



# SWR-121 HF

*Graphical HF Antenna Analyst*



## Operating Manual

1489 Poinsettia Ave., Suite # 134  
Vista, CA 92083 Tel (760) 798-9687  
Fax (760) 798-9689  
Hours 7:00am to 4:00pm Pacific time  
[www.aea-wireless.com](http://www.aea-wireless.com)

<b>Introduction</b> .....	<b>1</b>
Features .....	1
Specifications .....	2
Optional Accessories .....	2
<b>Operation</b> .....	<b>3</b>
To Turn On .....	4
Selecting a Frequency Range (Width) .....	4
Selecting a Center Frequency .....	5
Automatic Centering .....	5
Freezing the Display .....	6
Auto-Hold, Feature .....	6
SWR Scaling .....	6
Operational Tips .....	7
<b>Operation from a Terminal</b> .....	<b>8</b>
<b>Adjustments</b> .....	<b>9</b>
Internal Access .....	9
Jumper Settings .....	9
Checking the Batteries .....	10
Replacing the Battery .....	10
Calibration .....	10
<b>Self-Tests</b> .....	<b>12</b>
<b>In Case of Trouble</b> .....	<b>13</b>
Power .....	13
Cabling .....	13
Other .....	13
<b>Parts Pictorial</b> .....	<b>14</b>
<b>Limited Warranty</b> .....	<b>15</b>

**Proprietary Information**

*Reproduction, dissemination, or use of information contained herein for purposes other than operation and/or maintenance is prohibited without written authorization from AEA, A Division of Tempo Research Corporation.*

©1997 by AEA, A Division of Tempo Research. All rights reserved.

*Part Number 5001-3000 Rev. A. This document and all software or firmware designed by AEA is copyrighted and may not be copied or altered in any way without prior written consent from AEA.*

Congratulations on your purchase of the SWR-121 HF Antenna Analyst. The SWR-121 HF may very well be the most useful antenna accessory you've ever owned.

Even though the SWR-121 HF's functions are intuitive and easy to use, please read through this manual. The following pages contain some excellent notes and tips to help you get the most from your Analyst.

## Features

- Graphical display of SWR versus frequency from 1 Mhz to 31.999 MHz.
- Compact and battery-powered for portability.
- Automatic SWR scaling for best resolution.
- Digital readout of SWR - at center frequency and top of plot.
- Display of return loss in dB.
- Keypad selection of center frequency and frequency increments.
- Automatic battery-saver functions.
- Automatic centering of SWR null.
- RS-232 interface allows remote control, remote display, and saving of plots (optional PC software available).
- Internal beeper provides audible indication of SWR.
- Self-test and calibration functions.

<b>Specifications</b>	♦	Characteristic impedance:	50 or 75 Ohms (internally selectable)
	♦	SWR measurement range:	1:1 to 65.5:1
	♦	Return loss range:	0.3 dB to 50 dB
	♦	Accuracy:	+/-10% typical, when calibrated
	♦	Frequency range:	1.000 MHz to 31.999 MHz
	♦	Frequency increments:	1 kHz
	♦	Manual frequency steps:	1 kHz to 30.999 MHz
	♦	Display resolution:	0* to 200 kHz per dot (*single frequency)
	♦	Total display width:	0 to 22 MHz (110 times resol. setting)
	♦	Harmonics & spurious:	30 dB below fundamental, typical
	♦	Output power:	Approximately 5 mW into 50 Ohms
	♦	Power source:	Internal batteries or external 12-16 VDC
	♦	Battery complement:	8 AA alkaline or high energy lithium
	♦	Battery saver mode:	Entered after 4 minutes idle
	♦	Display update time:	Approximately 9 seconds per sweep
	♦	SWR-proportional tone:	Approximately 200 Hz x SWR value
	♦	Serial port:	9600 baud, XON/XOFF handshake
	♦	Size:	4.3 x 2.25 x 8.5 inches (including connector)
	♦	Weight:	1 lb, 10 oz (including batteries)

## Optional Accessories

- ♦ AC-1 Wall cube
- ♦ AACOM PC-compatible software and serial cable

These accessories are available directly from AEA.

**Warning** The SWR-121 HF will be damaged by RF power applied to its ANTENNA connector. Do not transmit into the Analyst! Damage may also occur when testing an antenna which is near other antennas being used for transmitting. Damage of this type is not covered under warranty.

**Note** *Erroneous readings may occur when testing antennas which are located in strong RF fields (i.e. near commercial broadcast antennas).*

The SWR-121 HF combines a microprocessor-controlled frequency synthesizer with an accurate low-power SWR bridge to present a graphical display of SWR versus frequency. You can select the center frequency, frequency range, and manual step size from the keypad, as described later in this manual. Below the horizontal (frequency) axis, the current values of the following parameters are displayed (Figure 1):

- the frequency width of each dot in the plot,
- $F_c$  the center frequency in kilohertz,
- SWR the standing-wave ratio at the center frequency, and
- RL the return loss in dB.

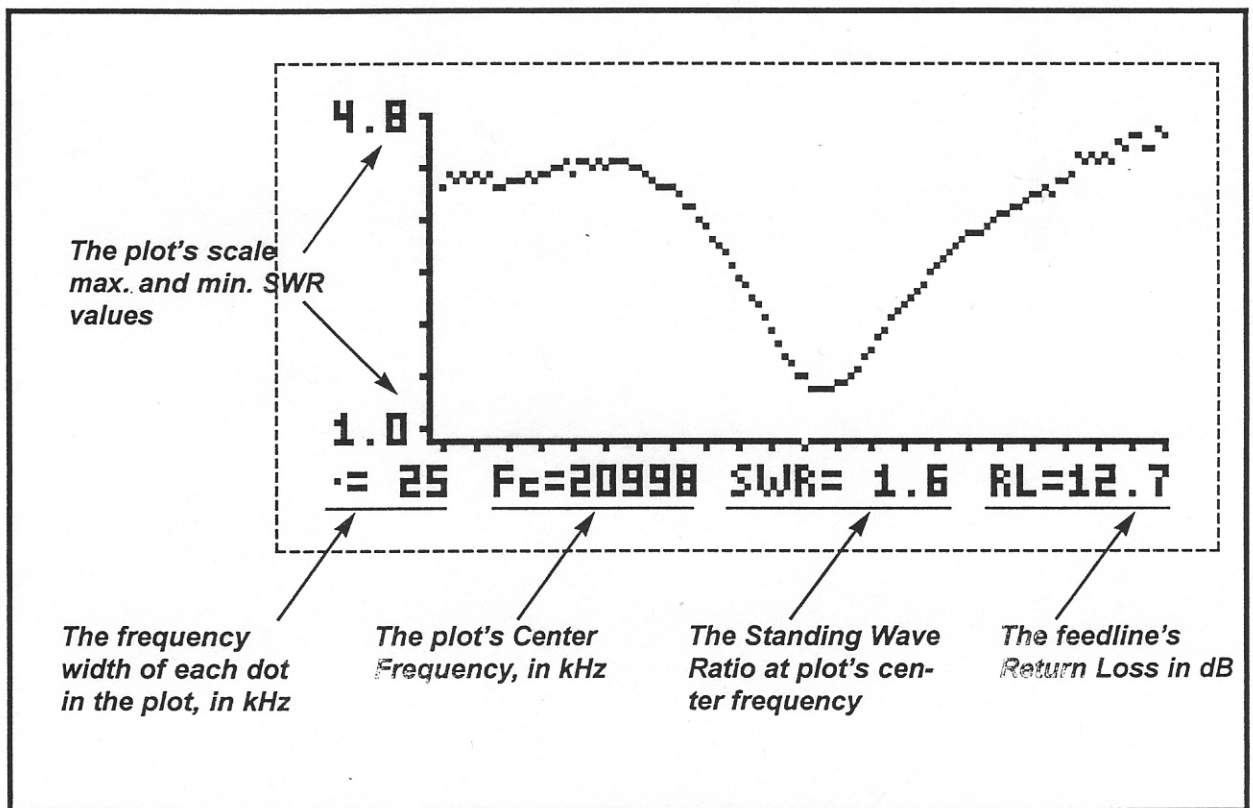

Figure 1. SWR-121 HF Display

## Turn On

To turn the SWR-121 HF on, press and hold the ON button until the AEA logo appears (about one second). The SWR-121 HF turns on with a default center frequency of 10 MHz, and display width (per dot) of 0. "0" width means that the unit does not sweep a frequency range, but outputs a single frequency. In this mode, the entire plot represents the selected frequency. This is a particularly useful setting when you are trying to minimize SWR at a specific frequency.

## Note

*When the width is set to 0, the internal beeper will chirp approximately 3 times per second at a pitch that is proportional to SWR, as long as the SWR is below 10:1. This makes some antenna tuning procedures more convenient since you need not keep your eyes on the display. This feature may be disabled by removing the jumper socket at SWR TONE. See the ADJUSTMENTS chapter for information on changing jumpers.*

## Selecting A Frequency Range (Width)

The SWR-121 HF's display can be adjusted to cover a specific frequency range by using the WIDTH buttons (Figure 2). Setting the WIDTH defines the resolution of a single dot on the display in kHz (i.e. a WIDTH of 1 makes each dot in the display 1 kHz wide). Since the entire display area is 110 dots wide, that would make the display width 110 kHz, or 110 x WIDTH.

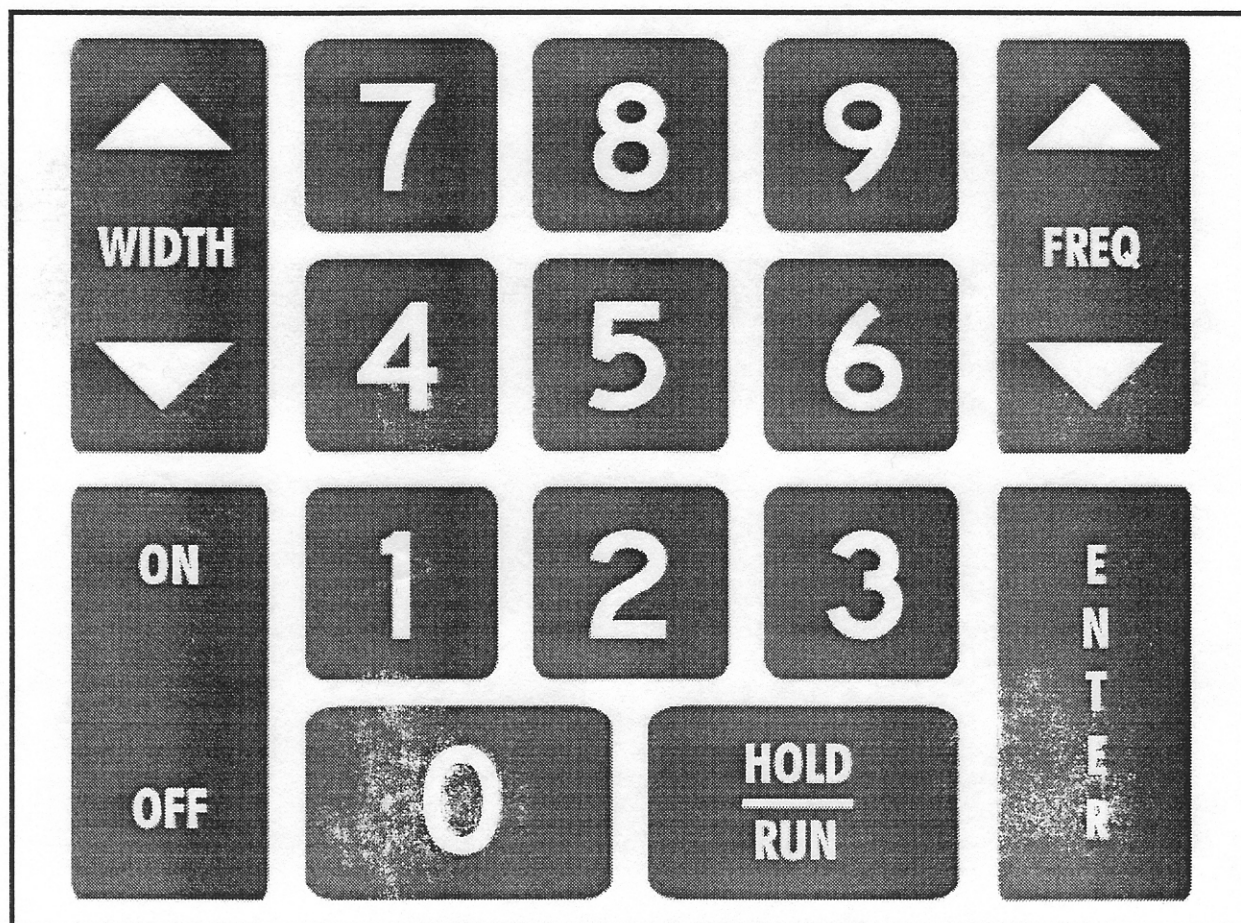

Figure 2. SWR-121 HF Keypad

You can set the width in one of two ways. First, by pressing the WIDTH▼ or WIDTH▲ buttons, you can step through the nine preset widths (0, 1, 2, 5, 10, 20, 50, 100 or 200 kHz per dot).

If you wish to set a specific width, enter that number on the keypad and press WIDTH▲ or WIDTH▼. As you enter numbers on the keypad, the display will clear and the number you are entering will appear, followed by the kHz symbol (Figure 3). If you press more than three numbers, the display will be set to the maximum width of 200. Remember, if you wish to check SWR at one specific frequency, set the WIDTH to 0.



**Figure 3. Entering a Number**

Each division mark on the horizontal frequency axis represents 5 times the width setting. For example, when the dot width is 5 kHz, the display is 550 kHz wide, and each horizontal division corresponds to 25 kHz.

**Note** *The number pad has many uses. It can be used to change the WIDTH, CENTER FREQUENCY and STEP SIZE. Each time you enter numbers on the keypad for any of these operations, they will be displayed on the screen as in Figure 3. These numbers are not acted upon by the SWR-121 HF until another button, such as ENTER, FREQ▲ or WIDTH▼ is pressed.*

**Selecting a Center Frequency** There are three ways to change the center frequency. First, you can enter a frequency directly from the keypad and press ENTER to make the change. As you enter numbers on the keypad, the display will clear and the number you are entering will appear, followed by the kHz symbol (Figure 3). If more than five digits are entered, only the last five are used. The frequency shown when the ENTER button is pressed becomes the new center frequency. Note that frequencies are entered and displayed in kilohertz.

The second way to change the center frequency is by using the FREQ▲ and FREQ▼ buttons (Figure 2). When the instrument is turned on, these buttons step the center frequency up and down, respectively, by 1 kHz each time a button is pressed. This default step size may be changed by entering a step size on the keypad prior to pressing the FREQ▲ or FREQ▼ button.

For example, if you enter 1234 and then press FREQ▲ or FREQ▼, the center frequency will change by 1234 kHz, and subsequent presses of either button will step by that amount. The selected step size will remain in effect until changed or until the next time the instrument is turned on.

If a center frequency is entered that is outside the 1.000 to 31.999 kHz range, the center frequency will not change, and plotting will resume using the existing settings. (If you make an error when entering a frequency, you can abort the entry by simply entering an invalid frequency, such as 00000.) If the combination of center frequency and width is such that either end of the display would represent out-of-range frequencies, that section of the plot will be left blank.

**Automatic Centering** Automatic centering is another way to change the center frequency. Once you have an SWR null plotted, you are likely to want to center it to allow zooming and accurate reading of the SWR at the null. To quickly change the center frequency ( $F_c$ ) to that of the lowest SWR in the plot, proceed as follows:

- 1) Press HOLD/RUN, to freeze the display.
- 2) Press and hold the FREQ▲ or FREQ▼ button, depending on which way the center frequency needs to move to reach the SWR dip of interest. (Use FREQ▼ if the dip is to the left of  $F_c$ , FREQ▲ if it is to the right of  $F_c$ .)

- 3) While still holding the **FREQ**▲ or ▼ button down, press **HOLD/RUN** again to resume.

The center frequency will change to that of the lowest pixel on the chosen side of center and a new plot will begin.

## Freezing the Display

Normally, the instrument continually sweeps and plots the selected range. If you want to freeze the display for closer examination, press the **HOLD/RUN** button. In addition to freezing the display, this function removes power from much of the circuitry and places the microprocessor in a reduced-current idle state to preserve battery life. A special Display Hold icon appears when in the Hold state (Figure 4). Pressing **HOLD/RUN** again resumes normal operation with the previously used settings. Using this feature or turning the instrument off whenever possible will prolong battery life.

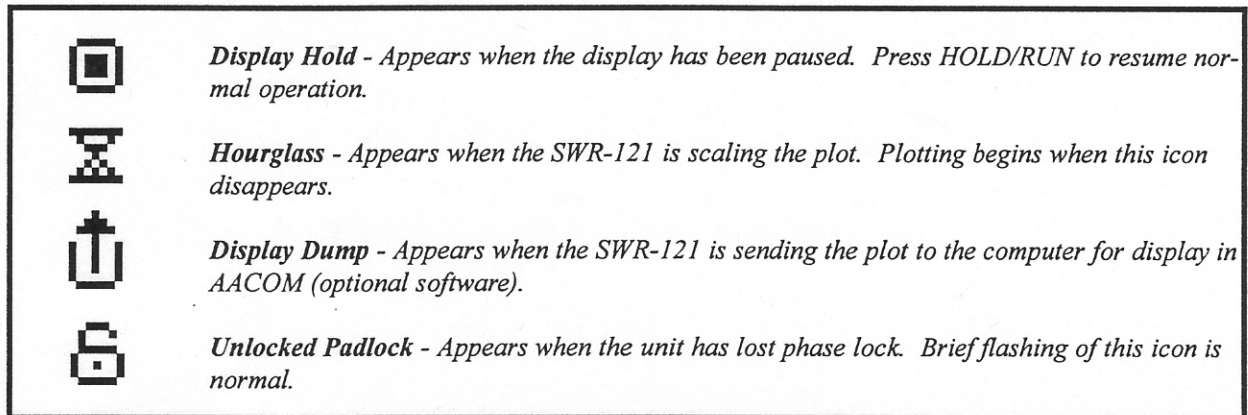

**Figure 4. Icon Legend**

## Auto-Hold Feature

The unit will automatically enter the Hold state when no keys have been pressed in a four minute period. (This feature may be disabled by removing the jumper socket from **AUTO-HOLD**. See the **ADJUSTMENTS** chapter for information on jumper location and changing jumper settings.) If you prefer that the unit shut off completely after four minutes, install a jumper socket at **AUTO-OFF**. (Auto-off will not occur if the unit has been manually placed in the Hold state.)

## SWR Scaling

The following paragraphs explain how the SWR-121 scales the display. This information is not necessary for normal operation.

The display is normally scaled automatically (*see Note*) so that the highest SWR within the selected frequency range, to a minimum of 1.5 or a maximum of 9.9, is plotted level with the top of the vertical axis, and the axis is labeled with that value. SWRs slightly above that value are plotted on the next three higher lines, while the very top line of the display represents any SWR value outside the current range of the display.

The bottom of the plot area always represents an SWR of 1:1, and is labeled 1.0. The SWR at the center frequency (which is located directly above the missing dot in the center of the horizontal axis) is also shown at the bottom of the display. Although the top of the vertical axis will never represent an SWR over 9.9, the displayed value of the SWR at the center frequency can be as high as 65.5 which, for practical purposes, is "infinite". The return loss in dB at the center frequency is also displayed in the lower right corner.

To find the maximum SWR within the selected range, and thereby choose an appropriate vertical scale, the instrument scans the range prior to plotting. During this time an hourglass icon appears (Figure 4). This simply means "wait". When the hourglass icon disappears in about nine seconds, the vertical axis is labeled and plotting begins. The SWR and return loss at the center frequency are displayed or updated as the plot passes the center point.



To provide a stable display when there is fluctuation in the maximum SWR found within the selected range, the scale of the display does not change unless (1) the center frequency is changed, (2) the width is changed, (3) the ENTER button is pressed, or (4) the Hold state is exited. Any of these actions cause the unit to rescale the display before it resumes plotting.

## Notes

- 1) *The automatic-scaling feature may be disabled by removing the jumper at AUTOSCALE (see the ADJUSTMENTS chapter for information on jumper location and changing jumper settings.) This will eliminate the 9 second delay after changing frequency or width, but the top of the vertical axis will always represent an SWR of 9.9. The AUTO-SCALE jumper selects the turn-on state of this feature. You may toggle auto-scaling on and off by pressing HOLD/RUN to freeze the display, then holding down ENTER while pressing HOLD/RUN again.*
- 2) *Although the SWR reads out to only one decimal place, the vertical resolution of the graphical display will usually be much better, particularly at low SWRs. If the highest SWR found within the range is less than or equal to 1.5, the display will be scaled so that the top of the vertical axis represents an SWR of 1.5.*

*When an SWR range this small is displayed, each vertical dot represents a change in SWR of less than .01, so received signals or noise may cause some random fluctuations in the plot.*

## Operational Tips

**SWR at a Single Frequency.** When trying to minimize an antenna's SWR at a single frequency, set the desired frequency from the keypad, select a width of 0, and tune the antenna to its lowest SWR. Each time ENTER is pressed (with the AUTO-SCALE jumper enabled), the top of the vertical axis assumes the value of the SWR at that time (to a minimum of 1.5), allowing maximum resolution for subsequent improvement.

**Making a 2:1 SWR Plot.** The jumper at AUTO-SCALE must be installed (see the ADJUSTMENTS chapter for information on jumper locations and changing jumper settings) for this feature to work.

You can easily measure the bandwidth of an antenna between 2:1 SWR points as follows: Set the center frequency near the antenna's resonant point, and select the desired display width. Replace the antenna with a 100-Ohm resistor (assuming 50-Ohm operation). Press ENTER. In a few seconds, the top of the vertical axis will be labeled 2.0. Reconnect the antenna.

When the plot is complete, the 2:1 SWR bandwidth can be measured by the distance between the two points where the plot crosses the top of the vertical axis. Note how many horizontal division marks this distance corresponds to, and use the following formula:  $N \times \text{WIDTH} \times 5 = \text{Bandwidth}$ , where N is the number of horizontal division marks. Bandwidths at SWRs up to 10:1 may be measured in a similar manner by using a resistor of the value  $R = \text{SWR} \times 50$ .

**75 Ohm Antenna Measurements.** The SWR-121 HF is shipped configured for 50-Ohm operation. The unit may be configured for 75-Ohm operation by simply removing the jumper socket at 50/75, near the antenna connector on the circuit board (see the ADJUSTMENTS chapter for information on jumper location and changing jumper settings). Place this jumper socket over a single pin for 75 Ohm operation; this will avoid losing the jumper. When set for 75 Ohms, SWR on 300-Ohm balanced lines may also be checked by using a 4:1 balun.

**Synthesizer Out of Lock.** In addition to the Display Hold and hourglass icons described earlier, an unlocked padlock icon (Figure 3) may be visible at the left side of the display from time to time. Brief flashing of the icon is normal. This indicates that the synthesizer has lost phase-lock. If this icon remains on for more than a second, it may indicate that the batteries need to be replaced, or that the SWR-121 requires alignment. See the ADJUSTMENTS chapter for information on checking the batteries and performing the alignment procedure.

# Operation from a Terminal

The serial interface allows control of the Analyst (but no display) from a terminal or terminal emulator. (It must be set to 9600 baud, no parity, 8 data bits, and 1 stop bit to communicate with the SWR-121.) The active keys are as follows:

0-9	function the same as the digit buttons on the instrument
U	steps the frequency up
D	steps the frequency down
O	zooms out
I	zooms in
Enter	functions the same as the Enter button on the instrument
Backspace	resweeps immediately, without changing the scale
Spacebar	freezes the display*
?	returns SWR string (see below)

\*On the instrument, only the HOLD/RUN button will exit the paused state. From the terminal, any key will do so, and if it's one of the keys listed above, it will also perform its normal function.

Typing a "?" will return a string of the form SWR @ 12345 kHz. = 12.34, followed by a carriage return and linefeed. (Width is automatically reset to 0 for fastest response.)

You may also precede the "?" with a frequency. For example, typing "14230?" will set the width to 0 and the frequency to 14.230 MHz, and the SWR at that frequency will be returned from the Analyst.

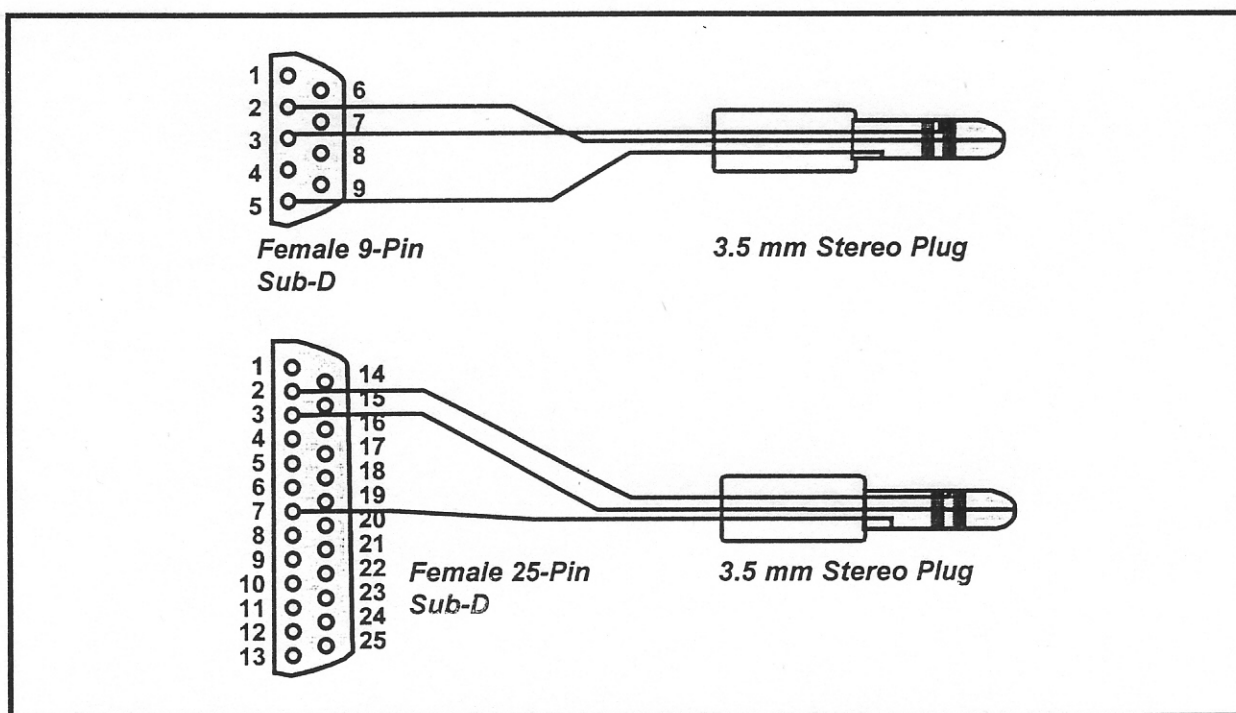

Figure 5. Serial Port Wiring Connections

## Internal Access

The following adjustments (except the battery check) require gaining access to the internal workings of the Analyst. The next two paragraphs explain how to remove the battery cover and rear cover.

There are six screws on the rear panel. The two screws behind the rubber foot, when removed, allow access to the battery compartment. When replacing this cover, make sure the foot's pegs are seated in the slots in the top of the battery cover before reinstalling the screws.

The four screws in the corners of the rear cover, when removed, allow access to the circuit board, where the trimmer capacitor, potentiometers and function selection jumpers are located. Note that the battery cover screws do not need to be removed to remove the rear panel. After removing the rear cover screws, carefully flip the cover over to the left to avoid pulling the battery connection wires from the circuit board.

## Jumper Settings

Several SWR-121 HF settings can be changed by installing or removing circuit board jumpers (Figure 6). These jumpers are actually "shorting plugs" which connect two pins together when installed. The functions controlled by these jumper settings are explained in the OPERATION chapter. When not installed, these jumpers should be left on one of the two pins to allow easy reinstallation at a later date, if desired.

To change a jumper, first remove the rear cover as described above. Locate the jumper block near the lower right corner of the circuit board (Figure 6). Locate the desired jumper and, using a pair of small-tip needlenose pliers, gently grab the top of the jumper and lift up. To install the jumper, carefully place it over both pins on the circuit board and gently slide it down as far as possible. To uninstall a jumper, carefully place it over one of the pins on the circuit board and gently slide it down as far as possible (Figure 7).

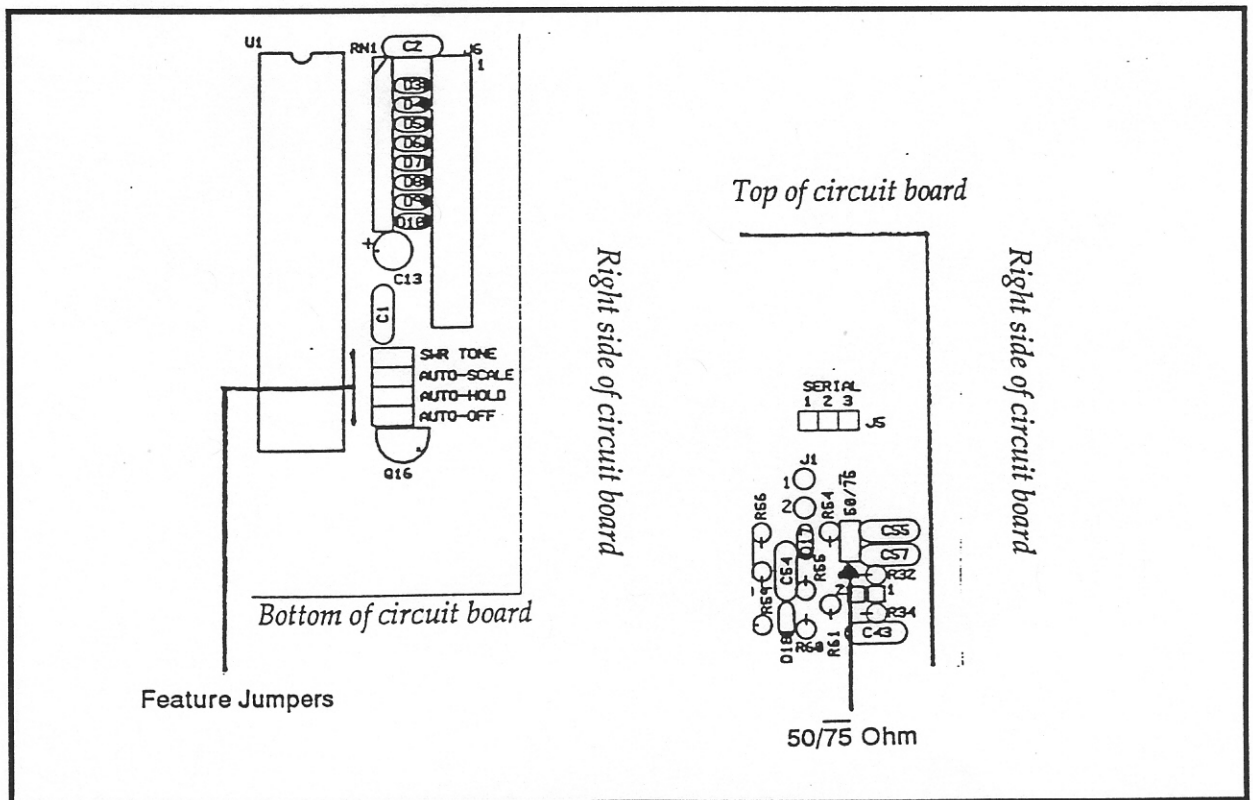

Figure 6. Jumper Locations

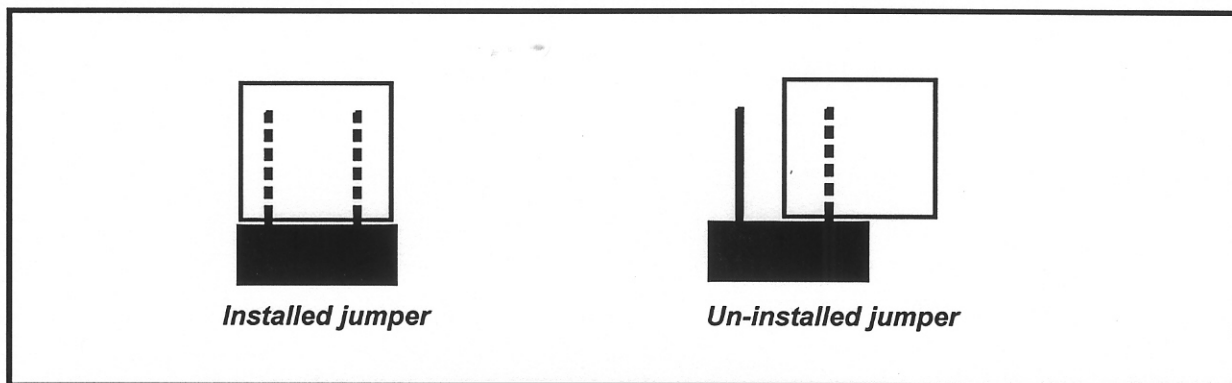

Figure 7. Jumper Removal/Installation

## Checking Batteries

You can get a relative idea of the condition of the batteries by entering Calibration mode. To do this, remove any load from the antenna connector, press and hold the ENTER button while turning the instrument on. (See the CALIBRATION section for more information on Calibration mode.) After the self-tests (described later) are completed, you will see the letters F and R (representing Forward and Reflected voltages from the bridge) near the top of the display. The letters will be near the right side of the display with fresh batteries and will move to the left as the battery voltage decreases (Figure 8). When the letters reach the center of the display with no load attached, the batteries should be replaced soon, as only a few hours of useful life remain. All eight batteries should be replaced at the same time. Alkaline or high energy Lithium batteries are strongly recommended for longest life.

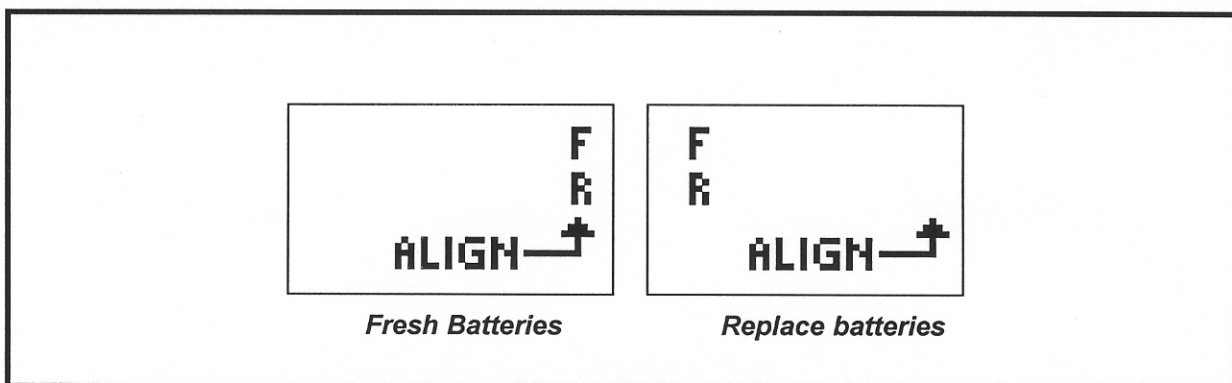

Figure 8. Checking the Batteries

## Replacing the Battery

Turn the instrument off before replacing batteries. The two screws under the rubber foot allow access to the battery compartment. See the INTERNAL ACCESS section of this chapter for more information. Be careful to insert the batteries according to the markings on the inside of the case bottom to avoid damage.

## Calibration

Although calibration will not normally be required unless components have been replaced, the procedure is given for reference. Calibration must be performed with fresh batteries and external power disconnected. See the PARTS PICTORIAL for lead connections and parts locations.

**TIMEBASE:** Connect a frequency counter to the antenna connector. Turn the instrument on and adjust trimmer capacitor C39 for a reading of 10 MHz. Alternately, you can set a receiver to WWV or some other station of known accuracy, set the SWR Analyzer to the same frequency (with dot width set to 0), and adjust C39 for zero-beat.

**BRIDGE AMPLIFIER GAIN:** Press and hold the ENTER button while turning the instrument on. After several self-tests are completed, an F and an R will appear in the display. Adjust R51 and R50, respectively, so that the F and R are vertically aligned at the "ALIGN" arrow near the right side of the display with the antenna connector open (no load connected). These letters indicate the Forward and Reflected voltages from the SWR bridge. The right side of the display represents 5 Volts (full- scale); the left side represents 0 Volts. (If adjustments are made with old batteries, erroneous SWR measurements may result when they are replaced.)

- Note**
- 1) *If the Calibration mode is entered while the instrument is powered from an external source, the letters F and R will appear near the center of the display. As long as the letters are vertically aligned within a pixel or two, accuracy will be maintained.*

**VCO (VOLTAGE-CONTROLLED OSCILLATOR):** Turn the instrument off, then on to set a center frequency of 10 MHz and 0 width. Connect a voltmeter between ground and pin 6 of U8. Adjust C25 for a reading of 7.0 Volts.

**INJECTION OSCILLATOR:** Connect an oscilloscope to the antenna connector. Adjust C31 for a peak, using a non-metallic tool. If the waveform shows any flat-topping, adjust C31 away from peak slightly until the flat-topping is eliminated. (Adjusting too far off of the peak may result in the oscillator stopping.)

**VIEWING ANGLE:** While viewing the display from the angle normally used, adjust internal control R4 until the background dots disappear.

Pressing ENTER while turning the unit on causes several self-tests to be performed:

- 1) The LCD module is tested.
- 2) A checksum test is made on the program ROM.
- 3) The synthesizer is tested at several frequencies.
- 4) The serial port is tested (A 3.5 mm stereo plug with tip connected to ring must be inserted into the serial connector).

As each test is passed, an abbreviation of the test name will appear near the bottom of the display. If one of the above listed tests fail, its abbreviation will not appear on the screen. If this happens, note which test failed and contact AEA's Technical Support department (see the IN CASE OF TROUBLE Chapter).

- Note**
- 1) *If you do not install a 3.5 mm stereo plug into the serial connector before starting the self test, the serial port test will fail. This is not critical, and once the testing routine is complete you may continue with the alignment procedure and/or battery check described in the ADJUSTMENTS chapter.*

Following the self-tests, the outputs of the bridge amplifiers are displayed as described under "Calibration."

If your SWR-121 HF doesn't seem to be working properly, please try the following suggestions before sending the unit in for repair:

**Power** When using the Analyst as a portable instrument, low batteries are the most likely cause of difficulty. See "Adjustments" chapter of this manual for instructions on how to check batteries.

If the Analyst is plugged in, is your power supply providing 12 to 16 volts DC under load? In other words, is your power supply capable of delivering at least 12 volts while the SWR-121 HF is on? If you're not sure, try another 12 volt power supply. Also, make sure the center pin of your power cable is positive. If it is not, then the SWR-121 HF's internal fuse is probably blown. Replace the fuse and rewire the power cable for center pin positive.

**Cabling** Make sure all cables are securely connected. Check cable continuity with an ohmmeter.

**Other** If you can't seem to solve the problem yourself, please let us try to help you over the phone before sending the unit in. Many of the products we receive for service are in perfect working order when we receive them. Calling us for technical assistance can save you both time and money.

If you need application and troubleshooting assistance, please call AEA during our 7:00 a.m.-4:00 p.m. hours in Vista, California. Ask for the Technical Support department. The phone number is (760) ~~798-9687~~. Please have your SWR-121 HF serial number available. We will also need to know the nature of any other equipment connected to the SWR-121 HF.

If you call for assistance, please have the SWR-121 HF and antenna connected and powered on. The technician you speak with may ask you to perform certain functions to aid in diagnosis. If you have a voltmeter, you might have the SWR-121 HF open so you can report measurements to the technician.

To assist in the rapid repair of the unit, the user is requested to call (760) 598-9677 for a Return Material Authorization (RMA) number. The user is requested to include a statement giving a complete description of the problem, including the conditions under which it occurred. Complete return information (name, company, address and daytime phone number) should be included with each returned unit.

Units should be sent to: AEA Wireless  
1489 Poinsettia Ave Suite 134  
Vista, CA 92081

© 1993 AEA  
ALL RIGHTS RESERVED

REFER TO YOUR MANUAL TO IDENTIFY  
PARTS BY REFERENCE DESIGNATORS.  
(PARTS PICTORIAL SECTION)

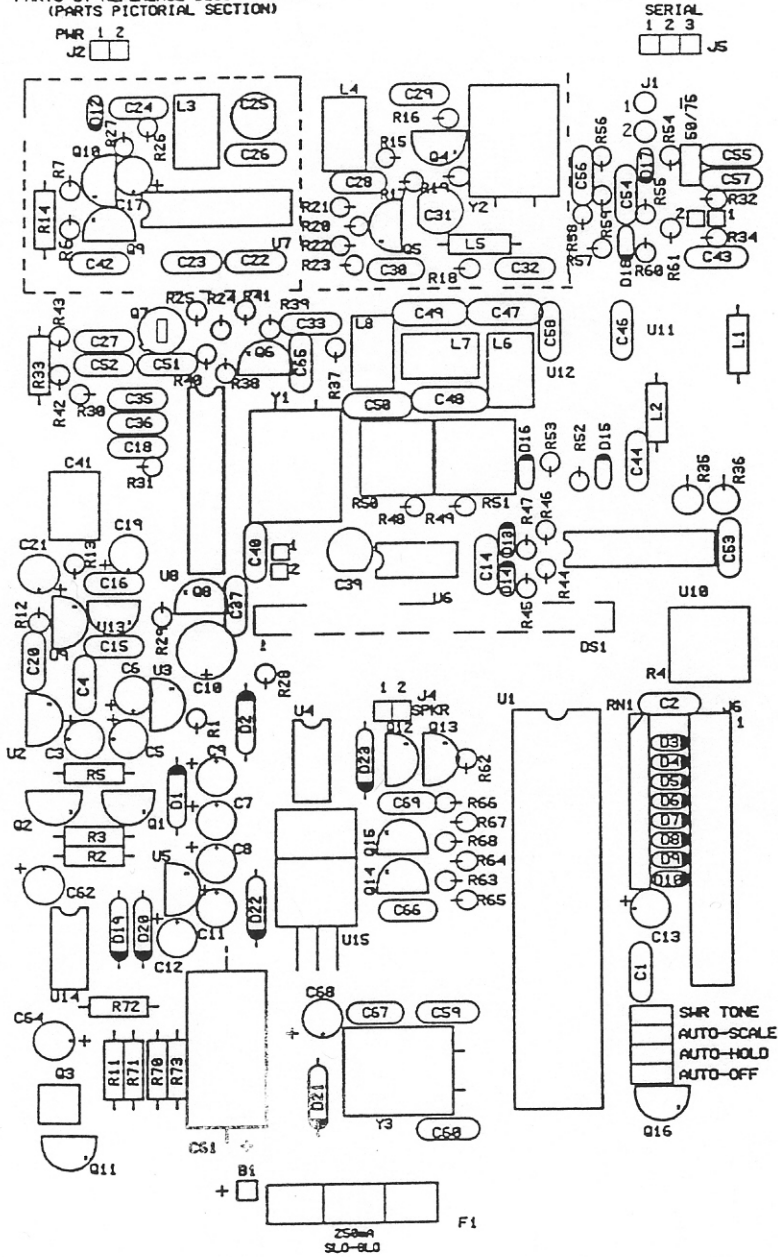



# Limited Warranty

---

ADVANCED ELECTRONIC APPLICATIONS, A DIVISION OF TEMPO RESEARCH CORPORATION, warrants to the original purchaser that this product shall be free from defects in material or workmanship for a period of one year from the date of shipment to the original purchaser. All units returned to the Tempo factory, delivery charges prepaid, and deemed defective under this warranty, will be replaced or repaired at Tempo's option. No other warranties are implied, nor will responsibility for operation of this instrument be assumed by Tempo Research Corporation.

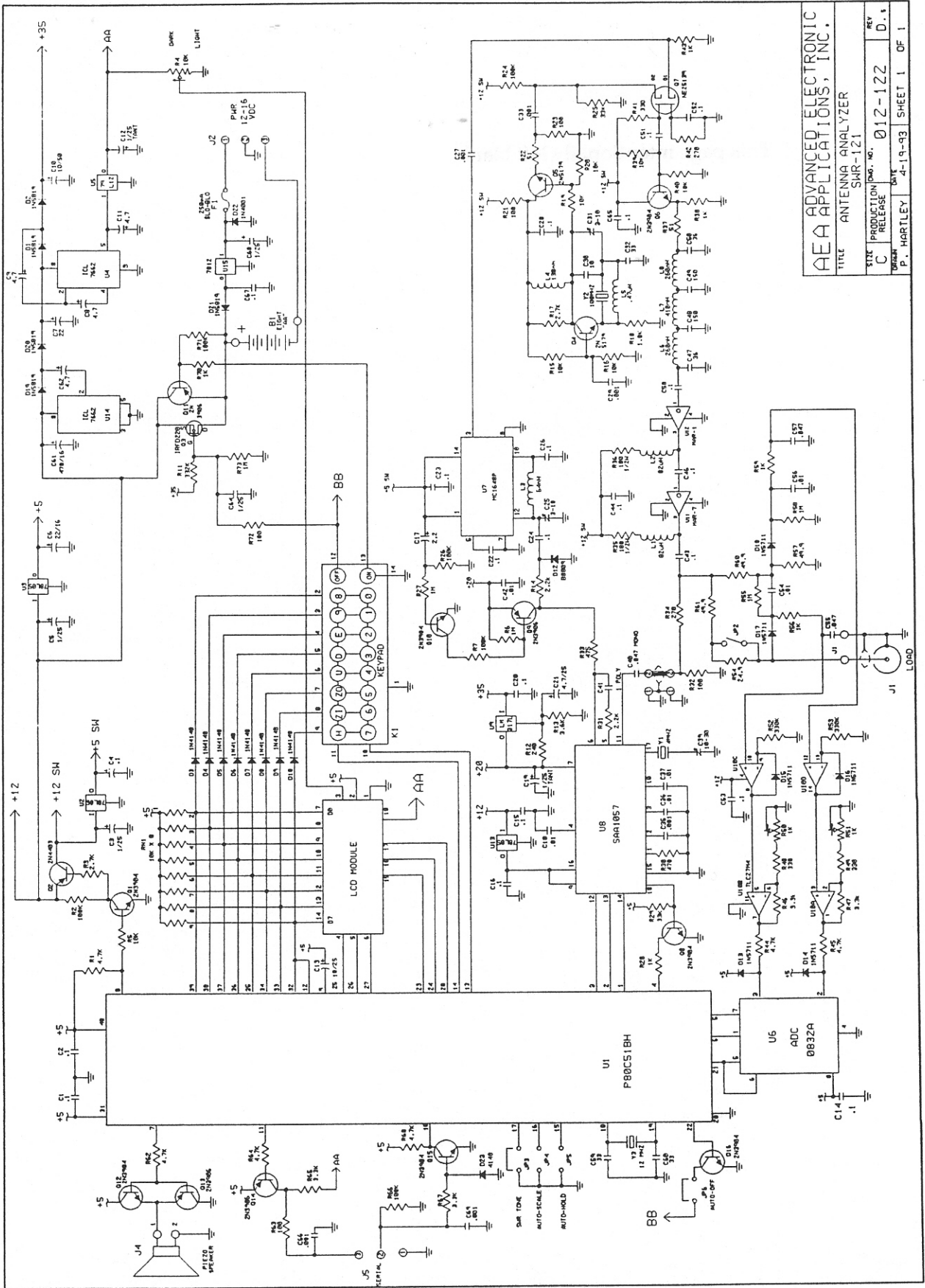

**AEA ADVANCED ELECTRONIC APPLICATIONS, INC.**  
 TITLE ANTENNA ANALYZER SMR-121  
 SIZE PRODUCTION 8.5" x 11" REV D.1  
 C RELEASE  
 DESIGNER P. HARTLEY DATE 4-19-93 SHEET 1 OF 1



1487 Poinsettia Ave., Suite #127  
Vista, CA 92083 Tel (760) 798-9687  
Fax (760) 798-9689  
Hours 7:00am to 4:00pm Pacific time  
[www.aea-wireless.com](http://www.aea-wireless.com)