

Assembly Manual

The Mains Monitor

Cat No. **K 7207**

by *Rob Evans*

Please read Disclaimer carefully as we can only guarantee parts and not the labour content you provide.

Reproduced in part by arrangement with Electronics Australia, from their June 1999 edition.

Please read: 'A Safety Guide to Mains Wiring & Handling' before assembling this kit.



While the mains supply is held at a relatively fixed voltage by electricity authorities, events such as high load conditions, electrical storms and line faults can cause that level to peak or sag without warning - a dreaded 'brownout'. Both conditions can quickly damage mains-powered appliances and equipment, unless they're automatically switched off by a protection device like the Mains Monitor presented here. This immediately disconnects the power when the mains voltage is outside your predefined limits; then when all's well, it reconnects the load after a defined time delay - and as a bonus, it even tells you that a mains disruption occurred while you were out.

IF YOU LIVE IN the country, you're sure to have experienced fluctuations in the mains supply voltage at one stage or another. This can range from the occasional and minor 'brownout' to large and repeated variations in the nominal voltage level, where each sag is followed by what appears to be a kickback surge - very disturbing indeed.

These things can occur in the city areas as well, albeit to a lesser degree. The industrial area near our *Electronics Australia* office is a case in point, where high loads cause a low mains voltage during normal working hours, yet the voltage level is magically restored at around 5pm...

The bottom line for those in the country though, is that extended surges or sags in the mains supply voltage can damage a range of 240V equipment and appliances, particularly those that use motor-driven compressors such as refrigerators, air-conditioners and freezers. In short, an overly high or low mains voltage will cause these motors to overheat and if not adequately protected, eventually burn out.

While most of these devices have a

degree of built-in motor protection, it's often a fairly crude thermal arrangement that won't trip before some motor damage has occurred. The protection arrangements are somewhat better in

commercial rather than domestic compressor equipment of course, but these too may not be enough to guarantee a long and happy life for the motor.

In both types of appliances though, the

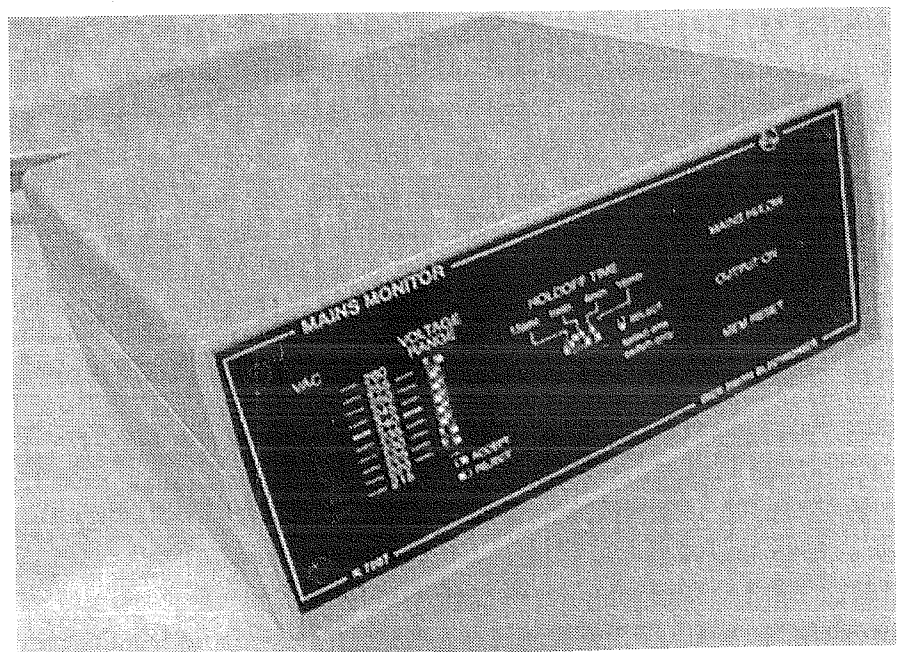

More functional than attractive, the Mains Monitor has front panel switches for setting both the 'accepted' mains voltage range and the delay before its mains outlet is re-activated.

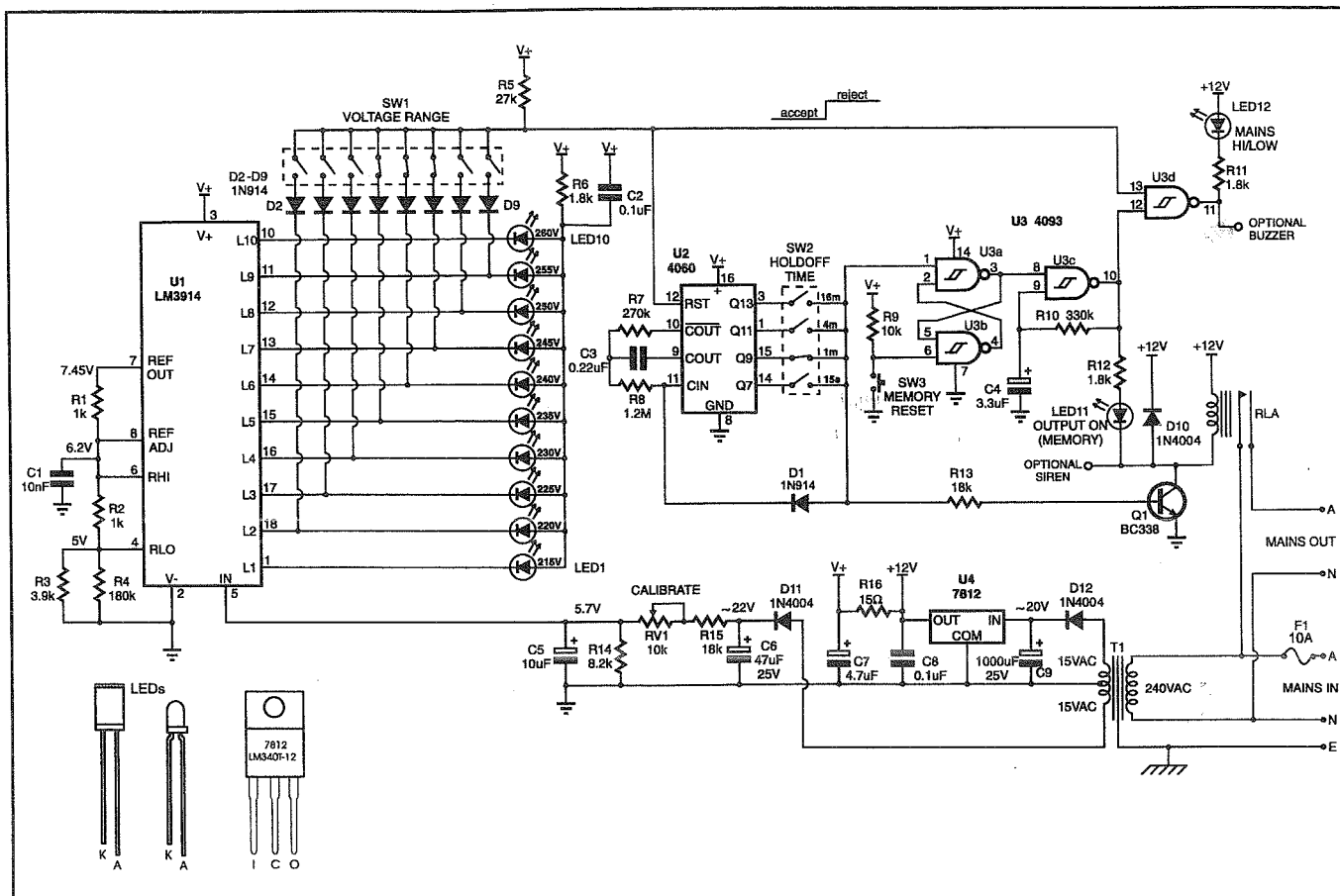
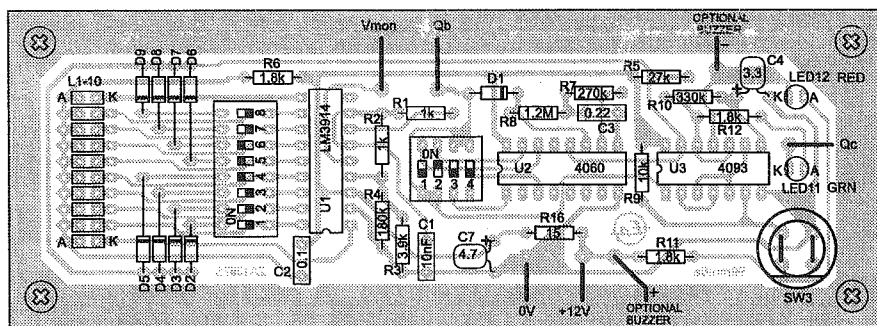
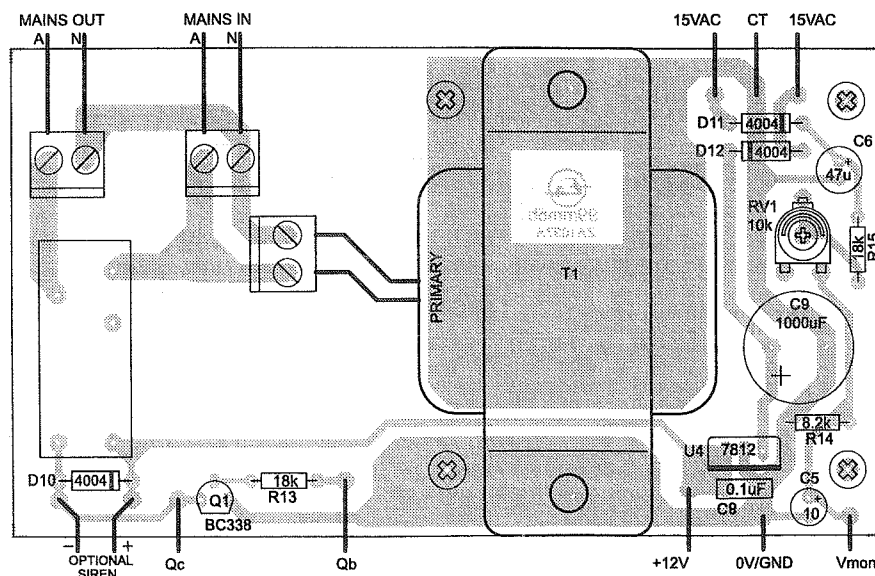

Fig. 1: One half of the mains cycle drives regulator U4, while the other half feeds the voltage monitor circuit at D11. U1 then displays this voltage on LED1-10, where OR gate D2-9 taps off the logic levels for the remaining timer and relay driving stages.



The component overlay diagrams for the controller board (above) plus the power supply and mains switching PCB (below). Take particular care with the mains wiring.



cutout systems are rarely self-resetting, which in turn means that the device is out of action until a human intervenes. This situation can become quite serious if a refrigerator or freezer is storing expensive perishable goods - or for that matter, next month's food supplies.

Along with variations in the mains supply, a short (and complete) dropout can be extremely hazardous to compressor systems as well. In this case, the liquid refrigerant in the compressor is still under pressure since the system hasn't had time to equalise, so the compressor motor tries to restart while under full load. It usually can't do this, and sits there in a stalled and overheating state until (if you're lucky) the overload cut-out trips. An extended mains dropout is fine, but a short one can be disastrous.

By the way, there's also evidence to suggest that extremes in the mains voltage can permanently damage mode power supplies, such as those used in personal computers. While the danger associated with a high mains voltage is probably self-evident, a low source voltage will force the supply to work much harder in order to maintain its output voltage. Eventually the supply will completely drop out, but high demands are placed on the internal

Resistor Colour Codes

Value	4 Band (1%)	5 Band (1%)
15R	Brn - Grn - Blk - Brn	Brn - Grn - Blk - Gld - Brn
1K	Brn - Blk - Red - Brn	Brn - Blk - Blk - Brn - Brn
1.8K	Brn - Gry - Red - Brn	Brn - Gry - Blk - Brn - Brn
3.9K	Org - Wht - Red - Brn	Org - Wht - Blk - Brn - Brn
8.2K	Gry - Red - Red - Brn	Gry - Red - Blk - Brn - Brn
10k	Brn - Blk - Org - Brn	Brn - Blk - Blk - Red - Brn
18K	Brn - Gry - Org - Brn	Brn - Gry - Blk - Red - Brn
27K	Red - Vio - Org - Brn	Red - Vio - Blk - Red - Brn
180K	Brn - Gry - Yel - Brn	Brn - Gry - Blk - Org - Brn
270K	Red - Vio - Yel - Brn	Red - Vio - Blk - Org - Brn
330K	Org - Org - Yel - Brn	Org - Org - Blk - Org - Brn
1.2M	Brn - Red - Grn - Brn	Brn - Red - Blk - Yel - Brn

switching devices until that actually happens.

The EA Mains Monitor solves all of the above problems by continuously monitoring the mains voltage (hence the name), then switching off its output load when the mains level is considered unacceptable. You can set the 'acceptable' voltage range via an 8-way DIP switch on the unit's front panel, which also offers a 4-way DIP switch to set the time taken before the circuit restores power, after the mains has returned to the acceptable voltage range.

As you can see from the shots of the prototype, it also offers 10 LEDs to display the current mains voltage in five volt steps, so you get a real-time view of what the mains is up to. We've also added an 'event memory' feature which is activated when the unit has disconnected the mains. This changes the 'output on' LED from a continuous to a flashing mode, so that you can tell that an 'event' has occurred.

The event memory can then be cleared with a front panel 'memory reset' push-button, where the output LED then returns to its normal state. By the way, the remaining front panel LED flashes to indicate when the mains voltage is out of your predefined band.

So there you have our new Mains Monitor protector unit. It's quite easy to put together and uses conventional low-cost parts, it can be set up to deal with a wide range of mains voltages and delay holdoff times - and best of all, it could save you a bundle by preventing dam-

age to a mains appliances.

Circuit details

The Mains Monitor's circuit is based on a common LM3914 dot/bar display driver IC, which drives 10 LEDs in response to a DC level derived from the power transformer's secondary winding. As this monitoring voltage will change in proportion to the 240V mains, the LM3914 circuit can be arranged so that the LEDs give a direct readout of the incoming mains voltage. Logic levels at the IC's outputs are then used to control the following timing and relay control circuits, formed around a 4060 timer chip and a 4093 quad NAND gate.

With this circuit, the best place to start a more detailed description is probably at the power supply section. As you can see from the schematic (Fig.1) this is based on a standard 2856-type transformer, where the two 15VAC halves of its secondary winding feed separate half-wave rectifier stages at D11 and D12.

The circuit around D12 is a conventional regulated power supply setup, where the rectified voltage at reservoir electro C9 (about 20V) feeds a 7812 three-terminal regulator U4. The resulting +12V output is then passed through filter stage R16/C7, which derives a clean supply rail (V+) for the more sensitive parts of the circuit.

Since the rectifier stage fed from the other half of T1's secondary (via D11) is only used to monitor the mains voltage level, this is a low-current but well-filtered arrangement. Here, the rectified voltage at C6 (around 22V) is applied to an adjustable voltage divider formed by R15, trimpot RV1 and R14, with final filtering provided by C5.

All things being equal, this stage delivers a nominal level of 5.7V when the mains is at 240V and RV1 is set to mid-travel. This represents a voltage ra-

Parts List

Resistors

R1,2	1k
R3	3.9k
R4	180k
R5	27k
R6	1.8k
R7	270k
R8	1.2M
R9	10k
R10	330k
R11,12	1.8k
R13,15	18k
R14	8.2k
R16	15 ohms
RV1	10k mini trimpot (horiz.)

Capacitors

C1	10nF MKT
C2	0.1uF MKT
C3	0.22uF monolithic
C4	3.3uF 16V/25V tantalum
C5	10uF 16V/25V tantalum
C7	4.7uF 25V/50V electro
C6	47uF 25V/50V electro
C8	0.1uF MKT
C9	1000uF 25V/35V electro

Semiconductors

U1	LM3914 dot/bar LED driver
U2	4060 / MC14060 / CD4060 CMOS counter/timer
U3	4093 / MC14093 / CD4093 quad Schmitt NAND
U4	7812 / LM340T-12 12V regulator
Q1	BC338 / 2N5818 NPN transistor
LED1-10	Rectangular LEDs
LED11,12	3mm LEDs (red and green)
D1-9	1N914 / 1N4148 diodes
D10-12	1N4004 power diodes

Switches

SW1	8-way DIP switch
SW2	4-way DIP switch
SW3	PC-mount pushbutton

Miscellaneous

T1	30VCT/140mA transformer (2856 or equiv)
RLA	SPDT 10A relay, 12V coil
F1	fuseholder with 10Amp fuse
Plastic instrument case, 155 x 65 x 160mm; PCB coded 99mm6a (ZA1907B), 140 x 50mm; PCB coded 99mm6b (ZA1097A), 120 x 66mm; IC sockets; 3 x PC-mount terminal blocks, 2-way; cord grip grommets; PCB pins; nuts, bolts and lock washers; mains-rated hookup wire; solder lugs; heatshrink tubing for fuse holder; solder; cable ties; rubber feet; front and rear panel; mains cord with plug and socket and instructions.	

Capacitor Codes

Value	IEC Code	EIA Code
0.01uF	10n	103K
0.1uF	100n	104K
0.22uF	220n	224K

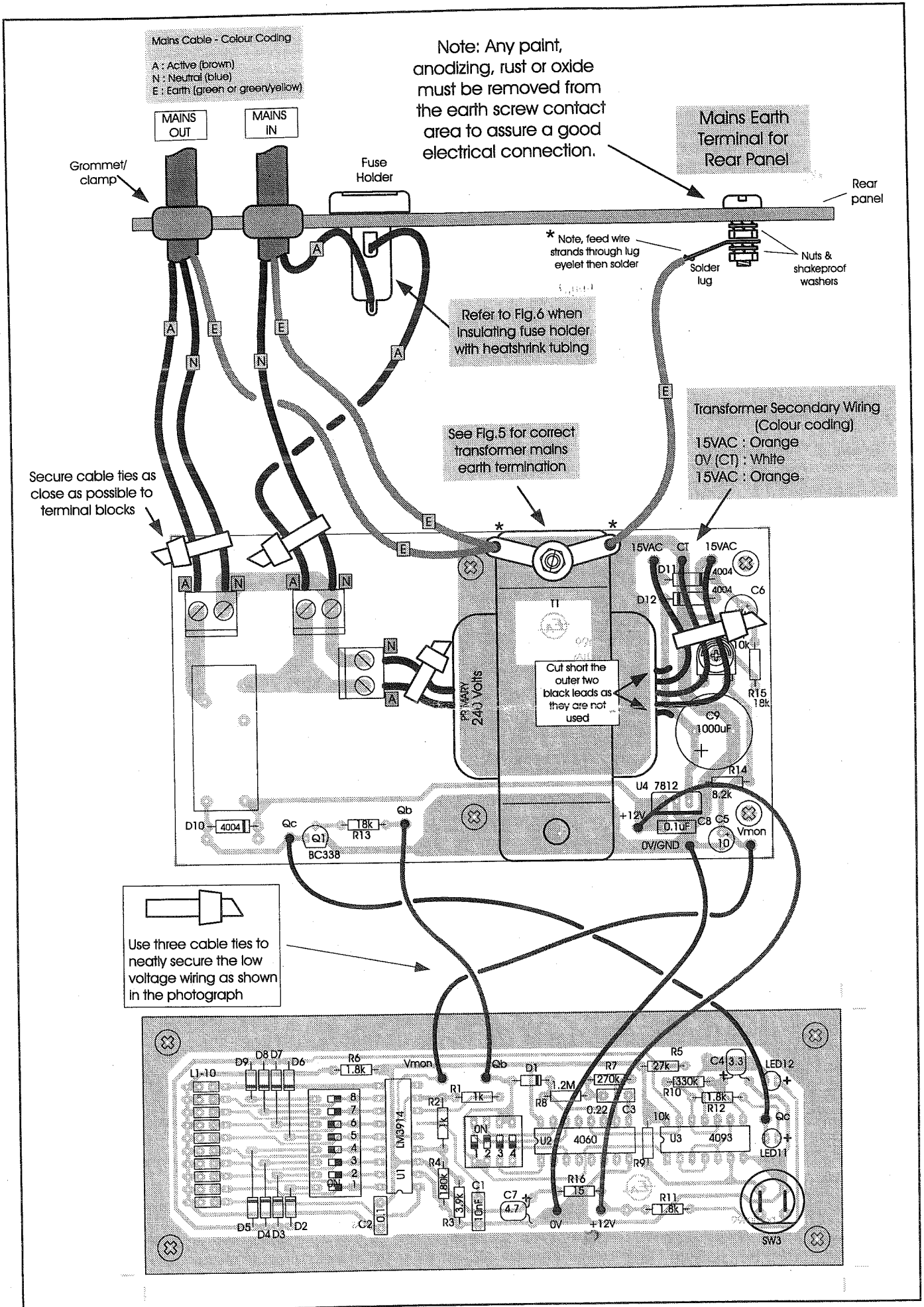
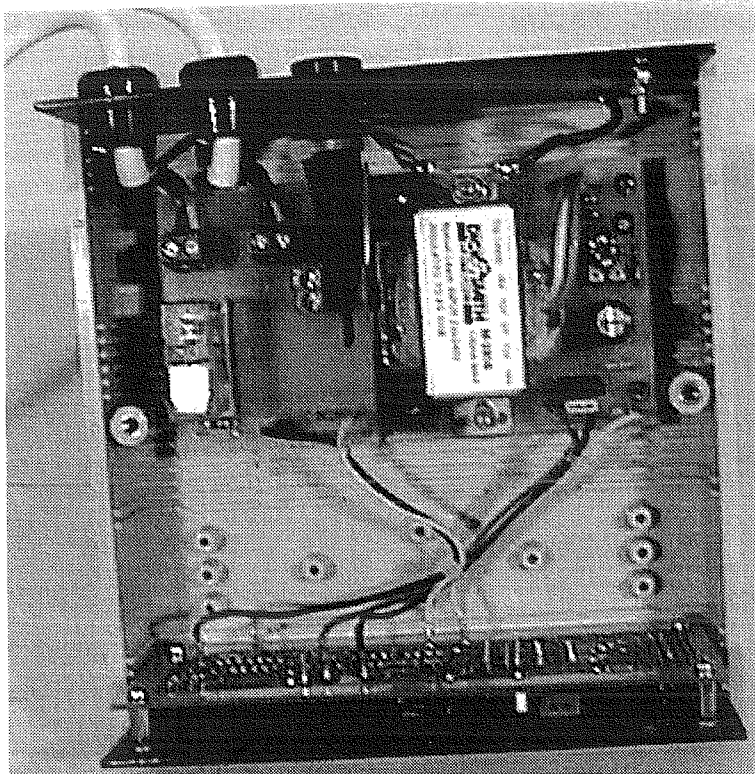

Fig.2: Extreme care should be taken when working with mains wiring. Correctly insulate the mains fuse as shown in fig.6 and restrain all wiring using the cable ties provided. Don't forget, the wiring to the display PCB is terminated from the copper side of the board.



Guide To Screw Allocation

Main PCB to Case

- 4 x Screw self-tapper No4 x 12mm
- 4 x Nylon spacer - 6mm

Display PCB to front panel

- 4 x Screw M3 x 6mm black Csk
- 4 x Spacer hex 9mm (suit M3 screw)
- 4 x Screw M3 x 6mm pan head
- 12 x Washer flat M3

Transformer to Main PCB

- 2 x Screw M3 x 12mm
- 3 x Nut M3
- 4 x Washer shakeproof M3
- 2 x Solder lug (for mains earth)

Rear panel earth lug

- 1 x Screw M3 x 12mm
- 2 x Nut M3
- 2 x Washer shakeproof M3
- 1 x Solder lug (for mains earth)

tio of 42:1 between the mains and the 'monitoring' voltage across C5, so the unit's 215VAC to 260VA input range equates to a monitor voltage range of 5.1 - 6.2V.

Note that the two outputs from T1's (centre-tapped) secondary are of opposite phase, so the above circuit monitors the transformer output on one half of the mains cycle, while the power supply circuit loads T1 on the other half. The two 'events' are effectively 10ms apart, so the unit's own varying power supply load won't effect the accuracy and sta-

bility of the mains monitoring voltage.

Next, this linear representation of the mains voltage is applied to the input of U1 (pin 5), the LM3914 LED driver chip. Here, the voltage divider formed by R1 to R4 forces U1 to act as an expanded-scale voltmeter, with the ends of its internal voltage reference ladder (pins 6 and 4) held at 6.2V and 5V. The 1.2V difference across the 10-way ladder means that the bargraph display (LED1 to LED10) will respond to the input (monitor) voltage in 120mV increments - or in effect, to the mains voltage

in 5V steps.

The values chosen for R1-4 also set the upper and lower LEDs to represent 260VAC and 215VAC, respectively, and set the current drawn by U1's REF OUT terminal (pin 7) at 1.25mA. In the LM3914, the current at this pin 'programs' the LED current to 10 times that figure, or in this case, 12.5mA. Note that pin 9 of U1 has been left unconnected, which configures the LM3914's output to run in 'dot' rather than 'bar' mode.

While the special current programming feature of the LM3914 makes it very easy to set the LED current (and therefore brightness), the limiting action at each output will normally prevent them from falling fully to 0V. As this isn't suitable for interfacing to a digital stage (in our case, the following timing and relay control circuitry), we've fooled the chip's outputs into being compatible by the addition of the LED supply resistor R6.

The idea here is that while the LM3914's outputs are trying to sink a 'programmed' current of 12.5mA, the 1.8k resistor in series with the LEDs sets an absolute limit of about 6mA. The chip's outputs therefore fall to 0V in an attempt to sink 12.5 millamps of LED current, giving us a full (digitally-compatible) swing at U1's outputs - plus of course, a final LED current of around 6mA.

Eight of U1's 10 outputs are then coupled to an OR gate composed of diodes D2 to D9 and DIP switch bank SW1, plus pullup resistor R5. If we consider that the 'voltage range' DIP switches are

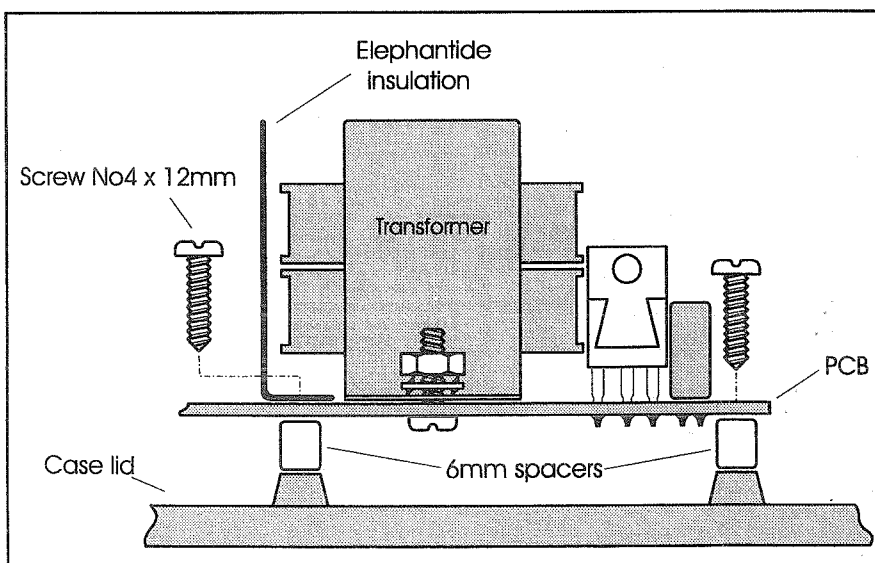

Fig.3: The above diagram shows how the PCB is raised and secured to the case lid by using 6mm nylon spacers and 12mm screws. A piece of elephantide (insulating paper) is used to create an insulating barrier between the transformer and fuse holder. The elephantide insulating paper is cut and folded as shown in fig.8, and secured in place using the same screws that hold the PCB onto the case lid.

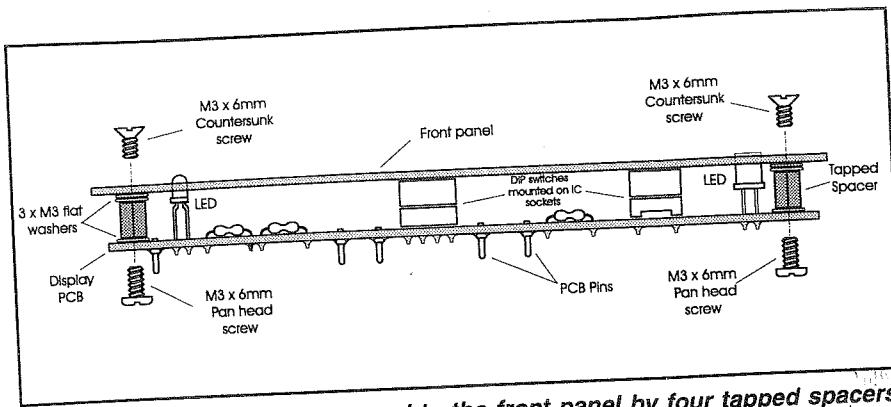

Fig.4: The display PCB is secured to the front panel by four tapped spacers. Each spacer uses three washers (as shown) to correctly space the PCB from the front panel. Both the rectangular and round LEDs are soldered in position so that they sit flush with the front panel. Note, the wiring to the display printed circuit board is made to the PCB pins which are inserted and soldered from the copper side of the printed circuit board.

closed at D5, D6 and D7 for the moment, then the OR gate output (at the lower end of R5) will be low when LEDs 5, 6 or 7 are on - that is, when the mains voltage is 235, 240 or 245 volts.

Conversely, the OR gate output will go high when the mains voltage is outside this range, since under these conditions one of the other LM3914 outputs will be low. This mains accept/reject signal is then applied to the timer chip's reset input (pin 12 of U2), plus LED12's Schmitt NAND controlling gate U3d.

Looking at the 4060 counter/timer chip first, you can see that U2 is enabled under 'normal' conditions (accept/reject signal low), but held reset when the mains is out of the voltage range selected by DIP switch SW1. Components C3, R7 and R8 set U2's internal oscillator to run at around 8.5Hz, so outputs Q7, 9, 11 and 13 correspond to time delays of 15 seconds, one minute, four minutes and 16 minutes, respectively.

These four outputs are applied to the

holdoff delay DIP switch (SW2), where one output is selected and then passed to the following stages and diode D1. Assuming SW2 has selected U2's Q9 output (as shown), this will go high after a delay of around one minute and disable the chip's clock circuit via D1 (at CIN, pin 11). As a result, the 4060 then sits in a state of 'limbo' with the selected output held high, and will remain in this condition until it's reset by the accept/reject control line.

This is in fact the true normal or 'ready' state of the circuit, when the mains voltage is acceptable. In this mode, the high at the output of SW2 activates the mains output relay (RLA) via R13 and switching transistor Q1, so the unit's 240V mains source is passed to the mains out connections via RLA's contacts.

The high at the output of SW2 is also applied to the SET input of the 'event memory' latch, a negative-edge triggered flipflop made up of NAND gates U3a and U3b. This is normally in a reset

state, and can be forced back into this mode by a low level applied by memory reset switch SW3.

The flipflop's Q output (pin 3 of U3a) is then used to control the action of the following oscillator stage, based on NAND gate U3c. This is arranged to oscillate at around 1Hz by feedback components R10 and C4, and is normally in a disabled state since the flipflop's Q output is low. In this state the output of U3c is high, and since the collector of Q1 is low when the mains is 'in-band', LED11 is activated via R12 - thereby indicating that the 240V outlet is on.

Note that since the accept/reject line is low under normal conditions, gate U3d's output will be high and LED12 (mains hi/low) is off.

So there we have the normal state of the circuit, when the mains is in the 'accepted' band as defined by the voltage range DIP switch, SW1. In summary, the OR gate output (the accept/reject line) is low, the 4060 timer chip (U2) is in its 'limbo' state, the event memory flipflop (U3a/b) is reset, and the mains outlet relay (RLA) is engaged.

When the mains voltage then moves out of the accepted band, the resulting high level on the accept/reject control line resets U2, forcing all of its outputs low. This in turn immediately shuts off Q1, RLA and the mains output, and sets the event flipflop U3a/b.

The high at the flipflop's Q output then enables oscillator U3c, which in turn applies 1Hz pulses to gate U3d. This gate has now been enabled by the accept/reject line (at pin 12), so its output follows the 1Hz pulses - causing LED12 to flash in sympathy. Note that LED11 (output) is now off, since the collector of Q1 has gone high.

The circuit then remains in this condition - with the 240V outlet off, LED12 flashing, and LED11 off - until the mains voltage moves back into the accepted range. When this occurs the accept/reject line returns to a high level, which disables LED12 via U3d and re-enables the timer chip U2. Its internal oscillator is no longer disabled via D1 (all U2's outputs are low) and it begins to clock the counter in 118ms (8.5Hz) increments.

This is the circuit's holdoff period, which continues until the 4060 output selected by SW2 (holdoff time) goes high. If the selected output is say Q9, as shown in the schematic, the holdoff time is terminated after 512 counts (60 seconds), where the resulting high at Q9

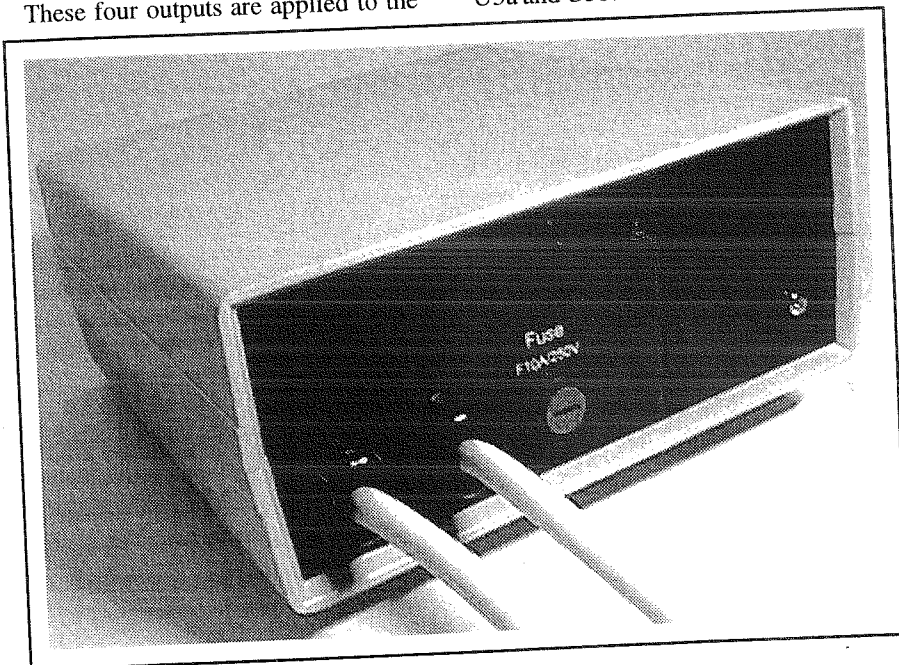

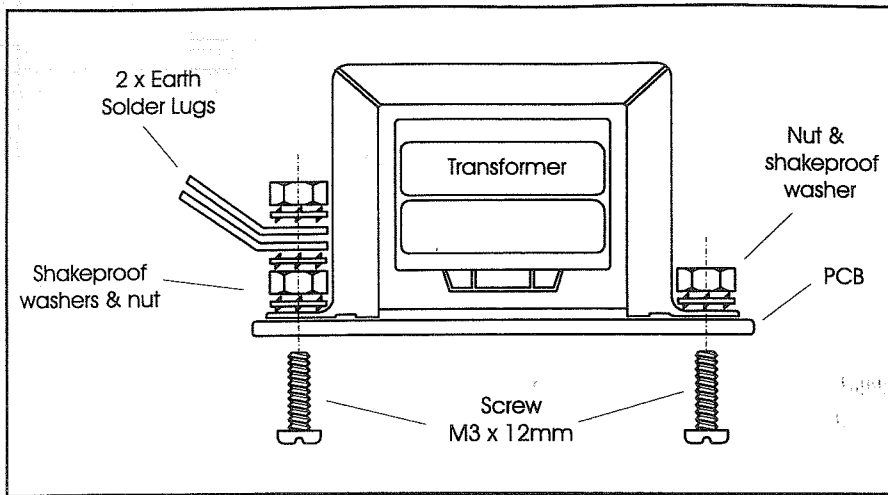

Fig.5: One of the transformer mounting screws is used as the main earth connection. The above diagram shows the correct mounting of the solder lugs using the screws, nuts and shakeproof washers provided.

forces U2 back into its 'limbo' state. The mains outlet is then reactivated via Q1 and RLA, and most of the circuit returns to its normal/ready state, as detailed above.

One thing that *has* changed however, is that the event flipflop (U3a/b) has been set during the mains-off sequence, which leaves the oscillator stage U3c enabled. As a result, LED11 (output on) will now flash at a 1Hz rate, indicating that a mains-off event has occurred. Activating SW3 will then reset the event flipflop, returning the circuit to its true standby or normal state with LED11 continuously on.

Lastly, you may have noticed that we've added siren and buzzer output connection points at Q1 and U3d, respectively. These are optional of course, and can be used in critical applications where those nearby need to be alerted

that the load has been shutoff, due to a shift in the mains voltage.

Note that the 'optional buzzer' output from U3d is compatible with a low-current style of buzzer, while the siren output at Q1 can be used to drive one of the high-efficiency piezo sirens - where all nearby *must* know that the load's been disconnected. It will sound continuously when the unit's mains outlet is off, while the buzzer pulses at the 1Hz rate when the mains is out of the accepted band. Also, both the buzzer and siren must be connected between their respective output and the positive supply rail, at the PCB pads provided.

Construction

The Mains Monitor is quite easy to put together, with the only slightly tricky part organising the display-board spacing of the DIP switches. They need to sit

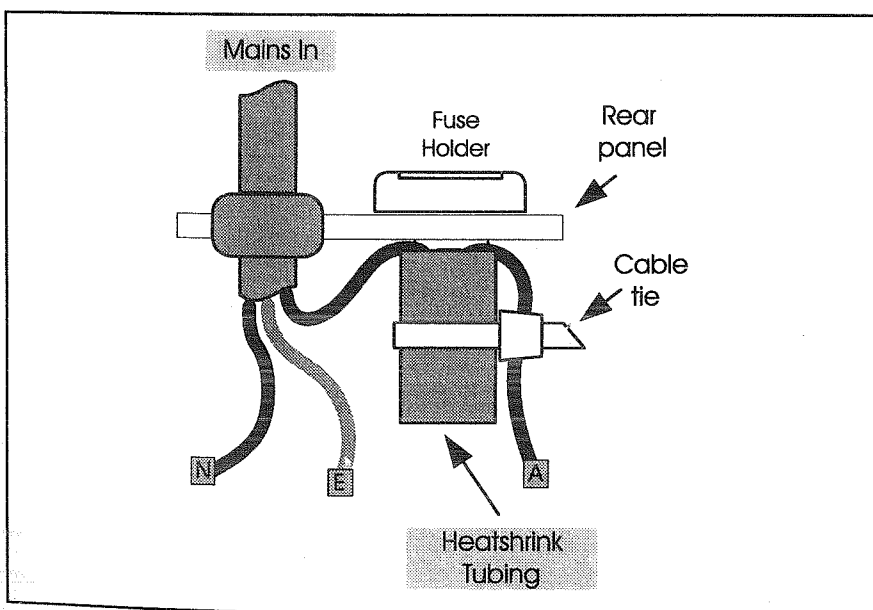

Fig.6: Shows how to insulate the fuse holder using a length of heatshrink tubing. This is done by sliding a piece of tubing over it's entire length and applying heat carefully until the tubing shrinks in size forming a glove tight fit. Finally, use a cable tie to secure the active lead to the fuse holder body as shown.

hard against the inside front panel. The 240V mains connections are relatively straightforward too, but as with other projects which actively switch the mains, you need to pay particular attention to the accuracy and safety of your 240V wiring (see fig.2).

All of the monitor's circuitry is contained on two circuit boards which fit neatly into a standard 155 x 65 x 160mm plastic instrument case, with only five wires passing between the PCBs.

As you can see from the shots of the prototype, the larger of the two PCBs (120 x 66mm, coded 99mm6b/ZA1097A) mounts upside down into the top half of the case, and this board holds the power supply components, mains connections and relay, plus the power transformer itself. The 'brains' of the circuit is held by the smaller PCB mounted behind the front panel (140 x 50mm, coded 99mm6a/ZA1097B), which is simply bolted to the panel at four perimeter points.

Begin the construction by assembling the power supply board first, while using the component overlay diagram as a guide. Start with the lower profile components in the usual way, while paying particular attention to the orientation of the semiconductors and electrolytic capacitors - note that D11 and D12 face in opposite directions. Fit PCB pins at all the external (low-voltage) connection points, and if you're using five-band close tolerance resistors it's worthwhile checking their value with a multimeter, before each is installed.

Move onto the larger parts (making sure that the electrolytic caps, terminal blocks and the relay are fitted hard down on the board surface) and complete the assembly by bolting the power transformer in place. Note that its frame must make a reliable electrical contact with the earthed copper area on the PCB, so star and locking washers should be used on the screw/nut assembly.

The transformer's primary (brown/blue) and secondary leads can now be trimmed to length and attached to the board connections as shown, and the whole assembly bolted into the upper half of the case.

Note that the plastic instrument cases have the widest array of moulded mounting pillars on the *upper* half of the box, so you'll need to attach the power supply assembly to this half, and effectively build the unit upside down internally. In this way, you won't end up with PCB mounting screw holes in the

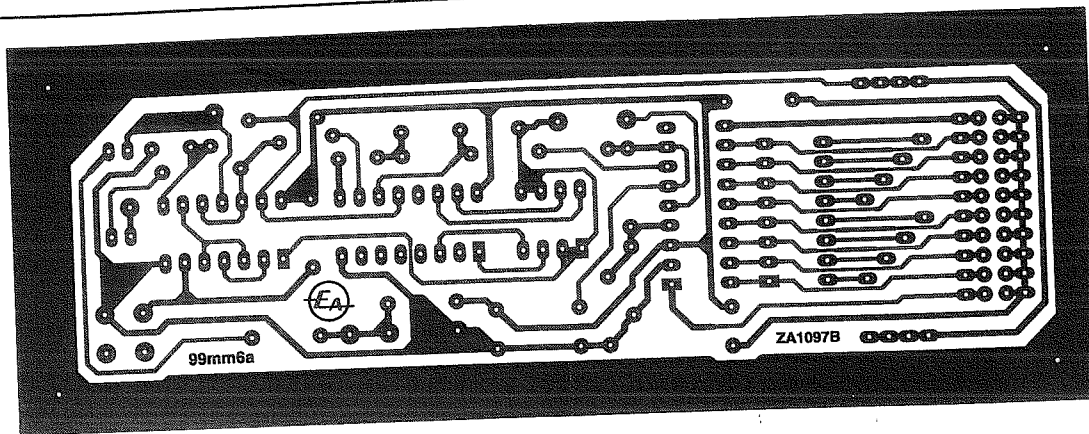

Here's actual-size copies of the PCB artwork, so you can make up your own - of course, it's a lot easier to use ready-to-go boards supplied with a kit...

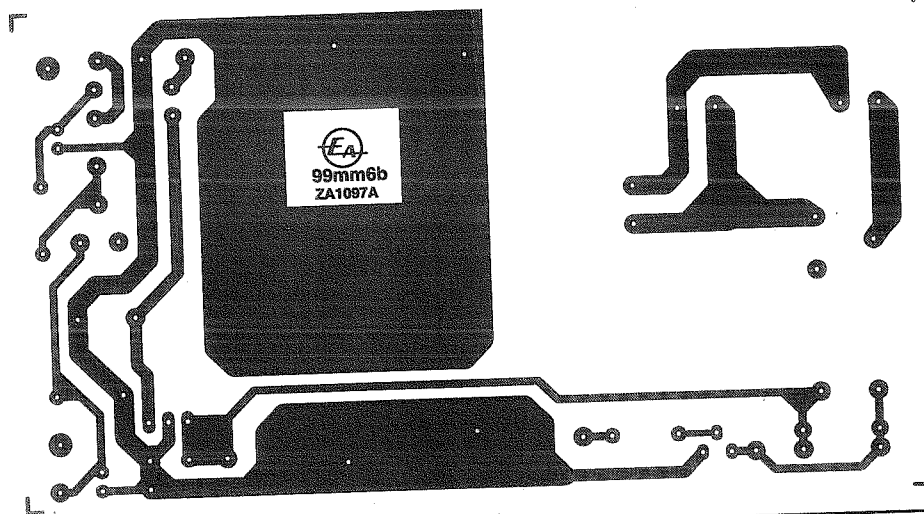

bottom of the case, or case-assembly screw holes and moulded feet on the top of your unit. The connections to the front panel assembly won't be affected by the power supply PCB 'hanging from the lid'...

The rear panel assembly and mains wiring can now be completed, while carefully using the component overlay

as a connection guide. The mains in and out cables are most easily made from a low-cost extension cord (by cutting it in half), and should pass through the unit's rear panel via suitable cord grip grommets. Other than that, the fuseholder must be wired as shown on the overlay diagram, and of course, its exposed connecting pins well covered with heat

shrink tubing.

At this point you can perform a few initial checks on the power supply board, before moving on to the controller PCB assembly. Be very careful during these tests, since as you might expect, there are lethal voltages present inside the unit - more specifically, on the PCB tracks connecting the relay and terminal blocks, plus the recessed terminal block screws themselves.

Apply mains power to the unit, then check the voltage at the +12V and V_{mon} outputs, where the latter should read around five or six volts with the trimpot RV1 in mid position.

If all's well, you can then test the relay action by *carefully* connecting the +12V point to the Q_b (Q1 base resistor) connection with a wire link or test lead. The relay should respond with an audible click as it closes, and if you've plugged a load into the unit's 240V outlet (say, a desk lamp), this should turn on accordingly.

You can now move on to assembling the controller board, while again following through the same small-to-larger component installation procedure, and using the relevant component overlay as

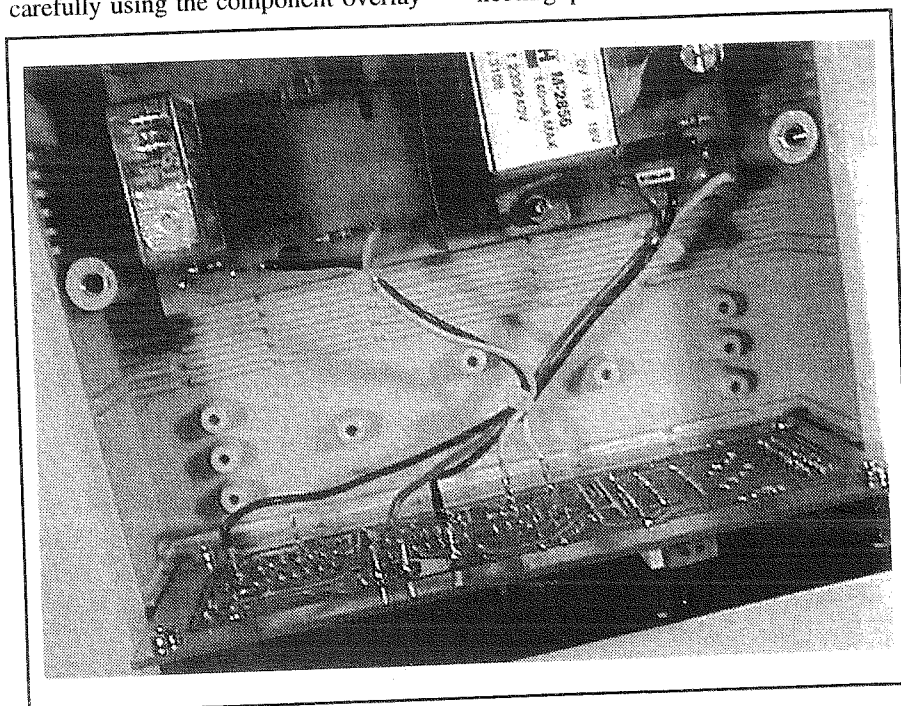

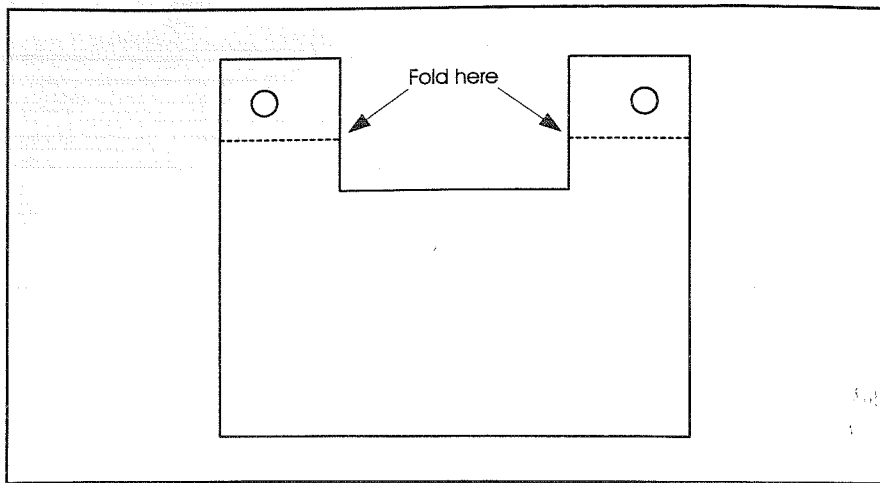

Fig.8: Use this actual size template to shape and cut the elephantide insulating paper. The elephantide is placed on the terminal block side of the transformer and held in position by two mounting screws. Refer to fig.3 for positioning.

a guide. Note that the ICs, DIP switches, individual round and rectangle LEDs should not be fitted at this stage, as you'll need to decide on a mounting method that suits the final board-to-panel space.

By the way, the PCB terminal pins mount on the copper side of this board, for easy connection to the other PCB later.

Other points to be aware of here are the orientation of diodes D2 to D9 (two banks arranged in opposite directions), the positioning and polarity of tantalum electros C7 and C4 (mounted horizontally to avoid fouling the front panel), plus the orientation of the pushbutton switch SW3. The pins on this type of switch are linked in pairs, so you'll need to check with your multimeter that the linked pins are on the left and right, as indicated on the overlay diagram.

With the majority of components installed, you now need to decide the best way to mount the LEDs and DIP switches so that they suit the height of the existing board components, and in particular, that of the pushbutton switch. As the front panel has cutouts to match the DIP switches and leds, the aim here is to set their above-board height so that they're roughly flush with the front panel (inner or outer) surfaces, while the pushbutton switch protrudes comfortably through the panel (see fig.4).

This might sound a little convoluted, but you'll soon get the idea when you check how the panel and board assembly fit together. With the standard components used in our prototype, the DIP switches needed to be raised by about 5mm, so fitting those components with IC sockets did the trick.

Once you're happy with the component height arrangements, install the LEDs and DIP switches, but don't solder until everything is sitting exactly as needed - note their polarity on the overlay diagram.

Now fit the assembly to the front panel using suitable screws, spacers and nuts, then solder each LED in place so that the lens just pokes through the front panel. After that, connect five short lengths of hookup wire between the two boards as shown, and you're ready to fire up the completed unit for a few checks.

Tests and setting up

The initial checks are best done with RV1 set to mid-travel, the holdoff time set at 15 seconds and the voltage range set to one step on either side of the currently shown mains voltage. That is, if the bargraph is showing the mains as 240V, set the range DIP switch so that 235V, 240V and 245V are accepted.

If display does not show a sensible mains voltage reading, you may have a power transformer with an usually high

or low output voltage, and RV1 will need to be adjusted. As there's 240VAC voltages inside the unit, use an insulated adjustment tool (a modified plastic knitting needle if nothing else is available) and be very careful during the procedure. Of course, if you can't adjust RV1 for any reading, then there's probably some kind of fault around the LM3914 chip U1.

Assuming that all's well, you can now check that the relay engages about 15 seconds after power is applied to the unit, and the output LED activates. This should flash at around 1Hz (since there's been a mains dropout, in effect), then change to continuously on when the 'mem reset' pushbutton is pressed.

A similar sequence of events should also happen if you induce a mains fault by momentarily switching off the DIP switch that corresponds to the current mains voltage. In this case though, the 'mains hi/low' LED should flash while the switch is off, indicating that the mains is out of the acceptable range.

This brings us to the thorny issue of calibration. While you'll ultimately want the Mains Monitor to shut off the load when the mains voltage is unsuitable, this is largely a subjective judgment based on the nature of the 240V equipment being controlled. In practice then, a moderate degree of error in the unit's readout won't really compromise its effectiveness, as long as the voltage range has been set while the mains is stable.

On the other hand, it's quite a simple job to calibrate the unit using RV1 - you just adjust the trimpot until the display readout matches the current mains voltage. The problem here though, is one of safety.

It's undeniably risky to measure the 240V mains with a multimeter and its exposed probes, but to do this at the same time as adjusting a trimpot is really asking for trouble. In this case we strongly suggest that constructors *do not* calibrate the unit themselves, and take the completed unit to a licensed electrician or technician for adjustment.

Assembly Notes

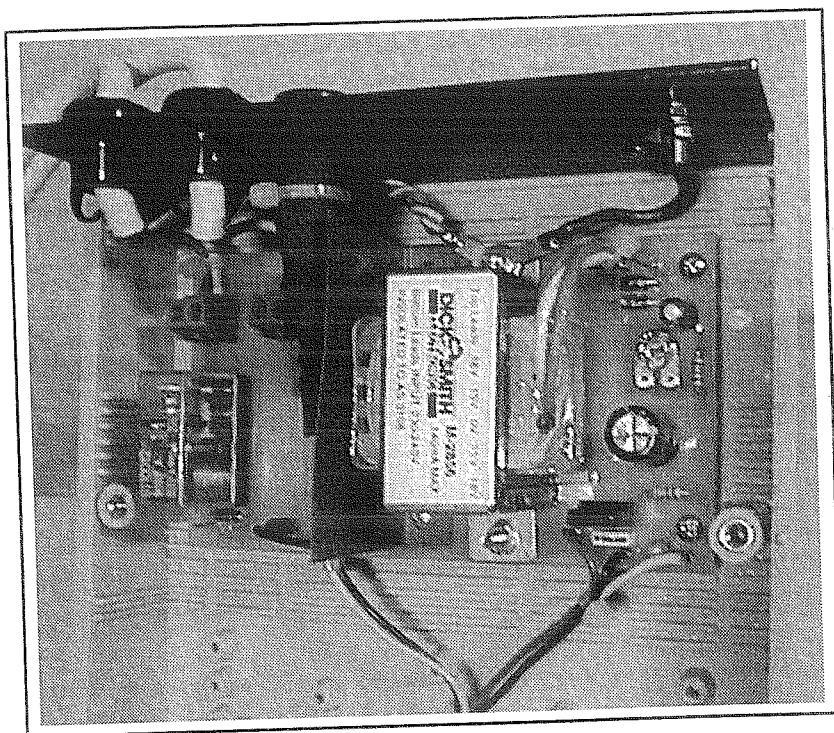
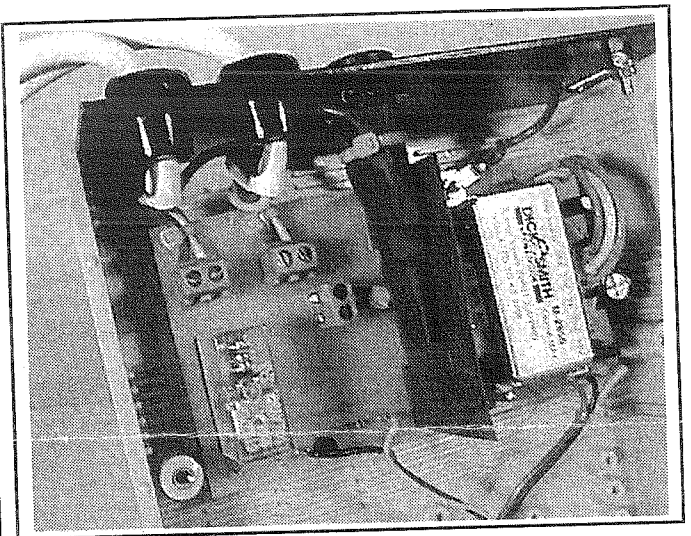
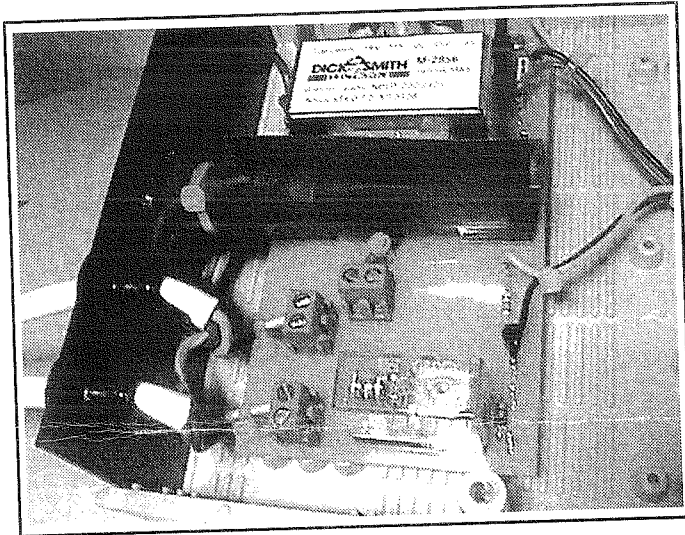
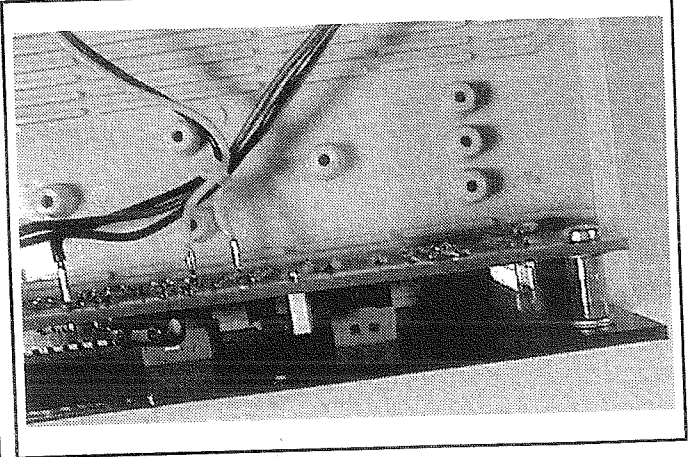
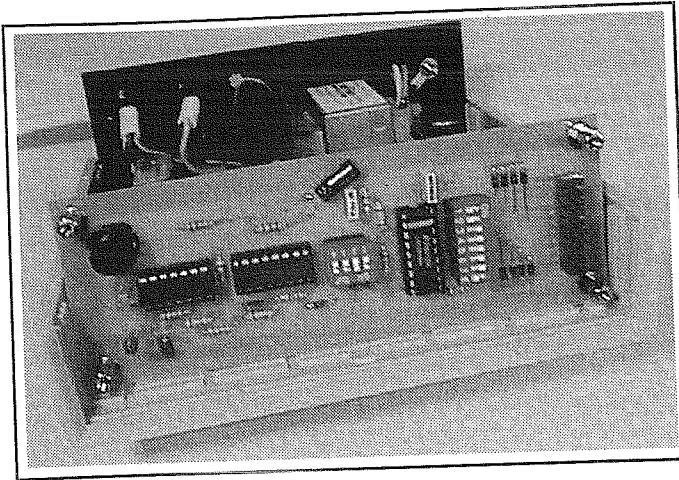

DICK SMITH
ELECTRONICS

ACN 000 908 716
CNR Lane Cove & Waterloo Roads
North Ryde NSW 2113
PH: (02) (Int 612) 9937 3200 Fax: (02) 9888 3631