

INSTRUCTION MANUAL

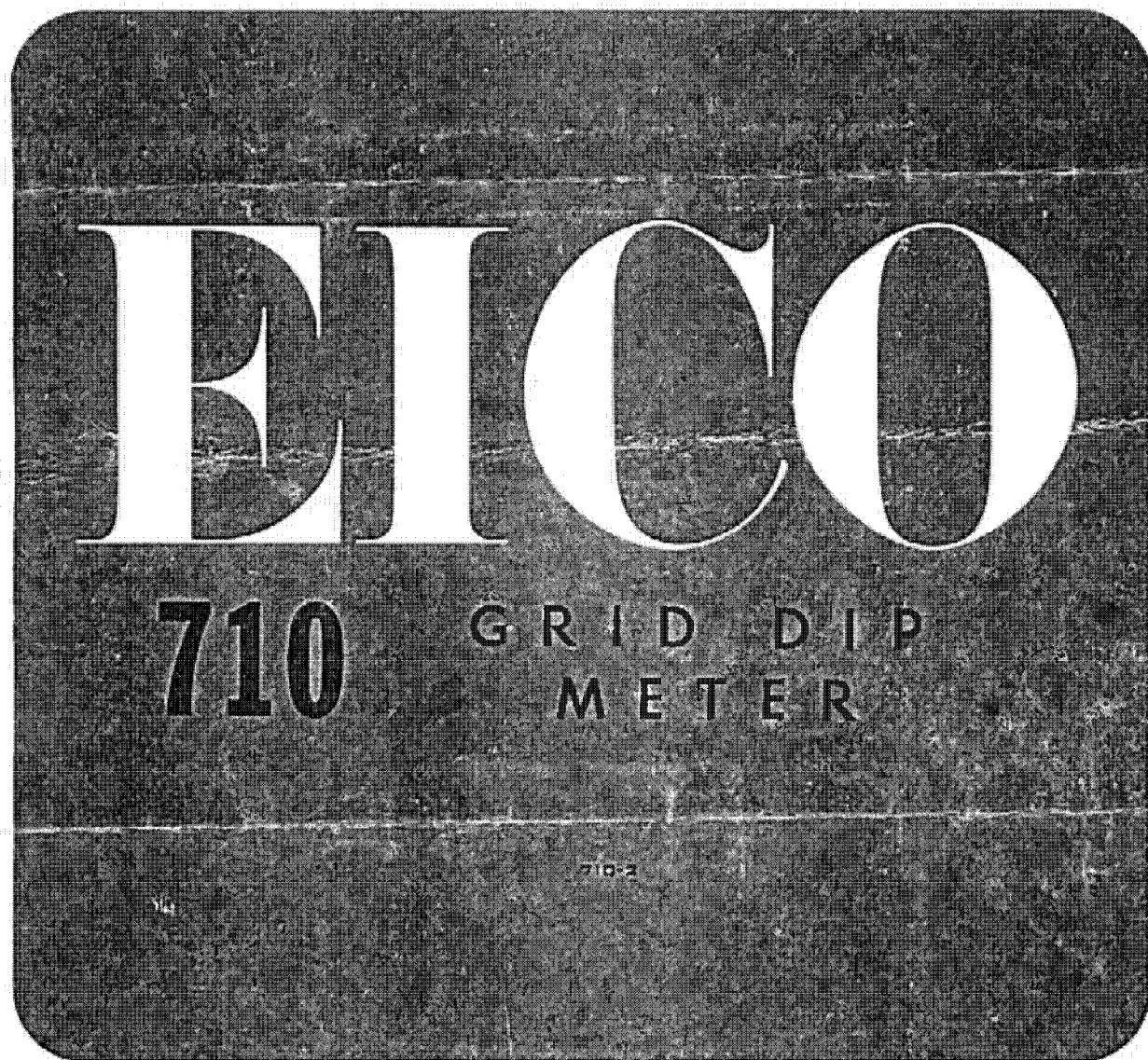
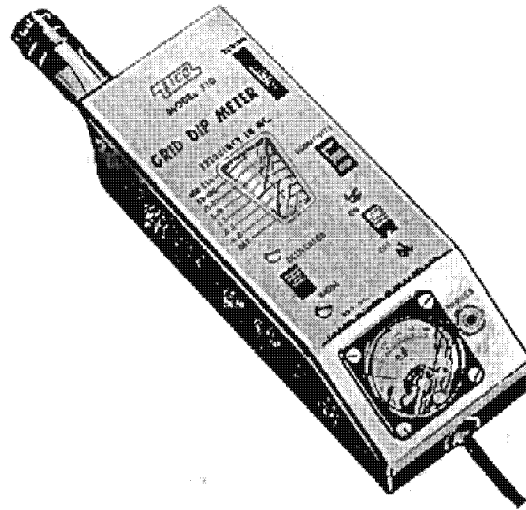

131-01 39th Ave., Flushing, N. Y. 11352

MODEL 710

GRID DIP METER



general description

A grid-dip oscillator (g.d.o.) is basically a variable high frequency oscillator with a d-c microammeter in the grid return circuit to indicate relative power. The selected plug-in tank coil is mounted externally to serve as a "probe" that can be coupled appropriately to the circuit or source in question; a complete set of plug-in coils is provided to cover a wide range of frequencies from 400 kc to 250 mc. The tank capacitor is variable and calibrated for eight frequency ranges, one frequency range for every coil provided. As a g.d.o., the 710 can be used to determine the resonant frequency of de-energized resonant circuits or self-resonant components. Indirectly, therefore, it can also be used to determine values of capacitance, inductance, or Q by procedures that will be described. Since it is basically a v.f.o., the 710 may also be used as a signal or marker generator. By switching off the oscillator plate supply, the 710 becomes a tuned r-f diode detector with a meter in the diode load circuit. As such, it can be used to determine the frequency of r-f energy sources. With the plate supply switched on again, but a headphone plugged into the phone jack, the 710 becomes an oscillating detector. This provides a very sensitive method for determining the frequency of unknown r-f energy sources, namely that of "beating" the unknown r-f energy picked up by the "probe" coil against the frequency generated by the internal variable oscillator.

SPECIFICATIONS

Frequency Range: 400 kc-250 mc in 8 overlapping ranges

Meter Movement: 500 microamperes.

Plug-in Coils: Wound to $\pm 0.5\%$ accuracy on polystyrene forms. Coil A - 400 to 700 kc; coil B - 700 to 1380 kc; coil C - 1380 to 2900 kc; coil D - 2.9 to 7.5 mc; coil E - 7.5 to 18 mc; coil F - 18 to 42 mc; coil G - 42 to 100 mc; coil H - 100 to 250 mc (hairpin).

Circuit: Exceptional stability is obtained with improved grid current stability over tuning range.

Tuning: Variable capacitor, equipped with planetary drive of 1:7 ratio.

Tube: 6AF4 (A) (Colpitts oscillator).

Scales: All the same length, 3 3/4" long, wrapped on cylindrical drum rotating through 340 degrees. Pilot lamp illuminates scales and edge-lights hairline engraved on plexiglass scale window.

Power Requirements: 117V 50/60 cy; 10 watts.

Power Supply: Transformer-operated selenium rectifier.

Dimensions: 2 1/4" high, 2-9/16" wide, 6 7/8" long.

Net Weight: 3 lbs.

Panel: Brushed satin aluminum, permanent acid-etched lettering.

Case: Steel, permanent gray wrinkle finish.

functions of controls

TUNING Control: Mechanically coupled to shaft of variable air capacitor. Determines the tuning frequency of the variable air capacitor and the plug-in "probe" coil.

OSCILLATOR-DIODE Switch: SPST switch in the oscillator plate voltage supply line. At OSCILLATOR position, B+ voltage is applied to the plate of the internal tube which then operates as an oscillator. At DIODE position, plate supply is disabled and the internal tube operates as a diode.

METER: Sensitive d-c microammeter in grid return circuit of oscillator tube to indicate relative power at the OSCILLATOR position of the OSCILLATOR-DIODE switch. In the diode load circuit to indicate relative value of detected r-f at the DIODE position of the OSCILLATOR-DIODE switch.

PHONE Jack: Intended to receive high impedance head-

phone (over 500 ohms), either crystal or magnetic. Inserting the phone plug automatically cuts out the meter with the phone taking its place in the circuit. Phone is an audio frequency signal indicator required for "zero-beat" comparison of internal and external frequencies, rather than a dc level indicator as is the meter.

SENSITIVITY Control: Rheostat, shunting meter or phone. Setting determines meter or phone sensitivity, which has to be adjustable to the conditions of use (degree of coupling, strength of signal, mode of operation, etc.).

ON-OFF Switch: Connects or disconnects instrument from a-c power line.

COIL Socket: Receives appropriate plug-in coil for desired range of frequencies.

operation

In all cases, the instrument takes operating power from the 105-125 volt, 50/60 cycle ac line and is turned on or off by the ON-OFF switch. The size and arrangement of controls permits one-handed operation and the meter is angled to permit observation in any position from vertical to horizontal.

WARNING: It is possible to receive a disabling or lethal shock when operating the grid-dip meter near high-voltage circuits should accidental contact of the probe coil or the instrument case to the high voltage circuit occur. Be extremely careful and observe all high voltage precautions.

1) **Grid-Dip Oscillator (g. d. o.):** Used to determine the resonant frequency of de-energized r-f circuits or self-resonant components such as coils and capacitors. The probe coil covering the expected frequency range is plugged into the coil socket and the OSCILLATOR-DIODE switch is thrown to OSCILLATOR. The 710 then becomes a variable high frequency oscillator with a d-c microammeter in the grid return circuit to indicate relative power. When the "probe" coil is coupled to an r-f circuit resonant in the frequency range covered by the particular coil, turning the TUNING control to the resonant frequency will be accompanied by a dip (decrease) in the meter reading due to the power absorbed by the resonant circuit. Before searching for the grid-dip, set the SENSITIVITY control for a mid-scale reading on the meter at the center of the frequency range, which will normally be satisfactory for a search over that particular band. In searching for the grid-dip, the meter reading will vary gradually as the TUNING control is turned, until the vicinity of the

correct frequency is reached. In this vicinity, a more or less sharp dip will occur, depending on the circuit Q. Read the frequency dial setting for the particular coil used at the lowest point of the dip. Note that no power is applied to the r-f circuit in question during g. d. o. operation. If there is some question as to whether the g. d. o. is measuring the resonant frequency of the desired tuned circuit in an equipment, vary the g. d. o. frequency until the grid dip is obtained; then moisten one finger and touch it to an ungrounded point in the circuit in question. No reaction in the g. d. o. meter means the resonance is of another circuit. Remember that power must be turned off before touching the test circuit. Another point worthy of note regards g. d. o. operation is that harmonics of lumped-constant networks will not show up. However, indication will sometimes occur of other resonant circuits formed by wiring, stray capacitances, etc., usually at a higher frequency. Harmonics of transmission lines and antennas will be indicated also.

2) **Tuned R-f Diode (t. r. f. diode):** (Also called non-oscillating detector, or absorption-type frequency meter). Used to determine the frequency of r-f energy in an energized r-f circuit. The probe coil covering the expected range is plugged into the coil socket and the OSCILLATOR-DIODE switch is thrown to DIODE. The 710 then becomes a tuned r-f diode detector or absorption-type frequency meter. The instrument meter is effectively in the diode load circuit and will read increasingly up-scale as the TUNING control is turned to the vicinity of the r-f frequency in question when the "probe" coil is coupled closely to the r-f energy source. The energy of the r-f

source must be at least 500,000 microvolts if this method of frequency determination is to be effective. Read the frequency dial setting for the particular coil used at the maximum meter reading. Use the SENSITIVITY control to keep the maximum meter reading on-scale. See methods of coupling.

3) Oscillating Detector: Another and more sensitive method used to determine the frequency of r-f energy. The probe coil covering the expected frequency range is plugged into the coil socket and the OSCILLATOR-DIODE switch is thrown to OSCILLATOR. A high impedance magnetic headphone is plugged into the PHONE jack which automatically cuts out the instrument meter. When the "probe" coil is suitably coupled to the unknown r-f energy source, the unknown r-f energy picked up mixes with the r-f energy in the instrument tank-circuit generated by the internal oscillator. A difference frequency equal to the difference between the external and internal frequencies is developed in the mixing and is called the

"beat" frequency. When the difference is very small, the "beat" frequency falls into the audible range and can be heard in the headphone. The "beat" note, or whistle, will drop in pitch as the external and internal frequencies are made to approach each other by varying either one as required. When one frequency is made to pass the other, the pitch of the "beat" note will rise again. The lowest pitched whistle corresponds to coincidence and is called "zero-beat", meaning a zero difference frequency. At high frequencies, the entire audible range is such a small fraction of the frequency in question, that the "zero-beat" is heard simply as a click in passing through coincidence. The oscillating detector method of frequency measurement is more sensitive than the f. r. f. diode method because the Q of the tank circuit is lowered by the diode.

4) Signal Marker Generator: With g.d.o. operation, the 710 can be used as a signal or marker generator, except where special shielding or a known r-f output voltage is required.

methods of coupling

Various proper methods of coupling are shown in Fig. 1. In any case, greatest frequency accuracy can be achieved by using the loosest possible coupling that gives sufficient indication.

Too close a coupling in g.d.o. operation is indicated by the dip occurring at a slightly different frequency when it is approached from the high frequency side than when it is approached from the low frequency side. It is therefore, desirable to check the dip frequency from both the high and low sides. However, a close coupling (e.g. 1/4 inch) is desirable at first to find the dip; a further aid

in finding the dip is to approach it from the frequency side on which the meter reading is generally rising, so that the dip is more noticeable when it occurs.

Too close a coupling in oscillating detector operation may cause the 710 oscillator to "lock in" with the external r-f source, thus defeating the measurement. This condition can be uncovered by rechecking the frequency of the "zero-beat" with a looser coupling. When using capacitive coupling, avoid, as much as possible, detuning of the circuit under investigation.

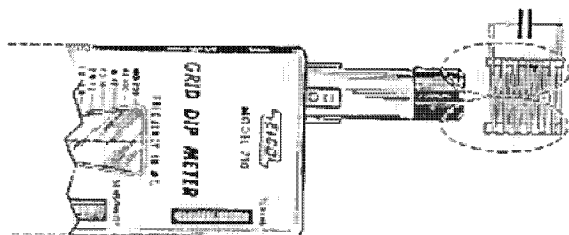

Fig. 1A. Preferred method (inductive coupling)

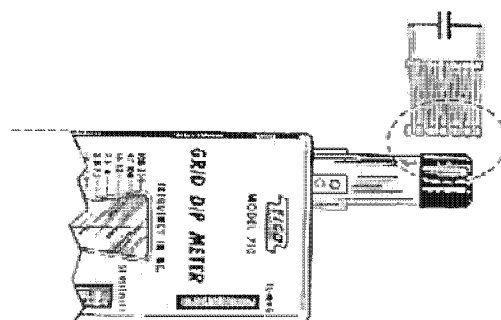

Fig. 1B. Alternate method of inductive coupling

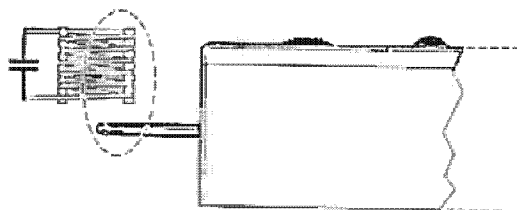

Fig. 1A'. High frequency hairpin coil inductively coupled at side

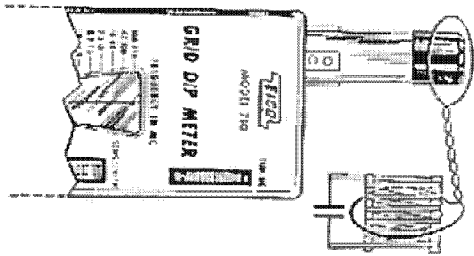

Fig. 1C. Link coupling for concealed or obstructed coil, or coils in a shielded can

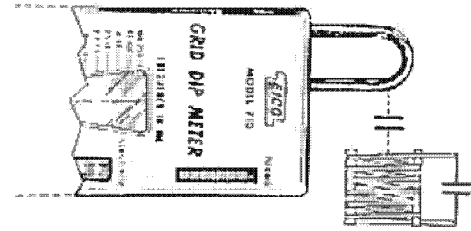

Fig. 1F. High frequency hairpin coil capacitively coupled to coil

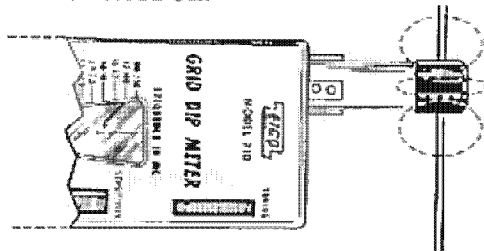

Fig. 1D. Inductive coupling to straight ungrounded wire or antenna

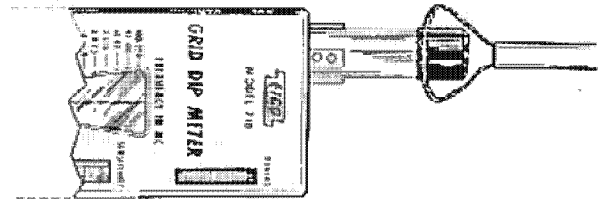

Fig. 1G. Inductive coupling to end of shorted parallel feeder line

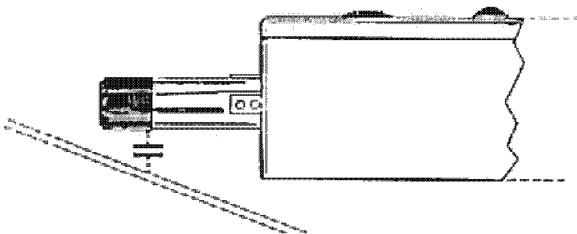

Fig. 1E. Capacitive coupling to ungrounded straight wire or antenna

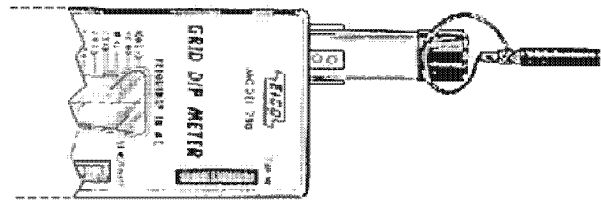

Fig. 1H. Inductive coupling to end of shorted co-axial line

applications

MEASURING AN UNKNOWN CAPACITY

The value of an unknown capacity between 50 μ f and 5000 μ f can be determined with the 710. The method is to connect the unknown capacitance across the F coil to create a resonant circuit. The 710 is then used as a g. d. o. with the C, D, or E coils plugged in, depending on the estimated capacity, to determine the resonant frequency. From the resonant frequency, the unknown capacity can be obtained from the graph of Fig. 3.

IMPORTANT NOTE: A suitable means has been provided to connect the unknown capacitance across the F coil. Two pin sockets with solder tabs are provided to which small alligator clips (not provided) should be soldered. A pin socket-&-clip arrangement is then fitted to each pin of the F coil. The pig-tail leads of the unknown capacitance are inserted in the alligator clips. **DO NOT**

solder leads directly to the pins of the F coil, as the heat would melt the plastic coil form. See Fig. 2. If the unknown capacity is less than 50 μ f, its value can be determined by paralleling an additional fixed known capacity of about 100 μ f across the unknown capacity. Subtract this fixed known capacity from the value corresponding to the resonant frequency shown in the graph of Fig. 3 to find the unknown capacity. If the precise value of the fixed capacity to be added is not known, it can be found by the method described above. Note that a slight error may be encountered in measuring capacitance values due to the distributed capacitance of the coils, shift in resonance due to self-inductance of large capacitors, and capacitance due to nearby metallic objects. The error is usually negligibly small.

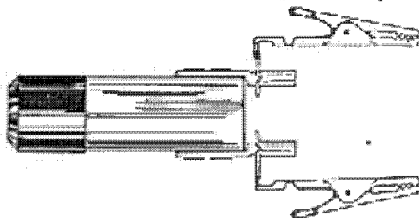

Fig. 2. Pin socket & clip attachments affixed to F coil

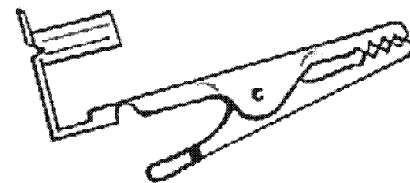
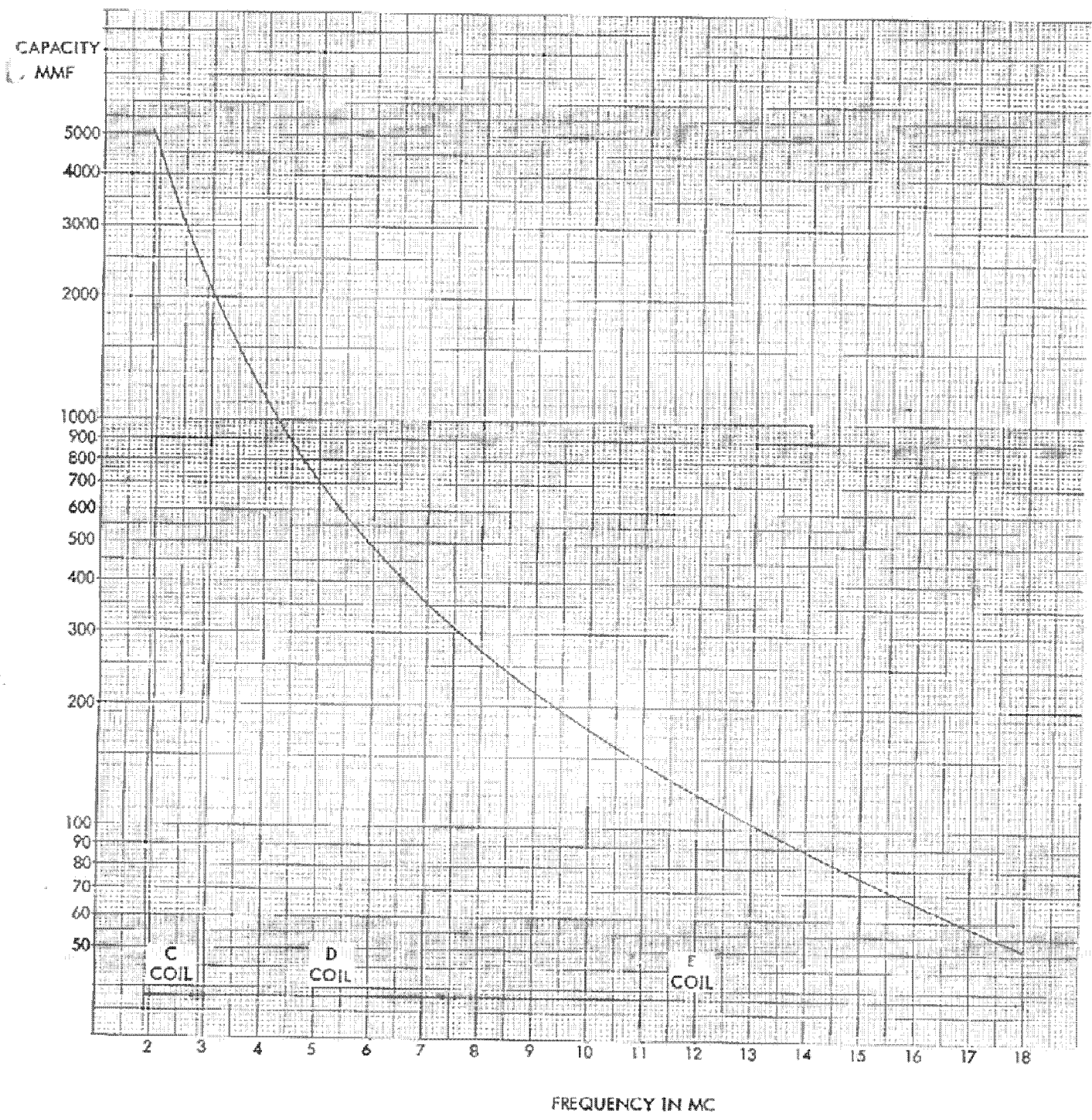

Fig. 2. Pin socket & clip detail



DETERMINE COIL (C, D, OR E) TO BE PLUGGED INTO 710 FROM ESTIMATED VALUE OF UNKNOWN CAPACITY. CAPACITY RANGE COVERED BY EACH COIL SHOWN ON FREQUENCY AXIS

BAND F COIL IN PARALLEL WITH UNKNOWN CAPACITOR IN ALL MEASUREMENTS

FIG. 3 CAPACITANCE MEASUREMENT

MEASURING INDUCTANCE

To measure the inductance of a coil, connect a low tolerance capacitor (silver mica) across it of about 100 uuf. Using the 710 as a g.d.o., couple the probe coil to the unknown coil and determine the resonant frequency. The unknown coil inductance L can be found from the relationship given below. In this formula, the resonant frequency measured is "f" (in cps) and the known fixed capacity "C" (in farads). The value found for L will be in henries.

$$L = \frac{1}{39.48f^2C}$$

MEASURING CIRCUIT Q

To measure the Q of a resonant circuit, use the 710 as a signal generator. Connect a VTVM with an RF probe across the circuit in question. Couple the probe coil to the coil in the resonant circuit and find the resonant frequency, which should correspond to a maximum or peak voltage reading on the VTVM. Note the resonant frequency. Then shift the 710 frequency on both sides of resonance to points where the VTVM voltage reading is about 70.7% (3 db down) of the maximum voltage reading noted at resonance. Note the frequencies at which these voltage readings occur, and then subtract the lower frequency value from the higher frequency value to determine the difference frequency. The value of Q can be found from the following relationship, where fr is the resonant frequency and f1-f2 the difference between the frequencies where the response is 3 db down.

$$Q = \frac{f_r}{f_1 - f_2}$$

RECEIVER TUNED CIRCUITS

Use instrument as g.d.o. With receiver power off adjust each tuned circuit to the desired frequency. Gang-tuned circuits should be checked at both ends of the range and a few points in between. After completing these adjustments, apply power to the receiver and use the 710 as a signal generator to check the final alignment. This is done by attaching a very short antenna to the receiver input terminals and locating the 710 a few feet away from the receiver at some point where it is removed from nearby conductors, and where body movements can not affect the r-f signal from the instrument. Alternatively, the 710 can be located a few feet from the receiver at a convenient point along the receiver transmission line. Tune the receiver, with AVC on, to a frequency at which no signals are present. An "S" meter, a vtvm, or some sort of indicator must be connected to the receiver detector. If the receiver is a superheterodyne and it is not functioning it may be useful to check the operation of the local oscillator. Using the 710 as a t.r.f. diode, couple the probe coil to the receiver oscillator coil. A maximum up-scale reading should be obtained at the resonant frequency of oscillator tank circuit if it is functioning.

PRE-SETTING TRANSMITTER TUNED CIRCUITS

Use instrument as g.d.o. Remove plate power from transmitter but leave all tube in the sockets and all circuits completed. Proceed to adjust tank circuits to desired frequency, after which plate power may be applied and final adjustments of alignment made with grid and plate meter indications. Using the 710 as a t.r.f. diode, each tank may be checked for correct frequency. The 710 may also be used as an oscillating detector for this work, but the increased sensitivity makes it necessary to avoid mistaking beats with other energized r-f circuits. Beating with the desired tank circuit may be checked by moving the probe coil nearer to it; increased volume of the audible beat indicates that the desired circuit is being checked. Also, beating against harmonics may occur. The lowest frequency beat heard is the fundamental.

NEUTRALIZATION

Use instrument as t.r.f. diode. Remove plate power from the stage to be neutralized (filament power should remain applied) and apply power to the driving stage. Couple the 710 "probe" coil to the output tank of the stage being neutralized. Set the instrument to the driving frequency and check for the presence of r.f. in the output tank circuit as evidenced by some meter reading other than zero. If r.f. is present, adjust the neutralizing capacitor until the meter reading goes to zero.

Another method, which can be used to check neutralization, requires operation of the 710 as a g.d.o. Again, plate power is removed from the transmitter but filament power remains applied. The 710 is then coupled to the grid tank of the stage to be neutralized with the meter set to the bottom of the dip. The instrument meter reading should remain unaffected as the plate tank capacitor is varied if neutralization has been achieved.

PARASITIC OSCILLATIONS

Use instrument as oscillating detector. With power applied to the transmitter, listen on headphone while varying the operating frequency of the 710 for a beat indicating the presence of a parasitic oscillation. If a parasitic is found, read its frequency from the 710 scale. Remove power from the transmitter and use the instrument as a g.d.o. to find the circuit or component resonant at the parasitic frequency.

ANTENNA ADJUSTMENTS

The 710 used as a g.d.o. aids in the adjustment of antennas without causing interference. However, there are many different types of antennas, feeders, and couplings that can be used and each situation has its specific adjustment requirements. When a particular antenna set-up is chosen to meet the needs of a given situation, an understanding of how the antenna operates will permit intelligent use of the 710 to aid in making adjustments properly. The antenna should always be near its final height and position if the resonance readings are to have real value.

In any case, the proper type of coupling should be used (inductive at current maximums, capacitive at voltage maximums) and this coupling should usually be loose. Coupling along the line or at the ends is possible with parallel feed lines, but a co-axial line can only be coupled to at the ends. Checking at the end of a line is usually done by inductive coupling to a shorting loop across the inner and outer conductors of the co-ax cable or across the ends of the parallel feeders.

Correct matching of open wire lines to an antenna can be checked by using the 710 as a t. r. f. diode to indicate the presence of standing waves. The instrument "probe" coil must be moved along the line with constant coupling maintained. All of the "probe" coils, except the hair-pin high-frequency coil, have insulating caps which permit this to be done without holding a piece of insulating material between the "probe" coil and the line. Considerable variation in readings indicates the presence of standing waves. When correct matching of the line is obtained,

standing waves will disappear. For the latter operation, power must be fed into the feed lines by the transmitter.

To determine correct matching of a co-axial line, use the instrument as a t. r. f. diode. Only in this case, place it near the antenna where it will serve as a field-strength meter. Correct matching is indicated by maximum meter indication, corresponding to maximum output from the antenna.

CHECKING QUARTZ CRYSTALS

Use the Instrument as a g. d. o. Connect a short lead with an alligator clip at each end across the crystal holder pins. Insert the instrument "probe" coil into the loop made by the lead and tune for the grid-dip indication. The crystal frequency can then be read from the instrument's frequency scales. This check also indicates the activity of the crystal, since an inactive crystal will not produce the grid-dip indication.

maintenance

Included in this section are a VOLTAGE CHART, a RESISTANCE CHART, and a TROUBLE-SHOOTING CHART

listing common symptoms of trouble together with their possible causes.

VOLTAGE CHART

TERMINAL BOARD TB1	Lug 2	Lug 3
	125 DC	108 DC

TUBE SOCKET XVI	Pin 1	Pin 3	Pin 4	Pin 5	Pin 7	Pin 2	Pin 6	
	55 DC	0	6.3 AC	0	55 DC	-20 DC	-20 DC	
							NEGATIVE	

CONDITIONS OF MEASUREMENT: Coil A is inserted in coil socket. OSCILLATOR-DIODE switch set to OSCILLATOR position. ON-OFF switch set to ON. SENSITIVITY control set to obtain approximately half-scale reading on meter. Negative voltages are so indicated by a minus (-) sign, positive voltages have no sign. All voltage measurements made to chassis ground. Measurements given were made with a 20,000 Ω /V VOM. Operating line voltage at which measurements are made is 117VAC, 60 cps. NOTE: ALL VOLTAGE & RESISTANCE VALUES MAY NORMALLY VARY BY \pm 15%.

RESISTANCE CHART

TERMINAL BOARD TB1	Lug 2	CONDITIONS OF MEASUREMENT: 710 line cord disconnected from AC outlet. No coil plugged into coil socket. OSCILLATOR-DIODE switch set at DIODE position. ON-OFF switch set at OFF position.			
	1 MegΩ or more*				
TUBE SOCKET XV1	Pins 1 & 7	Pins 2 & 6	Pins 3 & 5	Pin 4	
	1 MegΩ or more*	10kΩ	0	0	

*After one minute

TROUBLE-SHOOTING CHART

This chart is based on the assumption that all wiring is correct. All symptoms include assumption that the line cord is connected to the 117VAC, 60 cps line and the ON-OFF switch S2 is set at ON. M1 is meter, I1 is pilot lamp, R1 is SENSITIVITY control, S1 is OSCILLATOR-DIODE switch.

SYMPTOM	POSSIBLE CAUSE	CHECK/REMEDY
S1 at OSC., I1 not lit.	S1, S2 defective T1 defective	Replace Replace
M1 does not read with R1 adjusted to mid-rotation		
S1 at DIODE, I1 lit.	S1 defective	Short two lugs of S1 with jumper. If M1 reads, replace S1
Throwing S1 to OSC. with coil plugged in and R1 at mid-rotation does not result in M1 reading	T1 defective	Check AC voltage between T1 secondary leads (red). If absent, replace T1
	CRI defective	Replace
S1 at DIODE, I1 lit. Throwing S1 to OSC. dims I1.	Short in B+ supply Most likely shorted C7 or C6	Replace
With S1 at OSC., and any coil except H plugged in, it is impossible to obtain full-scale reading on M1 at maximum sensitivity setting of R1	Low B+ voltage Tube V1 defective Low AC line voltage (below 100 VAC)	C7, C6 defective. Replace Replace Check voltage. Booster transformer may be required if condition is usual
M1 does give any indication. Operation otherwise seems normal	M1 defective Normally closed PHONE jack is open	Replace Clean or replace
M1 reading erratic. Reading jumps while tuning	Dirt between wiper spring and shaft of C8	Clean with benzine
S1, S2, R1 do not slide or turn freely	Front panel misaligned against chassis	Loosen 4 screws which hold front panel and position it so that the controls are centered in the panel openings and no rubbing can occur. Re-tighten 4 screws.
TUNING knob rubs against tube side	Tube bracket accidentally bend	Bend tube bracket further away from TUNING knob with long-nose pliers

SERVICE

If trouble develops in your instrument which you can not remedy yourself, write to our service department listing all possible indications that might be helpful. If desired you may return the instrument to our factory where it will be placed in operating condition for \$5.00 plus the cost of parts replaced due to their being damaged in the course of construction. NOTE: Before returning this unit, be sure all parts are securely mounted. Attach a tag to the instrument, giving your home address and the trouble with the unit. Pack very carefully in a rugged container, us-

ing sufficient packing material (cotton, shredded newspaper, or excelsior), to make the unit completely immovable within the container. The original shipping carton is satisfactory, providing the original inserts are used or sufficient packing material inserted to keep the instrument immovable. Ship by prepaid Railway Express, if possible, to Electronic Instrument Co., Inc., 33-00 Northern Blvd., Long Island City 1, New York. Return shipment will be made by express collect. Note that a carrier cannot be held liable for damages in transit if packing IN HIS OPINION, is insufficient.

PARTS LIST

Stock #	Symbol	Description	Am't.
22559	C1, 2	cap., disc, ceramic, 90uuf ±5%	2
22561	C3, 4, 5	cap., disc, ceramic, 2200uuf ±5%	3
23015	C6	cap., electrolytic, 50uf 150V	1
23028	C7	cap., electrolytic, 10uf 150V	1
29012	C8	cap., variable	1
93004	CR1	rectifier, selenium	1
92000	I1	bulb, #47	1
50010	J1	jack, phone	1
97042	J2	coil, jack	1
74004	M1	meter, 500 uA	1
16018	R1	pot., miniature, 2.5K	1
10400	R2	res., 10K, 1/2W, ±10%	1
10421	R3	res., 6.8K, 1/2W, ±10%	1
10532	R4	res., 2K, 1/2W, ±5%	1
62001	S1, 2	switch, slide SPST	2
30028	T1	transformer, power	1
54008	TB1	term. board, 4 post	1
54005	TB2	term. board, 2 post right, w/gnd.	1
90053	V1	tube, 6AF4A	1
97714	X11	pilot light assembly	1
97022	XV1	socket, 7 pin miniature	1
35039	A	coil, 400 to 700kc	1
35040	B	coil, 700 to 1380kc	1
35041	C	coil, 1380 to 2900kc	1
35042	D	coil, 2.9 to 7.5mc	1
35043	E	coil, 7.5 to 18mc	1
35044	F	coil, 18-42mc	1
35045	G	coil, 42-100mc	1
35046	H Loop	coil, 100-250mc	1
40000		nut, hex 6-32 x 1/4	2
40007		nut, hex #4-40 x 1/4	9
40037		nut, hex (for miniature pot) #1-64 x 5/32	2
40034		nut, fln., #4	4
40038		nut, hex (for min. phone jack) 1/4-32 x 3/8	1
41015		screw, flat head 6-32 x 3/8	2
41016		screw, bd. head, 4-40 x 1/4	13
41023		PK, bd. head, #4 x 1/4	3
41067		screw, #4-40 x 5/8	1
41068		screw, #4-40 x 1/8	4
41069		set screw, (for large gear & tun. knob) 6-32 x 1/8	2
41070		set screw, (for bevel gear) 3-56 x 1/8	1
42007		washer, lock #4	9
42023		washer, lock 1/4" I.D.	1
42049		washer, flat 17/64 I.D. (min. phone jack)	1
43000		lug, ground #4	3
43006		lug, ground #6	1
44013		spacer, 29/64" long	1
46010		grommet, rubber 5/16 dia.	1
47005		spring	1
47502		large gear assembly	1
47503		bevel gear and drum assembly	1
47504		tuning knob assembly	1
57000		line cord	1
58004		wire, hook-up, thin wall	length
58300		spaghetti	length
58501		wire, bare	length
80041		panel	1
81158		chassis	1
81159		chassis "U" bracket	1
88024		cabinet	1
89605		window, plastic (mounted on panel)	1
89613		sleeve for #47 bulb	1
66076		manual of instruction (wired)	1
66330		manual of instruction (kit)	1

RESISTOR COLOR CODES

RMA COLOR CODE FOR
FIXED COMPOSITION RESISTORS

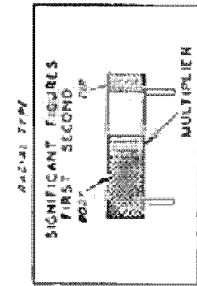
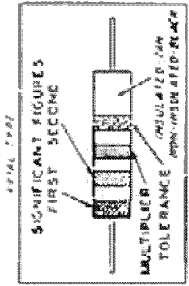

JAN COLOR CODE FOR
FIXED COMPOSITION RESISTORS

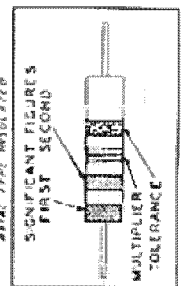

RMA COLOR CODE FOR
FIXED COMPOSITION RESISTORS

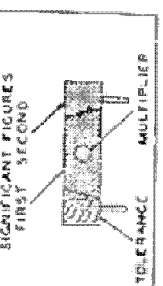

CAPACITOR COLOR CODES

PMA 3-DOT COLOR CODE FOR MICA DIELECTRIC CAPACITORS

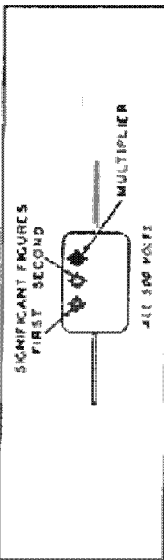

JAN 8-DOT COLOR CODE FOR PAPER DIELECTRIC CAPACITORS

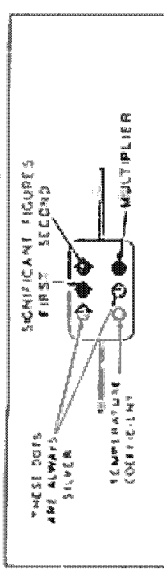

PMA 8-DOT COLOR CODE FOR MICA-DIELECTRIC CAPACITORS

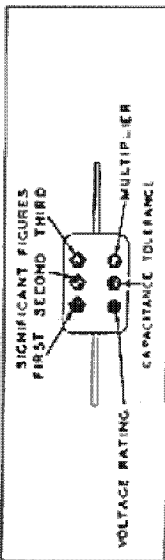

JAN 8-DOT COLOR CODE FOR MICA-DIELECTRIC CAPACITORS

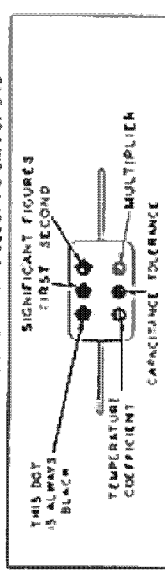

RMA COLOR CODE FOR TUBULAR
CERAMIC-DIELECTRIC CAPACITORS

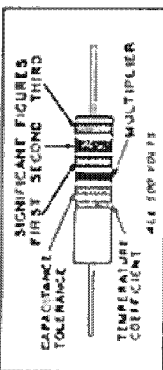

JAN COLOR CODE FOR FIXED CERAMIC-DIELECTRIC CAPACITORS

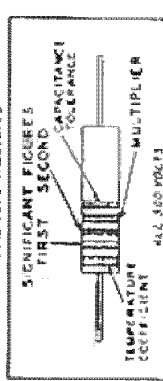

RMA RADIO MANUFACTURERS ASSOCIATION
JAN. JOINT ARMY-NAVY

RESISTORS		CAPACITORS			
TOLERANCE	MULTIPLIER	COLOR	RMA MICA AND CERAMIC-DIELECTRIC	JAN MICA AND PAPER DIELECTRIC	JAN CERAMIC DIELECTRIC
10	1	BLACK	10	10	A
10	10	BROWN	100	100	B
100	100	RED	1000	1000	C
1000	1000	ORANGE	10000	10000	D
10000	10000	YELLOW	100000	100000	E
100000	100000	GREEN	1000000	1000000	F
1000000	1000000	BLUE	10000000	10000000	G
10000000	10000000	VIOLET	100000000	100000000	
100000000	100000000	GRAY	1000000000	1000000000	
1000000000	1000000000	WHITE	0.1	0.1	
5	0.1	GOLD	0.01	0.01	
10	0.01	SILVER	0.01	0.01	
20		NO COLOR			

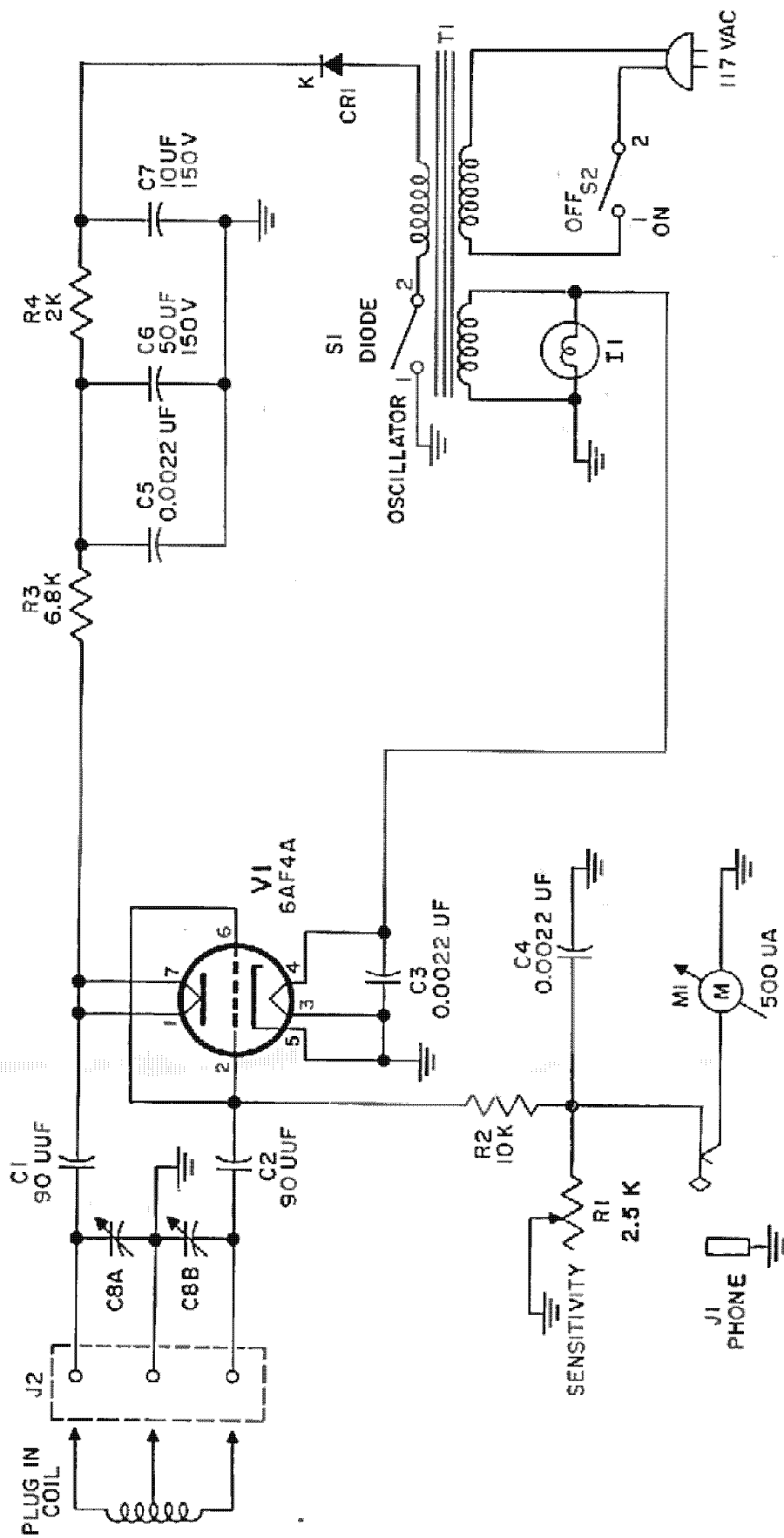

TRIGOL

MODEL 710 GRID DIP METER

TRIGOL