

ASSEMBLING
AND USING
YOUR.....

Heathkit

TUBE
CHECKER
MODEL IT-21

HEATH COMPANY

BENTON HARBOR,
MICHIGAN

THE WORLD'S *Finest* TEST EQUIPMENT IN KIT FORM

Assembly
and
Operation
of the



TUBE
CHECKER

MODEL IT-21



TABLE OF CONTENTS

Specifications.	2
Introduction.	3
Construction Notes.	6
Parts List.	7
Proper Soldering Techniques.	10
Step-By-Step Procedure.	11
Step-By-Step Assembly.	12
Testing.	29
Cabinet Installation.	29
Using Your Tube Checker.	30
In Case Of Difficulty.	32
Service Information.	32
Service.	32
Replacements.	34
Shipping Instructions.	34
Warranty.	34
Schematic.	35*

*Fold-out from page.

All prices are subject to change without notice. The Heath Company reserves the right to discontinue instruments and to change specifications at any time without incurring any obligation to incorporate new features in instruments previously sold.

SPECIFICATIONS

Tube Socket Accommodations	4 - pin. 5 - pin. 5 - pin Nuvistor. 6 - pin. 7 - pin combination and pilot lamp. 7 - pin miniature. 7 - pin Nuvistor. 8 - pin octal. 8 - pin loctal. 9 - pin miniature. 9 - pin Novar. 10- pin miniature. 12- pin Compactron.
Controls.	FILAMENT VOLTAGE SET LINE TYPE PLATE
Element Test Voltages.	30, 100, and 250 volts AC.
Filament Voltages.63, 1.4, 2, 2.35, 2.5, 3.15, 4.2, 4.7, 5, 6.3, 7.5, 9.45, 12.6, 19.6, 25, 32, 50, 70, and 110 volts AC.
Roll Chart Mechanism.	Constant tension, free rolling, thumbwheel oper- ated, illuminated.
Line Voltage Adjustment.	Step type.
Meter.	1 milliamperes full scale, BAD - ? - GOOD scale, illuminated.
Tests Available.	Emission, Short, Leakage, Open Element, and Filament continuity.
Power Requirements.	105-125 volts 50/60 cps AC.
Dimensions.	13" wide x 8-1/2" high x 5-1/2" deep.
Net Weight.	9 lbs.

INTRODUCTION

A vacuum tube possesses a number of operating characteristics, any one of which may be used to indicate, to a limited degree, the operational capabilities of the tube. Any number of tube testing devices are available, utilizing one or more of these characteristics, each one subject to its own limitations. It is universally recognized that no tube tester can provide a complete and accurate account of the condition existing within a given vacuum tube when that tube is in operation in the receiver. If maximum benefit is to be obtained from a tube tester, regardless of its design, two things should be known: (1) the requirements placed on the tube, and (2) the limitations of the tube tester. With this thought in mind, we have listed some of the more commonly used methods of tube testing.

EMISSION TESTING

Testing the emission capabilities of the cathode provides the simplest and most economical means of determining the overall quality of a vacuum tube. This is accomplished by connecting all the grids to the plate and operating the tube as a rectifier. The actual emission of the cathode is then compared to a predetermined value accepted as standard for that tube type. If the cathode should have one particularly active portion, the emission checker will indicate the quality of the tube to be good, even though the remainder of the cathode may be inactive. On the other hand, modern coated cathodes are capable of large emission, often far in excess of the emission required for the particular application. In some cases the emission checker will indicate the quality of the tube to be questionable or even unacceptable. This tube may not function in an application requiring a large emission but would probably operate satisfactorily for a long time in a circuit where the emission requirements are less.

TRANSCONDUCTANCE TESTING

A transconductance tester places a standard voltage on each tube element, creating a plate current flow. Measurement of this plate current will indicate the transconductance of that particular tube under static conditions. Here again, since the tube is not operating exactly as it does in the receiver, the test may be termed inconclusive. An improved version of the transconductance test is available in the dynamic transconductance tester.

DYNAMIC TRANSCONDUCTANCE TESTING

The dynamic transconductance of a tube is measured by using the circuit of the static transconductance tester and adding a signal generator. By applying a signal to the tube under test, the action of the plate current will be similar to that experienced in the receiver, varying in relationship to the input signal. Although this system gives an indication of how the tube will operate under signal conditions, it is still limited in scope. Certain types of tubes cannot be satisfactorily checked on any type of tester, even the dynamic transconductance tester. Particular offenders in this respect are tubes used in the vertical and horizontal deflection circuits of television receivers. The only method of accurately checking these tubes is by set testing.

SET TESTING

No tube tester is required in this system of tube testing; simply insert a new tube in the receiver and observe the results. At first glance this appears to be the most inexpensive testing system available. Bear in mind, however, that if all tubes were to be tested in this manner, a stock of tubes representing an investment of several hundred dollars is required.

POWER OUTPUT TESTING

This testing system is perhaps the most satisfactory in regards to similarity between test results and actual operation in the receiver. Since both the input and output powers are known, the other factors can be determined. In the case of voltage amplifiers the voltage amplification and output voltage will be of prime interest. The power output test is ideally suited to testing power amplifiers, where the output power is of major concern.

LOW LINE TEST

In this testing system the input voltage to the receiver is lowered to 105 volts. Sufficient time should be allowed (10 minutes) for the tube heaters to stabilize. If the questionable tube fails to function properly it should be replaced.

INSTRUMENT DESCRIPTION

In designing a tube checker, the designer is faced with the problem of deciding which of the

above mentioned testing procedures to follow. Points that must be considered are the cost, relative merits of each system, and the net value to the purchaser. On the basis of these and other considerations, the HEATHKIT Tube Checker has been designed around the emission testing circuit. There are several reasons for this decision, some of which are: (1) the emission checker will provide the best overall indication of tube quality when compared with other types on a cost per unit basis, (2) the transconductance of a tube is dependent upon cathode emission, (3) some busy servicemen do not wish to take the time necessary to check the tube thoroughly. They plug in the tube, push the button and observe the meter to check the emission; if the emission of the tube is too low for the intended service, determining any of the other characteristics is a waste of valuable time, (4) the emission testing circuit is relatively simple, requires few components, and lends itself well to kit-type construction, and (5) the low selling price made possible by the use of this circuit more than compensates for any inherent shortcomings it may possess. We sincerely believe the HEATHKIT Tube Checker will give the most test information per dollar invested.

The action of the instrument has been made quite flexible by the use of multiple filament voltages, adjustable cathode current, variable meter sensitivity and individual element switching. The thirteen lever switches make it possible to connect any element to any other element, regardless of the pin numbers involved.

The instrument may be used in darkened areas (such as the inevitable dark corner behind the TV receiver) with ease since both the roll chart and the meter are illuminated.

No difficulty should be experienced in roll chart operation on the part of the left-handed operator. Thumbwheel drive knobs have been provided on both sides of the panel to eliminate any "cross-over" problems. The roll chart mechanism is a unique design which permits the roll chart to run freely throughout its entire length without binding. The chart rollers are spring loaded to keep the chart taut at all times to present a smooth viewing surface.

TUBE TYPE ACCOMMODATIONS

The HEATHKIT Tube Checker was designed for

checking tubes encountered in everyday radio and TV service work, but is not specifically limited to these types. It will check satisfactorily any tube that can be accommodated in the tube sockets if the data provided by the tube manufacturer is available. Sockets provided are: 4-pin, 5-pin, 5-pin Nuvistor, 6-pin, 7-pin combination and pilot lamp, 7-pin miniature, 7-pin Nuvistor, 8-pin octal, 8-pin loctal, 9-pin Novar, 10-pin miniature, and 12-pin Compactron.

The 10-pin miniature socket is constructed so that it can also be used to check 9-pin miniature tubes.

ROLL CHART DATA

The roll chart contains necessary data for the checking of currently used tubes. Because of the constantly growing list of tubes it is impossible to list all the tubes on the chart. Many tubes not listed on the chart may be found in the roll chart supplement. Test data for newly released tube types is forwarded regularly to subscribers to the roll chart subscription service. This service is provided free to all purchasers of HEATHKIT Tube Checkers for the current calendar year.

FILAMENT VOLTAGES

Filament voltages used in the operation of the tube checker are derived from a secondary winding on the power transformer which is tapped to provide nineteen different voltages. These voltages are switch selected for convenience of operation and assure the application of the proper filament voltage for a given tube type under test.

TEST VOLTAGES

Voltages used in the various tests provided by the Tube Checker are derived from a secondary winding on the power transformer which is tapped at 30, 100, and 250 volts. During the operation of the Checker, three basic circuits are set up using these voltages.

LINE TEST CIRCUIT

The first basic circuit, Figure 1, is in use when the TEST switch is in the SHORT ADJUST position. The SET LINE switch in the primary of the power transformer varies the voltage across the primary, thus controlling the voltage across both secondary windings simultaneously. The

meter, with the voltage divider and rectifier network now in the circuit, will indicate the proper secondary voltage when the needle is within the LINE TEST block. The purpose of the SET LINE switch is to assure proper voltages on the tube under test, thus minimizing the possibility of an erroneous indication due to abnormally high or low power line voltages.

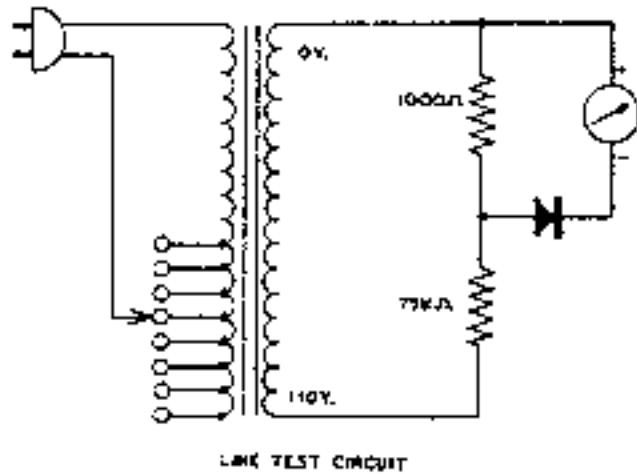

Figure 1

SHORT TEST CIRCUIT

The second basic circuit, Figure 2, is used in the short, leakage, and filament continuity tests. The 100 volt tap is connected to the neon short indicator and associated network and is in series with the plate of the tube under test. The meter is not in the circuit; the tests are indicated by the neon lamp. Moving the lever switches in the prescribed manner connects the tube elements in such a manner that a shorted element will cause considerable increased current flow through the resistor in parallel with the neon lamp. The voltage drop then produced reaches the operating voltage of the neon lamp causing it to glow, thus indicating a short. For the leakage test, the circuit remains unchanged in all respects except one: the value of the resistance in parallel with the neon lamp is increased, thus increasing the sensitivity of the test. The term "short" as used in this test should not be confused with the direct short formed by connecting two terminals with a piece of wire. The sensitivity rating of the short test is 250 KΩ, which means the lamp will glow if the resistance between the shorted elements is anywhere between the values of 0 and 250,000 ohms. The sensitivity rating of the leakage test (high-sensitivity short test) is 2 megohms which means that the lamp will glow if the resistance is anywhere between 0 and 2,000,000 ohms. Actually, this test may be altered to any desired sensitivity by replacing the 2.2 megohm

resistor with the required value. The short test is a very critical test and should be performed carefully and evaluated in terms of the amount of leakage which can be tolerated in the circuit.

Figure 2

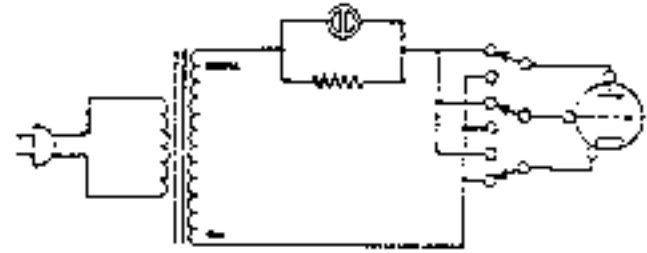

QUALITY TEST CIRCUIT

The third basic circuit, Figure 3, is used when making the quality and open element tests. The plate and grids are connected together to the 30 volt transformer tap. The filament and cathode are connected together to the 0 volt tap of the high voltage winding through the PLATE control. The PLATE control adjusts the sensitivity of the meter, which is in the circuit at this time. The tube now conducts as a half-wave rectifier, the total emission of the cathode being passed to a single terminal (anode) and out through the meter circuit.

A good tube, with the sensitivity of the meter properly adjusted, will have sufficient cathode emission to swing the meter needle into the GOOD section of the scale. If the emission is too low, the current through the tube will not be high enough to bring the needle into the GOOD section; it will remain in the (?) section or drop into the BAD section.

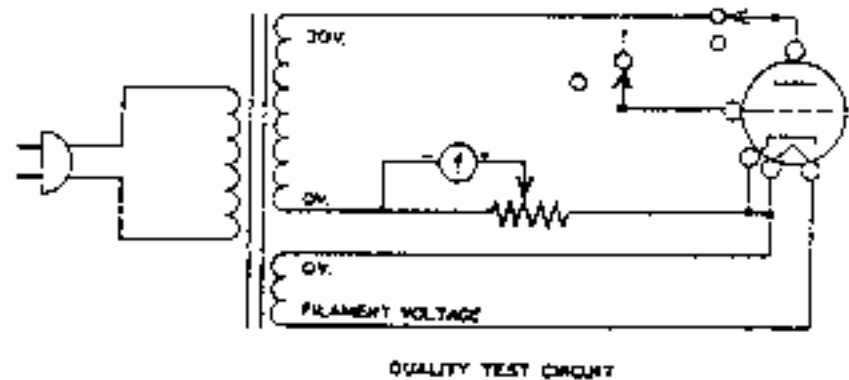

Figure 3

An open element may be detected in the following manner. Since all tube elements (except cathode) are connected to the plate terminal, the current indicated by the meter during the quality test represents the total current through the tube. Disconnecting an element from the plate terminal will cause the current through the tube to diminish. The meter reading will then be less than originally noted. Therefore, a drop in the meter reading indicates the ele-

ment is not open. If the element were open, disconnecting it from the plate terminal would make no change in the tube current, hence no change in the meter reading. For tubes with a number of grids, the operation is somewhat more complex, but the same theory applies in general. For gas tubes (OZ4, etc.) the 250 volt tap is used instead of the 30 volt tap. The rest

of the circuitry remains unchanged.

The TYPE switch places the appropriate resistance value in the plate circuit of the tube under test to limit the cathode-current. This switch also changes the meter sensitivity to obtain the proper meter deflection for this value of cathode current.

CONSTRUCTION NOTES

This manual is supplied to assist you in every way to complete your kit with the least possible chance for error. The arrangement shown is the result of extensive experimentation and trial. If followed carefully, the result will be highly stable and dependable performance. We suggest that you retain the manual in your files for future reference, both in the use of the equipment and for its maintenance.

UNPACK THE KIT CAREFULLY AND CHECK EACH PART AGAINST THE PARTS LIST. In so doing, you will become acquainted with the parts. Refer to the information on the inside covers of the manual to help you identify the components. If some shortage or parts damage is found in checking the Parts List, please read the Replacements section and supply the information called for therein.

Resistors generally have a tolerance rating of

10% unless otherwise stated in the Parts List. Tolerances on capacitors are generally even greater. Limits of +100% and -20% are common for electrolytic capacitors.

We suggest that you do the following before work is started:

1. Lay out all parts so that they are readily available.
2. Provide yourself with good quality tools. Basic tool requirements consist of a screwdriver with a 1/4" blade; a small screwdriver with a 1/8" blade; long-nose pliers; wire cutters, preferably separate diagonal cutters; a penknife or a tool for stripping insulation from wires; a soldering iron (or gun) and rosin core solder. A set of nut drivers and a nut starter, while not necessary, will aid extensively in construction of the kit.

Most kit builders find it helpful to separate the various parts into convenient categories. Muffin tins or molded egg cartons make convenient trays for small parts. Resistors and capacitors may be placed with their lead ends inserted in the edge of a piece of corrugated cardboard until they are needed. Values can be written on the cardboard next to each component. The illustration shows one method that may be used.

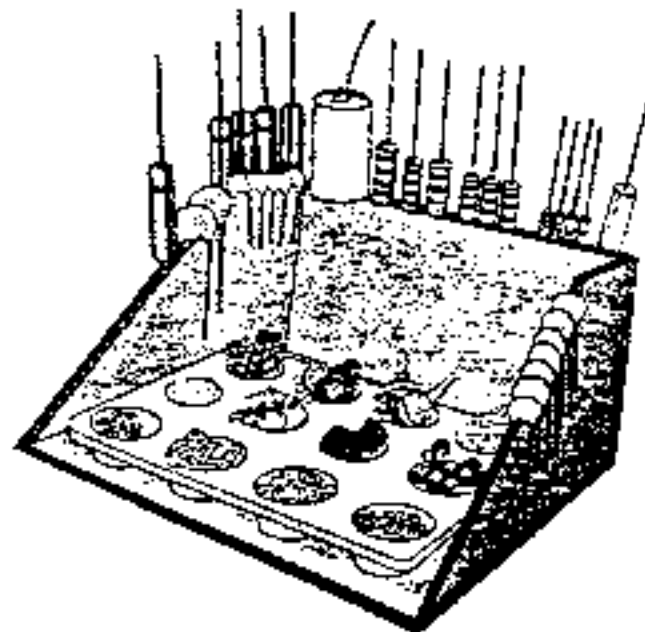

PARTS LIST

NOTE: The circled numbers in the Parts List are keyed to the circled numbers on the pictures of the parts to aid in parts identification.

PART No.	PARTS Per Kit	DESCRIPTION
----------	---------------	-------------

Resistors

1-5	1	360 Ω 1/2 watt (orange-blue-brown)
1-79	1	820 Ω 1/2 watt (gray-red-brown)
1-9	1	1000 Ω 1/2 watt (brown-black-red)
1-81	1	1500 Ω 1/2 watt (brown-green-red)
1-82	1	3600 Ω 1/2 watt (orange-blue-red)
1-26	1	100 K Ω 1/2 watt (brown-black-yellow)
1-30	1	270 K Ω 1/2 watt (red-violet-yellow)
1-37	1	2.2 megohm (red-red-green)
2A-21	1	75 K Ω 2% 1 watt
3E-1	1	2500 Ω 7 watt wire-wound

①



②



③



Controls-Capacitor-Switches

11-12	1	200 Ω control
2-11	1	.1 μ fd tubular capacitor
60-3	1	DPDT spring-return slide switch

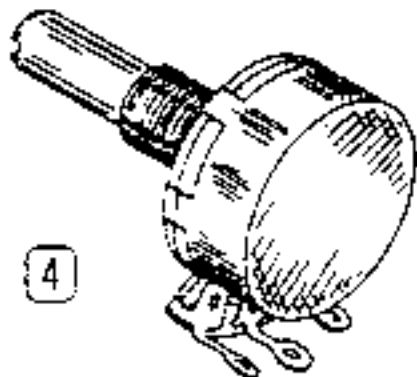

④

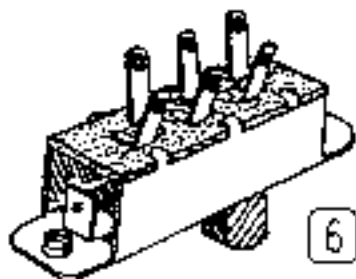

⑤

PART No.	PARTS Per Kit	DESCRIPTION
----------	---------------	-------------

Controls-Capacitors-Switches (cont'd.)

60-4	1	SPDT slide switch
62-21	1	13-gang 3-position lever switch
⑦ 63-17	1	2-pole 4-position rotary switch
63-167	1	20-position rotary switch
63-168	1	10-position rotary switch

⑦

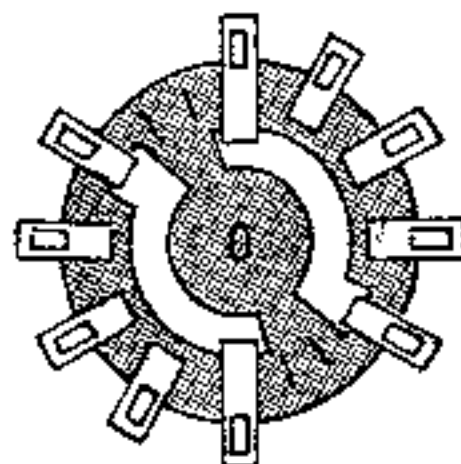

Lamps-Terminal Strips-Sockets-Knobs

412-1	2	#47 pilot lamp
⑧ 412-12	1	Neon lamp
⑨ 431-2	1	2-lug terminal strip
431-5	2	4-lug terminal strip
431-27	1	3-lug terminal strip
⑩ 434-4	1	Octal socket
⑪ 434-6	1	Loctal socket

⑧

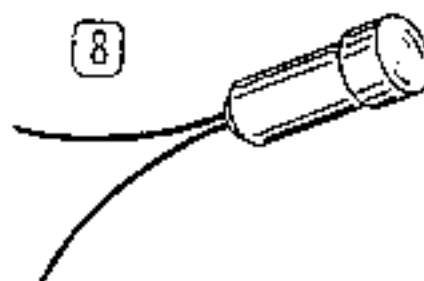

⑨



⑩

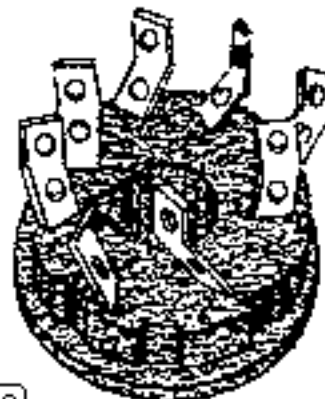

⑪





PART No.	PARTS Per Kit	DESCRIPTION
Lamps-Terminal Strips-Sockets-Knobs (cont'd.)		
434-9	1	4-pin socket
434-11	1	5-pin socket
434-12	1	6-pin socket
434-13	1	7-pin socket
434-14	1	7-pin miniature socket
434-120	1	9-pin Novar socket
434-121	1	12-pin Compactron socket
434-122	1	10-pin miniature socket
434-119	1	5-pin Nuvistor socket
434-139	1	7-pin Nuvistor socket
434-21	2	Pilot lamp socket
462-7	13	Lever switch knob
462-72	2	Thumbwheel knob
462-207	4	Large knob
463-27	2	Snap-on pointer

PART No.	PARTS Per Kit	DESCRIPTION
Grommets-Wire-Clamp		
73-2	5	3/4" rubber grommet
73-3	4	1/2" rubber grommet
75-24	1	Line cord bushing
89-1	1	Line cord
134-47	1	Selector switch wiring harness
134-48	1	Switch-meter wiring harness
207-3	1	1/8" plastic cable clamp
340-2	1	Length bare wire
341-1	1	Length black test lead
344-50	1	Black hookup wire
344-51	1	Brown hookup wire
344-52	1	Red hookup wire
344-53	1	Orange hookup wire
344-54	1	Yellow hookup wire
344-55	1	Green hookup wire
344-56	1	Blue hookup wire
344-57	1	Violet hookup wire
344-58	1	Gray hookup wire
344-59	1	White hookup wire

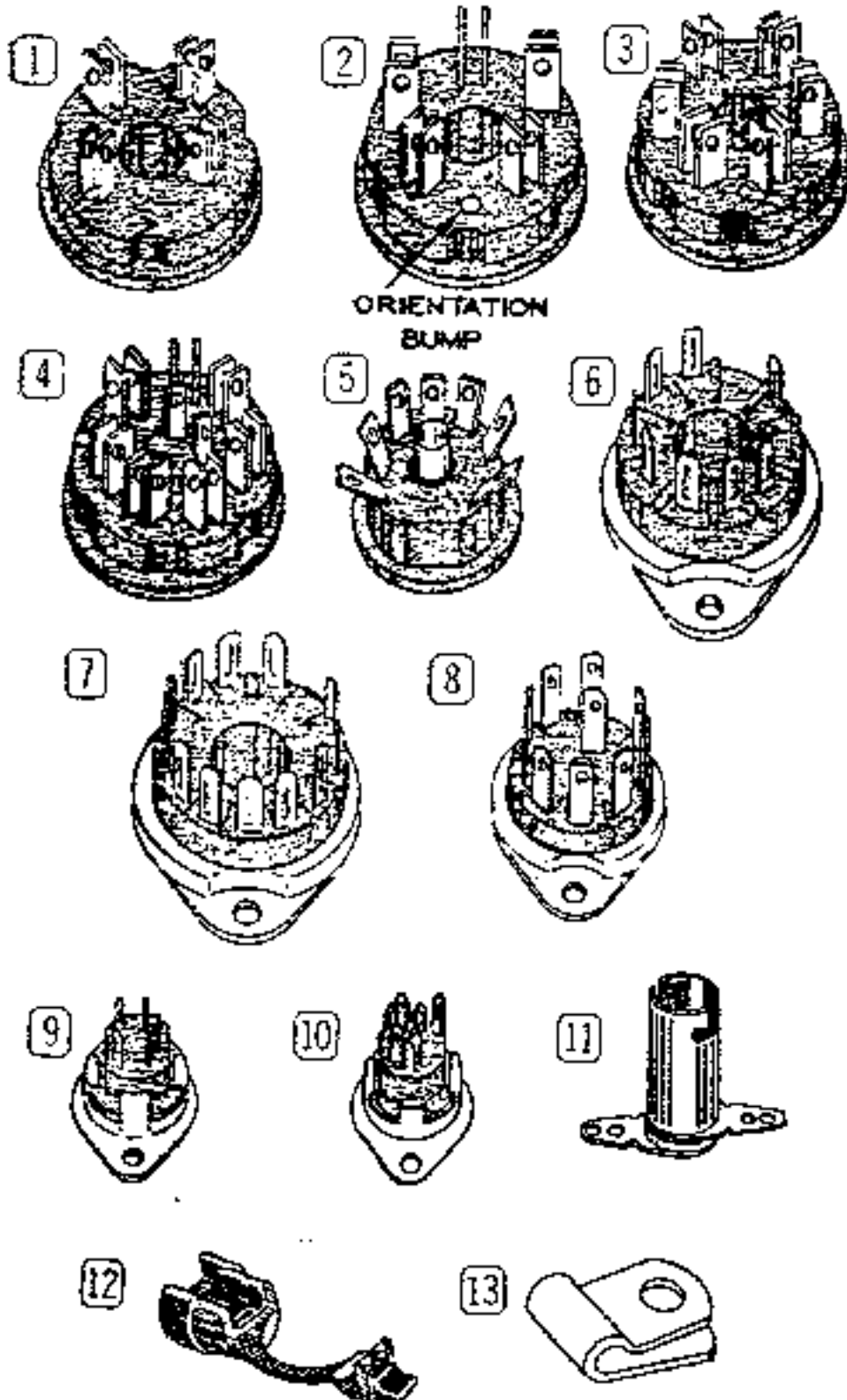

Hardware		
250-83	2	#10 x 1/2" sheet metal screw
250-43	2	8-32 x 1/4" setscrew
250-18	4	8-32 x 3/8" screw
250-15	5	8-32 x 1/8" setscrew
250-56	28	6-32 x 1/4" screw
250-89	6	6-32 x 3/8" screw
250-52	4	4-40 x 1/4" screw
250-49	6	3-48 x 1/4" screw

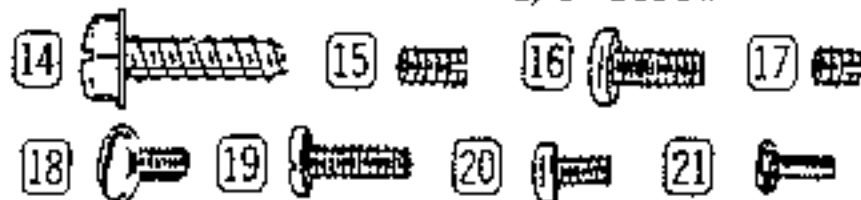

252-1	6	3-48 nut
252-3	29	6-32 nut
252-4	4	8-32 nut
252-7	4	Control nut
252-22	2	6-32 speednut
252-9	1	Push-on speednut
253-9	4	#8 flat washer
253-10	4	Control flat washer

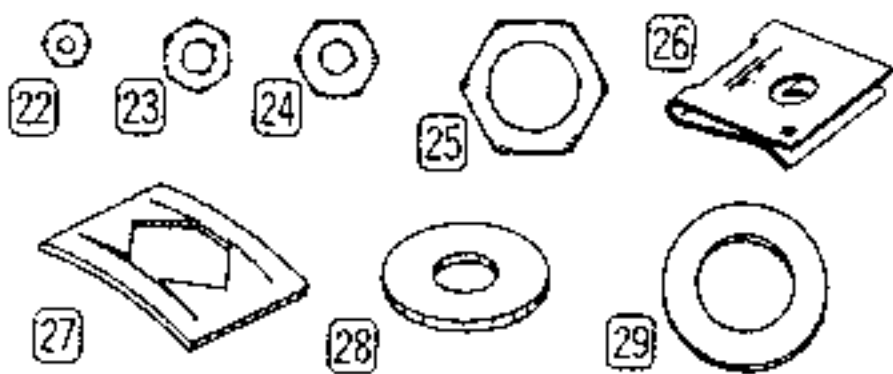

PART PARTS DESCRIPTION
No. Per Kit

PART PARTS DESCRIPTION
No. Per Kit

Hardware (cont'd.)

Miscellaneous

1	254-7	6	#3 lockwasher
2	254-1	31	#6 lockwasher
3	254-2	4	#8 lockwasher
4	254-5	4	Control lockwasher
5	259-1	2	#6 solder lug
6	253-36	4	Formed spring brass washer
7	258-4	2	Coil spring
8	435-1	5	Socket mounting ring
9	435-2	1	Miniature socket mounting ring
10	435-3	1	Large socket mounting ring

11	54-72	1	Power transformer
12	57-6	1	Half-wave rectifier
13	100-208	1	Drive roller
14	100-210	1	Take-up roller
15	211-15	1	Handle
16	260-3	1	Grid clip
17	261-4	8	Rubber feet
18	407-53	1	0-1 ma meter
19	445-7	1	Roll chart
20	74-6	1	Masking tape
21	451-17	2	Nylon idler gear
22	453-48	1	Roll chart idler shaft
23	455-15	5	1/4" retaining ring
24	331-6	1	Solder
25	391-34	1	Blue and white label
26	595-537	1	Manual

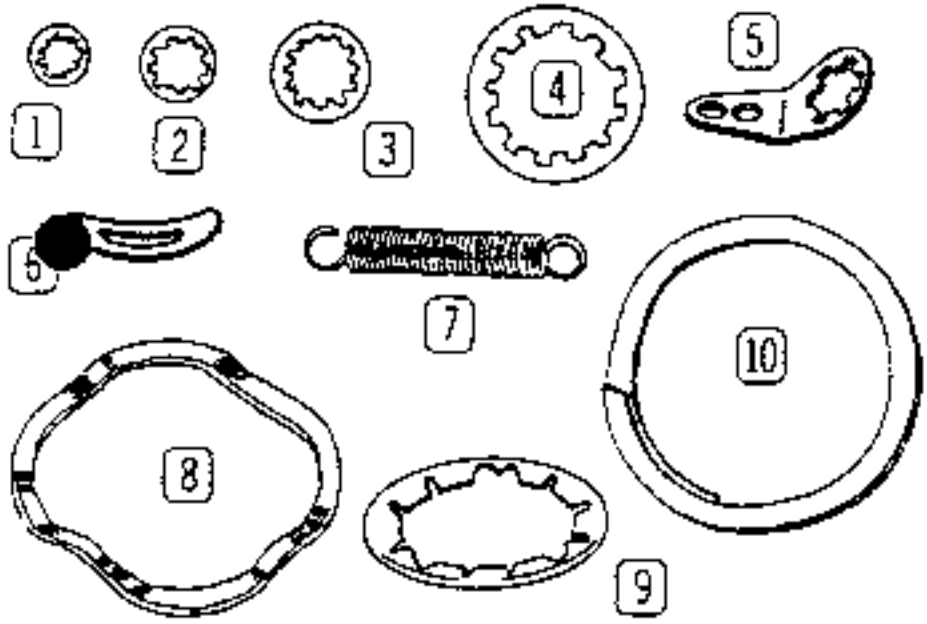

Metal Parts

90-220	1	Cabinet
100-M157	1	Pilot lamp bracket assembly
100-M378	1	Escutcheon
200-M347	1	Chassis
203-307F704-705-706	1	Front panel
204-M190	2	Takeup roller bracket
204-M480	2	Panel support bracket
204-M481	1	Right-hand roll chart bracket
204-M482	1	Left-hand roll chart bracket
205-M100	1	Meter mounting plate

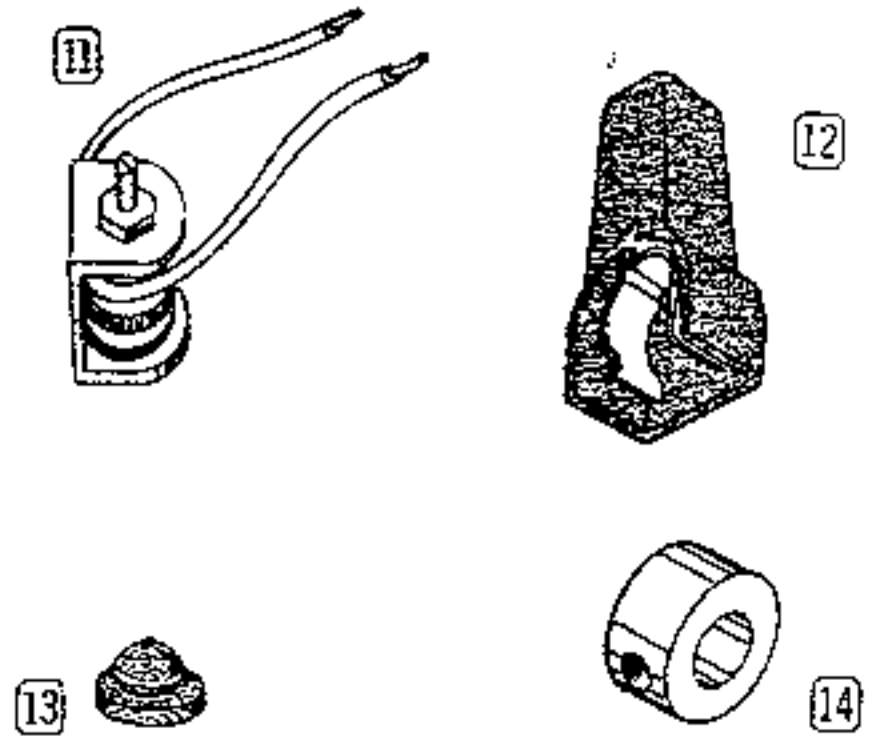

PROPER SOLDERING TECHNIQUES

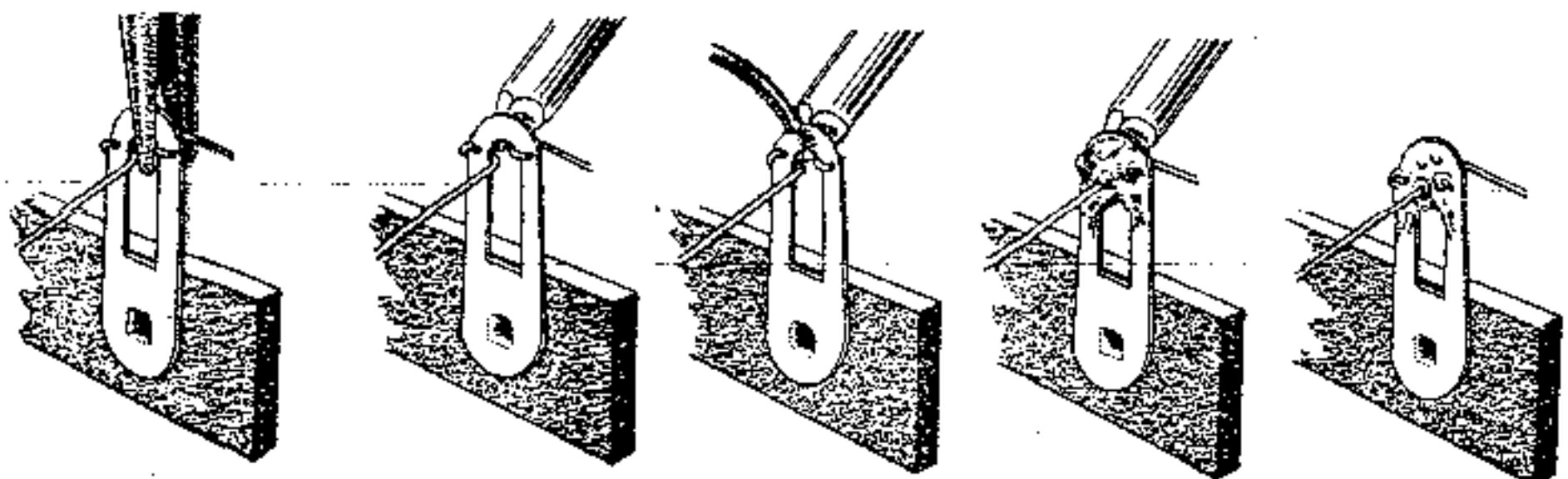

CRIMP WIRES HEAT CONNECTION APPLY SOLDER ALLOW SOLDER TO FLOW PROPER SOLDER CONNECTION

Only a small percentage of customers find it necessary to return equipment for factory service. By far the largest portion of malfunctions in this equipment are due to poor or improper soldering.

If terminals are bright and clean and free of wax, frayed insulation and other foreign substances, no difficulty will be experienced in soldering. Correctly soldered connections are essential if the performance engineered into a kit is to be fully realized. If you are a beginner with no experience in soldering, a half hour's practice with some odd lengths of wire may be a worthwhile investment.

For most wiring, a 25 to 100 watt iron or its equivalent in a soldering gun is very satisfactory. A lower wattage iron than this may not heat the connection enough to flow the solder smoothly. Keep the iron tip clean by wiping it from time to time with a cloth.

CHASSIS WIRING AND SOLDERING

1. Unless otherwise indicated, all wire used is the type with colored insulation (hookup wire). In preparing a length of hookup wire, 1/4" of insulation should be removed from each end unless directed otherwise in the assembly step.
2. To avoid breaking internal connections when stripping insulation from the leads of transformers or similar components, care should be taken not to pull directly on the lead. Instead, hold the lead with pliers while it is being stripped.

3. Leads on resistors, capacitors, and similar components are generally much longer than need be to make the required connections. In these cases, the leads should be cut to proper length before the part is installed. In general, the leads should be just long enough to reach their terminating points.

4. Crimp or bend the lead (or leads) around the terminal to form a good joint without relying on solder for physical strength. If the lead is too large to allow bending or if the step states that it is not to be crimped, position it so that a good solder connection can still be made.

5. Position the work, if possible, so that gravity will help to keep the solder where you want it.

6. Place a flat side of the soldering iron tip against the joint to be soldered until it is heated sufficiently to melt the solder.

7. Then place the solder and it will immediately flow over the joint; use only enough solder to thoroughly wet the junction. It is usually not necessary to fill the entire hole in the terminal with solder.

8. Remove the solder and then the iron from the completed joint. Use care not to move the leads until the solder is solidified.

A poor or cold solder joint will usually look crystalline and have a grainy texture, or the solder will stand up in a blob and will not have adhered to the joint. Such joints should be re-

heated until the solder flows smoothly. In some cases, it may be necessary to add a

little more solder to achieve a smooth, bright appearance.

ROSIN CORE SOLDER HAS BEEN SUPPLIED WITH THIS KIT. THIS TYPE OF SOLDER MUST BE USED FOR ALL SOLDERING IN THIS KIT. ALL GUARANTEES ARE VOIDED AND WE WILL NOT REPAIR OR SERVICE EQUIPMENT IN WHICH ACID CORE SOLDER OR PASTE FLUXES HAVE BEEN USED. IF ADDITIONAL SOLDER IS NEEDED, BE SURE TO PURCHASE ROSIN CORE (60:40 or 50:50 TIN-LEAD CONTENT) RADIO TYPE SOLDER.

STEP-BY-STEP PROCEDURE

The following instructions are presented in a logical step-by-step sequence to enable you to complete your kit with the least possible confusion. Be sure to read each step all the way through before beginning the specified operation. Also read several steps ahead of the actual step being performed. This will familiarize you with the relationship of the subsequent operations. When the step is completed, check it off in the space provided. This is particularly important as it may prevent errors or omissions, especially if your work is interrupted. Some kit builders have also found it helpful to mark each wire and part in colored pencil on the Pictorial as it is added.

The fold-out diagrams in this manual may be removed and attached to the wall above your working area; but because they are an integral part of the instructions, they should be returned to the manual after the kit is completed.

In general, the illustrations in this manual correspond to the actual configuration of the kit; however, in some instances the illustra-

tions may be slightly distorted to facilitate clearly showing all of the parts.

The abbreviation "NS" indicates that a connection should not be soldered yet as other wires will be added. When the last wire is installed, the terminal should be soldered and the abbreviation "S" is used to indicate this. Note that a number will appear after each solder instruction. This number indicates the number of leads that are supposed to be connected to the terminal in point before it is soldered. For example, if the instruction reads, "Connect a wire to lug 1 (S-2)," it will be understood that there will be two wires connected to the terminal at the time it is soldered. (In cases where a wire passes through a terminal or lug and then connects to another point, it will count as two wires, one entering and one leaving the terminal.)

The steps directing the installation of resistors include color codes to help identify the parts. Also, if a part is identified by a letter-number designation (R1, C1, etc.) on the Schematic, its designation will appear at the beginning of the assembly step which directs its installation.

STEP-BY-STEP ASSEMBLY

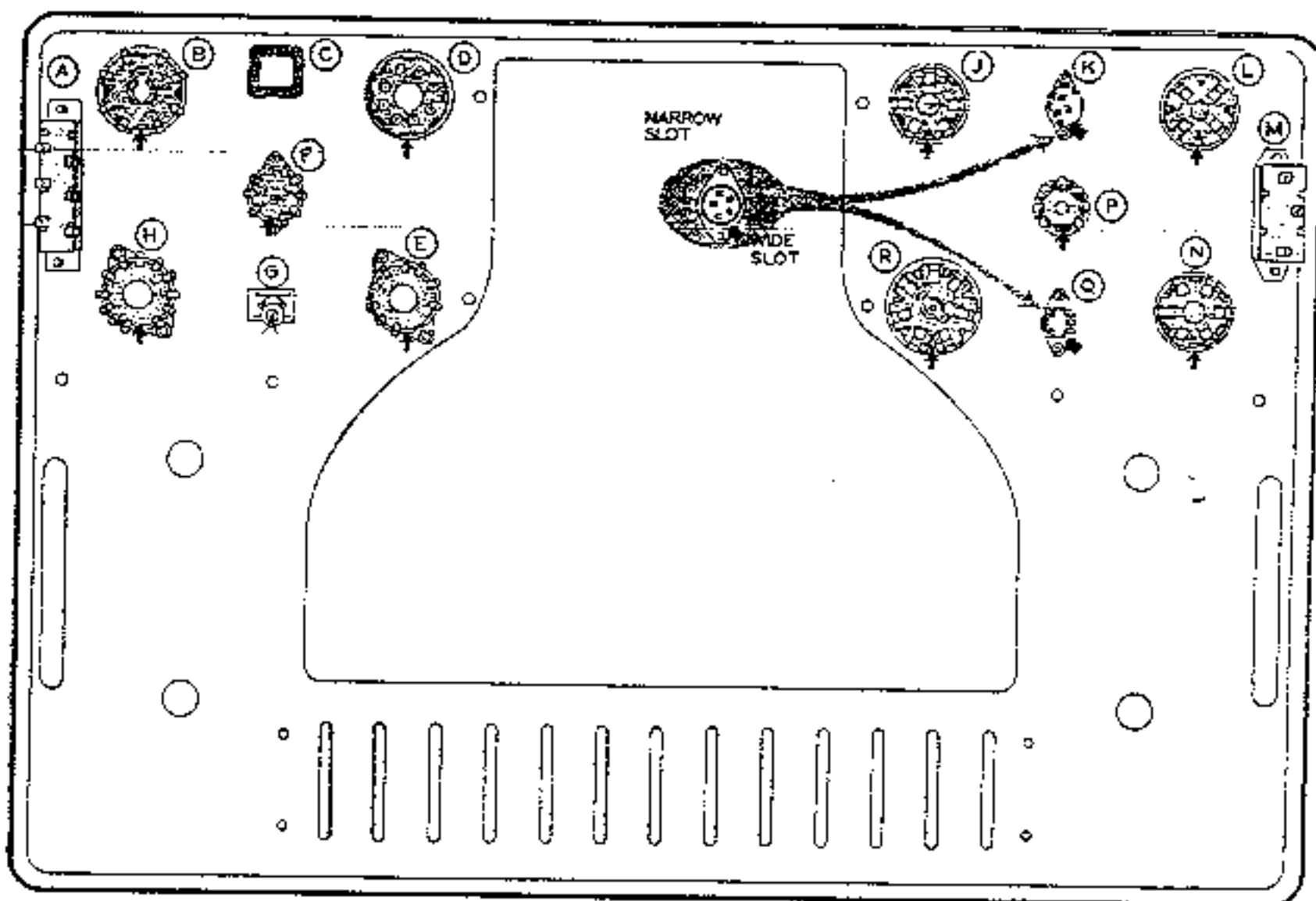

Pictorial 1

Refer to Pictorial 1 for the following steps.

- () To prevent scratching the front panel finish, place a cloth over the work area. Place the front panel on your work area as shown.
- () Referring to Detail 1A, mount the octal tube socket at location B. Secure the socket with a socket mounting ring as shown. Be sure to position the keyway as shown by the arrow in Pictorial 1.

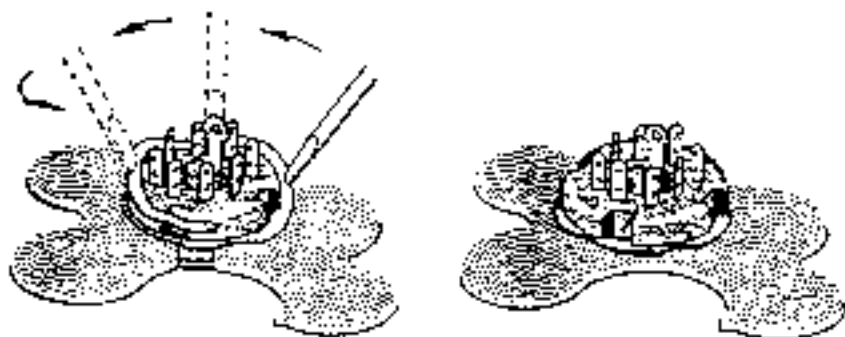

HOLD THE SOCKET IN THE CHASSIS HOLE AND PLACE ONE END OF THE RING INTO THE GROOVE OF THE SOCKET. USING A SCREWDRIVER, PRESS THE RING INTO THE GROOVE AROUND THE SOCKET.

Detail 1A

- () Mount the octal tube socket at location D. Secure the socket with a socket mounting ring. Position the keyway as shown by the arrow in Pictorial 1.
- () Referring to Detail 1B, mount the 12-pin Compactron tube socket at location H. Secure the socket with 6-32 x 1/4" screws, #6 lockwashers, and 6-32 nuts. Position the blank space as shown by the arrow in Pictorial 1.
- () Mount the 9-pin Novar tube socket at location E. Use 6-32 x 1/4" screws, #6 lockwashers, and 6-32 nuts. Position the blank space as shown.
- () Mount the 10-pin miniature tube socket at location F. Use 3-48 x 1/4" screws, #3 lockwashers, and 3-48 nuts. Position the blank space as shown.

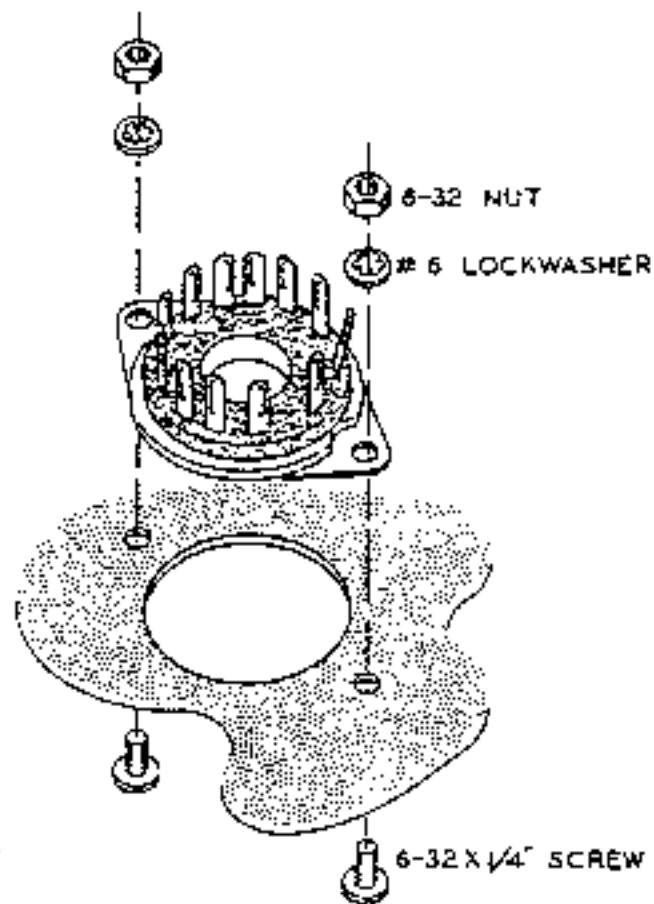

Detail 1B

- () Insert a 3/4" rubber grommet at location C. Work this grommet into the hole until it becomes a square.
- () Mount the DPDT spring-return slide switch at location A. When mounting this switch, position it so that the slide button is normally in the SHORT ADJUST LINE position (see the front of the panel). Use 6-32 x 1/4" screws to secure the switch.
- () Referring to Detail 1C, mount the neon lamp at location G. Use the large push-on speednut.

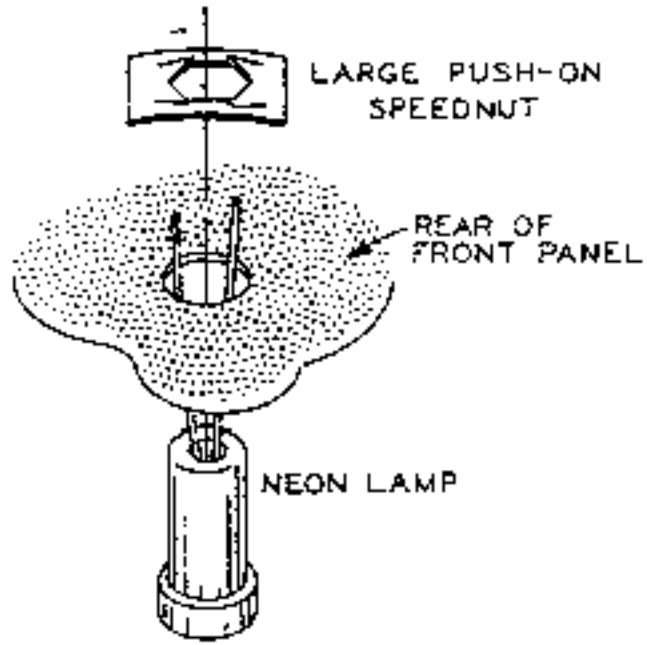

Detail 1C

- () Mount the 7-pin miniature tube socket at location P. Use the miniature socket mounting ring. See Detail 1D. Position the blank space as shown by the arrow in Pictorial 1.

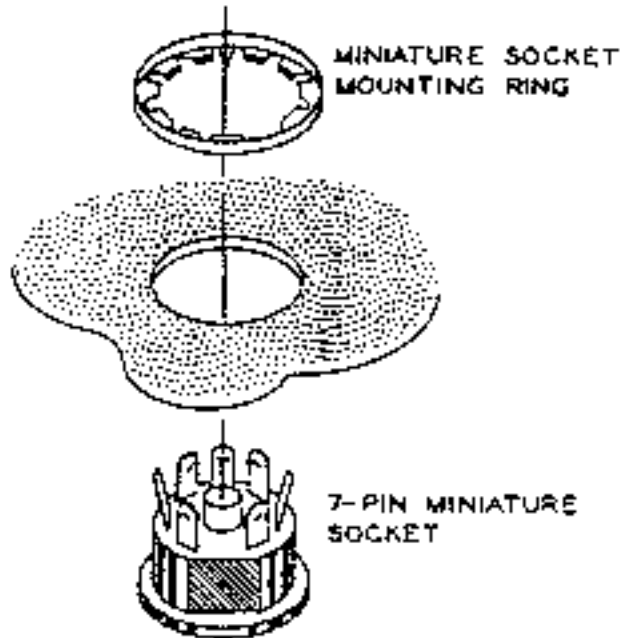

Detail 1D

- () Mount the 5-pin tube socket at location J. Use a socket mounting ring. Position the orientation bump (see Parts Pictorial) of the socket as shown by the arrow in Pictorial 1.
- () Mount the 4-pin tube socket at location L. Use a socket mounting ring. Position the orientation bump as shown.
- () Mount the 6-pin tube socket at location N. Use a socket mounting ring. Position the orientation bump as shown.
- () Mount the combination pilot lamp testing socket and 7-pin tube socket at location R. Use the large socket mounting ring. Position the orientation bump as shown.
- () Mount the 7-pin Nuvistor tube socket at location K. Use 3-48 x 1/4" screws, #3 lockwashers, and 3-48 nuts. Be sure to position the orientation slots as shown by the arrows in Pictorial 1.
- () Mount the 5-pin Nuvistor tube socket at location Q. Use 3-48 x 1/4" screws, #3 lockwashers, and 3-48 nuts. Position the orientation slots as shown by the arrows in Pictorial 1.
- () Mount the SPDT slide switch (#60-4) at location M. Use 6-32 x 1/4" screws. Position the switch lugs as shown.



Refer to Pictorial 2 for the following steps.

The following steps concern the connection of wires to the tube sockets on the front panel. Cut each color of hookup wire to length as

directed and strip 1/4" of insulation from each end of the wire. Each socket will be referred to by its location letter. The photograph of the completed kit on Page 36 can be used as a general reference for wire placement.

<u>COLOR</u>	<u>LENGTH</u>	<u>FROM</u>	<u>TO</u>
() Brown	2"	lug 1 of B (S-1)	lug 1 of F (NS).
() Brown	3"	lug 1 of F (NS)	lug 1 of D (S-1).
() Brown	3-1/4"	lug 1 of F (NS)	lug 1 of H (NS).
() Brown	2-3/4"	lug 1 of F (S-4)	lug 1 of E (S-1).
() Red	2-1/4"	lug 2 of B (S-1)	lug 2 of F (NS).
() Red	3-1/2"	lug 2 of F (NS)	lug 2 of H (NS).
() Red	2-1/2"	lug 2 of F (NS)	lug 2 of E (S-1).
() Red	2-1/2"	lug 2 of F (S-4)	lug 2 of D (S-1).
() Yellow	2-1/2"	lug 4 of B (S-1)	lug 4 of F (NS).
() Yellow	2-1/2"	lug 4 of F (NS)	lug 4 of D (S-1).
() Yellow	2-3/4"	lug 4 of F (NS)	lug 4 of E (S-1).
() Yellow	3-1/4"	lug 4 of F (S-4)	lug 4 of H (NS).

Refer to Pictorial 3 for the following steps.

<u>COLOR</u>	<u>LENGTH</u>	<u>FROM</u>	<u>TO</u>
() Orange	3-1/4"	lug 3 of B (S-1)	lug 3 of F (NS).
() Orange	2-1/4"	lug 3 of F (NS)	lug 3 of D (S-1).
() Orange	2-3/4"	lug 3 of F (NS)	lug 3 of E (S-1).
() Orange	3-1/4"	lug 3 of F (S-4)	lug 3 of H (NS).
() Green	2-1/4"	lug 5 of B (S-1)	lug 5 of F (NS).
() Green	2-3/4"	lug 5 of F (NS)	lug 5 of D (S-1).
() Green	1-3/4"	lug 5 of F (NS)	lug 5 of E (S-1).
() Green	2-3/4"	lug 5 of F (S-4)	lug 5 of H (NS).

<u>COLOR</u>	<u>LENGTH</u>	<u>FROM</u>	<u>TO</u>
() Blue	1-3/4"	lug 6 of B (S-1)	lug 6 of F (NS).
() Blue	3-1/4"	lug 6 of F (NS)	lug 6 of D (S-1).
() Blue	1-3/4"	lug 6 of F (NS)	lug 6 of E (S-1).
() Blue	3"	lug 6 of F (S-4)	lug 6 of H (NS).
() Violet	3-1/4"	lug 7 of B (S-1)	lug 7 of F (NS).
() Violet	2-3/4"	lug 7 of F (NS)	lug 7 of D (S-1).
() Violet	2"	lug 7 of F (NS)	lug 7 of E (S-1).
() Violet	2-3/4"	lug 7 of F (S-4)	lug 7 of H (NS).
() Gray	2-1/2"	lug 8 of B (S-1)	lug 8 of F (NS).
() Gray	2-1/2"	lug 8 of F (NS)	lug 8 of D (S-1).
() Gray	2-1/2"	lug 8 of F (NS)	lug 8 of E (S-1).
() Gray	2-1/4"	lug 8 of F (S-4)	lug 8 of H (NS).
() White	3"	lug 9 of F (NS)	lug 9 of E (S-1).
() White	1-1/2"	lug 9 of F (S-2)	lug 9 of H (NS).
() Black	1-1/4"	lug 10 of F (S-1)	lug 10 of H (NS).

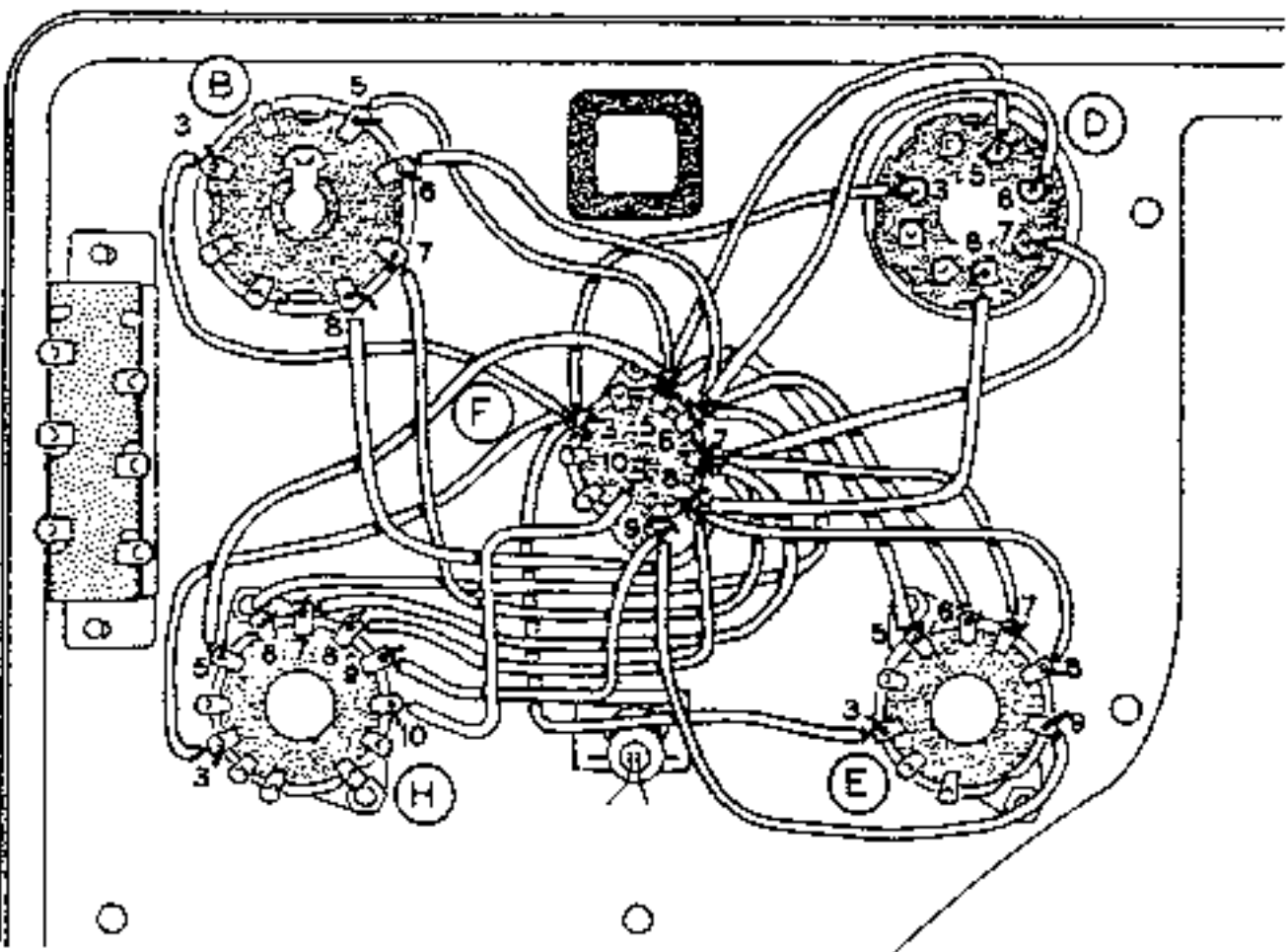

Pictorial 3



Refer to Pictorial 4 for the following steps.

<u>COLOR</u>	<u>LENGTH</u>	<u>FROM</u>	<u>TO</u>
() Brown	3"	lug 1 of J (S-1).	lug 1 of R (NS).
() Brown	2-3/4"	lug 1 of R (NS)	lug 1 of P (NS).
() Brown	2"	lug 1 of P (NS)	lug 1 of K (S-1).
() Brown	2-1/4"	lug 1 of P (S-3)	lug 1 of N (NS).
() Brown	3"	lug 1 of N (S-2)	lug 1 of L (S-1).
() Red	3"	lug 2 of J (NS)	lug 2 of R (NS).
() Red	3"	lug 2 of J (S-2)	lug 2 of K (S-1).
() Red	3-1/4"	lug 2 of R (NS)	lug 2 of P (NS).
() Red	2-1/2"	lug 2 of P (NS)	lug 2 of N (NS).
() Red	1-3/4"	lug 2 of P (S-3)	lug 2 of Q (S-1).
() Red	2-3/4"	lug 2 of N (S-2)	lug 2 of L (S-1).
() Red	2-3/4"	lug 12 of Q (NS)	lug 12 of K (S-1).
() Yellow	2-1/2"	lug 4 of J (S-1)	lug 4 of R (NS).
() Yellow	2"	lug 4 of R (NS)	lug 4 of P (NS).
() Yellow	2-1/2"	lug 4 of P (NS)	lug 4 of Q (S-1).
() Yellow	3-1/2"	lug 4 of P (NS)	lug 4 of N (NS).
() Yellow	1-1/4"	lug 4 of P (S-4)	lug 4 of K (S-1).
() Yellow	2"	lug 4 of N (S-2)	lug 4 of L (S-1).
() Blue	2"	lug 6 of K (S-1)	lug 6 of P (NS).
() Blue	3-1/2"	lug 6 of P (NS)	lug 6 of N (S-1).
() Blue	2"	lug 6 of P (S-3)	lug 6 of R (NS).

Refer to Pictorial 5 for the following steps.

<u>COLOR</u>	<u>LENGTH</u>	<u>FROM</u>	<u>TO</u>
() Orange	3"	lug 3 of J (S-1)	lug 3 of R (NS).
() Orange	2-1/2"	lug 3 of R (NS)	lug 3 of P (NS).
() Orange	2-3/4"	lug 3 of P (S-2)	lug 3 of N (NS).
() Orange	3"	lug 3 of N (S-2)	lug 3 of L (S-1).
() Green	2"	lug 5 of J (S-1)	lug 5 of R (NS).
() Green	2-1/2"	lug 5 of R (NS)	lug 5 of P (NS).
() Green	3"	lug 5 of P (S-2)	lug 5 of N (S-1).
() Violet	2"	lug 7 of P (NS)	lug 7 of K (S-1).
() Violet	2-1/2"	lug 7 of P (S-2)	lug 7 of R (NS).
() Black	3"	lug 10 of Q (NS)	lug 10 of K (S-1).

() R3. Connect a 2.2 megohm (red-red-green) 1/2 watt resistor between lugs 1 (NS) and 3 (S-1) of switch M.

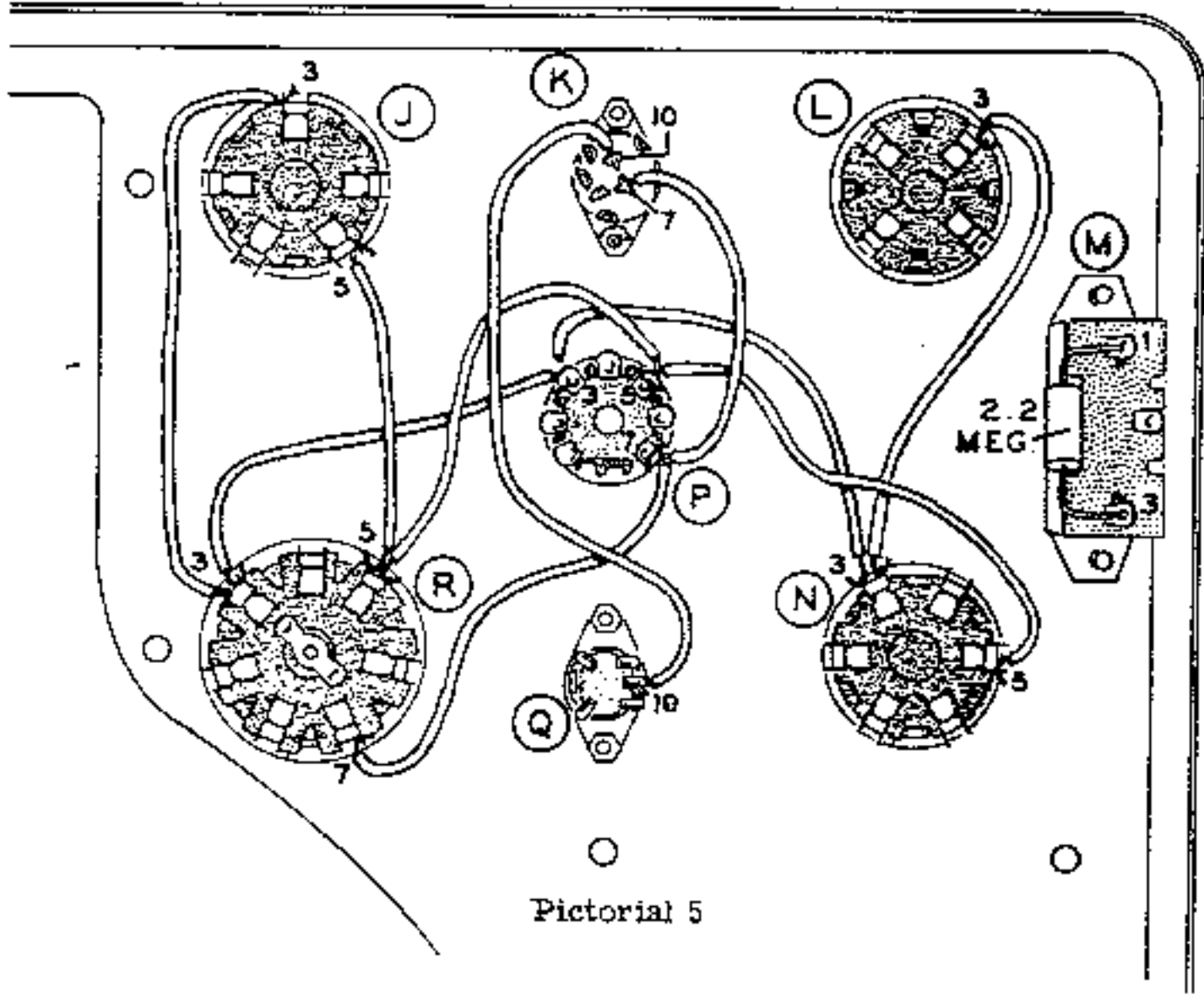

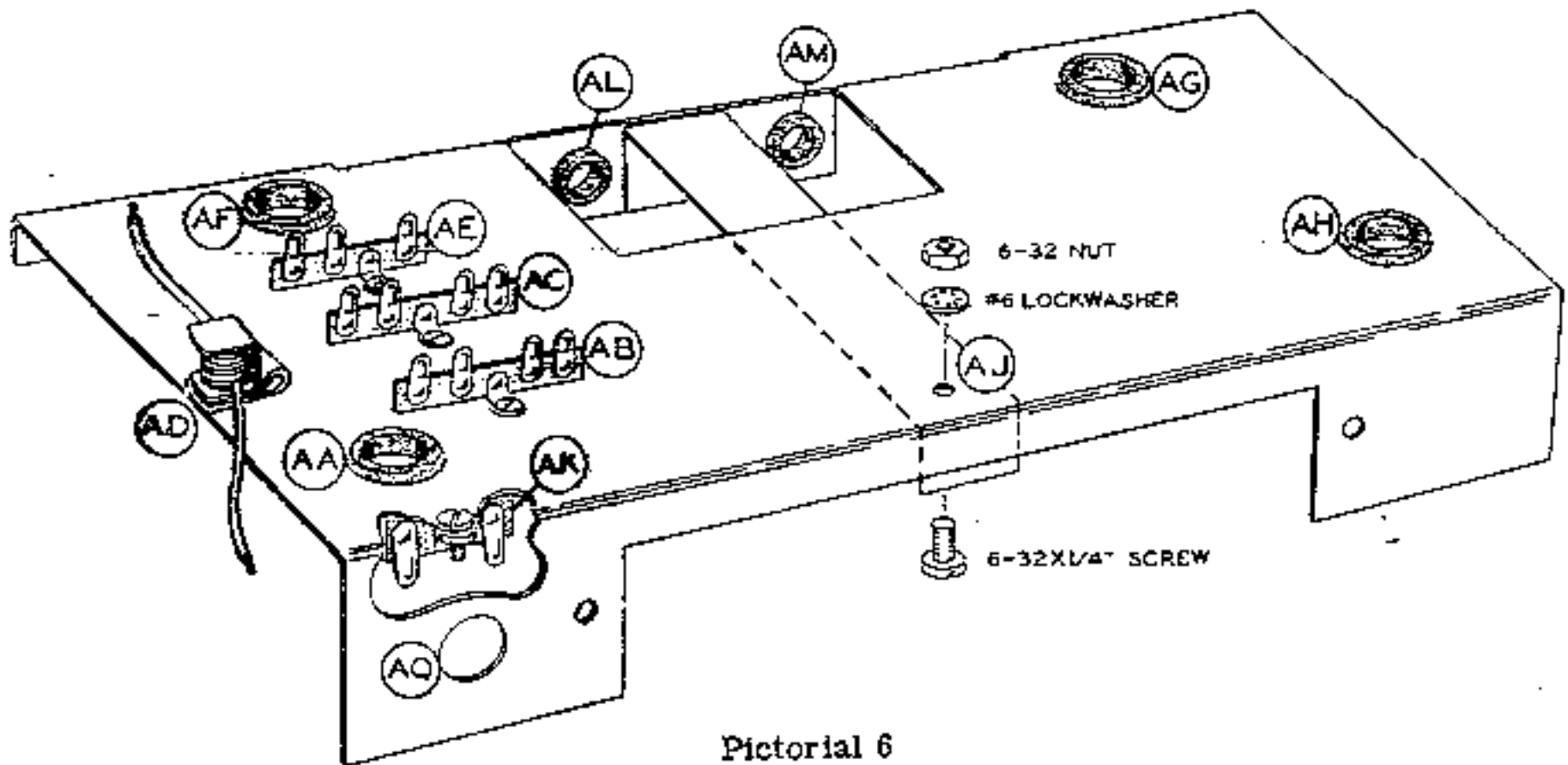

Pictorial 6

Refer to Pictorial 6 for the following steps.

- () Position the chassis as shown in Pictorial 6.
- () Referring to Detail 6A, mount 4-lug terminal strips at locations AB and AC. Use 6-32 x 1/4" screws, #6 lockwashers, and 6-32 nuts.
- () Temporarily mount the half-wave rectifier and the 1/8" plastic cable clamp at location AD. Use a #6 lockwasher and a 6-32 nut below the chassis. Position as shown.
- () Insert 3/4" rubber grommets in holes AA, AF, AG, and AH.
- () Locate the panel lamp bracket and insert 1/2" rubber grommets at locations AL and AM.
- () Mount the panel lamp bracket on the bottom of the main chassis. Secure the bracket with a 6-32 x 1/4" screw, #6 lockwasher, and a 6-32 nut at AJ.

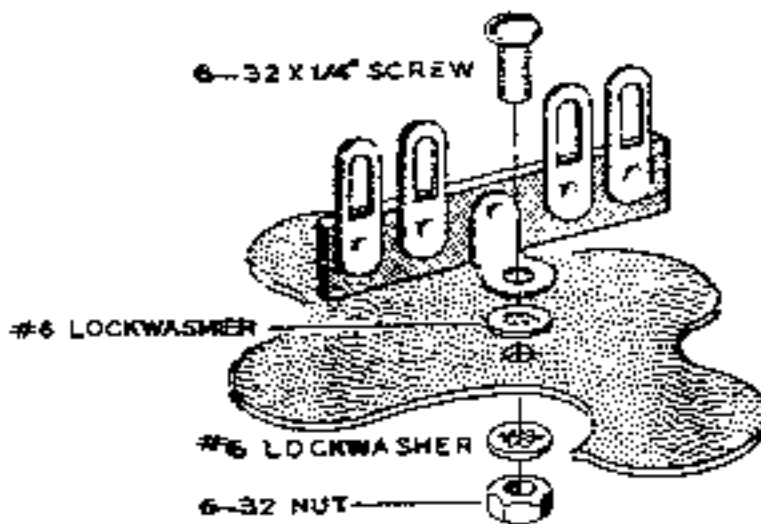

Detail 6A

Set the chassis aside until called for later.
Refer to Pictorial 7 for the following steps.

- () Mount a 3-lug terminal strip at location AE. Use a 6-32 x 1/4" screw, #6 lockwashers, and 6-32 nut.
- () Mount a 2-lug terminal strip at location AK under the chassis. Use a 6-32 x 1/4" screw, #6 lockwashers, and a 6-32 nut.
- () Carefully remove the meter from its box and remove the spring shorting bar from between the meter terminals.
- () Referring to Detail 7A, mount the meter to the meter mounting plate. Use the nuts supplied with the meter. The lockwashers are not used. Do not overtighten the meter mounting hardware or you may damage the meter case.

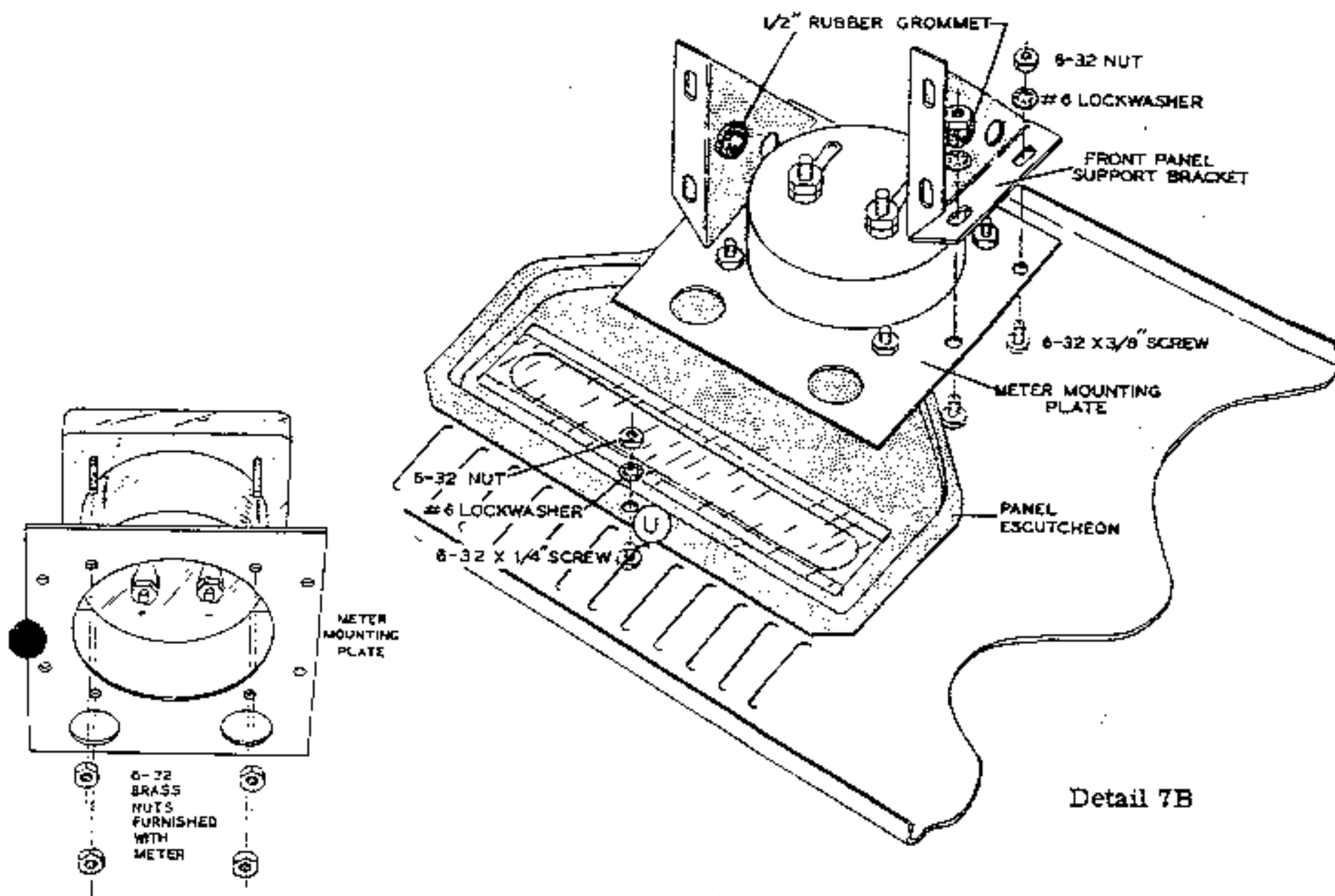

Detail 7A

Detail 7B

- () Place the escutcheon into the panel from the rear as shown in Detail 7B. Secure the edge of the escutcheon at location U with a 6-32 x 1/4" screw, #6 lockwasher, and a 6-32 nut.
- () Position the meter mounting plate and meter assembly over the escutcheon as shown in Detail 7B.
- () Again referring to Detail 7B, mount the panel support brackets on the front panel by placing 6-32 x 3/8" screws through the front panel, the panel escutcheon, the meter mounting plate, and then the support bracket. Secure with a #6 lockwasher and 6-32 nut on each screw. Do not tighten the mounting hardware.
- () Insert a 1/2" rubber grommet in each panel support bracket as shown.

- () Place the chassis assembly on the front panel. Secure it to the front panel with four 6-32 x 1/4" screws, #6 lockwashers, and 6-32 nuts. Be sure that the neon lamp and tube socket leads are not between the chassis and the front panel. The rubber grommets on the panel lamp bracket should fit into the corresponding holes in the meter mounting plate.
- () Secure the chassis to the panel support brackets with four 6-32 x 1/4" screws, #6 lockwashers and 6-32 nuts. Now tighten the screws securing the escutcheon to the front panel.
- () Mount the bank of lever switches to the front panel. Use 4-40 x 1/4" screws. Inspect the switches and place the long lug toward the chassis as shown in Pictorial 7.
- () Insert a #47 pilot lamp in each of the lamp sockets. Place the ends of the lamps in the rubber grommets AL and AM. Position the lugs on the lamp sockets as shown in Pictorial 7.

Refer to Pictorial 8 and Detail 8A for the following steps.

- () Locate the idler shaft and mount the fixed idler gear over the knurl of the shaft. See Detail 8A. The gear teeth must be toward the center of the shaft.
- () Start an 8-32 x 1/8" setscrew in one of the 1/4" retaining rings. Slip the retaining ring on the other end of the idler shaft.
- () Install the other idler gear on the shaft.
- () Set the spacing between the idler gears by placing them alongside one of the rollers and moving the adjustable gear until the gear teeth mesh. Slide the retaining ring against the back of the gear and tighten the setscrew.
- () Assemble the drive roller and idler gear assembly by sliding the end brackets into place at each end. Be sure to place a brass spring washer between the back of each gear on the idler shaft and the end bracket. See Detail 8A.
- () Start 8-32 x 1/8" setscrews in two 1/4" retaining rings. Place one of these retaining rings on each end of the drive roller shaft. Do not tighten.
- () Start an 8-32 x 1/4" setscrew in each thumbwheel and place each end of the drive roller shaft with the hub toward the end bracket.
- () Install a #6 solder lug on each roller support bracket as shown in Detail 8A. Use 6-32 x 1/4" screws and 6-32 nuts.
- () Mount this chart mechanism assembly on the front panel as shown in Pictorial 8 by securing the flange of the end brackets to the chassis with 6-32 x 1/4" screws, #6 lockwashers, and 6-32 nuts. Do not tighten yet.
- () Place the take-up roller on the end brackets as shown in Detail 8A. Be sure that the gears on each end of the take-up roller mesh with those on the idler shaft.

- () Place a formed brass washer on each end of the idler shaft. Install the take-up roller brackets on the take-up roller shaft and the idler shaft. Position them as shown in Detail 8A.
- () Start 8-32 x 1/8" setscrews in the remaining 1/4" retaining rings. Place one of these rings on each end of the idler shaft. Push the retaining rings against the take-up brackets and tighten the setscrews.
- () Referring to Detail 8B, mount the 10-position SET LINE switch at location W. Place a control flat washer between the front panel and the roller end bracket. Secure the switch with a control lockwasher and control nut. See Pictorial 8 for positioning of the switch lugs. Do not tighten.

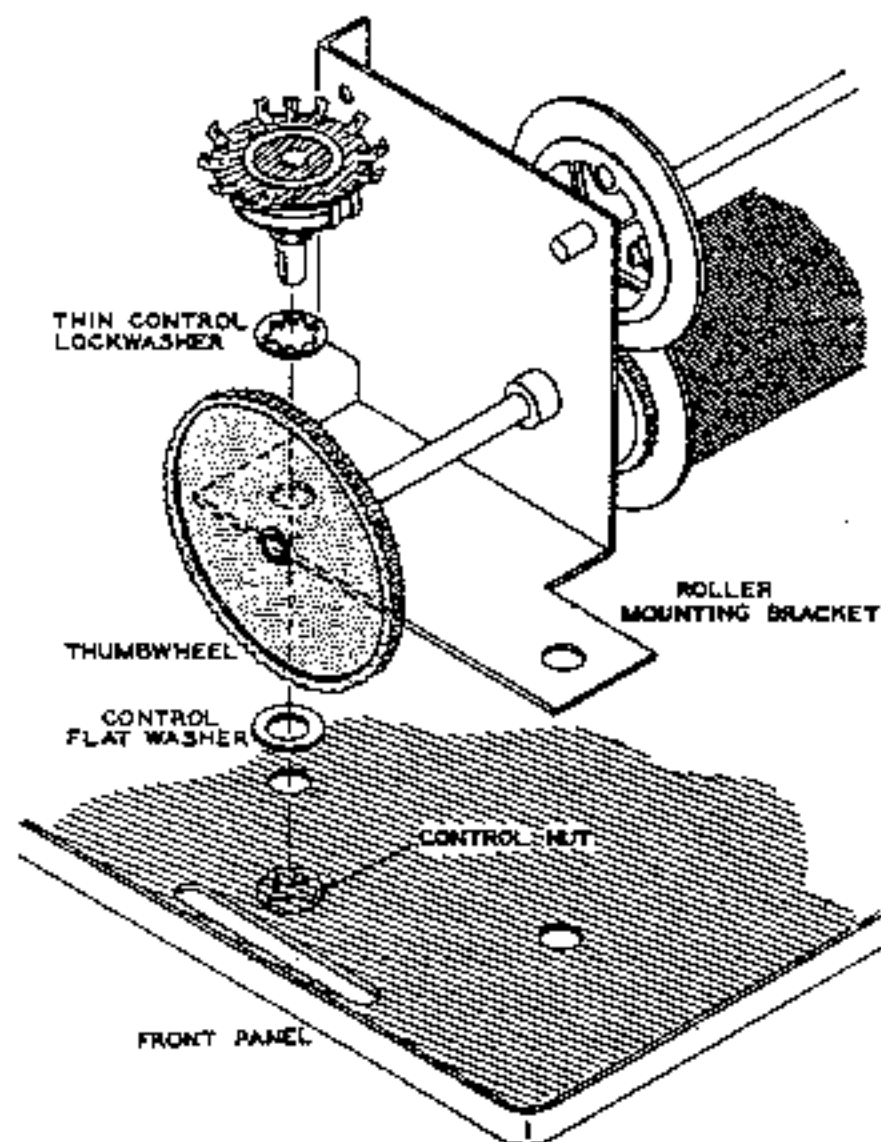

Detail 8B

- () Similarly, mount the 4-position TYPE switch at location V. Place a control flat washer between the front panel and the end bracket. Secure the switch with a control lockwasher and control nut. Do not tighten. Position the switch lugs as shown with the flat of the switch shaft toward the bottom of the front panel.
- () Mount the 20-position FILAMENT switch at location S. Place a control flat washer between the front panel and the end bracket. Secure the switch with a control lockwasher, and control nut. Do not tighten. Position the switch lugs as shown.
- () R11. Mount the 200 Ω PLATE control at location T. Place a control flat washer between the front panel and the end bracket. Secure the control with a control lockwasher and control nut. Position the control lugs as shown. Now tighten all of the control nuts.
- () Place one of the lever switch knobs on each switch lever.

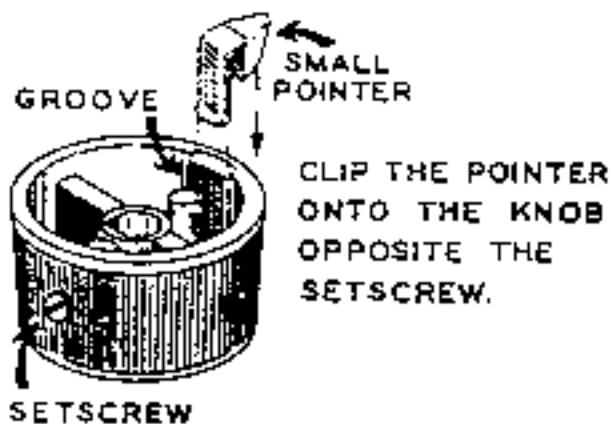

Detail 8C

- () Prepare two of the control knobs by snapping the pointer onto the knob as shown in Detail 8C.
- () Turn the shaft of each control to its fully counterclockwise position. Install the knobs with the pointers on the FILAMENT and PLATE control shafts. Position the knobs so the setscrew is over the flat on the shafts and tighten the setscrew.

- () Similarly, install the remaining two knobs on the shafts of the SET LINE and TYPE controls. Position the knobs so the setscrew is over the flat on the shafts and tighten the setscrew.

NOTE: If the pointers on the knobs do not line up with the front panel markings, remove the knobs, loosen the control and position it accordingly.

- () Tighten the screws holding the chassis to the roller support brackets.
- () Push the retaining rings on the drive roller shaft against the roller brackets and tighten the setscrews.
- () Center the thumbwheels in their respective slots and tighten the setscrews.

This completes the assembly of the roll chart mechanism. Place ONE DROP of light machine oil on each bearing surface. The assembly should now run smoothly without binding. If the gears bind or if the rollers have a tendency to slide from side-to-side, recheck the positioning of the idler gears, retaining rings, and brackets.

Refer to Pictorial 8 for the following steps.

- () Place a length of bare wire through all number 2 lugs on Selector switches SA through SN. Solder lug 2 of each switch except SB.
- () Place a length of bare wire through all number 3 lugs on the Selector switch. Solder lug 3 of each switch except SB.
- () Place a length of bare wire through all number 4 lugs on the Selector switch. Solder lug 4 of each switch except SM.
- () R5. Connect a 360 Ω (orange-blue-brown) 1/2 watt resistor between lugs 2 (NS) and 3 (S-1) of switch V.
- () R5. Place one lead of a 1500 Ω (brown-green-red) 1/2 watt resistor through lug 4 (NS) to lug 5 (S-1) of switch V. Now solder lug 4 of V (S-2). Connect the other lead of this resistor to lug 2 of V (NS).
- () R8. Connect a 3600 Ω (orange-blue-red) 1/2 watt resistor between lugs 8 (S-1) and 10 (NS) of switch V.
- () R7. Connect an 820 Ω (gray-red-brown) 1/2 watt resistor between lugs 9 (S-1) and 10 (NS) of switch V.

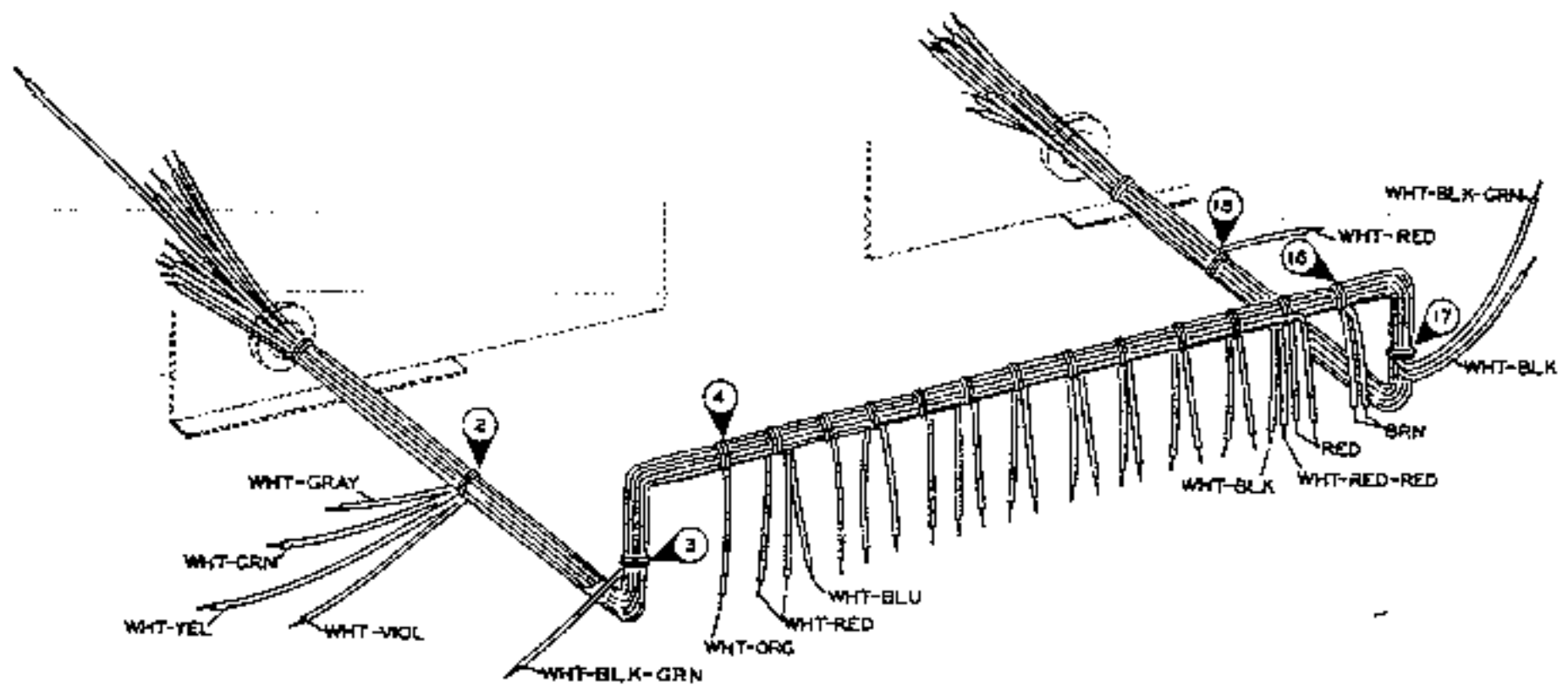

Detail 9A

Refer to Pictorial 9 for the following steps.

- () Locate the switch wiring harness and form it as shown in Detail 9A.
- () Position the harness over the bank of lever switches as shown in Pictorial 9 and insert the ends under the drive roller shaft and through rubber grommets AF and AG.

In the following steps, only switch harness wires will be connected. The breakout numbers are circled on the Pictorial for quick identification.

Connect the harness wires from breakout #2 as follows:

- () White-yellow to lug 2 of switch V (S-3).
- () White-green to lug 12 of switch V (S-1).
- () White-violet to lug 11 of switch V (S-1).
- () White-gray to lug 1 of switch W (S-1).

Connect the harness wire from breakout #3 as follows:

- () White-black-green to lug 6 of switch V (NS).

Connect the harness wire from breakout #4 as follows:

- () White-orange to lug 1 of switch SN (S-1).

Connect the harness wires from breakout #5 as follows:

- () Both white-red to lug 1 of switch SM (S-2).
- () White-blue to lug 4 of switch SM (S-3).

Connect the harness wire from breakout #6 as follows:

- () White-brown to lug 1 of switch SL (S-1).

Connect the harness wires from breakout #7 as follows:

- () Both black to lug 1 of switch SK (S-2).

Connect the harness wire from breakout #8 as follows:

- () White to lug 1 of switch SJ (S-1).

Connect the harness wires from breakout #9 as follows:

- () Both gray to lug 1 of switch SH (S-2).

Connect the harness wires from breakout #10 as follows:

- () Both violet to lug 1 of switch SG (S-2).

Connect the harness wires from breakout #11 as follows:

- () Both blue to lug 1 of switch SF (S-2).

Connect the harness wires from breakout #12 as follows:

- () Both green to lug 1 of switch SE (S-2).

Connect the harness wires from breakout #13 as follows:

- () Both yellow to lug 1 of switch SD (S-2).

Connect the harness wires from breakout #14 as follows:

- () Both orange to lug 1 of switch SC (S-2).

Connect the harness wires from breakout #15 as follows:

- () Both red to lug 1 of switch SB (S-2).

- () White-black to lug 2 of switch SB (S-3).

- () White-red-red to lug 3 of switch SB (S-3).

Connect the harness wires from breakout #16 as follows:

- () Both brown to lug 1 of switch SA (S-2).

Connect the harness wires from breakout #17 as follows:

- () White-black to lug 3 of control T (NS).

- () White-black-green to lug 1 of control T (S-1).

Connect the harness wire from breakout #18 as follows:

- () White-red-red to lug 22 of switch S (NS).

Refer to Pictorial 10 for the following steps.

- () Locate the switch-meter wiring harness.
- () Referring to Detail 10A, locate breakout #8 and place it through the grommets in the front panel support brackets, as shown in Pictorial 10.
- () Place breakout #1 of the harness through grommet AG in the chassis.

Connect the harness wires from breakout #2 as follows:

- () Violet to lug 1 of switch M (S-2).
- () Both brown to lug 2 of switch M (S-2).

Connect the harness wires from breakout #3 as follows:

- () Black to lug 9 of socket R (S-1).
- () Green to lug 8 of socket R (S-1).

Connect the harness wires from breakout #4 as follows:

- () Red to lug 1 of the meter (S-1).
- () Place the yellow and both black wires through the cutout in the chassis.
- () Connect the two black wires to lug 1 of pilot lamp socket AM (S-2).
- () Connect the yellow wire to lug 2 of pilot lamp socket AM (S-1).

Connect the harness wire from breakout #5 as follows:

- () Orange to lug 2 of the meter (NS).

Connect the harness wires from breakout #6 as follows:

- () Orange to lug 2 of the meter (S-2).
- () Place both yellow and both black wires through the cutout in the chassis.
- () Connect the two black wires to lug 1 of pilot lamp socket AL (S-2).
- () Connect the two yellow wires to lug 2 of pilot lamp socket AL (S-2).

Connect the harness wires from breakout #7 as follows:

- () Violet to lug 2 of terminal strip AC (NS).
- () Orange to lug 2 of terminal strip AB (NS).

Connect the harness wires from breakout #8 as follows:

- () Short brown to lug 2 of terminal strip AE (NS).
- () Blue to lug 3 of terminal strip AC (NS).
- () Red to lug 3 of slide switch A (S-1).
- () Long brown to lug 1 of slide switch A (S-1).
- () Connect the red lead of the half-wave rectifier to lug 3 of terminal strip AB (NS).
- () Connect the yellow lead of the half-wave rectifier to lug 5 of switch A (S-1).

Refer to Pictorial 11 for the following steps. In the following steps use the switch harness wires.

Connect the harness wires from breakout #1 as follows:

- () Brown to lug 1 of socket H (S-2).
- () Red to lug 2 of socket H (S-2).
- () Orange to lug 3 of socket H (S-2).
- () Yellow to lug 4 of socket H (S-2).
- () Green to lug 5 of socket H (S-2).
- () White-red to lug 12 of socket H (S-1).
- () White-brown to lug 11 of socket H (S-1).
- () Black to lug 10 of socket H (S-2).
- () White to lug 9 of socket H (S-2).
- () Gray to lug 8 of socket H (S-2).
- () Violet to lug 7 of socket H (S-2).
- () Blue to lug 6 of socket H (S-2).

- () White-orange to lug 3 of terminal strip AE (NS).
 - () White-green to lug 2 of slide switch A (S-1).
 - () White-blue to lug 4 of slide switch A (S-1).
 - () White-yellow to lug 6 of slide switch A (S-1).
 - () White-violet to lug 4 of terminal strip AC (NS).
 - () Place the white-gray wire through grommet AA. It will be connected later.
- Connect the harness wires from breakout #19 as follows:
- () Brown to lug 1 of socket R (S-3).
 - () Red to lug 2 of socket R (S-3).
 - () Orange to lug 3 of socket R (S-3).
 - () Yellow to lug 4 of socket R (S-3).
 - () Green to lug 5 of socket R (S-3).
 - () Blue to lug 6 of socket R (S-2).
 - () Violet to lug 7 of socket R (S-2).
 - () Black to lug 10 of socket Q (S-2).
 - () Gray to lug 8 of socket Q (S-1).
 - () White-red to lug 12 of socket Q (S-2).
 - () Position the power transformer on the chassis so that the transformer leads are as shown in Pictorial 11. Mount the power transformer on the chassis. Use 8-32 x 3/8" screws, with #8 flat washers under the screw heads. Secure with #8 lock-washers and 8-32 nuts.
 - () Separate the brown and gray leads extending from the bottom on the right side of the power transformer. Place these leads under the transformer as shown.
 - () Pick the black transformer lead extending from the top of the left side of the transformer and place it through grommet AG. Place the remainder of the transformer leads through grommet AH.
 - () Pick out the red-yellow and the red-white transformer leads extending from the bottom of the right side of the transformer. Place these leads through grommet AF. Position them as shown.
 - () Place the power transformer leads, except the red and blue-red leads, through grommet AA.
 - () Connect the blue-red power transformer lead to lug 1 of terminal strip AB (NS).
 - () Connect the red power transformer lead to lug 4 of terminal strip AB (NS).
 - () R4. Connect a 2500 Ω 7 watt wire-wound resistor from lug 4 of terminal strip AB (S-2) to lug 4 of terminal strip AC (S-2).
 - () R10. Connect a 75 K Ω 2% precision resistor from lug 3 of terminal strip AC (S-2) to lug 3 of terminal strip AB (NS).
 - () R9. Connect a 1000 Ω (brown-black-red) 1/2 watt resistor between lugs 3 (S-3) and 2 (S-2) of terminal strip AB.
 - () R2. Connect a 270 K Ω (red-violet-yellow) 1/2 watt resistor between lugs 1 (NS) and 2 (S-2) of terminal strip AC.
 - () R1. Connect a 100 K Ω (brown-black-yellow) 1/2 watt resistor from lug 1 of terminal strip AE (NS) to lug 1 of terminal strip AC (NS).
 - () Connect either neon lamp lead to lug 1 (S-2) and the other lead to lug 2 (S-2) of terminal strip AE.
 - () C1. Connect a .1 μ fd tubular capacitor from lug 1 of terminal strip AB (S-2) to lug 1 of terminal strip AC (S-3).
 - () Connect the grid clip to one end of the length of black test lead as shown in Detail 11A (on fold-out with Pictorial 11).
 - () Remove the hardware securing the half-wave rectifier and the plastic clamp. Place the free end of the black test lead through grommet C in the front panel, through the plastic clamp, and connect it to lug 3 of terminal strip AE (S-2). Now replace the hardware on the rectifier.

Refer to Pictorial 12 for the following steps.

CAUTION: Do not allow the soldering iron to come into contact with thumbwheels.

Dress the harness wires extending from break-out #1 of the meter wiring harness under the drive roller shaft and connect them as follows:

- () Orange to lug 2 of control T (S-1).
- () Black to lug 3 of control T (NS).
- () Blue to lug 20 of switch S (NS).
- () Green to lug 22 of switch S (S-2).
- () Yellow to lug 11 of switch S (NS).

Connect the power transformer leads extending through grommet AH to the 20 position rotary switch S as follows:

- () Black-yellow to lug 20 of S (S-2).
- () Black-violet to lug 19 of S (S-1).
- () Blue-yellow to lug 18 of S (S-1).
- () Green-blue to lug 17 of S (S-1).
- () Brown-yellow to lug 16 of S (S-1).
- () Yellow to lug 15 of S (S-1).
- () White-orange to lug 14 of S (S-1).
- () Blue-orange to lug 13 of S (S-1).
- () Violet to lug 12 of S (S-1).

- () Blue to lug 11 of S (S-2).
- () Orange to lug 10 of S (S-1).
- () White to lug 9 of S (S-1).
- () Brown to lug 8 of S (S-1).
- () Gray to lug 7 of S (S-1).
- () Green-white to lug 6 of S (S-1).
- () Green-orange to lug 5 of S (S-1).
- () Green-yellow to lug 4 of S (S-1).
- () Green-red to lug 3 of S (S-1).
- () Green to lug 2 of S (S-1).

() Connect the black power transformer lead extending from grommet AG to lug 3 of control T (S-3).

() Connect the red-white power transformer lead extending through grommet AF to lug 6 of switch V (S-2).

() Connect the red yellow transformer lead extending through grommet AF to lug 10 of switch V (S-3).

Connect the power transformer leads from grommet AA switch W as follows:

- () Black-red to lug 10 of W (S-1).
- () Black-yellow to lug 9 of W (S-1).

- () Black-violet to lug 8 of W (S-1).
- () Black-orange to lug 7 of W (S-1).
- () Black-blue to lug 6 of W (S-1).
- () Black-green to lug 5 of W (S-1).
- () Black-white to lug 4 of W (S-1).
- () Blue-white to lug 3 of W (S-1).
- () Blue-green to lug 2 of W (S-1).
- () Connect the black power transformer lead extending from grommet AA to lug 1 of terminal strip AK (NS).
- () Connect the white-gray harness wire extending from grommet AA to lug 2 of terminal strip AK (NS).

Referring to Detail 12A, install the strain relief insulator and line cord at AQ on the chassis. Leave approximately 1-1/2" of line cord inside the chassis.

- () Connect either line cord wire to lug 1 (S-2) and the other wire to lug 2 (S-2) of terminal strip AK.
- () Install a 6-32 speednut on each side of the cutout in the rear flange of the chassis as shown in Pictorial 12.

This completes the wiring of your Tube Checker.

NOTE: The power transformer leads may be tied into a cable to improve the overall appearance of your kit. To tie the transformer leads into a cable, wrap a short length of hookup wire around the transformer leads at various intervals. See the photograph on Page 36.

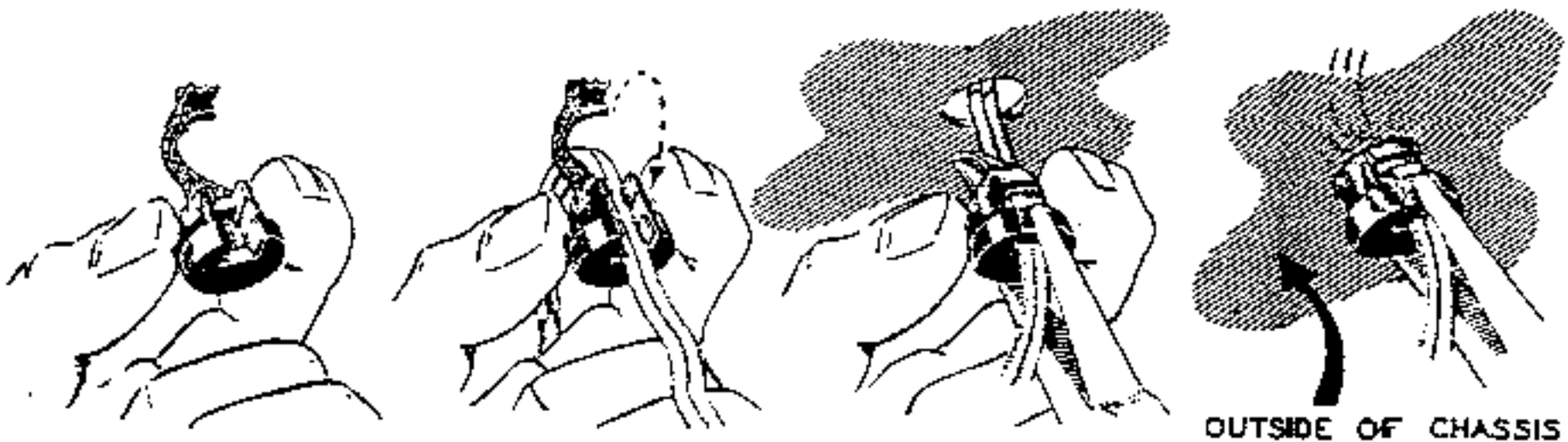

Detail 12A

Refer to Pictorial 13 for the following steps.

- () Install the roll chart on the drive roller as shown in Pictorial 13A. Line up the bottom of the chart with the separation line between the two halves of the roller. Tape the chart to the roller with the masking tape provided.
- () Roll the chart on the drive roller, turning the roller with one hand and guiding the chart with the other. Use the take-up roller as a guide to keep the chart straight as it winds

up on the drive roller. See Pictorial 13B.

- () Push the take-up roller toward the chassis and tape the top of the chart as shown in Pictorial 13C. Roll the chart back and forth through its entire length several times to make sure it does not bind at either end. Keep the chart taut by pulling back slightly on the take-up roller shaft.
- () Install the take-up roller tension springs as shown in Pictorial 13C.

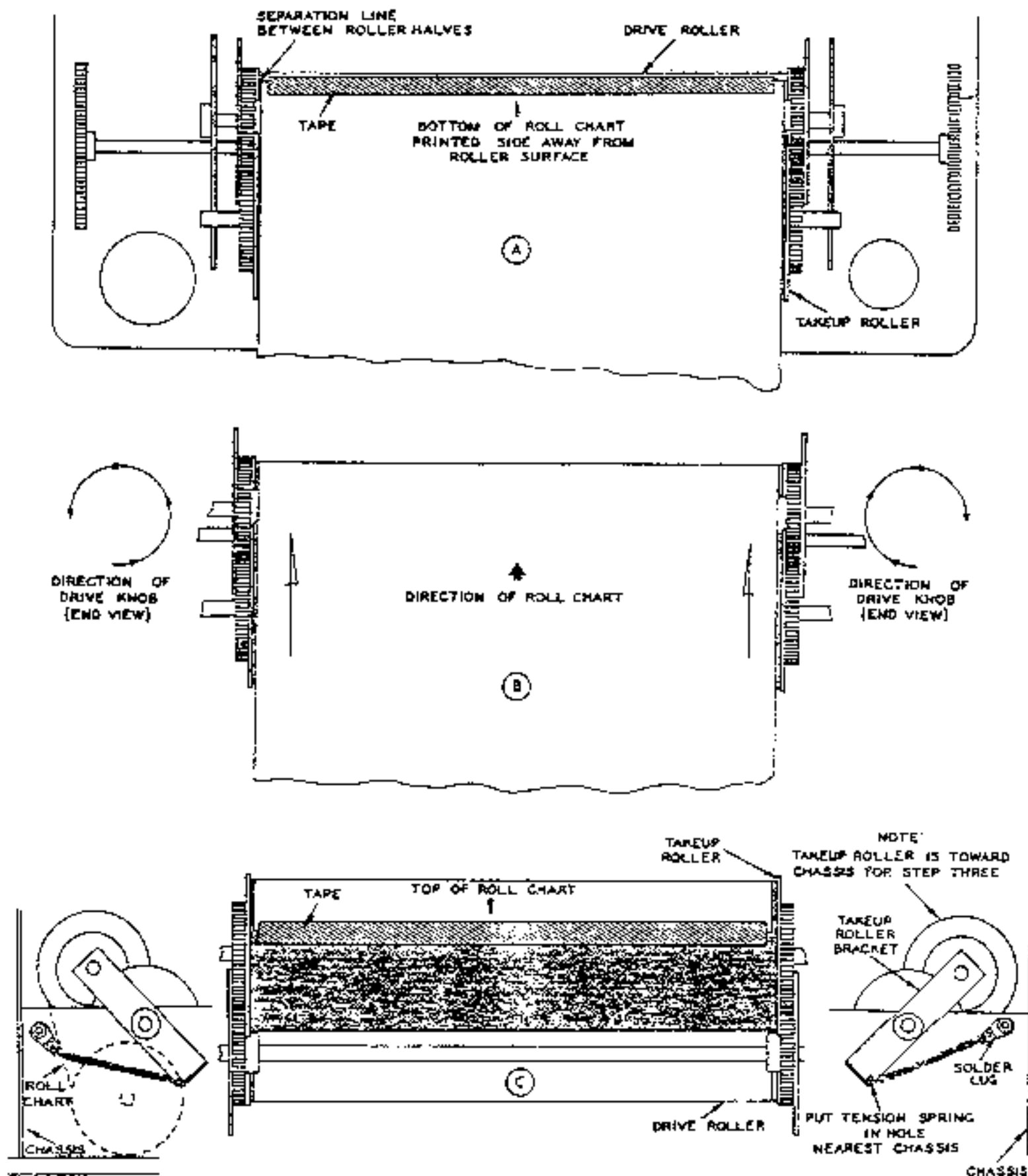

Pictorial 13

TESTING

CAUTION: If the neon short lamp lights during testing, turn the Tube Checker off immediately and systematically troubleshoot the circuit for the possible cause of difficulty. The short test indicator should not indicate any glow during the testing procedure if the instrument is correctly wired.

Plug the line cord into a 117 volt AC, 50/60 cps outlet. Never use 25 cps or DC line voltage as the power transformer will suffer severe damage. Turn the instrument on by rotating the SET LINE control. The panel lamps should light immediately and the meter pointer should deflect upscale. Rotate the SET LINE control back and forth through several positions. The panel lamps should become brighter and the meter pointer should deflect further upscale as the control is rotated clockwise.

If an AC voltmeter is available, the filament voltages may be checked as follows:

1. Rotate the SET LINE control until the Tube Checker meter pointer falls in the LINE TEST block at mid-scale.
2. Push one test probe into terminal 1 of the 6X4 socket and the other into terminal 5.
3. Pull down lever switch E into the BOTTOM position, leaving all other lever switches in the CENTER position.

4. Rotate the FILAMENT control through all positions. The voltmeter reading should increase as the FILAMENT control is rotated clockwise. Any deviation from this pattern indicates improper transformer wiring. The reading of the voltmeter should substantially agree with the setting of the filament control.

The following chart is provided so that the high voltage secondary of the transformer may be checked for proper connections. Before making the voltage checks, rotate the SET LINE control until the meter pointer falls in the LINE TEST block at mid-scale.

Connect AC voltmeter test leads to:	Meter should read: (±10%)
lug 1 of T and lug 10 of V	30 volts AC
lug 1 of T and lug 1 of AB	100 volts AC
lug 1 of T and lug 4 of AB	250 volts AC

If preliminary tests indicate the Tube Checker to be functioning properly, the action of the instrument can be further tested by making actual tests on a variety of tubes. Remember that for the purpose of testing the instrument, a tube known to be defective in some way may be just as useful, if not more so, than a tube which is perfect in every respect.

CABINET INSTALLATION

- () Install the rubber feet in the bottom and back of the cabinet.
- () Install the handle, using #10 sheet metal screws.
- () Place the Tube Checker face down on your work bench. Slide the line cord through the hole in the back of the cabinet and push the cabinet down inside the flanges at the edge of the panel. Secure with two 6-32 screws through the rear of the cabinet, and into the speednuts.

NOTE: The blue and white identification label shows the Model Number and Production Series

Number of your kit. Refer to these numbers in any communications with the Heath Company; this assures you that you will receive the most complete and up-to-date information in return.

- () Install the identification label in the following manner:
 1. Select a location for the label where it can easily be seen when needed, but will not show when the unit is in operation. This location might be on the rear panel or the top of the chassis, or on the rear or bottom of the cabinet.
 2. Carefully peel away the backing paper. Then press the label into position.

USING YOUR TUBE CHECKER

The instrument you have just completed will provide a variety of tests to indicate the relative value of the particular tube being checked. The following steps may be used as a guide in setting up tube testing procedures. Remember that the ultimate value of any measuring device is dependent upon the skill of the operator and, more important, his ability to properly evaluate the information provided by the instrument.

1. With the power cord connected, move the roll chart to the listing of the tube to be tested. If an asterisk (*) appears after the tube designation, refer to the proper note at the bottom of the roll chart. Turn the SET LINE control until the meter pointer falls within the LINE TEST block.
2. Set the TYPE switch to the number shown on the chart.
3. Set the FILAMENT selector to the voltage shown on the chart.
4. Set the PLATE control according to the chart information.
5. Set the LEVER switches to the T-TOP and B-BOTTOM positions as shown in the top and bottom columns on the chart.
6. Insert the tube and reset the SET LINE control if necessary. (Pin positions and keyways determine tube positioning on all sockets.)
7. Check the tube for shorts by moving the levers shown in light type through the two positions, returning to the position shown on the chart. The TEST switch remains in the SHORT position for this test. The SHORT-LEAKAGE switch should be in the SHORT position. A shorted tube is indicated by a steady glow of the neon lamp. Disregard neon lamp flashing as the lever switches are moved. It is possible that some serious short circuits will momentarily overload the power transformer. This condition will be indicated by complete dim out of the panel lamps. Do not allow the Tube Checker to operate under this extreme condition for any length of time. Make the test as quickly as possible in order to obtain the desired information.

8. Check the tube for leakage between elements by moving the SHORT-LEAKAGE switch to the LEAKAGE position and repeating the short test as outlined above.
9. After allowing sufficient time for the tube to reach operating temperature, check for quality by moving the test slide switch to the TEST position. If the meter pointer falls in the GREEN scale, the quality of the tube is GOOD.
10. Check for open elements as follows: holding the slide switch in the TEST position, move each lever in the TOP position (only those shown in light type) to the BOTTOM position and return. Satisfactory tube elements (those properly connected to their pins) are indicated by a decrease in meter reading. The grid element usually shows a large decrease, while a screen or plate may show only a slight decrease.

NOTE: If the meter indication in the quality test is off scale, reduce the meter reading to an on-scale reading by turning the PLATE control counterclockwise, then proceed with the open element test.

11. To check filaments, filament taps and internal connections for continuity, set the FILAMENT selector to .63 volts. Move each lever shown in dark type through each of its other two positions. Always move only one lever at a time. Satisfactory filaments, taps, and internal connections will be shown by a bright glow of the SHORT test indicator.

In any of the above tests, should the tube prove to be faulty in some respect, the defective element can be traced by comparing the lever switch in question with a base diagram of the tube. Lever switch A corresponds to tube pin 1, lever switch B to tube pin 2, etc.

Multiple tube types (tubes which contain more than one set of elements) are indicated on the chart by a bracket set of listings, one for each test to be made on the tube. The Checker is set up according to the test in each line and checked through all of the test as outlined in the preceding steps.



Check pilot lamps by setting the FILAMENT selector to the proper voltage and inserting the pilot lamp in the socket found in the center of the large 7-pin socket. This is a universal type pilot lamp test socket and does not require that the lamp be permanently inserted. It is only necessary to hold the pilot lamp so that the side wall of the base and the center pin of the lamp make contact with the corresponding points in the lamp socket.

NEW TUBES

We annually revise the Tube Checker roll chart in order to keep abreast of new tube releases. However, because of the great quantity of new tubes being released by manufacturers, a customer will occasionally desire to check a new tube before the test data appears on the roll chart.

The following instructions indicate how to set up the instrument for obtaining temporary settings so that these new tubes may be checked (provided manufacturer's data is available).

1. Note manufacturer's data carefully concerning the base diagram of the pin connections and filament voltage.
2. Set the Tube Checker TYPE switch as follows:
 - Type 1 - for low cathode current tubes (below 4 ma), usually diode types.
 - Type 2 - for tube types with cathode current between 3 ma and 15 ma. These are usually filament type tubes with the exception of diodes.
 - Type 3 - for tube types with cathode current greater than 8 ma. These are usually indirect-heated cathode types with the exception of diodes.
 - Type 4 - for gas control tubes, gaseous rectifiers, and eye or target tubes.
3. Set FILAMENT voltage to the value specified by manufacturer.
4. Set all levers to the CENTER position.
5. Determine the first filament connection from the tube base diagram and leave its connection lever in the CENTER position. Its connection lever corresponds to the letter on the lever - A corresponds to pin 1, B to pin 2, C to pin 3, etc.
6. Determine the second filament connection from the tube base diagram and set its connection lever to the BOTTOM position.
7. Determine from base diagram if the tube has a filament tap. The position of the lever corresponding to the filament tap will depend upon the placement of the tap in respect to the other filament connections. Some filament taps are placed in the center of the filament, as in the 12AU7. For this type filament, the two outer terminals (pins 4 and 5) are connected to one side of the filament supply (levers in CENTER position) and the tap is connected to the other side (lever in BOTTOM position). The FILAMENT control is then set at $1/2$ the voltage rating of the entire filament, or (in this case) $12.6/2 = 6.3$ volts. When the filament tap is not filament which is electrically nearer the tap position. For the 35Z5, pins 2 and 3 should be connected to one side of the filament supply and pin 7 to the other. The FILAMENT control is then set to the voltage closest to that recommended by the tube manufacturer, in this case 32 volts.
8. If the tube has more than one section (duo-diodes, duo-triodes, etc.) make a separate test for each section. For the section being tested, follow the instructions below. For the section not being tested, move all corresponding connection levers to the bottom position. If the tube has only one section, follow the instructions below.
9. Move the connection lever corresponding to the cathode to the BOTTOM position.
10. Move all other elements of the section being tested (screens, suppressors, grids, etc.) to the TOP position.
11. Plug the tube into the correct socket.
12. Plug the line cord into the power supply and turn the instrument on.
13. Adjust the SET LINE control until the meter pointer falls in the LINE TEST block.
14. Hold the ADJUST LINE SHORT-TEST switch in the TEST position and adjust the PLATE



control to bring the pointer to the middle of the GOOD scale. (If possible, make this adjustment for at least three new tubes of the same type and select the average setting.)

15. List all these settings in the space provided

at the back of the manual.

16. If the tube is of the multi-section type, check the remaining sections in the manner outlined above and list the settings in the manual.

IN CASE OF DIFFICULTY

1. Recheck the wiring. Trace each lead in colored pencil on the Pictorial and Schematic Diagram as it is checked. It is frequently helpful to have a friend check your work. Someone who is not familiar with the unit may notice something consistently overlooked by the constructor.
2. It is interesting to note that about 90% of the kits that are returned for repair, do not function properly due to poor connections and soldering. Therefore, many troubles can be eliminated by reheating all connections to make sure that they are soldered as described in the Proper Soldering Techniques section of this manual.
3. Check the values of the component parts. Be sure that the proper part has been wired into the circuit, as shown in the pictorial diagrams and as called out in the wiring instructions.
4. Check for bits of solder, wire ends or other foreign matter which may be lodged in the wiring.
5. Check the voltages in the manner outlined under TESTING. This may help to show up a misinterpretation of the transformer lead identification code.
6. Make continuity checks between the lever switch common lugs and the various socket pins to make sure that all contacts are properly connected to the lever switches. (Pin 1 of each socket corresponds to lever switch A, pin 2 to lever switch B, etc.)

SERVICE INFORMATION

SERVICE

If, after applying the information in this manual and your best efforts, you are still unable to obtain proper performance, it is suggested that you take advantage of the technical facilities which the Heath Company makes available to its customers.

The Technical Consultation Department is maintained for your benefit. This service is available to you at no charge. Its primary purpose is to provide assistance for those who encounter difficulty in the construction, operation or maintenance of HEATHKIT equipment. It is not intended, and is not equipped to function as a general source of technical information involving

kit modifications nor anything other than the normal and specified performance of HEATHKIT equipment.

Although the Technical Consultants are familiar with all details of this kit, the effectiveness of their advice will depend entirely upon the amount and the accuracy of the information furnished by you. In a sense, YOU MUST QUALIFY for GOOD technical advice by helping the consultants to help you. Please use this outline:

1. Before writing, fully investigate each of the hints and suggestions listed in this manual under In Case Of Difficulty. Possibly it will not be necessary to write.

2. When writing, clearly describe the nature of the trouble and mention all associated equipment. Specifically report operating procedures, switch positions, connections to other units, and anything else that might help to isolate the cause of trouble.
3. Report fully on the results obtained when testing the unit initially and when following the suggestions under In Case Of Difficulty. Be as specific as possible and include voltage readings if test equipment is available.
4. Identify the kit Model Number and Series Number, and date of purchase, if available. Also mention the date of the kit assembly manual. (Date at bottom of Page 1.)
5. Print or type your name and address, preferably in two places on the letter.

With the preceding information, the consultant will know exactly what kit you have, what you would like it to do for you and the difficulty you wish to correct. The date of purchase tells him whether or not engineering changes have been made since it was shipped to you. He will know what you have done in an effort to locate the cause of trouble and, thereby, avoid repetitious suggestions. In short, he will devote full time to the problem at hand, and through his familiarity with the kit, plus your accurate report, he will be able to give you a complete and helpful answer. If replacement parts are required, they will be shipped to you, subject to the terms of the Warranty.

The Factory Service facilities are also available to you, in case you are not familiar enough with electronics to provide our consultants with sufficient information on which to base a diagnosis of your difficulty, or in the event that you prefer to have the difficulty corrected in this manner. You may return the completed equipment to the Heath Company for inspection and necessary repairs and adjustments. You will be charged a minimal service fee, plus the price of any additional parts or material required. However, if the completed kit is returned within the Warranty period, parts charges will be governed by the terms of the Warranty. State the date of purchase, if possible.

Local Service by Authorized HEATHKIT Service Centers is also available in some areas and

often will be your fastest, most efficient method of obtaining service. HEATHKIT Service Centers will honor the regular 90 day HEATHKIT Parts Warranty on all kits, whether purchased through a dealer or directly from the Heath Company; however, it will be necessary that you verify the purchase date of your kit.

Under the conditions specified in the Warranty, replacement parts are supplied without charge; however, if the Service Center assists you in locating a defective part (or parts) in your kit, or installs a replacement part for you, you may be charged for this service.

HEATHKIT equipment purchased locally and returned to Heath Company for service must be accompanied by your copy of the dated sales receipt from your authorized HEATHKIT dealer in order to be eligible for parts replacement under the terms of the Warranty.

THIS SERVICE POLICY APPLIES ONLY TO COMPLETED EQUIPMENT CONSTRUCTED IN ACCORDANCE WITH THE INSTRUCTIONS AS STATED IN THE MANUAL. Equipment that has been modified in design will not be accepted for repair. If there is evidence of acid core solder or paste fluxes, the equipment will be returned **NOT** repaired.

For information regarding modification of HEATHKIT equipment for special applications, it is suggested that you refer to any one or more of the many publications that are available on all phases of electronics. They can be obtained at or through your local library, as well as at most electronic equipment stores. Although the Heath Company sincerely welcomes all comments and suggestions, it would be impossible to design, test, evaluate and assume responsibility for proposed circuit changes for special purposes. Therefore, such modifications must be made at the discretion of the kit builder, using information available from sources other than the Heath Company.

REPLACEMENTS

Material supplied with HEATHKIT products has been carefully selected to meet design requirements and ordinarily will fulfill its function without difficulty. Occasionally, improper operation can be traced to a faulty component. Should inspection reveal the necessity for re-



placement, write to the Heath Company and supply all of the following information.

- A. Thoroughly identify the part in question by using the part number and description found in the manual Parts List.
- B. Identify the kit Model Number and Series Number.
- C. Mention date of purchase.
- D. Describe the nature of defect or reason for requesting replacement.

The Heath Company will promptly supply the necessary replacement. PLEASE DO NOT RETURN THE ORIGINAL COMPONENT UNTIL SPECIFICALLY REQUESTED TO DO SO. Do not dismantle the component in question as this will void the guarantee. This replacement policy does not cover the free replacement of parts that may have been broken or damaged through carelessness on the part of the kit builder.

SHIPPING INSTRUCTIONS

In the event that your instrument must be returned for service, these instructions should be

carefully followed. Be sure to secure the Tube Checker in its cabinet.

Wrap the equipment in heavy paper, exercising care to prevent damage. Place the wrapped equipment in a stout carton of such size that at least three inches of shredded paper, excelsior, or other resilient packing material can be placed between all sides of the wrapped equipment and the carton. Close and seal the carton with gummed paper tape, or alternately, tie securely with stout cord. Clearly print the address on the carton as follows:

To: HEATH COMPANY
Benton Harbor, Michigan 49022

ATTACH A LETTER TO THE OUTSIDE OF THE CARTON BEARING YOUR NAME, COMPLETE ADDRESS, DATE OF PURCHASE, AND A BRIEF DESCRIPTION OF THE DIFFICULTY ENCOUNTERED. Also, include your name and return address on the outside of the carton. Preferably affix one or more "Fragile" or "Handle With Care" labels to the carton, or otherwise so mark with a crayon of bright color. Ship by insured parcel post or prepaid express; note that a carrier cannot be held responsible for damage in transit if, in HIS OPINION, the article is inadequately packed for shipment.

WARRANTY

The Heath Company warrants that the parts supplied in its kits (except batteries) shall be free of defects in materials and workmanship under normal conditions of use and service. The obligation of Heath under this warranty is limited to replacing or repairing any such part upon verification that it is defective in this manner. This obligation is further limited to such defective parts for which Heath is notified of the defect within a period of ninety (90) days from the original date of shipment of the kit.

The obligation of Heath under this warranty does not include either the furnishing or the expense of any labor in connection with the installation of such repaired or replacement parts. The obligation of Heath with respect to transportation expenses is limited to the cost of shipping the repaired or replacement parts to the buyer, provided such repair or replacement comes within the terms of this warranty.

The foregoing warranty extends only to the original buyer and is expressly in lieu of all other warranties, expressed or implied. The foregoing warranty is further in lieu of all other obligations or liabilities on the part of Heath and in no event shall the Heath Company be liable for any anticipated profits, consequential damages, loss of time or other losses incurred by the buyer in connection with the purchase, assembly or use of the kit product or components thereof.

The foregoing warranty shall be deemed completely void if acid core solder or paste flux or other corrosive solders or fluxes have been used in assembling or repairing the kit product. Heath will not replace or repair any parts of any kit products in which such corrosive solders or fluxes have been used.

This warranty applies only to Heath products sold and shipped to points within the continental United States and to APO and FPO shipments. Warranty replacement for Heath products sold or shipped outside the United States is on a f.o.b. factory basis. Contact the Heath authorized distributor in your country or write: Heath Company, International Division, Benton Harbor, Michigan, U.S.A.

HEATH COMPANY

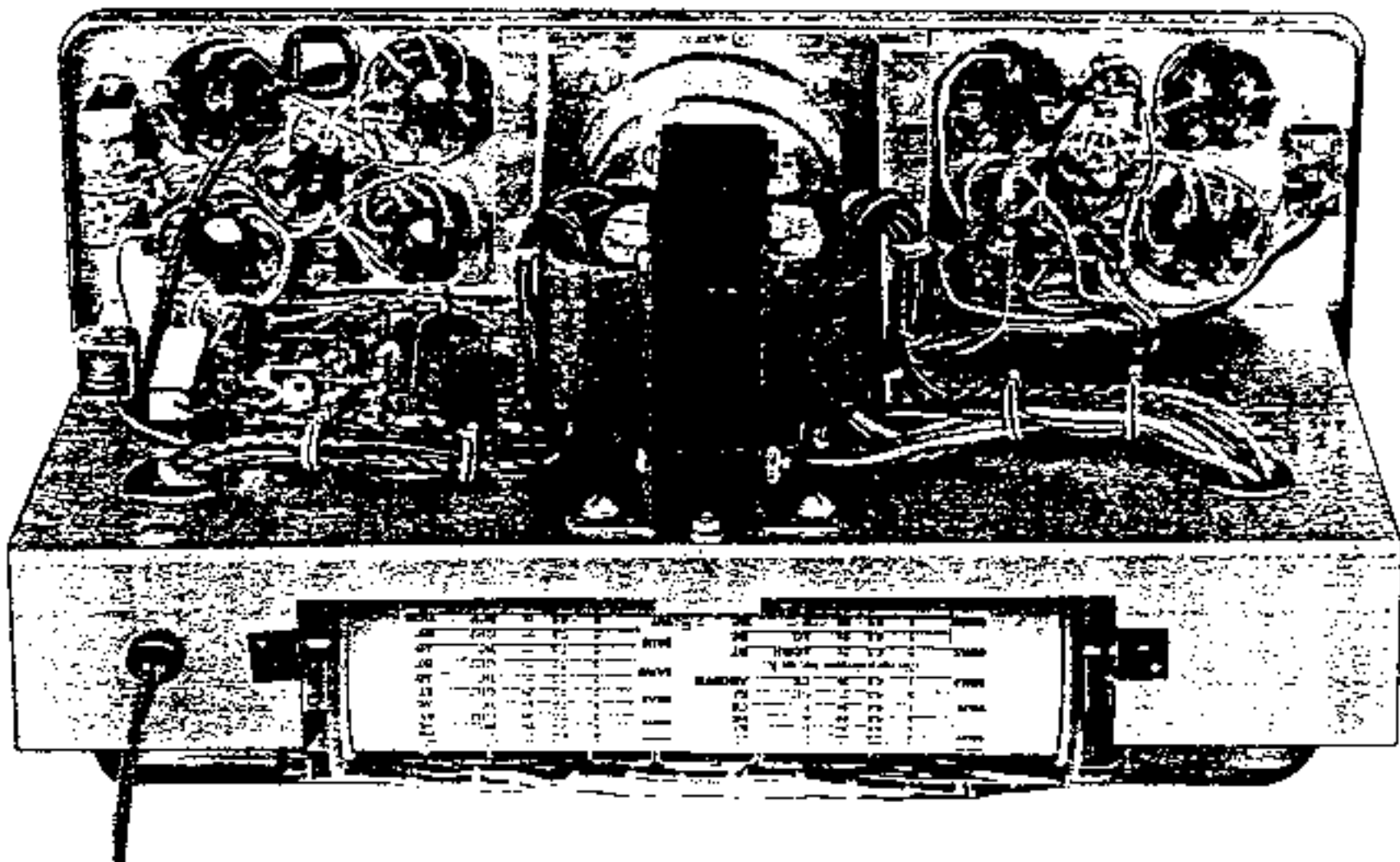
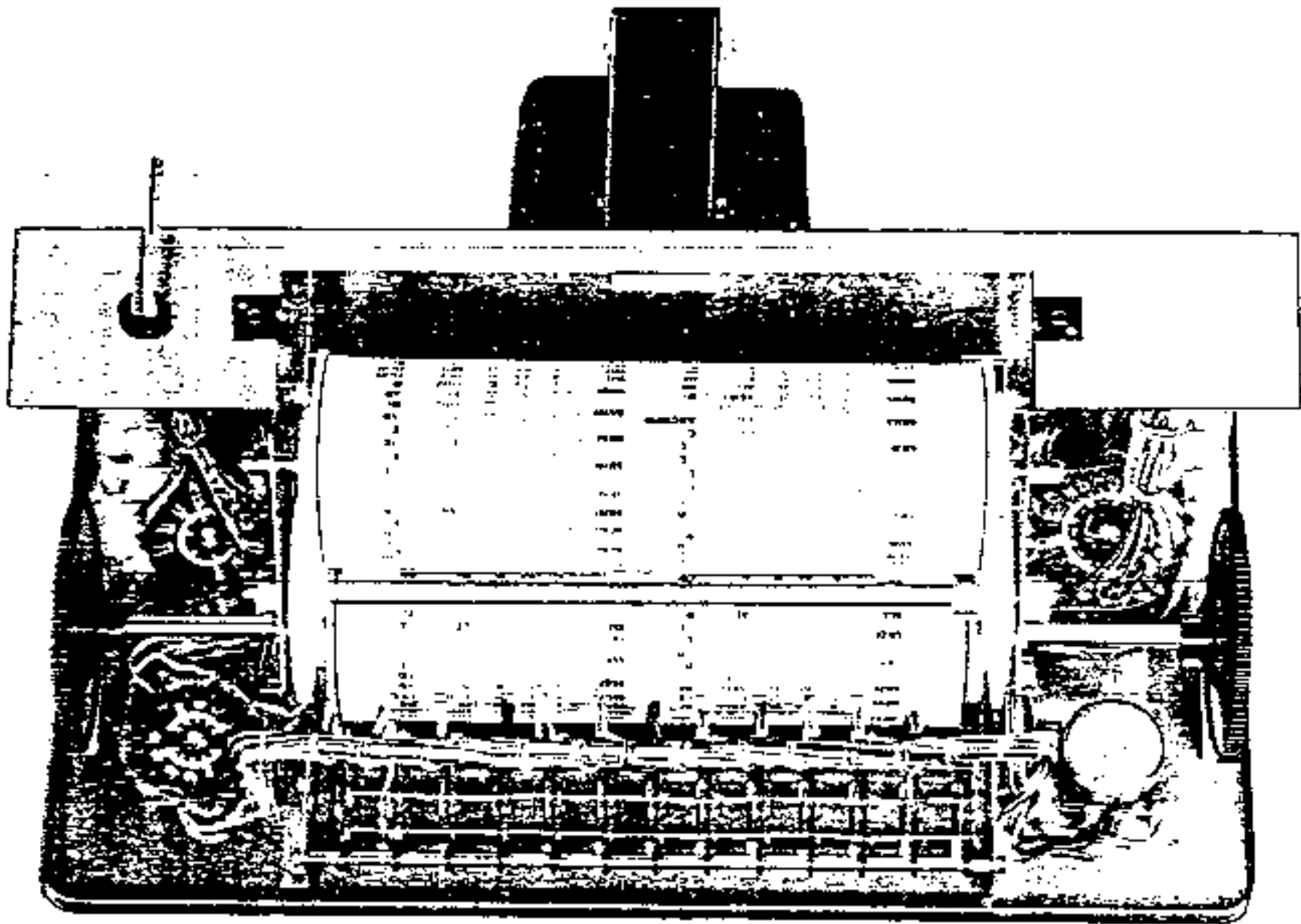

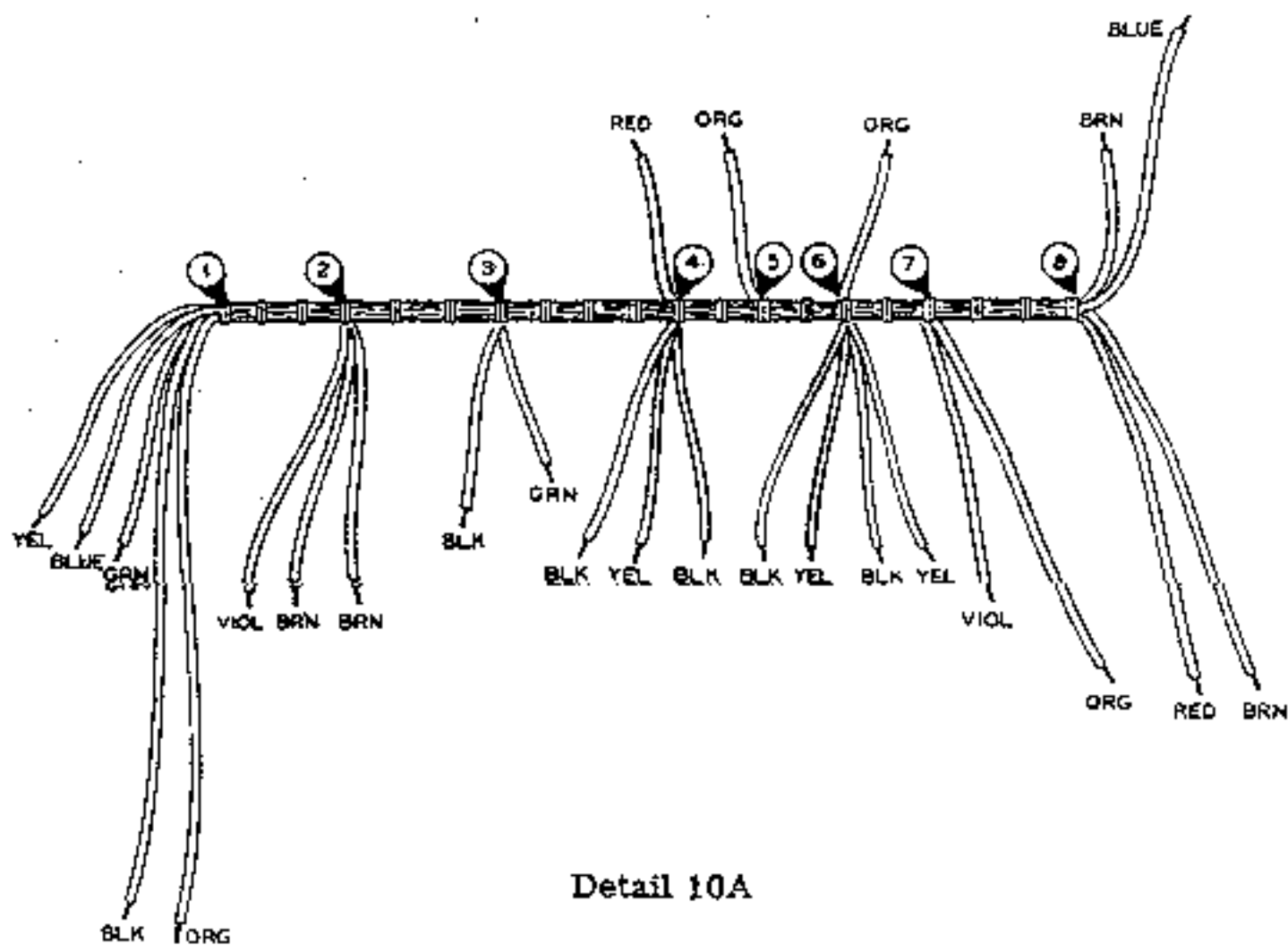

Detail 10A

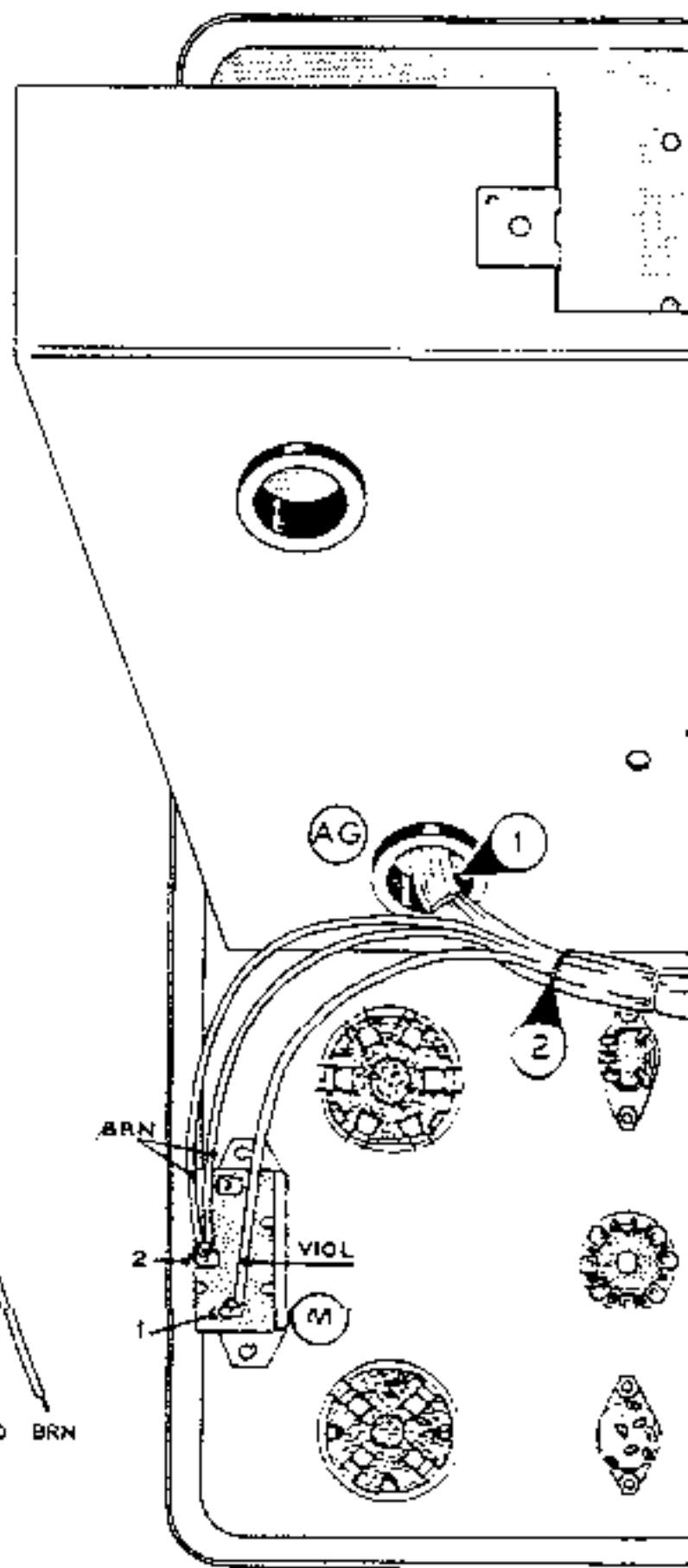

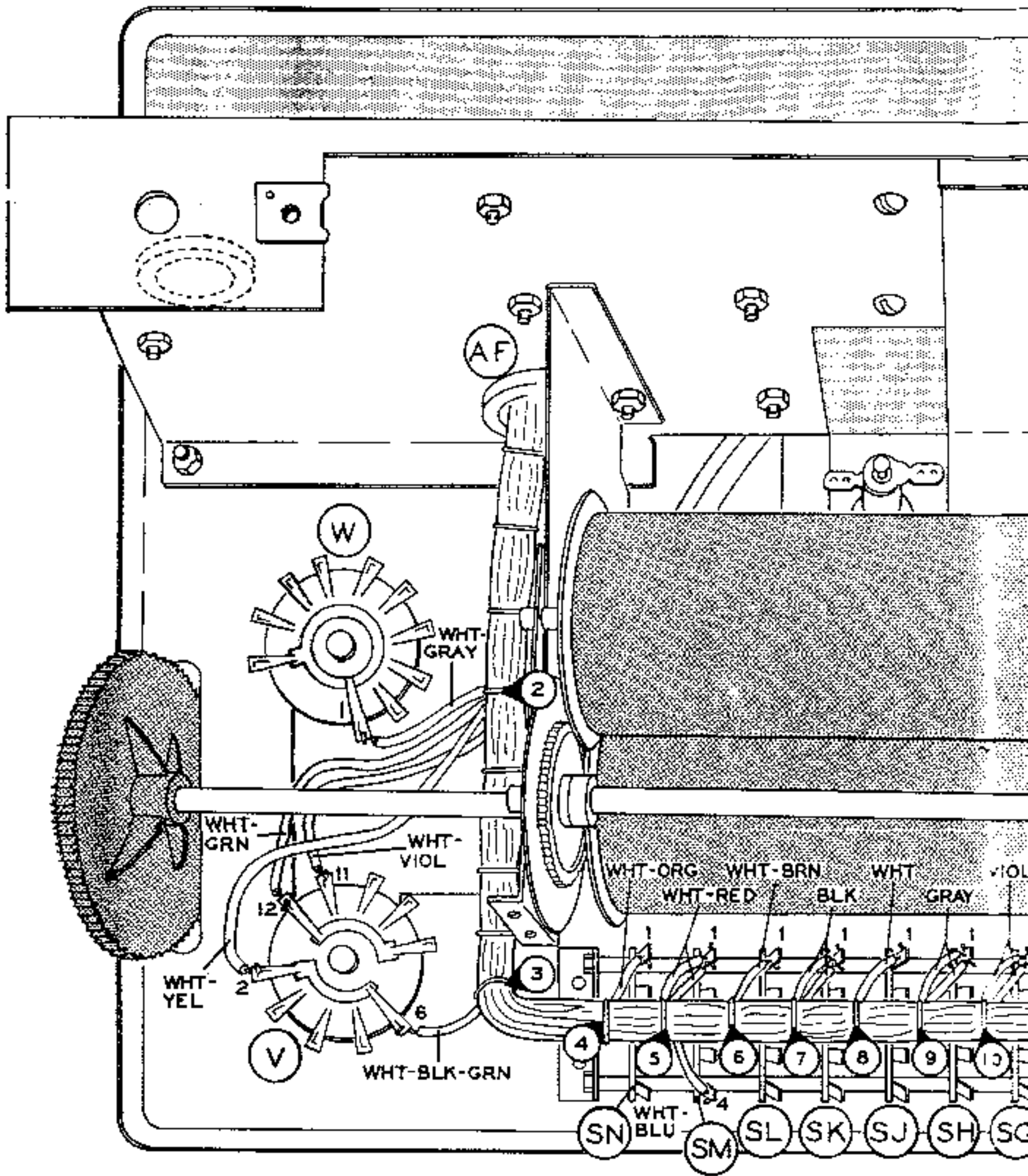

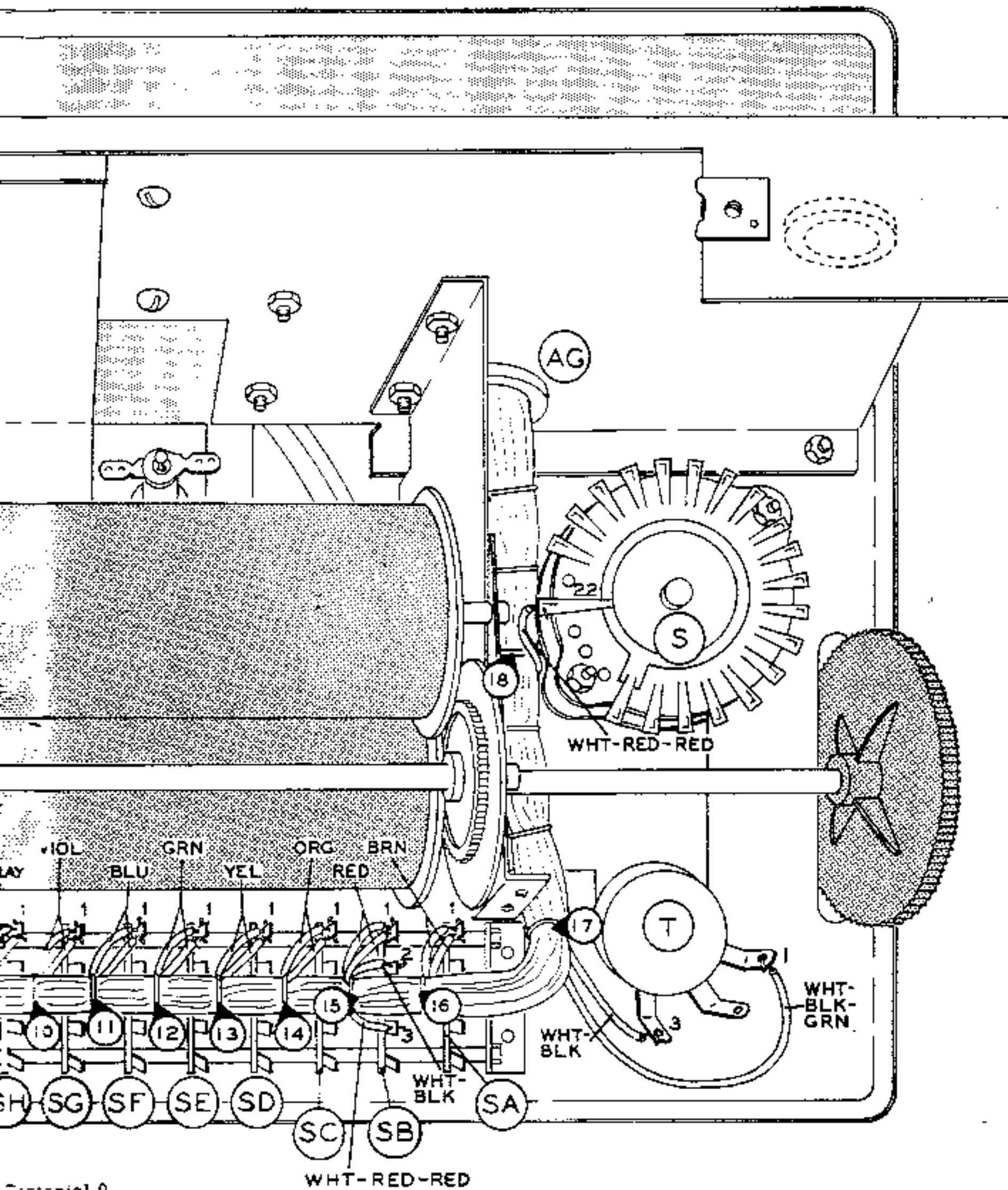
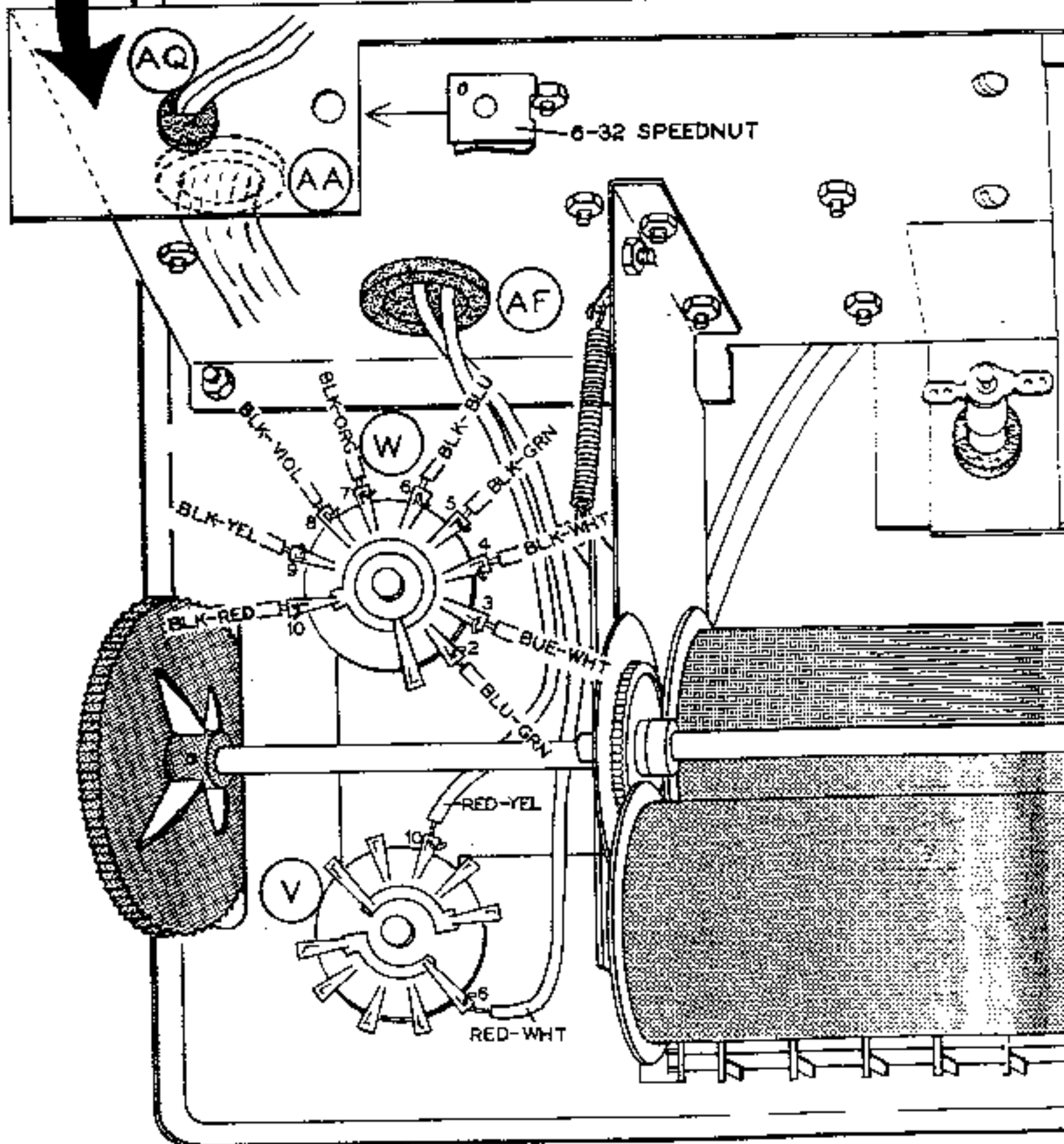
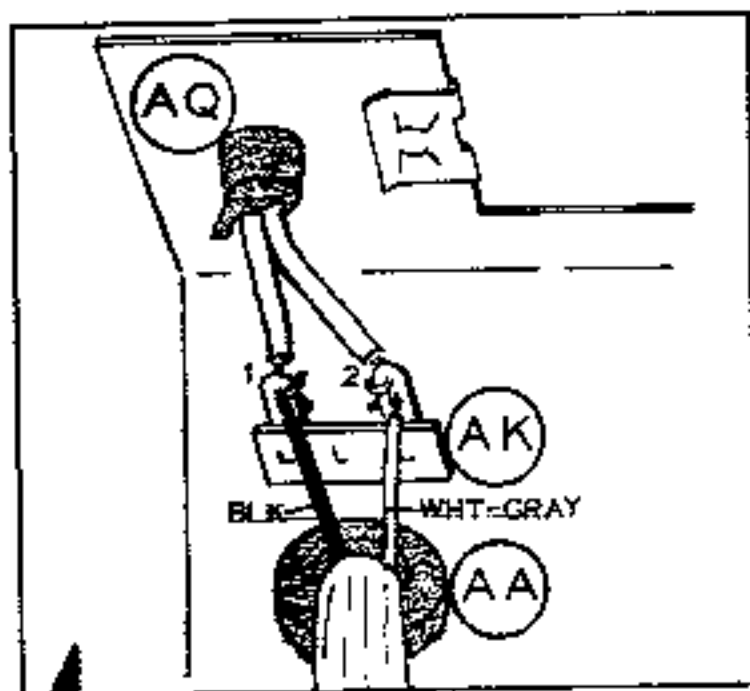
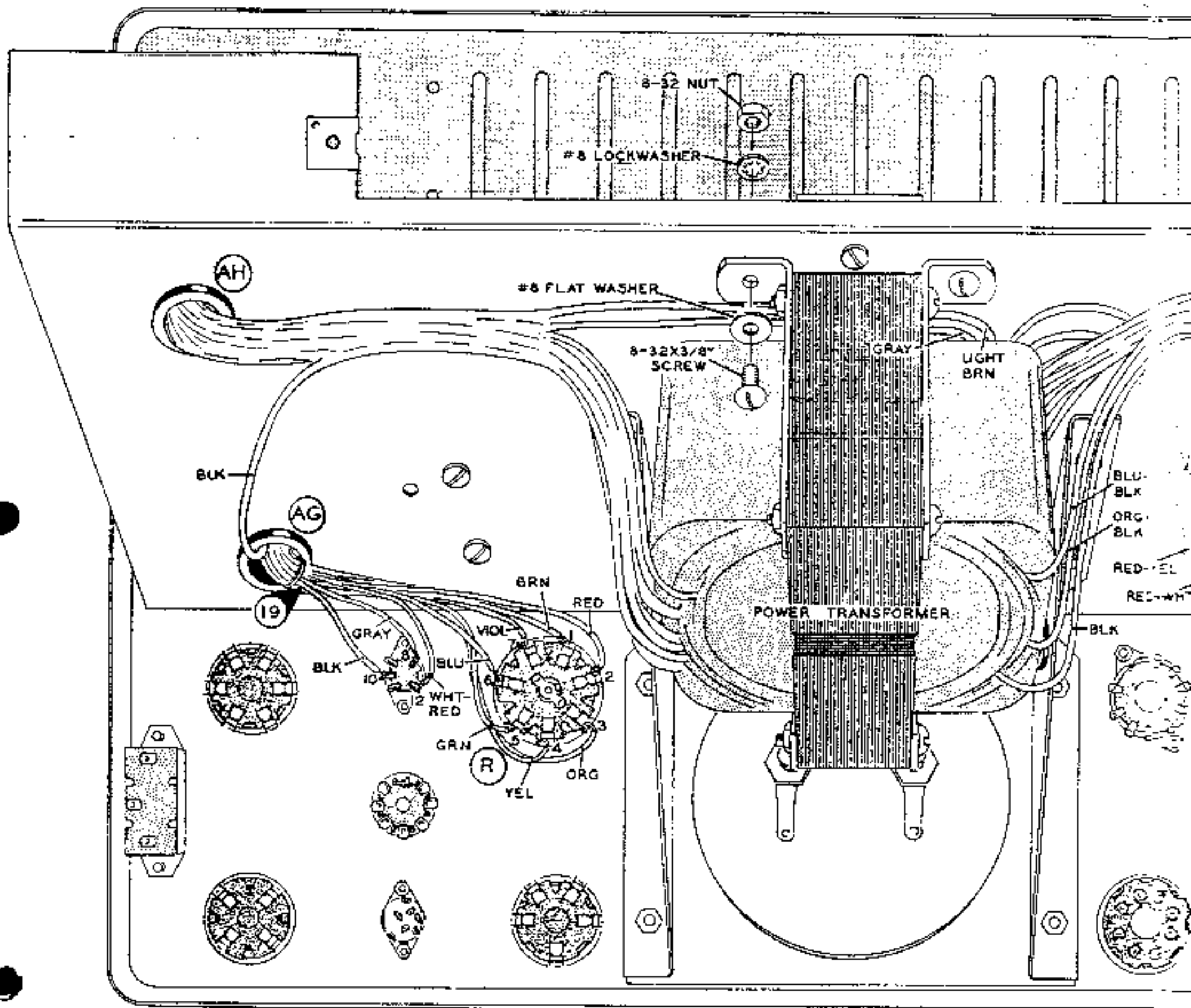
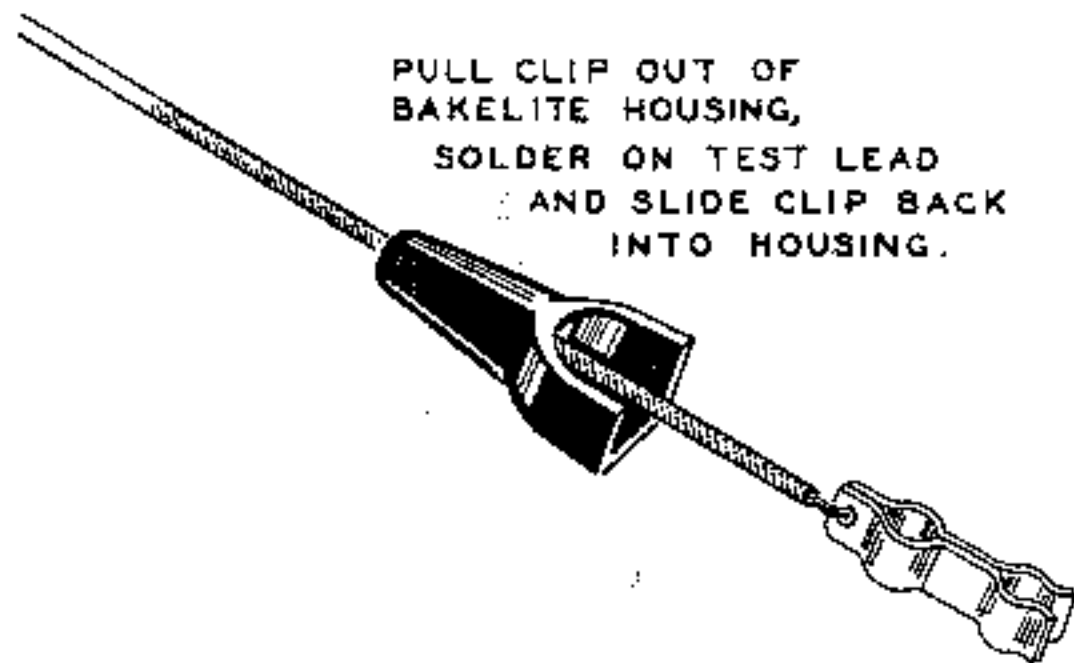
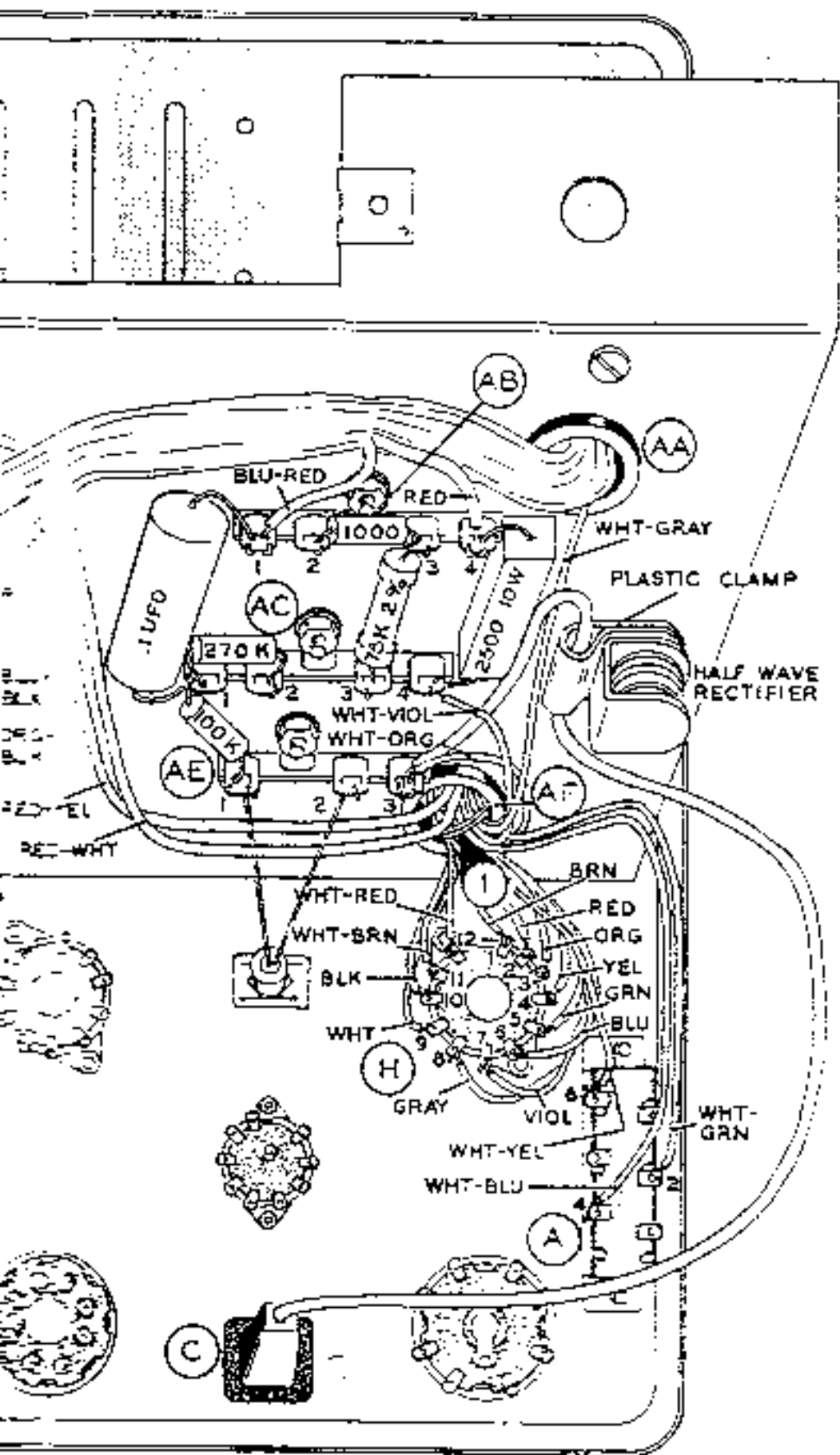

Diagram 9





Pictorial 11



PULL CLIP OUT OF
 BAKELITE HOUSING,
 SOLDER ON TEST LEAD
 AND SLIDE CLIP BACK
 INTO HOUSING.

Detail 11A

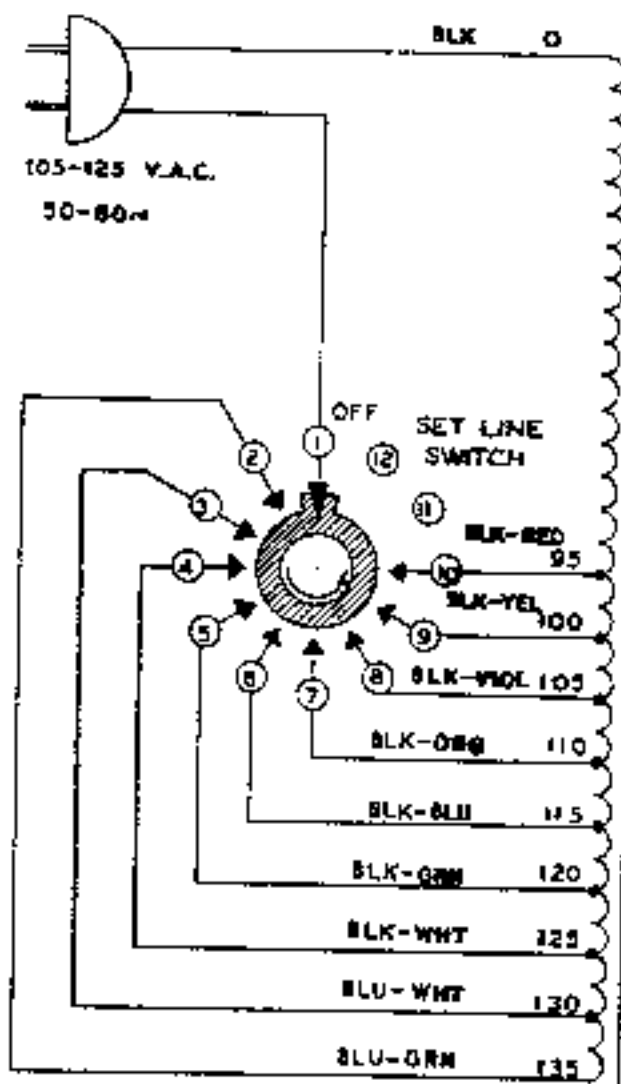

LINE AND FILAMENT SWITCHES
SHOWN IN "OFF" POSITION.

**SCHEMATIC OF THE
HEATHKIT
MODEL IT-21**

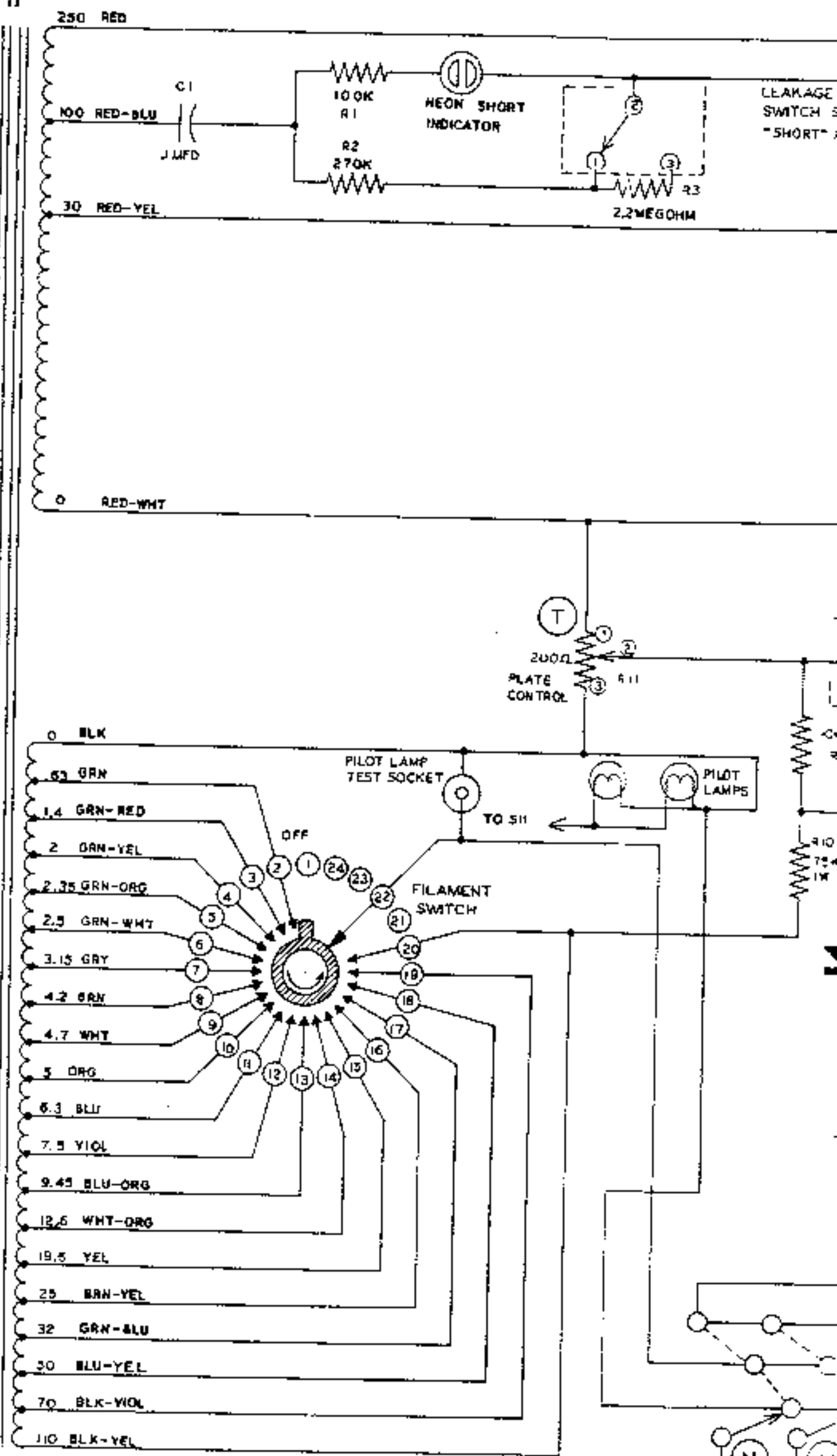

TO GRID CLIP (N)
TO P.N. NO. 12 (V)

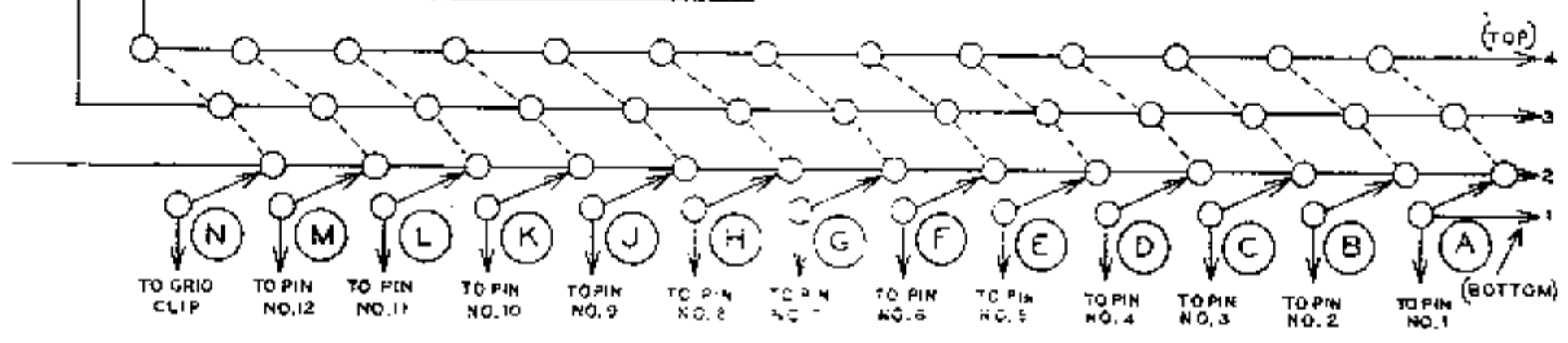
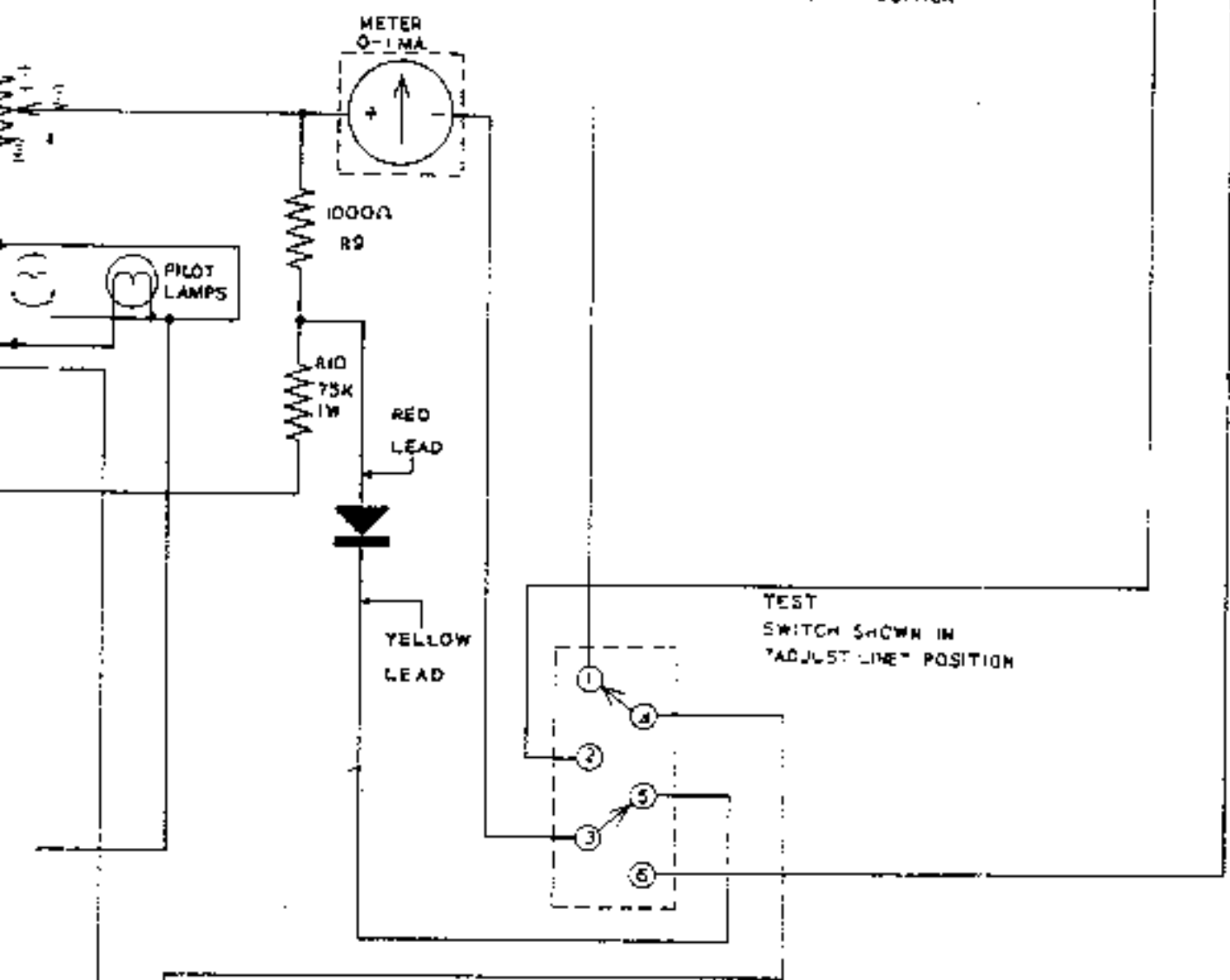
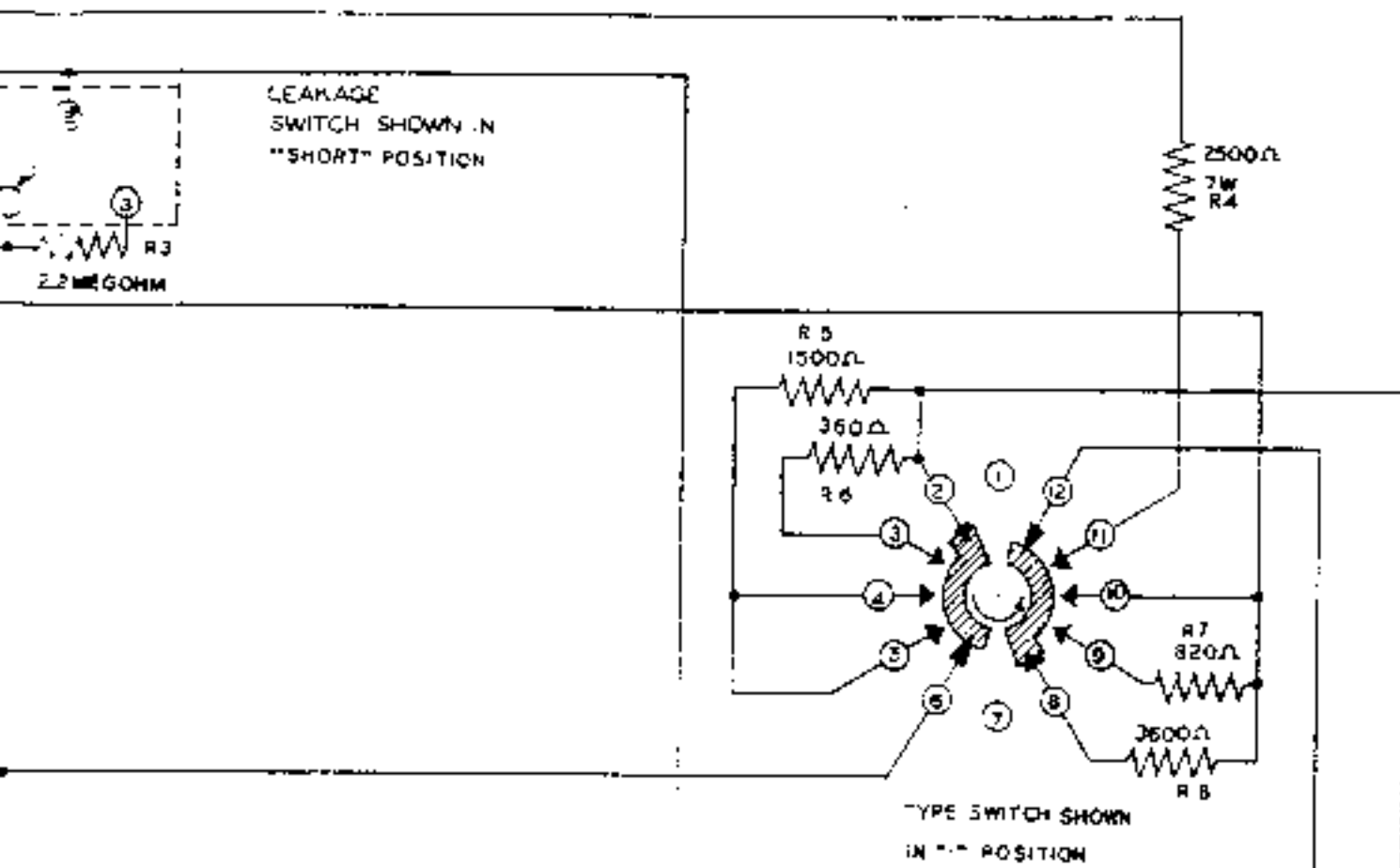

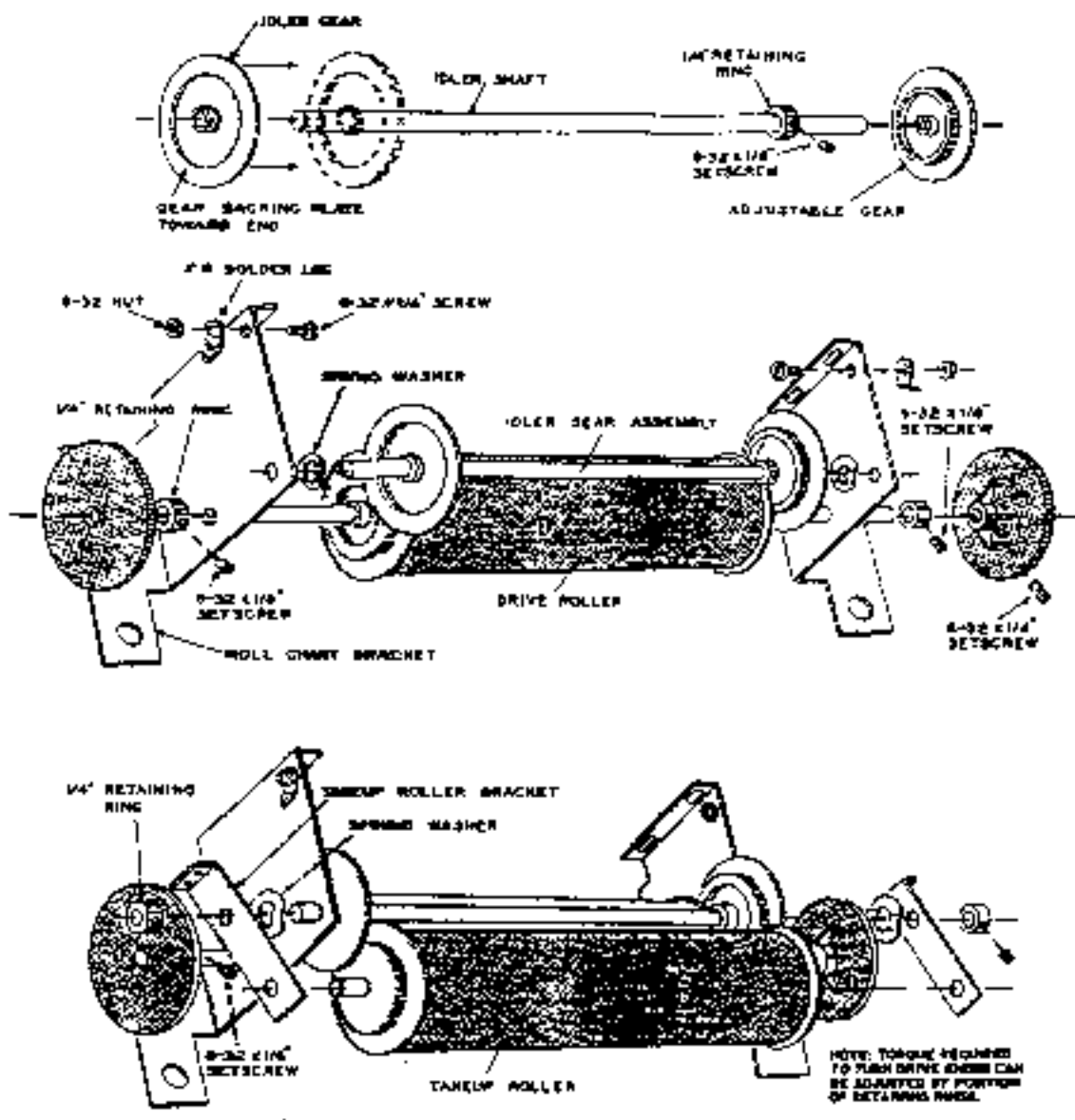

Detail 8A

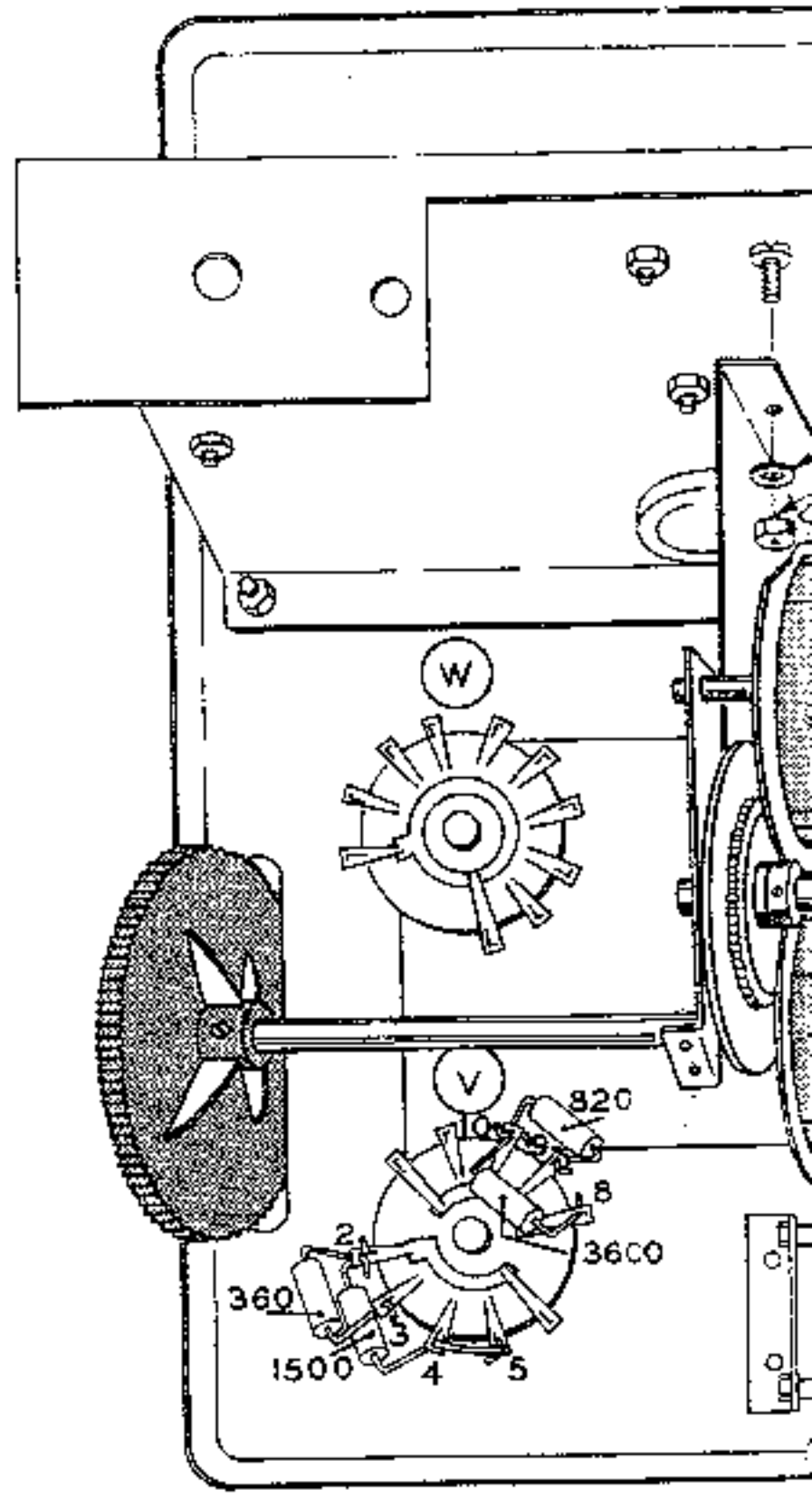

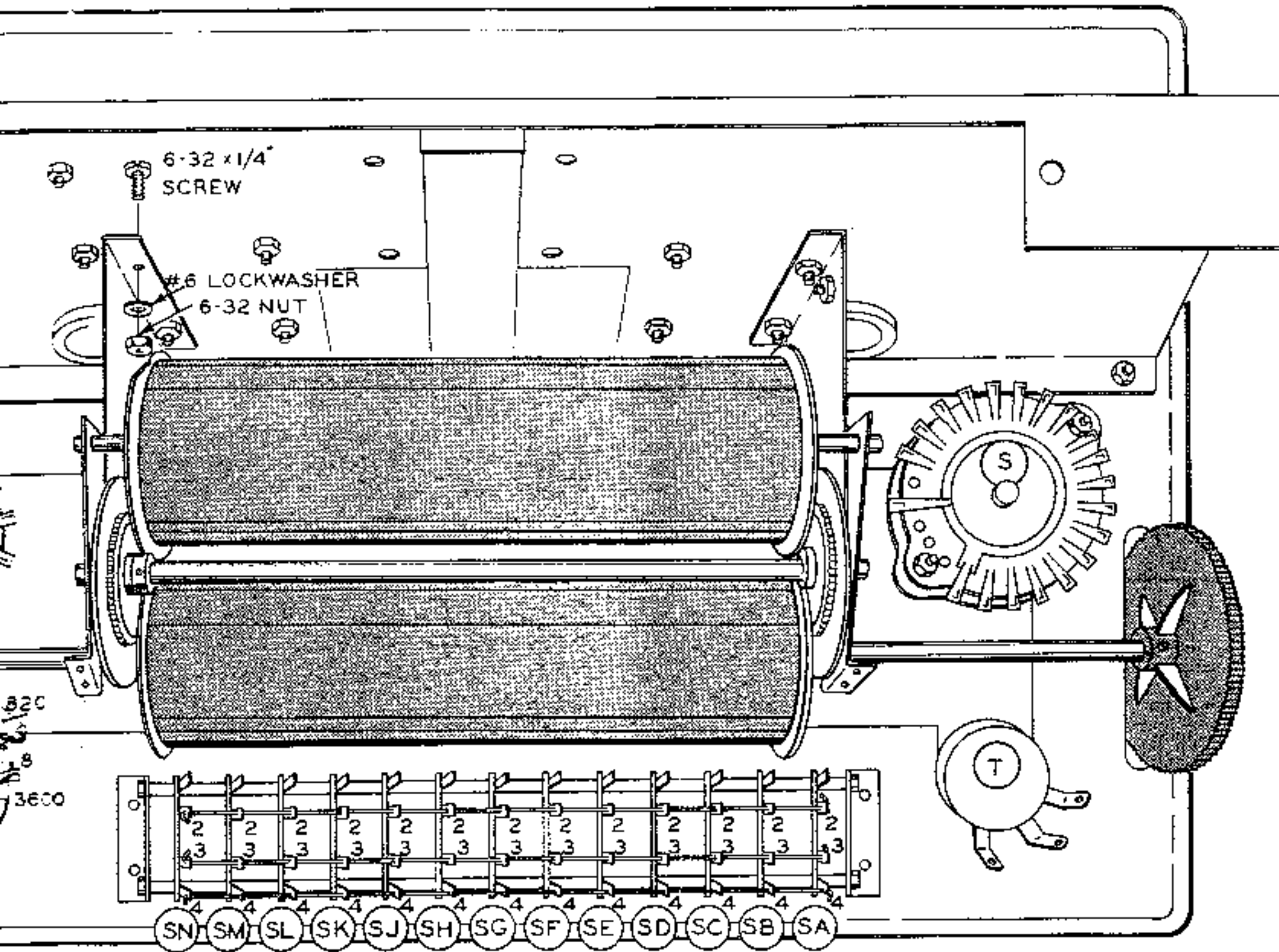

Pictorial 8

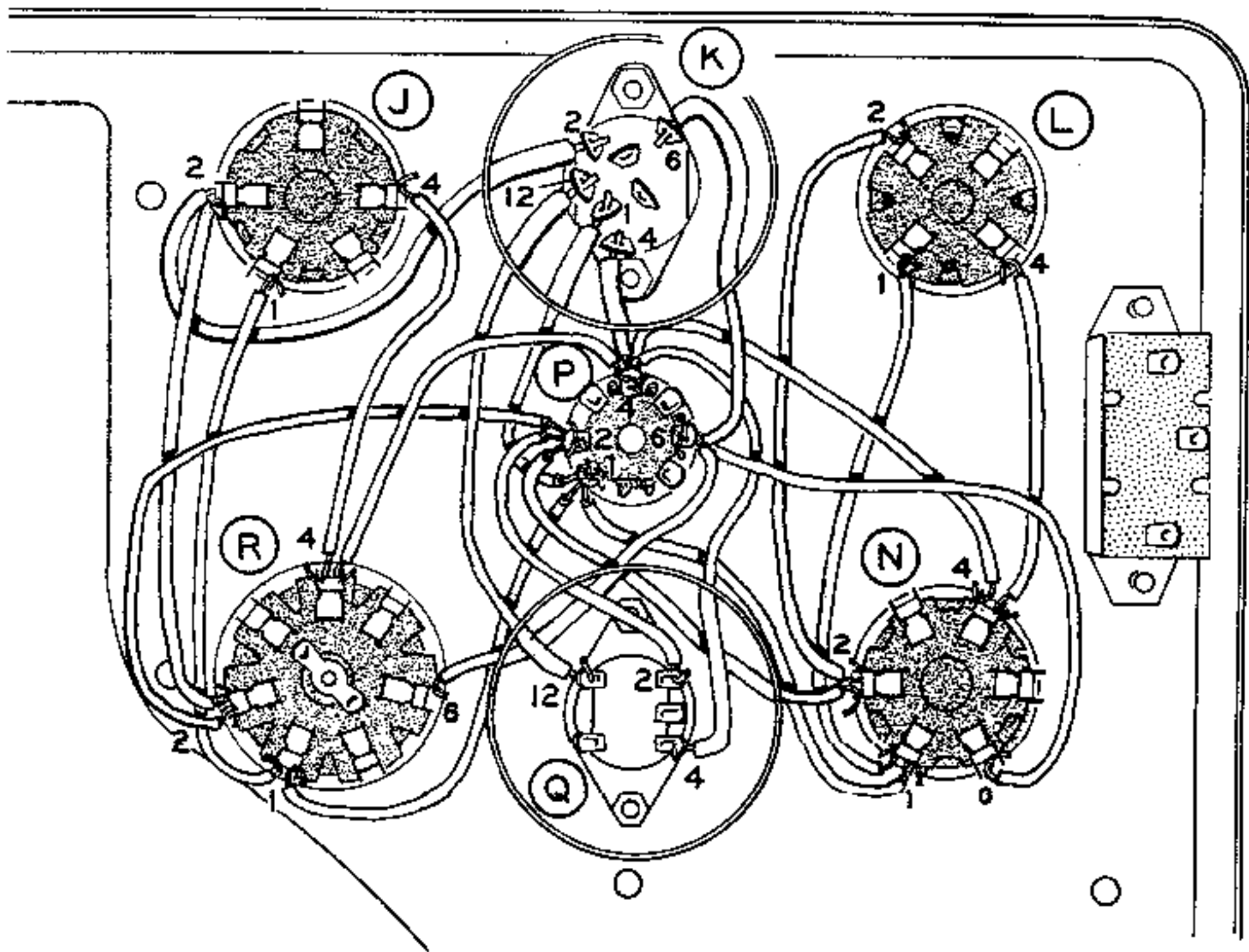

Pictorial 4

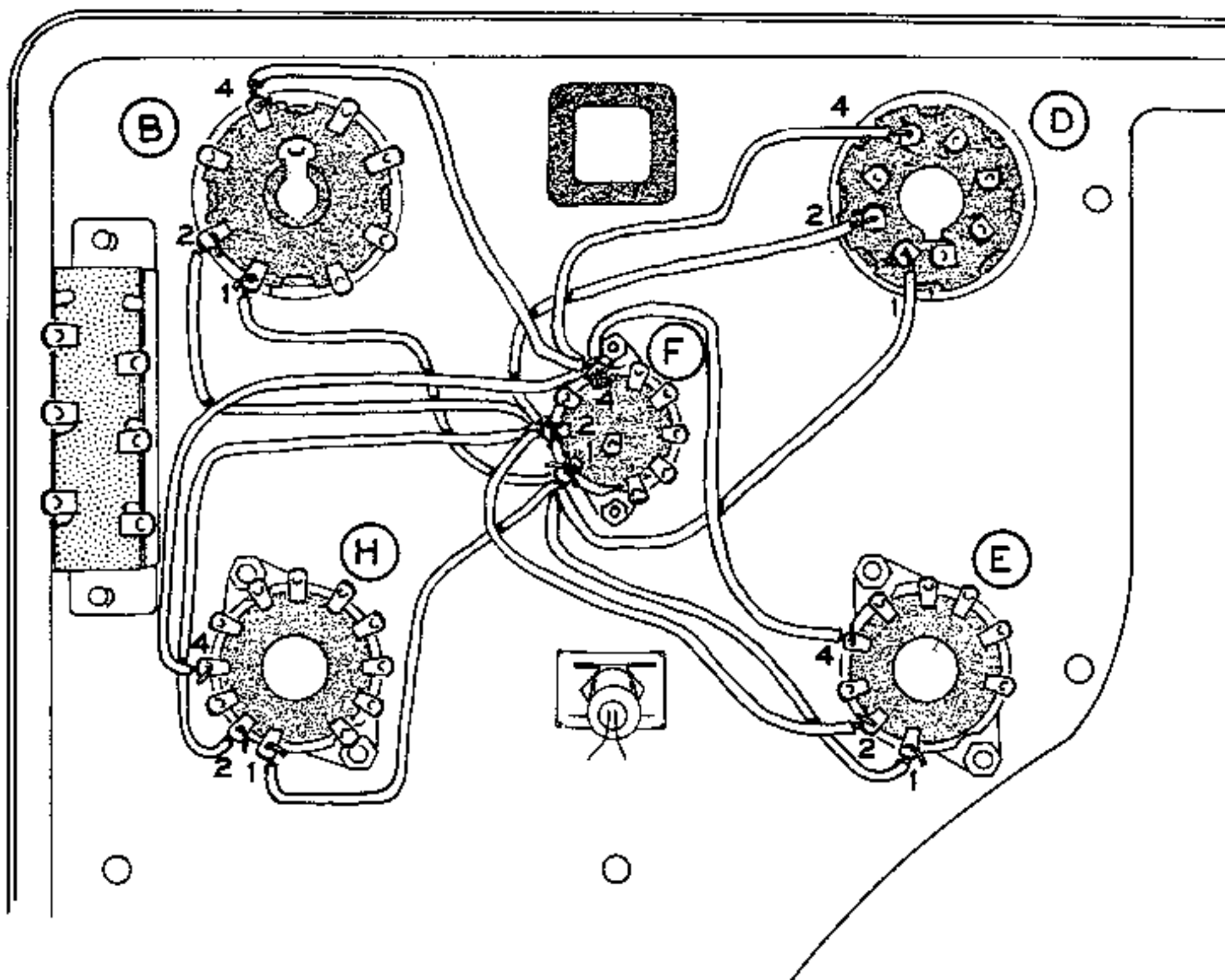

Pictorial 2

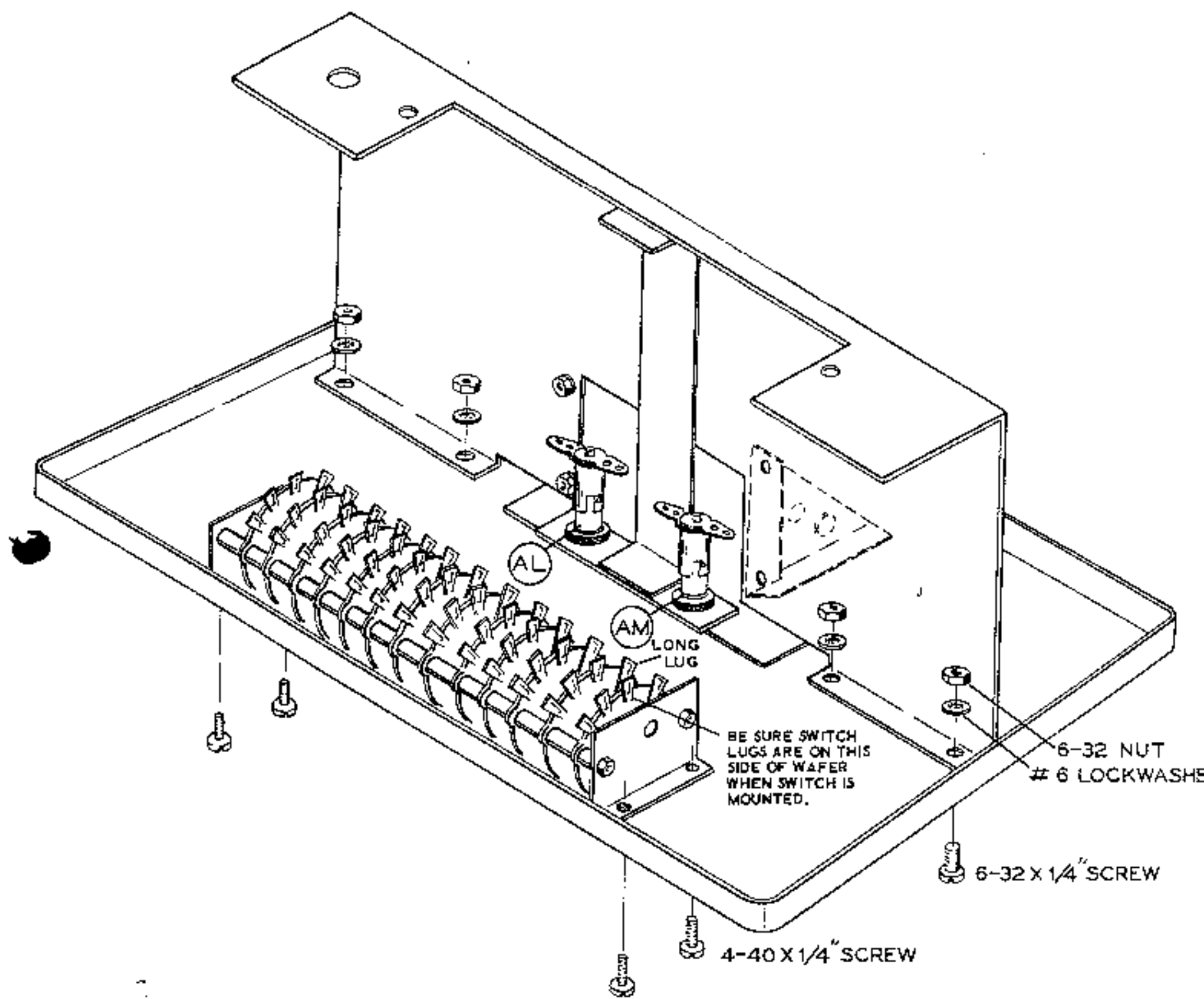

Pictorial 7