

# Assembly Manual

## Versatile 40V/3A Lab Power Supply

K-3206

**DICK SMITH**  
**ELECTRONICS**

ACN 000 908 716

# K I T

PLEASE READ DISCLAIMER CAREFULLY AS WE  
CAN ONLY GUARANTEE PARTS AND NOT THE  
LABOUR CONTENT YOU PROVIDE

Reproduced in part by arrangement with  
Electronics Australia, from their December  
1993 & January 1994 editions.

PLEASE READ: 'A Safety  
Guide To Mains Wiring and  
Handling' before assembling  
this kit.

*This new supply should handle all but the most specialized tasks on a home or professional workbench. Based on readily available components, it has full electrical and thermal overload protection, adjustable current limiting, dual meters, and can be used either as single or dual-tracking supply.*

In the August 1991 issue of Electronics Australia, they presented a 'mean, lean, recession-compatible' 18V/1A benchtop supply, which included what we felt were the essential features for a useful but low-cost unit. This turned out to be a very popular project.

It's a safe bet however, that there are a reasonable number of us that need a rather more elaborate supply, and are prepared to pay the associated premium — provided of course, that it still represents good value for money. Such a supply would need to have a higher output voltage and current capability and a wider range of features, while hopefully maintaining the simple construction techniques and cost-effective design of our original 18V/1A unit.

To achieve this end, we once again

took a careful look at just how such a supply is mostly used, and included features into the new design based on this knowledge — while keeping a close eye on the cost of the individual components.

Our final design bears little resemblance to the previous 18V/1A supply as it happens, and uses a larger case and power transformer, has meters for both voltage and current readings, sports two heatsinks on the rear panel, and uses a much larger circuit board and number of components.

Until you notice the additional '0V' binding post on the front panel, the unit looks like a reasonably conventional 40V power supply with variable current limiting. It's the combination of this connector and the current limiting con-

trol that sets the design apart from all previous efforts, since now we effectively have a dual-tracking supply *with* fully variable current limiting.

These two features have been quite mutually exclusive in the past, where single-ended supplies tended to offer variable current limiting, and dual-tracking units would have a fixed maximum

### FEATURES

- Single or dual tracking operation
- Variable current limiting in two ranges
- Individual Volts and Amps meters
- Over-temperature shutdown
- Output load switching
- Current setting switch
- Fully floating circuit with separate earth terminal
- Dropout (output ripple) indicator

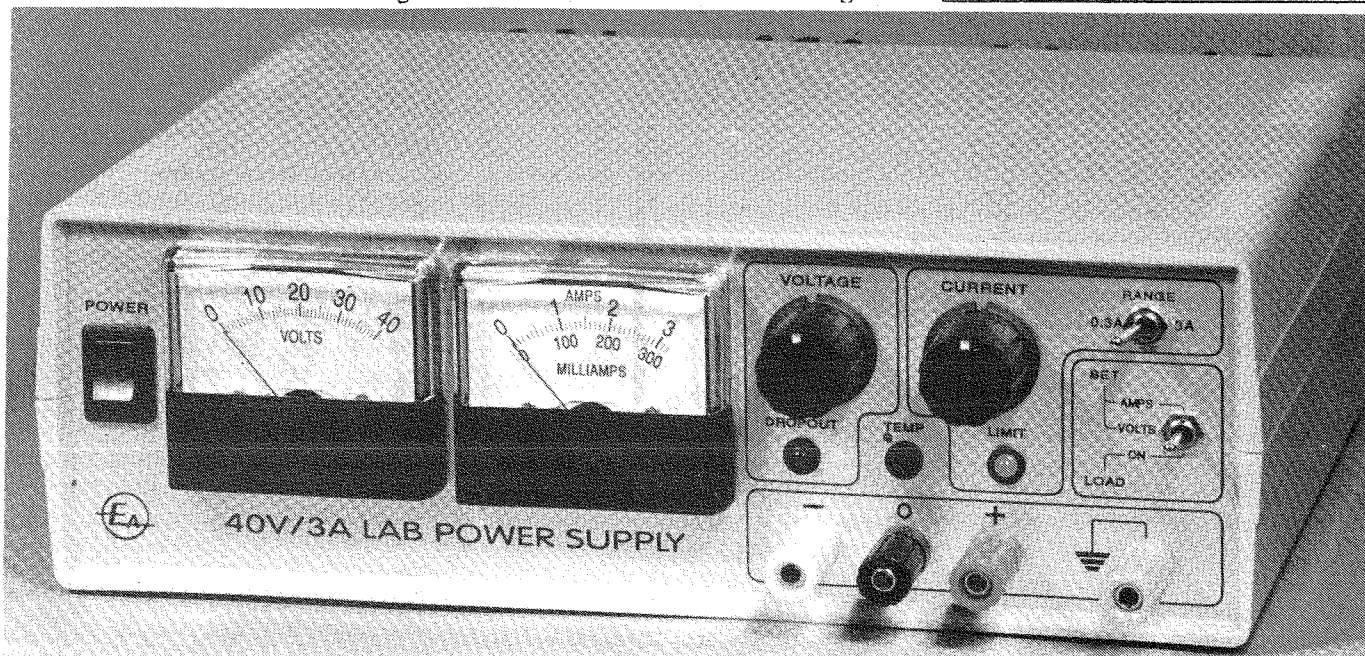

current limit to protect the supply itself. One reason for this shortcoming in dual-tracking supplies is the difficulty in deriving a simple circuit which is able to both monitor and shut-down the current in each half of the supply, yet can be adjusted by a single 'dual tracking' current limit control.

In our new circuit however, we've come up with a relatively straightforward arrangement using just three op-amps, which monitors the current in both sections of the supply, produces an output proportional to the *greater* of the two, then limits the supply's output in response to this level when compared to a preset current limit control. And as a bonus, its output can also drive the supply's current meter, which will then display whichever current is greater.

In practice though, both the meter readings and current limiting action are just as you would expect from a conventional supply, and you're not aware that the circuit is picking the higher figure. Note that the two currents will be almost identical when the unit is used as a single-ended or dual-tracking supply, and one will be at zero when only one half of the supply is used — so in all cases, both the meter and the limiting circuit are responding to a realistic level.

The end result is a very flexible arrangement, allowing the supply to perform a wide range of tasks with a minimum number of controls.

As you can see from the summary panel it offers both a host of useful features and impressive performance, and by our reckoning, represents excellent value for money. To be optimistic about Australia's economy, we might present this project as a mean, not so lean, recovery-compatible power supply...

## Circuit description

As you can see from the schematic, we've used a number of op-amps to perform the supply's various functions, rather than calling on one or more dedicated regulator ICs (such as the LM723) as used in the previous circuits. This allows for a more flexible design approach and poses few restrictions on the unit's performance or features.

Despite the reasonably high component count though, the circuit itself is quite straightforward and can be divided into several sections, with each op-amp and its associated components performing quite a distinct function.

In general terms, IC1A (with Q1 and Q2) forms the positive regulator stage, and IC1B 'measures' its output current across R4 or R5, while IC2A (with Q3 and Q4) and IC2B (with R14 and R15) perform the same functions for the negative supply.

Other than that, IC3 acts as a temperature detector, IC4A senses the overall output current, and IC4b monitors the supply's output terminals for excessive ripple.

In more detail, power for the supply is derived from the 15-0-15 volt secondary winding of TX1, and full-wave rectified by the encapsulated diode bridge BR1 producing a raw supply of about +/- 21V (referenced to 0V or ground). This in turn is filtered by reservoir capacitors C1 (positive supply) and C2 (negative), then applied to both the main circuitry and the 12V regulators IC5 and IC6 — these provide +/-12V rails for the low-powered circuitry.

The main positive regulator circuit is based around IC1A, and can be considered as a standard non-inverting amplifier, with its output current capability boosted by the darlington pair formed by Q1 and Q2. This stage has a gain of two, as set by the combination of R1 and R2, includes both the darlington pair and resistors R4 to R5 in its feedback loop, and has its input connected to the wiper of the Voltage pot, RV1.

Note that to assist in understanding and faultfinding the circuit, we've included a range of typical voltage readings on the schematic itself. These are for an output voltage setting of +/-10V (20V overall), and correspond to a 1A output current — which would be flowing into a load of 10 ohms per side (or 20 ohms overall) connected via the output switch SW2.

If we also assume for the moment that the voltage across RV1 is constant (at around 10.5V) and the wiper is set to a level of 5V as shown, then the positive regulator's output will be at 10V since the op-amp will drive its output so as to make the voltage at its two inputs (pins 5 and 6) at the same level (in this case, 5V). And of course if the output voltage is say tending to fall, the reduced level at the op-amp's inverting input (pin 6) will cause its output to rise, thereby increasing the drive to Q1 and Q2 and correcting the fall.

The remaining parts of this stage include C4 restrict the overall bandwidth, and power supply bypass components R3, C8 and C9.

R3 has been included to reduce the overall voltage applied to IC1 to a safe level of around 32V when the supply is unloaded, where the raw positive rail rises to about 22V. Without the small drop induced by the 680 ohm resistor, the voltage across the TL072 would be around 34V, which is uncomfortably

close to the IC's maximum supply rating of 36V.

Next in line is the current sensing stage, based around the differential amplifier IC1B, which monitors the voltage across the regulator's current sensing resistors R4 or R5/R6 as selected by the current range switch SW1. In this circuit the two input networks (R16 to R19 and RV2) set the *differential* gain to 4.5 and the *common mode* gain to near zero, so that voltage levels common to both inputs (the supply's output voltage) are ignored and only the voltage drop across the sensing resistors (proportional to the supply's output current) will be amplified.

In the situation depicted in the schematic, R5 and R6 are bypassed by SW1A (shown in the 3A position), which leaves R4 as the sensing resistor. As is indicated by the voltage levels, the 1A current flowing into the load induces a drop of 0.22V across R4, which is then amplified by IC1B to produce an output level of 1V at the cathode of D3 — more about this diode in a moment.

As you would also expect, when the load is disconnected and the voltage drop across R4 falls to zero, the differential amp's output will drive to 0V — in short, we have a current-to-voltage converter with floating inputs, where in this case, the output rises at a rate of 1V per amp. This then drives the current reading meter M1 (via RV6 and R32), and the following current limiting stage based around IC4A.

When we wish the supply to have a current reading and limiting range of 0.3A rather than 3A as above, SW1 is moved to the 0.3A position where R4 is bypassed and R5 and R6 are now in circuit. If the parallel combination of these resistors had the value of 2.2 ohms, we would then have a theoretical output rate of 1V per 100mA from the differential amp — the required ten-fold increase in sensitivity.

In practice however, we have made up the required value from the parallel combination of a 2.7 ohm resistor and a 12 ohm 'padding' resistor, where the latter is used to adjust the overall value so that we have *exactly* ten times the resistance that was present when SW1 is in the 3A position.

Since the resistors involved won't precisely match their rated value, and SW1 and its associated wiring will effectively add resistance to R4, we need to adjust one of the sensing resistors so that both the current readings and limiting settings make sense between ranges.

While our prototype supply showed only a small error between current ranges with just a 2.2 ohm resistor installed (rather than the parallel pair), we felt that the variables involved would surely work against some constructors, and the trimming scheme was required. Fortunately, the adjustment process itself is quite straightforward (see 'Setting up,

## SPECIFICATIONS

Output voltage: 0 to 40V (0 to +/-20V)  
Output current: Up to 3.5A (see Fig.1)  
Current limit: Approx 30mA to 3.5A in two ranges  
Load regulation: Better than 0.2% at 3A output current  
Output ripple: Less than 5mV at 3A output current  
Overload duration: Indefinite

testing' in part 2).

The remaining components in the differential current amp are the input balancing trimpot RV2, and the output isolating diode D3 — which allows two of these stages to control a single output line in an OR fashion — as you've probably noticed, the negative supply based around IC2A drives an identical current sensing amp, formed around IC2B, which despite having negative rather than positive voltages at its inputs, operates in the same manner.

While a first sight this ORing scheme appears quite simple — since two diodes alone form an OR gate — its actual operation is quite subtle. Considering the action of IC1B with the voltages as shown on the circuit, you can see that any fall in the final output voltage (at the cathode of D3) will be automatically corrected by the negative feedback action via R19 — note that D3 is always forward biased in this scenario.

However, if the final output is tending to rise (say, pulled high from some other drive source), the negative feedback action will force the op-amp's output (pin 1) to drive low, in an effort to correct the situation. Diode D3 then becomes reverse biased, and the op-amp is no longer driving the output, which continues to rise. As you've no doubt gathered, this 'other' drive source is in fact the output from the negative supply's current sensing amp (IC2B), which is (say) responding to an increase in load current.

Thus we have a situation where the section of the supply (that is, positive or negative) which is handling the most output current will be driving the current meter and limiting circuits. With the voltage levels shown on the schematic, the negative supply is handling slightly less current than the positive, and consequently, the output of IC2B (pin 7) has driven low. Of course, if the output current was flowing *directly* from the positive to negative output terminals, this would mean that the negative current sensing circuit has a slightly lower sensitivity to that of the positive current sensor.

By the way, R24 has been included to provide a standing bias current through whichever diode is conducting (D3 or D4), so that it cannot become reversed biased when the output voltage is close to zero.

The current sensing output is applied to the metering circuit (M1) as mentioned, and the current limit detector based around IC4A. The best way to think of this stage is as a simple comparator, where a preset level is applied to the non-inverting input from RV7 (Current) and our voltage representing the supply's output current is applied to the inverting input — if the latter exceeds the former, the op-amp's output will swing low.

With the voltages as shown on the cir-

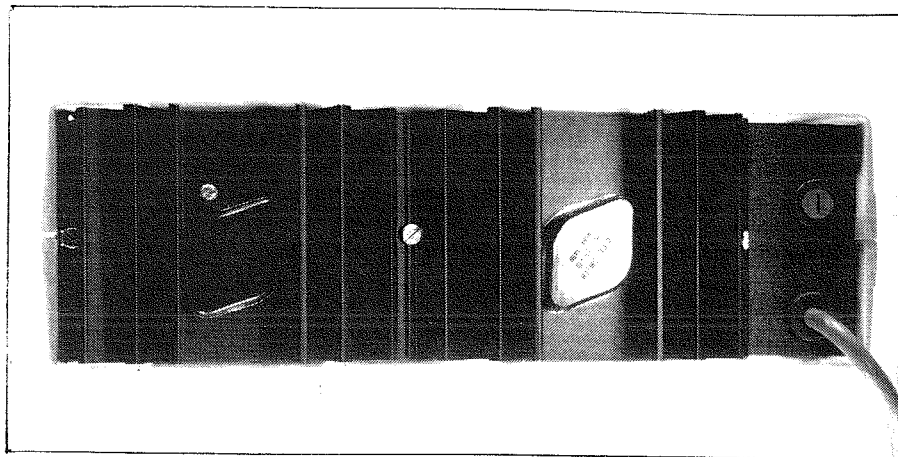

**The rear panel holds the heatsinks for the series-pass transistors Q1 and Q4, plus the mains fuseholder and the mains cord - note the plastic insulating caps fitted to the transistors.**

cuit, the Current pot (RV7) is set to detect a level corresponding to 2A (2V) and the current detector is generating a 1V level in response to the supply's output current of 1A. In this situation, the output of IC4A is at a high level (around 11V), Q8 is biased off via R33, and the limiting indicator LED2 is off. And most importantly, the high level at pin 7 of IC4A is passed to the Voltage pot RV1, via isolating diode D1 — providing the supply's overall reference voltage (note the connection at point 'A' on the schematic).

If the supply's output current rises above 2A however, the level presented at IC4A's inverting input will exceed that at its non-inverting input (as set by RV7), and its output will swing low. This then biases Q8 on via R33, which in turn activates LED2 via limiting resistor R34, indicating that current limiting is taking place. As you expect, the fall at the output of IC4A will also cause a similar drop in voltage across RV1, which reduces the regulator circuit's source voltage and causes the supply's output level to fall.

This in turn reduces the current flowing into the load and the voltage level applied to IC4A's inverting input, which halts the downward trend at the op-amp's output, and so on. Thus the whole feedback process causes the output voltage to balance at a point where our

preset current (set by RV7) is flowing into the load.

Despite this seemingly convoluted process, the comparator stabilises quickly and smoothly, as IC4A has its gain set to 100 by R37 and R35, and the transient response is tailored by feedback components C16 and R36.

Any voltage changes at the wiper of RV1 also effect the *negative* regulator circuit, as you'd expect. This circuit is based around IC2A, and acts as an *inverting* amplifier with a gain of two (rather than a non-inverting stage as for the positive regulator circuit). So for a source voltage of 5V, the negative regulator will produce an output of -10V.

In this circuit the gain is set by the combination of resistors R7 to R9, the bandwidth restricted by capacitor C5, and the output current capability boosted by PNP transistors Q3 and Q4. Other than that, R11 restricts the supply voltage as before, C10 and C11 bypass the IC2A's supply pins, and R10 locks the non-inverting input (pin 3) to ground. Finally, D2 has been included to prevent the source voltage swinging below -0.6V — which won't occur in normal circumstances, by the way.

The final parts of the supply's circuit concern the output ripple detector based on IC4B, and the temperature cutout stage formed around IC3. The temperature sensing circuit uses IC3 as a conventional comparator, where a reference voltage is applied to the inverting input (pin 2) via a voltage divider formed by R26, R27 and RV5, and the inverting input (pin 3) monitors the voltage across transistors Q5 and Q6.

These PNP flat-pack power transistors (BD140's) are effectively connected as diodes, where the current supplied by R25 flows through their base-emitter junctions to ground.

And as you would expect from the natural temperature response of the silicon junctions, the voltage drop across the base-emitter connections ( $V_{be}$ ) will fall as the transistors become hotter. Note that we've also bridged the base-

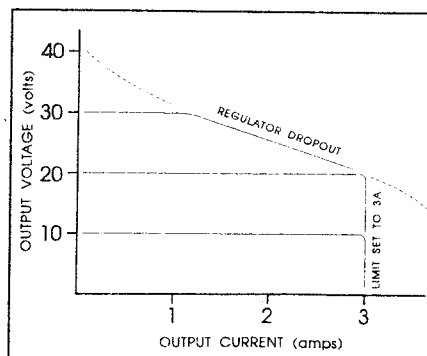

**Fig. 1: The supply's output current capability at voltage settings of 10, 20 and 30 volts, with the current limit set to 3A.**

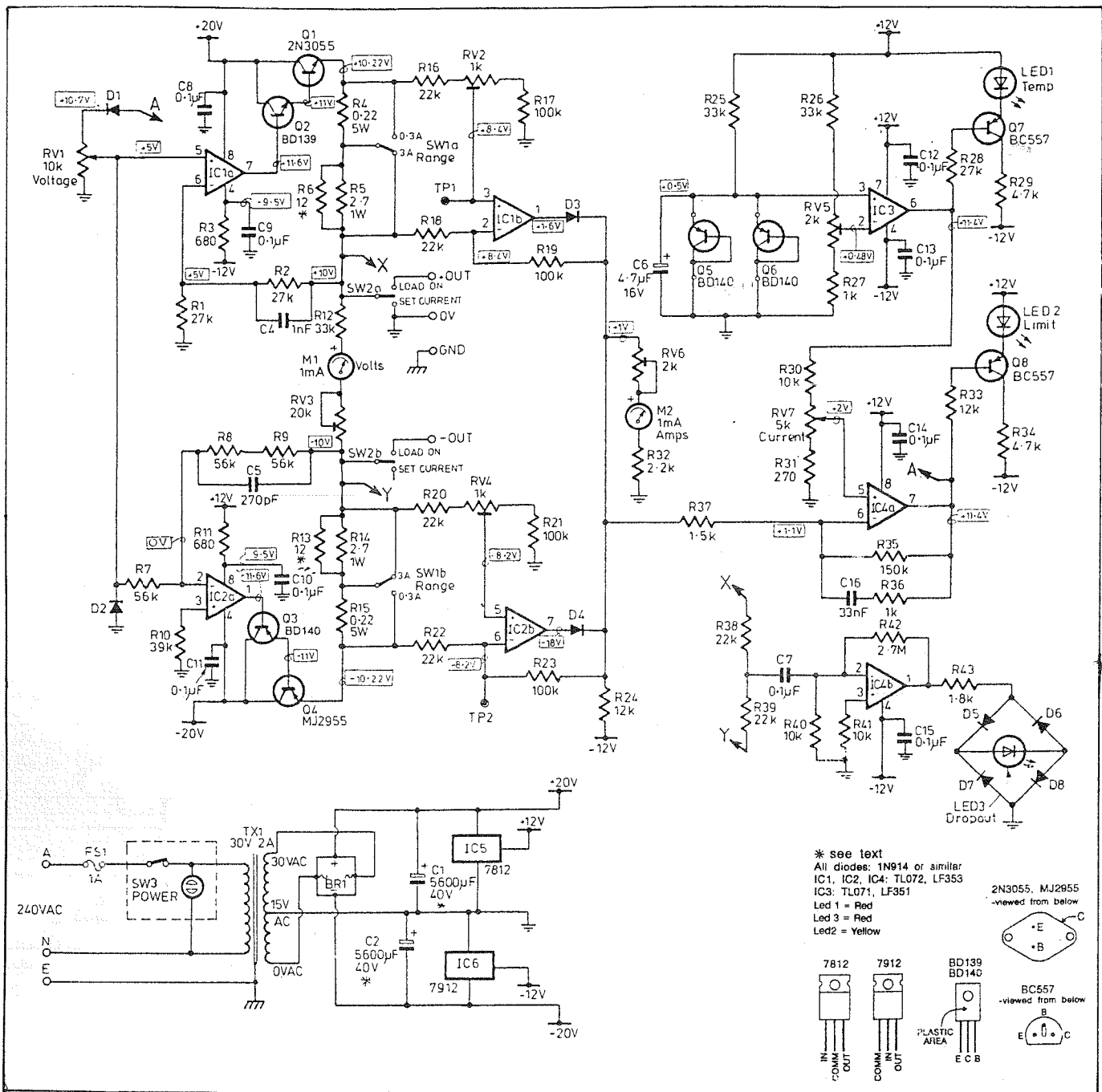

The supply's overall schematic diagram. The voltage readings shown on the circuit correspond to an output voltage of +/-10V (20V overall), and a load current of 1A.

collector legs on each device, and included a filter capacitor (C6) across the junctions.

Referring again to the voltage levels shown on the circuit, you can see that if the combined voltage drop across Q5 and Q6 falls below 0.48V then the output of IC3 will swing low, and LED1 will illuminate via Q7 — indicating a temperature shutdown.

Since the two B-E junctions are connected in parallel, the hottest transistor will dominate the voltage drop in a natural OR fashion, and that device will trigger the shutdown. In the final supply, Q7 is attached to bridge rectifier BR1 via a small heatsink bracket, and Q6 is bolted to Q1's heatsink.

The first idea here is to protect both the bridge rectifier and power transformer from thermal failure, by sensing

the rectifier's temperature — which will increase as the transformer's secondary current rises in response to heavier load conditions.

So over a period of time, the rectifier's dissipation will reflect that of the transformer, allowing protection of both components with one sensor.

Note that if the supply is delivering a high current at a moderate output voltage, the series pass transistors have a low voltage across their collector-emitter junctions and therefore dissipate little power.

For example, if the positive regulator is supplying 3A at an output level of 10V, the raw supply rail will have dropped to around 12V, leaving just 2V across Q1 and a resulting dissipation of only 6W — the heatsink will be relatively cool, but both the

rectifier and (eventually) the transformer become quite hot.

On the other hand, if the regulator is delivering only half of that current (1.5A) into say a short circuit, the full supply rail (around 20V at this current) is impressed across Q1, forcing it to dissipate a much higher power level of about 30W — in this case, the rectifier and transformer remain relatively cool, but the heatsink becomes hot.

So as you've no doubt gathered, the second temperature sensor attached to Q1's heatsink is intended to protect the series-pass transistors against thermal failure. While the temperature of the negative regulator's pass transistor (Q4) is not sensed directly, its dissipation will be very close to that of Q1 in virtually all circumstances.

The actual temperature shutdown ac-

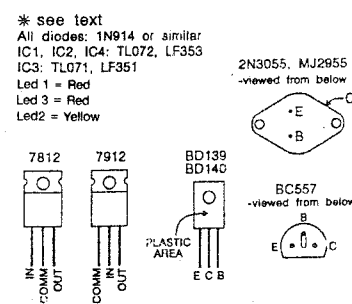

tion occurs as the output of IC3 (pin 6) swings negative (to around -11V), reversing the polarity of the voltage across the 'current set' voltage divider — R30, RV7 and R31. If RV7 is normally presenting IC4A (pin 5) with a reference voltage of say 2V, as shown on the schematic, this will immediately swing to about -2V as the divider's source voltage from IC3 swings negative. This in turn will cause the output of IC4A to also swing negative by its normal comparator action, which removes the source voltage from RV1 and reduces the supply's output level to zero.

The final section of the supply's circuit is the output ripple (dropout) detector based around IC4B, which is effectively configured as high gain dual-input amplifier. This senses the output of the negative and positive regulators via R38 and R39 respectively, isolates any AC component (such as 100Hz ripple) through high-pass filter C7 and R40, and amplifies the remaining signals by a factor of around 120 — as set by the combination of R38/R39 and R42.

This amplified signal then drives LED3, via the current limiting resistor R43 and a full-wave rectifier formed by D5 to D8, which ensures that both positive-going and negative-going swings are passed to the LED.

So in practice, if the supply's output ripple exceeds a level of about 30mV, there will be sufficient voltage at the output of IC4B to overcome the forward voltage drop of the rectifying diodes and LED3. The LED will then il-

luminates, indicating a dropout condition — that is, one (or both) of the regulators have run out of voltage headroom, allowing ripple from the raw supply rails to pass to the output terminals.

So that's it for the various stages in the supply's circuit. The final regulated outputs are passed to the load switch SW2, which isolates the load in the 'set volts' position, connects the load when 'load on' is selected, and shorts the positive output to 0V in the 'set current' position so the maximum output current can be set in advance.

The voltage meter (M1) and its associated resistors (R12 and RV3) are tied between the supply's positive and negative outputs, and will therefore respond to changes in the unit's overall output voltage.

### Construction

Most constructors will find putting the lab supply together to be quite a straightforward task, as there are few awkward or fiddly jobs involved. However, we recommend that you continually refer to the component overlay diagram as you install the parts, and cross check your work against both the schematic diagram and the associated shots of the prototype. The new lab power supply fits neatly into the largest in the range of standard plastic instrument cases, measuring 260 x 190 x 80mm, and most of the components are accommodated on a single PCB measuring 149 x 113mm (ZA1312). The remaining parts fit into the front and rear panels, while the transfor-

mer mounts onto the bottom half of the case.

Commence construction by installing the smaller parts into the PCB as shown on the component overlay diagram, and work your way through to the larger items. Note that there are only two links on the board, but we've used PCB pins for all of the off-board connections — and there are quite a few of those...

If you don't feel like installing PCB pins at all of these points, you can connect appropriate lengths (and gauges) of wire directly to the pads, then terminate the remaining ends at a later stage. Bear in mind however, that if you need to remove the PCB *after* the supply has been completed, you'll have to unsolder (and later, resolder) all of the connections at the front and rear panel components — not an easy job.

It's also worth noting that TP1, TP2 (and their associated grounding points, labeled 'GND'), plus R6 and R13 will all need PCB pins or short lengths of solid wire, for access during the setup procedure.

At this point, you might like to consider how accurate you wish the current readings to be between the 0.3A and 3A ranges. If you're happy to have a degree of error on the low range (at worst, around 10 or 15 percent), you can install 2.2 ohm rather than 2.7 ohm resistors as R5 and R14 during the construction, and not bother with the trimming resistors (R6 and R13) which are fitted during the supply's calibration process.

Next fit all of the parts onto the PCB

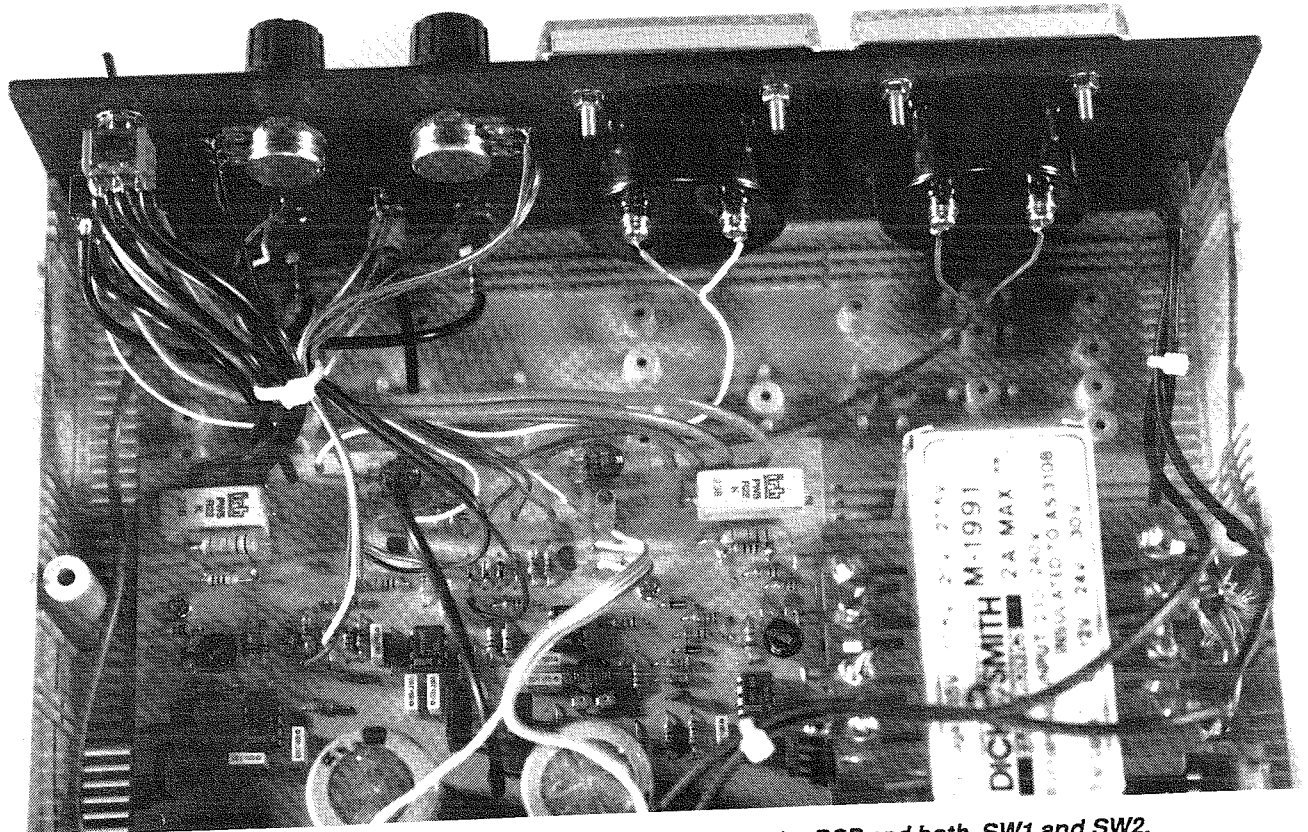

A view of the front panel wiring, showing the heavier wiring between the PCB and both SW1 and SW2.

(except R6 and R13, if you've taken this path) while paying close attention to each component's position and orientation, as shown on the overlay diagram. Mount the 0.22 ohm 5W resistors (R4 and R15) slightly above the PCB to assist cooling, and fit the aluminium bracket/heatsink to the diode bridge (with a smear of thermal grease) before it's installed in the board. We simply fashioned the bracket from a scrap of aluminium plate, by the way.

The last, and largest components to install are the main reservoir capacitors, which are shown as C1 and C2 on the schematic and rated at 5600uF/40VW — the value used in our prototype and supplied in this kit. So that you're locked into this specific type however, the PCB pattern has been arranged to accommodate a variety of other capacitor sizes and combinations as shown in Fig.2.

This overlay diagram shows three possible arrangements of the rectifier and filtering section of the PCB, where axial-type capacitors are shown at the top, larger PCB-mounting units in the middle, and a combination of smaller PCB-mounting caps appear at the bottom. The only real requirement is that the total capacitance per side is more than about

4700uF, and has a voltage rating greater than say 30V — since the unloaded supply rail sits at around 22V, 25V capacitors won't quite have enough voltage headroom. Note that while the 5600uF/40V units used in our prototype match the size that's shown at the bottom of Fig.3 (but only two are needed), some capacitors with the same ratings have significantly larger dimensions, and can be fitted as shown in the middle diagram of Fig.3.

On the other hand, four PCB-mounting

capacitors with a value of say 2500uF at 35V (or even larger) may prove to be more cost-effective or convenient, and can be fitted into the board as shown in the bottom arrangement of Fig.3 (C1A, C1B, C2A and C2B).

With the PCB assembly completed, you can begin to fit the remaining parts into the case, while using the photos of the prototype as a guide.

As mentioned above, the transformer is bolted into the bottom half of the case as shown in Fig.2 - don't forget to fit a

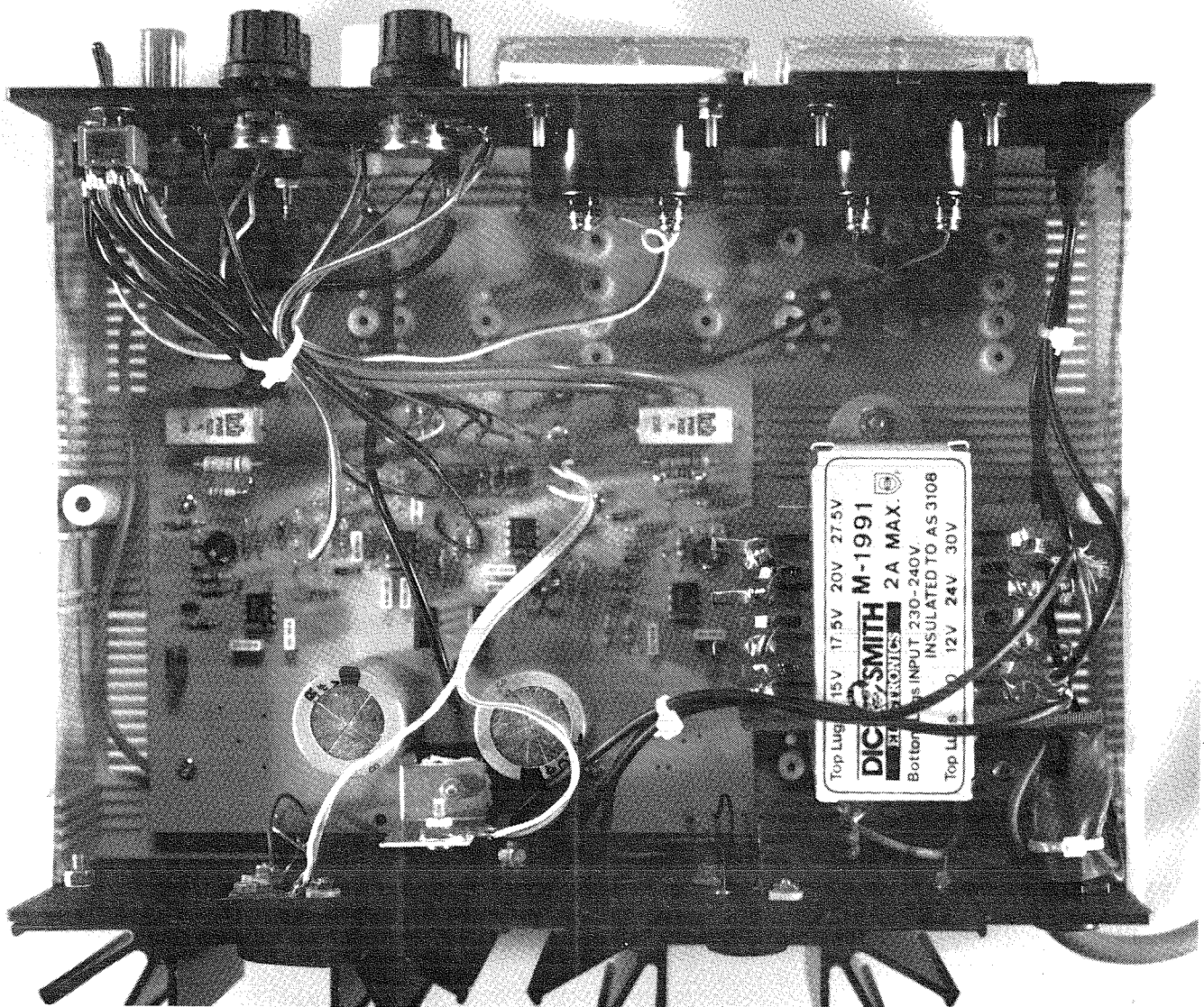
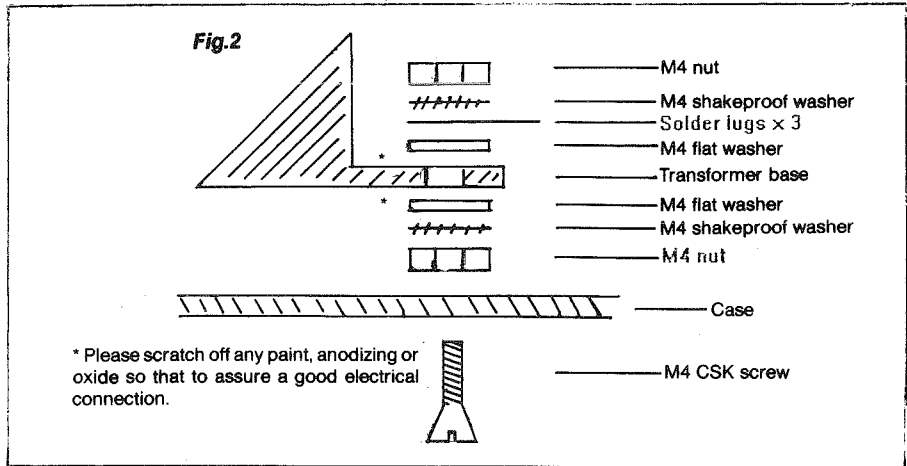

A plan view inside the completed unit, showing how the PCB and transformer are installed. The two driver transistors (Q2 and Q3) shown in this shot are smaller than those specified for the final unit, by the way.

solder lugs. Also you may need to remove any case stand-offs that interfere with the transformer mounting.

The heatsinks should be about 74mm in length, mounted with their fins vertically, and have a matching cutout in the case's rear panel for access. Note the case might not close properly due to the heatsink being a little larger than the case spacing. If this is the case you can either file a little off the case panel lip on both the top and bottom half of the case or file the heatsinks a little on both the top and bottom sides. When prepared, the heatsinks can be bolted to the panel - we found just three bolts sufficient - and the series pass transistors Q1 and Q4 installed with insulating washers, bush and thermal grease. Using a multimeter on a high ohms range check that the cases of Q1 and Q4 are isolated from the heatsink. We also installed plastic covers on both T03 transistors to avoid the possibility of inadvertent shorts when the unit is on the bench.

Note that each thermal sensing transistor (Q5 and Q6) has its base and collector legs joined. Each should be installed with the metal face against the heatsink or bracket, and have a smear of thermal grease used at the mating surfaces. Also, the sensing transistor attached to Q1's heatsink (on the right) should be electrically isolated with a suitable mica washer.

Once all of the remaining parts have been fitted to the case, the internal wiring can be completed. Use heavy-duty hook-up wire for all of the high current paths (the transformer secondary connections, the wiring to SW1 and SW2, and the 0V output lead), and light-duty wire or sections of 'rainbow' cable for the remaining low voltage connections (pots, LEDs, meters, etc). Other than that, the emitters and collectors of Q1 and Q4 can be connected to the PCB using short lengths of tinned copper wire, and of

course, all 240V AC connections made with mains-rated cable.

The voltage and current pots (RV1 and RV7, respectively) can be connected to the PCB via three-core lengths of rainbow cable, and terminated as shown in the overlay diagram.

Carefully follow the wiring diagram shown when it comes to completing the mains connections.

Finally make sure that you've fitted all of the front panel wiring. There should be short lengths of heavy-duty hook-up wire from the 'load on' terminals of SW2 to the appropriate output binding posts (+ & -), and a single connection from the 'current set' pin SW2A (the positive side) to 0V output terminal - this supplies a short circuit to the positive regulator while the current limit is being set RV7.

## Setting up, testing

**Warning: Before switching on, check the mains wiring thoroughly!** Once you're confident that the supply's wiring is correct, mechanically zero the meters movements, select '0.3A' and 'set volts' on the range and load switches respectively, and apply power to the power supply. Immediately check that the reading on the Volts meter responds to adjustments of the Voltage control, and the 12V regulators (IC5 and IC6) are not running hot.

If all is well, make a few careful voltage checks around the PCB; the raw supply rails should be around 22V, and the low voltage rails should be close to +/-12V. You can also check that the supply's overall output voltage can be adjusted from 0V to about 40V with the Voltage control (RV1).

Next check the status of the LED indicators — with any luck, they will all be off. If the 'temp' LED is on, you should

have noticed a problem by now, since its associated comparator (IC3) will have immediately shut down the supply's output voltage. Turning RV5 in a clockwise direction for a higher temperature setting should remedy this situation (more on its adjustment in a moment).

If the 'limit' or 'dropout' LED illuminates on the other hand, switch off the supply and re-check your wiring and the PCB. Since the load is not connected at this stage, there should be no current limiting action and the main regulators must have sufficient voltage headroom.

Once you are happy with the supply's basic operation, the PCB's various trim-pots can be adjusted. Start with the current sensing amplifier balance presets, RV2 and RV4.

With the supply's output voltage adjusted close to its maximum level (say 40V), connect TP1 to its nearby ground pin (labeled GND in the overlay) with a shorting lead, and adjust RV4 for a zero reading on the current (Amps) meter. Then apply the shorting lead to TP2 and its ground connector, and adjust RV2 in the same manner.

When the lead is removed the meter should continue to read zero, since the two differential amps now have balanced input networks. The above procedure works by forcing the differential amp that's not being adjusted into its inactive state — that is, with its output at a low potential. So if we ground TP1 for example, the output of IC1B will fall, then the meter (M2) is driven by IC2B, and we can note the meter reading while adjusting RV4. Conversely, grounding TP2 will activate IC1B, allowing adjustment of RV2.

After that you can calibrate the voltage and current meters using a standard multimeter and a dummy load (SW2 set to load on). Bear in mind however, that the common low-cost meter movements will

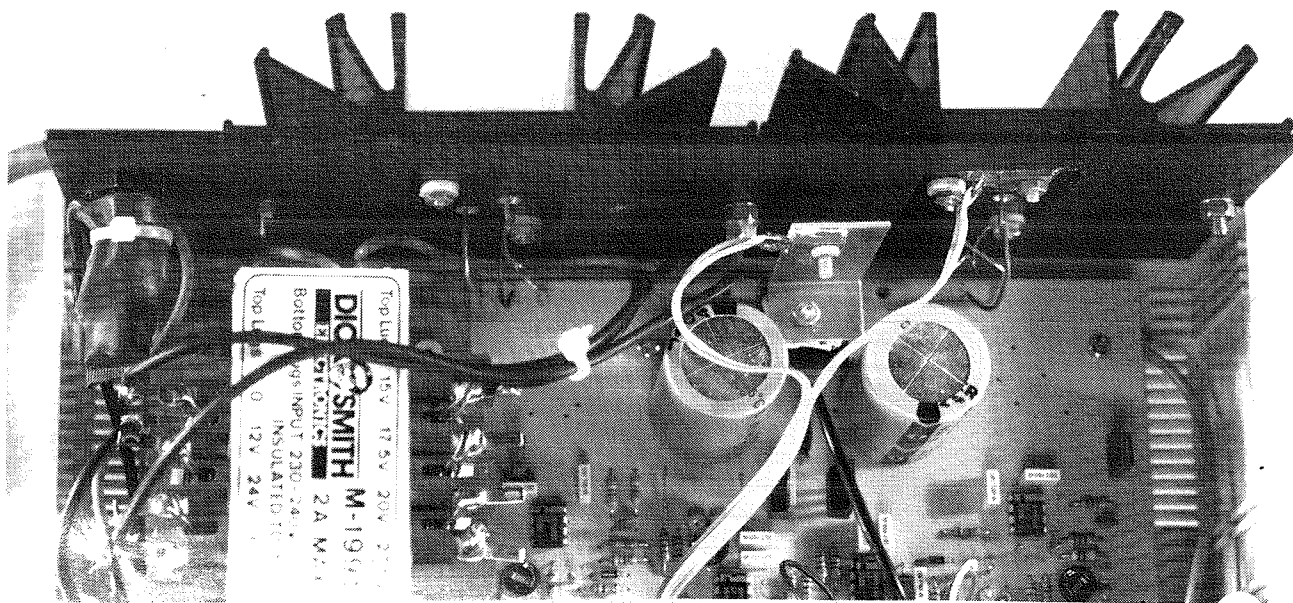

**The supply's rear panel, looking from inside the box. Note the bridge rectifier's L-shaped heatsink bracket and thermal sensing transistor, which are just behind the nearest reservoir capacitor.**

## Parts List

### Resistors (All 1/4W unless specified)

R1	27k (red-vio-org)	<input type="checkbox"/>
R2	27k (red-vio-org)	<input type="checkbox"/>
R3	680R (blu-gry-brn)	<input type="checkbox"/>
R4	0.22R (wire wound) 5W	<input type="checkbox"/>
R5	2.7R (red-vio-gold) 1W	<input type="checkbox"/>
R6	See text (setting up section)	<input type="checkbox"/>
	IF 12R (brn-red-blk)	<input type="checkbox"/>
R7	56k (grn-blu-org)	<input type="checkbox"/>
R8	56k (grn-blu-org)	<input type="checkbox"/>
R9	56k (grn-blu-org)	<input type="checkbox"/>
R10	39k (org-wht-org)	<input type="checkbox"/>
R11	680R (blu-gry-brn)	<input type="checkbox"/>
R12	33k (org-org-org)	<input type="checkbox"/>
R13	See text (setting up section)	<input type="checkbox"/>
	IF 12R (brn-red-blk)	<input type="checkbox"/>
R14	2.7R (red-vio-gold) 1W	<input type="checkbox"/>
R15	0.22R (wire wound) 5W	<input type="checkbox"/>
R16	22k (red-red-org)	<input type="checkbox"/>
R17	100k (brn-blk-yel)	<input type="checkbox"/>
R18	22k (red-red-org)	<input type="checkbox"/>
R19	100k (brn-blk-yel)	<input type="checkbox"/>
R20	22k (red-red-org)	<input type="checkbox"/>
R21	100k (brn-blk-yel)	<input type="checkbox"/>
R22	22k (red-red-org)	<input type="checkbox"/>
R23	100k (brn-blk-yel)	<input type="checkbox"/>
R24	12k (brn-red-org)	<input type="checkbox"/>
R25	33k (org-org-org)	<input type="checkbox"/>
R26	33k (org-org-org)	<input type="checkbox"/>
R27	1k (brn-blk-red)	<input type="checkbox"/>
R28	27k (red-vio-org)	<input type="checkbox"/>
R29	4.7k (yel-vio-red)	<input type="checkbox"/>
R30	10k (brn-blk-org)	<input type="checkbox"/>
R31	270R (red-vio-brn)	<input type="checkbox"/>
R32	2.2k (red-red-red)	<input type="checkbox"/>
R33	12k (brn-red-org)	<input type="checkbox"/>
R34	4.7k (yel-vio-red)	<input type="checkbox"/>
R35	150k (brn-grn-yel)	<input type="checkbox"/>
R36	1k (brn-blk-red)	<input type="checkbox"/>
R37	1.5k (brn-grn-red)	<input type="checkbox"/>
R38	22k (red-red-org)	<input type="checkbox"/>
R39	22k (red-red-org)	<input type="checkbox"/>
R40	10k (brn-blk-org)	<input type="checkbox"/>
R41	10k (brn-blk-org)	<input type="checkbox"/>
R42	2.7M (red-vio-grn)	<input type="checkbox"/>
R43	1.8k (brn-gry-red)	<input type="checkbox"/>

### Capacitors

C1	electro 5600uF/40V	<input type="checkbox"/>
C2	electro 5600uF/40V	<input type="checkbox"/>
C3	[not used]	<input type="checkbox"/>
C4	ceramic 1nF/102	<input type="checkbox"/>
C5	ceramic 270pF/271	<input type="checkbox"/>
C6	electro 4.7uF/16V/25V/50V	<input type="checkbox"/>
C7	MKT .1uF/100n	<input type="checkbox"/>
C8	MKT .1uF/100n	<input type="checkbox"/>
C9	MKT .1uF/100n	<input type="checkbox"/>
C10	MKT .1uF/100n	<input type="checkbox"/>
C11	MKT .1uF/100n	<input type="checkbox"/>
C12	MKT .1uF/100n	<input type="checkbox"/>
C13	MKT .1uF/100n	<input type="checkbox"/>
C14	MKT .1uF/100n	<input type="checkbox"/>

C15	MKT .1uF/100n	<input type="checkbox"/>
C16	MKT 33nF/33n	<input type="checkbox"/>

### Semiconductors

D1	1N914/1N4148/T48	<input type="checkbox"/>
D2	1N914/1N4148/T48	<input type="checkbox"/>
D3	1N914/1N4148/T48	<input type="checkbox"/>
D4	1N914/1N4148/T48	<input type="checkbox"/>
D5	1N914/1N4148/T48	<input type="checkbox"/>
D6	1N914/1N4148/T48	<input type="checkbox"/>
D7	1N914/1N4148/T48	<input type="checkbox"/>
D8	1N914/1N4148/T48	<input type="checkbox"/>
Q1	2N3055	<input type="checkbox"/>
Q2	BD139	<input type="checkbox"/>
Q3	BD140	<input type="checkbox"/>
Q4	MJ2955	<input type="checkbox"/>
Q5	BD140	<input type="checkbox"/>
Q6	BD140	<input type="checkbox"/>
Q7	BC557	<input type="checkbox"/>
Q8	BC557	<input type="checkbox"/>
IC1	TL072/LF353	<input type="checkbox"/>
IC2	TL072/LF353	<input type="checkbox"/>
IC3	TL071/LF351	<input type="checkbox"/>
IC4	TL072/LF353	<input type="checkbox"/>
IC5	7812	<input type="checkbox"/>
IC6	7912	<input type="checkbox"/>
BR1	PW04/KBPC4-04	<input type="checkbox"/>
LED 1	Led red	<input type="checkbox"/>
LED 2	Led red	<input type="checkbox"/>
LED 3	Led yellow	<input type="checkbox"/>

### Hardware

RV1	10k SG LIN pot	<input type="checkbox"/>
RV2	1k trimpot	<input type="checkbox"/>
RV3	20k trimpot	<input type="checkbox"/>
RV4	1k trimpot	<input type="checkbox"/>
RV5	2k trimpot	<input type="checkbox"/>
RV6	2k trimpot	<input type="checkbox"/>
RV7	5k SG LIN pot	<input type="checkbox"/>

### Miscellaneous

1	PC board coded ZA1312
1	plastic instrument case
1	30V/2A transformer
2	radial-finned heatsinks
2	MU 45 panel meters, 1mA FCD
1	pre-punched, silk screened front panel
1	pre-punched rear panel
2	meter scale labels (volts & amps)
1	mains cable with plug
4	banana-type binding posts (yellow, black, red & green)
2	T0-3 plastic insulating caps
2	plastic knobs
1	DPDT mini toggle switch
1	DPDT mini toggle switch, centre off, momentary action on one side
1	mini rocker mains power switch with internal neon
1	3AG fuse holder
1	1 amp 3AG fuse
	Solder lugs, rubber feet, PCB pins, mica washers and bushes suit T03 & T-220, cable clamps, cable ties, rubber grommet, silicon grease, mains H/up wire, solder, H/up wire, heatshrink tubing, screws, nuts, flat washers and shakeproof washers etc.

have only a moderate accuracy through their range, and your best bet is to perform the adjustment with the pointer at around two-thirds of full scale deflection (FSD). Adjust the voltage meter with RV3, and the current meter with RV6 while SW1 is set to the high range (3A) - this is necessary if you've fitted 2.7 ohm resistors for R5 and R14, since these are yet to be trimmed in value by R6 and R13 respectively.

Assuming that this is the case, connect a multimeter (configured to read current on its say, 2A range) across the supply's positive output terminals (between zero and positive), select the 3A range on SW1, and adjust the current limit control for reasonably high reading - say 1.9A. Then switch to the supply's 0.3A

range and try a range of resistors (or a pot) in R6's position, until the multimeter reads 0.19A. Note that during this procedure the 'limit' LED should be on, and the supply's current meter (M2) should also be reading close to 1.9A when SW1 is in the 3A position.

Once you've found a suitable value for R6, this can be soldered in place, and a resistor of the same value installed as R13 - the equivalent component in the negative regulator's circuit. While you could take the trouble of repeating this setup process on the negative side, you would probably find that the final value for R13 is very close to that of R6, since most of the variables involved are the same.

The last adjustment involves the over-temperature setting adjustment, RV5.

This can be adjusted on a trial-and-error basis, where the trimpot is set so that the temperature cut-out is triggered when either the diode bridge or Q1's heatsink becomes too hot to touch, or simply for a given voltage at the wiper of RV5 (pin 2 of IC3). In the latter case, we would suggest a setting of 0.48V - as shown in the schematic voltage readings - which appears to be quite close to the mark.

### Mods & enhancements - optional

While the lab supply in its published form uses standard parts and its design should suit most constructors needs, those who are building the unit up from scratch



Rear panel

These dotted lines show the position for the heatsinks.

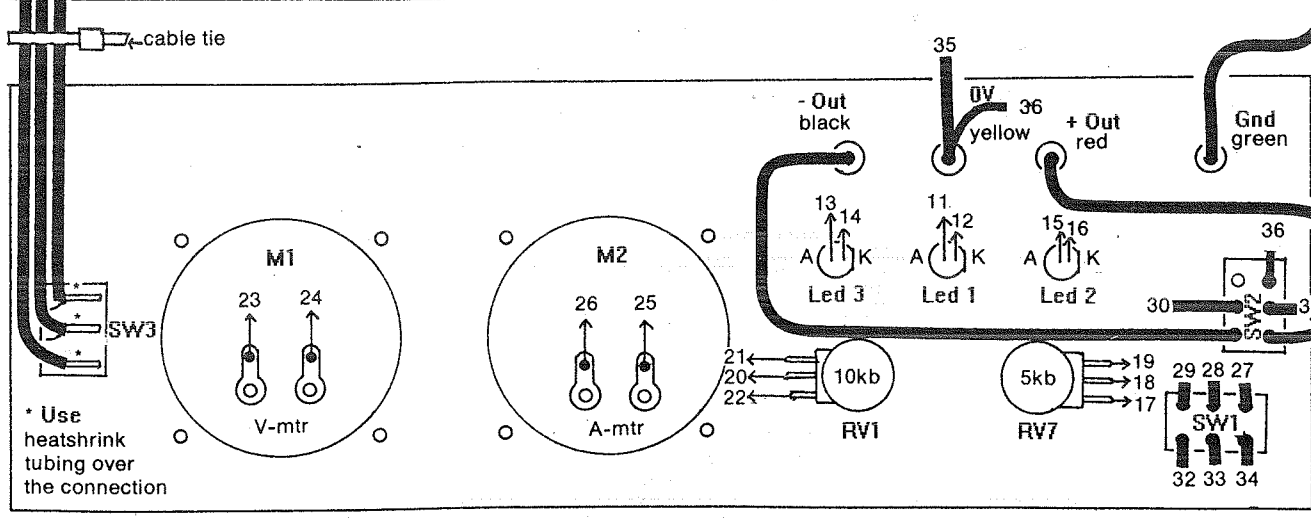
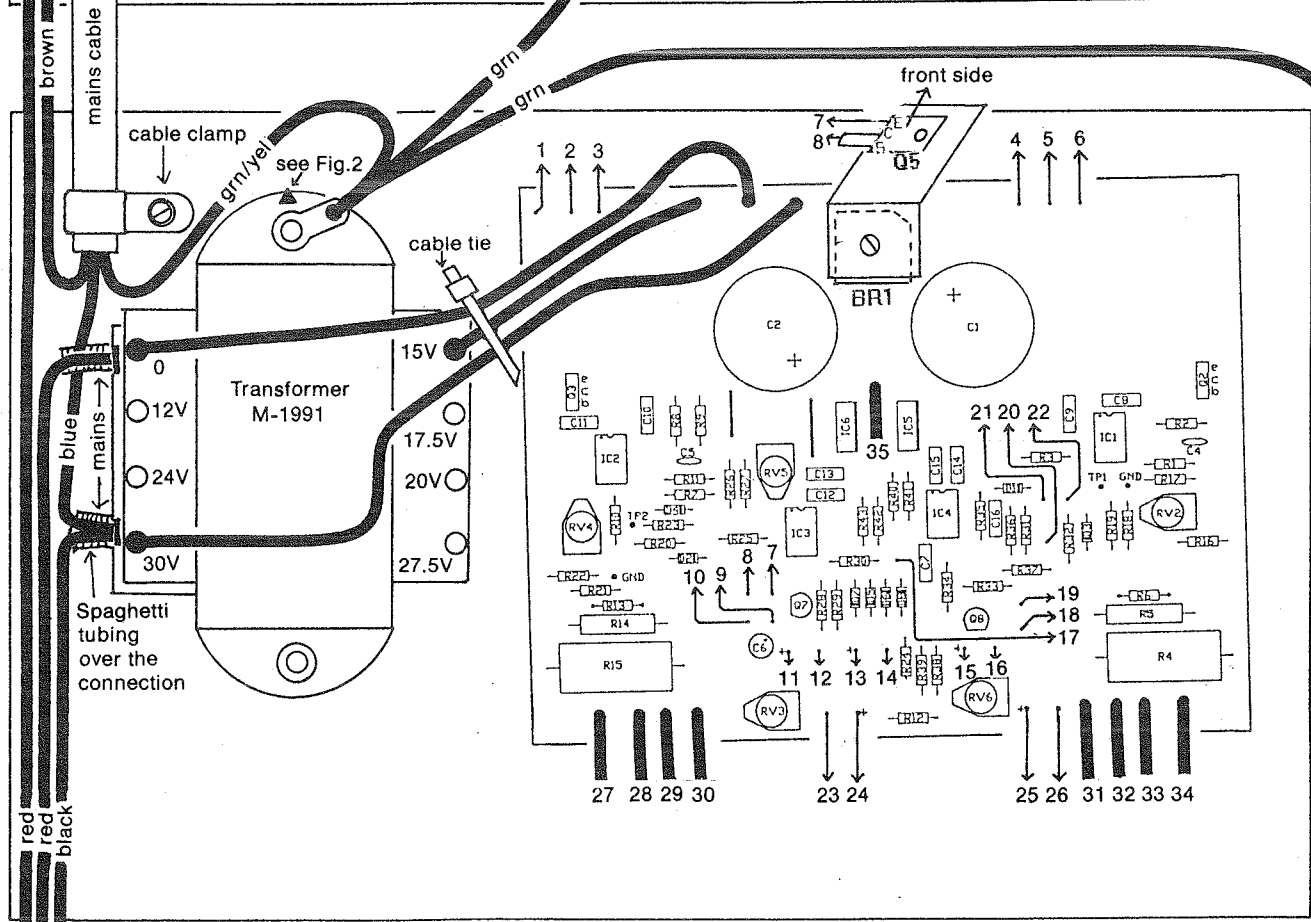
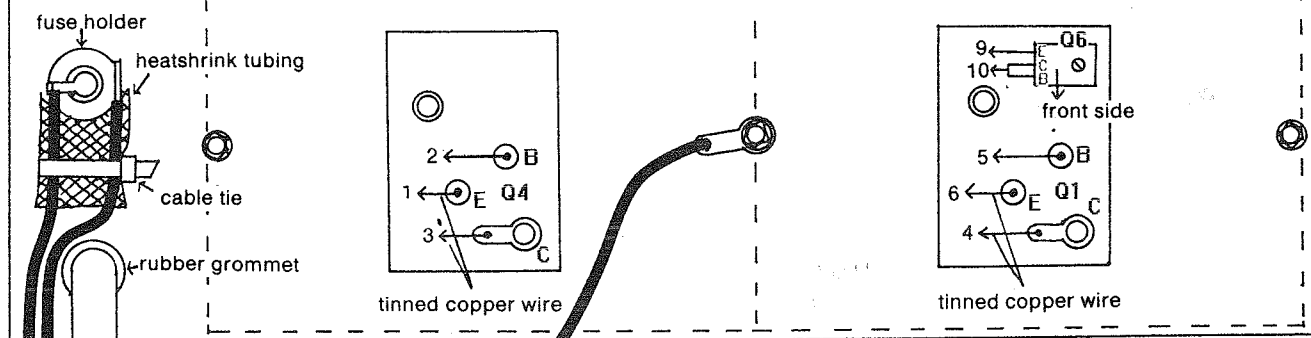

Front panel

Medium duty hookup wire  
Light duty hookup wire

Use this wiring diagram as a guide making the connections to off-board components. Carefully follow the mains wiring, and insulate all mains connections and secure with cable ties.

may wish to elaborate on the circuit, or use other components which may be at hand.

Since the 30V/2A transformer is one of the more expensive items involved, you may prefer to use a slightly different unit to run the supply. If this has a lower secondary voltage the supply will work quite happily, but with a reduced maximum output voltage as you would expect — you may be able to save a few dollars by using filter capacitors with a lower working voltage, as well.

If the transformer has a slightly *higher* secondary voltage on the other hand, you will need to ensure that the supply voltage to IC1 and IC2 doesn't exceed the op-amp's 36V rating.

This can be corrected by increasing the value of R3 and R11, so as to reduce the voltage between pins 8 and 4. Note that the theoretical maximum voltage for the raw supply rails is about +/-30V, since the 12V regulator ICs have a input voltage rating of around 32V, and the negative current sensing stage (IC2B) must have a positive supply rail (pin 8) of at least 5V to ensure an adequate output swing — if pin 8 is at 5V, then pin 4 must not exceed about -30V, as this would be a total supply rail of 35V for IC2.

You could also use a transformer with a higher output current capability, as this would help to maintain the supply's output voltage at high current levels. In this case however, you will need to consider the current rating (and cooling) of the bridge rectifier, and bear in mind that the dissipation in Q1 and Q4 will increase by a significantly level.

Other than that, some constructors may like to bolster the degree of thermal protection by adding further sensing transistors to the negative regulator's heatsink (for Q4), or even to the transformer itself. While the various sensors will operate in an OR fashion as described above, the shut-down threshold point (as set by RV5) will need to be adjusted on a trial-and-error basis.

And as a final point, a one ohm 5W resistor could be fitted between SW2A's 'set current' pin and the 0V terminal, in place of the length of wire used in the

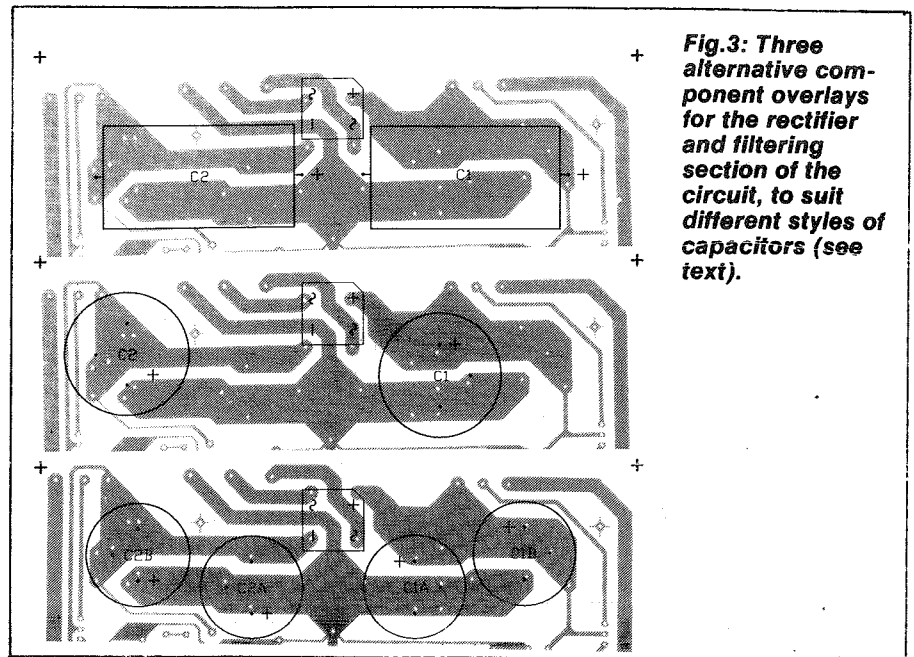

**Fig.3: Three alternative component overlays for the rectifier and filtering section of the circuit, to suit different styles of capacitors (see text).**

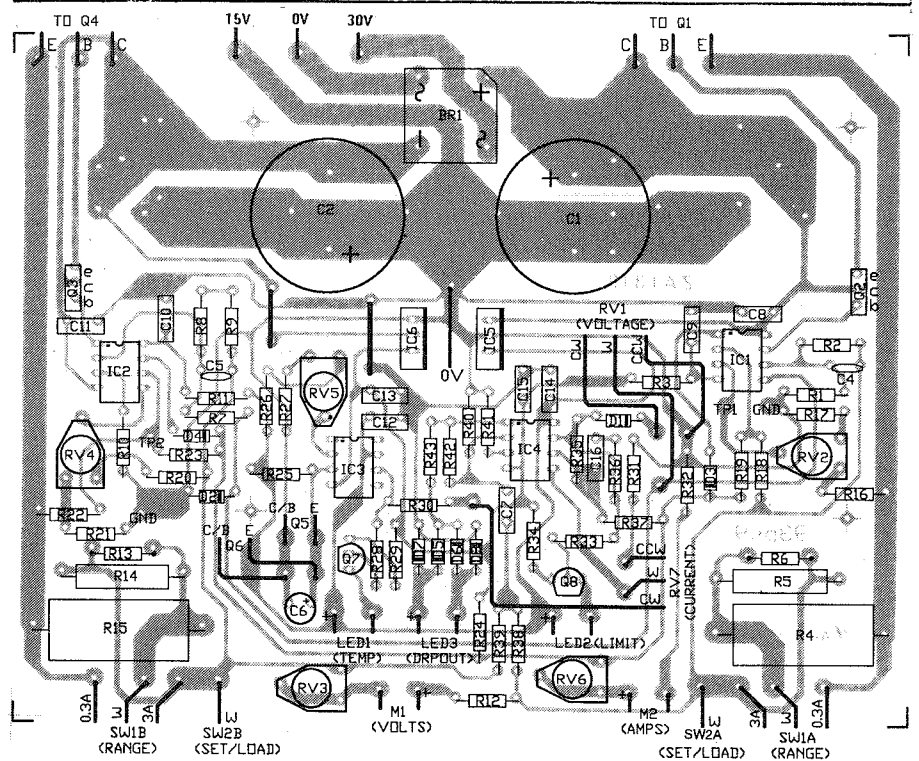

prototype. This would decrease the strain on the switch contacts to some degree, since when the supply's output has been set to high voltage, a large instantaneous current can flow through the contacts via

the short.

With the resistor installed however, this momentary current is reduced by a substantial amount, which should extend SW2's working life.

### Notes & Errata



ACN 000 908 716

CNR Lane Cove & Waterloo Roads  
North Ryde NSW 2113

PH: (02) (Int 612) 9937 3200 Fax: (02) 9888 3631