

INSTALLATION AND OPERATION MANUAL
KACHINA MODEL 505AR/ARX
ANTENNA ROTOR CONTROL

ORIGINAL 11/98

TABLE OF CONTENTS

CHAPTER 1 - OVERVIEW

CHAPTER 2 - TECHNICAL SPECIFICATIONS

CHAPTER 3 - 505AR INSTALLATION

CHAPTER 4 - RELAY BOARD INSTALLATION

CHAPTER 5 - SOFTWARE INSTALLATION

CHAPTER 6 - CABLE CONNECTION AND INITIAL ALIGNMENT

- 6.1 - Rotor Sense Voltage Upper Limit Calibration
- 6.2 - Calibrating the Rotor Endpoints
- 6.3 - Setting the Brake Delay
- 6.4 - Setting Overshoot

CHAPTER 7 - OPERATION

- 7.1 - Pointing the Antenna
- 7.2 - Auxiliary Relay Driver Outputs
- 7.3 - Using the Memories

CHAPTER 8 - TROUBLESHOOTING

FIGURES

- Figure 3.1 - Parts List 505AR and 505ARX
- Figure 3.2 - Block Diagrams, 505AR and 505ARX
- Figure 3.3 - Installation Instructions, 505AR
- Figure 4.1 and 4.2 - Relay Board Installation
- Figure 4.3 and 4.4 - Relay Board Installation
- Figure 4.5 and 4.6 - Relay Board Installation
- Figure 4.7 and 4.8 - Relay Board Installation
- Figure 4.9 and 4.10 - Relay Board Installation
- Figure 4.11 and 4.12 - Relay Board Installation
- Figure 4.13 and 4.14 - Relay Board Installation
- Figure 6.1 - Front and Rear Panel View, 505AR and 505ARX
- Figure 7.1 - Schematic Diagram, Relay Board
- Figure 7.2 - Auxiliary Connection

505AR/ARX ANTENNA ROTOR CONTROL SYSTEM

1.0 Overview

The 505AR/ARX Antenna Rotor Control System allows control of third-party antenna rotors using a personal computer (PC). The 505AR includes a plug-in PC card designed to occupy one of the PC's internal ISA expansion slots. The 505ARX comes with a self-contained, external unit, designed for use with the 505RC Remote Control System. Each model also includes a Relay Card Assembly which the user wires into their manual rotor control box. Kachina's KCROTOR software runs on any Windows[™]-equipped PC.

Software sends serial commands to the 505AR/ARX via a dedicated RS-232 serial port on the PC. In addition to rotor azimuth control, five un-dedicated relay driver outputs are available for toggling external antenna switches, amplifier power, or other station functions. All commands are acknowledged by the 505AR/ARX for positive control. Rotor position is indicated on a large compass display in the software. Rotor position telemetry is continually sent to the PC, so that the azimuth display always reflects the actual antenna position.

Brake on/off delay and overshoot is programmable in fine increments to accommodate different sizes and makes of rotors. Ten memories are provided in which all settings can be stored for later retrieval. This allows automatic and instant recall of antenna bearing and switch settings.

The units are compatible with either north- or south-centered rotors. They can accept DC position-sensing voltages to 25 VDC, and either increasing or decreasing voltage with clockwise rotation.

2.0 Technical Specifications

Supply Voltage:	13.8 VDC \pm 15%
Supply current:	Quiescent, 65 mA nominal; active, 1000 mA maximum
Control port:	RS-232, 1200 baud, no parity, 8 data, 1 stop
Rotor control:	Relay closures for brake, clockwise, and counterclockwise motors, 250 VAC @ 6 A max.; 30 VDC @ 5 A max.; 10 μ A and 10 mVDC minimum
Other relay driver outputs:	150 mA maximum at the supply voltage when ON
Compatible rotor position-sensing voltage range:	0-2.5 VDC min., 0-25 VDC max.; unit accepts either increasing or decreasing voltage with CW rotation.

3.0 505AR Installation

The 505AR/ARX requires the exclusive use of a serial port on the PC in which it is installed. This cannot be the same serial port used for control of a Kachina transceiver. First determine that you have a free port available, or obtain another serial port card from a computer dealer. Be sure of the port number to which the 505AR/ARX will be connected.

The parts included with your 505AR/ARX are shown in Fig. 3.1. For installation of the 505AR inside a PC, begin with the paragraph immediately below. For installation of a 505ARX, skip to Section 4.

Refer to Fig. 3.3. First, **REMOVE THE POWER CORD FROM THE PC. CONTACT WITH AC MAINS VOLTAGE CAN BE FATAL.** Next, remove the PC's cover. Locate an empty 8-bit ISA slot. Remove the screw holding down the dummy slot cover. Position the locating tab at the bottom of the 505AR slot cover in the slot, then press gently downward to seat the module in the ISA connector. Reattach the screw at the top of the slot cover to secure the module in place. Replace the PC's cover and secure.

4.0 Relay Board Installation

The Relay Board is designed to mount inside your manual rotor control box. A Kachina-supplied cable (970074) connects the Relay Board to the 505AR/ARX. Instructions are supplied below on how to connect the brake, clockwise (CW) and counterclockwise (CCW) relays to the switch contacts inside the rotor box. The instructions describe installation in a Hy-Gain rotor control box, but the 505AR/ARX may be used with almost any rotor control by following the example.

Before beginning Relay Board installation, **BE SURE ALL AC POWER IS REMOVED FROM THE ROTOR CONTROL BOX**. Carefully remove the cover of the rotor control unit. See Fig. 4.1. The end of cable 970074 which is stripped and tinned must be passed through the cover or panel of the control unit to the Relay Board, which will be mounted inside. Drill or punch a hole in the rotor control unit at least 7.9 mm (5/16") in diameter for the cable.

Use the drill template to find the best location for the Relay Board inside the control unit. Check the chassis opposite the desired mounting hole locations to ensure no damage to rotor control unit components will occur during drilling. Drill or punch four 3.2 mm (1/8") mounting holes for the Relay Board. See Fig. 4.2.

Install the rubber grommet (provided) in the hole for the cable. See Fig. 4.3. Pass the open end of cable 970074 through the grommet. Tie a knot in the cable or use a cable tie to provide strain relief for the cable. See Fig. 4.4.

Mount the Relay Board inside the rotor control unit using the screws and spacers provided. See Fig. 4.5. Locate the contacts for the CW, CCW, and BRAKE switches. See Fig. 4.6. Solder the two wires connected to the Relay Board terminals marked "BRAKE1" and "BRAKE2" across the "BRAKE" switch terminals. See Fig. 4.8.

Solder the wires from the "CW" terminals across the "CW" switch, as shown in Fig. 4.9. Solder the wires from the "CCW" terminals across the "CCW" switch. See Fig. 4.7.

Attach the open ends of cable 970074 according to Figs. 4.10 and 4.11. Connect the Sense +, Sense -, and Chassis Ground wires as shown in Figs. 4.12 and 4.13. The sense voltage indicates the actual position of the rotor. Sense - is a separate return for this signal, and is grounded at the 505AR/ARX end of the cable. This helps avoid ground loops.

Clean any metal shavings and debris from the rotor control unit before re-assembling it. See Fig. 4.14.

5.0 Software Installation

Follow the directions on the diskette label to install the KCROTOR software on your PC. Its new icon will appear in your Kachina group. The first time this software is invoked, you will be prompted for the serial port number to which the 505AR/ARX is attached. This port may be changed by navigating to the directory in which the software resides and deleting the file "KCROTOR.CFG".

Software features are described in Section 7, Operation.

6.0 Cable Connection and Initial Alignment

Connect the 15-pin connector of cable 970074 to the mating connector at the rear of the 505AR/ARX as shown in Fig. 3.2. Attach the Kachina-supplied null-modem serial cable between the 9-pin sub-D connector on the 505AR and the 9-pin sub-D connector of the PC serial port. Using a 505ARX with the 505RC Remote Control System, connect the cable to one of the 9-pin sub-D Auxiliary port connectors on the 505RC. It matters not which Auxiliary port is used, but the baud rate for that port must be set to 1200 baud. AUX1 is factory set to this rate. Refer to the 505RC Installation and Operation Manual for information on setting the Auxiliary port baud rates.

Power up the PC and rotor control unit. In the case of 505ARX, apply its power by plugging in the AC adaptor provided. See Fig. 3.2. If the 505RC is being used, it will be necessary to power it up also, and to dial and connect to perform the initial calibration.

6.1 Rotor Sense Voltage Upper Limit Calibration

Refer to Fig. 6.1. Start the KCROTOR software, entering the correct serial port number, if necessary. Manually rotate the antenna to the position providing the highest DC sense voltage, usually the most CW position. Observe the state of the red LED at the rear of the 505AR/ARX. If the LED is on, rotate the adjacent potentiometer CCW until it is just extinguished. If the LED is off, rotate the "POT" CW until it is lit, then CCW until it is just extinguished. This setting allows for maximum positional resolution by the sensing circuits in the 505AR/ARX. The pot is a multi-turn control, and may have to be rotated through several full revolutions to achieve results.

If the LED cannot be made to light regardless of the amount of pot revolution, it is possible the rotor produces a maximum "sense" voltage at the other end of its rotation range. In this case, manually rotate the antenna to the other end of its range, and try the above procedure again.

6.2 Calibrating the Rotor Endpoints

After successful setting of the pot, click on the "Antenna" menu of the KCROTOR software. Select "Designate CW Endpoint" or "Designate CCW Endpoint", depending on the current antenna position. This calibrates the 505AR/ARX to that end of the antenna rotor's range.

Then manually rotate the antenna to the other end of its range, and designate the opposite endpoint under the "Antenna" menu. Also from the "Antenna" menu, set your rotor's antenna stop position-- north or south. Note that a north-centered rotor has stops at the south.

6.3 Setting the Brake Delay

If your rotor has a wind brake, it may require significant delay at the beginning and end of rotation. Rotors carrying heavy loads require longer brake delays to avoid abruptly braking the unit. The KCROTOR software, under the "Antenna" menu, allows the setting of this delay from 0.5 to 2.5 seconds in 0.5-second increments. This setting is retained until changed by the operator.

6.4 Setting Overshoot

Rotors carrying heavy loads may tend to overshoot the mark after the motor voltage has been shut off. This situation requires longer brake delays and some amount of overshoot compensation. The amount of overshoot compensation can be set in 2.5° increments from the "Antenna" menu. Experimentation may be necessary to determine the optimum brake delay and overshoot compensation values.

7.0 Operation

7.1 Pointing the Antenna

A new antenna azimuth may be selected in one of two ways. The azimuth may be entered numerically from the "Antenna" menu, or the mouse may be used to "point-and-click" on the azimuth display in the KCROTOR window.

During rotation, a red indicator line shows the target azimuth, and the blue indicator line shows the actual antenna position. The actual antenna azimuth is also shown in the large, numeric display at the upper left of the window. Azimuth position updates are provided continually at 0.5-second intervals when the 505AR/ARX is on line. When the 505AR/ARX is off line, the numeric azimuth display is "ghosted", or turns grey.

When the antenna reaches the target azimuth, the red line disappears, the rotor is shut off, and the brake applied after the brake delay. The antenna rotation can be manually stopped by clicking on the "STOP" button, or by hitting the "ESC" key.

7.2 Auxiliary Relay Driver Outputs

Five auxiliary relay driver outputs are provided for the driving of user-provided, 12 VDC relays. When a relay driver output is on, +12 VDC is present. When off, it is high-impedance. See Fig. 7.2 for pin assignments of cable 970074 carrying these signals.

The driver outputs may be toggled by clicking on the green text at the left of the software window. Custom designators or names may be given to these outputs under the "Relays" menu. Observe the maximum current ratings of the relay driver outputs, and under no circumstances apply reverse voltage to these pins. See Section 2, Technical Specifications.

7.3 Using the Memories

Ten user memories are provided for the storage of antenna azimuth and relay driver settings. These can be used to store favorite configurations for quick recall. To set a memory, first set the antenna position and relay states as desired. Select "Save" from the "Memory" menu.

To recall the stored settings, select "Recall" from the "Memory" menu, and click on the desired memory entry. Alternatively, use the "up" and "down" arrow keys on the PC keyboard to highlight the desired entry, then hit "Enter".

8.0 Troubleshooting

Find your symptom below, then examine the possible causes listed for that symptom.

Symptom: 505AR/ARX stays off line.

Possible Causes: Incorrect serial port entered for KCROTOR. Solution: Quit the program, then navigate to the directory where the Kachina software is installed, and delete the file "KCROTOR.CFG". Re-start the program, entering the correct serial port number.

Cables misconnected. Solution: Compare control site installation with Fig. xx.

Power not applied to 505ARX. Solution: Plug in the AC adapter.

505RC AUX port baud rates not set. Solution: Set the Baud rate for the ports to the same value on each RCU.

Serial cables are not "null-MODEM" type. Solution: A null-MODEM cable connects pin 2 of one end to pin 3 of the other. Check cable wiring.

Symptom: Rotor control box azimuth display doesn't agree with KCROTOR azimuth display.

Possible Causes: Initial calibration not performed correctly.

Solution: Perform calibration routine in Section 6.

Rotor sense voltage has large AC component.

Solution: Use shielded rotor cable.

Problem: Rotor goes the wrong way after selecting target azimuth.

Possible Causes: Endpoints selected incorrectly.

Solution: Refer to Section 6.

Relay Board or cable 970074 has CW and CCW connections swapped.

Solution: Exchange the connections.

Problem: Rotor will not respond to rotation commands.

Possible Causes: Improper serial port connection.

Solution: Check the serial cable and serial port number at start-up.

Brake, CW, or CCW relay not firing.

Solution: Check Relay Board wiring.

Problem: While transmitting, rotor moves without command having been issued.

Possible Causes: Cable used not properly shielded or grounded.

Solution: Make sure all cable shields are tied to chassis ground. Try ground braid between pieces of equipment. Establish a good R.F. ground at the operating point.

Figure 3.1-Parts List 505AR and 505ARX

ITEM	QTY.	PART NO.	DESCRIPTION
1	1	505AR	ANTENNA ROTOR CARD (505AR ONLY)
2	1	505ARX	ANTENNA ROTOR CARD (505ARX ONLY)
3	1	980028	AC POWER ADAPTOR (505ARX ONLY)
4	1	970076	SERIAL CABLE, NULL MODEM (505AR ONLY)
5	1	970075	SERIAL CABLE, NULL MODEM (505ARX ONLY)
6	1	970074	RELAY CABLE, HDE-15F TO DE-9F / OPEN
7	1	827710	DRILL TEMPLATE
8	1	831124	RELAY BOARD WITH JUMPER WIRES
9	2	000050	CABLE TIE, 4"
10	1	815101	RUBBER GROMMET
11	4	812446	SPACER, ALUM, HEX, 4-40 X .500
12	4	812479	NYLON PCB SPACERS
13	8	810201	SCREW, 4-40 X 1/4, XPHMS, S.S.
14	8	812000	WASHERS, 4-40, INTERNAL LOCK
15	1	Z469016	KCROTOR, DISKETTE

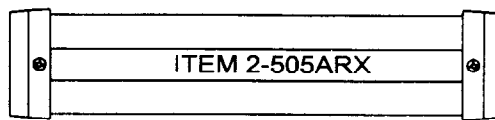
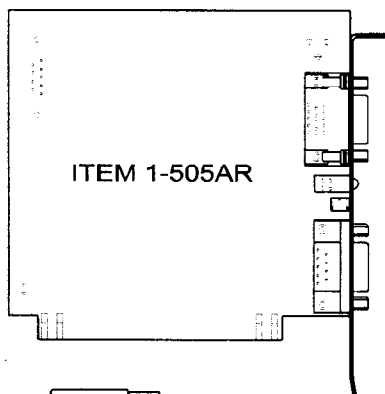

ITEM 3-AC POWER ADAPTOR

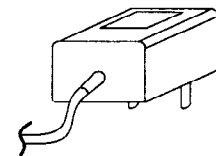

ITEM 8-RELAY BOARD

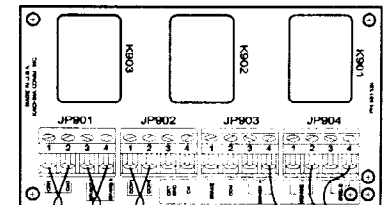

10" 26 AWG WIRES

20 AWG, 6 INCH LENGTH JUMPER WIRES

ITEM 9-CABLE TIE



ITEMS 4 & 5-SERIAL CABLE
P/N 970076 - 970075

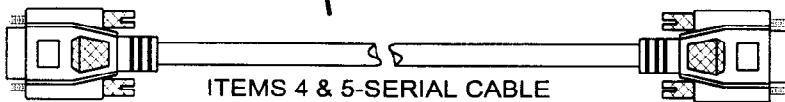

ITEM 6-RELAY CABLE
P/N 970074

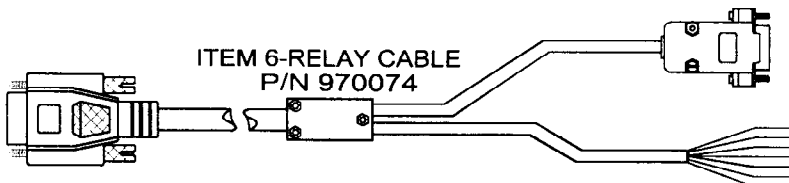

ITEM 7

DRILL TEMPLATE
RELAY BOARD
827710

ITEM 10-RUBBER GROMMET



ITEM 11-ALUM. SPACER



ITEM 12-NYLON PCB SPACERS



ITEM 13-SCREW



ITEM 14-WASHER



ITEM 15-DISKETTE



Figure 3.2-Block Diagrams, 505AR and 505ARX

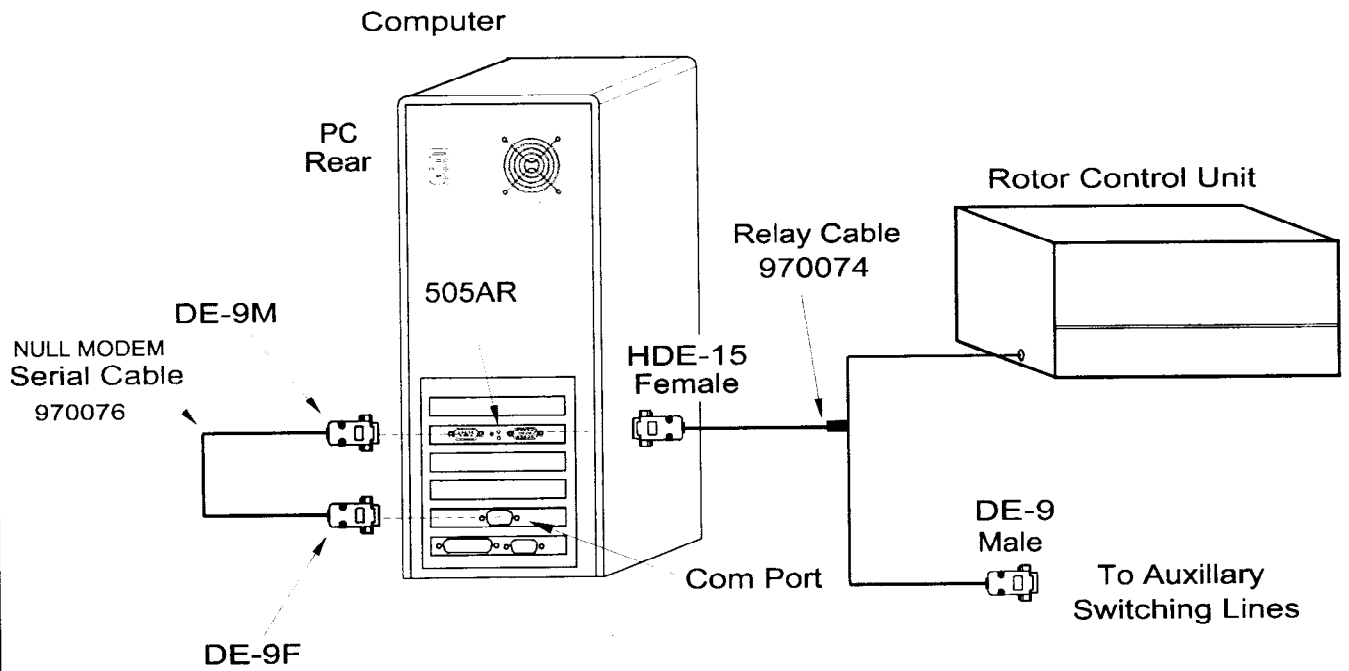

Block Diagram, 505AR

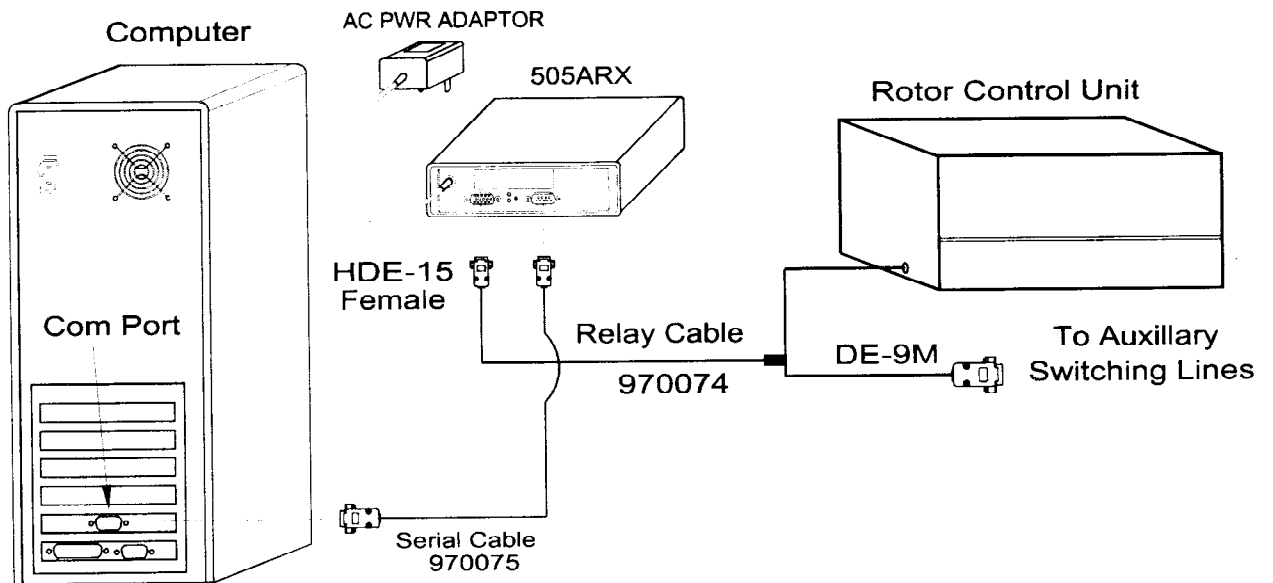

Block Diagram, 505ARX

Figure 3.3-Installation Instructions, 505AR

1
Disconnect power to PC

2
Remove PC cover

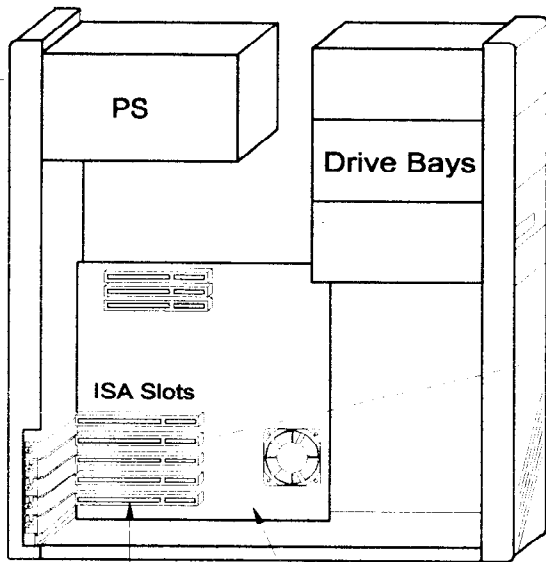

Computer

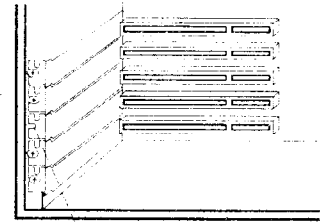

Remove screw and dummy slot cover.

4

Locate an empty ISA slot

3

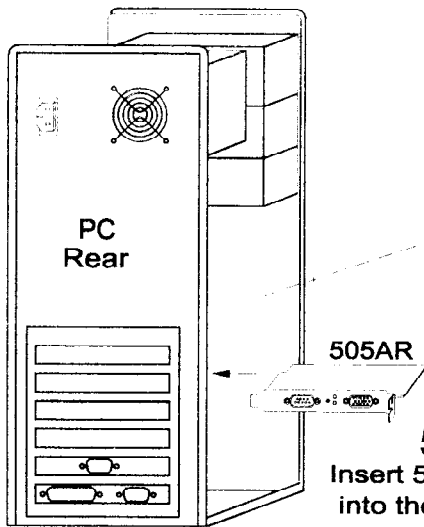

505AR

5
Insert 505AR card
into the ISA slot.

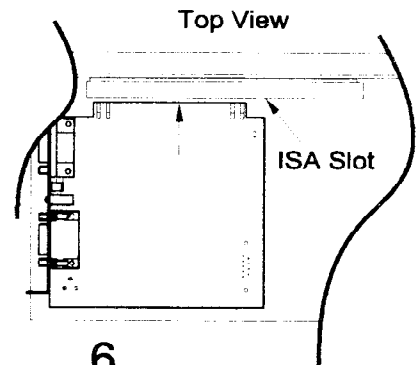

Top View

ISA Slot

6

Press gently downward to seat the
card in the ISA connector.

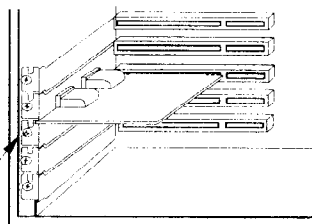

7

Reattach the screw

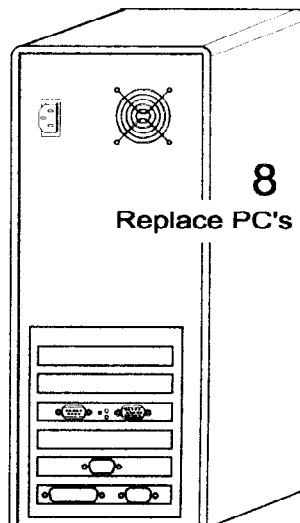

8

Replace PC's cover and secure.

Figures 4.1 and 4.2-Relay Board Installation

- 4.1 Before beginning Relay Card installation, Be sure all AC power is removed from the Rotor Control Unit. Remove the covers from the Rotor Control Unit. Locate any unused holes on the rear of the chassis that you might be able to pass the cable 970074 through. If no such holes exist, drill or punch a 5/16" hole in the rear of the chassis near the bottom.

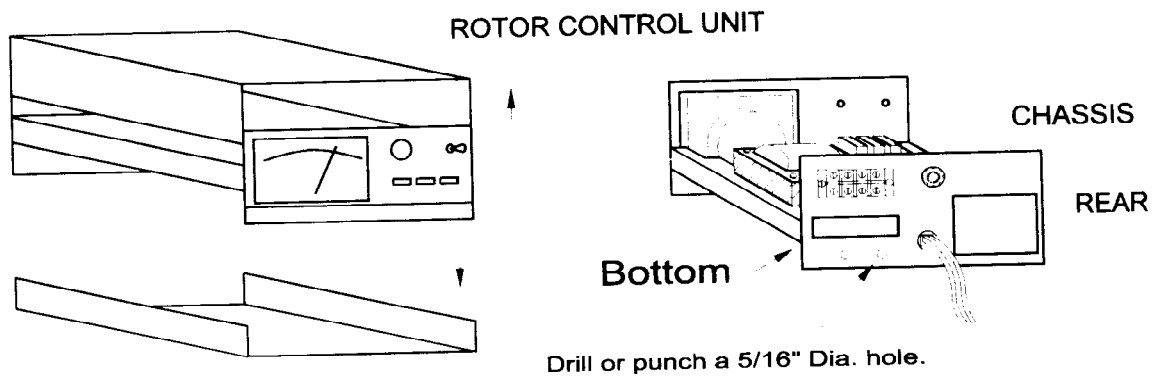

- 4.2 The Relay Board will need to be mounted on the bottom. Using the drill template 827710 find the best location for the Relay Board. Center tap the holes on the drill template then drill using a 1/8" drill bit. (CHECK THE OTHER SIDE TO SEE THAT NOTHING WILL GET DAMAGED FROM THE DRILL BIT AS IT PASSES THROUGH).

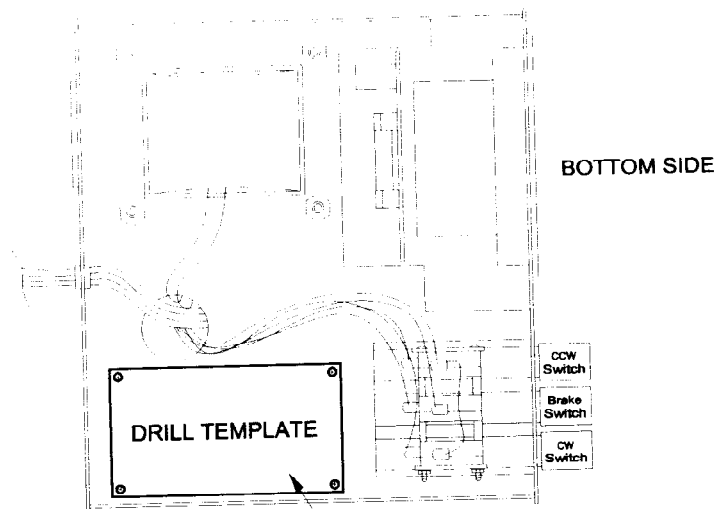

Find the best location and drill four 1/8" holes.

Figures 4.3 and 4.4-Relay Board Installation

- 4.3 Clean out any metal shavings that might be left from the drilling process. Press in the rubber grommet 815101 into the 5/16" hole that you drilled. Pass the open end of the cable 970074 through the grommet.

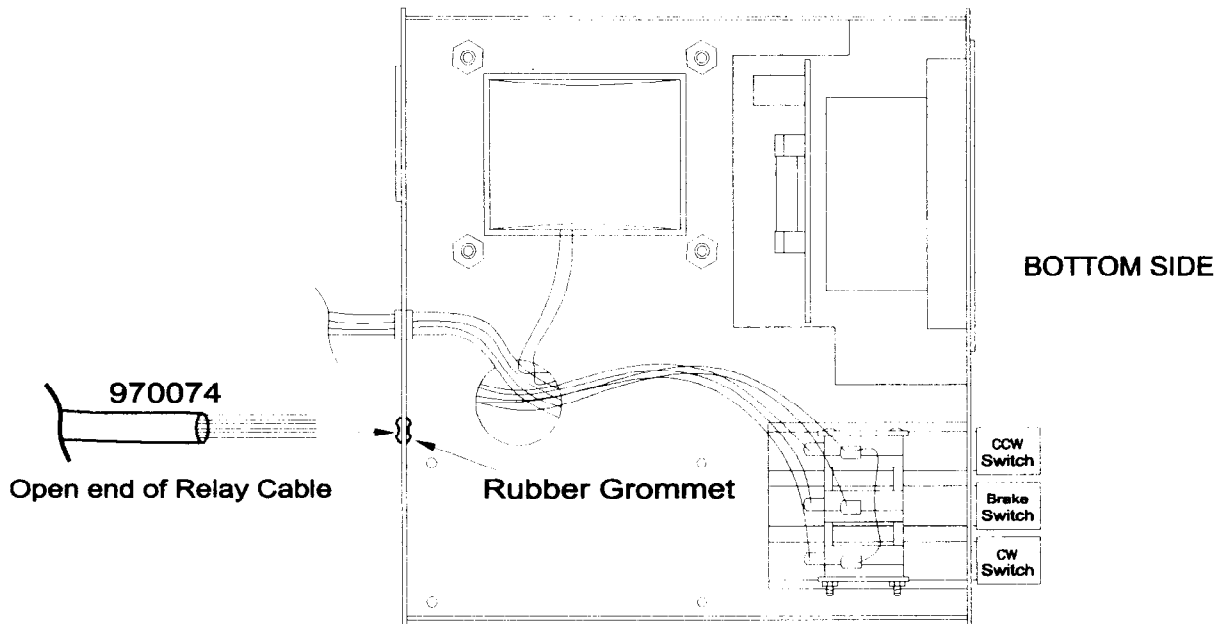

- 4.4 Tie a knot in the cable or use a cable tie to provide strain relief for the cable.

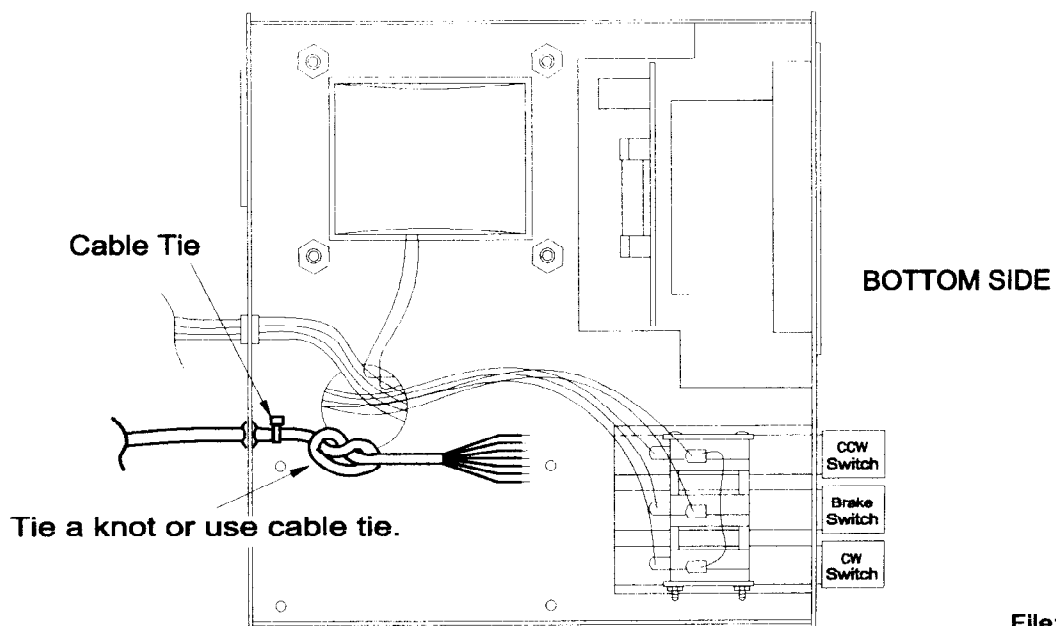

Figures 4.5 and 4.6-Relay Board Installation

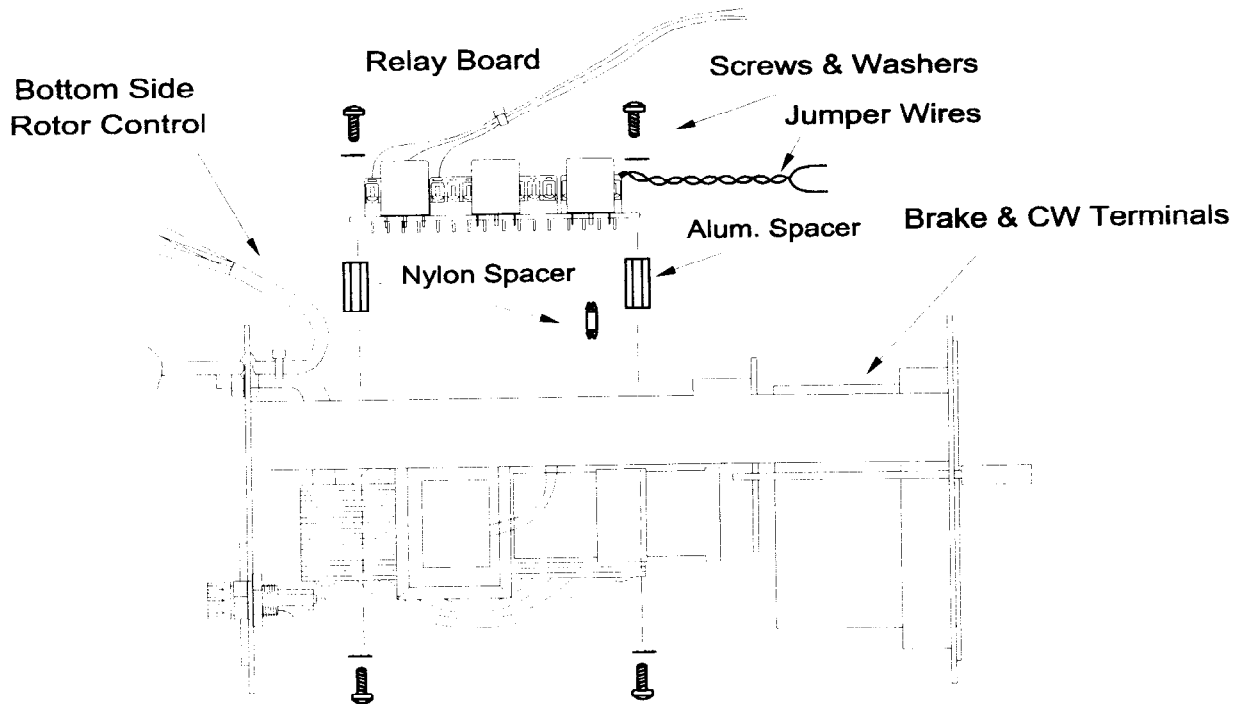

- 4.5 To mount the Relay Board, you may use the nylon spacers 812479 for snap in mounting, or use the aluminum spacers 812446 with washers and screws (all provided). Mount the Relay Board so that the jumper wires are in the direction best suited to solder across th the switch terminals.

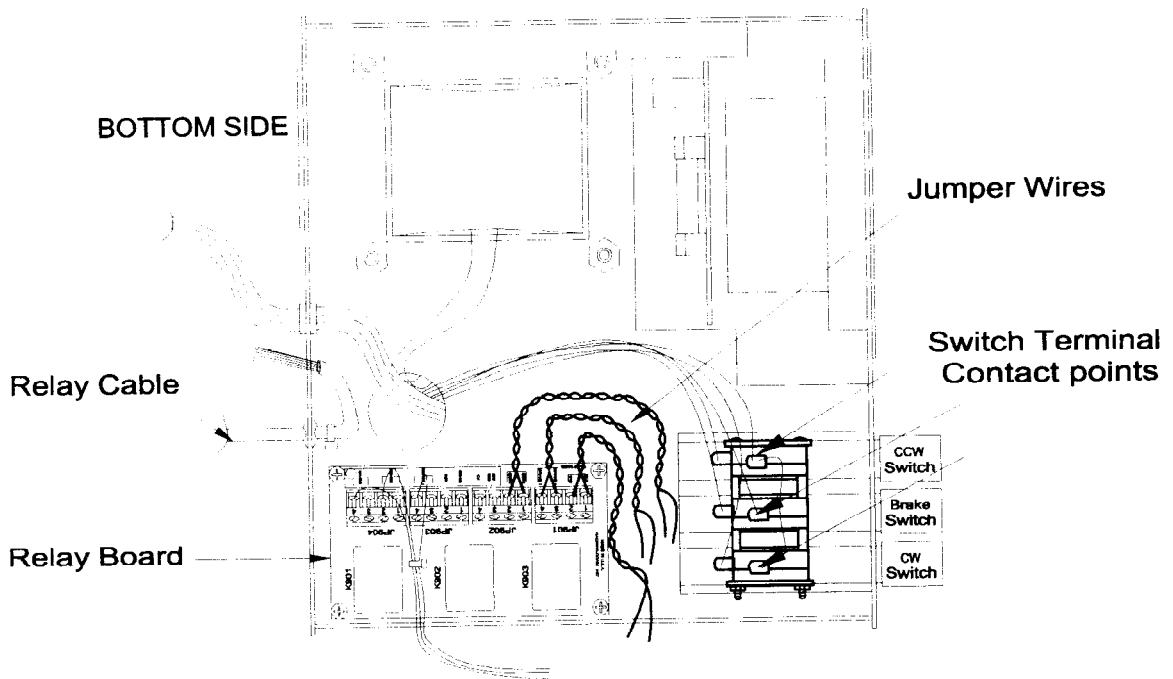

- 4.6 Locate the terminal contact points for CCW, Brake and CW switches. (Note: The twisted pairs of jumper wire pre-attached to the Relay Board are 20 awg wire, 6 inch lengths. If you find that the length of wire does not reach the terminals in your situation, replace the wire with the correct length. Be sure to use only 20 awg wire or heavier!).

Figures 4.7 and 4.8-Relay Board Installation

- 4.7 Solder the wires from the Relay Board JP902 CCW1 and CCW2 to the terminals on the CCW Switch.

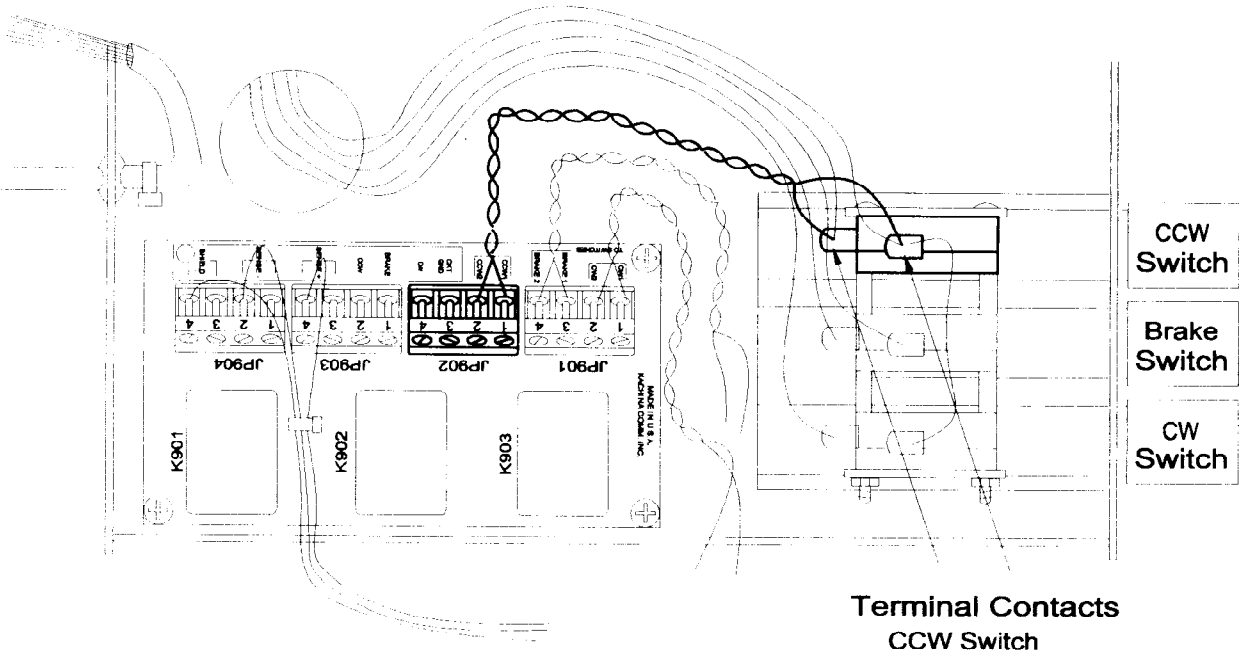

- 4.8 Solder the wires from the Relay Board JP901 Brake1 & Brake2 to the terminals on the Brake Switch.

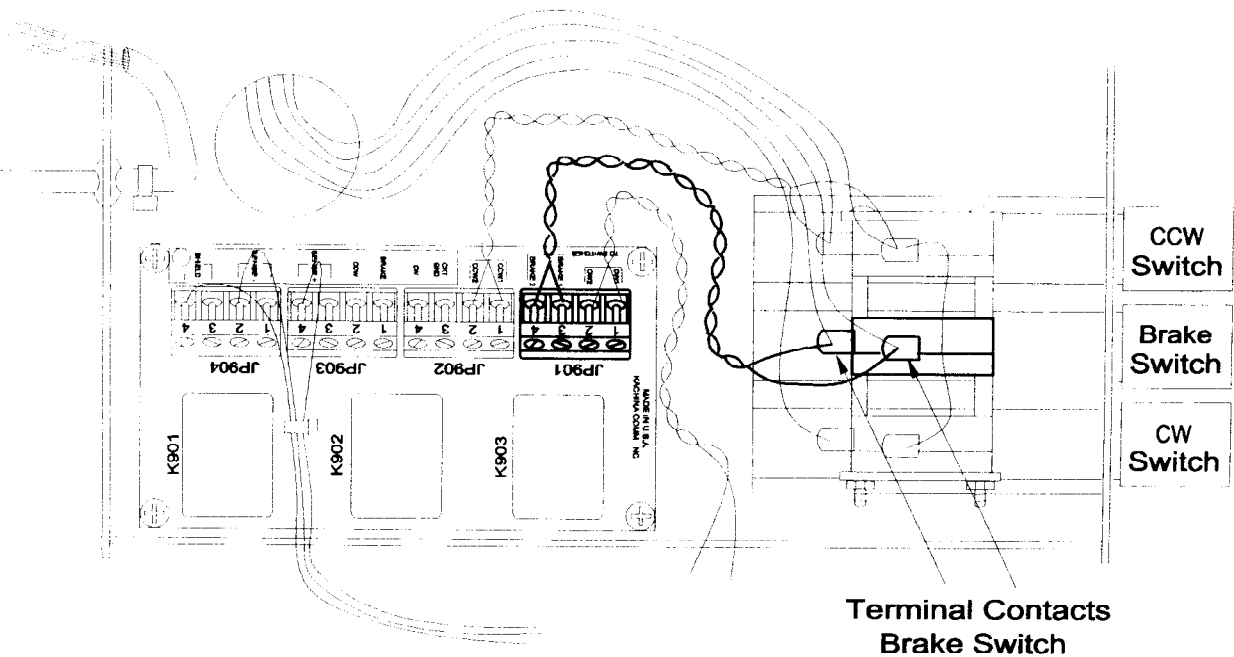

Figures 4.9 and 4.10-Relay Board Installation

- 4.9 Solder the wires from the Relay Board JP901 CW1 & CW2 to the Terminals on the CW switch.

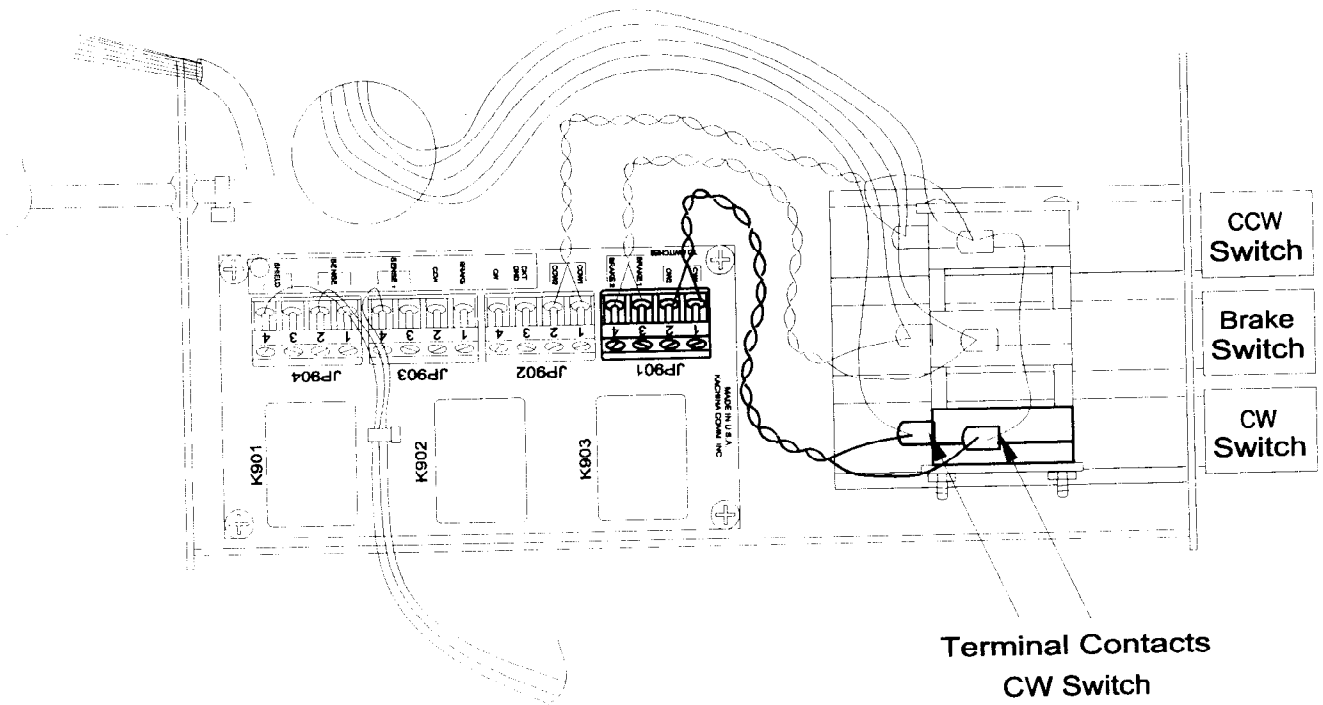

- 4.10 Secure the Relay Cable to the Relay Board by placing a cable tie around the cable and through the hole in the Relay Board. Next connect the wires to the terminal blocks JP901 and JP902 (see wiring diagram Figure 4.11).

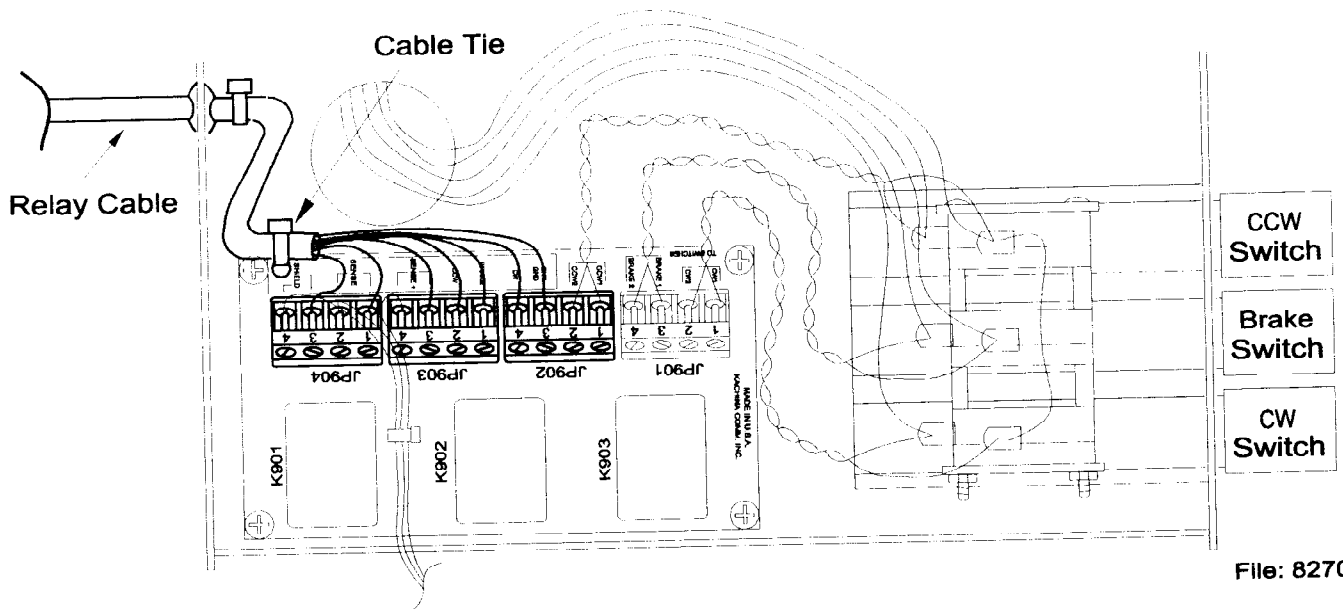

Figures 4.11 and 4.12-Relay Board Installation

Detail View-
Wiring Diagram,
Relay Cable to Terminals

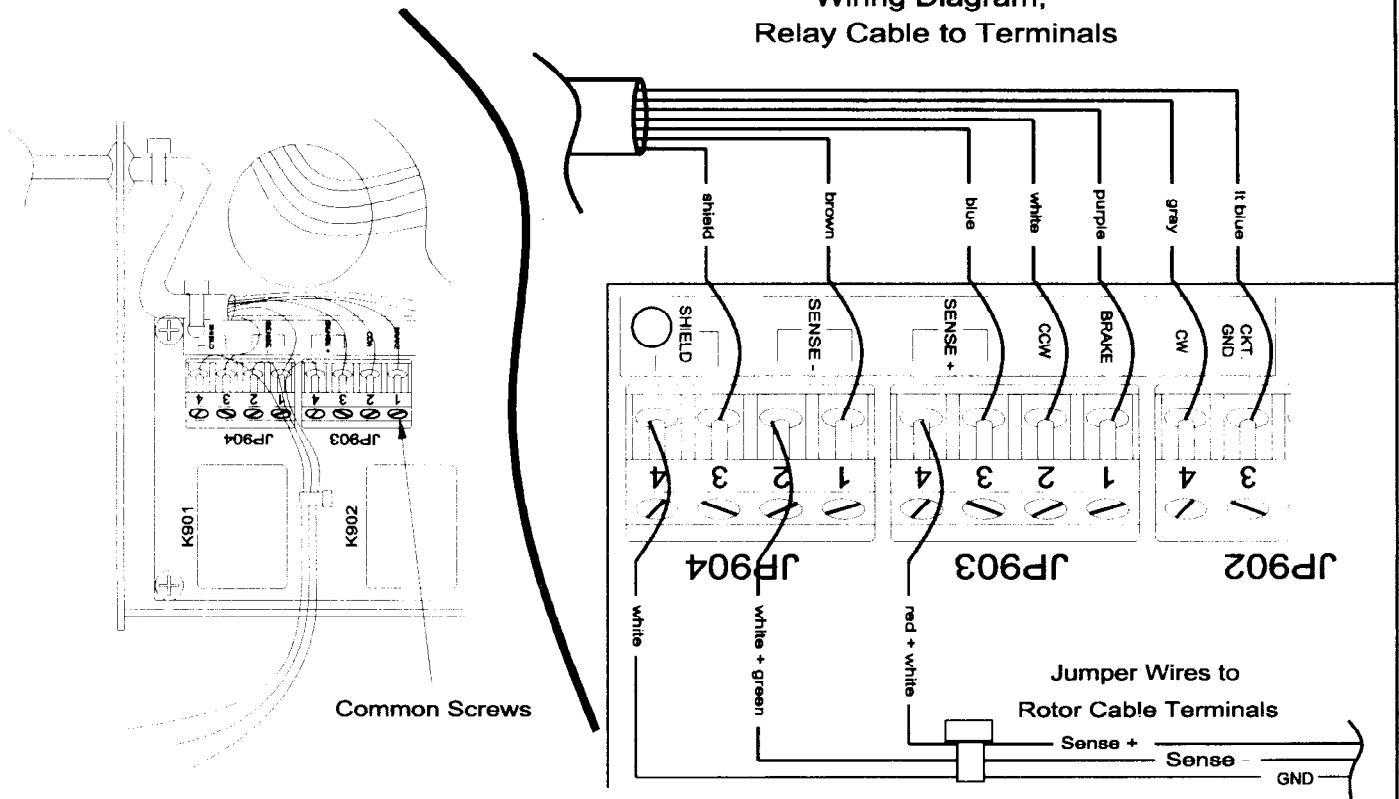

- 4.11 Use a common screwdriver to loosen the terminal screws that hold the wires. Insert the designated wires following the wiring diagram and tighten the screws.

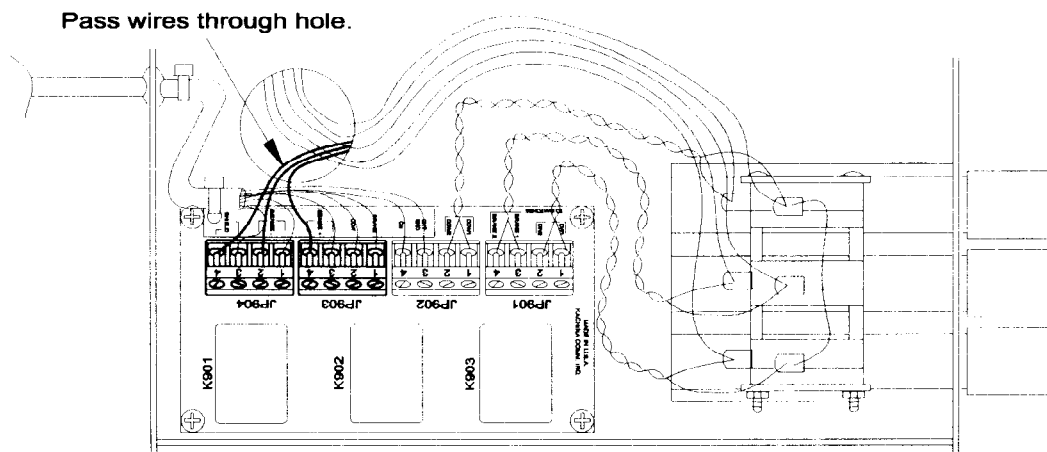

- 4.12 Pass the jumper wires from JP903 (Sense +), JP904 (Sense - and GND), through the hole to the Rotor Cable Terminals.

Figures 4.13 & 4.14-Relay Board Installation

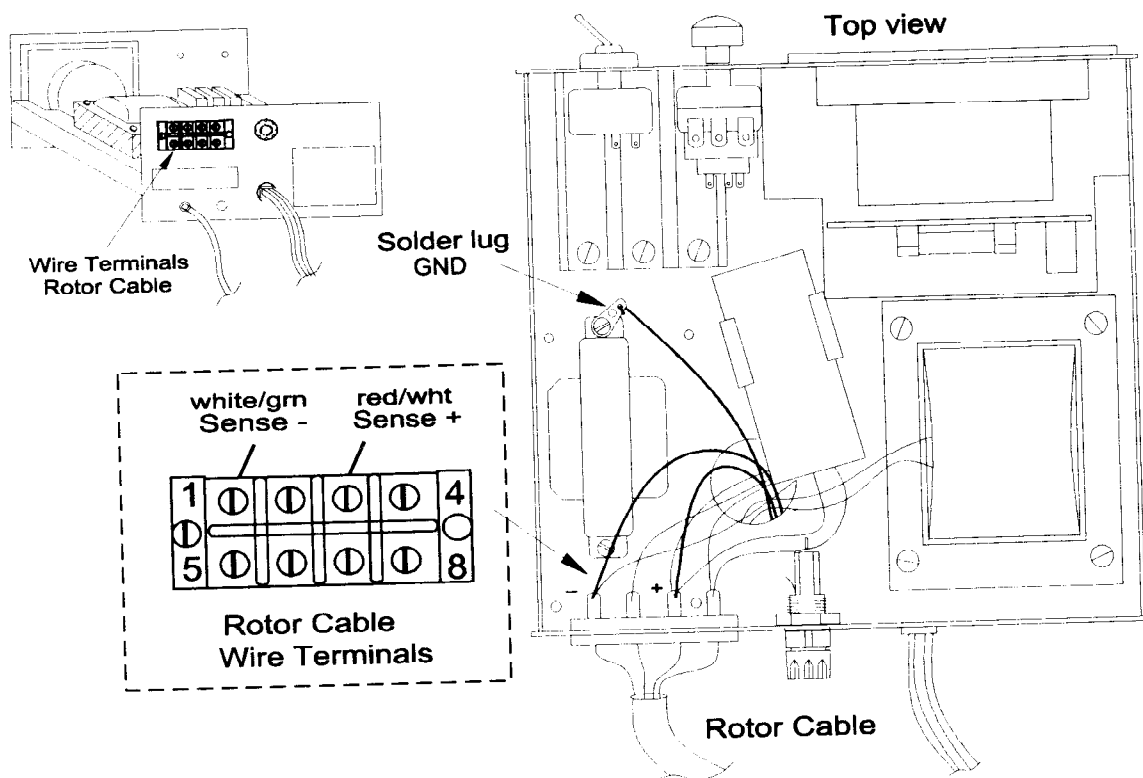

- 4.13** Take the jumper wires from the Relay Board Sense + & Sense - and solder them to the Rotor Cable Terminals 1 & 3. Take the GND wire and solder it to the solder lug located at the bottom of the transformer. Or any screw attached to the chassis.

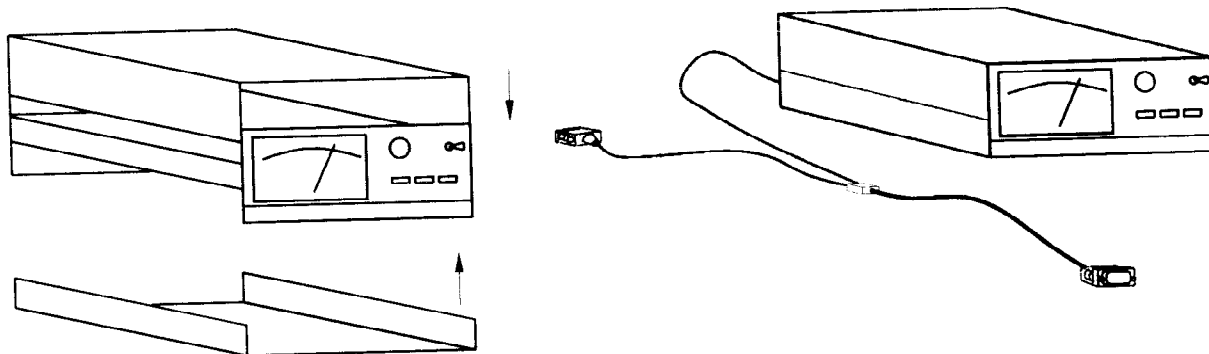

- 4.14** Replace the covers to the Rotor Control Unit. (BE SURE ONCE AGAIN THAT NO METAL SHAVINGS ARE LEFT INSIDE THE UNIT BEFORE YOU CLOSE IT UP).

Figure 6.1-Front and Rear Panel Views, 505AR and 505ARX

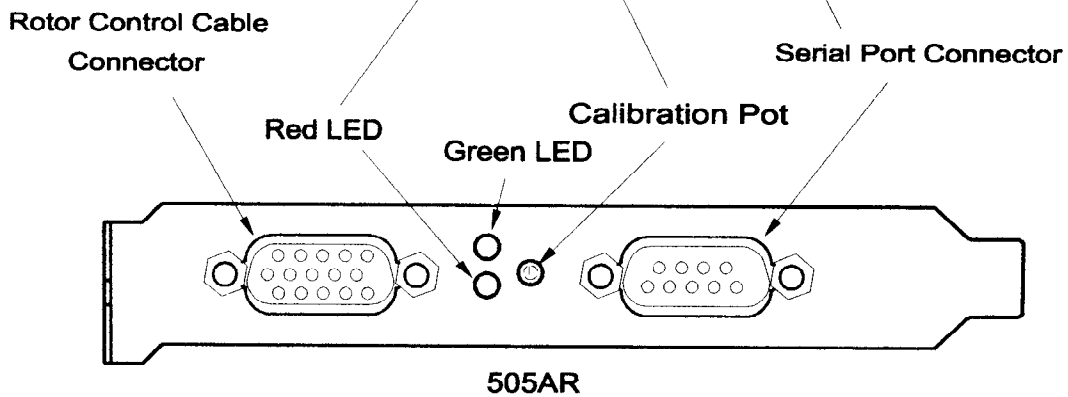
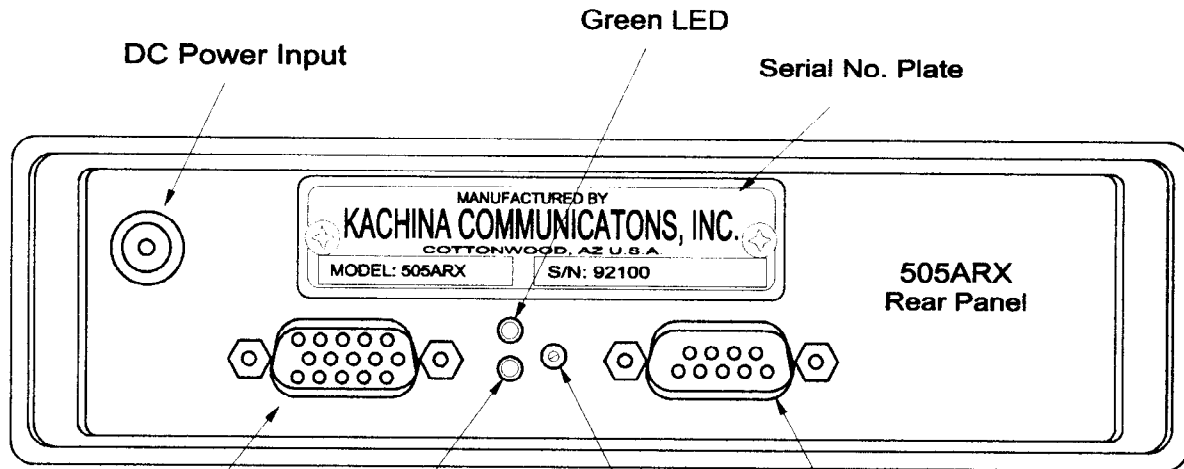
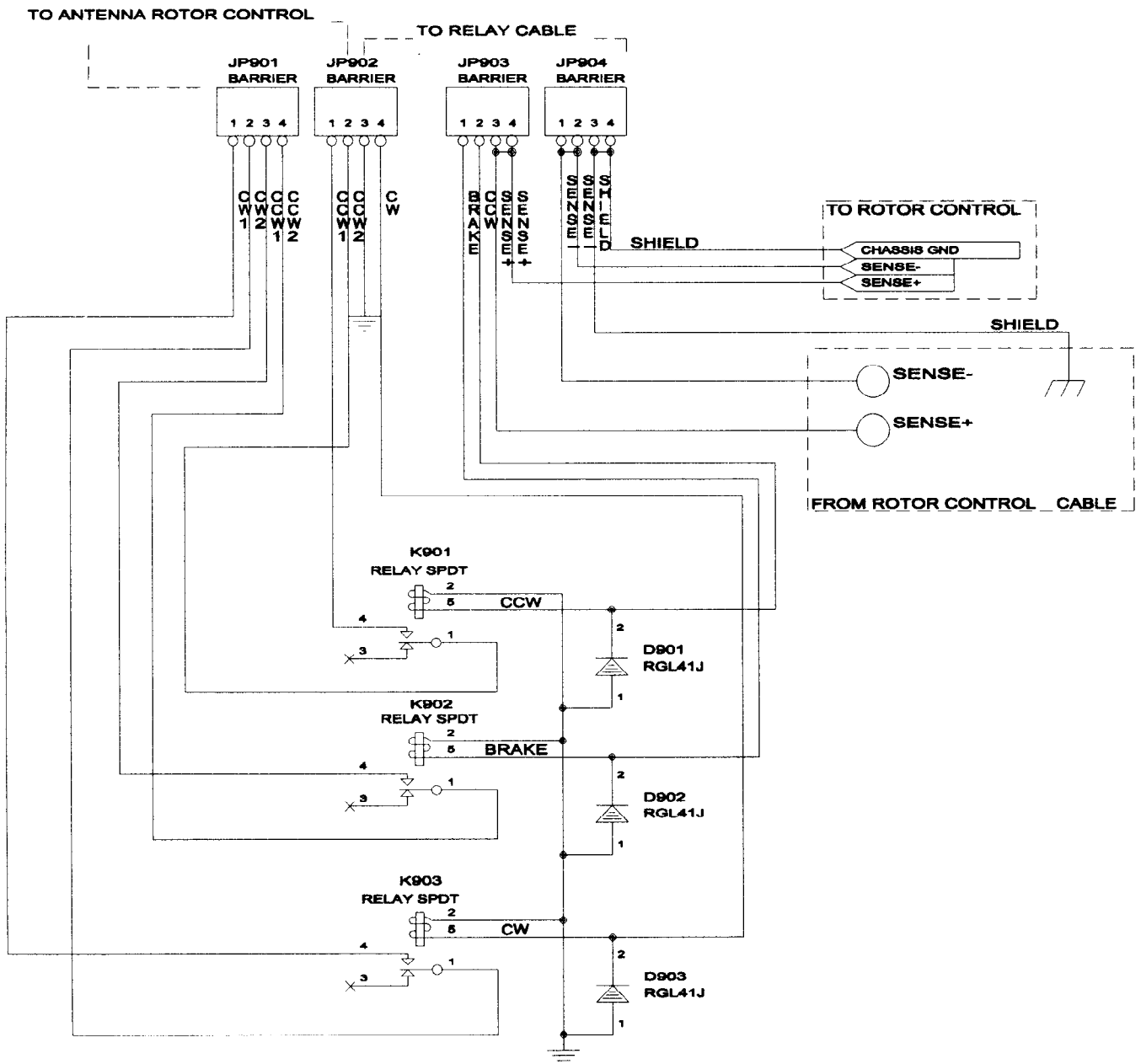

Figure 7.1-Schematic Diagram, Relay Board



Section 7
 Figure 7.2-Auxiliary Connector

INTERCONNECTIONS		
DE-9	FUNCTION	COLOR
PIN 1	GND	BLACK
PIN 2	AUX. DRV. 1	WHT/BLK
PIN 3	AUX. DRV 2	ORANGE
PIN 4	AUX. DRV 3	YELLOW
PIN 5	AUX. DRV 4	GREEN
PIN 6	AUX. DRV 5	LT. GREEN

