

GUYED TOWERS

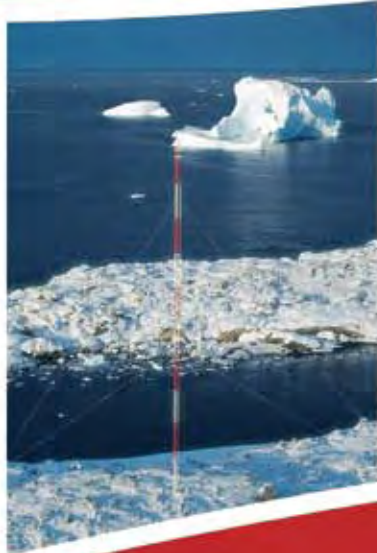



STANDARD 25G GUYED TOWER

ROHN 25G
The first. The original.



25G

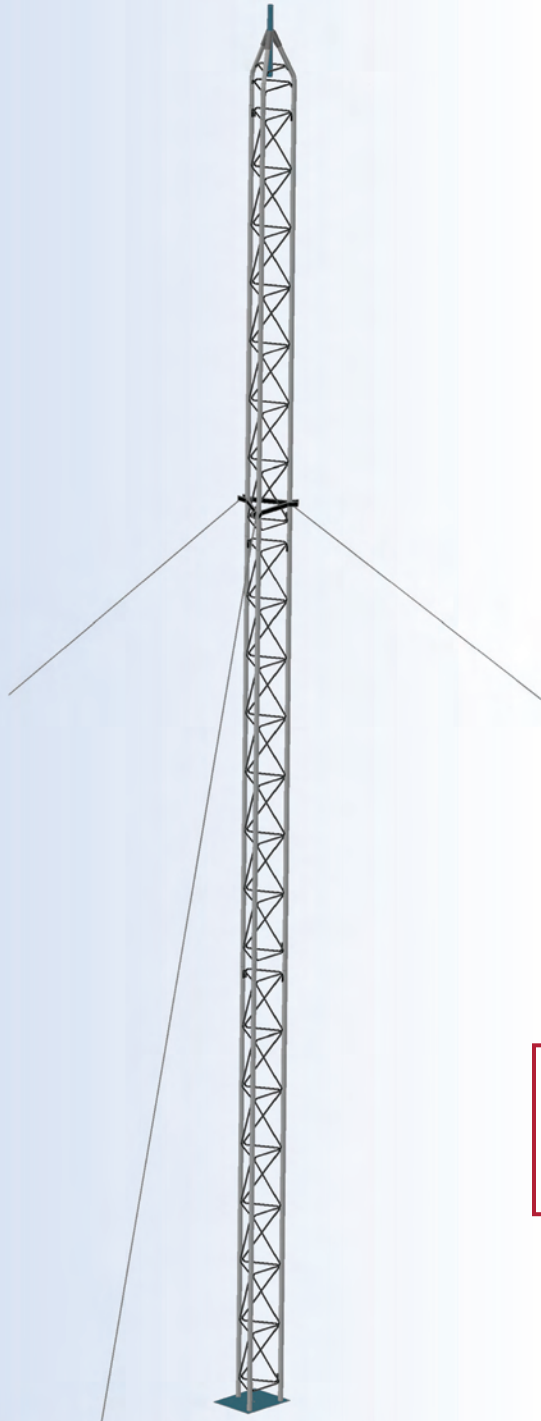

GENERAL USE

The 25G is available in the standard 10' section length and a 7' length which is UPS shippable. The 25G uses double bolted joints, proven to be the best method of joining tower sections for sturdiness and dependability. As a guyed structure, the 25G standard designs rise to a height of 190'.

FEATURES

- Completely hot-dip galvanized after fabrication
- Built on an 11 1/4" equilateral triangle design
- High strength tubular legs joined by Zig-Zag® cross members
- Each 7' or 10' section contains all required nuts and bolts shipped with section
- Continuous solid round steel bracing

CAUTION

Mixing copies of ROHN towers with ROHN towers is dangerous and voids all engineering and warranty data supplied by ROHN. Materials used by others are not the same quality and have not been tested or engineered by ROHN. Mixing ROHN tower sections with non-ROHN products may cause tower failure or injury.

Per Rev G requirements, any structure greater than 10' requires a climber safety device. Please see page 40 for ordering information.



STANDARD 25G GUYED TOWER SECTIONS

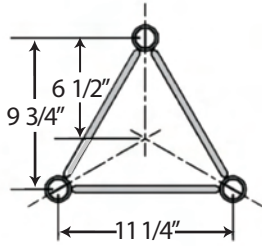

QUICK REFERENCE	
PARTS & ACCESSORIES	PAGES 37-40
GROUNDING INFORMATION	PAGE 41
FOUNDATION INFORMATION	PAGES 41-44

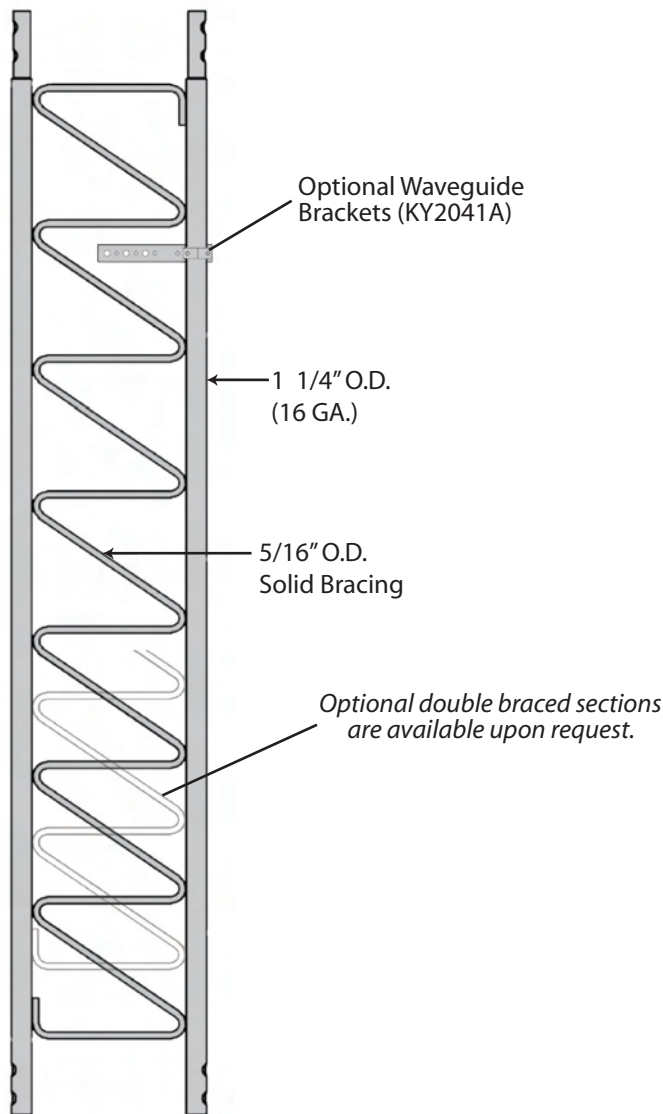

**STANDARD SECTION
25G - 10' Section**

**OPTIONAL 7' SECTION
25G7 - 7' Section**

The 7' Section is UPS shippable.

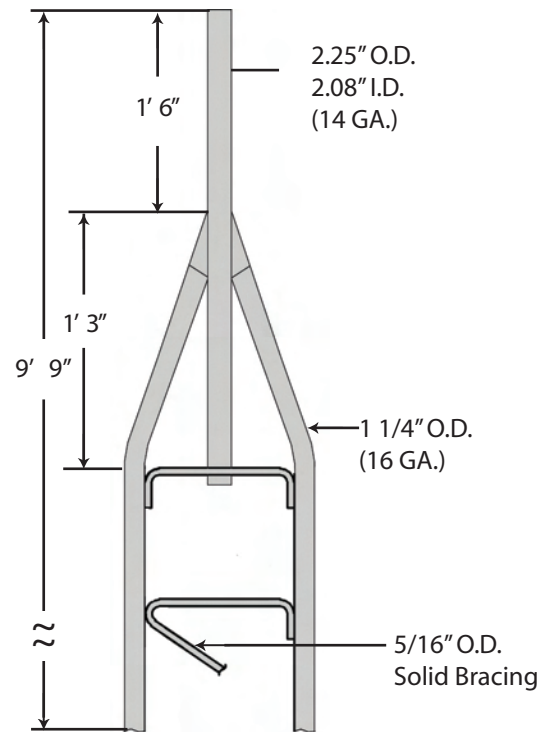

**STANDARD TOP SECTION
25AG2**

Additional 25G top sections are shown on page 37.

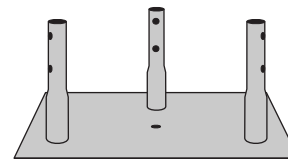

**CONCRETE BASE PLATE
BPC25G***

FOR USE WITH 3/4X12PP PIER PIN
EMBEDDED IN CONCRETE.

Additional base sections are available, please see page 38.

* Towers mounted on these bases must be bracketed or guyed at all times. Temporary steel guying may also be necessary during installation and dismantling.



BUYERS GUIDE
STANDARD DESIGNS - 25G
90MPH REV. G [3-SECOND GUST]
70MPH REV. F [FASTEST MILE]

Design Criteria

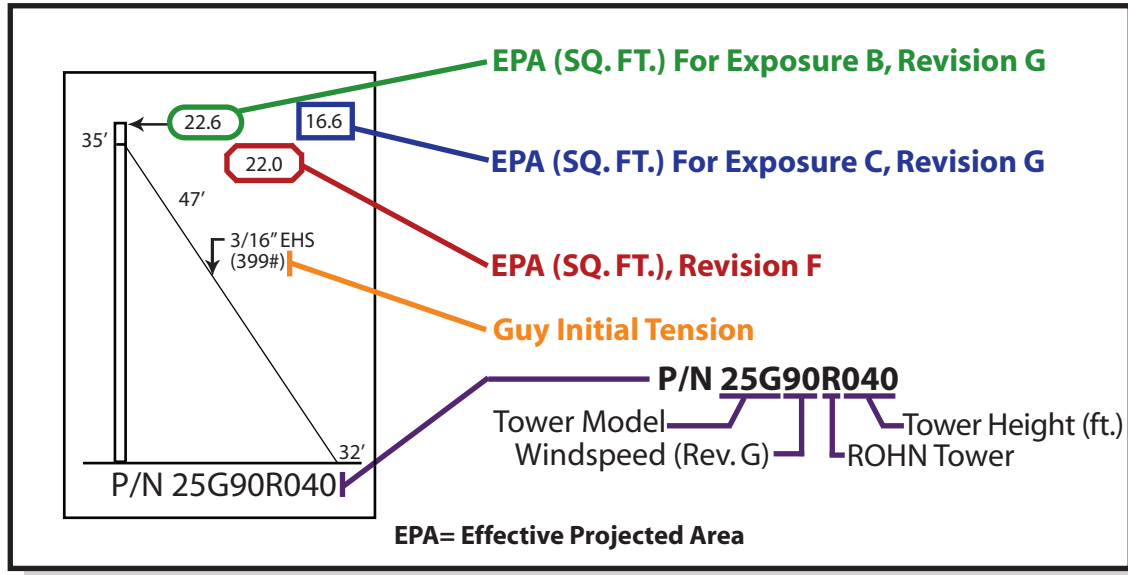

This document is to serve as a guide for sizing and purchasing the 25G tower. Tower and foundation installations should be performed by qualified and experienced personnel using assembly drawings provided with each tower.

DESIGN NOTES:

1. Tower designs are in accordance with ANSI/TIA-222-F and ANSI/TIA-222-G, Class I Structures, Topographic Category 1.
2. Design assumes towers are installed on level ground. Lower EPA values will apply for roof mounted towers or for sites located on unusual terrain.
3. Designs assume two 1/2" diameter lines on each tower face.
4. Anchor radius is from tower base to intersection of anchor rod with ground.
5. Guy chord lengths shown are based on level ground. Initial tensions for guys are shown in () in pounds at 60° Fahrenheit.
6. Antenna and mounts are assumed symmetrically placed at the tower top.

PARTS LIST NOTES:

1. Items listed are required for complete guyed towers.
2. Base and anchor foundations listed refer to standard foundation designations.
3. Guys provided with each standard tower are based on level ground conditions with an additional 6% length.
4. Rev G anchor grounding (AGK1GGX) and base grounding (BGK3GGX) are included with the tower material.
5. Assembly drawings and a safety package (P/N: ACWS) are included with each tower.
6. Parts lists are subject to change based on availability or revised design criteria.

FOR FOUNDATION INFORMATION, PLEASE SEE PAGES 41-44.

FOR GENERAL INSTALLATION INFORMATION, PLEASE SEE PAGES 147-153.



STANDARD DESIGN - 25G 90MPH REV. G, 70MPH REV. F

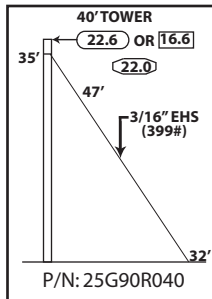

TOWER PARTS INCLUDED	25G	25AG2	BPC25G	GA25GD	FDNS	
					BASE	ANCHOR
	3	1	1	1	CB1G	AB2
GUYS & CONNECTIONS INCLUDED	3/16EHS	BG2142	5/16THH	1/2TB&J	TBSAFETY	
	175'	6	6	3	3	
ANCHORS & GROUNDING INCLUDED	GAC3455TOP	AGK1GGX	BGK3GGX	CPC.5/.75	3/4x12PP	
	3	1	3	3	1	

40' ROHN 25G
All parts shown in table are included when ordering
Part No: 25G90R040

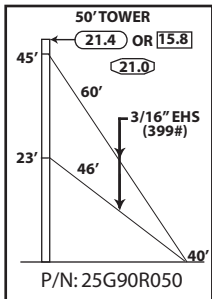

TOWER PARTS INCLUDED	25G	25AG2	BPC25G	GA25GD	FDNS	
					BASE	ANCHOR
	4	1	1	2	CB1G	AB2
GUYS & CONNECTIONS INCLUDED	3/16EHS	BG2142	5/16THH	1/2TB&J	TBSAFETY	
	350'	12	12	6	3	
ANCHORS & GROUNDING INCLUDED	GAC3455TOP	AGK1GGX	BGK3GGX	CPC.5/.75	3/4x12PP	
	3	1	3	3	1	

50' ROHN 25G
All parts shown in table are included when ordering
Part No: 25G90R050

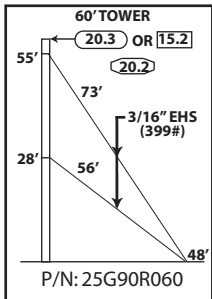

TOWER PARTS INCLUDED	25G	25AG2	BPC25G	GA25GD	FDNS	
					BASE	ANCHOR
	5	1	1	2	CB1G	AB2
GUYS & CONNECTIONS INCLUDED	3/16EHS	BG2142	5/16THH	1/2TB&J	TBSAFETY	
	425'	12	12	6	3	
ANCHORS & GROUNDING INCLUDED	GAC3455TOP	AGK1GGX	BGK3GGX	CPC.5/.75	3/4x12PP	
	3	1	3	3	1	

60' ROHN 25G
All parts shown in table are included when ordering
Part No: 25G90R060

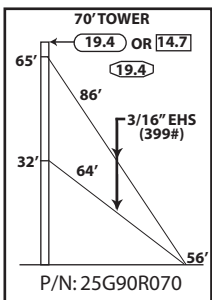

TOWER PARTS INCLUDED	25G	25AG2	BPC25G	GA25GD	FDNS	
					BASE	ANCHOR
	6	1	1	2	CB1G	AB2
GUYS & CONNECTIONS INCLUDED	3/16EHS	BG2142	5/16THH	1/2TB&J	TBSAFETY	
	500'	12	12	6	3	
ANCHORS & GROUNDING INCLUDED	GAC3455TOP	AGK1GGX	BGK3GGX	CPC.5/.75	3/4x12PP	
	3	1	3	3	1	

70' ROHN 25G
All parts shown in table are included when ordering
Part No: 25G90R070

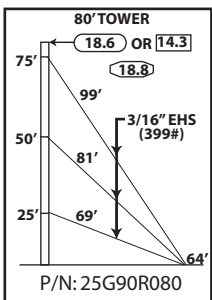

TOWER PARTS INCLUDED	25G	25AG2	BPC25G	GA25GD	FDNS	
					BASE	ANCHOR
	7	1	1	3	CB1G	AB2
GUYS & CONNECTIONS INCLUDED	3/16EHS	BG2142	5/16THH	1/2TB&J	TBSAFETY	
	800'	18	18	9	3	
ANCHORS & GROUNDING INCLUDED	GAC3455TOP	AGK1GGX	BGK3GGX	CPC.5/.75	3/4x12PP	
	3	1	3	3	1	

80' ROHN 25G
All parts shown in table are included when ordering
Part No: 25G90R080



STANDARD DESIGN - 25G
90MPH REV. G, 70MPH REV. F

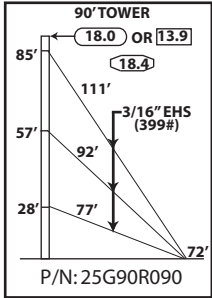

TOWER PARTS INCLUDED	25G	25AG2	BPC25G	GA25GD	FDNS	
					BASE	ANCHOR
	8	1	1	3	CB1G	AB2
GUYS & CONNECTIONS INCLUDED	3/16EHS	BG2142	5/16THH	1/2TBE&J	TBSAFETY	
	900'	18	18	9	3	
ANCHORS & GROUNDING INCLUDED	GAC3455TOP	AGK1GGX	BGK3GGX	CPC.5/.75	3/4x12PP	
	3	1	3	3	1	

90' ROHN 25G
All parts shown in table are included when ordering
Part No: 25G90R090

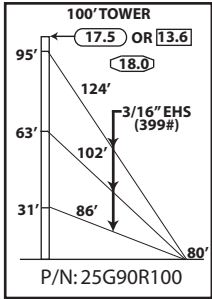

TOWER PARTS INCLUDED	25G	25AG2	BPC25G	GA25GD	FDNS	
					BASE	ANCHOR
	9	1	1	3	CB1G	AB2
GUYS & CONNECTIONS INCLUDED	3/16EHS	BG2142	5/16THH	1/2TBE&J	TBSAFETY	
	1000'	18	18	9	3	
ANCHORS & GROUNDING INCLUDED	GAC3455TOP	AGK1GGX	BGK3GGX	CPC.5/.75	3/4x12PP	
	3	1	3	3	1	

100' ROHN 25G
All parts shown in table are included when ordering
Part No: 25G90R100

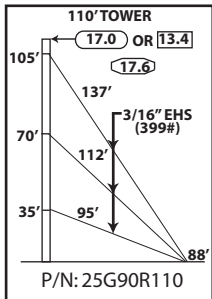

TOWER PARTS INCLUDED	25G	25AG2	BPC25G	GA25GD	FDNS	
					BASE	ANCHOR
	10	1	1	3	CB1G	AB2
GUYS & CONNECTIONS INCLUDED	3/16EHS	BG2142	5/16THH	1/2TBE&J	TBSAFETY	
	1100'	18	18	9	3	
ANCHORS & GROUNDING INCLUDED	GAC3455TOP	AGK1GGX	BGK3GGX	CPC.5/.75	3/4x12PP	
	3	1	3	3	1	

110' ROHN 25G
All parts shown in table are included when ordering
Part No: 25G90R110

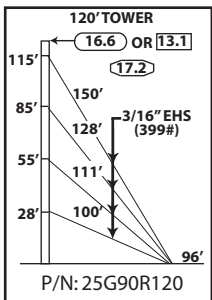

TOWER PARTS INCLUDED	25G	25AG2	BPC25G	GA25GD	FDNS	
					BASE	ANCHOR
	11	1	1	4	CB1G	AB2
GUYS & CONNECTIONS INCLUDED	3/16EHS	BG2142	5/16THH	1/2TBE&J	TBSAFETY	
	1575'	24	24	12	3	
ANCHORS & GROUNDING INCLUDED	GAC3455TOP	AGK1GGX	BGK3GGX	CPC.5/.75	3/4x12PP	
	3	1	3	3	1	

120' ROHN 25G
All parts shown in table are included when ordering
Part No: 25G90R120

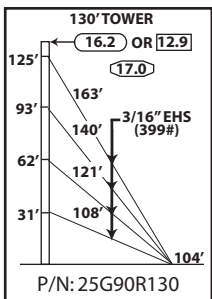

TOWER PARTS INCLUDED	25G	25AG2	BPC25G	GA25GD	FDNS	
					BASE	ANCHOR
	12	1	1	4	CB1G	AB2
GUYS & CONNECTIONS INCLUDED	3/16EHS	BG2142	5/16THH	1/2TBE&J	TBSAFETY	
	1700'	24	24	12	3	
ANCHORS & GROUNDING INCLUDED	GAC3455TOP	AGK1GGX	BGK3GGX	CPC.5/.75	3/4x12PP	
	3	1	3	3	1	

130' ROHN 25G
All parts shown in table are included when ordering
Part No: 25G90R130



STANDARD DESIGN - 25G 90MPH REV. G, 70MPH REV. F

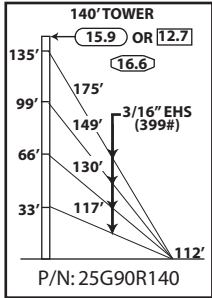

TOWER PARTS INCLUDED	25G	25AG2	BPC25G	GA25GD	FDNS	
					BASE	ANCHOR
TOWER PARTS INCLUDED	13	1	1	4	CB1G	AB2
GUYS & CONNECTIONS INCLUDED	3/16EHS	BG2142	5/16THH	1/2TBE&J	TBSAFETY	
	1825'	24	24	12	3	
ANCHORS & GROUNDING INCLUDED	GAC3455TOP	AGK1GGX	BGK3GGX	CPC.5/.75	3/4x12PP	
	3	1	3	3	1	

140' ROHN 25G
All parts shown in table are included when ordering
Part No: 25G90R140

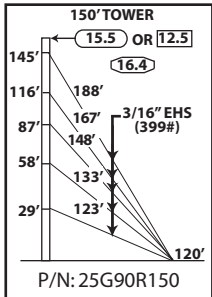

TOWER PARTS INCLUDED	25G	25AG2	BPC25G	GA25GD	FDNS	
					BASE	ANCHOR
TOWER PARTS INCLUDED	14	1	1	5	CB1G	AB2
GUYS & CONNECTIONS INCLUDED	3/16EHS	BG2142	5/16THH	1/2TBE&J	TBSAFETY	
	2425'	30	30	15	3	
ANCHORS & GROUNDING INCLUDED	GAC3455TOP	AGK1GGX	BGK3GGX	CPC.5/.75	3/4x12PP	
	3	1	3	3	1	

150' ROHN 25G
All parts shown in table are included when ordering
Part No: 25G90R150

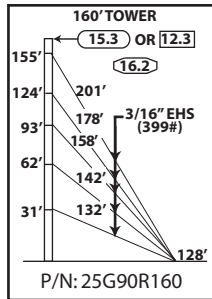

TOWER PARTS INCLUDED	25G	25AG2	BPC25G	GA25GD	FDNS	
					BASE	ANCHOR
TOWER PARTS INCLUDED	15	1	1	5	CB1G	AB2
GUYS & CONNECTIONS INCLUDED	3/16EHS	BG2142	5/16THH	1/2TBE&J	TBSAFETY	
	2600'	30	30	15	3	
ANCHORS & GROUNDING INCLUDED	GAC3455TOP	AGK1GGX	BGK3GGX	CPC.5/.75	3/4x12PP	
	3	1	3	3	1	

160' ROHN 25G
All parts shown in table are included when ordering
Part No: 25G90R160

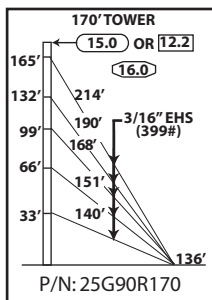

TOWER PARTS INCLUDED	25G	25AG2	BPC25G	GA25GD	FDNS	
					BASE	ANCHOR
TOWER PARTS INCLUDED	16	1	1	5	CB1G	AB2
GUYS & CONNECTIONS INCLUDED	3/16EHS	BG2142	5/16THH	1/2TBE&J	TBSAFETY	
	2750'	30	30	15	3	
ANCHORS & GROUNDING INCLUDED	GAC3455TOP	AGK1GGX	BGK3GGX	CPC.5/.75	3/4x12PP	
	3	1	3	3	1	

170' ROHN 25G
All parts shown in table are included when ordering
Part No: 25G90R170

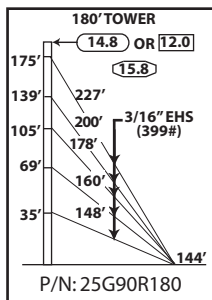

TOWER PARTS INCLUDED	25G	25AG2	BPC25G	GA25GD	FDNS	
					BASE	ANCHOR
TOWER PARTS INCLUDED	17	1	1	5	CB1G	AB2
GUYS & CONNECTIONS INCLUDED	3/16EHS	BG2142	5/16THH	1/2TBE&J	TBSAFETY	
	2925'	30	30	15	3	
ANCHORS & GROUNDING INCLUDED	GAC3455TOP	AGK1GGX	BGK3GGX	CPC.5/.75	3/4x12PP	
	3	1	3	3	1	

180' ROHN 25G
All parts shown in table are included when ordering
Part No: 25G90R180



STANDARD DESIGN - 25G 90MPH REV. G, 70MPH REV. F

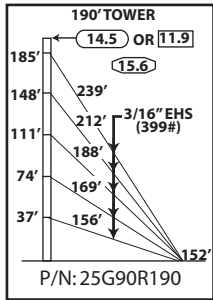

TOWER PARTS INCLUDED	25G	25AG2	BPC25G	GA25GD	FDNS	
					BASE	ANCHOR
	18	1	1	5	CB1G	AB2
GUYS & CONNECTIONS INCLUDED	3/16EHS	BG2142	5/16THH	1/2TBE&J	TBSAFETY	
	3075'	30	30	15	3	
ANCHORS & GROUNDING INCLUDED	GAC3455TOP	AGK1GGX	BGK3GGX	CPC.5/.75	3/4x12PP	
	3	1	3	3	1	

190' ROHN 25G
All parts shown in table are included when ordering
Part No: 25G90R190



STANDARD DESIGN - 25G

110MPH REV. G, 90MPH REV. F

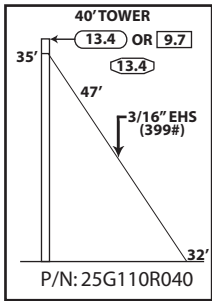

TOWER PARTS INCLUDED	25G	25AG2	BPC25G	GA25GD	FDNS	
					BASE	ANCHOR
	3	1	1	1	CB1G	AB2
GUYS & CONNECTIONS INCLUDED	3/16EHS	BG2142	5/16THH	1/2TBE&J	TBSAFETY	
	175'	6	6	3	3	
ANCHORS & GROUNDING INCLUDED	GAC3455TOP	AGK1GGX	BGK3GGX	CPC.5/.75	3/4x12PP	
	3	1	3	3	1	

40' ROHN 25G
All parts shown in table are included when ordering
Part No: 25G110R040

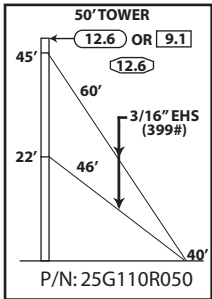

TOWER PARTS INCLUDED	25G	25AG2	BPC25G	GA25GD	FDNS	
					BASE	ANCHOR
	4	1	1	2	CB1G	AB2
GUYS & CONNECTIONS INCLUDED	3/16EHS	BG2142	5/16THH	1/2TBE&J	TBSAFETY	
	350'	12	12	6	3	
ANCHORS & GROUNDING INCLUDED	GAC3455TOP	AGK1GGX	BGK3GGX	CPC.5/.75	3/4x12PP	
	3	1	3	3	1	

50' ROHN 25G
All parts shown in table are included when ordering
Part No: 25G110R050

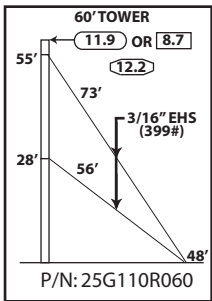

TOWER PARTS INCLUDED	25G	25AG2	BPC25G	GA25GD	FDNS	
					BASE	ANCHOR
	5	1	1	2	CB1G	AB2
GUYS & CONNECTIONS INCLUDED	3/16EHS	BG2142	5/16THH	1/2TBE&J	TBSAFETY	
	425'	12	12	6	3	
ANCHORS & GROUNDING INCLUDED	GAC3455TOP	AGK1GGX	BGK3GGX	CPC.5/.75	3/4x12PP	
	3	1	3	3	1	

60' ROHN 25G
All parts shown in table are included when ordering
Part No: 25G110R060

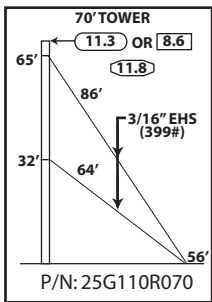

TOWER PARTS INCLUDED	25G	25AG2	BPC25G	GA25GD	FDNS	
					BASE	ANCHOR
	6	1	1	2	CB1G	AB2
GUYS & CONNECTIONS INCLUDED	3/16EHS	BG2142	5/16THH	1/2TBE&J	TBSAFETY	
	500'	12	12	6	3	
ANCHORS & GROUNDING INCLUDED	GAC3455TOP	AGK1GGX	BGK3GGX	CPC.5/.75	3/4x12PP	
	3	1	3	3	1	

70' ROHN 25G
All parts shown in table are included when ordering
Part No: 25G110R070

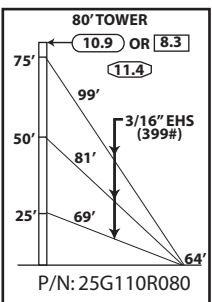

TOWER PARTS INCLUDED	25G	25AG2	BPC25G	GA25GD	FDNS	
					BASE	ANCHOR
	7	1	1	3	CB1G	AB2
GUYS & CONNECTIONS INCLUDED	3/16 EHS	BG2142	5/16 THH	1/2TBE&J	TBSAFETY	
	800'	18	18	9	3	
ANCHORS & GROUNDING INCLUDED	GAC3455TOP	AGK1GGX	BGK3GGX	CPC.5/.75	3/4x12PP	
	3	1	3	3	1	

80' ROHN 25G
All parts shown in table are included when ordering
Part No: 25G110R080



STANDARD DESIGN - 25G
110MPH REV. G, 90MPH REV. F

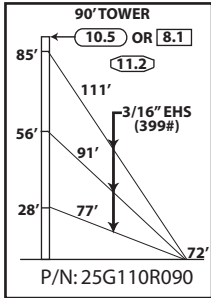

TOWER PARTS INCLUDED	25G	25AG2	BPC25G	GA25GD	FDNS	
					BASE	ANCHOR
	8	1	1	3	CB1G	AB2
GUYS & CONNECTIONS INCLUDED	3/16EHS	BG2142	5/16THH	1/2TBE&J	TBSAFETY	
	900'	18	18	9	3	
ANCHORS & GROUNDING INCLUDED	GAC3455TOP	AGK1GGX	BGK3GGX	CPC.5/.75	3/4x12PP	
	3	1	3	3	1	

90' ROHN 25G
All parts shown in table are included when ordering
Part No: 25G110R090

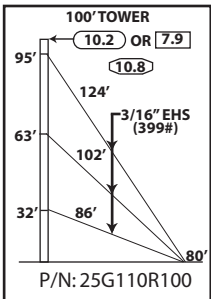

TOWER PARTS INCLUDED	25G	25AG2	BPC25G	GA25GD	FDNS	
					BASE	ANCHOR
	9	1	1	3	CB1G	AB2
GUYS & CONNECTIONS INCLUDED	3/16EHS	BG2142	5/16THH	1/2TBE&J	TBSAFETY	
	1000'	18	18	9	3	
ANCHORS & GROUNDING INCLUDED	GAC3455TOP	AGK1GGX	BGK3GGX	CPC.5/.75	3/4x12PP	
	3	1	3	3	1	

100' ROHN 25G
All parts shown in table are included when ordering
Part No: 25G110R100

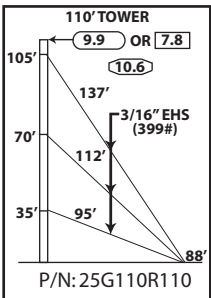

TOWER PARTS INCLUDED	25G	25AG2	BPC25G	GA25GD	FDNS	
					BASE	ANCHOR
	10	1	1	3	CB1G	AB2
GUYS & CONNECTIONS INCLUDED	3/16EHS	BG2142	5/16THH	1/2TBE&J	TBSAFETY	
	1100'	18	18	9	3	
ANCHORS & GROUNDING INCLUDED	GAC3455TOP	AGK1GGX	BGK3GGX	CPC.5/.75	3/4x12PP	
	3	1	3	3	1	

110' ROHN 25G
All parts shown in table are included when ordering
Part No: 25G110R110

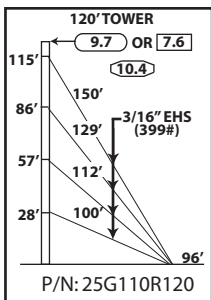

TOWER PARTS INCLUDED	25G	25AG2	BPC25G	GA25GD	FDNS	
					BASE	ANCHOR
	11	1	1	4	CB1G	AB2
GUYS & CONNECTIONS INCLUDED	3/16EHS	BG2142	5/16THH	1/2TBE&J	TBSAFETY	
	1575'	24	24	12	3	
ANCHORS & GROUNDING INCLUDED	GAC3455TOP	AGK1GGX	BGK3GGX	CPC.5/.75	3/4x12PP	
	3	1	3	3	1	

120' ROHN 25G
All parts shown in table are included when ordering
Part No: 25G110R120

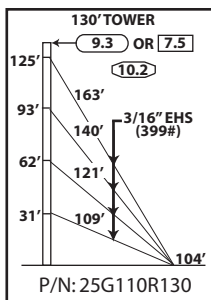

TOWER PARTS INCLUDED	25G	25AG2	BPC25G	GA25GD	FDNS	
					BASE	ANCHOR
	12	1	1	4	CB1G	AB2
GUYS & CONNECTIONS INCLUDED	3/16EHS	BG2142	5/16THH	1/2TBE&J	TBSAFETY	
	1700'	24	24	12	3	
ANCHORS & GROUNDING INCLUDED	GAC3455TOP	AGK1GGX	BGK3GGX	CPC.5/.75	3/4x12PP	
	3	1	3	3	1	

130' ROHN 25G
All parts shown in table are included when ordering
Part No: 25G110R130



STANDARD DESIGN - 25G
110MPH REV. G, 90MPH REV. F

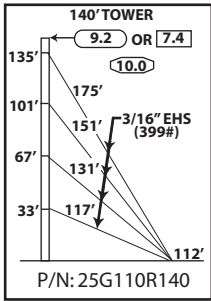

TOWER PARTS INCLUDED	25G	25AG2	BPC25G	GA25GD	FDNS	
					BASE	ANCHOR
	13	1	1	4	CB1G	AB2
GUYS & CONNECTIONS INCLUDED	3/16EHS	BG2142	5/16THH	1/2TBE&J	TBSAFETY	
	1825'	24	24	12	3	
ANCHORS & GROUNDING INCLUDED	GAC3455TOP	AGK1GGX	BGK3GGX	CPC.5/.75	3/4x12PP	
	3	1	3	3	1	

140' ROHN 25G
All parts shown in table are included when ordering
Part No: 25G110R140

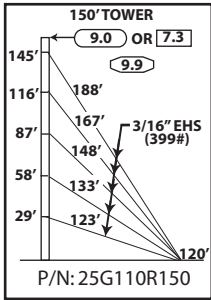

TOWER PARTS INCLUDED	25G	25AG2	BPC25G	GA25GD	FDNS	
					BASE	ANCHOR
	14	1	1	5	CB1G	AB2
GUYS & CONNECTIONS INCLUDED	3/16EHS	BG2142	5/16THH	1/2TBE&J	TBSAFETY	
	2425'	30	30	15	3	
ANCHORS & GROUNDING INCLUDED	GAC3455TOP	AGK1GGX	BGK3GGX	CPC.5/.75	3/4x12PP	
	3	1	3	3	1	

150' ROHN 25G
All parts shown in table are included when ordering
Part No: 25G110R150

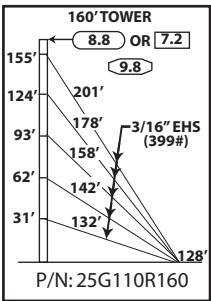

TOWER PARTS INCLUDED	25G	25AG2	BPC25G	GA25GD	FDNS	
					BASE	ANCHOR
	15	1	1	5	CB1G	AB2
GUYS & CONNECTIONS INCLUDED	3/16EHS	BG2142	5/16THH	1/2TBE&J	TBSAFETY	
	2600'	30	30	15	3	
ANCHORS & GROUNDING INCLUDED	GAC3455TOP	AGK1GGX	BGK3GGX	CPC.5/.75	3/4x12PP	
	3	1	3	3	1	

160' ROHN 25G
All parts shown in table are included when ordering
Part No: 25G110R160

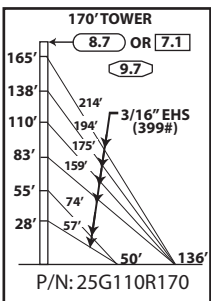

TOWER PARTS INCLUDED	25G	25AG2	BPC25G	GA25GD	BASE	INNER ANCHOR	OUTER ANCHOR
					CB2G	AB2	AB2
	16	1	1	6	CB2G	AB2	AB2
GUYS & CONNECTIONS INCLUDED	3/16EHS	BG2142	5/16THH	1/2TBE&J	TBSAFETY		
	2800'	36	36	18	6		
ANCHORS & GROUNDING INCLUDED	GAC3455TOP	AGK1GGX	BGK3GGX	CPC.5/.75	3/4x12PP		
	6	2	3	6	1		

170' ROHN 25G
All parts shown in table are included when ordering
Part No: 25G110R170

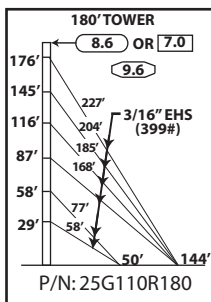

TOWER PARTS INCLUDED	25G	25AG2	BPC25G	GA25GD	BASE	INNER ANCHOR	OUTER ANCHOR
					CB2G	AB2	AB2
	17	1	1	6	CB2G	AB2	AB2
GUYS & CONNECTIONS INCLUDED	3/16EHS	BG2142	5/16THH	1/2TBE&J	TBSAFETY		
	2925'	36	36	18	6		
ANCHORS & GROUNDING INCLUDED	GAC3455TOP	AGK1GGX	BGK3GGX	CPC.5/.75	3/4x12PP		
	6	2	3	6	1		

180' ROHN 25G
All parts shown in table are included when ordering
Part No: 25G110R180



STANDARD DESIGN - 25G
110MPH REV. G, 90MPH REV. F

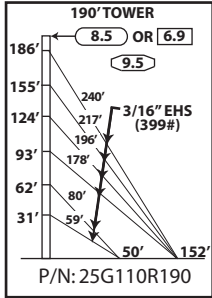

TOWER PARTS INCLUDED	25G	25AG2	BPC25G	GA25GD	BASE	INNER ANCHOR	OUTER ANCHOR
		18	1	1	6	CB2G	AB2
GUYS & CONNECTIONS INCLUDED	3/16EHS	BG2142	5/16THH	1/2TBE&J	TBSAFETY		
	3100'	36	36	18	6		
ANCHORS & GROUNDING INCLUDED	GAC3455TOP	AGK1GGX	BGK3GGX	CPC.5/.75	3/4x12PP		
	6	2	3	6	1		

190' ROHN 25G
All parts shown in table are included when ordering
Part No: 25G110R190



STANDARD DESIGN - 25G

130MPH REV. G, 110MPH REV. F

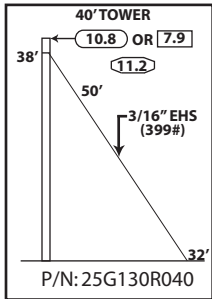

TOWER PARTS INCLUDED	25G	25AG2	BPC25G	GA25GD	FDNS	
					BASE	ANCHOR
	3	1	1	1	CB1G	AB2
GUYS & CONNECTIONS INCLUDED	3/16EHS	BG2142	5/16THH	1/2TBE&J	TBSAFETY	
	175'	6	6	3	3	
ANCHORS & GROUNDING INCLUDED	GAC3455TOP	AGK1GGX	BGK3GGX	CPC.5/.75	3/4x12PP	
	3	1	3	3	1	

40' ROHN 25G
All parts shown in table are included when ordering
Part No: 25G130R040

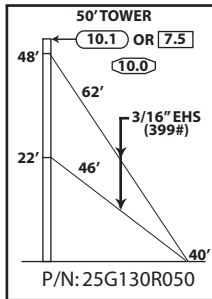

TOWER PARTS INCLUDED	25G	25AG2	BPC25G	GA25GD	FDNS	
					BASE	ANCHOR
	4	1	1	2	CB1G	AB2
GUYS & CONNECTIONS INCLUDED	3/16EHS	BG2142	5/16THH	1/2TBE&J	TBSAFETY	
	350'	12	12	6	3	
ANCHORS & GROUNDING INCLUDED	GAC3455TOP	AGK1GGX	BGK3GGX	CPC.5/.75	3/4x12PP	
	3	1	3	3	1	

50' ROHN 25G
All parts shown in table are included when ordering
Part No: 25G130R050

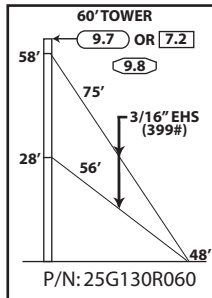

TOWER PARTS INCLUDED	25G	25AG2	BPC25G	GA25GD	FDNS	
					BASE	ANCHOR
	5	1	1	2	CB1G	AB2
GUYS & CONNECTIONS INCLUDED	3/16EHS	BG2142	5/16THH	1/2TBE&J	TBSAFETY	
	425'	12	12	6	3	
ANCHORS & GROUNDING INCLUDED	GAC3455TOP	AGK1GGX	BGK3GGX	CPC.5/.75	3/4x12PP	
	3	1	3	3	1	

60' ROHN 25G
All parts shown in table are included when ordering
Part No: 25G130R060

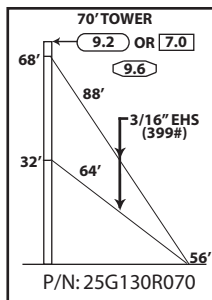

TOWER PARTS INCLUDED	25G	25AG2	BPC25G	GA25GD	FDNS	
					BASE	ANCHOR
	6	1	1	2	CB1G	AB2
GUYS & CONNECTIONS INCLUDED	3/16EHS	BG2142	5/16THH	1/2TBE&J	TBSAFETY	
	500'	12	12	6	3	
ANCHORS & GROUNDING INCLUDED	GAC3455TOP	AGK1GGX	BGK3GGX	CPC.5/.75	3/4x12PP	
	3	1	3	3	1	

70' ROHN 25G
All parts shown in table are included when ordering
Part No: 25G130R070

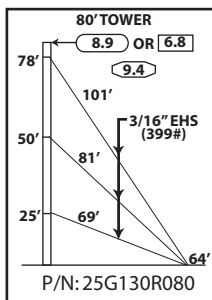

TOWER PARTS INCLUDED	25G	25AG2	BPC25G	GA25GD	FDNS	
					BASE	ANCHOR
	7	1	1	3	CB1G	AB2
GUYS & CONNECTIONS INCLUDED	3/16EHS	BG2142	5/16THH	1/2TBE&J	TBSAFETY	
	800'	18	18	9	3	
ANCHORS & GROUNDING INCLUDED	GAC3455TOP	AGK1GGX	BGK3GGX	CPC.5/.75	3/4x12PP	
	3	1	3	3	1	

80' ROHN 25G
All parts shown in table are included when ordering
Part No: 25G130R080



STANDARD DESIGN - 25G
130MPH REV. G, 110MPH REV. F

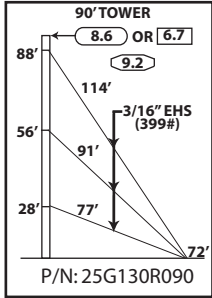

TOWER PARTS INCLUDED	25G	25AG2	BPC25G	GA25GD	FDNS	
					BASE	ANCHOR
	8	1	1	3	CB1G	AB2
GUYS & CONNECTIONS INCLUDED	3/16EHS	BG2142	5/16THH	1/2TBE&J	TBSAFETY	
	900'	18	18	9	3	
ANCHORS & GROUNDING INCLUDED	GAC3455TOP	AGK1GGX	BGK3GGX	CPC.5/.75	3/4x12PP	
	3	1	3	3	1	

90' ROHN 25G
All parts shown in table are included when ordering
Part No: 25G130R090

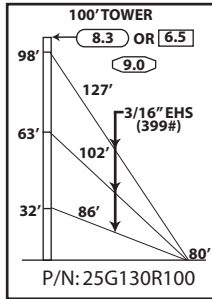

TOWER PARTS INCLUDED	25G	25AG2	BPC25G	GA25GD	FDNS	
					BASE	ANCHOR
	9	1	1	3	CB1G	AB2
GUYS & CONNECTIONS INCLUDED	3/16EHS	BG2142	5/16THH	1/2TBE&J	TBSAFETY	
	1000'	18	18	9	3	
ANCHORS & GROUNDING INCLUDED	GAC3455TOP	AGK1GGX	BGK3GGX	CPC.5/.75	3/4x12PP	
	3	1	3	3	1	

100' ROHN 25G
All parts shown in table are included when ordering
Part No: 25G130R100



PARTS & ACCESSORIES

<p>TOP SECTION 25AG COMES WITH TOP BUSHING INSTALLED, 1.31" I.D.</p>	<p>TOP SECTION 25AG1</p>	<p>TOP SECTION 25AG2</p>	<p>TOP SECTION 25AG3</p>
---	-------------------------------------	-------------------------------------	-------------------------------------

<p>TOP SECTION 25AG4 TOP PLATE HOLE PATTERN IS THE SAME AS BPL25G.</p>	<p>TOP SECTION 25AG5</p>	<p>BEARING PLATE BPL25G LONG LEGS PROVIDE EXTRA CLEARANCE FOR INSTALLATION OF EQUIPMENT. BOLTS TO TOP OF STANDARD SECTION. HOLE PATTERN FITS TB3 (2" O.D.) AND TB4 (3" O.D.) THRUST BEARINGS.</p>	<p>TOP PLATE APL25G FOR MOUNTING BEACON OR LIGHTNING ROD.</p>
---	-------------------------------------	--	--

	<p>TOP MOUNT 25TDMKD - NO MAST 25TDM2S3KD - 2 3/8" O.D. MAST 25TDM2S53KD - 2 7/8" O.D. MAST 25TDM3S3KD - 3 1/2" O.D. MAST 25TDM3S53KD - 4" O.D. MAST MOUNTING TUBE PROVIDED IS 7' LONG.</p>	<p>BEARING/ACCESSORY SHELF BAS25G HOLE PATTERN FITS TB3 (2" O.D.) AND TB4 (3" O.D.) THRUST BEARINGS ON TOP PLATE. ACCESSORY SHELF DRILLED FOR MOUNTING MANY POPULAR ROTORS.</p>	<p>LIGHTNING ROD LRCL 5' COPPER CLAD, MOUNTS TO APL25G.</p>
--	--	--	--



PARTS & ACCESSORIES

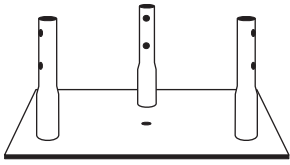

CONCRETE BASE PLATE FOR GUYED & BRACKETED TOWERS BPC25G* FOR USE WITH 3/4X12PP PIER PIN EMBEDDED IN CONCRETE. CONCRETE BASE PLATE IS TO BE USED FOR BRACKETED AND GUYED APPLICATIONS ONLY.



PIER PIN 3/4X12PP FOR USE WITH BPC25G EMBEDDED IN CONCRETE. PIER PIN MUST BE ORDERED SEPARATELY, UNLESS BEING PURCHASED AS PART OF A COMPLETE TOWER KIT.

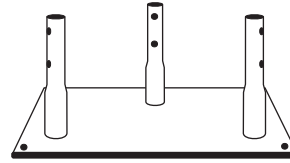

CONCRETE BASE PLATE FOR SELF-SUPPORTING TOWERS 25GSSB FOR USE WITH 5/8" x 12" (P/N: 260145G) BASE BOLTS (ORDERED SEPARATELY) IN SELF-SUPPORTING 25G TOWER APPLICATIONS.

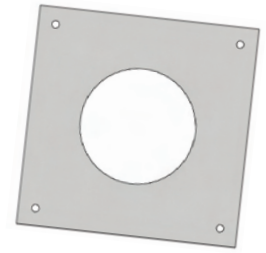

BASE BOLT & TEMPLATE KH8175A FOR USE WITH 25GSSB IN SELF-SUPPORTING 25G TOWER APPLICATIONS. KIT INCLUDES (1) TEMPLATE & (4) BASE BOLTS.

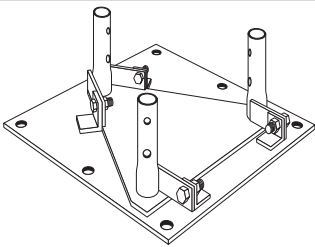

HINGED BASE PLATE BPH25G* FOR USE WITH 1/2X12BB BASE BOLTS (ORDERED SEPARATELY). HINGED TO ALLOW TOWER TO BE ROTATED UP FROM BASE DURING INSTALLATION. HINGED BASE PLATE IS TO BE USED FOR BRACKETED AND GUYED APPLICATIONS ONLY.

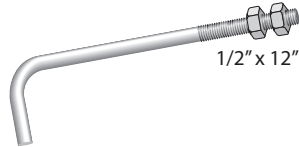

BASE BOLTS 1/2X12BB FOR USE WITH BPH 25G (6) REQUIRED, ORDERED SEPARATELY.

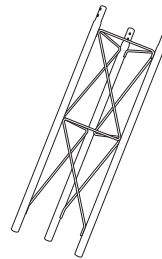

3 1/4" SHORT BASE SB25G 5' SHORT BASE SB25G5

FOR EMBEDMENT IN CONCRETE.

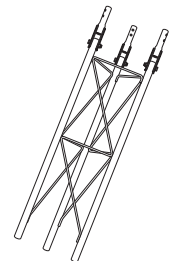

3 1/4" HINGED SHORT BASE SBH25G* FOR EMBEDMENT IN CONCRETE.



TAPERED BASE 25TG* CAN BE USED WITH A4197L BASE INSULATOR OR WITH 3/4x12PP, ORDERED SEPARATELY.

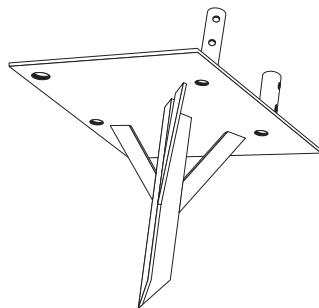

SINGLE DRIVE-IN BASE SDB25G* TO BE DRIVEN DIRECTLY INTO GROUND.

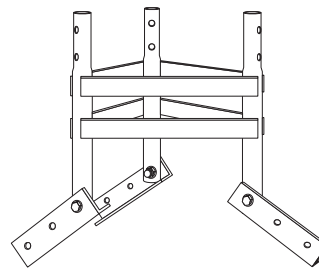

PEAK ROOF MOUNT PR25G* ADJUSTABLE HINGED FEET CONFORM TO NEARLY ANY ROOF PITCH. BOLTS TO ROOF SURFACE.

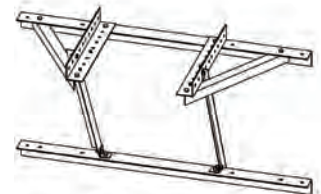
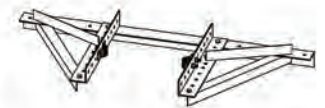

WALL MOUNT 25GWM INCLUDES BASE PLATE TO MOUNT 25G SECTION.

* TOWERS MOUNTED ON THESE BASES MUST BE BRACKETED OR GUYED AT ALL TIMES. TEMPORARY STEEL GUYING MAY ALSO BE NECESSARY DURING INSTALLATION AND DISMANTLING.



PARTS & ACCESSORIES

FLAT ROOF MOUNT
FR25G*
BOLTS DIRECTLY TO FLAT ROOF SURFACE.

SIDE ARM MOUNT
UHF25G
FOR UHF & FM ANTENNAS.
7/8" - 1 1/8" O.D. Mounting Pipe

FACE MOUNT
DM25G2 - 2 3/8" O.D. 5' LONG

DBS ANTENNA MOUNT
KY2068A16 - 1.66" O.D.
KY2068A15 - 1.50" O.D.
KY2068A2 - 2.38" O.D.
MOUNTING TUBE PROVIDED IS 3' LONG.

SIDE ARM BRACKET
SA253UA
MOUNTING TUBE PROVIDED IS 3' LONG,
2 - 1/4" O.D.
Adjustable
2.5' - 3.0'

ADJUSTABLE HOUSE BRACKET
HB25AG 0 - 15"
HB25BG 0 - 24"
HB25CG 0 - 36"

HEAVY DUTY UNIVERSAL HOUSE BRACKET
HBUTVRO
ADJUSTABLE TO POSITION TOWER
18" - 36" FROM WALL.

UNIVERSAL EAVE BRACKET
EB2525G
HINGED CONNECTION ALLOWS TOWER
LEG CLAMPS TO REMAIN PERPENDICULAR
TO GROUND WHILE BOLT DOWN
SUPPORTS ROTATE TO LAY FLAT ALONG
PITCHED ROOF OR EAVE.

TORQUE ARM STABILIZER ASSEMBLY
TA25
ANTI-TWIST DEVICE LOCATED IN THE
AREA OF ANTENNAS. PROVIDES SIX-WAY
GUYING. BOLTS TO TOWER AT ANY
SECTION JOINT. ATTACHED WITH
JOINT BOLTS. MUST BE INSTALLED AS
SECTIONS ARE JOINED TOGETHER.

TORQUE BAR
TB25D
OPTIONAL, FOR USE WITH GA25GD.
REQUIRES (1) 3/8" SHACKLE
FOR EACH BAR.

GUY BRACKET
GA25GD
MOUNTS TO TOWER AT ANY
HORIZONTAL BRACE.

ACCESSORY SHELF
AS25G
FOR MOUNTING MANY POPULAR
ROTORS. FIELD DRILLING MAY BE
NECESSARY FOR SOME ROTORS.

* TOWERS MOUNTED ON THESE BASES MUST BE BRACKETED OR GUYED AT ALL TIMES. TEMPORARY STEEL GUYING MAY ALSO BE NECESSARY DURING INSTALLATION AND DISMANTLING.



PARTS & ACCESSORIES

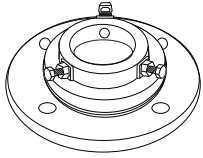

THRUST BEARING

TB3 - SUPPORTS UP TO 2" O.D. MAST.
TB4 - SUPPORTS UP TO 3" O.D. MAST.
MOUNTS TO BAS25G, BPL25G AND 25AG4.

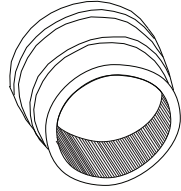

TOWER BUSHING

TB50 - 1-1/4" I.D. X 2" O.D.
TB75 - 1-1/2" I.D. X 2" O.D.
FOR USE ON 25AG TOP SECTION

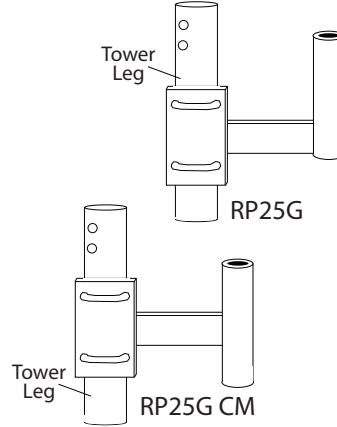

ROTOR POST

1.25" O.D.
1.08" I.D.

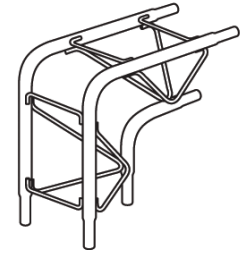

90° JOINTS

2590MM - BOTH ENDS SWAGED
JOINTS ARE NOT DRILLED WHERE THEY SLIP FIT TO 25G SECTIONS. CAN BE FIELD DRILLED OR CUSTOM CONNECTED TO MEET PARTICULAR NEEDS.

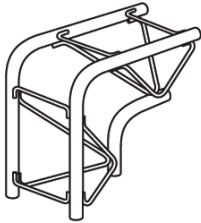

90° JOINTS

2590FF - BOTH ENDS OPEN
JOINTS ARE NOT DRILLED WHERE THEY SLIP FIT TO 25G SECTIONS. CAN BE FIELD DRILLED OR CUSTOM CONNECTED TO MEET PARTICULAR NEEDS.

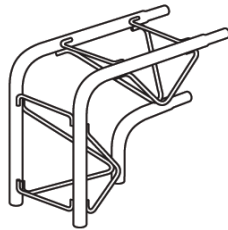

90° JOINTS

2590FM - ONE END SWAGED, ONE OPEN
JOINTS ARE NOT DRILLED WHERE THEY SLIP FIT TO 25G SECTIONS. CAN BE FIELD DRILLED OR CUSTOM CONNECTED TO MEET PARTICULAR NEEDS.



ANTI-CLIMB PANELS
25ACL3

THREE ANTI-CLIMB PANELS BOLT TO STANDARD TOWER SECTION.

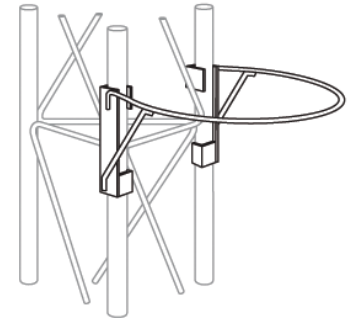

SAFETY RING
SR245

SNAPS INTO PLACE AT ANY LEVEL. NO BOLTS REQUIRED.

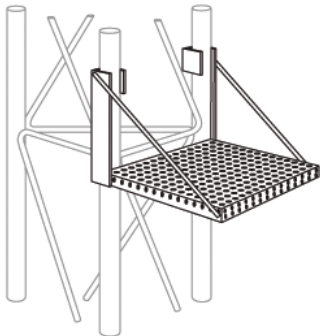

WORK PLATFORM
WP25G

SNAPS INTO PLACE AT ANY LEVEL. NO BOLTS REQUIRED.



ERECTION FIXTURE

EF2545 - 2 1/2" SHEAVE WITH 3/8" I.D. GROOVE.

NOTE: ERECTION FIXTURES ARE FOR LIFTING ONE 10' SECTION AT A TIME AND ARE NOT INTENDED FOR THE LIFTING OF PERSONNEL.



CLIMBING HARNESS

TTFBH-4D
JOURNEYMAN HARNESS
TTFBH-C/P
PROFESSIONAL HARNESS



SAFETY CABLE SLIDER WITH CARABINEER
TT-WG-500-W/SMC

SAFETY CABLE SYSTEM ORDERING INFORMATION

Table with 2 columns: TOWER HEIGHT and PART NUMBER. Rows include 50', 100', 150', and 200' tower heights.

SAFETY CABLE SLIDER AND CLIMBING HARNESS MUST BE ORDERED SEPARATELY.

ANCHOR INFORMATION

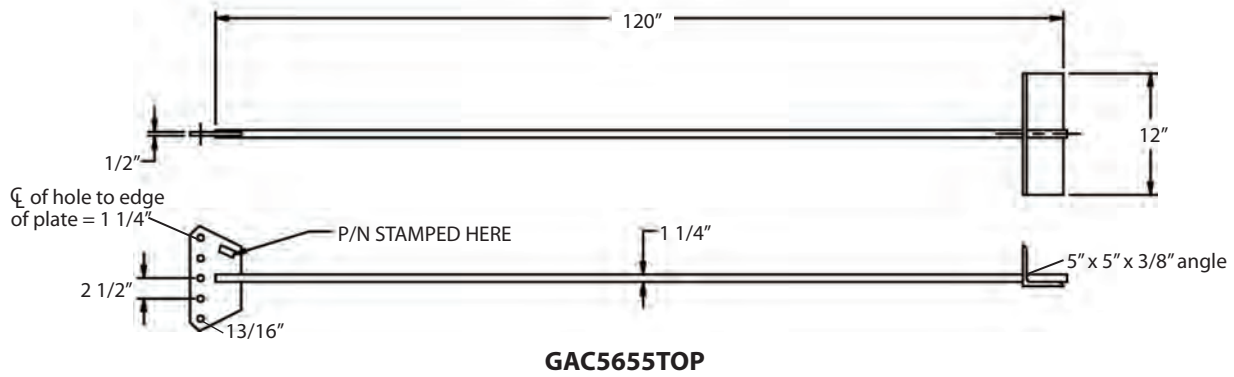
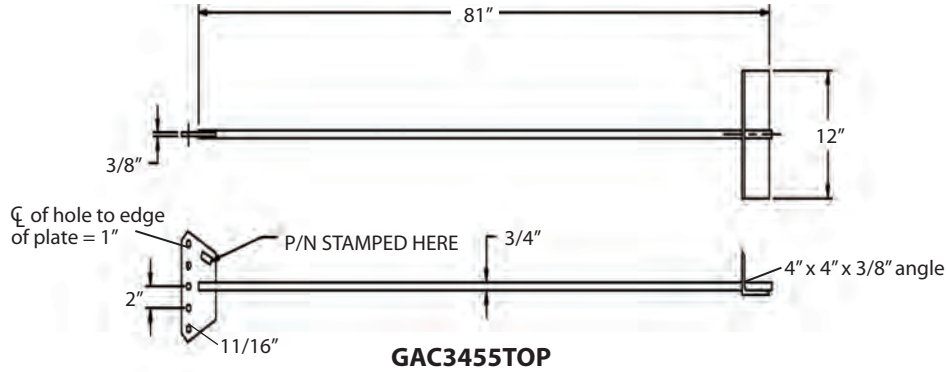

REV G
ANCHOR GROUNDING
AGK1GGX

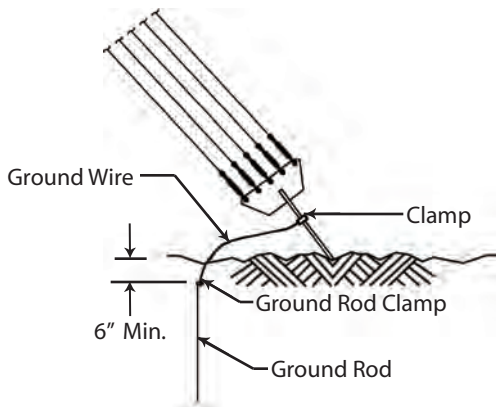

REV G
BASE GROUNDING
BGK3GGX

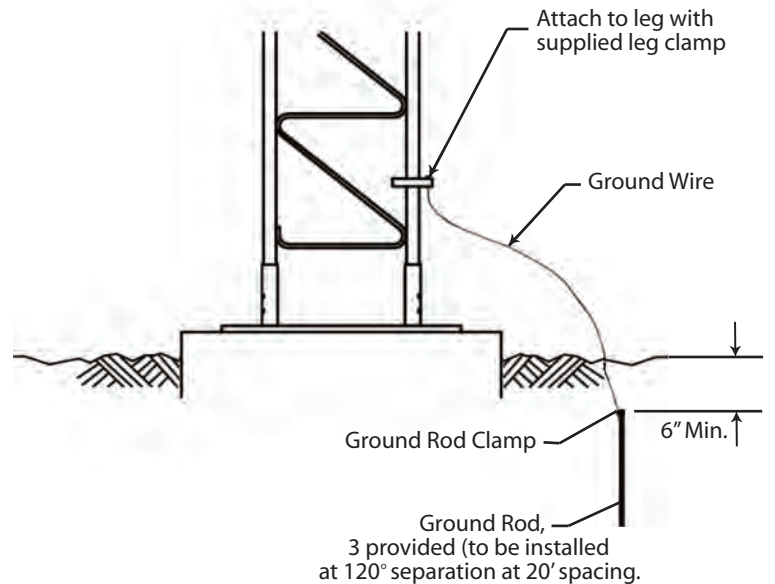



STANDARD ANCHOR BLOCKS

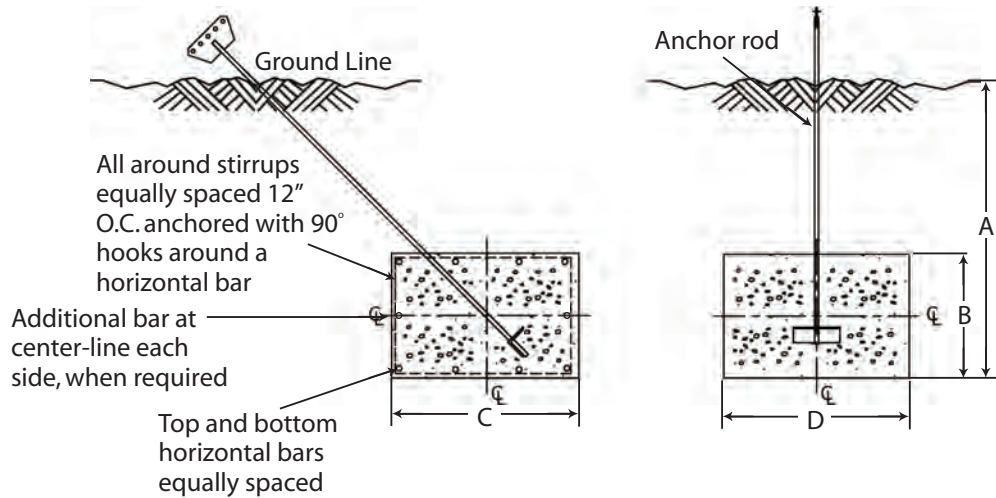

Refer to page 43 for anchor rod installation angles.

Block	Anchor Dimensions (in.)				Horizontal Bars (Qty. & Size)	Stirrup Size & Spacing	Concrete Vol. (Cu. Yds.)
	A	B	C	D			
AB2	4' - 0"	1' - 6"	4' - 0"	6' - 0"	(5) #6 Bars, Top Layer (5) #6 Bars, Bottom Layer (0) Additional Bar, Each Side	#3 @ 12" O.C.	1.33 Per Block 4.0 Total for 3
AB3	6' - 0"	1' - 6"	3' - 0"	6' - 0"	(4) #6 Bars, Top Layer (4) #6 Bars, Bottom Layer (0) Additional Bar, Each Side	#3 @ 12" O.C.	1.0 Per Block 3.0 Total for 3
AB4	6' - 0"	1' - 6"	4' - 0"	9' - 0"	(5) #6 Bars, Top Layer (5) #6 Bars, Bottom Layer (0) Additional Bar, Each Side	#4 @ 12" O.C.	2.0 Per Block 6.0 Total for 3
AB5	8' - 0"	2' - 0"	3' - 0"	10' - 0"	(4) #7 Bars, Top Layer (4) #7 Bars, Bottom Layer (1) Additional Bar, Each Side	#4 @ 12" O.C.	2.22 Per Block 6.7 Total for 3
AB6	8' - 0"	2' - 0"	4' - 0"	10' - 0"	(5) #7 Bars, Top Layer (5) #7 Bars, Bottom Layer (1) Additional Bar, Each Side	#4 @ 12" O.C.	2.96 Per Block 8.9 Total for 3



ANCHOR ROD INSTALLATION ANGLES

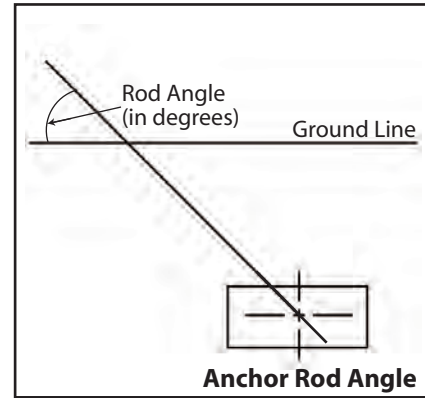
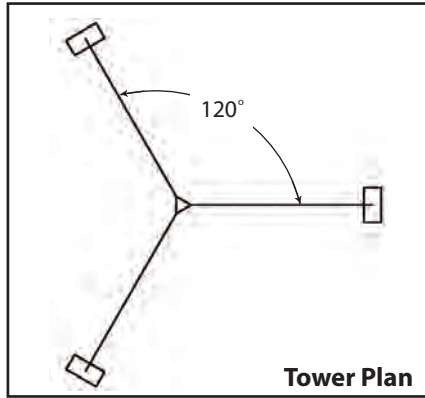

25G 90MPH		
Tower Height	Rod Number	Rod Angle
40'	GAC3455TOP	48
50'	GAC3455TOP	42
60'	GAC3455TOP	42
70'	GAC3455TOP	42
80'	GAC3455TOP	39
90'	GAC3455TOP	39
100'	GAC3455TOP	39
110'	GAC3455TOP	39
120'	GAC3455TOP	38
130'	GAC3455TOP	38
140'	GAC3455TOP	38
150'	GAC3455TOP	37
160'	GAC3455TOP	37
170'	GAC3455TOP	37
180'	GAC3455TOP	37
190'	GAC3455TOP	37

25G 110MPH				
Tower Height	Inner Rod Number	Inner Rod Angle	Outer Rod Number	Outer Rod Angle
40'	GAC3455TOP	48	-	-
50'	GAC3455TOP	41	-	-
60'	GAC3455TOP	41	-	-
70'	GAC3455TOP	41	-	-
80'	GAC3455TOP	38	-	-
90'	GAC3455TOP	38	-	-
100'	GAC3455TOP	39	-	-
110'	GAC3455TOP	38	-	-
120'	GAC3455TOP	37	-	-
130'	GAC3455TOP	37	-	-
140'	GAC3455TOP	37	-	-
150'	GAC3455TOP	36	-	-
160'	GAC3455TOP	36	-	-
170'	GAC3455TOP	40	GAC3455TOP	42
180'	GAC3455TOP	41	GAC3455TOP	42
190'	GAC3455TOP	43	GAC3455TOP	42

25G 130MPH		
Tower Height	Rod Number	Rod Angle
40'	GAC3455TOP	50
50'	GAC3455TOP	41
60'	GAC3455TOP	41
70'	GAC3455TOP	40
80'	GAC3455TOP	38
90'	GAC3455TOP	38
100'	GAC3455TOP	38



STANDARD BASE PIERS

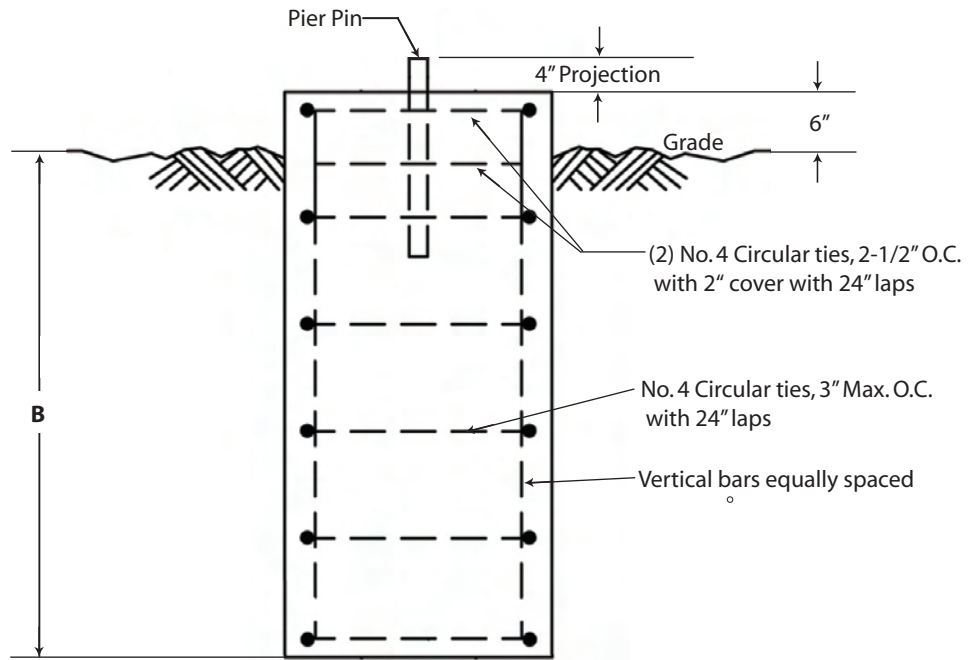

ELEVATION VIEW

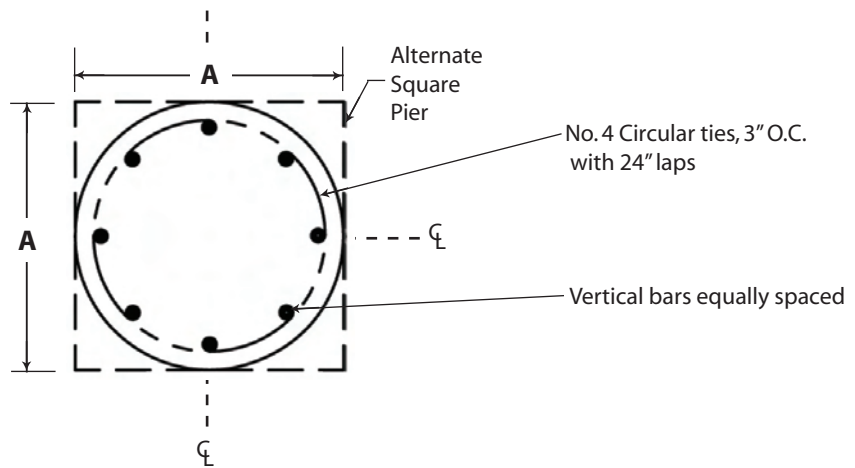

PLAN VIEW

Base	A	B	Concrete Vol. (Cu. Yds.) Round Pier	Vertical Bars (No. & Size)
CB1G*	2' - 6"	4' - 0"	1.0	(8) #7
CB2G	3' - 0"	4' - 0"	1.2	(10) #7

* Square pier option must be used for CB1G.