

Figure 1

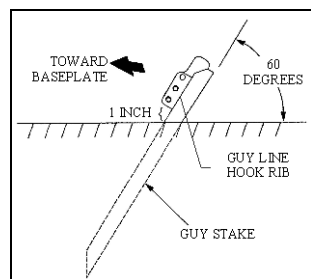

Figure 2

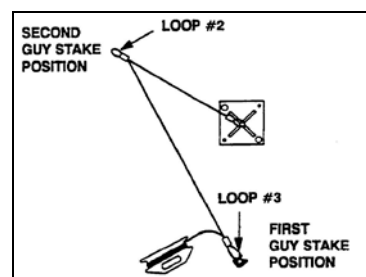

Figure 3

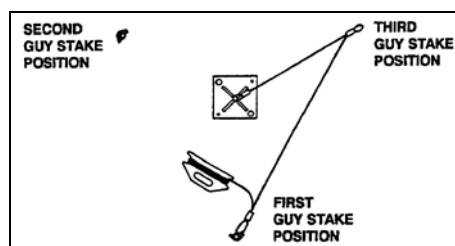

Figure 4

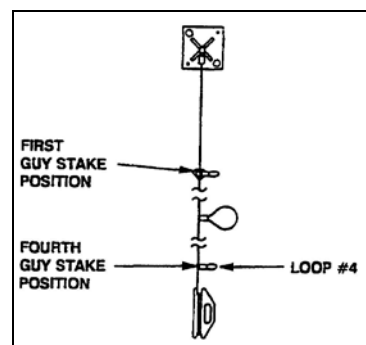

Figure 5

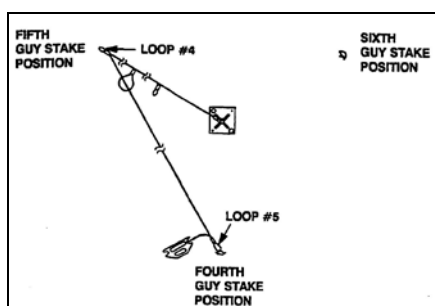

Figure 6

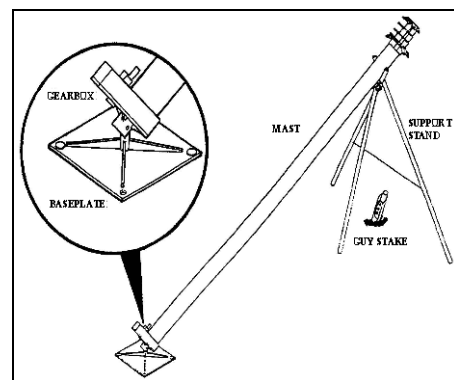

Figure 7

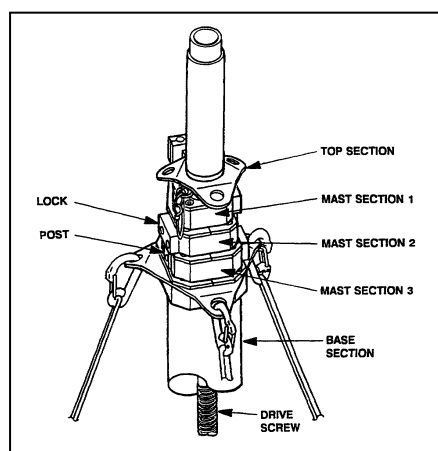

Figure 8

MAST DEPLOYMENT (3 Man Operation)

1. Select a site that has no more than a 15 degree (26.8%) slope, is suitable for deployment of guy stakes and guy lines and is at least 80 ft. (24.4 m) from overhead power lines.
2. Remove the accessories from the accessory bag. Refer to the accessory sheet for part identification and quantity.
3. Place the base plate at the center of the site and anchor with four base plate spikes.
4. Hook loop #1 of the radius rope over the center post of the base plate and unwind it to loop #2. See Fig. 1.
5. Hammer one guy stake at a 60 degree angle at the loop #2 position. See Fig. 1 & Fig. 2.
6. Unwind the radius rope to loop #3 and hook loop #3 over the guy stake that was just placed. See Fig. 3.
7. Hammer one guy stake at a 60 degree angle at the loop #2 position. See Fig. 2 and Fig. 3.
8. Without moving loops #1 and #3, walk loop #2 to the opposite side of the base plate and hammer one guy stake at a 60 degree angle at the loop #2 position. See Fig. 4.
9. Repeat steps 4 through 8 except using loops #4 and #5. See Fig. 5 and Fig. 6.
10. Place the support stand over one of the inner guy stakes. See Fig. 7.
11. Place the mast gearbox on the base plate and lay the top end of the mast on the support stand. See Fig. 7.
12. Install the payload and secure it.
13. Place the cable(s) through the cable guides and attach to the payload as required. See Fig. 8.
14. Unwrap the three inner guy tensioners and attach the black snap hooks to the lower (6") guy plate (black) and the green snap hooks to the lowest hole on the inner guy stakes. Note that the snap hooks should be fastened from underneath the guy plate. See Fig. 8 and Fig. 10.
15. Unwrap the three outer guy tensioners and attach the green snap hooks on the single line side to the upper (2.0") guy plate (green) and the green snap hooks on the double line side to the lowest hole on the outer guy stakes. Note that the snap hooks should be fastened from underneath the guy plate. See Fig. 8 and Fig. 12.
16. Raise the mast to a vertical position and verify that the gearbox is securely seated on the base plate. See Fig. 9.

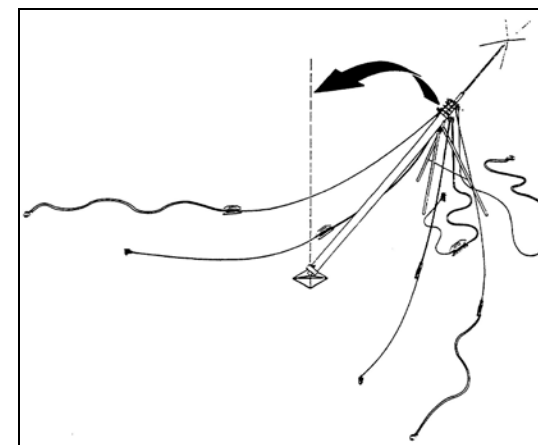

Figure 9

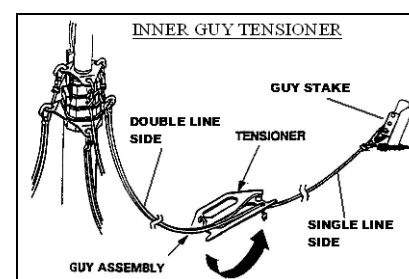

Figure 10

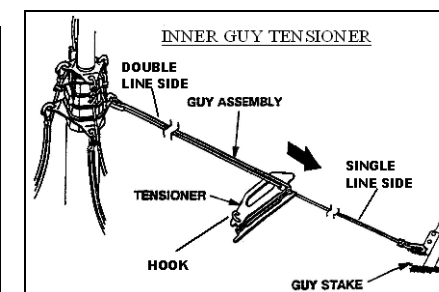

Figure 11

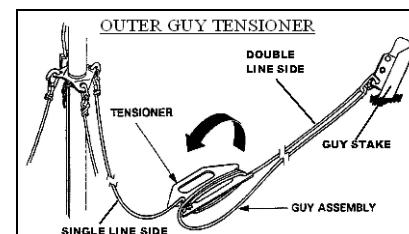

Figure 12

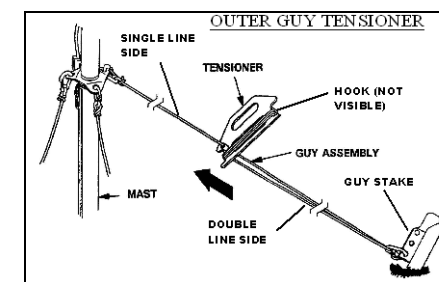

Figure 13

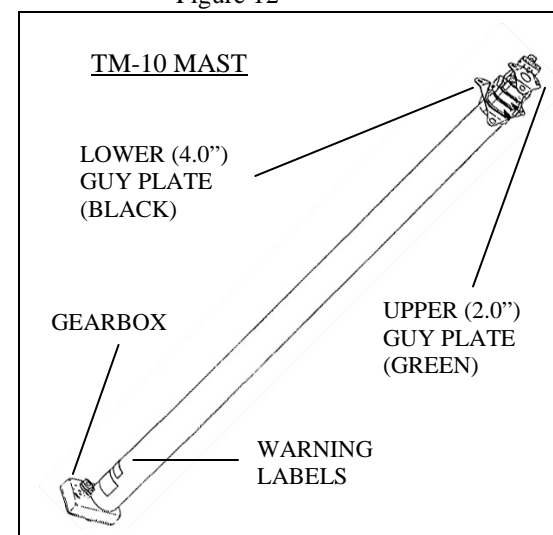

Figure 14

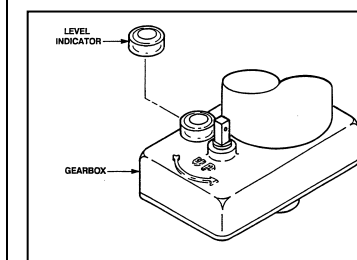

Figure 15

17. Remove the slack in one of the inner guy tensioners by winding the trailing end of the guy line around the tensioner. See Fig. 10.
18. Tension the line by sliding the tensioner toward the guy stake and lock it by placing the guy tensioner hook over the double guy lines. See Fig. 11.
19. Repeat for the other inner guy tensioners.
20. Using the bubble level, make final adjustments to the guy lines to set the mast vertical. The bubble must be completely inside the inner circle on the indicator before the mast is extended. See Figs. 14 and. 15.
21. Place the hand crank onto the gearbox and crank counterclockwise to extend the mast. Maintain a steady, even cranking speed. In the event of a jam, stop and crank in the reverse direction approximately five turns, then retry. Cranking more slowly will help to clear a jam. See Fig 14 and Fig. 15.
22. Under windy conditions, more torque will be required to extend the mast, especially when a section is nearing full extension. If available, deploy two men to the appropriate upper guy lines to pull the mast into the wind and straighten it. This will reduce the torque required for deployment. Do not attempt to deploy the mast if winds exceed 25 mph (40 kph).
23. The mast has built-in stops at approximately 32 ft., 10 in. (10 m), but it can be extended to any intermediate height.
24. Once the mast has reached the desired height, remove the crank.
25. Remove the slack in one of the outer guy tensioners by winding the trailing end of the guy line around the tensioner. See Fig. 12.
26. Tension the line by sliding the tensioner toward the mast and lock it by placing the guy tensioner hook over the double guy lines. See Fig. 13.
27. Repeat for the other outer guy tensioners.
28. Visually check that the mast is straight in all directions. Adjust the outer guy tensioners as required to straighten the mast.

MAST RETRIEVAL (3 Man Operation)

1. Verify that winds do not exceed 25 mph (40 kph). Do not attempt to retrieve the mast in winds exceeding 25 mph (40 kph)
2. Release the three outer guy tensioners to slacken the upper guy lines. (Ref. Fig. 12 and Fig. 13)
3. Place the hand crank onto the gearbox and crank clockwise to retract the mast. Maintain a steady, even cranking speed. In the event of a jam, stop and crank in the reverse direction approximately five turns, then retry. Cranking more slowly will help to clear a jam. (Ref. Fig. 15)
4. Under windy conditions, more torque will be required to retract the mast, especially when a section is still fully extended. If available, deploy two men to the appropriate upper guy lines to pull the mast into the wind and straighten it. This will reduce the torque required for retraction.
5. After the mast is fully nested, hold the mast vertical and release the three inner guy tensioners to slacken the lower guy lines. (Ref. Fig. 10 and Fig. 11)
6. Unhook all of the guy tensioners from the guy stakes.
7. Set up the support stand over one of the inner guy stakes. (Ref. Fig. 7)
8. Lower the mast until it rests securely on the support stand. Note that the mast will only tilt in the direction away from the gearbox crank input, rotate the mast if necessary to lower it into the support stand. (Ref. Fig. 7)
9. Remove the payload and stow it.
10. Unhook the guy lines from the mast guy plates and wind the guy lines around the guy tensioners for storage.
11. Place the "mast head end" of the mast transport bag (as labeled) over the top of the mast.
12. Remove the mast from the support stand and place it into the transport bag.
13. Hit each guy stake once on each edge (not on the inside or outside curved surfaces) then use the hammer to pry under the guy line hook rib and remove the guy stake. (Ref. Fig. 2)
14. Remove the base plate and base plate spikes.
15. Stow all the accessories in the accessory bag. Refer to the accessory sheet for part identification and quantity verification. Close the accessory bag.
16. Place this sheet in the pocket of the mast transport bag and close the bag.

PREVENTATIVE MAINTENANCE CHECKS AND SERVICES

1. Keep the mast clean. The sections can be wiped down during deployment or retrieval as required. Use care to avoid pinch points around the collars.
2. If the locks become hard to operate or require cleaning, the lock housings and posts can be removed while the mast is fully nested using the balldrivers in the accessory kit. Use care not to lose any of the small parts contained in the lock. Never remove a lock while the mast is deployed. (Ref. Fig. 8)
3. The bottom of the gearbox must be kept clean to ensure that it seats properly on the base plate.
4. Perform the following checks before and after each deployment. Do not attempt to deploy the mast if it does not pass all of the following checks.
 - (a) Visually inspect the guy tensioners for frayed or broken rope, cracks or other damage.
 - (b) Visually inspect the crank handle for damage.
 - (c) Visually inspect the guy plates for cracks or elongated holes. (Ref. Fig. 8)
 - (d) Visually inspect the guy stakes for cracks or severe damage.
 - (e) Visually inspect the exterior of the mast for dents or other damage.
 - (f) Visually inspect the mast for loose, broken, or missing hardware.
 - (g) Visually inspect the gearbox for damage.
 - (h) Verify that the bubble level is attached to the gearbox and is operational. (Ref. Fig. 15)



THE WILL-BURT CO.
ORRVILLE, OH 44667

TP-4659301-00

QEAM™ TM-10 Mechanical Mast Operating Instructions

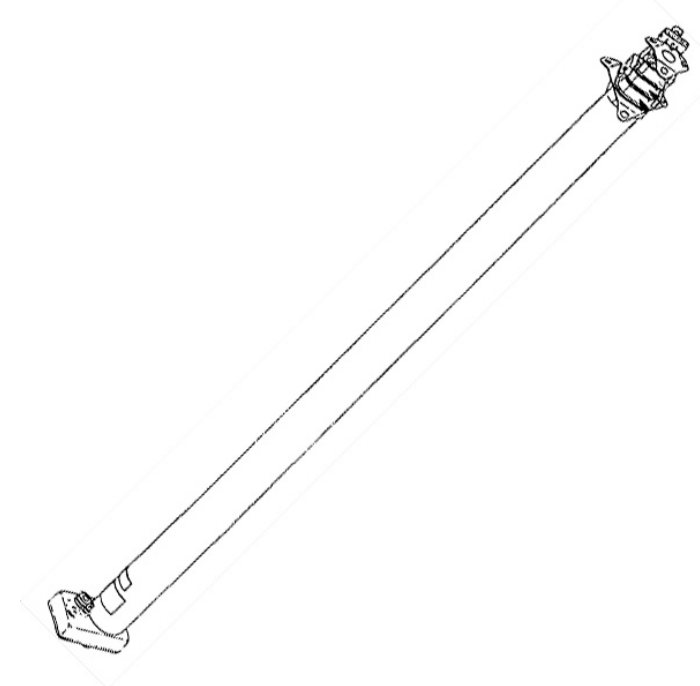

WARNING

Do not deploy the mast if power lines are less than 80 ft. (24.4 m) from the center of the deployment site.

WARNING

Do not attempt to deploy the mast on soft or loose soil. The base plate and guy stakes could become unstable under wind loading and cause the mast to fall.

WARNING

Do not attempt to deploy or retrieve this mast during electrical storms or when winds exceed 25 mph (40 kph)

Helmets or hard hats, eye protection, gloves, and safety shoes or combat boots must be worn while working in the mast deployment area.

WARNING

Do not attempt to deploy the mast on ground that slopes more than 15 degrees (26.8%).

The mast must be vertical before deployment. Adjust guy lines as required until the bubble level indicates the mast is vertical.

WARNING

The mast weighs approximately 42 lbs. (19 kg). Always observe weight lift limits.

TP-4659301-00