

HEATHKIT[®] MANUAL

for the

VLF CONVERTER

Model HD-1420

595-3468-0

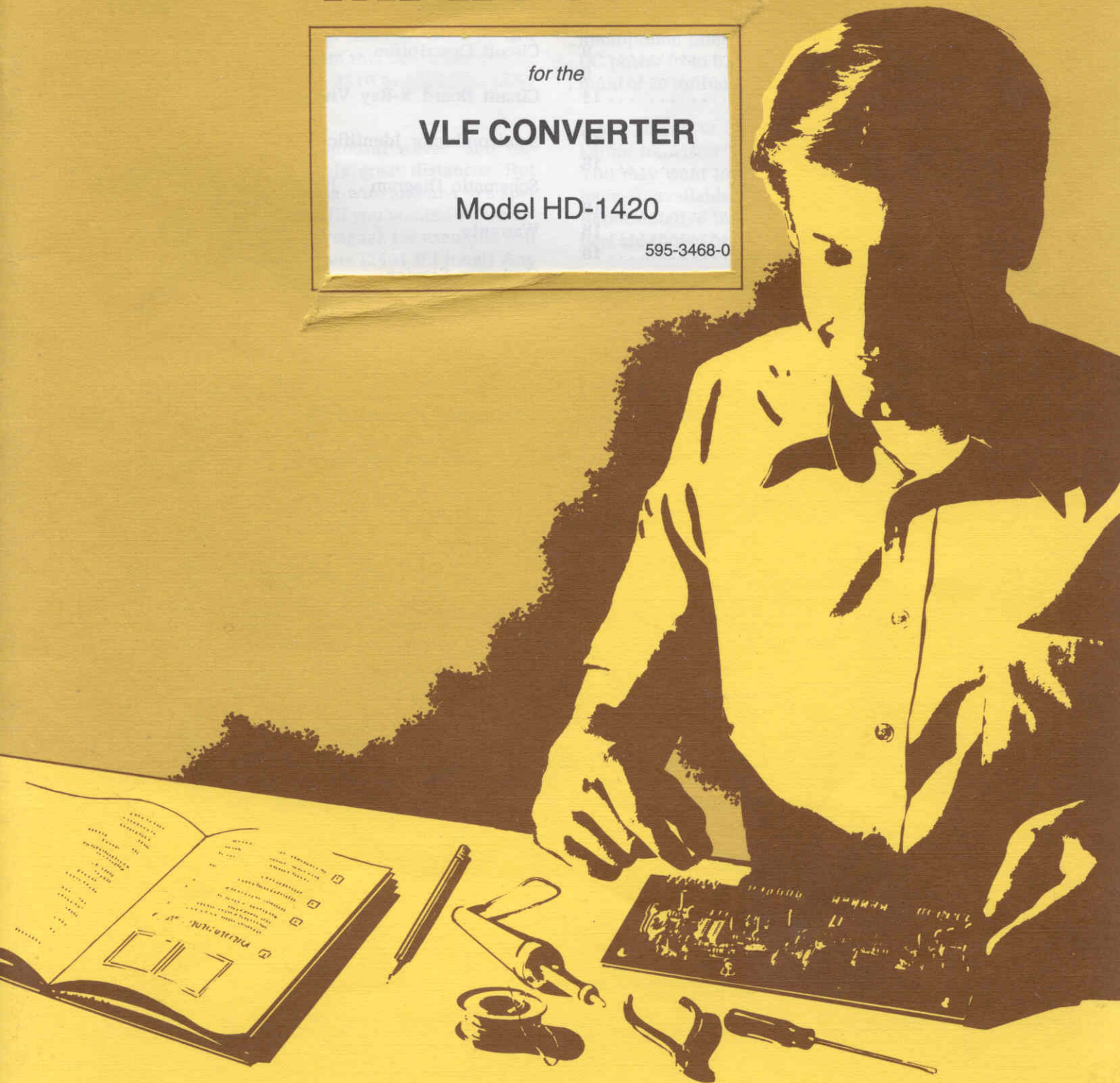

HEATH COMPANY • BENTON HARBOR, MICHIGAN

HEATH COMPANY PHONE DIRECTORY

The following telephone numbers are direct lines to the departments listed:

Kit orders and delivery information (616) 982-3411
Credit (616) 982-3561
Replacement Parts (616) 982-3571

Technical Assistance Phone Numbers

8:00 A.M. to 12 P.M. and 1:00 P.M. to 4:30 P.M., EST, Weekdays Only
R/C, Audio, and Electronic Organs (616) 982-3310
Amateur Radio (616) 982-3296
Test Equipment, Weather Instruments and
Home Clocks (616) 982-3315
Television (616) 982-3307
Aircraft, Marine, Security, Scanners, Automotive,
Appliances and General Products (616) 982-3496
Computers — Hardware (616) 982-3309
Computers — Software:
Operating Systems, Languages, Utilities (616) 982-3860
Application Programs (616) 982-3884
Heath Craft Wood Works (616) 982-3423



YOUR HEATHKIT 90-DAY LIMITED WARRANTY

Consumer Protection Plan for Heathkit Consumer Products

Welcome to the Heath family. We believe you will enjoy assembling your kit and will be pleased with its performance. Please read this Consumer Protection Plan carefully. It is a "LIMITED WARRANTY" as defined in the U.S. Consumer Product Warranty and Federal Trade Commission Improvement Act. This warranty gives you specific legal rights, and you may also have other rights which vary from state to state.

Heath's Responsibility

PARTS — Replacements for factory defective parts will be supplied free for 90 days from date of purchase. Replacement parts are warranted for the remaining portion of the original warranty period. You can obtain warranty parts direct from Heath Company by writing or telephoning us at (616) 982-3571. And we will pay shipping charges to get those parts to you . . . anywhere in the world.

SERVICE LABOR — For a period of 90 days from the date of purchase, any malfunction caused by defective parts or error in design will be corrected at no charge to you. You must deliver the unit at your expense to the Heath factory, any Heathkit Electronic Center (units of Veritechnology Electronics Corporation), or any of our authorized overseas distributors.

TECHNICAL CONSULTATION — You will receive free consultation on any problem you might encounter in the assembly or use of your Heathkit product. Just drop us a line or give us a call. Sorry, we cannot accept collect calls.

NOT COVERED — The correction of assembly errors, adjustments, calibration, and damage due to misuse, abuse, or negligence are not covered by the warranty. Use of corrosive solder and/or the unauthorized modification of the product or of any furnished component will void this warranty in its entirety. This warranty does not include reimbursement for inconvenience, loss of use, customer assembly, set-up time, or unauthorized service.

This warranty covers only Heath products and is not extended to other equipment or components that a customer uses in conjunction with our products.

SUCH REPAIR AND REPLACEMENT SHALL BE THE SOLE REMEDY OF THE CUSTOMER AND THERE SHALL BE NO LIABILITY ON THE PART OF HEATH FOR ANY SPECIAL, INDIRECT, INCIDENTAL OR CONSEQUENTIAL DAMAGES, INCLUDING BUT NOT LIMITED TO ANY LOSS OF BUSINESS OR PROFITS, WHETHER OR NOT FORSEEABLE.

Some states do not allow the exclusion or limitation of incidental or consequential damages, so the above limitation or exclusion may not apply to you.

Owner's Responsibility

EFFECTIVE WARRANTY DATE — Warranty begins on the date of first consumer purchase. You must supply a copy of your proof of purchase when you request warranty service or parts.

ASSEMBLY — Before seeking warranty service, you should complete the assembly by carefully following the manual instructions. Heathkit service agencies cannot complete assembly and adjustments that are customer's responsibility.

ACCESSORY EQUIPMENT — Performance malfunctions involving other non-Heath accessory equipment, (antennas, audio components, computer peripherals and software, etc.) are not covered by this warranty and are the owner's responsibility.

SHIPPING UNITS — Follow the packing instructions published in the assembly manuals. Damage due to inadequate packing cannot be repaired under warranty.

If you are not satisfied with our service (warranty or otherwise) or our products, write directly to our Director of Customer Service, Heath Company, Benton Harbor MI 49022. He will make certain your problems receive immediate, personal attention.

Heathkit® Manual

for the

VLF CONVERTER

Model HD-1420

595-3468-01

HEATH COMPANY
BENTON HARBOR, MICHIGAN 49022

Copyright © 1985
Heath Company
All Rights Reserved
Printed in the United States of America

TABLE OF CONTENTS

Introduction	3	In Case of Difficulty	19
Assembly Notes	4	Visual Checks	19
Parts List	7	Troubleshooting Chart	20
Step-by-Step Assembly	9	Specifications	21
Circuit Board	9	Circuit Description	22
Chassis	14	Circuit Board X-Ray View	23
Initial Tests	17	Semiconductor Identification	24
Final Assembly	18	Schematic Diagram .. Illustration Booklet, Page 8	
Installation and Operation	18	Warranty	Inside front cover.
Installation	18	Customer Service	Inside rear cover.
Operation	18		

INTRODUCTION

The Heathkit Model HD-1420 VLF Converter lets you listen to the frequencies below the standard AM broadcast band between 10 and 500 kHz. Among the many interesting signals in this VLF range are long range navigation signals, radioteletype, European high-power broadcasts, radio beacons, etc. You can tune in the output signal from this Converter on any receiver that will tune from 3510 to 4000 kHz (3.51 to 4.0 MHz).

Most of these signals are ground waves, and frequently travel over relatively great distances. But you do not have to cut a long-wire antenna to a specific length to receive them. (If you wanted a quarter-wave antenna for a 100 kHz signal, for example, you would need a wire 750 meters [2461 ft.] long!) Any wire length, horizontal or vertical, will usually provide you with reasonably good reception; but you should make it as long as you can.

Your VLF Converter is small enough that you can easily place it in almost any small corner near your receiver. When it is not in use, the Converter directly bypasses all the incoming signals to the receiver.

POWER SOURCE

You will need to obtain a suitable source of power for your Converter. You may use a 9-volt battery; a Heathkit Power Supply cube with a miniature microphone plug, Model PS-2350; or any source of DC power from 6.0 to 14 volts that is rated at a minimum of 20 milliamperes.

If you intend to use a battery, purchase a 9-volt alkaline transistor battery, NEDA #1604 (or 1604A). You may want to buy this battery now so you will have it available when you finish the assembly. Representative manufacturers and their type numbers are shown below.

WARNING: If you use this VLF Converter with a transceiver of any kind, be sure to disconnect the Converter before you apply transmitting power to your transceiver output. You will damage the Converter if you do not.

Eveready #216, PP3
Burgess #2U6
Mallory #TR-146X (long life)
RCA #VS323

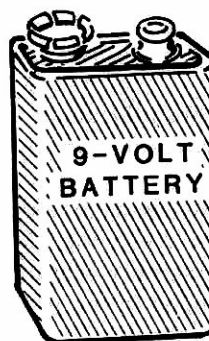

ASSEMBLY NOTES

TOOLS

You will need these tools to assemble your kit.



LONG-NOSE
PLIERS



DIAGONAL
CUTTERS

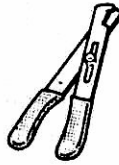

WIRE
STRIPPERS

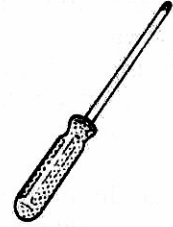

PHILLIPS
SCREWDRIVER

OTHER HELPFUL TOOLS



NUT STARTER
(May Be Supplied
With Kit)



DESOLDERING
BULB*



DESOLDERING
BRAID*

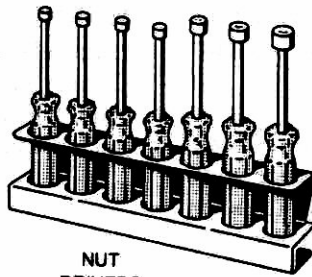

NUT
DRIVERS

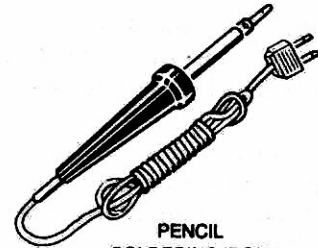

PENCIL
SOLDERING IRON
(22 to 25 WATTS)

*To Remove Solder From Circuit Connections.

ASSEMBLY

1. Follow the instructions carefully. Read the entire step before you perform each operation.
2. Refer to the separate "Illustration Booklet" for the Pictorials and Details. Keep the "Illustration Booklet" with the Assembly Manual. The illustrations in it are arranged in the proper sequence, as called for in the steps.
3. Pictorials show the overall operation for a group of assembly steps; Details generally illustrate a single step. When you are directed to refer to a certain Pictorial "for the following steps," continue using that Pictorial until you are referred to another Pictorial for another group of steps.
4. Position all parts as shown in the Pictorials.
5. Solder instructions are generally given only at the end of a series of similar steps. You may solder more often if you desire.

6. Each circuit part in an electronic kit has its own component number (R2, C4, etc.). Use these numbers when you want to identify the same part in the various sections of the Manual. These numbers, which are especially useful if a part has to be replaced, appear:
- In the Parts List,
 - At the beginning of each step where a component is installed,
 - In some illustrations,
 - In Troubleshooting Charts,
 - In the Schematic,
 - In the sections at the rear of the Manual.
7. When you are instructed to cut something to a particular length, use the scales (rulers) provided at the bottom of the Manual pages.

SAFETY WARNING: Avoid eye injury when you cut off excessive lead lengths. Hold the leads so they cannot fly toward your eyes.

SOLDERING

Soldering is one of the most important operations you will perform while assembling your kit. A good solder connection will form an electrical connection between two parts, such as a component lead and a circuit board foil. A bad solder connection could prevent an otherwise well-assembled kit from operating properly.

It is easy to make a good solder connection if you follow a few simple rules:

1. Use the right type of soldering iron. A 22 to 25-watt pencil soldering iron with a 1/8" or 3/16" chisel or pyramid tip works best.
2. Keep the soldering iron tip clean. Wipe it often on a wet sponge or cloth; then apply solder to the tip to give the entire tip a wet look. This process is called tinning, and it will protect the tip and enable you to make good connections. When solder tends to "ball" or does not stick to the tip, the tip needs to be cleaned and retinned.

NOTE: Always use rosin core, radio-type solder (60:40 tin-lead content) for all of the soldering in this kit. This is the type we have supplied with the parts. The Warranty will be void and we will not service any kit in which acid core solder or paste has been used.

PARTS

Resistors are identified in Parts Lists and steps by their resistance value in Ω (ohms), $k\Omega$ (kilohms), or $M\Omega$ (megohms). They are usually identified by a color code of four or five color bands, where each color represents a number. These colors (except for the last band, which indicates a resistor's "tolerance") will be given in the steps in their proper order. Therefore, the following color code is given for information only. NOTE: Occasionally, a "precision" or "power" resistor may have the value stamped on it.

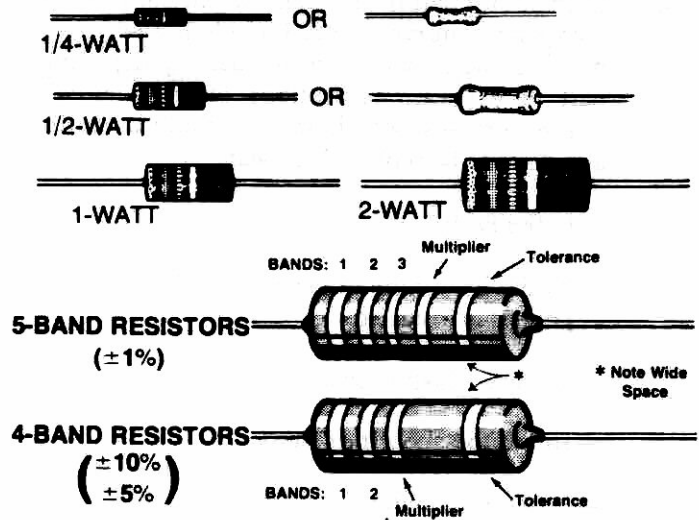

Band 1 1st Digit		Band 2 2nd Digit		Band 3 (if used) 3rd Digit		Multiplier		Resistance Tolerance	
Color	Digit	Color	Digit	Color	Digit	Color	Multiplier	Color	Tolerance
Black	0	Black	0	Black	0	Black	1	Silver	± 10%
Brown	1	Brown	1	Brown	1	Brown	10	Gold	± 5%
Red	2	Red	2	Red	2	Red	100	Red	± 2%
Orange	3	Orange	3	Orange	3	Orange	1,000	Brown	± 1%
Yellow	4	Yellow	4	Yellow	4	Yellow	10,000	Green	± .5%
Green	5	Green	5	Green	5	Green	100,000	Blue	± .25%
Blue	6	Blue	6	Blue	6	Blue	1,000,000	Violet	± .1%
Violet	7	Violet	7	Violet	7	Silver	0.01	Gray	± .05%
Gray	8	Gray	8	Gray	8	Gold	0.1		
White	9	White	9	White	9				

Capacitors will be called out by their capacitance value in μF (microfarads) or pF (picofarads) and type: ceramic, Mylar*, electrolytic, etc. Some capacitors may have their value printed in the following manner:

EXAMPLES:

$151K = 15 \times 10 = 150 \text{ pF}$

$759 = 75 \times 0.1 = 7.5 \text{ pF}$

NOTE: The letter "R" may be used at times to signify a decimal point: as in: $2R2 = 2.2 \text{ (pF or } \mu F)$.

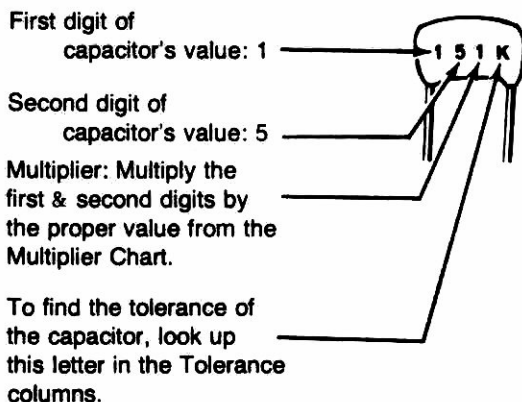

MULTIPLIER		TOLERANCE OF CAPACITOR		
FOR THE NUMBER:	MULTIPLY BY:	10 pF OR LESS	LETTER	OVER 10 pF
0	1	±0.1 pF	B	
1	10	±0.25 pF	C	
2	100	±0.5 pF	D	
3	1000	±1.0 pF	F	±1%
4	10,000	±2.0 pF	G	±2%
5	100,000		H	±3%
			J	±5%
8	0.01		K	±10%
9	0.1		M	±20%

*DuPont Registered Trademark.

PARTS LIST

Open the Parts Pack and check each part against the following list. **Do not remove any parts that are supplied on the tape strips until they are called for in an assembly step.** If a part is packed in an individual envelope with a part number on it, identify the part; place it back into its envelope until that part is called for in a step. Do not throw any packing materials away until that part is called for in a step. Do not throw any packing materials away until you have accounted for all the parts.

To order a replacement part, always include the **PART NUMBER.** Use the Parts Order Form furnished with this kit. If a Parts Order Form is not available, refer to "Replacement Parts" inside the rear cover of this Manual. For prices, refer to the separate "Heath Parts Price List."

KEY No.	HEATH Part No.	QTY.	DESCRIPTION	CIRCUIT Comp. No.
---------	----------------	------	-------------	-------------------

CAPACITORS

Mica

A1	20-76	1	68 pF	C102
A1	20-183	1	120 pF	C103
A1	20-103	2	150 pF	C106, C109
A1	20-107	2	680 pF	C107, C108

Other Capacitors

A2	21-147	1	47 pF ceramic	C112
A2	21-176	2	.01 μ F ceramic	C113, C114
A2	21-95	7	.1 μ F ceramic	C101, C104, C105, C110, C111, C115, C116
A3	25-927	1	22 μ F electrolytic	C117

METAL PARTS

B1	90-1357-1	1	Cabinet top
B2	200-1504-1	1	Chassis
B3	208-42	1	Battery holder

HARDWARE

NOTE: You may have to open more than one hardware packet to locate all of the hardware.

#6 Hardware

C1	250-1325	2	6-32 \times 1/4" screw
C2	250-1432	4	#6 \times 3/8" sheet metal screw
C3	250-1425	4	6-32 \times 1/2" screw
C4	252-3	12	6-32 nut
C5	254-1	8	#6 lockwasher

KEY No.	HEATH Part No.	QTY.	DESCRIPTION	CIRCUIT Comp. No.
---------	----------------	------	-------------	-------------------

Other Hardware

D1	250-49	2	3-48 \times 1/4" screw
D2	250-1412	8	4-40 \times 3/8" screw
D3	250-1437	1	8-32 \times 1/2" screw
D4	252-1	2	3-48 nut
D5	252-2	8	4-40 nut
D6	252-4	2	8-32 nut
D7	253-45	2	#8 flat washer
D8	254-7	2	#3 lockwasher
D9	254-9	7	#4 lockwasher
D10	254-2	2	#8 lockwasher
D11	259-9	1	#4 solder lug

WIRE-CABLE-SLEEVING

344-50	6"	Black wire
344-51	6"	Brown wire
344-52	24"	Red wire
344-58	6"	Gray wire
343-15	14"	Shielded cable
346-6	1	Piece sleeving

TRANSISTORS-INTEGRATED CIRCUITS (ICs)

NOTE: Transistors and integrated circuits may be marked for identification in any of the following four ways:

1. Part number.
2. Type number (on integrated circuits, this refers only to the numbers printed in **bold type**; the letters may be different or missing).
3. Part number and type number.
4. Part number with a type number other than the one listed.

E1	417-169	1	MPF105 transistor	Q103
E1	417-875	1	2N3904 transistor	Q102
E2	442-96	1	MC1496G IC	U101

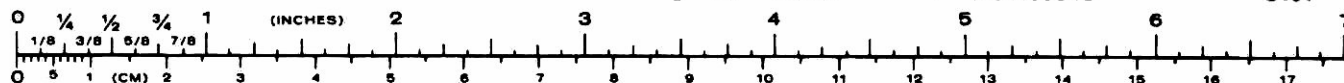

KEY No.	HEATH Part No.	QTY.	DESCRIPTION	CIRCUIT Comp. No.	KEY No.	HEATH Part No.	QTY.	DESCRIPTION	CIRCUIT Comp. No.
---------	----------------	------	-------------	-------------------	---------	----------------	------	-------------	-------------------

GENERAL

F1	40-2043	3	680 μ H choke (blu-gry-brn)	L101-L103
F2	45-643	1	330 μ H choke (org-org-brn)	L104
F3	60-20	1	Slide switch	SW1
F4	404-698	1	3.5 MHz crystal	Y101
F5	412-633	1	Red LED (light-emitting diode)	D1

CONNECTORS-JACKS

G1	432-798	1	Battery clip
G2	432-866	2	Spring connector
G3	432-1030	1	2-hole shell
G4	436-5	2	SO-239 jack
G5	436-28	1	Miniature phone jack

MISCELLANEOUS

	75-743	1	1" \times 3/4" paper insulator
	85-3092-1	1	Printed circuit board
H1	261-29	4	Foot
H2		1	Blue and white label
	597-260	1	Parts Order Form
		1	Assembly Manual (See title page for part number.)

Solder

TAPED COMPONENTS

The remaining parts are supplied on taped strips. It is not necessary to check them against the following list.

HEATH Part No.	QTY.	DESCRIPTION	CIRCUIT Comp. No.	HEATH Part No.	QTY.	DESCRIPTION	CIRCUIT Comp. No.
----------------	------	-------------	-------------------	----------------	------	-------------	-------------------

RESISTORS

NOTE: The following resistors are rated at 1/4-watt, and have a 5% tolerance unless otherwise noted.

6-330-12	1	33 Ω (org-org-blk)	R116
6-470-12	1	47 Ω (yel-viol-blk)	R112
6-221-12	1	220 Ω (red-red-brn)	R108
6-391-12	1	390 Ω (org-wht-brn)	R121
6-102-12	3	1000 Ω (brn-blk-red)	R105, R109, R122
6-222-12	7	2200 Ω (red-red-red)	R101, R106, R111, R114, R115, R117, R119

6-332-12	4	3300 Ω (org-org-red)	R103, R104, R110, R113
6-472-12	1	4700 Ω (yel-viol-red)	R102
6-103-12	1	10 k Ω (brn-blk-org)	R118
6-473-12	1	47 k Ω (yel-viol-org)	R107

NOTE: Be sure you have read the "Power Source" information on Page 3 so you will have a suitable power source available when you finish the assembly steps.

STEP-BY-STEP ASSEMBLY

CIRCUIT BOARD

Refer to Pictorial 1-1 in the Illustration Booklet as you read the following notes and perform the following steps.

NOTES:

1. Circuit board drawings such as the one shown in Pictorial 1-1 are divided into two or more sections. These sections show you which area of the circuit board you are working in for a specific series of steps.
 2. In each series of steps, corresponding to a circuit board section, you will install parts in a top-to-bottom, left-to-right sequence. Occasionally, you may be directed to install a particular component in an area out of sequence. Each of these components is identified in the step and on the Pictorial with a special callout (R101, C103, or L102, for example).
 3. As you perform each step, check it off in the box provided. You may also wish to place a check mark near each component on the Pictorial as you install the part.
 4. In general, solder instructions are given only at the end of a series of similar steps; you may solder more often if you wish.
- () Cut the "Taped Component Chart" from the last page in the Illustration Booklet. Make sure you read the instructions at the top of the chart before you use it. Note that it is divided into numbered sections which correspond to the numbered sections on the circuit board pictorial. The components are listed in the order of assembly.

In the following steps, you will be given detailed instructions on how to install and solder the first part on the circuit board. Read and perform each step carefully. Then use the same procedure as you install the remaining parts on the board.

Note that the circuit board has foil patterns on one side and the other side has outlines of components (parts) shown on it. The foil side of the board will be referred to as such, and the side with the outlines will be called the "component side" of the board.

- () Position the circuit board on your work area in front of you with the component side up as shown in Pictorial 1-1. NOTE: Always install parts on the component side of the circuit board and solder the leads or wires to the foil side, unless a step specifically directs you to do otherwise.
- () Cut the first part, a 1000 Ω (brn-blk-red) resistor, from the Taped Component Chart as outlined in the Chart instructions. Bend the resistor leads as shown to fit the hole spacing at R109 on the circuit board.

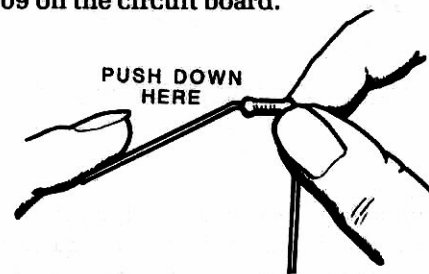

- () R109: Start the leads into the holes at the resistors location near the top of Section 1 of the circuit board. The end with the color bands may be positioned either way. NOTE: Resistors are identified by the following outline:

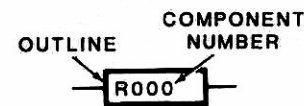

- () Press the resistor down against the top of the circuit board. Then bend the leads outward slightly to hold it in place.



() Turn the circuit board over and solder the resistor leads to the circuit board as follows:

1. Push the soldering iron tip against both the lead and the circuit board foil. Heat both for two or three seconds.

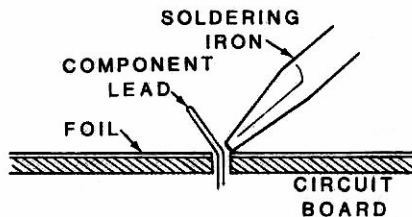

2. Then apply solder to the other side of the connection. **IMPORTANT:** Let the heated lead and the circuit board foil melt the solder.

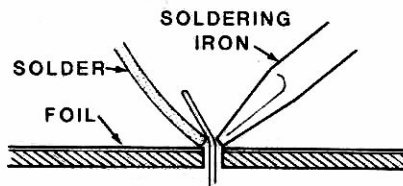

3. As the solder begins to melt, allow it to flow around the connection. Then remove the solder and the iron and let the connection cool.

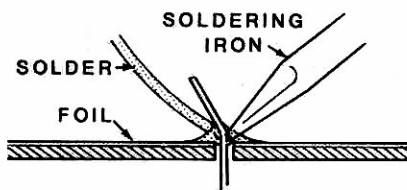

- () Cut off the excess lead lengths close to the connection. **WARNING:** Clip the leads so the ends will not fly toward your eyes.

- () Check each connection. Compare it to the illustrations on Figure 1 in the Illustration Booklet. After you have checked the solder connections, proceed with the assembly on this and the following pages. Use the same soldering technique for each connection.

Start at the top of Section 1 and install the following parts. The sequence of the steps matches the location of the components on the circuit board. **NOTE:** Make sure you installed R109 in an earlier step.

Section 1

- () R106: 2200 Ω (red-red-red).
- () R103: 3300 Ω (org-org-red).
- () R104: 3300 Ω (org-org-red).
- () R105: 1000 Ω (brn-blk-red).
- () R101: 2200 Ω (red-red-red).
- () Solder the leads to the foil and cut off the excess lead lengths.

Section 2

- () R110: 3300 Ω (org-org-red).
- () R115: 2200 Ω (red-red-red).
- () R114: 2200 Ω (red-red-red).
- () R111: 2200 Ω (red-red-red).
- () R102: 4700 Ω (yel-viol-red).
- () R116: 33 Ω (org-org-blk).
- () R107: 47 k Ω (yel-viol-org).
- () Solder the leads to the foil and cut off the excess lead lengths.

Heathkit®

Section 3

- R121: 390 Ω (org-wht-brn).
- R113: 3300 Ω (org-org-red).
- R117: 2200 Ω (red-red-red).
- R112: 47 Ω (yel-viol-blk).
- R119: 2200 Ω (red-red-red).
- R118: 10 k Ω (brn-blk-org).
- R108: 220 Ω (red-red-brn).
- R122: 1000 Ω (brn-blk-red).
- Solder the leads to the foil and cut off the excess lead lengths.

NOTE: To prepare a wire, as in the following step, cut the wire to the length indicated and then remove 1/4" of insulation from each end.

- Cut and prepare a 2-5/8" red wire.

NOTE: In the following step, locate wire location "W101" on the circuit board, which starts in Section 1 and ends in Section 3. When you install this wire, form it over the outline on the circuit board and push both wire ends down through their respective holes. Then solder the wire ends to the foil and cut off the excess ends.

- W101: 2-5/8" red wire.

Refer to Pictorial 1-2 for the following steps.

NOTES:

1. In the next two steps, when you install the transistors, the sections in which they are to be mounted will be called out at the beginning of the steps.
2. When you install the transistor in the following step, be sure to position the flat on the transistor over the outline of the flat on the circuit board. Then insert the leads into the circuit board holes and solder them to the foil. Cut off any excess lead lengths.

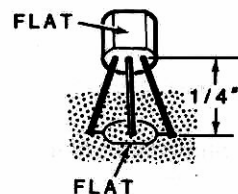

- Q102: (Section 1) 2N3904 transistor (#417-875).
- Q103: (Section 3) MPF105 transistor (#417-169).

Section 1

NOTE: When you mount ceramic and mica capacitors in the following steps, do not push the leads all the way down through the circuit board holes. These leads may have a thin coating of insulation at the top that will keep you from making a good solder connection.

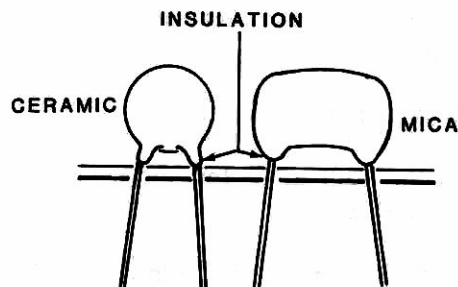

- C108: 680 pF mica capacitor.
- C107: 680 pF mica capacitor.
- C106: 150 pF mica capacitor.
- C101: .1 μ F ceramic capacitor.
- C105: .1 μ F ceramic capacitor.
- Solder the leads to the foil and cut off the excess lead lengths.

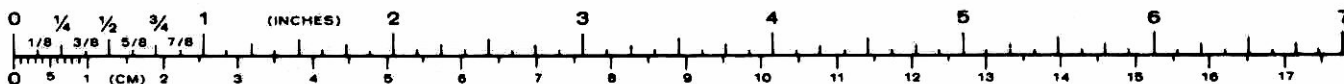

Section 2

- () C109: 150 pF mica capacitor.
- () C111: .1 μ F ceramic capacitor.
- () C110: .1 μ F ceramic capacitor.
- () C115: .1 μ F ceramic capacitor.
- () C114: .01 μ F ceramic capacitor.
- () C113: .01 μ F ceramic capacitor.
- () C103: 120 pF mica capacitor.
- () Solder the leads to the foil and cut off the excess lead lengths.

Section 3

- () C112: 47 pF ceramic capacitor.
- () C104: .1 μ F ceramic capacitor.
- () C116: .1 μ F ceramic capacitor.
- () L104: 330 μ H choke (org-org-brn, with silver multiplier band).
- () C102: 68 pF mica capacitor.
- () Solder the leads to the foil and cut off the excess lead lengths.
- () Form the leads of the MC1496G IC (#442-96) as shown. NOTE: When you install this IC in the next step, be sure to match the tab on the IC with the outline of the tab on the circuit board.

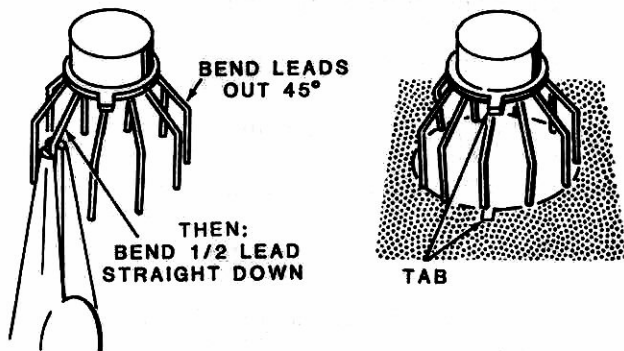

- () U101: (Section 2) MC1496G IC at U101. Solder the leads to the foil and cut off the excess lead lengths.

Refer to Pictorial 1-3 for the following steps.

NOTE: As you install each component in the following steps, solder its leads to the foil and, if applicable, cut off the excess lead lengths.

- () L103: 680 μ H choke (#40-2043, blu-gry-brn). NOTE: You may install this choke either way.
- () L102: 680 μ H choke (#40-2043, blu-gry-brn).
- () L101: 680 μ H choke (#40-2043, blu-gry-brn).

NOTE: In the next step, install the crystal you received with your kit, either in the larger or the smaller outline on the circuit board. Holes have been provided for both sizes.

- () Y101: 3.5 MHz crystal (#404-698). Push the crystal leads as far as possible through the board.

NOTE: In the next step, when you install the electrolytic capacitor, be sure to match the negative (-) mark on the capacitor with the negative (-) mark on the circuit board, OR match the positive (+) mark on the capacitor with the positive (+) mark on the board.

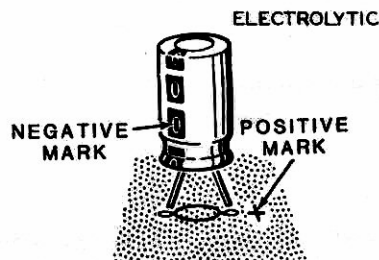

- () C117: 22 μ F electrolytic (#25-927).

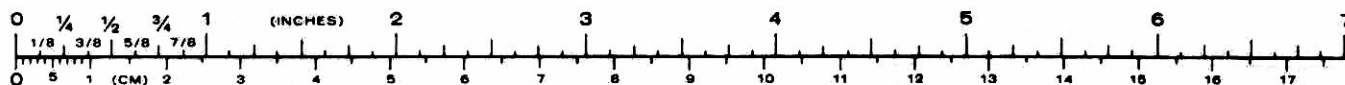

Heathkit®

NOTE: When a step calls for hardware, only the screw size is given. For instance, if "3-48 × 1/4" hardware" is called for, it means you should use a 3-48 × 1/4" screw, one or more #3 lockwashers, and a 3-48 nut at each indicated mounting hole. The Detail referred to in the step will show the proper number and placement of each hardware item.

() Refer to Detail 1-3A and mount the battery holder on the circuit board at the center of the BT101 outline in the manner shown. Use two sets of 3-48 hardware.

() Prepare the following wires:

3" gray	6" red
5-1/2" brown	6" black
7" red	

NOTE: In the following steps, when you install a wire on the circuit board, solder it to the foil and cut off the excess wire end. The free wire ends will be connected later.

() 3" gray wire to hole A.

() 5-1/2" brown wire to hole C.

() 7" red wire to the hole labeled "9V."

() Crimp and solder a spring connector on one end of the 6" red wire in the manner shown. Cut the bare wire end to 1/8".

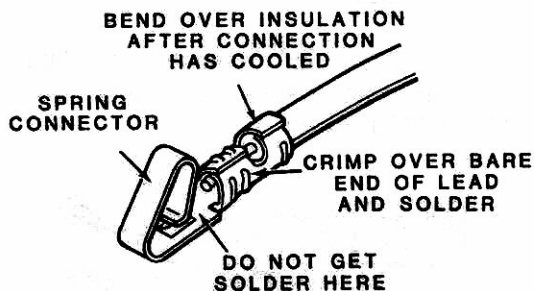

() In the same manner, crimp and solder another spring connector on one end of the 6" black wire.

() Position the 2-hole shell as shown. Then push the spring connector on the end of the black wire, tab up, into shell hole 1.

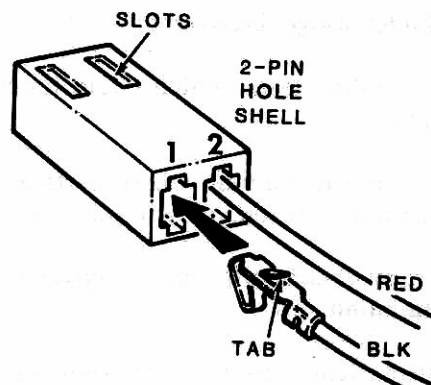

() Similarly, push the connector on the end of the red wire into hole 2 of the shell.

() On the other end of this assembly, connect the red wire to circuit board hole B, and the black wire to hole G (adjacent to hole B).

() Refer to Detail 1-3B and prepare the leads of the battery clip as shown. Remove 1/4" of insulation from each lead end; then tightly twist the end and apply a small amount of solder to hold the fine strands together.

() Connect the black battery clip lead to hole G near the back edge of the circuit board. Solder the lead to the foil and cut off the excess lead end. **NOTE:** The red battery clip lead will be connected later.

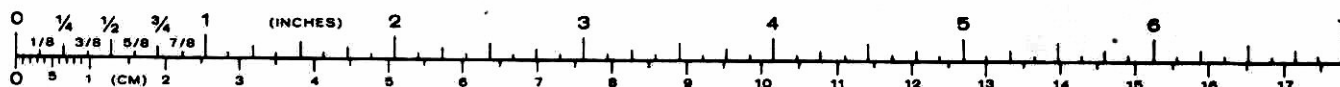

Circuit Board Checkout

Carefully inspect the foil side of the circuit board for the following most-commonly-made errors.

- () Unsoldered connections.
- () Poor solder connections.
- () Solder bridges between foil patterns.
- () Protruding leads which could touch together.

Refer to the illustrations where parts are installed as you make the following checks:

- () Transistors for the proper type and installation.
- () Electrolytic capacitor for the correct position of the positive (+) or negative (-) marks.
- () IC for the proper installation.

Set the circuit board aside temporarily.

CHASSIS

Refer to Pictorial 2-1 for the following steps.

- () Position the chassis on your work area as shown.
- () Scrape away any paint from around holes AA, AB, AC, AD, and AE in the bottom of the chassis. Also remove any paint from around the four screw holes at J102 and J103, as well as the hole at J101.
- () Secure a 6-32 × 1/2" screw to the bottom of the chassis at AA with a #6 lockwasher and a 6-32 nut.

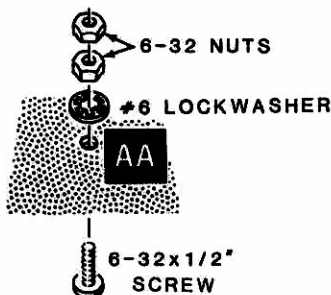

- () In the same manner, install three sets of 6-32 × 1/2" hardware at AB, AC, and AD.
- () Turn one additional 6-32 nut down onto each of the screws at AA through AD until it is snug.
- () At AE, from the inside of the rear panel, install an 8-32 × 1/2" screw, two #8 lockwashers, and an 8-32 nut. After you have tightened the nut securely, place two #8 flat washers on the screw; then turn another 8-32 nut onto the end of the screw. Turn the nut down with your fingers; do not tighten it further at this time.

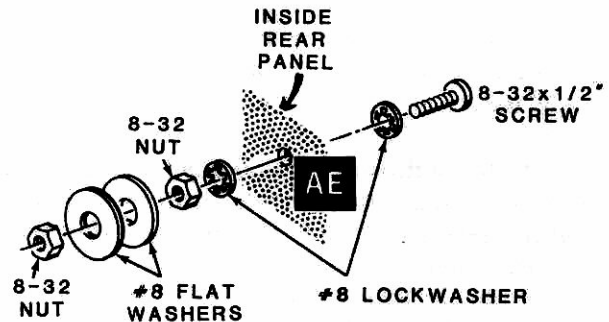

- () Mount a miniature phone jack on the rear panel at J101. Use the hardware supplied with the jack. Position the jack as shown in the Pictorial.

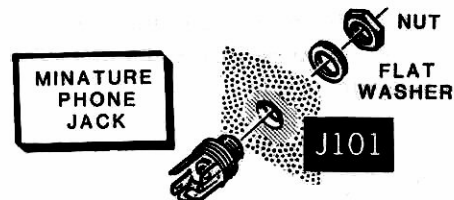

- () Install an SO-239 jack on the rear panel at J102 in the manner shown. Use four sets of 4-40 × 3/8" hardware.

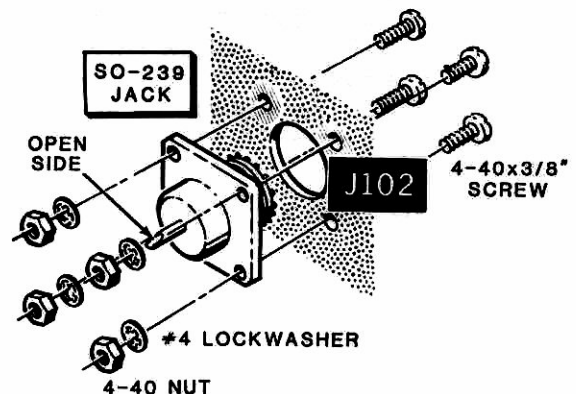

- () In the same manner, install the other SO-239 jack on the rear panel at J103. Use a #4 solder lug at SL1 in the place of the #4 lockwasher. Position the solder lug as shown in the Pictorial.
- () SW1: Install the slide switch on the front panel with two 6-32 × 1/4" screws in the manner shown. Be sure to install the switch with the open space toward the bottom of the chassis.

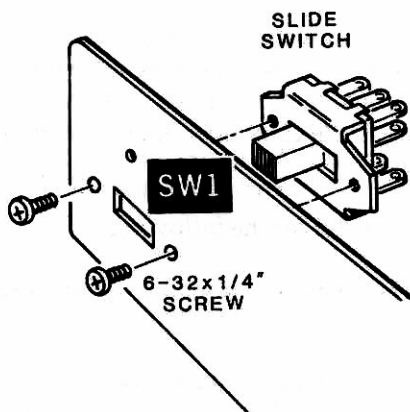

In the following step, when you install the LED in the front panel, refer to Detail 2-1A and proceed as follows:

1. Cut 1/8" from the narrow 1" edge of the 3/4" × 1" paper insulator as shown.
2. Remove the paper backing from the paper insulator.
3. Push the hole in the insulator down onto the leads of the LED, sticky side toward the front lens of the LED.
4. If necessary, straighten the LED leads.
5. Make sure the longer LED lead is toward the **center of the front panel**, and that the narrower edge of the paper insulator is down, toward the top of the slide switch.
6. Position the LED into the front panel and press the insulator firmly in place around the back of the LED.

- () D101: Refer to Detail 2-1A and install the red LED (#412-633) at D101 in the described manner.

Refer to Pictorial 2-2 for the following steps.

Refer to Detail 2-2A and install the circuit board assembly in the chassis in the following manner.

- () Place a #6 lockwasher on each of the screws in the bottom of the chassis at AA, AB, AC, and AD. Position the circuit board assembly down onto the ends of the four screws and secure it in place with four 6-32 nuts. Be sure the battery holder is toward the front of the chassis.

Final Wiring

NOTES:

1. In the following steps, (NS) means not to solder because other wires will be connected later. "S-" with a number, such as (S-2), means to solder the connection. The number following the "S-" tells how many wires are in the connection.
2. Refer to the inset drawing on the Pictorial to locate switch SW1 lugs in the following steps.

- () Connect the end of the gray wire coming from circuit board hole A to switch SW1 lug 7 (S-1).
- () Connect the end of the brown wire coming from circuit board hole C to switch SW1 lug 4 (S-1).
- () Prepare a 7" red wire.
- () Connect one end the 7" red wire to switch SW1 lug 1 (S-1). Connect the other end of the wire to miniature phone jack J101 lug 3 (S-1).
- () Locate the red wire coming from the battery clip. Connect the end of this wire to J101 lug 2 (S-1). NOTE: J101 lug 1 will not be used.

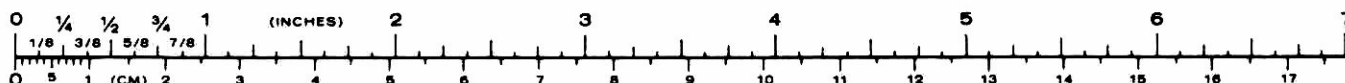

In the following step, refer to Detail 2-2B and cut and prepare the two lengths of shielded cable as follows:

1. Cut the cables to the lengths indicated.
 2. At each end of the cables, remove 3/4" of the outer insulation and the foil wrapping.
 3. At both ends of each cable, remove 1/4" of insulation from the inner cable lead as shown.
 4. At end B of both cables, cut off the shield leads.
- () Cut and prepare a 6-1/4" and a 7-3/4" shielded cable as outlined above.
- () At **end B** of the 6-1/4" shielded cable, connect the inner lead to switch SW1 lug 8 (S-1). Connect the other end of this cable as follows: Inner lead to the center conductor of rear panel jack J102 (S-1), and the shield lead to SL1 (NS).
- () At **end B** of the 7-3/4" shielded cable, connect the inner lead to switch SW1 lug 9 (NS). Connect the other end of this cable as follows: Inner lead to the center conductor of rear panel jack J103 (S-1), and the shield lead to SL1 (S-2).
- () Remove all the insulation from a 1" wire. Use a piece of leftover gray wire for this purpose.
- () Connect one end of the 1" bare wire to switch SW1 lug 5 (S-1) and the other end to lug 9 (S-2). Cut off the excess wire ends.
- () Connect the end of the red wire coming from circuit board hole "9V" to switch SW1 lug 2 (S-1).

- () Push the 2-hole shell, slots down, onto the leads of LED D101. Make sure the longer LED lead is matched with the red wire. Using pliers, bend the LED leads around the outside of the shell and cut off the excess lead ends.

NOTE: Do not install a battery in your kit until you are directed to do so in a step, **or** do not connect power to the rear panel power jack at J101. Do **not** perform the following step if you are going to use a 9-volt battery for kit power.

- () If you are not going to use a battery, push the short piece of large sleeving up over the battery clip contacts. This will keep them from shorting to the chassis or to circuit board components.

Refer to Pictorial 2-3 for the following steps.

- () Turn the chassis assembly upside down as shown.
- () Remove the paper backing from each of the four feet, and press a foot near each corner of the chassis bottom as shown in the Pictorial.
- () Remove the paper backing from the blue and white label and press the label in place on the chassis bottom as shown. NOTE: Be sure to refer to the Model and Series numbers on the blue and white label in any correspondence you have with the Heath Company about your kit.

Except for the "Final Assembly," this completes the "Step-by-Step Assembly" of your kit.

INITIAL TESTS

NOTE: Do not install the battery or otherwise apply power to your VLF Converter until you are directed to do so in a step.

Refer to Pictorial 3-1 for the following steps.

You will need a high input impedance volt-ohmmeter for the following tests.

- () Position your Converter as shown in the Pictorial.
- () Set your ohmmeter to its $R \times 100$ range.
- () Connect the ohmmeter ground (common) lead to SL1 on the Converter rear panel.
- () Push the POWER switch to OFF.

NOTE: In the following steps, if you do not get the correct results, do not proceed. Refer to the "In Case of Difficulty" section of this Manual. After you have found and corrected the problem, you may proceed with these tests.

- () Touch the positive ohmmeter probe to rear panel jack J101, lug 2 (+ battery clip lead). Check for an infinity ohmmeter reading.
- () Push the POWER switch to ON.
- () Touch the ohmmeter probe to jack J101 lug 2 again. The ohmmeter reading should be greater than 400Ω .
- () Turn OFF the POWER switch.

- () Connect your 9-volt NEDA Type 1604 battery to the battery clip; then push the battery down into the circuit board battery holder.

OR

If you have purchased a power supply cube or have another source of external power, connect this power to rear panel power jack J101.

- () Set your voltmeter to read (up to) +15 volts DC.
- () Connect the voltmeter ground (common) lead to rear panel solder lug SL1.
- () Touch the positive voltmeter probe to switch SW1 lug 1. The voltage at this point should be greater than 6.0 volts DC.
- () Push the POWER switch to ON.
- () Check and make sure the voltage on SW1 lug 1 is approximately the same as the previous step. Also check and make sure LED D101 is lit.
- () Disconnect and turn off the voltmeter.
- () Turn OFF the Converter POWER switch.
- () If you are using an external source of power, disconnect the power plug from J101.

This completes the "Initial Tests"; proceed to "Final Assembly."

FINAL ASSEMBLY

Refer to Pictorial 4-1 for the following steps.

() Position the chassis as shown.

() Place the top cover on the chassis assembly and secure it in place with four #6 × 3/8" screws as shown.

This completes the "Final Assembly" of your kit.

INSTALLATION AND OPERATION

INSTALLATION

Refer to Pictorial 5-1 for the following steps.

As we said on Page 3, you will need a suitable source of power. Install either a 9-volt NEDA Type 1604 (1604A) internal battery, or connect an external source of from 6 to 14 volts DC that is rated at at least 20 mA.

Connect a long-wire antenna to ANTENNA jack J102 on the Converter rear panel. You may use a long horizontal wire antenna with its end connected to the center pin of ANTENNA jack J102, or you may also use a vertical antenna with its downlead connected to the same point. We suggest that you use a PL-239 connector with its outer shell grounded at some convenient point near your radio. You may also use a loop antenna for VLF reception, as these are effective in nulling out interference.

The exact length of a long-wire antenna is relatively unimportant; a resonant antenna is not required for good signal pickup. Any practical antenna will be short when compared to the wavelength. However, the longer you make your antenna, the better your reception.

Connect the OUTPUT of the Converter at J103 to your receiver. You can use any type of radio capable of receiving from 3.500 to 4.010 MHz: A ham radio, or an SWL receiver which has AM, selectable sideband, or BFO capability.

OPERATION

As most VLF signals are not amplitude modulated, set your receiver for CW or SSB reception.

Tune your receiver up from a frequency of 3.500 MHz. The VLF signals that you hear will be at the frequency shown on the dial minus 3500. For example, if your receiver is tuned to 3560 (kHz) and you are listening to a VLF transmission, the actual transmitted signal will be 3560 minus 3500 (in kilohertz), or 60 kHz. At a dial reading of 3700 (or 3.700 MHz), you will be listening to a VLF transmission at 200 kHz, etc.

The VLF band from 10 to 160 kHz contains standard frequency long-range navigation, radioteletype, and other signals. The band from 160 to 190 kHz is a license-free band with transmission power limited to one watt and antenna lengths of up to 50 feet.

European broadcasters use the band from 150 to 280 kHz with high power. 410-500 kHz is used by coastal shipping. From 190 to 410 kHz, you will hear a large number of radio beacons, most of which identify themselves with call letters sent in code. Some also have AM modulation with weather reports and other information. Some examples follow:

Frequency (In kHz)	Call	Location
192	SFI	Petaluma, CA
233	LG	Long Beach, CA
236	GNI	Grand Isle, LA
263	MFR	Medford, OR
280	IPA	Easter Island
344	ZIY	Grand Cayman, BWI
365	LEO	Leon, Mexico
397	ZBB	Bimini, Bahamas

Interference

Your VLF Converter was designed to minimize feed-through of 80-meter signals and cross-modulation from standard broadcast signals. However, if your receiver or its interconnecting cable is not well shielded, you may hear 80-meter signals. To check for this, turn off the Converter power; the VLF signal will disappear but any 80-meter interference will remain.

If you hear a standard broadcast station in the VLF band, cross-modulation is present. You may eliminate this by using a shorter antenna, an attenuator between the antenna and the Converter, a series-tuned trap at the station's frequency, or a tuned circuit at the VLF frequency.

IN CASE OF DIFFICULTY

The following "Visual Checks" tell you what to do about any difficulties that occur right after your unit is assembled. If the "Visual Checks" fail to clear up the problems, or if difficulties occur after your unit has been in use for some time, refer to the "Troubleshooting Chart."

NOTE: Refer to the "Circuit Board X-Ray View" for the physical location of parts.

VISUAL CHECKS

1. Recheck the wiring. Trace each lead with a colored pencil on the Pictorial as you check it. It is frequently helpful to have a friend check your work. Someone who is not familiar with the unit may notice something you have consistently overlooked.
2. About 90% of the kits that are returned to the Heath Company for service do not function properly due to poor connections and soldering. Therefore, you can eliminate many troubles by reheating all connections to make sure they are soldered as described in the "Soldering" instructions on Illustration Booklet, Page 2.
3. Closely examine the circuit board foil in a good light to see that no solder bridges exist between adjacent connections. Remove any solder bridges by holding a clean, hot soldering iron tip between the two points that are bridged until the excess solder flows down onto the tip. Compare your foil patterns with the "Circuit Board X-Ray View."
4. Check to be sure each transistor is in the proper location (correct part number and/or type number). Make sure each transistor lead is connected to the proper point.
5. Check to be sure the LED is correctly connected.
6. Check the electrolytic capacitor to be sure its positive (+) and negative leads are at the correct positions.
7. Check each resistor value carefully. Be sure in each step that the proper part has been wired into the circuit as shown in the Pictorial diagrams. It would be easy, for example, to install a 22 k Ω (red-red-org) resistor where a 3300 Ω (org-org-red) resistor should have been installed.
8. Be sure all the wires and leads connected to the circuit boards have been trimmed as close as possible to the circuit board foils.
9. Check for bits of solder, wire ends, or other foreign matter which may be lodged in the wiring.

If you still have not located the trouble after the "Visual Checks" are completed and a voltmeter is available, check the voltage readings at the locations indicated on the Schematic diagram. NOTE: All voltage readings were taken with a high input impedance voltmeter. Voltages may vary slightly, up to $\pm 10\%$.

NOTE: In an extreme case where you are unable to resolve a difficulty, refer to the "Customer Service" information inside the rear cover of this Manual. Your Warranty is located inside the front cover.

Troubleshooting Chart

The following chart lists problems and possible cause of some troubles you might encounter. If a particular part is mentioned (Q102 for example) as a possible cause, check that part and any other components connected to it to see that they are installed and/or wired correctly. Also check for solder bridges and poor connections in the surrounding area. It is also possible, on rare occasions, for a part to be faulty and require replacement.

PROBLEM	POSSIBLE CAUSE
LED does not light.	<ol style="list-style-type: none"> 1. Weak battery. 2. Switch SW1A. 3. Jack J101. 4. LED D101.
Signal does not bypass Converter when Power switch is off.	<ol style="list-style-type: none"> 1. Jacks J102, J103. 2. Switch SW1B, SW1C.
No output signal.	<ol style="list-style-type: none"> 1. Transistors Q102, Q103. 2. IC U101. 3. Crystal Y101.
Poor sensitivity.	<ol style="list-style-type: none"> 1. Weak battery. 2. Inductors L101-L103. 3. Transistors Q102, Q103. 4. Capacitors C106-C109.

SPECIFICATIONS

Input Frequencies	10 to 500 kHz.
Output Frequencies	3.510 to 4.000 MHz.
Sensitivity	1 to 5 μ V, typical.
Power Requirements	6 to 14 VDC, Type 1604 9-volt battery; or external power supply, at 20 mA typical.
Dimensions	5-1/8" \times 5-1/8" \times 2-1/4" (13 \times 13 \times 5.7 cm).
Net Weight	1 lb. (.45 kg).

The Heath Company reserves the right to discontinue products and change specifications at any time without incurring any obligation to incorporate new features in products previously sold.

CIRCUIT DESCRIPTION

Refer to the Schematic Diagram in the Illustration Booklet as you read the following Circuit Description.

The incoming 10-500 kHz signals are routed from J102 through the contacts of switch SW1C to the base of isolation RF amplifier transistor Q102. The signal from the collector of Q102 is then passed through a filter network consisting of inductors L101 through L103 and capacitors C106 through C109. This filter eliminates all higher frequency broadcast and 3.5 MHz signals. The signal is then fed to mixer IC U101 pin 1 to be combined with the local oscillator signal at pin 7.

The local oscillator consists of the 3.5 MHz crystal, oscillator transistor Q103, and its associated com-

ponents. The 3.5 MHz signal output from this circuit is routed to pin 7 of U101 to be mixed with the incoming signal at pin 1.

Internally, the signals from pins 1 and 7 are mixed and the added signals, ranging in frequency from 3.510 to 4.000 MHz, are routed from U101 pin 6 through the contacts of switch SW1B to the output of the Converter at J103 for reception on the input of your receiver.

Power for the VLF converter consists of either an internal 9-volt Type 1604 (1604A) battery, or an external power supply of from 6 to 14-volts DC, typically at 20 mA. A Heath Power cube, Model PS-2350, is recommended for this unit.

CIRCUIT BOARD X-RAY VIEW

To find the PART NUMBER of a component for the purpose of ordering a replacement part:

- A. Find the circuit component part number (R102, C106, D101, etc.) on the X-Ray view.
- B. Locate the same number in the "Circuit Component Number" column of the "Parts List" in the front of the Manual.
- C. Adjacent to the circuit component number, you will find the PART NUMBER and DESCRIPTION which must be supplied when you order a replacement part.

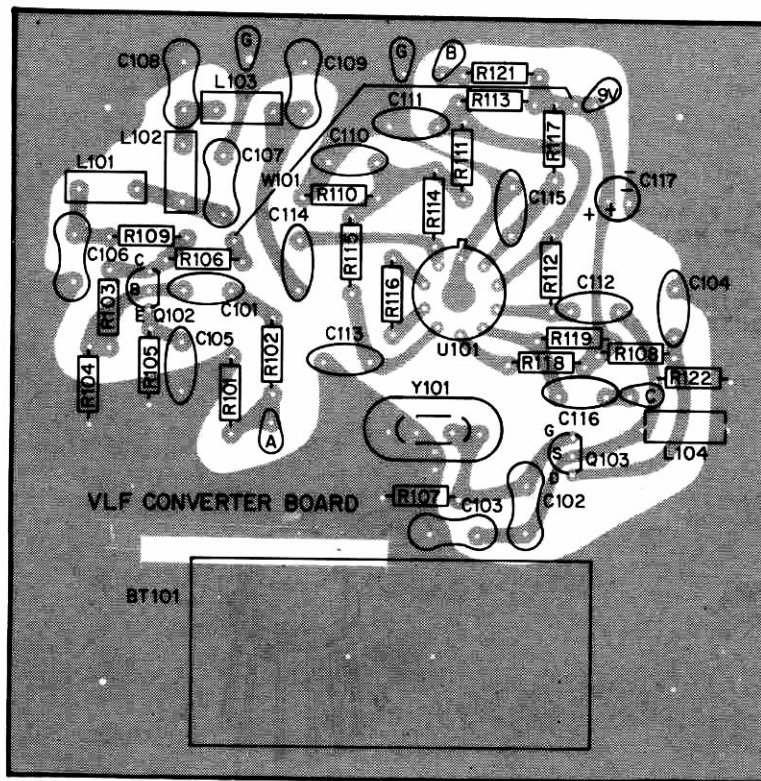

(Shown from the component side.)

SEMICONDUCTOR IDENTIFICATION

<u>COMPONENT NUMBER</u>	<u>HEATH PART NUMBER</u>	<u>MAY BE REPLACED WITH</u>	<u>KEY NUMBER</u>
DIODE			
D101	412-633	5082-4484	A1
TRANSISTORS			
Q102	417-169	MPF105	A2
Q103	417-875	2N3904	A3
INTEGRATED CIRCUIT			
U101	442-96	MC1496G	A4

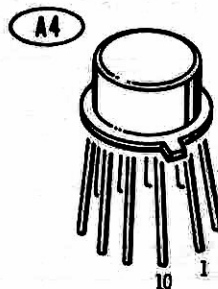
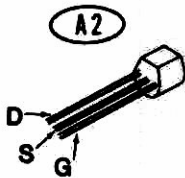
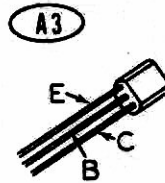
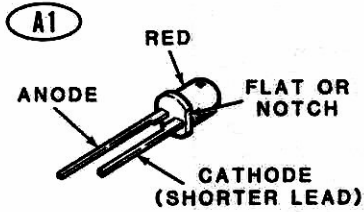

CUSTOMER SERVICE

REPLACEMENT PARTS

Please provide complete information when you request replacements from either the factory or Heath Electronic Centers. Be certain to include the **HEATH** part number exactly as it appears in the parts list.

ORDERING FROM THE FACTORY

Print all of the information requested on the parts order form furnished with this product and mail it to Heath. For telephone orders (parts only) dial 616 982-3571. If you are unable to locate an order form, write us a letter or card including:

- Heath part number.
- Model number.
- Date of purchase.
- Location purchased or invoice number.
- Nature of the defect.
- Your payment or authorization for COD shipment of parts not covered by warranty.

Mail letters to: Heath Company
Benton Harbor
MI 49022
Attn: Parts Replacement

Retain original parts until you receive replacements. Parts that should be returned to the factory will be listed on your packing slip.

OBTAINING REPLACEMENTS FROM HEATH ELECTRONIC CENTERS

For your convenience, "over the counter" replacement parts are available from the Heath Electronic Centers listed in your catalog. Be sure to bring in the original part and purchase invoice when you request a warranty replacement from a Heath Electronic Center.

TECHNICAL CONSULTATION

Need help with your kit? — Self-Service? — Construction? — Operation? — Call or write for assistance. you'll find our Technical Consultants eager to help with just about any technical problem except "customizing" for unique applications.

The effectiveness of our consultation service depends on the information you furnish. Be sure to tell us:

- The Model number and Series number from the blue and white label.
- The date of purchase.
- An exact description of the difficulty.
- Everything you have done in attempting to correct the problem.

Also include switch positions, connections to other units, operating procedures, voltage readings, and any other information you think might be helpful.

Please do not send parts for testing, unless this is specifically requested by our Consultants.

Hints: Telephone traffic is lightest at midweek — please be sure your Manual and notes are on hand when you call.

Heathkit Electronic Center facilities are also available for telephone or "walk-in" personal assistance.

REPAIR SERVICE

Service facilities are available, if they are needed, to repair your completed kit. (Kits that have been modified, soldered with paste flux or acid core solder, cannot be accepted for repair.)

If it is convenient, personally deliver your kit to a Heathkit Electronic Center. For warranty parts replacement, supply a copy of the invoice or sales slip.

If you prefer to ship your kit to the factory, attach a letter containing the following information directly to the unit:

- Your name and address.
- Date of purchase and invoice number.
- Copies of all correspondence relevant to the service of the kit.
- A brief description of the difficulty.
- Authorization to return your kit COD for the service and shipping charges. (This will reduce the possibility of delay.)

Check the equipment to see that all screws and parts are secured. (Do not include any wooden cabinets or color television picture tubes, as these are easily damaged in shipment. Do not include the kit Manual.) Place the equipment in a strong carton with at least **THREE INCHES** of *resilient* packing material (shredded paper, excelsior, etc.) on all sides. Use additional packing material where there are protrusions (control sticks, large knobs, etc.). If the unit weighs over 15 lbs., place this carton in another one with 3/4" of packing material between the two.

Seal the carton with reinforced gummed tape, tie it with a strong cord, and mark it "Fragile" on at least two sides. Remember, the carrier will not accept liability for shipping damage if the unit is insufficiently packed. Ship by prepaid express, United Parcel Service, or insured Parcel Post to:

Heath Company
Service Department
Benton Harbor, Michigan 49022



HEATH COMPANY • BENTON HARBOR, MICHIGAN
THE WORLD'S FINEST ELECTRONIC EQUIPMENT IN KIT FORM

LITHO IN U.S.A.