

# ALINCO

VHF/UHF TWIN BAND FM TRANSCEIVER

# DR-605T

# DR-605E

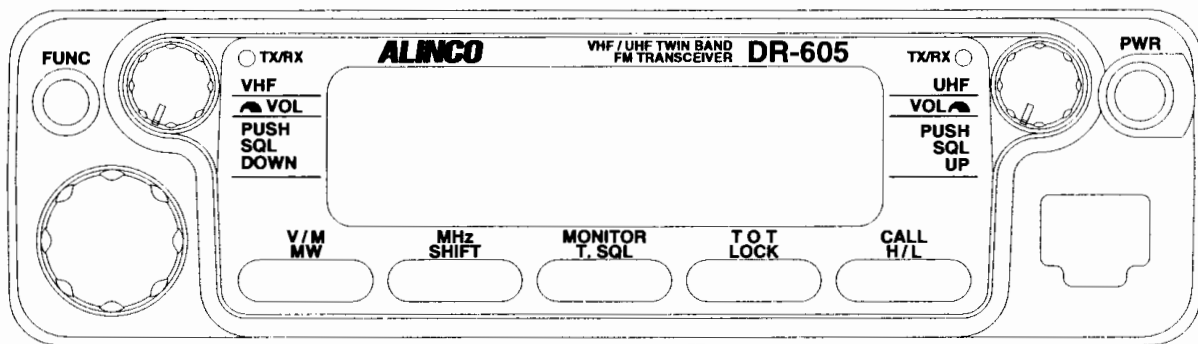

## Instruction Manual

Thank you for purchasing this **ALINCO** transceiver. To obtain optimum performance from this transceiver, read this instruction manual thoroughly, and keep it for future reference.

## NOTICE

This equipment has been tested and found to comply with the limits pursuant to Part 15 of the FCC Rules. These limits are designed to provide reasonable protection against harmful interference in a residential installation. This equipment generates, uses, and can radiate radio frequency energy, and if not installed and used in accordance with the instructions, may cause harmful interference to radio communications. However, there is no guarantee that interference will not occur in a particular installation. If this equipment does cause harmful interference to radio or television reception, which can be determined by turning the equipment off and on, the user is encouraged to try to correct the interference by one or more of the following measures.

- *Reorient or relocate the receiving antenna.*
- *Increase the separation between the equipment and receiver.*
- *Connect the equipment into an outlet on a circuit different from that which the receiver is connected.*
- *Consult the dealer or an experienced radio/TV technician for help.*

# Precautions

- Do not open the transceiver case or touch no-user-serviceable components.

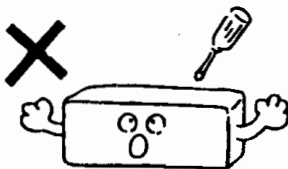

- Do not expose the transceiver to direct sunlight or to source of heat. Also, avoid using the transceiver in an extremely dusty or humid environment.

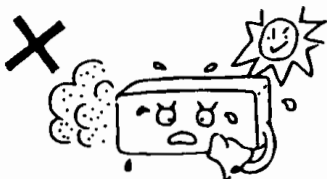

- Do not place anything which might spill over on top of the transceiver.



- For good ventilation, allow about 10 cm between the rear of the transceiver and the wall.

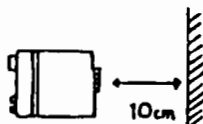

- If the transceiver causes harmful interference to VCR or TV reception, move the transceiver away from the appliance.

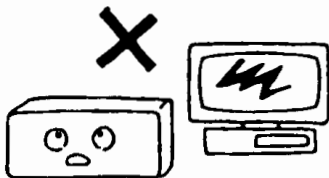

- Do not yank the power cable from its outlets. Also, do not rewire the power cable with other extension cables. Such handling may damage or short-circuit the cable.

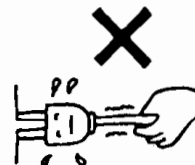

- Use a 13.8 V DC regulated power supply to operate this transceiver. The transceiver must be grounded.

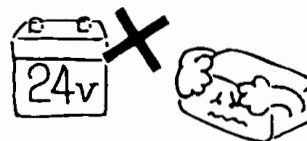

- Beware of moisture condensation. Moisture in the air will condense on the transceiver when you move it from a cold place to a warm place. Condensation will cause the unit to malfunction. If condensation forms on the unit, wipe or let dry.



- If the transceiver ever emits smoke or strange smells, immediately turn it off and unplug it. Then, contact an authorized ALINCO dealer.

## ■ Before Transmitting

There are many commercial and business related stations located near the ham bands. When operating an amateur station, it is important to observe all the proper rules of conduct and not to cause harmful interference to other stations, especially during mobile operation.

In particular, be sure to obtain the proper approval, when operating your transceiver in the following locations: aboard ships or airplanes, in the vicinity of airports, aboard trains, near commercial stations, and near commercial repeaters.

# Contents

Precautions .....	ii
Contents .....	iii
About This Manual.....	v
Document Conventions.....	vi
<b>CHAPTER 1 GETTING STARTED .....</b>	<b>1</b>
1.1 Unpacking.....	1
1.2 Keys, Terminals, and Display.....	2
Front Panel .....	2
LCD Display .....	5
Rear Panel .....	6
Microphone .....	6
<b>CHAPTER 2 INSTALLATION AND CONNECTION.....</b>	<b>7</b>
2.1 Installation and Connection for Base Station .....	7
Connecting the Microphone .....	7
Connecting an Antenna .....	7
Connecting the Power Supply .....	8
Connecting an External Speaker .....	8
2.2 Installation and Connection for Mobile Use.....	9
Installation Place .....	9
Connecting the Microphone .....	9
Connecting the Power Supply .....	9
Installing the Transceiver .....	10
Attaching a Mobile Antenna .....	10
<b>CHAPTER 3 BASIC OPERATION.....</b>	<b>11</b>
3.1 Reception .....	11
Turning the Power on.....	11
Adjusting the Volume .....	11
Adjusting Squelch .....	11
Selecting the Main Band .....	12
Setting a Frequency.....	13
3.2 Transmission.....	14
Selecting the Main Band .....	14
Setting Frequency.....	14
Selecting the Output Power.....	14
Transmitting .....	14
3.3 Operation Modes.....	15
VFO Mode.....	15
Memory Mode.....	15
CALL mode.....	15



*Note: This manual uses the DR-605T (U.S. Version) for examples, however, operation of DR-605E (European Version) is similar.*

<b>CHAPTER 4 ADVANCED FUNCTIONS .....</b>	<b>16</b>
4.1 Memory Channel .....	16
Storable Data .....	16
Recalling Memory Channels .....	16
Programming a Memory Channel .....	17
Erasing Memory Channels .....	18
4.2 <b>CALL</b> Channel .....	19
Recalling the <b>CALL</b> Channel .....	19
Changing the <b>CALL</b> Channel Frequency .....	19
4.3 Scanning .....	20
Band Scanning .....	20
Memory Scanning .....	21
Operation during Scanning .....	22
4.4 Other Useful Functions .....	23
Tone Encoder and Tone Frequency .....	23
<b>TOT</b> Function .....	24
Split Function .....	26
Reverse Function .....	29
Channel Step Selection .....	30
<b>KEY LOCK</b> function .....	30
<b>MONITOR</b> Function .....	31
Beep On/Off Setting .....	31
4.5 Resetting .....	32
<b>CHAPTER 5 SELECTIVE COMMUNICATION .....</b>	<b>33</b>
5.1 Tone Squelch (CTCSS) .....	33
Selecting a Tone Frequency .....	33
Transmission .....	34
Reception .....	34
Scanning .....	34
Turning off the Tone Squelch .....	34
Tone Scanning .....	35
5.2 Tone Burst .....	36
<b>CHAPTER 6 MAINTENANCE .....</b>	<b>37</b>
6.1 Troubleshooting .....	37
6.2 Cleaning .....	38
<b>APPENDICES .....</b>	<b>39</b>
A Packet Operation .....	39
1200 bps Packet Operation .....	40
9600 bps Packet Operation .....	41
B Channel Display Mode .....	42
C <b>XBR</b> (Crossband Repeater) Mode (for the DR-605T Only) .....	43
D <b>CLONING</b> Mode .....	44
E <b>SET</b> Mode .....	45
Accessing the <b>SET</b> Mode .....	45
Selecting Setting Items .....	45
Confirming the Setting .....	46
Setting Scanning Resume Condition .....	46
Setting Tone Burst Frequency .....	46
Setting <b>BCLO</b> (Busy Channel Lock out) Level .....	47
Turning <b>MONITOR</b> and <b>KEY LOCK</b> Functions On/Off (for the Channel Display Mode 1 Only) .....	47
F Options .....	48
G Specifications .....	

# About This Manual

## **CHAPTER 1 GETTING STARTED**

Shows the items in the DR-605 package. Check that all items are included. This chapter also explains the keys, LCD display, and terminals on the transceiver.

## **CHAPTER 2 INSTALLATION AND CONNECTION**

Explains installation and connection procedures for base stations and mobile operation.

## **CHAPTER 3 BASIC OPERATION**

Explains basic reception and transmission procedures. This chapter is especially useful for novice hams.

## **CHAPTER 4 ADVANCED FUNCTIONS**

Explains how to use diverse functions of this transceiver. You should master how to use these functions to make full use of the transceiver.

## **CHAPTER 5 SELECTIVE COMMUNICATION**

Explains how to communicate with a specific station using the tone squelch unit (EJ-24U). This chapter should be read only if your transceiver has the unit installed.

## **CHAPTER 6 MAINTENANCE**

Explains troubleshooting and cleaning.

## **APPENDICES**

Show the options and specifications. The appendices also give expert hams and dealers the following information:

- Packet Operation
- Channel Display Mode
- XBR (Crossband Repeater) Mode
- CLONING Mode
- SET Mode

1

2

3

4

5

6

APP

# Document Conventions

---

This manual uses the following icons.



Indicates a hazardous situation that, if not avoided, will result in death or serious injury.



Indicates a hazardous situation that, if not avoided, will result in serious damage to the unit.



Indicates an exception or note related to the procedure.



Provides helpful hints.



Indicates a reference page.



*Note: Names of products mentioned in this manual are used for identification purposes only and may be trade mark and/or registered trademarks of their respective company.*

**CHAPTER 1**

**GETTING STARTED**

**1.1 Unpacking**

The DR-605 package contains the items shown below. First, check that all the items are included. If any thing is missing or damaged, contact an authorized ALINCO dealer.

- DR-605 transceiver

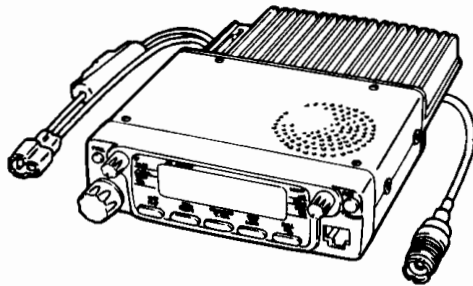

- Microphone



**⚠ Note:** *The DTMF microphone is optional for DR-605E.*

- Mobile mounting bracket

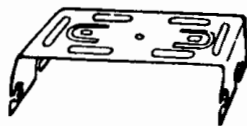

- DC power cable with fuses

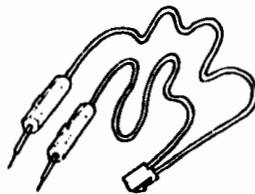

- Mobile mounting bracket screws

- Hexagon screws (M4 × 8 mm)



- Tapping screws (M5 × 20 mm)

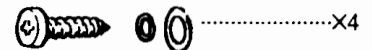

- Instruction manual (this manual)



- Hexagon screw spanner

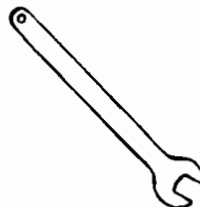

- Screws (M5 × 20 mm)

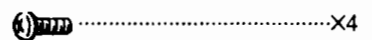

- Hexagon nuts (M5)

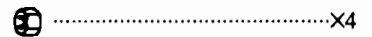

- Fuse (15 A)





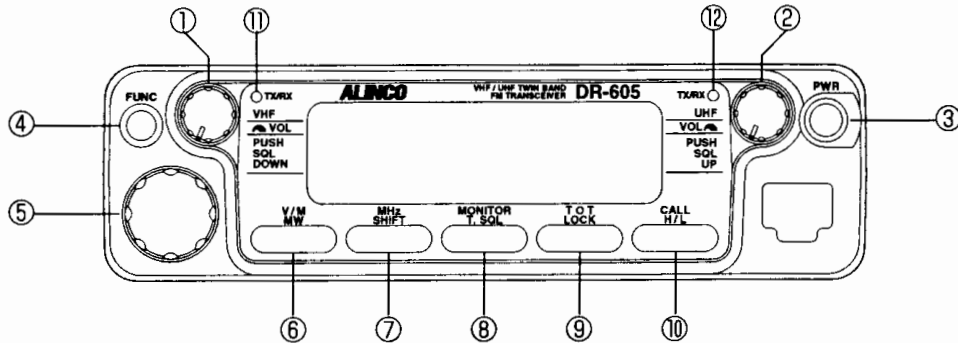

# 1.1 Keys, Terminals, and Display

## Front Panel



### Primary Functions

No.	Key	Function	Page
①	VHF	Press this knob to set the VHF band to the main band. Rotate the knob to adjust VHF band volum. When setting offset, press the knob to decrease offset in 1 MHz steps.	12, 27
②	UHF	Press this knob to set the UHF band to the main band. Rotate the knob to adjust the volume for the UHF band. When the offset is being set, press the knob to increase the offset in 1 MHz step.	12, 27
③	PWR	Turns the power on/off.	11
④	FUNC	Accesses the function mode.	—
⑤	Dial	Changes the frequency and memory channel number.	13, 16
⑥	V/M(MW)	Switches between the VFO mode and memory mode.	16
⑦	MHz(SHIFT)	Changes the frequency in 1 MHz steps.	13
⑧	MONITOR(T.SQL)	Unmutes the squelch.	31
⑨	TOT(LOCK)	Accesses the TOT setting mode.	24
⑩	CALL(H/L)	Recalls the CALL channel.	19

 **Note:** If no action is taken within five seconds after  appears, the function mode is canceled.

### LED

No.	LED	Function	Page
⑪	VHF TX/RX LED	Lights green when a signal is received on the VHF band. The LED lights red during transmission on the VHF band.	13, 14
⑫	UHF TX/RX LED	Lights green when a signal is received on the UHF band. The LED lights red during transmission on the UHF band.	13, 14

■ Secondary Functions (while **F** appears after the **FUNC** key is pressed)

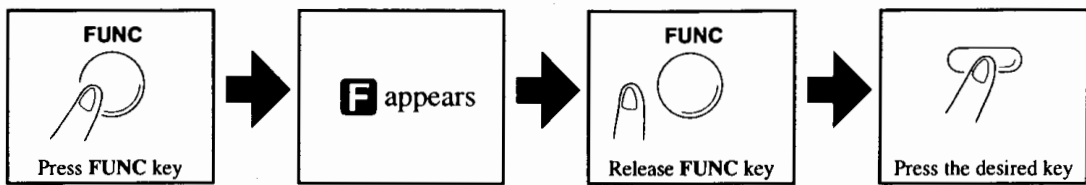

**⚠ Note:** If no action is taken within five seconds after **F** appears, the function mode is canceled.

No.	Key	Function	Page
①	VHF	Press this knob to select the squelch level on the main band. Then, each time the knob is pressed, the squelch level decreases.	11
②	UHF	Press this knob to select the squelch level on the main band. Then, each time the knob is pressed, the squelch level increases.	11
④	FUNC	Confirms your selection and exits the function mode.	—
⑤	Dial	Changes the memory channel.	17
⑥	V/M(M/W)	In the VFO mode, press this key to write data in the selected memory channel. In the memory mode, press the key to set specific channels not to be scanned during memory scanning.	17, 21
⑦	MHz(SHIFT)	Accesses the offset setting mode.	26
⑧	MONITOR(T.SQL)	Accesses the tone encoder and tone squelch setting modes.	23, 33
⑨	TOT(LOCK)	Locks the keys.	30
⑩	CALL(H/L)	Switches output power between high and low.	14

■ Secondary Functions (while the **FUNC** key is held down)

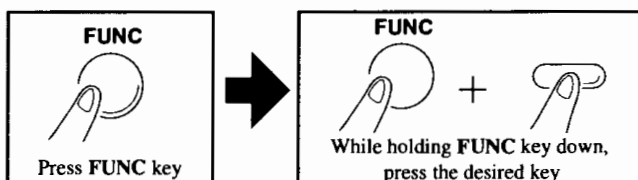

No.	Key	Function	Page
①	VHF	Accesses the 9600 bps packet mode.	41
②	UHF	Turns the beep function on/off.	31
⑤	Dial	Changes a memory channel in which you want to store crossband frequencies.	28
⑥	V/M(MW)	In the VFO mode, press this key to write the crossband frequencies in the selected memory channel. The main-band frequency is for reception, and the sub-band frequency is for transmission.	18, 28
⑦	MHz(SHIFT)	Accesses the channel step setting mode.	30
⑩	CALL(H/L)	Accesses the SET mode.	45

■ Functions when the Power is Turned on

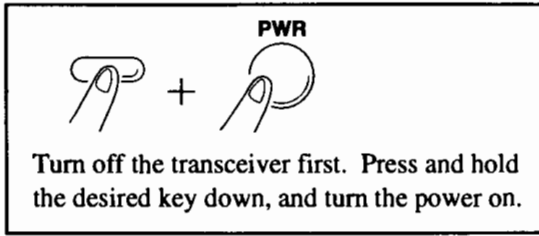

No.	Key	Function	Page
①	VHF	Accesses the crossband repeater mode.	43
②	UHF	Exits the crossband repeater mode.	43
④	FUNC	Resets all settings to their defaults.	32
⑥+①	V/M + VHF	Accesses the channel display mode.	42
⑥+⑧	V/M + MONITOR	Accesses the <b>CLONING</b> mode.	44
⑥+⑩	V/M + CALL	Exits the channel display mode.	42

# LCD Display

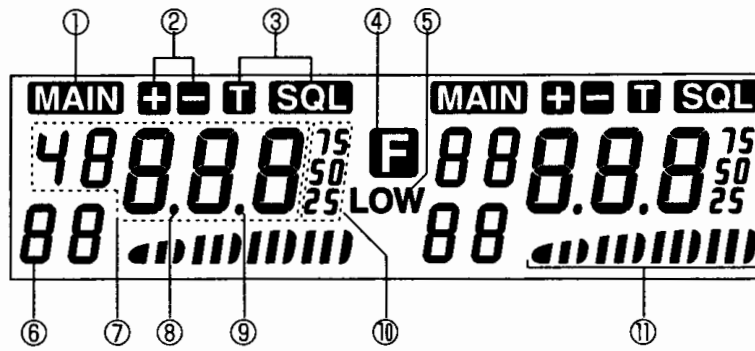

No.	Display	Function	Page
①	<b>MAIN</b>	Appears on the main band.	12
②	<b>+ -</b>	<b>-</b> appears when the minus offset is selected. <b>+</b> appears when the plus offset is selected. In the memory mode, <b>+ -</b> appears when a crossband memory channel has been recalled.	26, 28
③	<b>T SQL</b>	<b>T</b> appears when the tone encoder is activated. <b>T SQL</b> appears when the tone squelch unit is activated.	23, 33
④	<b>F</b>	Appears when the <b>FUNC</b> key is pressed. This icon disappears if no action is taken within five seconds after it appears.	—
⑤	<b>LOW</b>	Appears when the output power is set to low. This icon disappears when the output power is set to high.	14
⑥	<b>88</b>	Displays the selected memory channel number and squelch level. “ <b>[</b> ” is displayed when the <b>CALL</b> channel is selected. “ <b>L</b> ” is displayed when the <b>KEY LOCK</b> function is activated.	16, 19, 37
⑦	<b>88888</b>	Displays the selected transmission and reception frequencies.	—
⑧	Decimal point	Appears after the 1 MHz digit of the transmission, reception, and shift frequencies. The point flashes during scanning. The point disappears when a skipped memory channel has been selected.	20, 21, 22
⑨	Tone decimal point	Appears after the 1 Hz digit of the tone frequency. This point also appears after the 1 kHz digit when the channel step is being set. The point flashes only during busy mode scanning.	23, 30, 35
⑩	<b>75 50 25</b>	Indicates digits of the selected frequency below 1 kHz if they are not “00.”	—
⑪	<b>     </b>	Indicates relative received signal strength and relative output power level.	13, 14

## Rear Panel

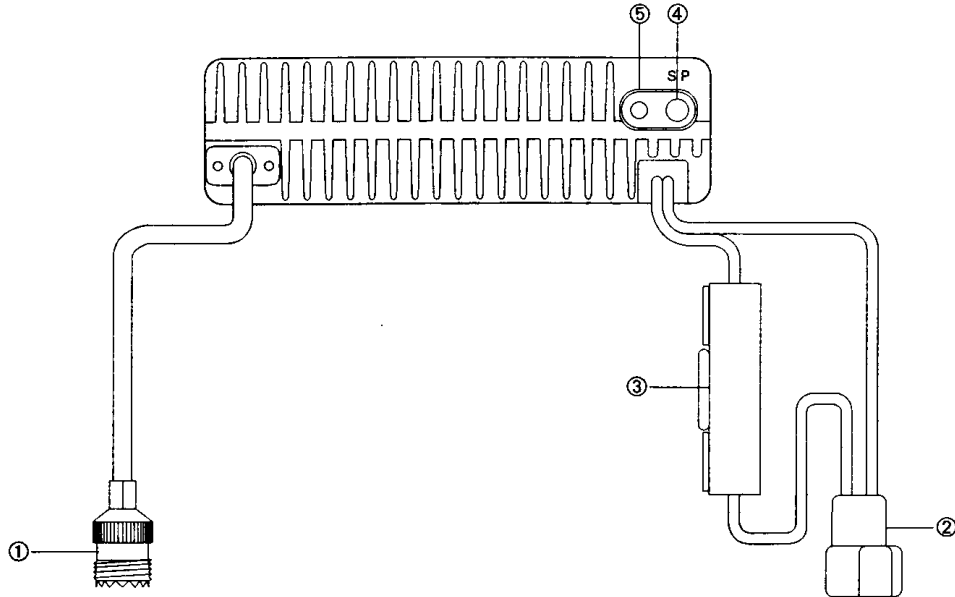

No.	Name	Function	Page
①	Antenna connector	Connects a 50 Ω dual band antenna.	7
②	Power connector	Connects the supplied power cable (Red to plus; black to minus).	8
③	Fuse case	Contains a fuse.	38
④	SP jack	Connects a commercially-available external speaker. This jack is a PTT input for 9600 bps packet operation, and a data IN/OUT for cloning.	8,40,41
⑤	Data input jack	Transmission data IN/OUT for 9600 bps packet operation.	41

## Microphone

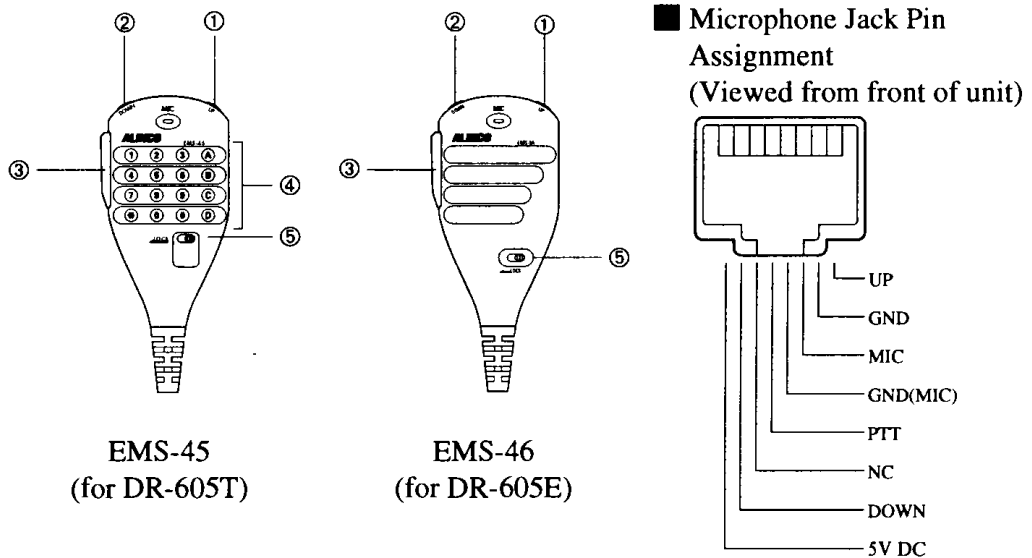

No.	Key	Function
①	UP key	Increases the frequency, memory channel number, and setting value.
②	DOWN key	Decreases the frequency, memory channel number, and setting value.
③	PTT key	Push to transmit, and release to receive on the main band. Also press this key to confirm your selection.
④	DTMF keys	Press the keys to send the desired DTMF code, which must be sent prior to your voice signal when contacting a specific station.
⑤	UP/DOWN lockout switch	Locks out the UP and DOWN keys.

## CHAPTER 2

## INSTALLATION AND CONNECTION

**2.1 Installation and Connection for Base Station**

Follow the procedures below for correct installation and connection.

**Connecting the Microphone**

Connect the microphone modular plug provided with the unit into the microphone jack. Insert the plug until hearing a click.

 **Note:** When connecting, take care to the modular plug direction.

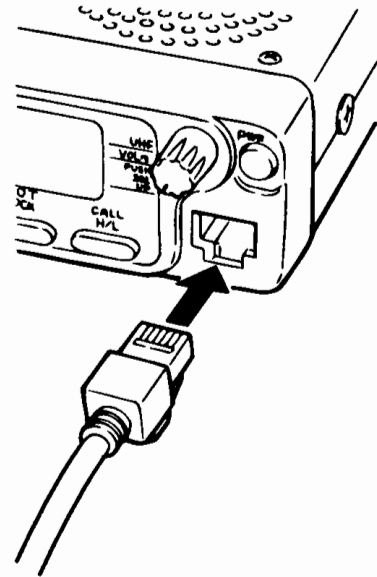
**Connecting an Antenna**

1. Connect the UHF plug of the coaxial cable of the antenna to the connector coming from the rear panel.
2. Tighten the ring screw of the connector.

**About the Antenna**

Use a 145/440 MHz dual band antenna.

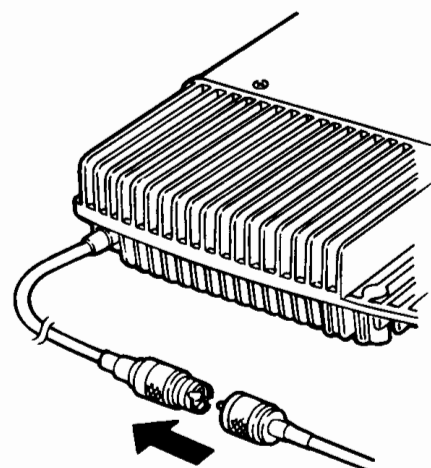

 **Note:** The transceiver has 50  $\Omega$  output impedance. Any mismatch among the impedances of the antenna, coaxial cable, and transceiver may decrease the output power and affect other electronic appliances such as televisions.

## Connecting the Power Supply

**Warning:** Before connecting a power supply, be sure to turn it and the transceiver off.

Connect the DC power cable provided with the unit to a 13.8 V DC regulated power supply.

- Connect the red lead to the plus terminal and the black lead to the minus terminal of the power supply.

**Caution:** Be sure to use the DC cable provided with the unit for this connection.

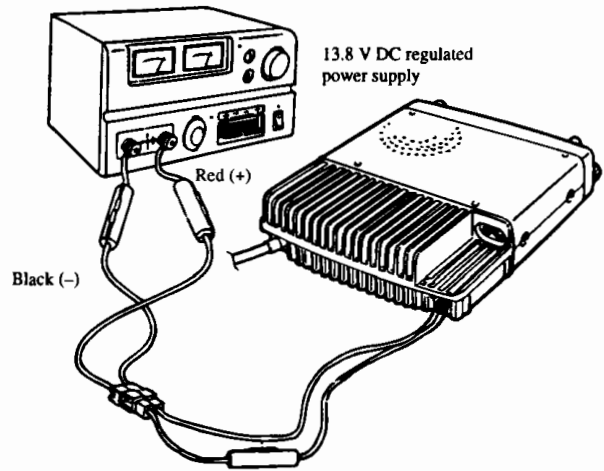

**Tip:** It is recommended to use a regulated power supply with current capacity of continuously 12 A or more.

## Connecting an External Speaker

When a commercially-available external speaker is connected to the speaker (8  $\Omega$ ) terminal on the rear panel, you can hear voice on both VHF and UHF bands from the speaker.

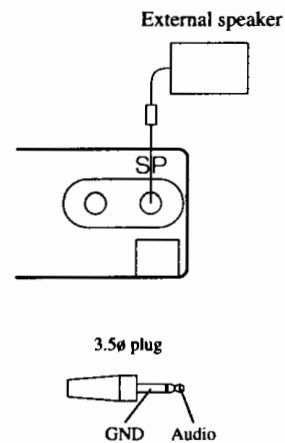

## 2.2 Installation and Connection for Mobile Use

For mobile use, safe driving comes first before transceiver operation. Follow the procedures below for correct installation and connection.

### Installation Place

Choose a place where the controls and microphone are easily accessible and allows you to safely drive.

Avoid places where:

- Your knees contact the transceiver frequently.
- The transceiver vibrates.
- The transceiver becomes hot, such as near the car heater outlet.

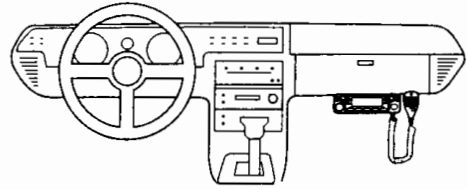

### Connecting the Microphone

Connect the microphone to the transceiver.

 For details, see page 7.

### Connecting the Power Supply

1. Connect the power cable provided with the unit directly to the 12 V car battery.
  - Connect the red lead to the plus terminal and the black lead to the minus terminal of the car battery.



**Warning:** When connecting, last connect the black lead to the minus terminal to prevent short circuit.

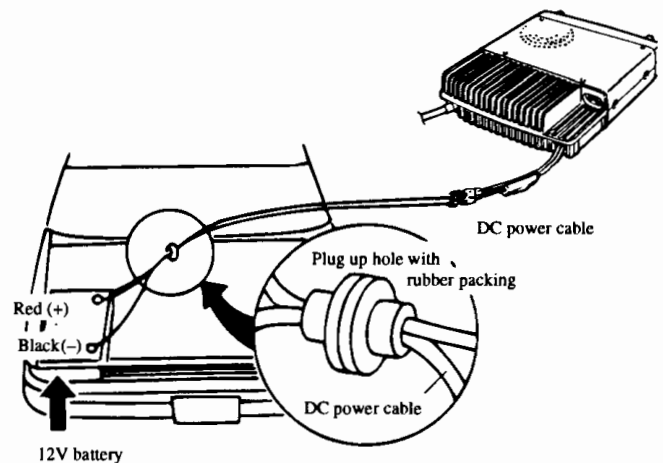

2. Secure the cable in a cool, dry place.



**Note:** If threading the cable through a wiring hole, plug up the hole with rubber packing.



**Caution:**

- If using a 24 V car battery, be sure to convert the voltage to 12 V DC with a DC/DC converter.
- Do not connect the power cable to a cigarette lighter connector because the power supply is unstable.



## Installing the Transceiver

Follow the procedure below to install the transceiver, for example, under the glove box.

1. Attach the mounting bracket to the glove box with the washers (× 4) and tapping screws (× 4) provided with the unit.
2. Loosely attach the hexagon screws (× 4) to the transceiver.
3. Let hexagon screw ① go through the rear notch of the bracket by sliding the transceiver upwards.
4. Let hexagon screw ② go through one of three front notches of the bracket to make the transceiver the most accessible. Slide the transceiver forwards and secure it. Then tighten the hexagon screws.

For making 4  $\pm 0.2$  mm  $\varnothing$  holes in glove box bottom

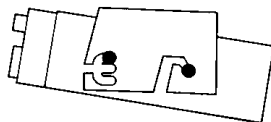
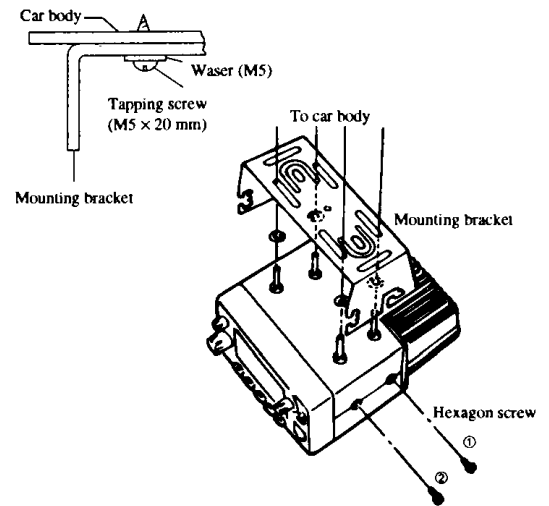

## Attaching a Mobile Antenna

1. Securely attach a commercially-available antenna on the car roof using an antenna base.
2. Connect the coaxial cable of the antenna to the transceiver.

⇒ For details on antenna connections, see page 7.

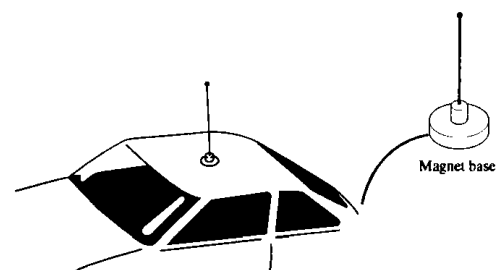
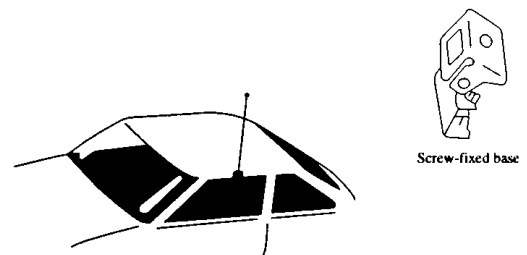

**CHAPTER 3**

**BASIC OPERATION**

**3.1 Reception**

This section describes the basic reception procedure.

**Turning the Power on**

Press the **PWR** switch.

- Press this switch again to turn the power off.

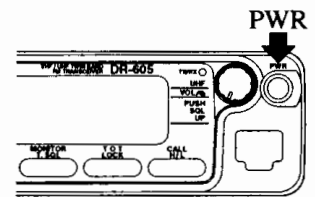

**Adjusting the Volume**

VHF: Rotate the **VHF** knob.

UHF: Rotate the **UHF** knob.

- Clockwise rotation increases the volume.
- Counterclockwise rotation decreases the volume.

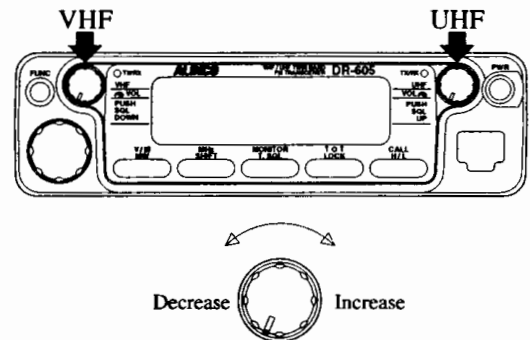

**Adjusting Squelch**

1. Press the **FUNC** key and while **F** is displayed, press the **VHF** or **UHF** knob to set the squelch level (0 to 9). During setting, **SQL** flashes.

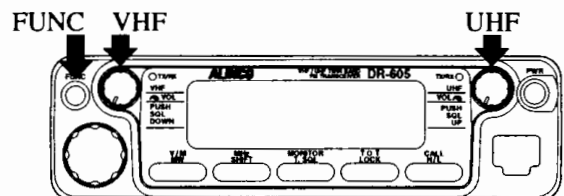

- The setting level is displayed on the LCD. (The default is "3.")



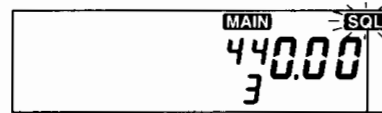

On VHF band

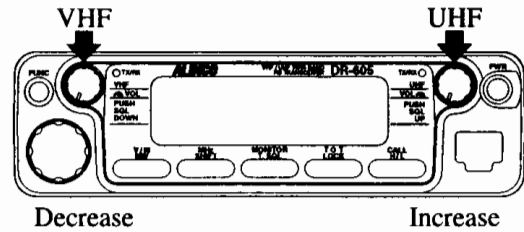

On UHF band

2. Select the squelch level at which the noise just disappears.
  - Press the **UHF** knob to increase the squelch level.
  - Press the **VHF** knob to decrease the squelch level.



 *Note: If the squelch level is too high, you cannot hear weak signals.*

3. Press the **FUNC**, **V/M**, or microphone **PTT** key to confirm your selection.
  - The squelch level indication disappears and the selected squelch level is confirmed.

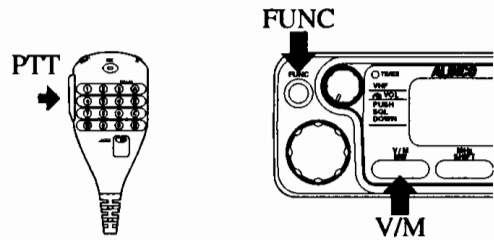

 *Note: If no action is taken within five seconds at this time, the selected level is also confirmed.*

## Selecting the Main Band

Press the **VHF** knob to set the VHF band to the main band.  
 Press the **UHF** knob to set the UHF band to the main band.

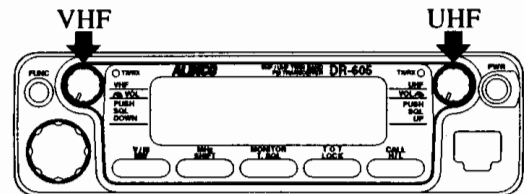

- **MAIN** appears on the main band.



VHF band is main band

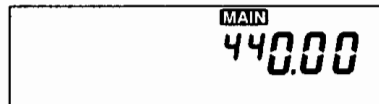

UHF band is main band

## Setting Frequency

Rotate the Dial or press the microphone UP/DOWN key.

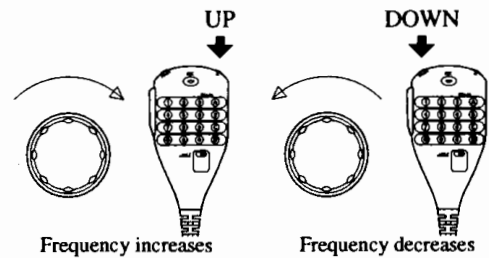

- When a signal is received, the TX/RX LED on the received band lights green. The signal strength is indicated by the S-meter.



 *Tip: Press and hold the UP/DOWN key down to scroll the frequency continuously. Hold either key down for anywhere between one and two seconds to start scanning. (For details on scanning, see page 20.)*

### ■ Changing the Frequency in 1 MHz Steps

1. Press the MHz key.
  - Digits below 1 MHz disappear on the LCD.

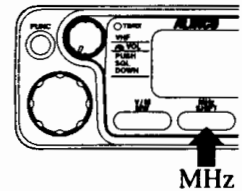

2. Rotate the Dial or press the microphone UP/DOWN key.
  - The frequency changes in 1 MHz steps.

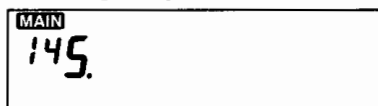

3. To confirm the changed frequency, press the V/M, MHz, or FUNC key.
  - Digits below 1 MHz reappear.

 *Note: If no action is taken within five seconds after the MHz key is first pressed, the changed frequency is confirmed just the same and digits below 1 MHz reappear.*

## 3.2 Transmission

This section describes the basic transmission procedure. If transmitting on the same band and frequency as reception, start with "Selecting the Output Power."

### Selecting the Main Band

Press the VHF or UHF knob to select the main band.

⇒ For selecting the main band, see page 12.

### Setting Frequency

Set the desired transmission frequency.

⇒ For setting the frequency, see page 13.

### Selecting the Output Power

Press the FUNC key and while **F** is displayed, press the CALL(H/L) key to select the output power. This switches the output power between high and low.

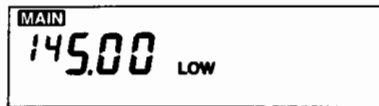
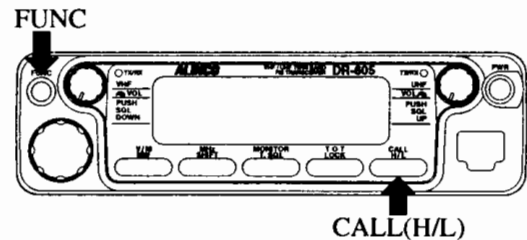

LOW appears when low power is selected



LOW disappears when high power is selected

- ⚠ Notes:
- Output power can be changed even during transmission.
  - Output power cannot be set separately for the VHF and UHF bands.

Output power settings

Model \ Setting	High		Low	
	VHF	UHF	VHF	UHF
605T	50 W	35 W	Approx. 5 W	Approx. 5 W
605E	50 W	35W	Approx. 5 W	Approx. 5 W

### Transmitting

1. Press the microphone PTT key and speak into the microphone
  - The TX/RX LED on the main band lights red.
  - During transmission, output power is indicated on the RF meter (S-meter).
2. Release the PTT key to return to reception.

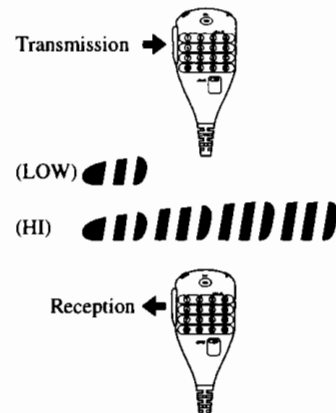

## 3.3 Operation Modes

The transceiver has three operation modes.

### VFO Mode

In the VFO mode, you can easily change the frequency with the Dial or microphone UP/DOWN key.

#### ■ Accessing the VFO Mode from Other Modes

Press the V/M key.

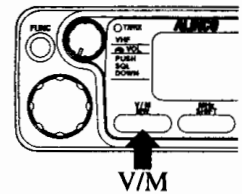
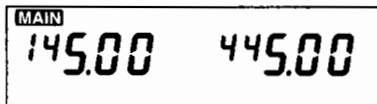

**⚠ Note:** In the CALL mode, pressing the V/M key may access the memory mode. In this case, press the V/M key again to access the VFO mode.

### Memory Mode

In the memory mode, you can recall frequencies and settings preprogrammed in memory channels. Rotating the Dial or pressing the microphone UP/DOWN key changes the memory channel number.

#### ■ Accessing the Memory Mode from Other Modes

Press the V/M key.

- The last-accessed memory channel number and settings are displayed.

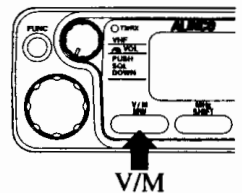
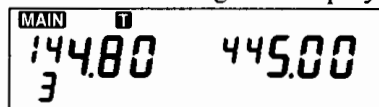

**⚠ Note:** In the CALL mode, pressing the V/M key may access the VFO mode. In this case, press the V/M key again to access the memory mode.

➡ For details on how to use the memory channels, see page 16.

### CALL mode

In the CALL mode, you can recall the CALL channel and wait for calls from other stations.

#### ■ Accessing the CALL mode from Other Modes

Press the CALL key.

- "C" is displayed.

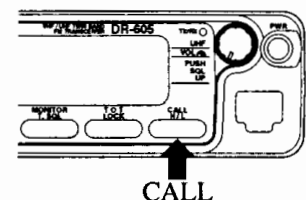
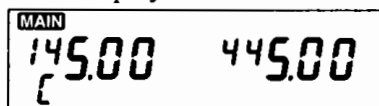

➡ For details on the CALL channel, see page 19.

# CHAPTER 4

# ADVANCED FUNCTIONS

## 4.1 Memory Channel

This transceiver has 50 memory channels and a **CALL** channel for each the VHF and UHF bands. Memory channels are useful for storing often-used frequencies and settings for easy recall.

### Storable Data

Memory channels can store the following information:

- Reception and transmission frequencies
- Channel step
- Offset direction
- Offset frequency
- Tone encoder/decoder on/off
- Tone encoder/decoder frequency

### Recalling Memory Channels

#### 1 Selecting the Main Band

Press the **VHF** or **UHF** knob to set the desired band to the main band.

- **MAIN** appears on the main band.

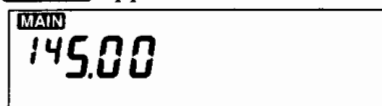

#### 2 Accessing the Memory Mode

Press the **V/M** key.

- The last-accessed memory channel is displayed.

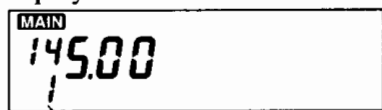

Memory channel.No.

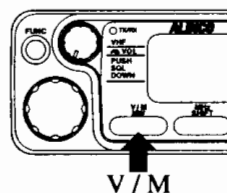

#### 3 Selecting Memory Channel Numbers

Rotate the Dial or press the microphone **UP/DOWN** key.

- Memory channels are displayed in this order.

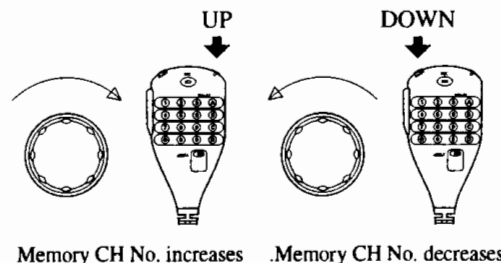
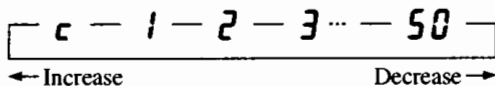

*Note: The LCD displays only the numbers of preprogrammed memory channels.*

## Programming Memory Channels

### 1 Selecting the Main Band

Press the **VHF** or **UHF** knob to set the desired band to the main band.

### 2 Setting a Frequency

In the VFO mode, set the desired frequency and other settings.

### 3 Selecting Memory Channels to Program

- Press the **FUNC** key.
  - F** and the last-accessed memory channel number are displayed. The transceiver still remains in the VFO mode.

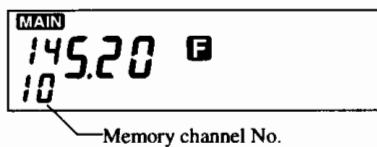
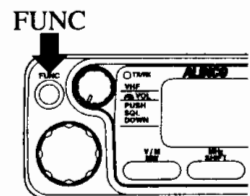

- Rotate the Dial or press the microphone **UP/DOWN** key to select the desired memory channel.
  - You can select any memory channel including unprogrammed channels.

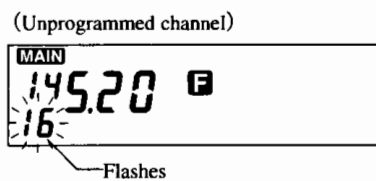
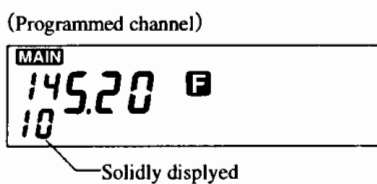
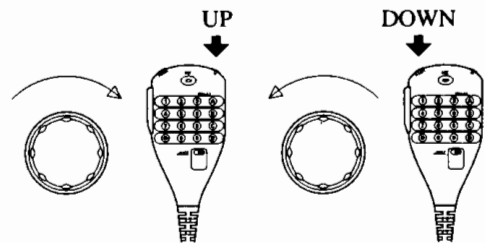

### 4 Storing Data in Memory Channels

- While **F** is displayed, press the **V/M** key.
- F** and the memory channel number disappears and the current VFO frequency and settings are written in the selected memory channel.

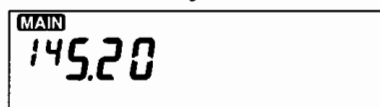
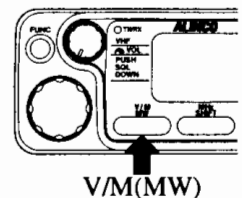



## Erasing Memory Channels

### 1 Selecting Memory Channels to Erase

In the memory mode, select the memory channel you want to erase.



*Note: The CALL channel cannot be erased.*



*For details on how to select channels, see page 16.*

### 2 Erasing Data from Memory channels

While holding the **FUNC** key down, press the **V/M** key.

- The memory channel number flashes and the data in the memory channel is erased.

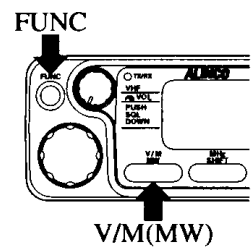

*Tip: At this time, to recover the memory channel, press and hold the **FUNC** key down and press the **V/M** key. If you change the memory channel number after erasing, however, the data cannot be recovered.*

## 4.2 CALL Channel

The **CALL** channel stores the call frequencies for the VHF and UHF band respectively. This channel can be easily recalled only by pressing the **CALL** key. The **CALL** channel can also be programmed in the same manner as regular memory channels; this is useful for quick and easy recall of the most-frequently-used frequencies and settings.

### Recalling the CALL Channel

Press the **CALL** key.

- "C" is displayed and the transceiver enters the **CALL** mode.

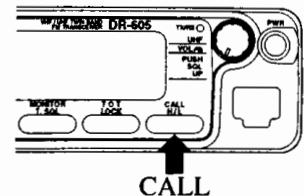
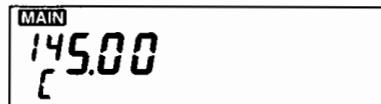

- To return to the VFO or memory mode, press the **CALL** key again.

### CALL Channel Default Settings

	DR-605T	DR-605E
VHF	145.000 MHz	145.000 MHz
UHF	445.000 MHz	435.000 MHz

### Changing the CALL Channel Frequency

**⚠ Note:** You cannot change the **CALL** channel frequency from the **CALL** mode. Before attempting to do so, be sure to access the **VFO** mode.

1. Set a new call frequency in the VFO mode.
2. After pressing the **FUNC** key, rotate the Dial or press the microphone **UP/DOWN** key until "c" appears.

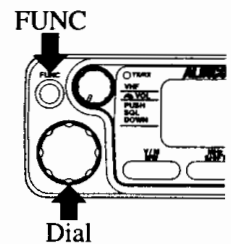
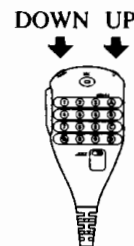
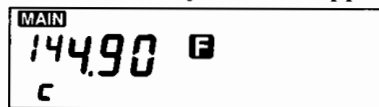

3. While **F** is displayed, press the **V/M(MW)** key.
  - **F** disappears and the new frequency is stored in the **CALL** channel.

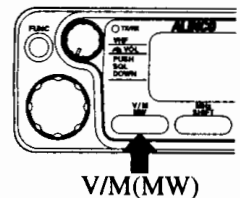

4. Press the **CALL** key and the new frequency is displayed.

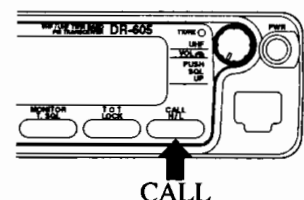
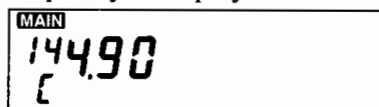

## 4.3 Scanning

Scanning is used to automatically search for signals over a frequency range or among programmed memory channels. Scanning pauses while a signal is being received and resumes according to the set resume condition.

There are three types of scanning.

- Band scanning
- Memory scanning
- Tone scanning

⇒ For details on tone scanning, see page 35.

There are two scanning resume conditions.

- Timer mode.....Scanning resumes five seconds after pausing, or when the signal disappears for two seconds or more. During scanning, the decimal point after the 1 MHz digit flashes.
- Busy mode .....Scanning pauses while a signal is being received, and resumes 2 seconds after the signal disappears. During scanning, the decimal points after the 1 MHz and 100 kHz digits flash.

⇒ For details on how to set the scanning resume condition, see page 46.

### Band Scanning

Band scanning searches the entire range of frequencies in the main band. Scanning proceeds in the set channel step.

#### 1 Starting Scanning

In the VFO mode, hold the microphone UP/DOWN key down for anywhere between one and two seconds.

- The decimal point flashes and scanning proceeds in the direction of the key pressed (upwards or downwards).

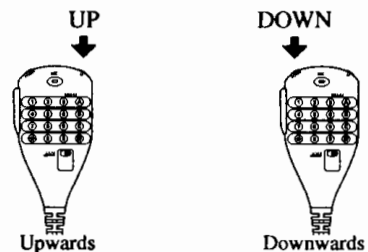

- Tip:**
- During scanning, you can change the scanning direction using the Dial or the microphone UP/DOWN key.
  - When paused, you can resume scanning using the Dial or the microphone UP/DOWN key.
  - During busy mode scanning, the tone decimal point also flashes.

- Notes:**
- Upwards scanning proceeds to the upper limit of the band and then returns to the lower limit of the band.
  - Downwards scanning proceeds to the lower limit of the band and then returns to the upper limit of the band.
  - If the power is turned off during scanning, scanning is canceled next time the power is turned on.

#### 2 Stopping Scanning

Press the FUNC, V/M, or the microphone PTT key.

- The decimal point appears solidly and the scanning stops.

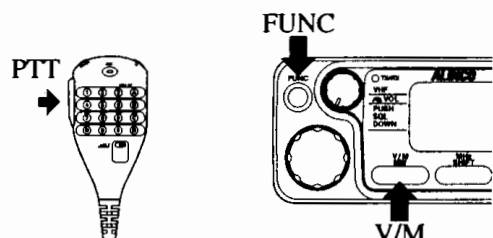
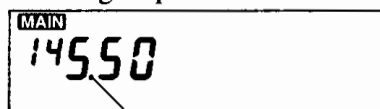

## Memory Scanning

Memory scanning searches for signals in preprogrammed memory channels.

### 1 Starting Scanning

In the memory mode, hold the microphone UP/DOWN key down for anywhere between one and two seconds.

- The decimal point flashes and scanning proceeds in the direction of the key pressed (upwards or downwards).

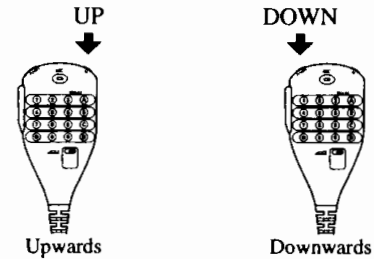

- Tip:*
- During scanning, you can change the scanning direction using the Dial or the microphone UP/DOWN key.
  - When paused, you can resume scanning using the Dial or the microphone UP/DOWN key.
  - During busy mode scanning, the tone decimal point also flashes.



- Notes:*
- The CALL channel is not scanned.
  - Upwards scanning proceeds to the highest number of programmed memory channels and then returns to the lowest number of them.
  - Downwards scanning proceeds to the lowest number of programmed memory channels and then returns to the highest number of them.
  - If the power is turned off during scanning, the scanning is canceled next time the power is turned on.

### 2 Stopping Scanning

Press the V/M, FUNC, or the microphone PTT key.

- The decimal point appears solidly and the scanning stops.

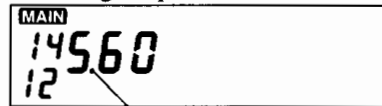

Solidly displayed

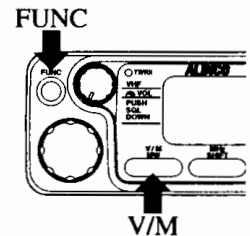
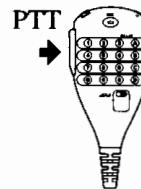

### Setting Non-scanning Channels (Skip Channels)

You can set specific memory channels not to be scanned during memory scanning.

1. In the memory mode, select the memory channel you want skipped.

⇒ For details on how to select a memory channel, see page 16.

2. Press the FUNC key and while F is displayed, press the V/M key.

- The decimal point disappears.

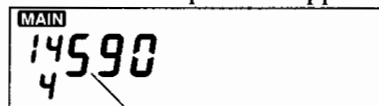

Disappears

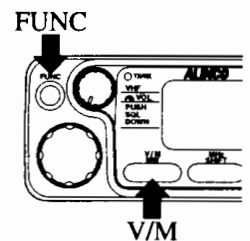

3. To cancel a skip channel, select the channel and repeat the operation in step 2.

- The decimal point appears, meaning the channel is scanned.

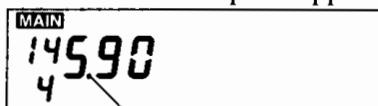

Appears

## Operation during Scanning

### ■ Switching the Band during Scanning

- If the **UHF** knob is pressed while scanning the VHF band, scanning continues and the UHF band is set to the main band.
- If the **VHF** knob is pressed while scanning the UHF band, scanning continues and the VHF band is set to the main band.
- In either cases of the above:
  - Pressing the **PTT** key lets you transmit on the main band.
  - Holding the microphone **UP/DOWN** key down on the new band for anywhere between one and two seconds lets you to scan on both bands.



- Notes:*
- *During transmission, scanning pauses on the sub band. When the transmission is stopped, scanning resumes.*
  - *While scanning sub band, you cannot program or erase memory channels, activate the reverse function, and access the SET mode on the main band.*

# 4.4 Other Useful Functions

This transceiver has various useful functions other than as prementioned. Effective use of these functions allows you to get more out of your transceiver.

## Tone Encoder and Tone Frequency

When the CTCSS tone encoder (comes standard with DR-605) is enabled, a subaudible tone is superimposed over your transmission signal.

*Tip: If your transceiver has the optional tone squelch unit (EJ-24U) installed, tone decoding is possible. (See page 33.)*

### 1 Accessing the Tone Encoder Mode

Press the **FUNC** key and while the **F** is displayed, press the **MONITOR(T.SQL)** key.

- **T** and the current tone frequency appear. (The default is 88.5 Hz.)

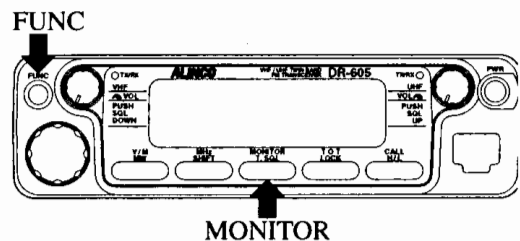
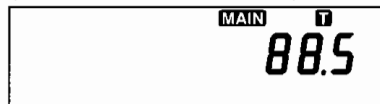

### 2 Setting Tone Frequency

While the tone frequency is displayed, rotate the Dial or press the microphone **UP/DOWN** key to select one of 50 tone frequencies.

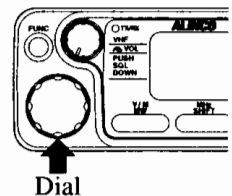
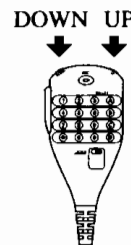

• Table of available tone frequencies (Unit: Hz)

67.0	69.3	71.9	74.4	77.0	79.7	82.5	85.4	88.5
91.5	94.8	97.4	100.0	103.5	107.2	110.9	114.8	118.8
123.0	127.3	131.8	136.5	141.3	146.2	151.4	156.7	159.8
162.2	165.5	167.9	171.3	173.8	177.3	179.9	183.5	186.2
189.9	192.8	196.6	199.5	203.5	206.5	210.7	218.1	225.7
229.1	233.6	241.8	250.3	254.1				

### 3 Confirming Tone Frequency

Press the **FUNC**, **V/M**, or microphone **PTT** key.

- With **T** still displayed, the LCD returns to the reception frequency display.

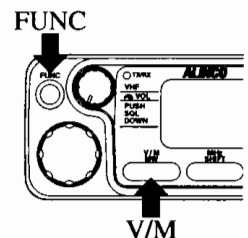
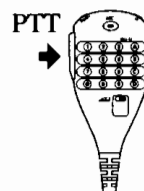
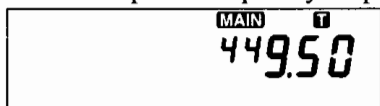

**Note:** If no action is taken within five seconds of making the setting, the current tone frequency is confirmed just the same.

- To cancel the tone setting, press the **FUNC** key and while **F** is displayed, press the **MONITOR(T.SQL)** key. **T** disappears and the tone setting is canceled. When the optional tone squelch unit is installed, repeat this operation until **T** disappears.

## TOT (Time-Out Timer) Function

The TOT function automatically stops transmission after the set time-out time. The transceiver beeps five seconds before transmission stops, and beeps again when transmission stops. If the TOT penalty time is set, transmission is inhibited for the set period of time after the time-out-timer expires. If not set, transmission resumes immediately after the timer expires.

This function prevents accidental prolonged transmission which could interfere with other stations and overheat the transceiver.

### Setting Time-out Time

1. Press the TOT key.
  - "t" and the current time-out time are displayed.

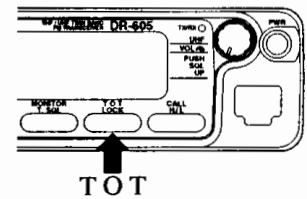
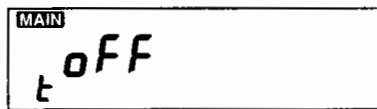

2. Rotate the Dial or press the microphone UP/DOWN key to select the desired time-out time.
  - Each click of the Dial or UP/DOWN key changes the time in 30 seconds increments. The time-out time is selectable from 0 to 450 seconds. (The default is "oFF".)

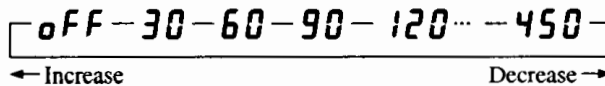
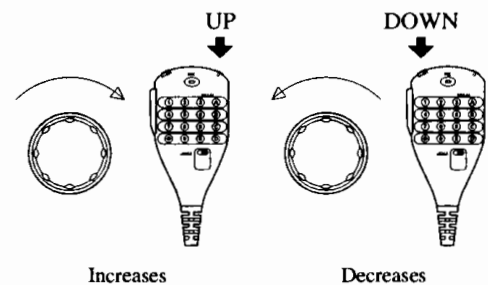

3. Press the FUNC, V/M, or microphone PTT key.
  - The selected time-out time is confirmed and you exit the TOT setting mode.
  - To access the TOT penalty time setting mode, press the TOT key instead of the above keys.

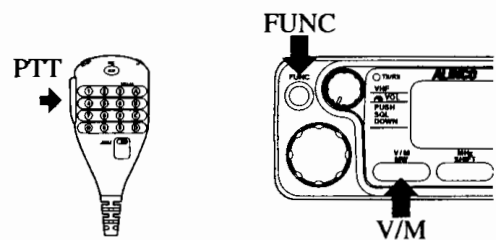

**Note:** If no action is taken within five seconds of making the setting, the selected time-out time is confirmed just the same and you exit the TOT setting mode.

4

## ■ Setting TOT Penalty Time

- In the time-out time setting mode, press the **TOT** key.
  - "P" and the current **TOT** penalty time are displayed. (The default is 0.)

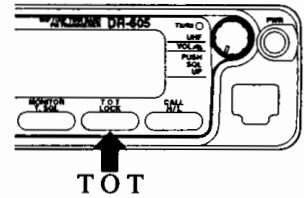

- Rotate the Dial or microphone **UP/DOWN** key to select the desired **TOT** penalty time.
  - Each click of the Dial or **UP/DOWN** key changes the time in one second increments. The penalty time is selectable from 0 to 15 seconds.

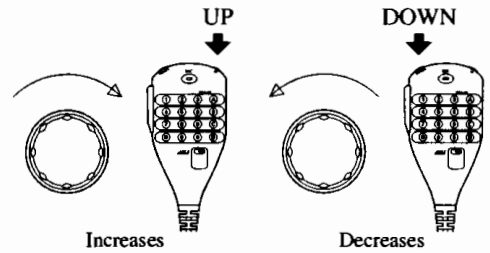
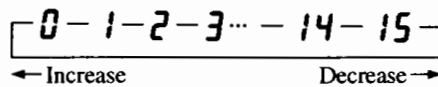

- Press the **FUNC**, **V/M**, or microphone **PTT** key.
  - The selected penalty time is confirmed and you exit the **TOT** setting mode.
  - To return to the time-out time setting mode, press the **TOT** key instead of the above keys.

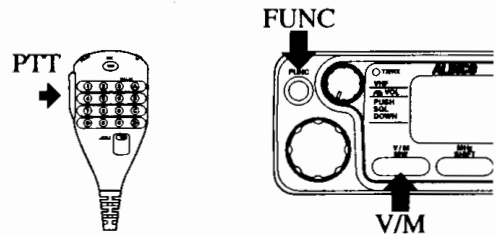

 **Note:** If no action is taken within five seconds of making the setting, the selected penalty time is confirmed just the same and you exit this setting mode.



## Split Function

### ■ Offset Direction and Frequency

It is possible to shift the transmission frequency in either the plus (+) or minus (-) direction with respect to the reception frequency.

- Minus direction ..... Transmitting at the reception frequency minus the offset frequency.
- Plus direction ..... Transmitting at the reception frequency plus the offset frequency.

- In the VFO mode, press the **FUNC** key and while F is displayed, press the **MHz(SHIFT)** key.
  - The offset and transmission frequencies appear alternately.

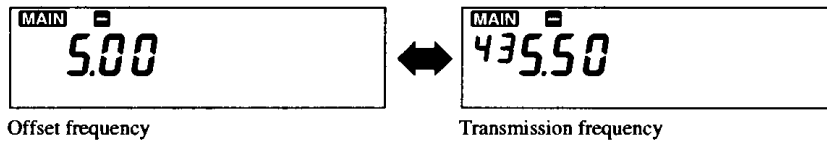
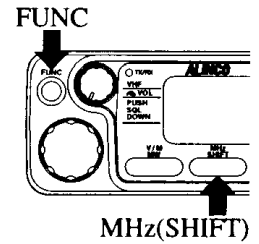

**Note:** If an offset frequency results in an out-of-band transmission, pressing the PTT key displays "oFF," meaning the transmission is not possible.

- Press the **MHz** key to select the offset direction between plus and minus.
  - Each time the key is pressed, the offset direction changes like this.

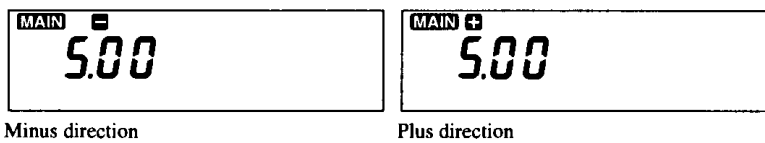
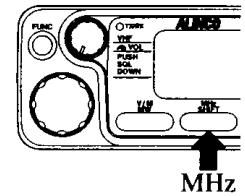

4

- 3.** Change the offset frequency.
- To change the frequency in the set channel step  
Rotate the Dial or press the microphone **UP/DOWN** key.

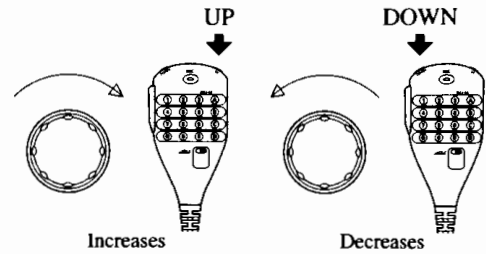

*Tip: If the UP/DOWN key is held down for one or more seconds, the offset frequency changes continuously in the set channel step.*

- To change the frequency in 1 MHz steps  
Press the **VHF** knob to decrease the frequency; press the **UHF** knob to increase it.

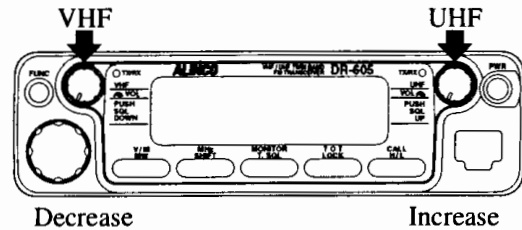

*Tip: If the VHF or UHF knob is held down for one or more seconds, the offset frequency changes continuously in 1 MHz steps.*

- 4.** Press the **FUNC**, **V/M**, or microphone **PTT** key to confirm the offset frequency.
- After confirmation, the reception frequency is displayed.

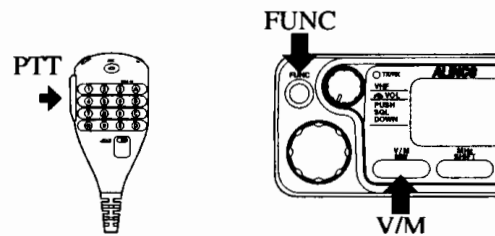
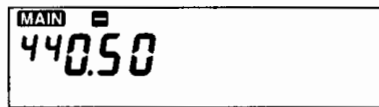

**⚠ Note:** If no action is taken within five seconds of making the setting, the current offset frequency is confirmed just the same.

- 5.** Press the **PTT** key to transmit.
- Minus direction.....Transmitting at the reception frequency minus the offset frequency.
  - Plus direction .....Transmitting at the reception frequency plus the offset frequency.

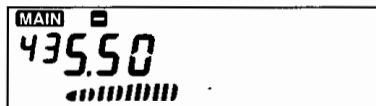

Minus direction



Plus direction

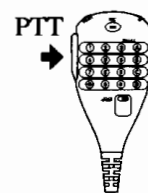

**⚠ Note:** If an offset frequency results in an out-of-band transmission, pressing the **PTT** key displays "oFF," showing the transmission is not possible.

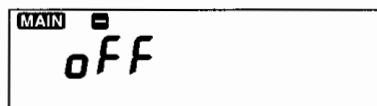

4

## ■ Crossband Transmission

Crossband transmission is possible when the main-band frequency is programmed for reception and the sub-band frequency is programmed for transmission.

Follow the steps below for crossband transmission.

**1.** In the VFO mode, set a reception frequency on the main band and a transmission frequency on the sub band.

**2. a)** If writing in the last-accessed memory channel  
While holding the **FUNC** key down, press the **V/M** key.

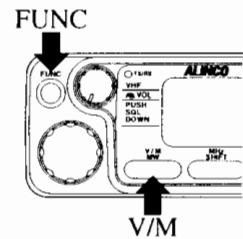

**b)** If writing in the selected memory channel  
While holding the **FUNC** down, rotate the Dial or press the microphone **UP/DOWN** key to select the desired channel. Continue holding the **FUNC** key down and press the **V/M** key.

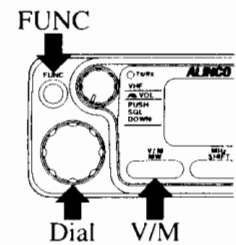
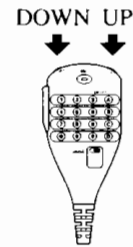



- The memory channel number and **F** disappear, meaning the main-band frequency is programmed for reception and the sub-band frequency is programmed for transmission in the selected memory channel.

 **Note:** Even if an offset frequency is set on the sub-band, the displayed sub-band frequency is programmed for transmission.

**3.** Access the memory mode and recall the crossband memory channel.

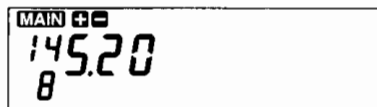
- + -** appears.



 For details on how to recall a memory channel, see page 16.

**4.** Press the microphone **PTT** key to transmit.

- Transmission takes place at the programmed frequency.

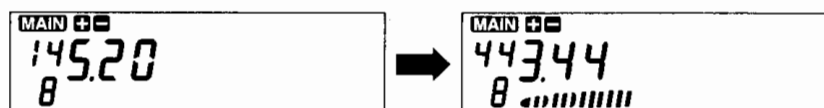
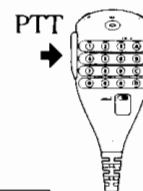

## Reverse Function

The reverse function exchanges the transmission and reception frequencies when offset frequency and direction are set or when a crossband memory channel is selected.

1. a) When offset frequency and direction are set (⊖ or ⊕ is displayed):

Press the **MONITOR** key.

- ⊕ (for minus offset) or ⊖ (for plus offset) flashes. The transmission and reception frequencies are exchanged and the offset direction is reversed.

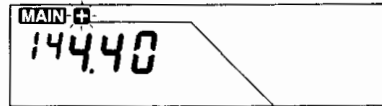

For minus offset

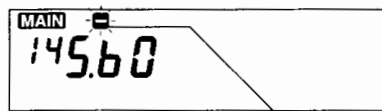

For plus offset

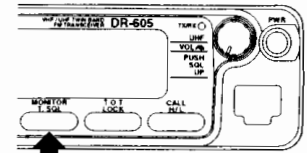

MONITOR

- b) When a crossband memory channel is selected (⊕⊖ is displayed):

Press the **MONITOR** key.

- The transmission and reception frequencies are exchanged.

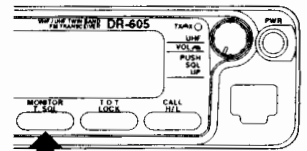

MONITOR



*Note: When the reverse function results in an out-of-band frequency, "oFF" is displayed.*

2. Press any key to return to the previous display.

## Channel Step Selection

- In the VFO mode, hold the **FUNC** key down and press the **MHz** key.
  - The current channel step is displayed.

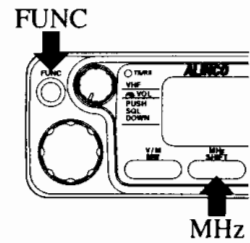
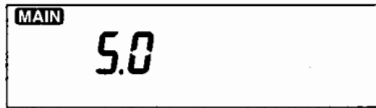

- Rotate the Dial or press the microphone **UP/DOWN** key to select the channel step.
  - The channel step changes like this.

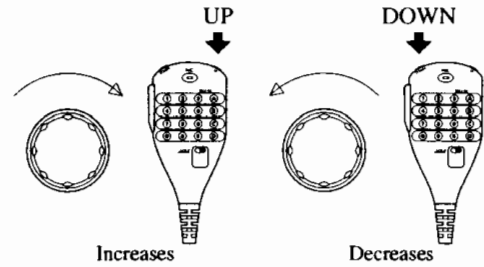

- The channel step changes like this.

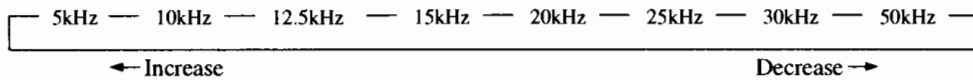

- Press the **FUNC**, **V/M**, or microphone **PTT** key.
  - The selected channel step is confirmed.

**Note:** If no action is taken within five seconds of making the setting, the selected channel step is canceled.

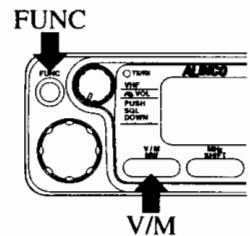
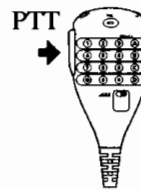

4

## KEY LOCK function

This function locks keys to prevent accidental changes in frequencies and settings.

- Note:** While this function is activated, these keys are still active.
- FUNC**
  - PTT**
  - UP/DOWN**
  - FUNC + VHF/UHF** (Sets the squelch level.)
  - FUNC + TOT(LOCK)** (Cancels the **KEY LOCK** function.)

- Press the **FUNC** key and while **F** is displayed, press the **TOT(LOCK)** key.
  - "L" appears, meaning the **KEY LOCK** function is activated.

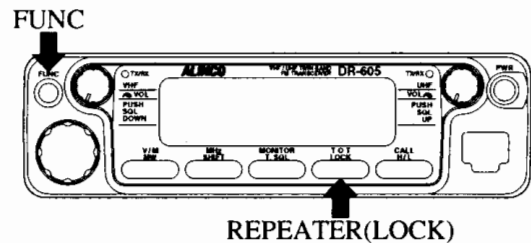
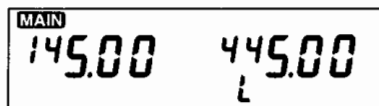

- To cancel the **KEY LOCK** function, press the **FUNC** key again and while **F** is displayed, press the **TOT(LOCK)** key.
  - "L" disappears, meaning the **KEY LOCK** function is canceled.

- Notes:**
- Turning the power off does not cancel the **KEY LOCK** function.
  - Accessing the **XBR** or channel display mode cancels the **KEY LOCK** function.

## MONITOR Function

In mobile operation, a received signal may be interrupted by tunnels while driving. This function unmutes the squelch to receive very weak signals. With the function, you can listen to voice more clearly under bad reception conditions.

1. While **+** and/or **-** are not displayed, press the **MONITOR** key.
  - The TX/RX LED lights green and squelch is unmuted.

 *Tip: This function is also activated even if the tone squelch is enabled.*

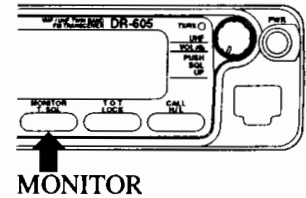

2. Press any key to cancel the **MONITOR** function.

 *Note: If you set either the offset frequency and direction or crossband frequencies, the reverse function is activated. (See page 29.)*

## Beep On/Off Setting

The beep function can be turned on and off.

While holding the **FUNC** key down, press the **UHF** knob.

- This operation turns the beep function on and off.

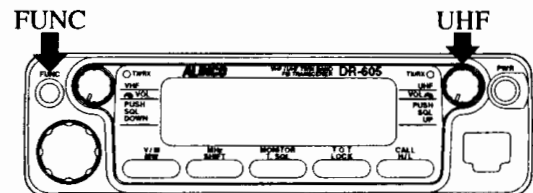

 *Notes:*

- This setting affects operation in both the VHF and UHF bands.
- There is no icon on the LCD showing whether the beep function is on or off.

# 4.5 Resetting

Resetting the transceiver returns all programmed memory contents to their factory default settings. If any problems persist, resetting may overcome them and return the transceiver to normal operation.

## Resetting Procedure

While holding the **FUNC** key down, turn the power on.

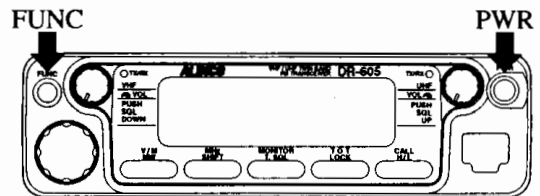

- After all segments of the LCD is displayed, the default settings are displayed.

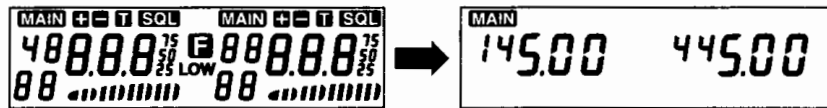

**Note:** • Take special care when resetting because all settings are initialized.

### Factory Default Settings

Main band		DR-605T	DR-605E
CALL frequency	VHF	145.000 MHz	145.000 MHz
	UHF	445.000 MHz	435.000 MHz
VFO frequency	VHF	145.000 MHz	145.000 MHz
	UHF	445.000 MHz	435.000 MHz
Offset frequency	VHF	0.6 kHz	0.6 kHz
	UHF	5 MHz	7.6 MHz
Tone frequency		88.5 Hz	
Offset direction		None	
Tone setting		None	
Channel step		5 kHz	12.5 kHz
Memory channel No.		C	
Scanning resume condition		Timer	
Tone burst frequency		1750 Hz	
BCLO function		Off	
MONITOR/KL		Off (No icon displayed)	
Output power		High (No icon displayed)	
Squelch level		3	

**CHAPTER 5**

**SELECTIVE COMMUNICATION**

**5.1 Tone Squelch (CTCSS)**

The optional tone squelch unit (EJ-24U) must be installed to activate the tone squelch (decoder) function. During tone squelch operation, when a signal is received that contains a correct subaudible tone, squelch is unmuted and you can hear the signal. This allows communication only with selected stations.

➔ For details on how to install EJ-24U, see page 48.

⚠ **Note:** • When communicating through a repeater, do not use the tone squelch function. Depending on the repeater, subaudible tones may interrupt your communication.

**Selecting Tone Frequency**

1. Press the **FUNC** key and while **F** is displayed, press the **MONITOR** key.

- Each time the **MONITOR** key is pressed, the display changes as follows:

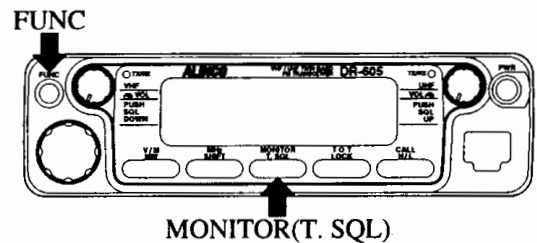

- Press the **MONITOR** key repeatedly until **T SQL** is displayed.

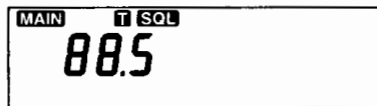

- To exit the setting mode, press the **FUNC** or microphone **PTT** key while neither **T** nor **T SQL** is displayed.

2. Rotate the Dial or press the microphone **UP/DOWN** key to select the desired tone frequency (selectable from 50 frequencies).

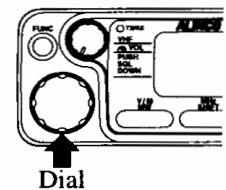
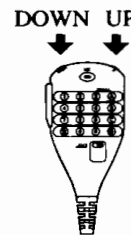

✎ **Tip:** The tone frequency can be set separately for the VHF and UHF bands.

• Table of available tone frequencies (Unit: Hz)

67.0	69.3	71.9	74.4	77.0	79.7	82.5	85.4	88.5
91.5	94.8	97.4	100.0	103.5	107.2	110.9	114.8	118.8
123.0	127.3	131.8	136.5	141.3	146.2	151.4	156.7	159.8
162.2	165.5	167.9	171.3	173.8	177.3	179.9	183.5	186.2
189.9	192.8	196.6	199.5	203.5	206.5	210.7	218.1	225.7
229.1	233.6	241.8	250.3	254.1				

**5**



3. Press the **FUNC**, **V/M**, or microphone **PTT** key to confirm the selected frequency.
  - With **T SQL** still displayed, the LCD returns to the reception frequency display.

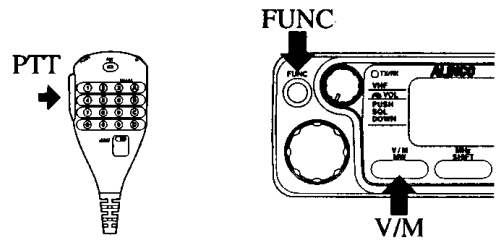
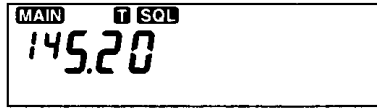

**Note:** • If no action is taken within five seconds of making the setting, the selected tone frequency is confirmed just the same.

- To cancel the selected frequency, press the **MONITOR** key until **T** or **T SQL** disappears, and then press the **FUNC** or microphone **PTT** key.

**Notes:** • The tone frequency can be set separately for the tone encoder and decoder. However, changes in the tone frequency of the tone encoder automatically change that of the tone decoder.  
 • Changes in the tone decoder frequency of the tone squelch do not affect that of the tone encoder.

## Transmission

Press the **PTT** key.

- The set subaudible tone is superimposed over your transmission signal.

## Reception

When a signal with the correct tone is received, squelch is unmuted and you can listen to voice.

**Tip:** When a signal with a tone other than one for your party is received, you cannot listen to voice but the S-meter indication changes.

5

## Scanning

When receiving a signal with a correct tone, the transceiver stops scanning and receives the signal.

**Tips:** • During scanning, the scanning direction can be changed with the Dial or the microphone **UP/DOWN** key.  
 • When paused, scanning can be resumed with the Dial or the microphone **UP/DOWN** key.

## Tuning off the Tone Squelch

1. Press the **FUNC** key and while **F** is displayed, press the **MONITOR(T.SQL)** key.
  - The current tone squelch settings are displayed.

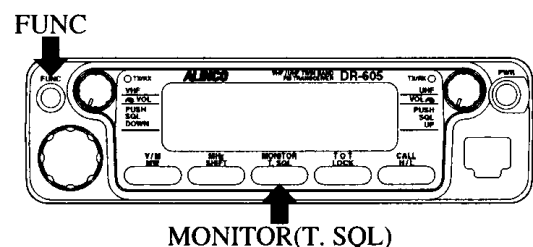
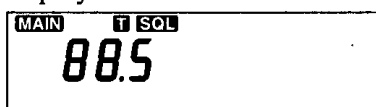

2. Press the **MONITOR** key.
  - **T SQL** disappears.

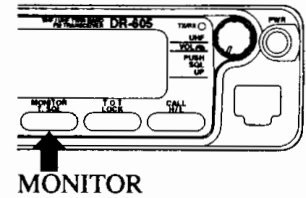

3. Press the **FUNC**, **V/M**, and microphone **PTT** key.
  - The LCD returns to the reception frequency display.

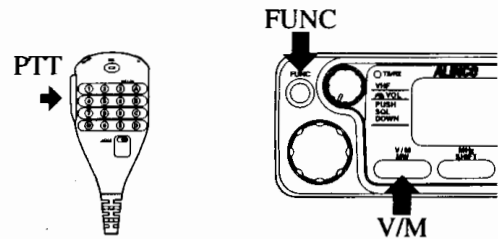
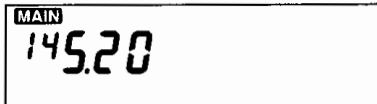

**Note:** • If no action is taken within five seconds after the **MONITOR** key is pressed, the LCD returns to the reception frequency display.

### Using the MONITOR function

The **MONITOR** function allows you to temporarily turn the tone squelch off.

➔ For details on the **MONITOR** function, see page 31.

## Tone Scanning

Tone scanning searches a received signal for a specific tone.

### 1 Turning on the Tone Squelch

In the VFO mode, press the **FUNC** key and while **F** is displayed, press the **MONITOR(T.SQL)** key.

- Press the **MONITOR** key repeatedly until **T SQL** is displayed.

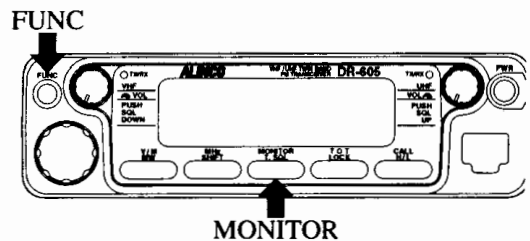
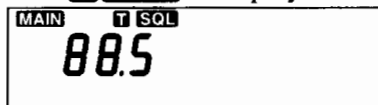

5

### 2 Starting Scanning

While the tone frequency is displayed, hold the microphone **UP/DOWN** key down for anywhere between one and two seconds.

- The decimal point flashes and scanning proceeds in the direction of the key pressed (upwards or downwards).

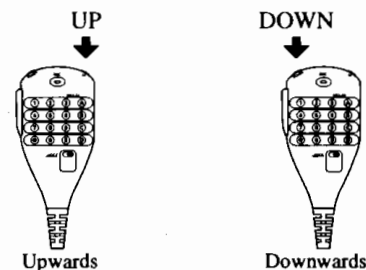
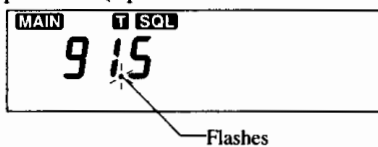

- Tips:**
- During scanning, the scanning direction can be changed with the Dial or the microphone **UP/DOWN** key.
  - When paused, scanning cannot be resumed until the **UP/DOWN** key is pressed.

### 3 Stopping Scanning

Press the **FUNC**, **V/M**, or microphone **PTT** key.

- The decimal point appears solidly and scanning stops.

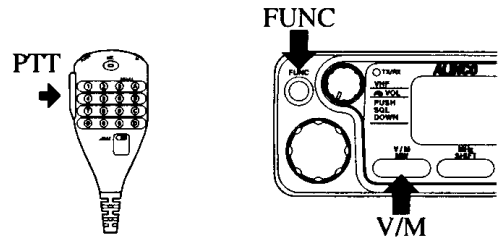
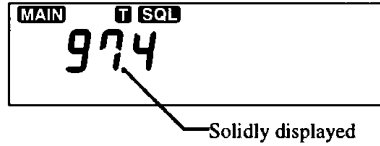

### 4 Exiting the Scanning Mode

After scanning stops, press the **FUNC**, **V/M**, or microphone **PTT** key.

- The transceiver returns to the VFO mode.

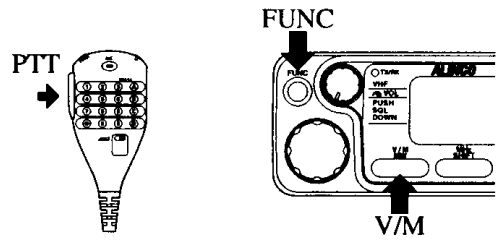
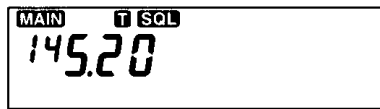



## 5.2 Tone Burst

A burst tone can be transmitted for accessing European repeaters, etc.

### Transmitting Burst Tone

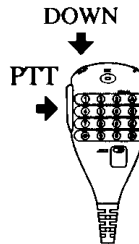
Hold the **PTT** key down, and press the **DOWN** key (and then release the **DOWN** key if desired).



 **Notes:** • Tone burst transmission is not possible in the **CLONING** mode. (See page 44.)

 To change the burst tone frequency, see page 46

## CHAPTER 6

## MAINTENANCE

## 6.1 Troubleshooting

If a problem should occur, first try any of troubleshooting procedures listed below. If the problem persists, try to reset the transceiver; this may solve the problem. If all else fails, contact an authorized ALINCO dealer.

⇒ For details on resetting, see page 32.

Problem	Possible Cause	Solution
Power is on but nothing appears on LCD.	a. + and - polarities of power connection are reversed. b. Fuse is blown.	a. Connect red lead to plus terminal and black lead to minus terminal of DC power supply. b. Check and solve problem resulting in blown fuse and replace fuse with new one(*).
LCD is too dim.	Power voltage is low.	Power supply voltage should be 13.8 V DC.
No sound comes from speaker. Reception is not possible.	a. VHF or UHF knob is turned too far counterclockwise. b. Squelch is muted. c. Tone squelch is active. d. PTT key is pressed and transceiver is in transmission. e. External speaker is connected.	a. Adjust VHF or UHF knob to proper level. b. Decrease squelch level. c. Turn tone squelch off. d. Release PTT key. e. Unplug external speaker.
Key and Dial do not function.	KEY LOCK function is activated ("L" is displayed).	Cancel KEY LOCK function.
Rotating Dial will not change memory channel.	a. No memory channel is programmed. b. Transceiver is in CALL mode.	a. Program memory channel. b. Press V/M key to access memory mode.
Pressing UP/DOWN key will not change memory channel.	Transceiver is in CALL mode.	Access the VFO or memory mode.
PTT key is pressed but transmission is not possible.	a. Microphone connection is poor. b. Antenna connection is poor.	a. Connect microphone properly. b. Connect antenna properly.

## ■ Replacing Fuse\*

DR-605T.....15 A

DR-605E.....15 A

When a new fuse blows soon after replacement, disconnect the power cable and contact an authorized ALINCO dealer.

 **Caution:** Be sure to use the above-specified fuses.

 **Note:** • *If the reception frequencies are related as follows, an unmodulated signal may be received. This results from the transceiver's frequency composition rather than a transceiver problem.*

*(VHF band side reception frequency - 21.7 MHz) × 3 = UHF band side reception signal - 61.7 MHz*

- *If a reception frequency is three times higher than a transmission one, you may hear your own transmission.*

## 6.2 Cleaning

Use a dry, silicone or soft cloth to clean the control panel and case.

 **Notes:** • *Do not use thinner, benzine, alcohol, or any solvent that might deform or discolor the transceiver.*  
• *If any part of the transceiver is excessively dirty, use a water-diluted neutral detergent to clean it.*

## A Packet Operation

Packet operation is used to transfer data, rather than voice, with a personal computer.

### ■ Requirements for Packet Operation

- ① Antenna
- ② Regulated DC power supply (for DR-605)
- ③ Regulated DC power supply (for TNC)
- ④ TNC (Terminal Node Controller)
- ⑤ Personal computer

-  **Notes:**
- A separate DC power supply is required for each the transceiver and TNC.
  - If the transceiver, personal computer, and TNC are too close to one another, they will interfere with each other.
  - Make sure that you and your partner use the same frequency.

### ■ TXD (transmission data) Input Sensitivity

	Input impedance	Standard modulation input	Compliant equipment
1200 bps	2.2 k $\Omega$	10mVp-p	Standard TNC or other communication equipment
9600 bps	10 k $\Omega$	2Vp-p	9600 bps modem/TNC

-  **Notes:**
- Deviation from the optimum input level (10mVp-p for 1200 bps, 2Vp-p for 9600 bps) results in low S/N ratio or excessive distortion, which causes data communication errors.
  - If the data input level exceeds approx. 3 Vp-p in 9600 bps packet operation, the transceiver's limiter circuit is activated and a transmission error may occur. In this case, adjust the TNC volume to the optimum level.

## 1200 bps Packet Operation

### ■ Connections for Packet Operation

Connect the TNC, etc., to the microphone jack (on the front panel) and SP jack (on the rear panel) on the transceiver.

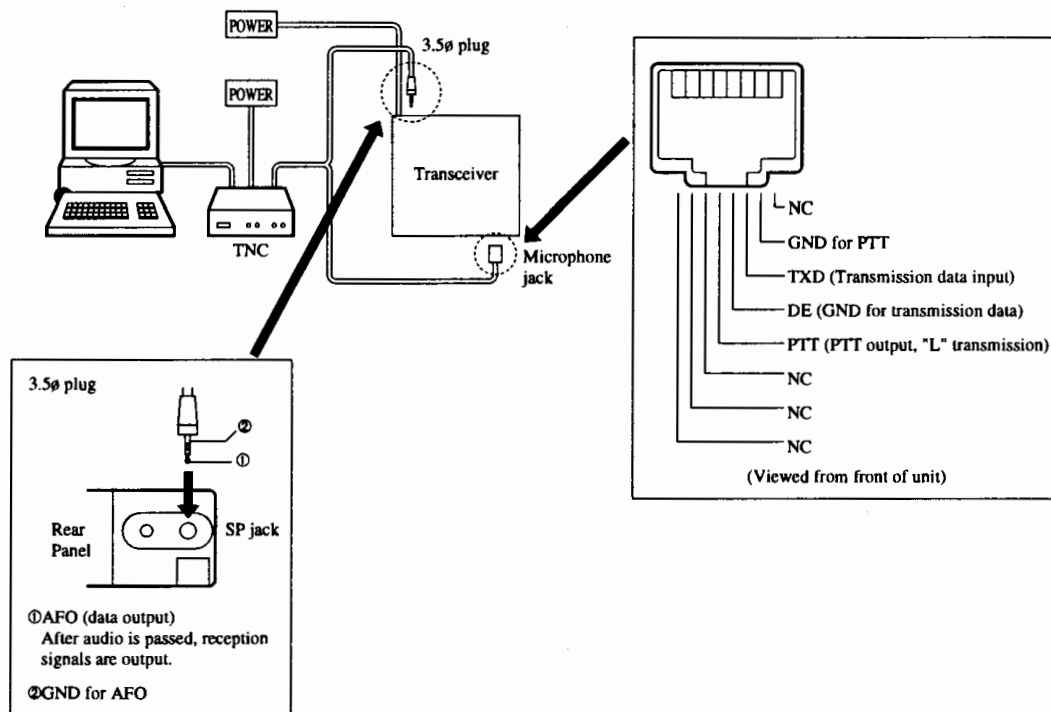

### ■ Packet Operation

1. Select the squelch level at which the noise just disappears.
2. Adjust the volume according to the packet input level.

## 9600 bps Packet Operation

### ■ Connections for Packet Operation

Connect the TNC plugs to the data input jack (left) and PTT (SP) jack (right) on the rear panel of the transceiver.

**Note:** • If a G3RUH or K9NG type TNC is used, its output level may be low depending on the manufacturer. Because the low output level may result in insufficient deviation, check that the output level is correct before performing operations.

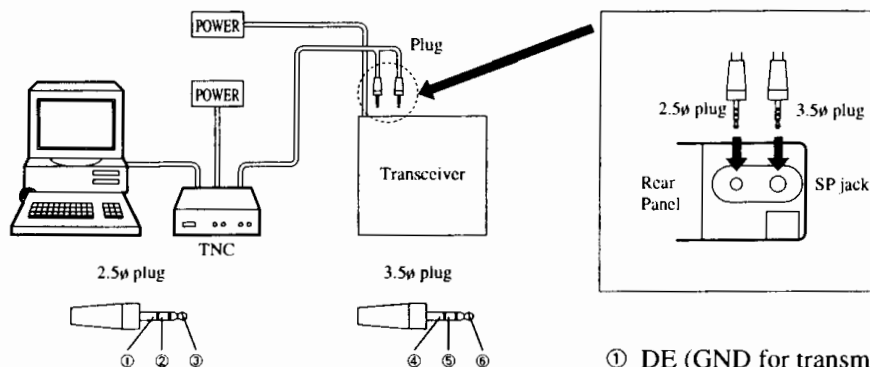

- ① DE (GND for transmission data)
- ② PR9600 (9600 bps data output)  
Outputs FM signal detector  
(output level: 300 mVp-p/47 k)
- ③ TXD (Transmission data input)  
Connects to the TNC MIC output
- ④ GND for PTT
- ⑤ PTT (PTT output, "L" transmission)  
Connects to the PTT output
- ⑥ NC

### ■ Packet Operation

1. Press the VHF or UHF knob to select the main band.
2. While holding the FUNC key down, press the VHF knob.
  - "9600" is shown on the sub-band display. (The main-band display still shows the reception frequency.)

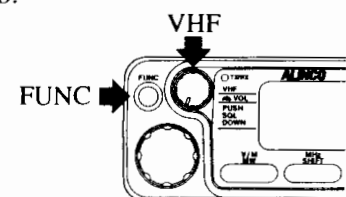
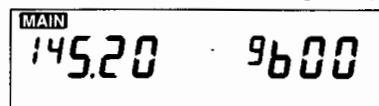

- To exit this packet mode, repeat this operation.

3. Adjust the volume and squelch to the most desirable level for monitoring operation. The volume and squelch level do not affect output of received data.

**Note:** • In the 9600 bps packet mode, you cannot access the XBR or CLONING modes.  
 • In the 9600 bps packet mode, you cannot use the monitor or reverse function.  
 • In the 9600 bps packet mode, audio input and PTT control from the microphone are turned off, and CTCSS decoder is disabled.



## B Channel Display Mode

This mode display shows preprogrammed memory channel numbers instead of frequencies.

### Accessing the Channel Display Mode

While holding the V/M key and VHF knob down, turn the power on.

- The number of the last-accessed memory channel is displayed.

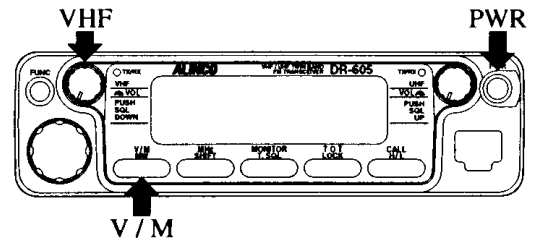

**Note:** • If no memory channel has been preprogrammed, "--- ---" is displayed on the LCD.



- Notes:**
- In this mode, you can:
    - Access the XBR and CLONING modes.
    - Activate the MONITOR and KEY LOCK functions if they are turned on in the SET mode.
  - In this mode, you cannot:
    - Switch between the VFO and memory modes.
    - Access the CALL mode.
    - Change the TOT settings.
    - Change the offset frequency and direction.
    - Change the tone squelch settings.
    - Access the SET mode.
    - Access the 9600 bps packet mode.
    - Turn the beep function on/off.
    - Erase data from memory channels.

### Exiting Channel Display Mode

While holding the V/M and CALL keys down, turn the power on.

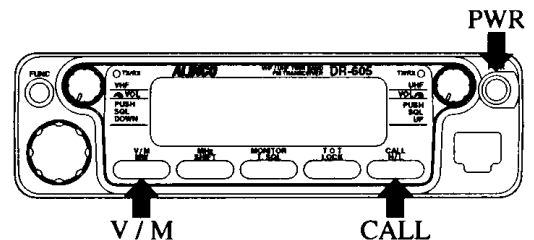

PP.

## C XBR (Crossband Repeater) Mode (for the DR-605T Only)

This mode allows the DR-605T to operate like a repeater. That is, when receiving a specific signal on one band, the transceiver automatically transmits a specific signal on another band. During transmission, **MAIN** appears on the transmission side.

- ⚠ **Notes:**
- During transmission, the main band cannot be changed.
  - This mode can be accessed in the VFO, memory, and CALL modes as well as channel display mode 1.
  - This mode cannot be accessed in the 9600 bps packet mode.
  - If you access the XBR mode from the CLONING mode, the transceiver exits the CLONING mode and enters the XBR mode.
  - If a crossband memory channel is selected, transmission takes place at the reception frequency.
  - If the tone squelch unit is installed, it is activated when a tone signal is received.
  - If offset direction and frequency are set, the transceiver transmits the reception frequency plus (or minus) the offset frequency.
  - In the XBR mode, the TOT function is active but the TOT penalty time is ignored.
  - In the XBR mode, the BCLO function is inactive. (See page 47.)

### Accessing the XBR Mode

While holding the VHF knob down, turn the power on.

- **MAIN** flashes, meaning the transceiver is in the XBR mode.

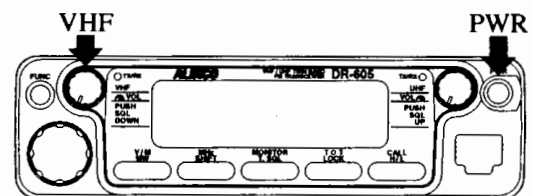
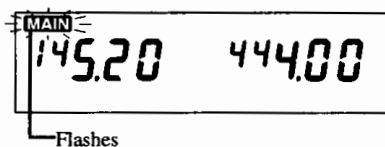

### Exiting the XBR Mode

While holding the UHF knob down, turn the power on.

- **MAIN** appears solidly, meaning the transceiver has exited the XBR mode.

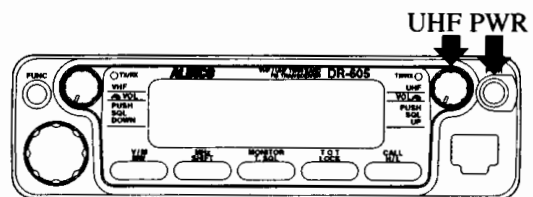
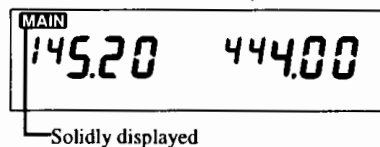

# D CLONING Mode

The **CLONING** mode allows you to transfer data from a preprogrammed DR-605 (master) to an unprogrammed DR-605 (slave). The master and slave must be connected with a commercially-available 3.5  $\phi$  stereo plug cable.

## Cloning

Complete these steps for each cloning operation.

1. Turn off the master and slave DR-605's.
2. Plug one end of the 3.5  $\phi$  stereo plug cable into the master's SP jack and plug another end into the slave's SP jack.

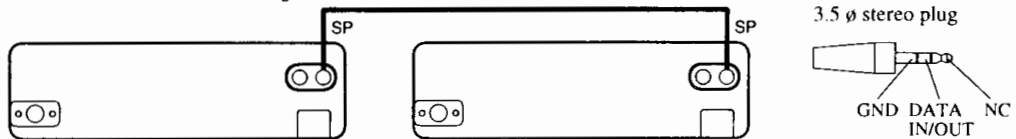

3. On both the master and slave, hold the **V/M** and **MONITOR** keys down, and turn the power on.
  - The LCD displays "cLonE" on both transceivers.

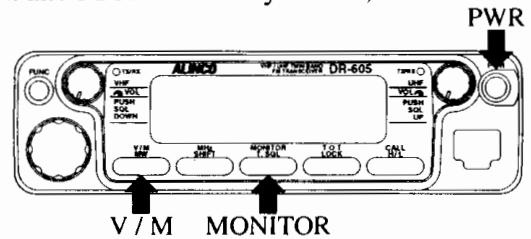
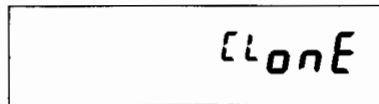

4. On the master, press the microphone **PTT** key to start transferring data.
  - During the transfer, the master displays "SEnd" and the slave still displays "LoAd."

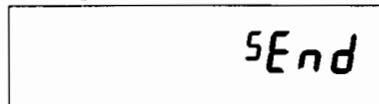

Master



Slave

5. a) If the transfer is successful:
  - "PASS" is displayed on the master and slave. Then the master and slave automatically exit the **CLONING** mode. If any key is pressed, the transceivers return to the **CLONING** mode.



- b) If an error has occurred:
  - "Err" is displayed on the master. In this case, check and solve what caused the error, and press the **PTT** key again on the master. If the error persists, turn the transceivers off and repeat the steps 2 and 3.



For more cloning, bring the next slave into the **CLONING** mode; that is, display "cLonE" on the LCD.

6. Turn the power off to both the maser and slave.
7. Disconnect the cable.

PP.

# E SET mode

The **SET** mode enables you to set the following.

- Scanning resume condition
- Tone burst frequency
- **BCLO** (Busy Channel Lock Out) function on/off
- **MONITOR** and **KEY LOCK** functions on/off (for the channel display mode)

## Accessing the SET Mode

While holding the **FUNC** key down, press the **CALL** key.

- **F** disappears and the first setting item (scanning resume condition) is displayed.

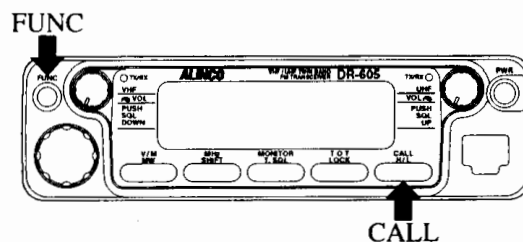
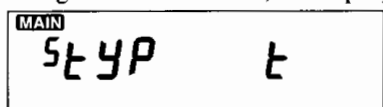

-  **Notes:**
- The **SET** mode is not canceled even if no action is taken within five seconds of making the setting.
  - The **SET** mode cannot be accessed in the channel display mode.
  - In the **SET** mode, the transceiver still continues receiving.

## Selecting Setting Items

Rotate the Dial to select the desired setting item.

- Rotating the Dial changes the item like this:

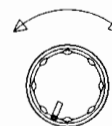
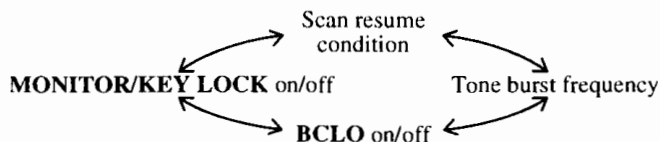

## Confirming the Setting

To confirm the setting, proceed with one of the following actions.

- Press the **FUNC**, **V/M**, or microphone **PTT** key.

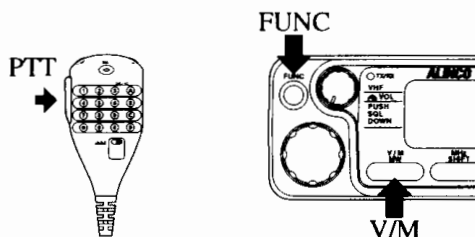

- Rotate the Dial to move to the next setting item.

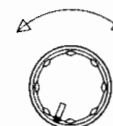

- Turn the power off.

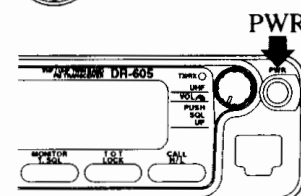

APP

## Setting Scanning Resume Condition

The scanning resume condition is selectable from these two modes.

- Timer mode ....Scanning resumes five seconds after pausing, or when the signal disappears for two seconds or more.
- Busy mode .....Scanning pauses while a signal is being received, and resumes 2 seconds after the signal disappears.

Pressing the microphone UP/DOWN key changes the resume condition as shown below.

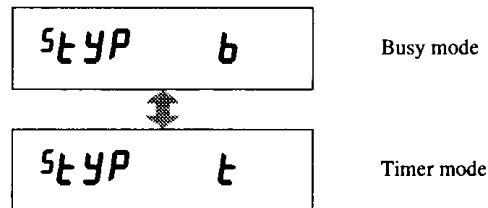

## Setting Tone Burst Frequency

➡ For details on tone burst, see page 36.

Pressing the microphone UP/DOWN key changes the tone burst frequency as shown below.

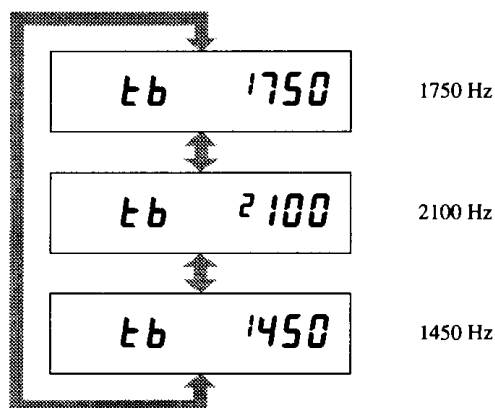

## Setting BCLO (Busy Channel Lock out) Level

The **BCLO** function prohibits transmission when your transceiver receives a signal with a tone other than one for your group (if the tone squelch is activated).

**Notes:**

- If offset or crossband frequencies are set, the **BCLO** function detects the signal on the reception frequency.

- The **BCLO** function is not activated in the **CLONING** and **XBR** modes.

Pressing the microphone **UP/DOWN** key changes the **BCLO** level as shown below.

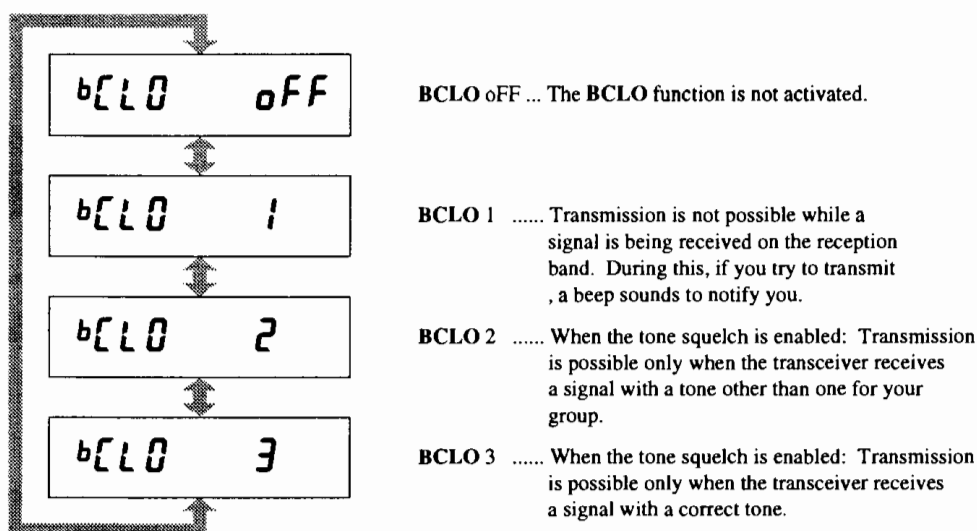

**Note:** • When the tone squelch is not enabled, **BCLO 2** and **3** work the same as **BCLO 1**.

## Turning MONITOR and KEY LOCK Functions On/Off (for Channel Display Mode Only)

The **MONITOR** and **KEY LOCK** functions can be turned on/off only for the channel display mode.

Pressing the microphone **UP/DOWN** key turns the **MONITOR** and **KEY LOCK** functions on/off as shown below.

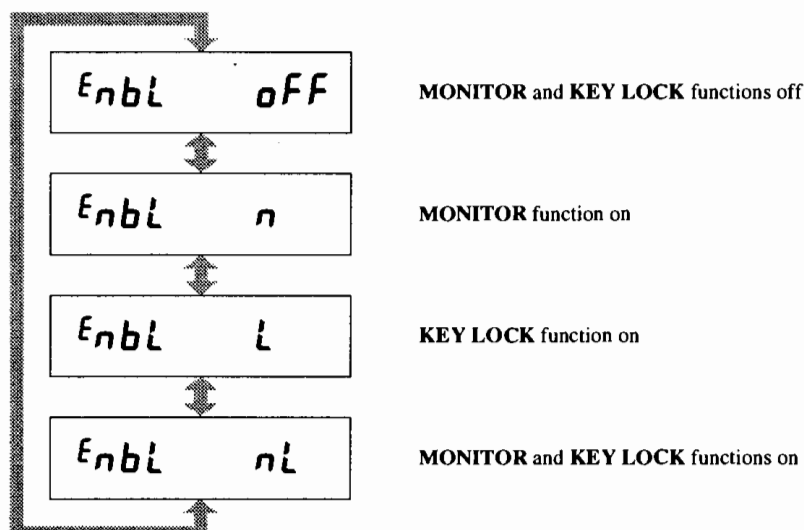

APP.

## F Options

The following options are available.

### Tone Squelch (CTCSS) Unit (EJ-24U)

#### ■ Installing the Tone Squelch Unit

1. Turn the power off and unplug the power cable.
2. Remove the four screws on the top case and remove it.

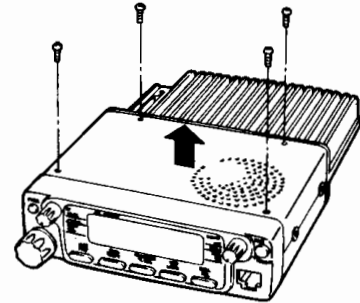

3. Install the EJ-24U unit.
  - Connect the unit with the red lead on the right (viewed from the front panel).
  - Secure the unit on the PC board using the supplied adhesive tape.

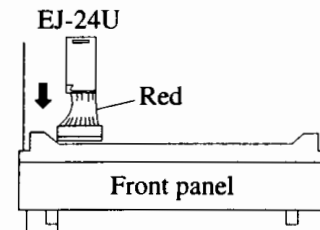

4. Attach the top case and tighten 4 screws on the case.

### DTMF equipped microphone (EMS-45)



 **Note:** • This comes standard with the DR-605T.

# G Specifications

Spec.\Model		DR-605T	DR-605E
<b>General</b>			
Freq. range	VHF	TX:144.000 to 147.995 MHz / RX:136.000 to 173.995 MHz	144.000 to 145.995 MHz
	UHF	TX:430.000 to 449.995 MHz / RX:420.000 to 470.000 MHz	430.000 to 439.995 MHz
Modulation		F3E (FM)	
Ant.		50 $\Omega$	
Supply voltage		13.8V DC	
Ground		Negative	
Current consumption	VHF TX	50 W:11.5 A max.	
	UHF TX	35 W:10.0 A max.	
	RX	1.2 A max.	
Freq. stability		$\pm 10$ ppm max.	
Dimensions		140(W) $\times$ 40(H) $\times$ 176(D) mm	
Weight		1.1 kg	
Channel		VHF:51 / UHF:51 total 102	
<b>Transmitter</b>			
Output	VHF	H:50 W L:approx. 5 W	
	UHF	H:35 W L:approx. 5 W	
Modulator		Reactance mod.	
Spurious		- 60 dB max.	
Max. deviation		$\pm 5$ kHz	
Mod. distortion (@60% mod.)		3% max. (300 to 3000 Hz)	
Mic. impedance		2 k $\Omega$	
<b>Receiver</b>			
Rx system		Double superhet.	
I.F.		VHF:21.7 MHz / 450 kHz	
		UHF:30.85 MHz / 455 kHz	
Sens. (12 dB SINAD)		- 16 dB $\mu$ (0.16 $\mu$ V) or less	
Selectivity		- 6 dB: 12 kHz min., - 60 dB: 28 kHz max.	
Squelch sens.		- 20 dB $\mu$ (0.1 $\mu$ V) or less	
AF output (@5% distortion)		2 W or more (8 $\Omega$ load)	
AF output impedance		8 $\Omega$	

-  Notes: • Specifications are subject to change without notice or obligation.  
• Specifications are guaranteed in the amateur band only.



Spec. \ Model		DR-605TE1	DR-605TE2
<b>General</b>			
Freq. range	VHF	136.000 to 173.995 MHz	136.000 to 173.995 MHz
	UHF	400.000 to 420.000 MHz	450.000 to 470.000 MHz
Modulation		F3E (FM)	
Ant.		50 $\Omega$	
Supply voltage		13.8V DC	
Ground		Negative	
Current consumption	VHF TX	35 W: 11.0 A max.	
	UHF TX	35 W: 11.0 A max.	
	RX	1.2 A max.	
Freq. stability		$\pm 10$ ppm max.	
Dimensions		140(W) $\times$ 40(H) $\times$ 176(D) mm	
Weight		1.1 kg	
Channel		VHF: 51 / UHF: 51 total 102	
<b>Transmitter</b>			
Output	VHF	H: 35 W L: approx. 5 W	
	UHF	H: 35 W L: approx. 5 W	
Modulator		Reactance mod.	
Spurious		- 60 dB max.	
Max. deviation		$\pm 5$ kHz	
Mod. distortion (@60% mod.)		3% max. (300 to 3000 Hz)	
Mic. impedance		2 k $\Omega$	
<b>Receiver</b>			
Rx system		Double superhet.	
I.F.		VHF: 21.7 MHz / 450 kHz	
		UHF: 30.85 MHz / 455 kHz	
Sens. (12 dB SINAD)		- 16 dB $\mu$ (0.16 $\mu$ V) or less	
Selectivity		- 6 dB: 12 kHz min., - 60 dB: 28 kHz max.	
Squelch sens.		- 20 dB $\mu$ (0.1 $\mu$ V) or less	
AF output (@5% distortion)		2 W or more (8 $\Omega$ load)	
AF output impedance		8 $\Omega$	



**Notes:** • Specifications are subject to change without notice or obligation.

## ALINCO, INC.

Head office: "TWIN 21" MID Tower Building 25F  
 1-61, 2-Chome, Shiromi, Chuo-ku, Osaka 540-8580 Japan  
 Phone: 06-946-8150 Fax: 06-946-8175 Telex: 63086  
 E-mail: 101243.1446@compuserve.com  
 U.S.A.: 438 Amapola Ave., Suite 130, Torrance, CA 90501-6201 U.S.A.  
 Phone: 310-618-8616 Fax: 310-618-8758  
<http://www.alinco.com/>  
 Germany: Eschborner Landstrasse 55, 60489 Frankfurt am Main, Germany  
 Phone: 069-786018 Fax: 069-789-60766