

W. K. ...
OPERATING
ALIGNMENT and SERVICING
INSTRUCTIONS
for the

1941

SUPER

Skyrider

MODEL SX-28



the hallicrafters *inc.*

CHICAGO U.S.A.

07292840

THE 1941 MODEL SX-28 SUPER SKYRIDER RECEIVER

INSTRUCTIONS FOR INSTALLATION, OPERATION AND SERVICE

INSTALLATION

It is recommended that, upon receipt, the carton and then the receiver be carefully examined for any damage which might have occurred in transit. Should any sign of damage be apparent immediately file claim with the carrier stating the extent of the damage.

Important: Unless otherwise marked, this receiver is to be operated from 110-125 volts of 50/60 cycle alternating current. A universal 110-220 volt model is obtainable on order. This model can be operated at either of those two voltages with 25/60 cycle current. If the voltages are higher than indicated an external stepdown transformer must be used. A switch, mounted on the top of the universal transformer case, will allow convenient 110-220 voltage change.

The standard model SX-28 receiver comes equipped with a cabinet for table mounting. The standard $8\frac{3}{4}$ " x 19" panel dimension with holes suitably spaced make it possible for the chassis to be mounted in a standard relay rack. Maximum overall chassis length is $17\frac{3}{8}$ " and depth $13\frac{1}{2}$ ". When the model SX-28 is so mounted the table cabinet is replaced with a dust cover. The maximum over-all length of the receiver will then allow it to be mounted in a rack with upright channel clearance of $17\frac{1}{2}$ ".

TERMINALS AND CONNECTIONS ON REAR OF RECEIVER

SPEAKER

On the rear apron of the receiver's chassis appear two terminal strips for connecting either a 500 or 5000 ohm speaker to the receiver. Should a matching HALLI-CRAFTERS Bass-Reflex speaker be used with the receiver, it should be connected to the 5000 ohm terminals. The 500 ohm terminals can be connected to a speaker or other load of that impedance value.

ANTENNA

To the terminals marked A1-A2 and G should be connected the antenna you have chosen to use with the model SX-28 receiver.

Very satisfactory results throughout the tuning range of the SX-28 will be obtained with a conventional inverted "L" Marconi type of antenna 75 to 100 feet long including lead-in. This antenna should be erected as high as possible and removed from surrounding objects. Be sure that the antenna is insulated from the ground at all points. When this type of antenna is used it is connected to terminal A-1. The Jumper between A-2 and G should remain connected.

In the event a doublet antenna is used with the model SX-28 SUPER SKYRIDER receiver, the two wires of the doublet lead-in should be connected to terminals A1 and A2. The Jumper between A2 and G can remain connected or removed, depending upon its effect on favorable reception.

A ground can be used if desired and should be connected to the G terminal. Connecting the receiver to a good ground (cold water pipe or 6 foot rod driven in moist soil) might improve reception and reduce noise. Under normal conditions no noticeable difference will exist so a ground is suggested only if it aids reception.

Should you wish to have a separate antenna for some one short wave frequency or band, a half-wave antenna cut to the proper length for the desired frequency will prove very effective. The following formula will give the length of the $\frac{1}{2}$ wavelength antenna depending on the desired frequency.

$$\text{Length in feet} = \frac{463}{\text{frequency in megacycles.}}$$

or, for example, a half wave 40 meter antenna would be $\frac{463}{7} = 66.14$ feet long.

The antenna should preferably be of solid soft drawn enameled copper wire for ease in handling. The center of the wire is cut and an insulator inserted at that point. The twisted pair, or open wire transmission line, is then soldered to each 33 foot length, after the enamel has been scraped off, directly on either side of this center insulator. The other end of the transmission line should be connected to A1 and A2 on the receiver. It should be remembered that such an antenna has directional properties broadside to its length and should be so oriented if maximum pickup from a certain direction is to be expected.

In designing transmission line systems for a more accurate match of the line to the antenna input circuit, it will be helpful to know that the approximate antenna input impedance of the receiver is 400 ohms.

STAND-BY SOCKET

The Send-Receive switch on the front panel makes the receiver inoperative by removing the plate voltage from the tubes when the switch is in the SEND position. Connected in parallel with this switch is the standard 110 volt receptacle on the rear chassis edge. Should you wish to make the receiver inoperative by using a remote relay or switch, connect the contacts of the relay to a standard plug, insert it in the STAND-BY switch socket and the external relay or switch will close and open the circuit so long as the SEND-RECEIVE switch on the front panel is in the SEND position.

PHONO-JACK

The Phono-Jack enables you to use the high fidelity audio amplifier of the receiver for phonograph record or transcription play-back purposes. A high impedance crystal or magnetic pick-up arm should be used for this purpose and connected to a standard headphone plug. This plug is then inserted in the PHONO-JACK when record playing is desired. The receiver is inoperative to radio signals, when the plug is in the phono-jack.

The volume of the audio amplifier is varied by rotating the AF Gain control until the proper level is obtained. Removal of the plug from the Phono-Jack once more places the RF and IF portions of the receiver in operation.

6 VOLT DC SOCKET

The DC Operation Socket can be used when it is necessary to furnish power to the receiver from a direct current source. For conventional AC operation, the shorting plug must remain in the DC Operation socket. This plug should be removed for battery or vibrapack operation.

A similar plug to the shorting plug should be wired as shown on the Schematic diagram and connected to the external source of DC power. The DC operation plug is then inserted in the socket and operation from batteries or a vibrapack is secured.

270 volts of plate voltage, or B supply, at 150 milliamperes current are necessary for successful operation of the receiver, should it be operated in this manner.

"S" METER ZERO SET

"S" METER CONTROL is obtained by varying the knurled knob appearing on the left hand chassis apron edge. This control enables you to properly set the "S" Meter to zero. In order to make the adjustment correctly, the RF GAIN CONTROL must be advanced clockwise as far as it will go. In addition, the switch directly below the bandspread hand-wheel must be in the AVC—ON Position. When these conditions have been complied with, remove the antenna from the Receiver and then adjust the S meter control until the S meter reads zero. Reconnecting the antenna to the receiver will then make the meter indicate the relative carrier strength of each incoming signal as various signals are tuned in.

OPERATION

Each control of the Model SX-28 SUPER SKYRIDER receiver performs a definite function that contributes to the outstanding reception capabilities of the unit. Full appreciation of the receiver is to be expected only after you have become familiar with each of the controls and the effect their operation has on the receiver's performance.

The large calibrated main dial shows the frequencies covered throughout the 6 band, 550 kc to 43 mc frequency range of the receiver. They are as follows:

- Band 1—550 to 1,600 kilocycles
- Band 2— 1.6 to 3.0 megacycles
- Band 3— 3.0 to 5.8 megacycles
- Band 4— 5.8 to 11.0 megacycles
- Band 5— 11.0 to 21.0 megacycles
- Band 6— 21. to 43. megacycles

The BAND SWITCH, directly below the main dial, will place the proper set of coils in the circuit to cover the desired frequency. The main dial is turned by the large handwheel which is equipped with a micrometer scale for maximum accuracy in resetting or logging purposes. Of particular interest is the locking clutch which will be found directly below the handwheel. This feature will allow you to lock the main dial after a desired signal has been turned in. Subsequent movement of the handwheel will not detune the receiver because the control is provided with a clutch which disengages the handwheel once the dial lock has been set.

The International Shortwave broadcast bands are indicated on the main dial by heavier lines showing the frequencies on which these transmissions will be heard.

The Amateur band setting positions of the main dial are indicated by a small 0 appearing over the red numbers which identify each amateur band. The hairline on the main dial window should be set so that it intersects this small circle when the main dial is placed in position for the desired amateur band.

The BANDSPREAD dial is calibrated for the 10-20-40 and 80 meter amateur bands. When tuning on the 160 meter band the main dial should be used.

Note: The calibration on the main dial will be accurate

only if the bandspread condenser is set at minimum capacity which is indicated by a setting of 100 on the bandspread logging scale. It should be recognized that if the bandspread condenser is left at any other setting but 100, that small amount of bandspread condenser capacity, added to the main tuning condenser capacity, would throw off the main tuning dial calibration because the receiver is calibrated with the Bandsread condenser set at minimum capacity. The portions of the amateur bands on which type A3, or telephone, transmissions will be heard are underscored with another dark line.

The numbered outer edge of the bandspread dial will prove to be of great help for logging or pre-setting purposes when the bandspread tuning control is used for easier tuning on frequencies other than those covered by the amateur bands.

When "bandsreading" any frequency throughout the tuning range of the receiver remember the main dial must then be set to a slightly higher frequency than the desired signal. The difference depends on the amount of bandspread condenser capacity used and the frequency of the received signal.

When switching from one range to another, an indicator moves vertically behind both the main and bandsread dials. Tuning fatigue is thereby greatly minimized by focusing attention on only the frequencies covered by that particular setting of the bandswitch.

The translucent, indirectly lighted dials are easily read and so arranged that parallax is reduced to an absolute minimum.

To operate the receiver adjust the following controls in the order in which they are mentioned:

The TONE CONTROL turns the receiver *on* and *off* and in addition emphasizes either the base or treble frequencies to the extent required by various receiving conditions. The effect the Tone Control has on the fidelity of reproduction is shown in the accompanying Audio Fidelity curve.

Place the SEND-RECEIVE switch in the RECEIVE position—have the ANL control off (turned to the left until the switch operates).

Place the bandswitch in position .55 to 1.65 mc, which will then enable you to tune in stations on the standard Broadcast Band.

Rotate the RF GAIN control to the right until #9 on the skirt of the control appears under the panel marker. (The RF Gain must be full ON as above indicated before the S meter will indicate correctly.) So that the S meter will be properly connected in the circuit, the AVC-BFO switch appearing to the lower right of the bandsread handwheel, must be in the AVC ON position.

Note: The *Antenna Trimmer* control is not in the circuit on Bands 1 and 2. On the remaining bands proper adjustment of this control is indicated by the maximum signal.

After complying with the above conditions, the AF GAIN control should be advanced to the right until the desired volume is obtained. Tuning the receiver by operating the main dial handwheel will now allow you to pick up stations throughout the .55 to 1.65 mc tuning range of the Broadcast band. Maximum deflection of the S Meter will indicate when each station is accurately tuned in.

When covering the short-wave or higher frequency bands the above procedure should be followed—except that greater care should be used because it is so easy to completely pass over a station.

The other controls on the model SX28 SUPER SKYRIDER receiver will enable you to obtain the best results

from the receiver once you have become used to their effects on the reception of various types of signals.

The SELECTIVITY control acts as a shutter or gate and varies the width of the path on which signals reach the second detector of the receiver. Six different selectivity steps are provided so that you can successfully cope with different degrees of interference. Reference to the SELECTIVITY CURVE will show, graphically, how the control trims the width of the signal so that what interference might be present in the signal's skirts or sidebands is effectively clipped off. Should an interfering signal lap over into the desired signal, adjustment of the SELECTIVITY control, will reduce that interference.

I. F. SELECTIVITY

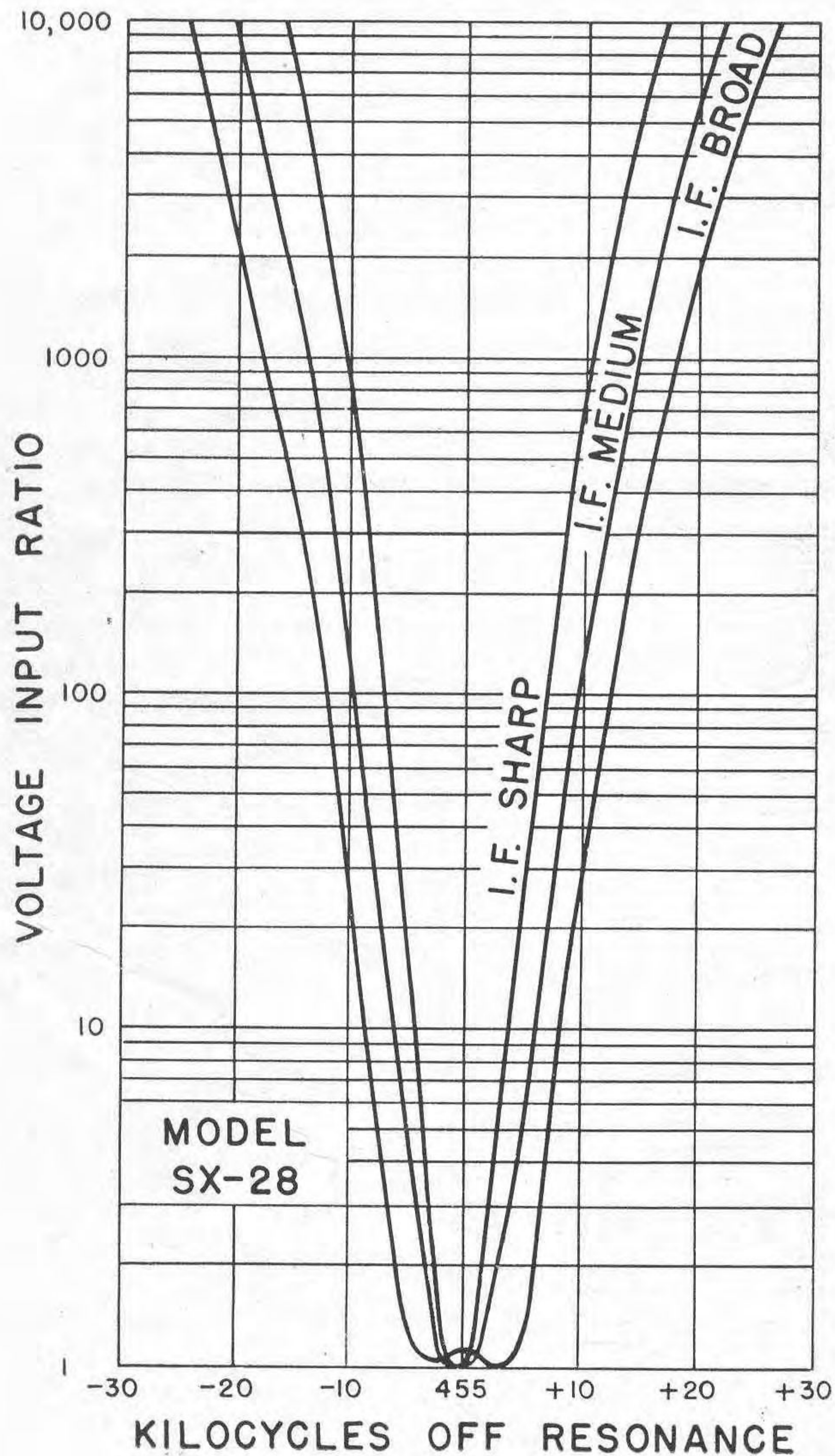

Please once more refer to the SELECTIVITY CURVE and recognize the fact that with the control set in the BROAD IF position, the signal proper and all its parts, which are combined in the side bands, or skirts, will be passed to the 2nd detector, audio amplifier, and then Speaker. As the selectivity of the receiver is increased from BROAD-IF to XTALSHARP, the gate, or admittance path, is so narrowed that only the main portion of the signal is allowed to pass through. This fact and its effect on the quality of reproduction is readily appreciated by listening to a signal and noting the reduction in higher frequency response in the more selective settings of the switch.

At this point, it is suggested that the CRYSTAL SHARP setting be used only in cases of extreme interference—the receiver must then be tuned exactly to the signal. Only then will the signal be intelligible because you have clipped off its sidebands in which the sibilants and overtones are embodied.

The CRYSTAL SHARP position of the selectivity switch is to be used principally for the reception of code, or CW, signals. By proper associated operation of the CRYSTAL PHASING control true single signal operation and the maximum in selectivity can be obtained (crystal circuit discussed in detail in the summary of related circuits).

PHASING CONTROL

The Phasing Control is in the circuit on three positions of the selectivity control namely—XTAL Sharp, XTAL Medium and XTAL Broad.

The control is used to remove heterodyne interference as well as to minimize other forms of interference having a predominance of high frequency components—such as static and interference from electrically operated devices.

The A.N.L., or *Automatic Noise Limiter*, materially contributes to the satisfactory operation of the receiver by limiting objectionable interference caused by ignition systems or other man made causes of electrical disturbances. With the A.N.L. control retarded to the left as far as it will go, or until the A.N.L. switch is heard to operate—the noise limiter circuit is not functioning. Turning the control to the right closes the switch which is mounted on the control. The noise limiter is now operating. Progressively turning the control clockwise varies the threshold at which the noise limiter starts to take hold. The setting at which the control will be left depends entirely on the type and amount of interference present as well as the signal strength. The noise limiter should be judiciously adjusted because through its operation the desired signal can even be eliminated or badly distorted which destroys its usefulness. Only after you have become familiar with the operation of this control by actual practice can you determine how far it should be advanced before the best compromise between noise and signal is obtained.

The AVC-BFO OFF-ON switch performs a dual function. The AVC circuit should be operating for the reception of telephone, or modulated, signals in order to reduce fading to a minimum. As previously mentioned, the functioning of the S Meter is dependent upon AVC action so the switch must be in the AVC ON position when the S meter is used to measure relative carrier intensity.

Inasmuch as the AVC circuit levels all signals to a predetermined value (See AVC action curve) no one signal can overload the receiver and cause distortion. At times, in searching for distant or weak signals, it might be desirable to use the full sensitivity of the Model SX-28. In that case place the AVC switch in the AVC OFF position. Remember that with the receiver operating with no AVC action, strong signals will overload the input circuit with resultant distortion. Under such a condition of operation the sensitivity of the set must be then controlled, manually, by properly retarding the RF Gain control until you have reached the point below which overloading takes place.

The other function of this switch is to turn on the Beat Frequency oscillator. When receiving code signals, a beat note is absolutely essential. With the BFO switch in the ON position, each signal tuned in will be accompanied with a beat note or whistle. For proper adjust-

ment of the BFO control which appears directly under the TONE CONTROL the following procedure is suggested. Set the BFO control to zero, now tune in a signal either voice or code. If a code signal is received, only the carrier or thump of the signal will be audible because no beat note is present. Be sure that you have the signal accurately resonated. Now, without retuning the receiver, rotate the BFO control until a beat note of the desired pitch is obtained. You now have introduced a beat note which differs from the IF frequency of the receiver, namely 455 kc, by the frequency of the audible signal. Variation of the BFO control will allow you to change the pitch, or frequency, of the oscillator which will prove to be of help under various conditions of interference.

Directly under the BFO control will be seen the BASS IN-OUT Switch. With this switch in the BASS IN position you will have normal audio fidelity. Placing the switch in the BASS OUT position, the audio filter CH₂ is inserted. The effect of this filter on the band of frequencies passed is shown on the AUDIO FILTER curve. This filter will contribute greatly to the intelligibility of the received signal when the receiver is operated in the advanced positions of selectivity.

The Head Phone Jack is connected to a tap on the output transformer. The signal in the headphones is of the proper volume for satisfactory communications reception. Since no direct current is present in the headphone circuit crystal type phones can be used.

SUMMARY OF RELATED CIRCUITS

THE 2-STAGE PRESELECTOR

The RF AMPLIFIER, or pre-selector, of the Model SX-28 SUPER SKYRIDER has two 6SK7 tubes in cascade on Bands 3, 4, 5, and 6. On Bands 1 and 2 more than one stage is unnecessary to obtain the required image ratio and reduction of spurious interference. With two RF stages using three pre-selection circuits, the band width would be narrowed to such an extent that even expanding the IF Amplifier to its utmost would still not provide high-fidelity reception. The modern communications receiver requires two stages of preselection on the higher frequencies to accomplish only one primary object—satisfactory image rejection.

The Model SX-28 has an image ratio of 45 to 1 at 28 mc—350 to 1 at 14 mc and a proportionately increasing ratio as the frequency is lowered. While the two RF stages are principally needed to obtain such image ratios they also perform two other useful functions—more favorable signal to noise ratio and slightly increased selectivity.

Examining the coil assembly will immediately show how rigidly it is constructed and what care has been taken to completely shield each section from the other. The manner in which the RF and antenna coils are tuned on bands 3, 4, 5, and 6 will be interesting. Rather than push turns to compensate for variations in inductance, each coil is permeability tuned. This results in exact adjustment of inductance with improved tracking and gain as the result. On Bands 1 and 2 the inductance of the antenna coils is sufficiently large so that lead length differences do not cause any noticeable inductance change.

THE OSCILLATOR AND CONVERTER

A separate 6SA7 tube is used as the High Frequency Oscillator in the Model SX-28 SUPER SKYRIDER. This tube proves desirable in this function because of its very high value of transconductance which enables the oscillator to operate with very little coupling to the coil. This feature reduces the unfavorable effects of tube variations and voltage fluctuations on the tuned circuit. The HF Oscillator is coupled to the 6SA7 converter tube at the Cathode Tap—a point where variations of operating parameters of the converter tube will least affect the 6SA7 Oscillator. A 6SA7 tube is used in the Mixer Circuit because tests indicated that changes in operating voltages caused less reflection in the injector grid loading than would occur in most converter tubes. Another feature in favor of the 6SA7 tube is that a negative loading is

applied to the tuned circuit feeding its control grid. This characteristic improves the gain and selectivity of the tuned circuit which in turn improves the image and signal to noise ratio.

THE IF AMPLIFIER

The IF Amplifier of the Model SX-28 was designed with a view towards permanency of adjustment under conditions of extreme changes in temperature and humidity as well as unusual mechanical vibration.

The first two IF Transformers are permeability tuned. In comparing this type of transformer with one having compression mica tuning condensers, it must be remembered that it takes many more turns of the adjusting screw to cause the equivalent change in tuning of the permeability tuned type. Hence a slight change in the position of the screw will have negligible effect upon the tuning. The adjusting screw is under spring tension thereby making it impossible to turn under vibration.

The diode transformer is air-tuned with two variable condensers each with a lump capacity of 50 mmf and variable of 50 mmf. These air trimmers are also under spring tension so that they can withstand considerable vibration. Being of the air tuned type, their capacity change is negligible with wide changes in humidity. Reference to the Schematic will show that the IF transformers are expanded in two steps—thereby enabling medium or full reproduction of the higher frequencies to be obtained.

VARIABLE SELECTIVITY

Six ranges of selectivity are provided in the model SX-28 receiver. They are:

- 1—Broad IF—(for high fidelity reception)
- 2—Medium IF—(more selectivity—less highs)
- 3—Sharp IF—(reduces annoying interference—far less highs)
- 4—Crystal Broad—(Similar to Sharp IF but cleaner cutting of side bands)
- 5—Crystal Medium—(next selectivity step to #4—greatly increased sideband cutting—more pronounced crystal "Slot" for interference—very little highs present)
- 6—Crystal Sharp—(position of extreme selectivity—practically no sideband content—very pronounced crystal "slot")

The graphic effects of the different steps of selectivity on a signal are shown in the SELECTIVITY CURVE.

6SK7

CRYSTAL FILTER CIRCUIT

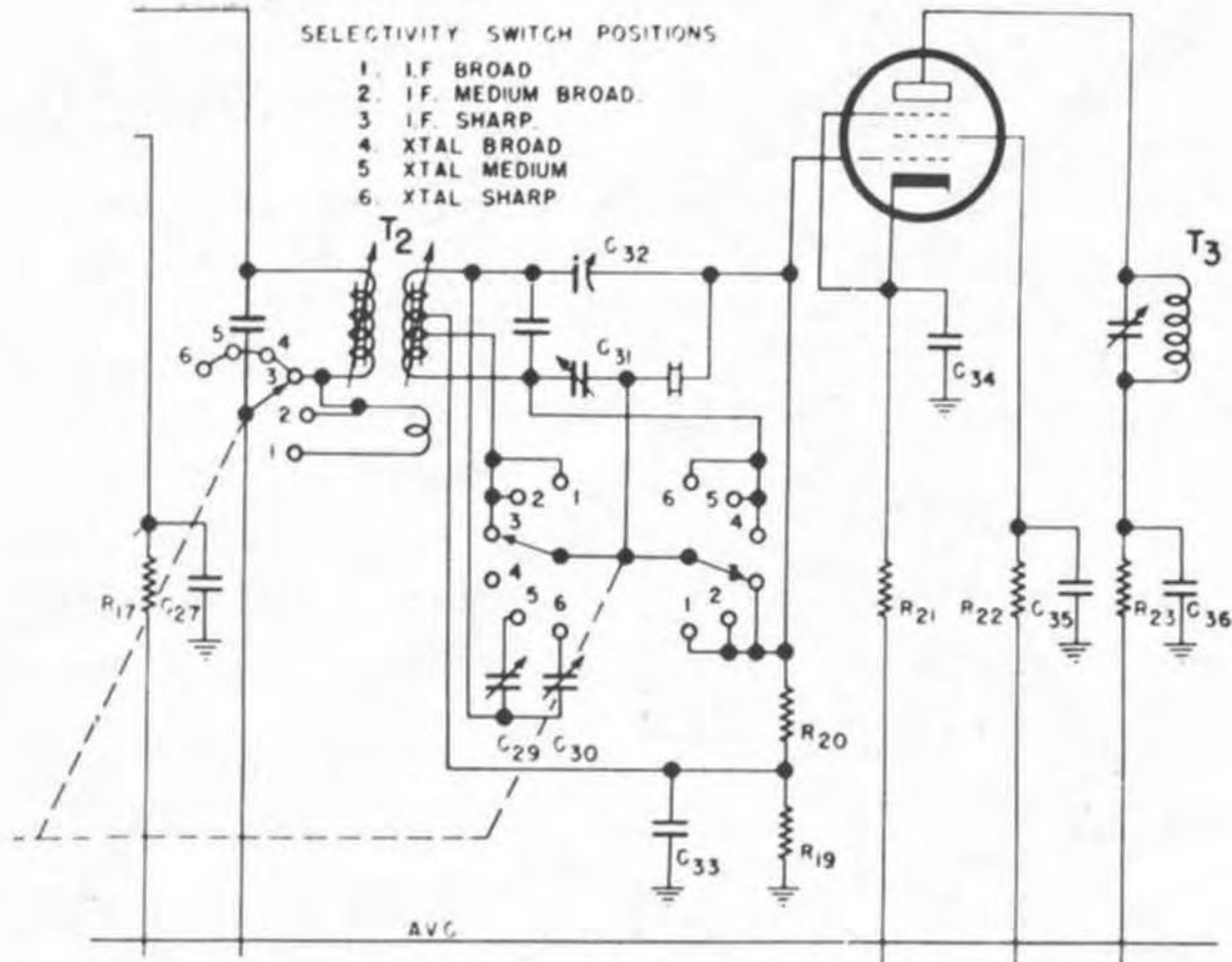

In positions 1, 2, 3 the crystal is short circuited. In position 4 the short across the crystal is opened and the iron core in the secondary of the transformer is adjusted for Broad Crystal Action and at this point is accurately tuned to the crystal frequency. Due to the close coupling of the secondary to the crystal, the sharply rising resonance curve of the secondary causes, in contrast, a sharply falling resonance curve in the secondary. The combined action of these two characteristics results in a relatively broad resonance curve for the CRYSTAL BROAD selectivity setting. In the MEDIUM CRYSTAL No. 5 position, C_{29} is adjusted for selectivity midway between the BROAD and CRYSTAL SHARP settings.

In position 6, or CRYSTAL SHARP, the trimmer C_{30} is adjusted for the Sharpest crystal action. Under this condition, the Secondary is slightly detuned from the resonant crystal frequency sufficiently so that its resonance curve is not greatly affected by the crystal but still coupled tightly enough so that it can transfer energy to the crystal circuit. When this point is reached it is indicated by a rise in the output. Two such points of increased output will normally occur—one for each adjustment of the secondary on either side of the resonant frequency of the crystal.

SINGLE SIGNAL ADJUSTMENT

It is extremely simple to attain single signal reception with the SX-28. First, turn on the BFO to the desired Beat Note and turn the selectivity switch to the XTAL SHARP position. Pick a good solid CW signal, preferably a commercial station because a commercial is likely to stay on long enough for you to complete the phasing adjustment for single signal reception.

You will find on tuning across this signal that it has two amplitudes. Tune first to the weaker of these two amplitudes. Now, turn the PHASING control until this weaker of the two amplitudes is reduced to a minimum. (If the weaker amplitude appears on the right the above procedure still holds.) Then tune to stronger of the two amplitudes and adjust the BFO control to a tone most pleasing to you. This adjustment for single signal selectivity will hold with no further adjustment unless you change the phasing control.

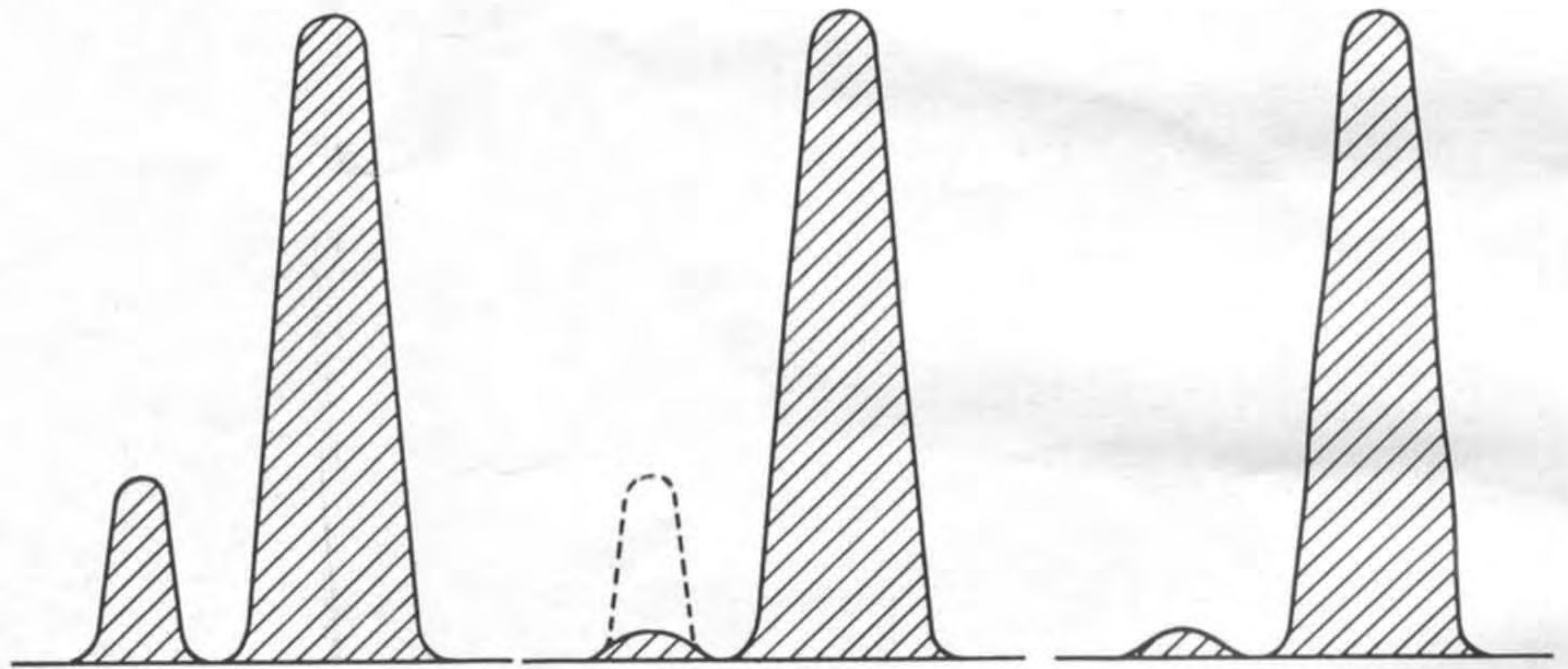

With Selective Switch in XTAL Sharp position identify the weaker amplitude—Tune Receiver to the weaker.

Adjust phasing control carefully until this weaker amplitude is reduced to a minimum.

Retune Receiver to the stronger amplitude and then adjust pitch control until you get note most pleasing to copy.

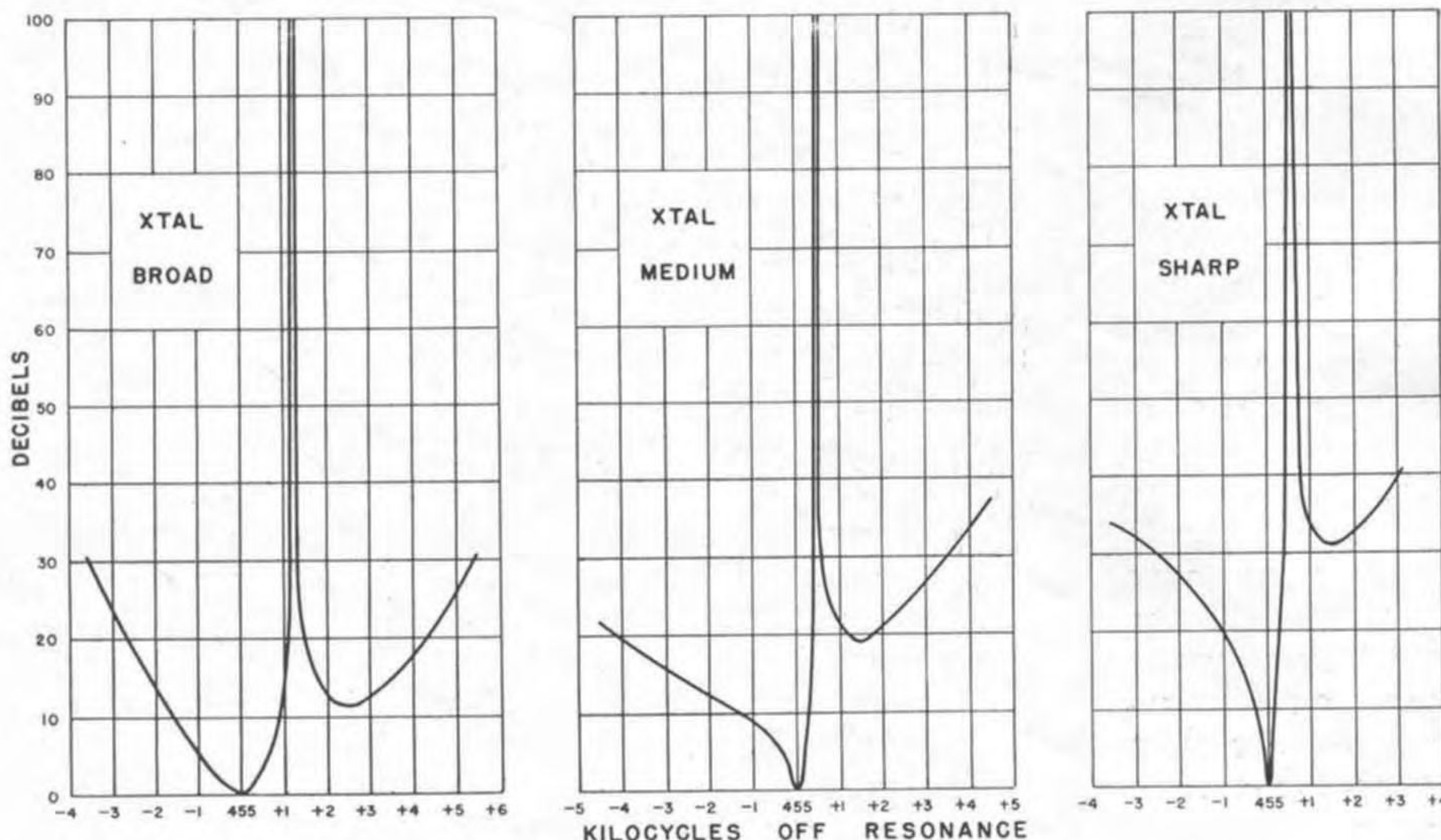

CRYSTAL FILTER CURVES

NOTE: The CRYSTAL FILTER and holder are wired directly into the receiver and do not plug in as heretofore. In this manner exceptional crystal filter action is obtained because of the elimination of the capacity and losses of a socket. So mounting the crystal prevents possible change in polarity which would occur if the crystal were improperly inserted in the circuit. The size of the crystal has been carefully determined to allow the BROAD CRYSTAL position to tune as broadly as possible. The capacity of the crystal holder has been reduced to a minimum through the use of a specially designed polystyrene holder.

NOISE LIMITER

The principle of operation of the limiter is very similar to that of the Lamb limiter which has been described in detail in past issues of Q.S.T. The carrier of the received signal is first converted over to the intermediate frequency and then fed into the 6L7 IF Amplifier and 6B8 AVC and noise amplifier. A broadly tuned IF transformer is used in the plate of the 6B8 with its primary and secondary closely coupled. The secondary feeds into the 6B8 diode where rectification of the carrier furnishes AVC voltage for the RF and mixer tube as well as for the following 6SK7 noise amplifier. The primary of the IF transformer of the 2nd stage of noise amplification is coupled to a center-tapped secondary which feeds a balanced diode detector circuit. This type of diode detector is used because there is considerably less IF frequency component appearing across the common diode load resistor R_{49} . Because of this fact an efficient low pass filter (C_{53} - C_{55} - C_{53}) can be used which allows the passage of the higher audio frequencies without attenuation. In the form of further explanation of our approach toward noise elimination, it must be remembered that noise in general is composed of a random mixture of high and low frequencies. Of this mixture the predominating higher frequencies are the most objectionable. It is to our advantage to retain the high frequency components. Thus, these transients will be allowed to rise to a point far above the carrier level with the result that they will be applied to the injector grid of the 6L7 tube without being reduced in value. Transients, such as ignition interference having a steep wave front, consist largely of high frequency components. The voltage applied to the grid of the 6L7 tube has a negative polarity because of the 6H6 noise rectifier. By varying the ANL control, we raise or lower the negative voltage applied to the 6L7 tube until it is barely sufficient to overcome the noise impulses applied to the grid of this tube without allowing the modulation peaks of the carrier to become badly distorted.

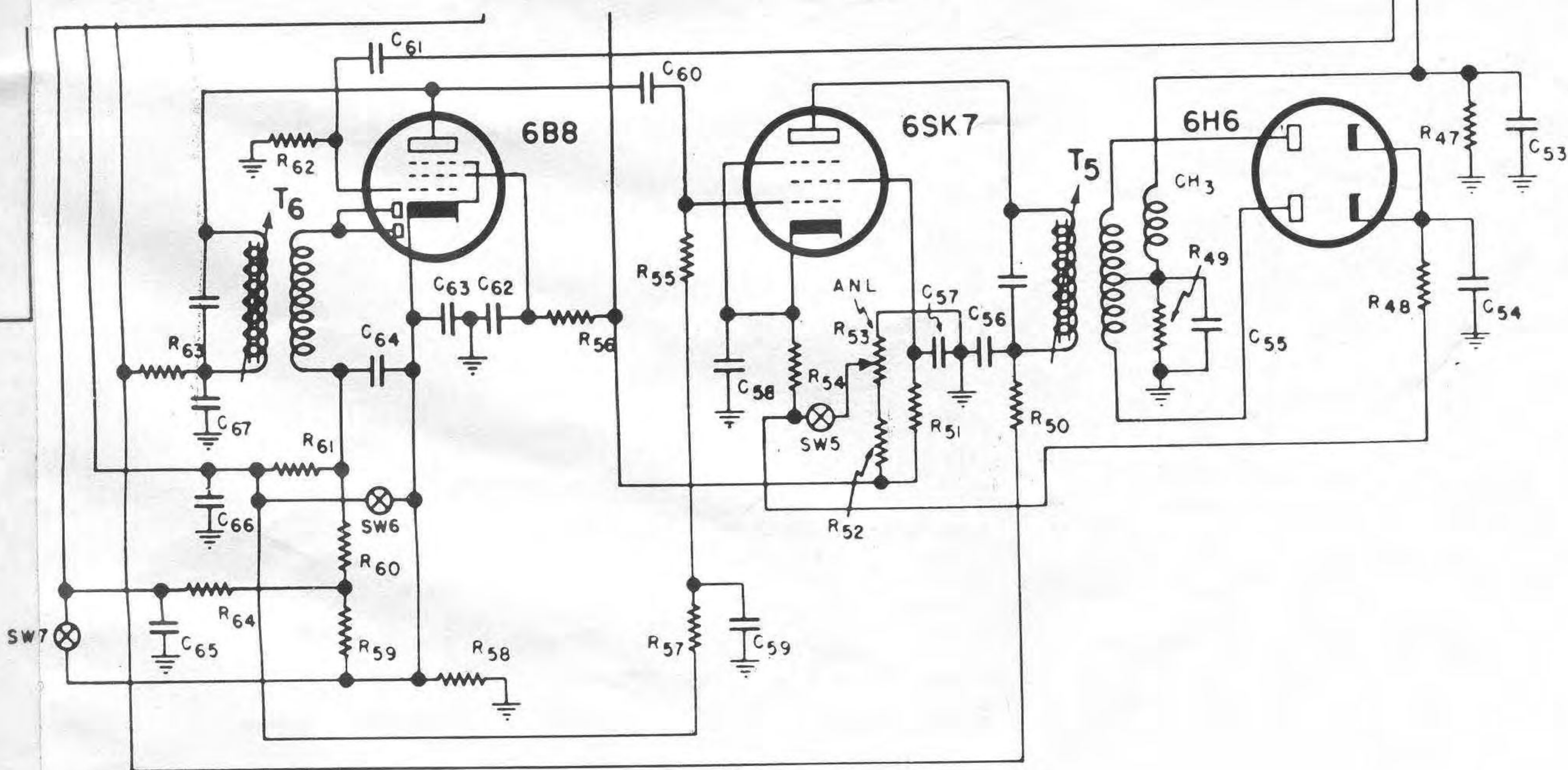
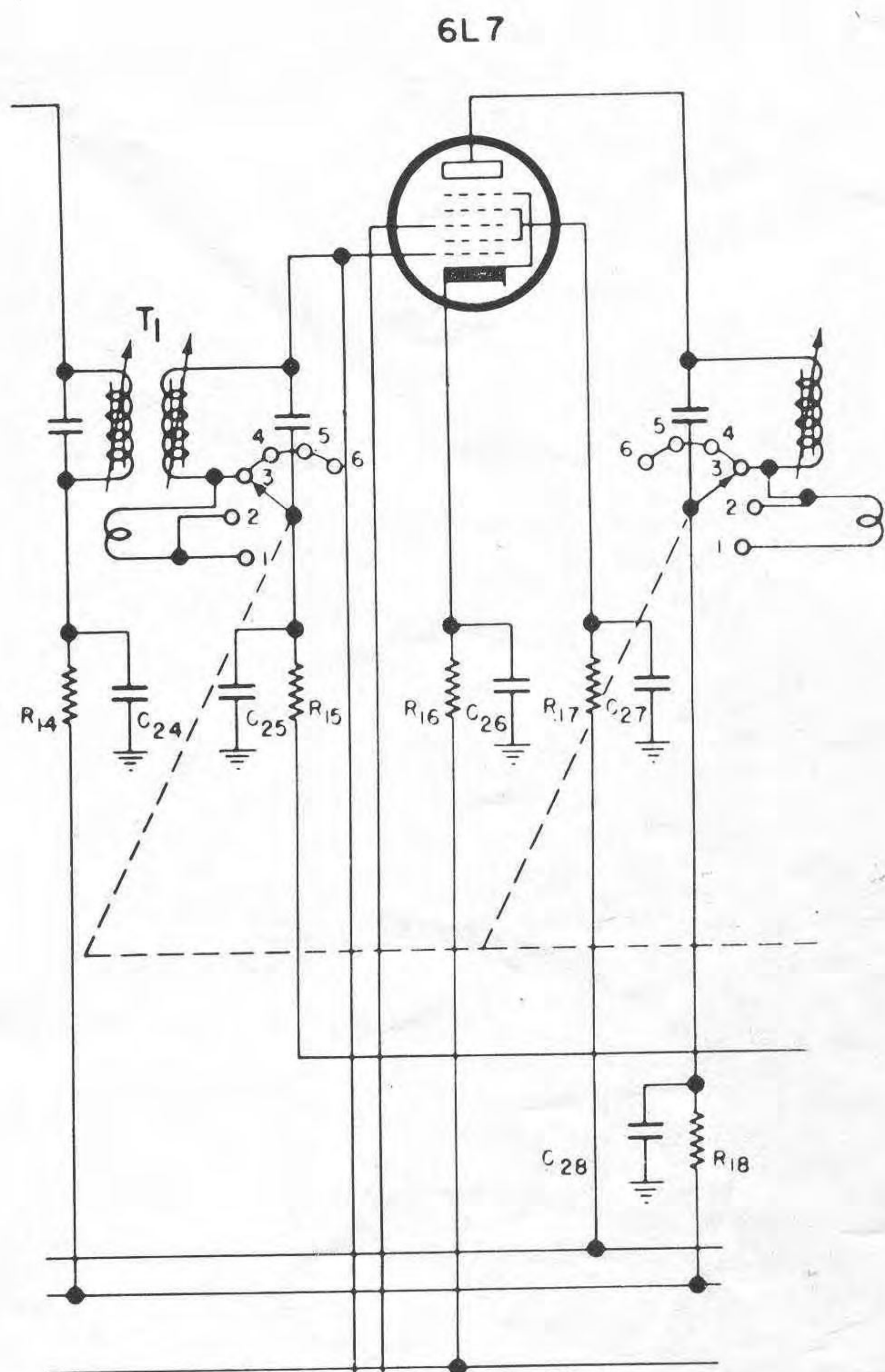

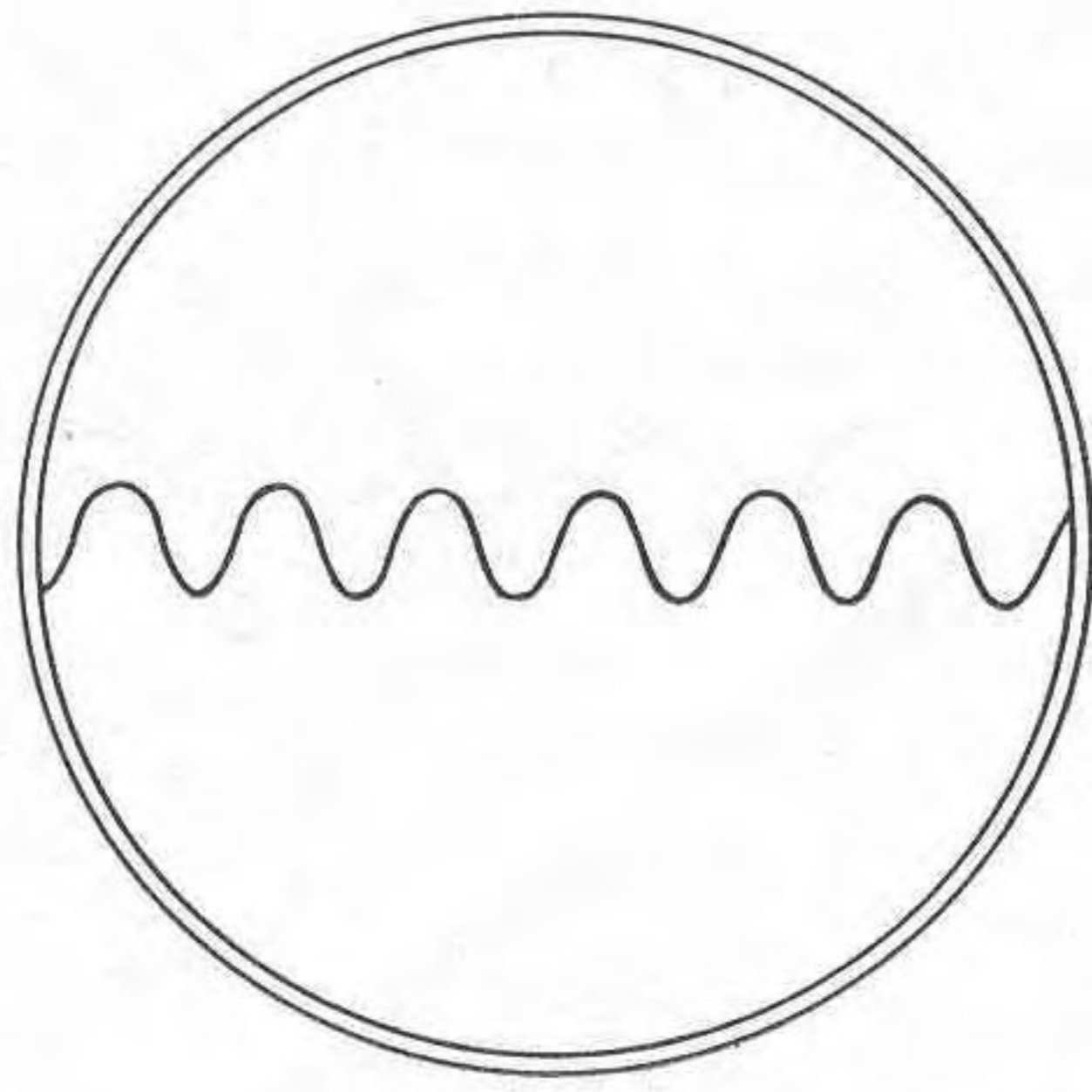

Constant tone signal no interference ANL OFF.

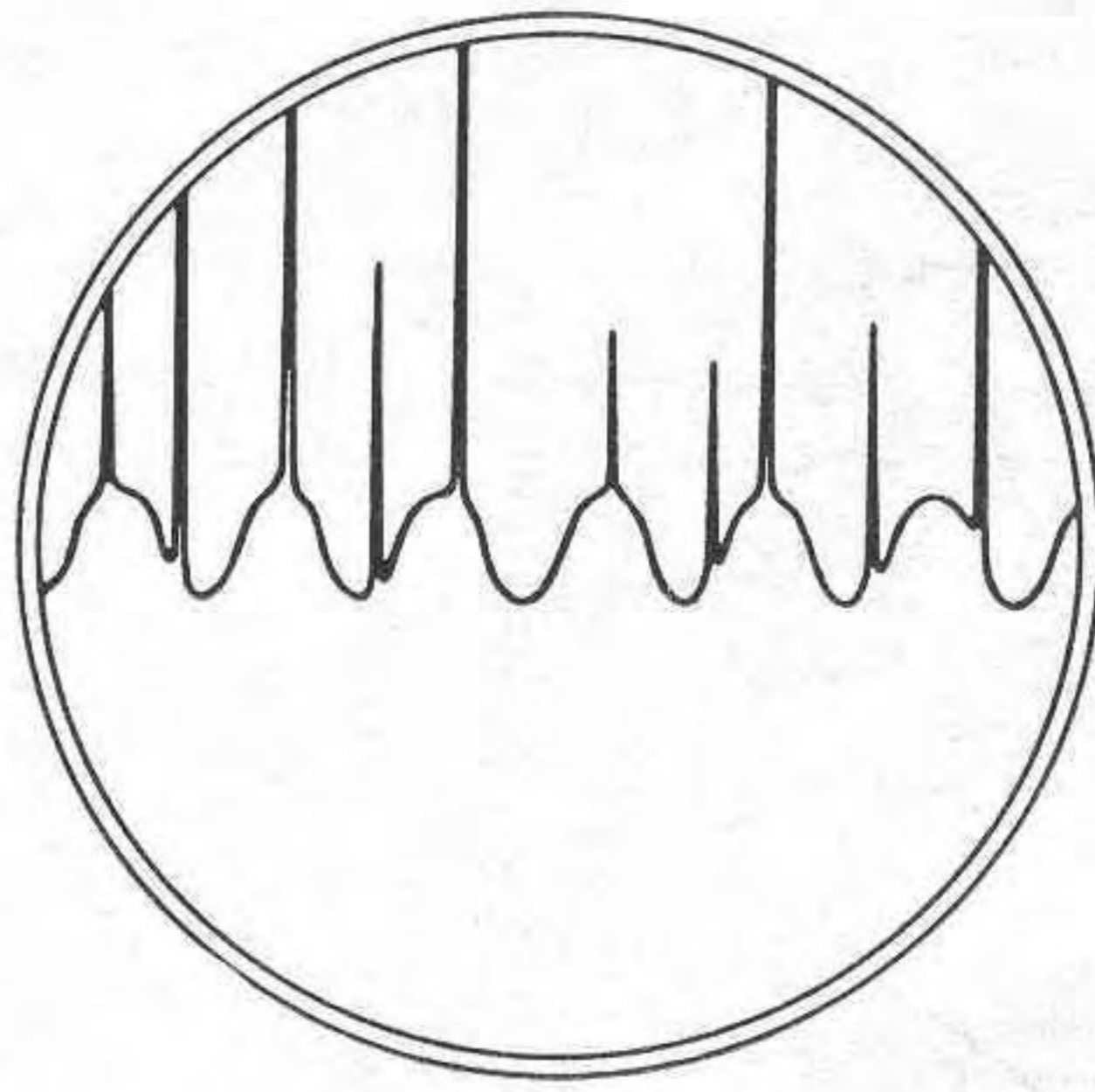

Same Signal ANL OFF. (Note transient peaks extend well beyond range of screen. Signal not readable.)



Same signal. Same noise. ANL-ON adjusted for most favorable signal to noise ratio.

If the noise limiter adjustment permits too great a value of transient voltage to be applied to the 6L7 injector grid, detection will take place and rectified components of this modulated carrier will appear in the 6L7 plate circuit. This effect will appear as distortion in the output of the receiver. If, on the other hand, not enough

noise voltage is applied, then the momentary decrease in sensitivity will not be great enough to stop the noise from getting through and some of it will appear in the plate circuit of the 6L7 tube and consequently in the output of the receiver. As a result the noise limiter must be carefully adjusted to the particular carrier and noise level being received.

A.V.C. CURVE — AT 3 MC.

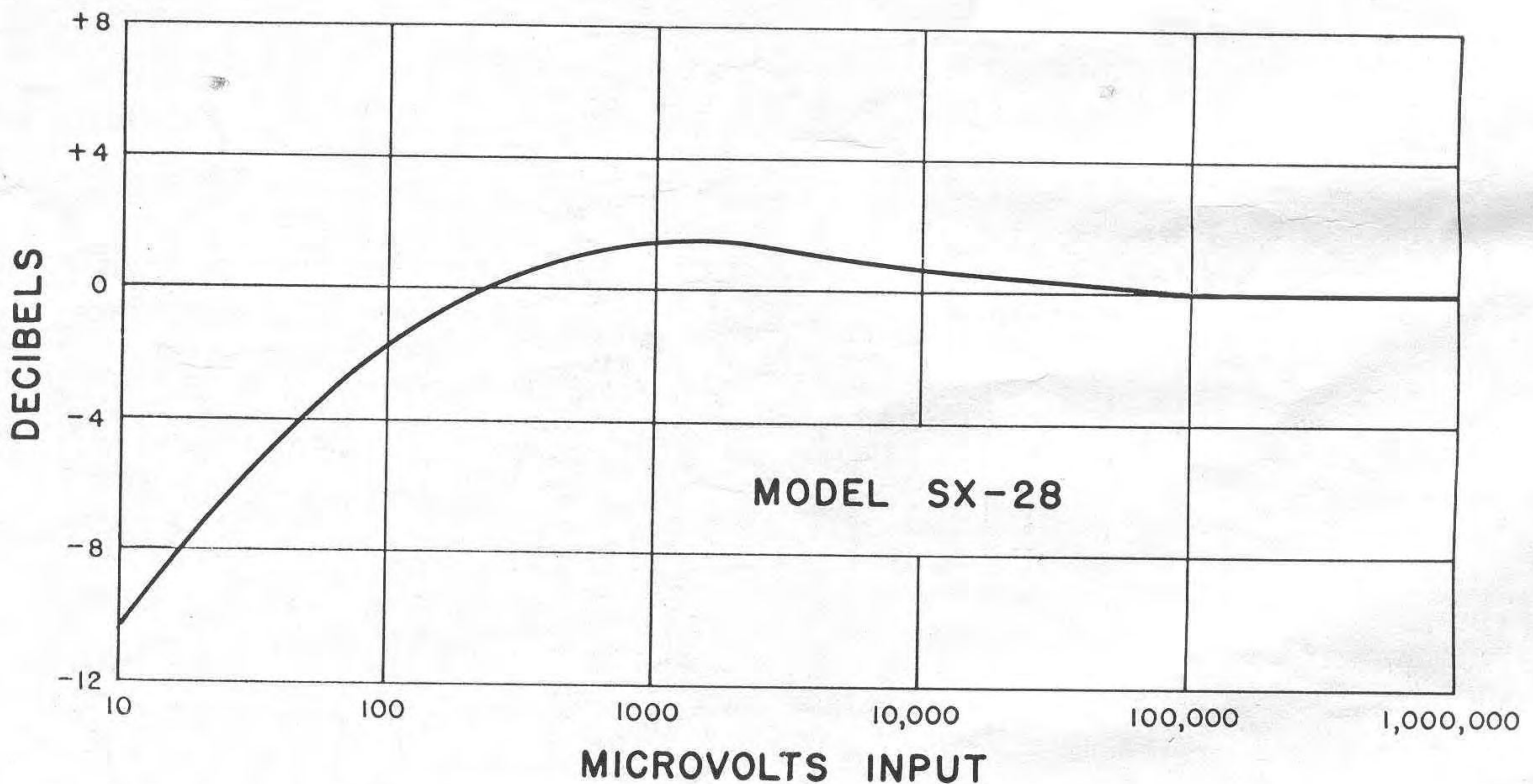

AVC ACTION

A double AVC system is used. The RF and mixer tubes are operated by the broadly tuned carrier coming through only three tuned IF circuits. The final signal however passes through six-tuned IF circuits. As a result, when the signal is slightly detuned, the receiver output has dropped considerably while the AVC action has dropped but very little. This results in a reduction of between-station noise and a more sharply defined aural tuning action.

"S" OR SIGNAL INTENSITY METER

The approximate DB per S unit equivalent is 6 DB's. As is known, a DB, or decibel, is a unit of change in signal level and is defined as being the least detectable change the average ear can appreciate when listening to a single pitched tone. 3DB is the least change the ear detects when listening to sounds varying in both amplitude and pitch. By comparison, a variation of one S unit on the meter will indicate a change of two detectable steps in signal level. Quantitatively, a DB gain or loss is equal to $20 \log_{10} \left(\frac{E_1}{E_2} \right)$ where E_1 = input voltage and E_2 = output voltage.

THE SECOND DETECTOR

As will be noted, a diode type of second detector is used in the Model SX-28. Its choice was prompted by the fact that such a detector is capable of handling large percentages of modulation with very little distortion. This is due to the output of the diode being easily filtered (IF Removed). In addition, the rectified output contains a DC component which can be used for AVC purposes.

THE BEAT FREQUENCY OSCILLATOR

The BFO is turned on with the switch below the band-spread handwheel and adjusted by the skirted knob directly below the tone control. The BFO circuit, as will be seen by referring to the schematic, is the well known Hartley oscillator. It will be noticed that a plate dropping resistor is used to compensate for plate voltage variations. An increase in receiver voltage causes an increase in the plate current of the oscillator. This increase in turn causes the voltage drop across the resistor to increase, thus maintaining a more constant voltage at the plate of the beat oscillator tube. A favorable ratio of capacity to inductance is used. The fixed tank capacity has been artificially aged by alternately exposing it to very high and then low temperatures. In this manner any residual strains of the component parts are removed and the capacity of the condenser remains constant. The BFO coil is permeability tuned which further removes the possibility of drift which would occur should a compression variable be used to resonate the circuit.

Proper location of the Beat Oscillator tube and its associated components plus excellent shielding and mechanical rigidity do much to keep stray fields from being established. Little BFO leakage is to be expected in the Model SX-28 so "tweets" or BFO harmonics will not prove to be bothersome.

THE AUDIO AMPLIFIER

The second or output stage of the audio amplifier in the Model SX-28 receiver uses two 6V6GT tubes connected in push-pull. These tubes are driven by the 6SC7 double triode. One of the triode sections of the 6SC7 tube is used as the inverter to the 6V6GT tubes. A portion of the signal from the plate circuit of the first 6SC7

triode is fed to the grid of the other 6SC7 triode Section, thereby giving two output voltages in opposite phase suitable for exciting the push-pull 6V6GT output amplifier.

THE POWER SUPPLY

The power supply in the Model SX-28 is quite normal except that it supplies voltage for the 6V6GT output tubes directly from the rectifier or before the filter system. Voltage fluctuations in the receiver are greatly reduced—increasing the audio output of the receiver and stabilizing the operation of all circuits.

The filter circuit consisting of a total of 60 mfd's of capacity plus an additional filter in the 6SC7 plate supply and a 12 henry choke keep the hum level of the receiver in excess of 60 DB below maximum output. The power transformer is built to withstand continuous operation at 250 degrees F but has been designed to run at approximately 160 degrees F under normal conditions.

SPECIFICATIONS

Tubes:

1—6SK7	1st RF Amplifier
1—6SK7	2nd RF Amplifier
1—6SA7	Mixer
1—6SA7	HF Oscillator
1—6L7	1st IF Amplifier Noise Limiter
1—6SK7	2nd IF Amplifier
1—6B8	2nd Detector and S meter tube
1—6B8	AVC Amplifier
1—6SK7	Noise Amplifier
1—6H6	Noise Rectifier
1—6J5	Beat Oscillator
1—6SC7	1st Audio Amplifier
2—6V6GT	Push-Pull Output Amplifiers
1—5Z3	Rectifier

Power Consumption—at 117 volts—60 cycles—138 watts
Power Consumption—DC operation—18 amp. at 6 volts or 108 watts

Power Output —8 watts undistorted

Sensitivity—(for .05 watts output) Bands 1 to 5—2 MV and under; 6th band 4 MV

	2 x	1000 x
Selectivity—IF broad (high fidelity)	12 kc	36 kc
IF Sharp	4.1 kc	22 kc

Frequency Range RF—Note: These are the actual frequencies covered corresponding to nominal figures indicated on the front panel.

550	to 1,620 kilocycles
1.5	to 3.1 megacycles
2.9	to 5.9 megacycles
5.75	to 11.5 megacycles
10.3	to 21.5 megacycles
20.4	to 42 megacycles

Frequency response AF (audio filter out broad IF—tone control high—70 to 3000 cycles $\pm 2\frac{1}{2}$ DB

Speaker Output Impedances—5000 and 500 ohms

Intermediate Frequency—455 kc

Table cabinet dimensions—20 $\frac{1}{2}$ " long x 10" high x 14 $\frac{3}{4}$ " deep

Relay Rack dust cover dimensions—14 $\frac{3}{4}$ " deep x 17 $\frac{3}{8}$ " long x 8 $\frac{3}{4}$ " high

Panel dimensions—19" x 8 $\frac{3}{4}$ "

Chassis dimensions—17 $\frac{3}{8}$ " x 13 $\frac{1}{2}$ "

Weight—(unpacked)—75 lbs.—packed 87 lbs.

ALIGNMENT PROCEDURE MODEL SX-28—SUPER SKYRIDER

Equipment Needed for Aligning:

1—An all wave signal generator which will provide an accurately calibrated signal at the test frequencies indicated.

2—Output indicating meter connected to 5000 ohm output terminals.

3—Non-metallic screw driver.

4—Dummy antenna of 200 mmf and also 400 ohm carbon resistor.

Setting of controls prior to alignment—IF and RF.

Tone control at maximum high frequency position (#9)—BFO at 0—Bass switch at Bass IN—AF Gain at #9—RF Gain at #9—Band switch—IF alignment position .55 to 1.6 band—RF alignment depending on band aligned.

Selectivity control at sharp IF—Send-Receive switch in Receive—Crystal phasing at #3 on left side—ANL—OFF at 0—AVC OFF.

Important: Have bandspread control so logging scale reads 100.

Antenna trimmer adjusted for Maximum gain at each RF alignment point on Bands 3-4-5-6.

Note: Antenna trimmer not in circuit on bands 1 and 2.
455 KC—IF Alignment: Tune main dial to 1400 kc on .55 to 1.6 mc band. Connect the hot lead from the signal generator to 6SA7 mixer terminal #8—Ground to chassis. Roughly adjust the aligning screws of T1, the lower screw of which is accessible through hole in right mounting bracket, for maximum gain. Now adjust lower screw on T2 (do not adjust upper screw). Also adjust C31 and the air trimmer condenser at the top of T3 for maximum gain.

Switch to Crystal Broad Position—Turn on BFO and adjust to a tone of about 1000 cycles. Vary the frequency of the signal generator while adjusting the top screw on T2 until the output goes through a maximum, dips down and starts going up again. Adjust the phasing control

for maximum selectivity and then back off the top screw on T2 until the output reaches a minimum value between the two maximum values first noted. The frequency of the signal generator should be varied over a small range while adjusting the top screw of T2. A swishing note, in contrast to the usual sharp crystal tone will be apparent when the correct adjustment has been reached.

Switch to "Xtal Sharp" and adjust C-30 for maximum output while varying signal generator frequency. Two points of maximum output will be noted corresponding to two adjustments of C-30. Either one of these points may be used at which to leave C-30. a sharply peaked tone will result at the correct adjustment.

Switch to "Xtal Medium" and adjust C-29 till the output is midway between the outputs reached while aligning the "Xtal Sharp" and "Xtal Broad" positions. The apparent sharpness of tone should be midway between the "Sharp" and "Broad" positions.

Switch again to "Xtal Sharp" and set the signal generator to exact crystal frequency. Set BFO front panel control to a tone of approximately 1000 cycles. Switch again to "Sharp IF" and carefully realign the IF transformers as earlier described in the first paragraph of these instructions.

BFO Adjustment: Set front panel control to zero—BFO switch ON—Signal Generator tuned to crystal frequency—selectivity switch in IF Sharp position—now, adjust screw on top of T4, after loosening lock nut, to zero best.

Noise Limiter and AVC Amplifier Adjustment: Have the controls set as before except that the AVC switch is now in the ON position. Connect a high resistance type voltmeter across R47 which is connected between terminal #5 of the 6L7 tube and chassis. With the signal generator connected as before and the ANL control turned all the way to the right, or position #9, rotate the adjusting screws on top of T5 and T6 until the DC voltmeter across R47 shows maximum voltage. The output meter used in IF and RF alignment is not used in making these adjustments.

GUARANTEE

This receiver is guaranteed to be free from any defect in workmanship and material that may develop within a period of ninety (90) days from date of purchase, under the terms of the standard guarantee, as designated by the Radio Manufacturers Association. Any part or parts that prove defective within this period will be replaced without charge when subjected to examination at our factory, providing such defect, in our opinion, is due to faulty material or workmanship, and not caused by tampering, abuse or normal wear. All such adjustments to be made FOB the factory.

Should this receiver require any adjustments, your dealer or distributor has complete technical service in-

formation, or the factory will be glad to assist you in any problem direct.

Should it be necessary to return any part or parts to the factory, a "Return Material Permit" must be obtained in advance by first writing the Adjustment Department, who will issue due authorization under the terms of the guarantee.

The Hallicrafters, Inc., reserve the right to make changes in design or add improvements to instruments manufactured by them, without incurring any obligation to install the same in any instrument previously purchased.

All Hallicrafters receivers are built under patents of Radio Corporation of America and Hazeltine Corporation.

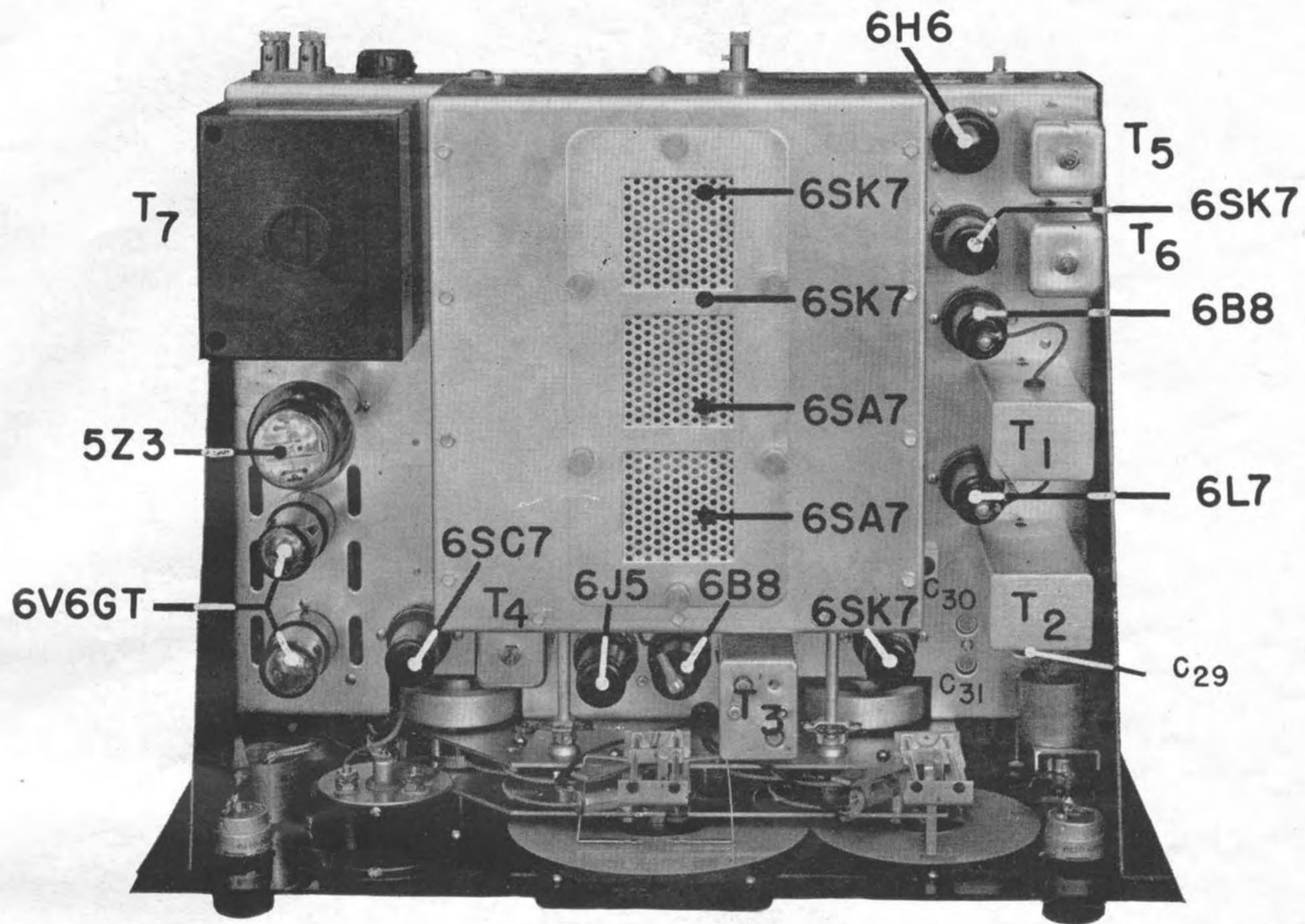

TOP CHASSIS VIEW

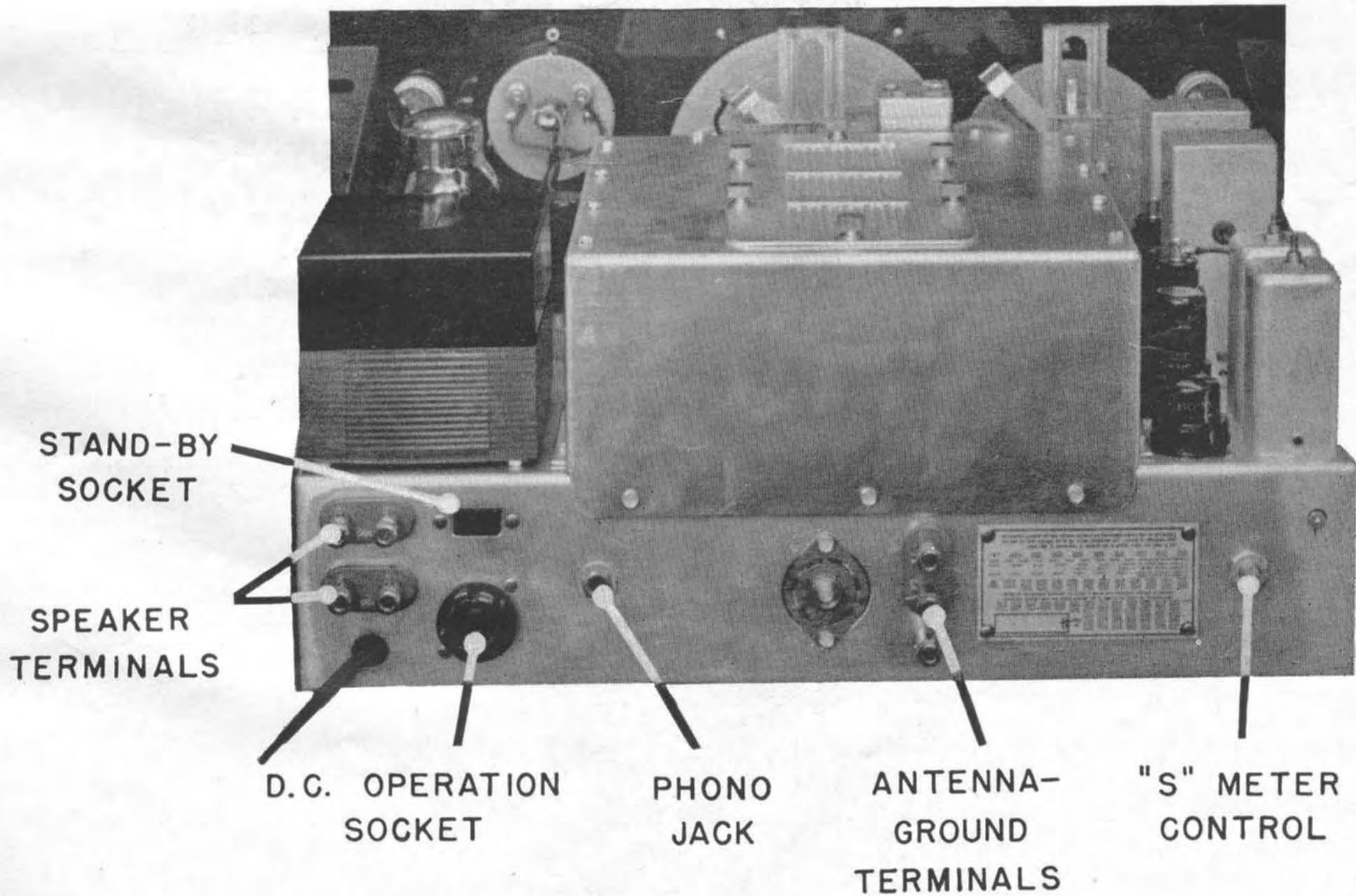

BACK VIEW

AUDIO FIDELITY CURVE

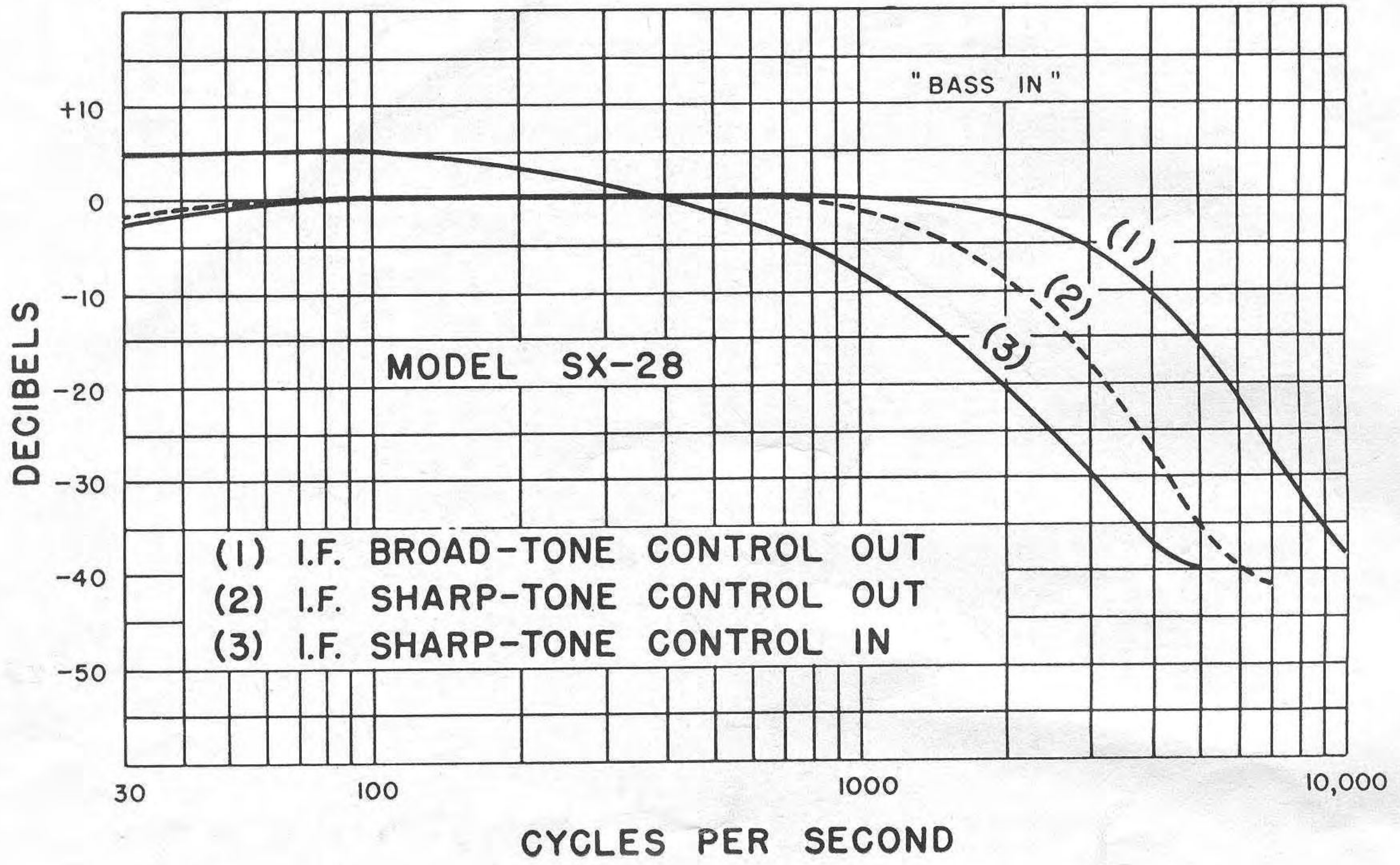

AUDIO FILTER CURVE

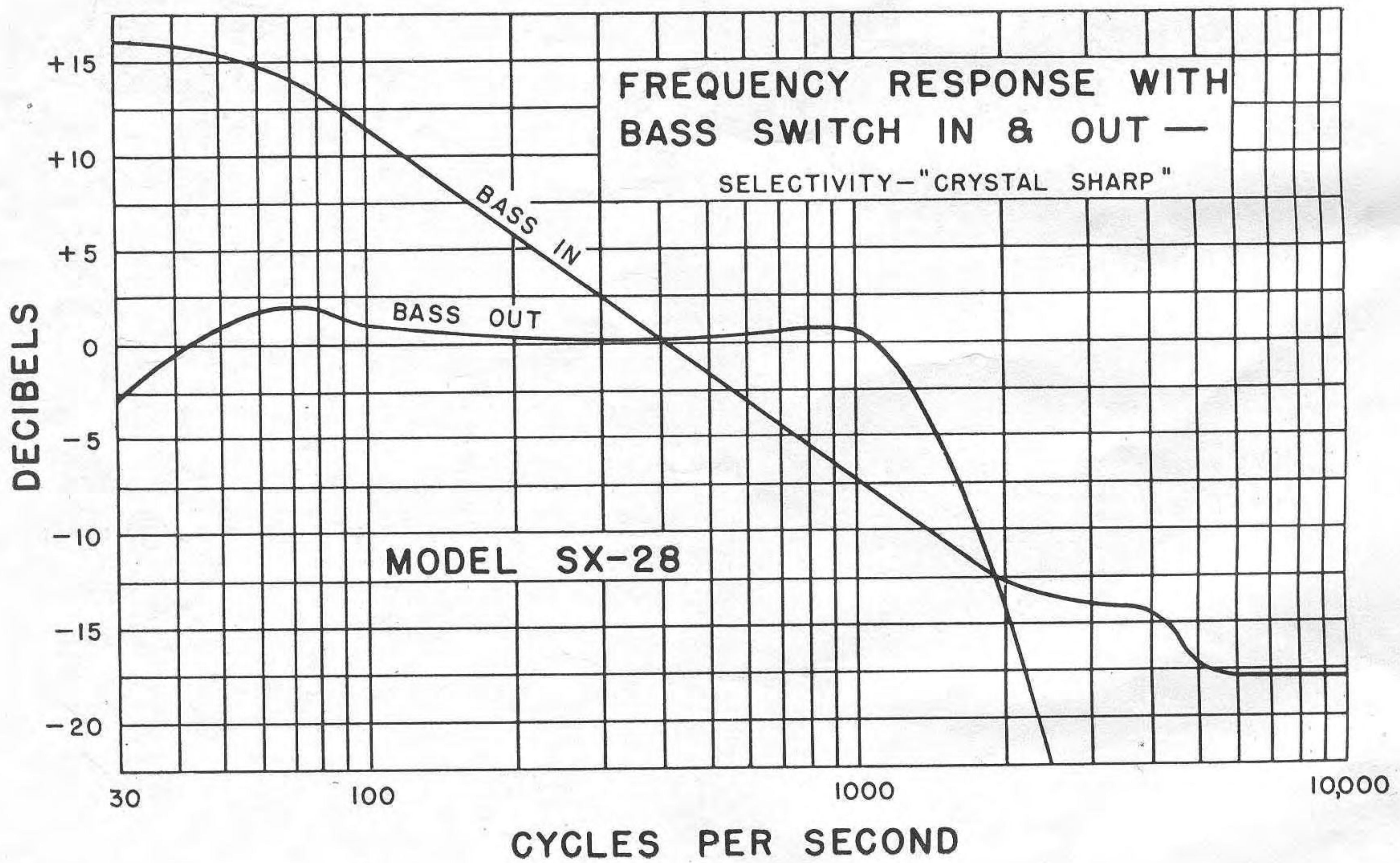

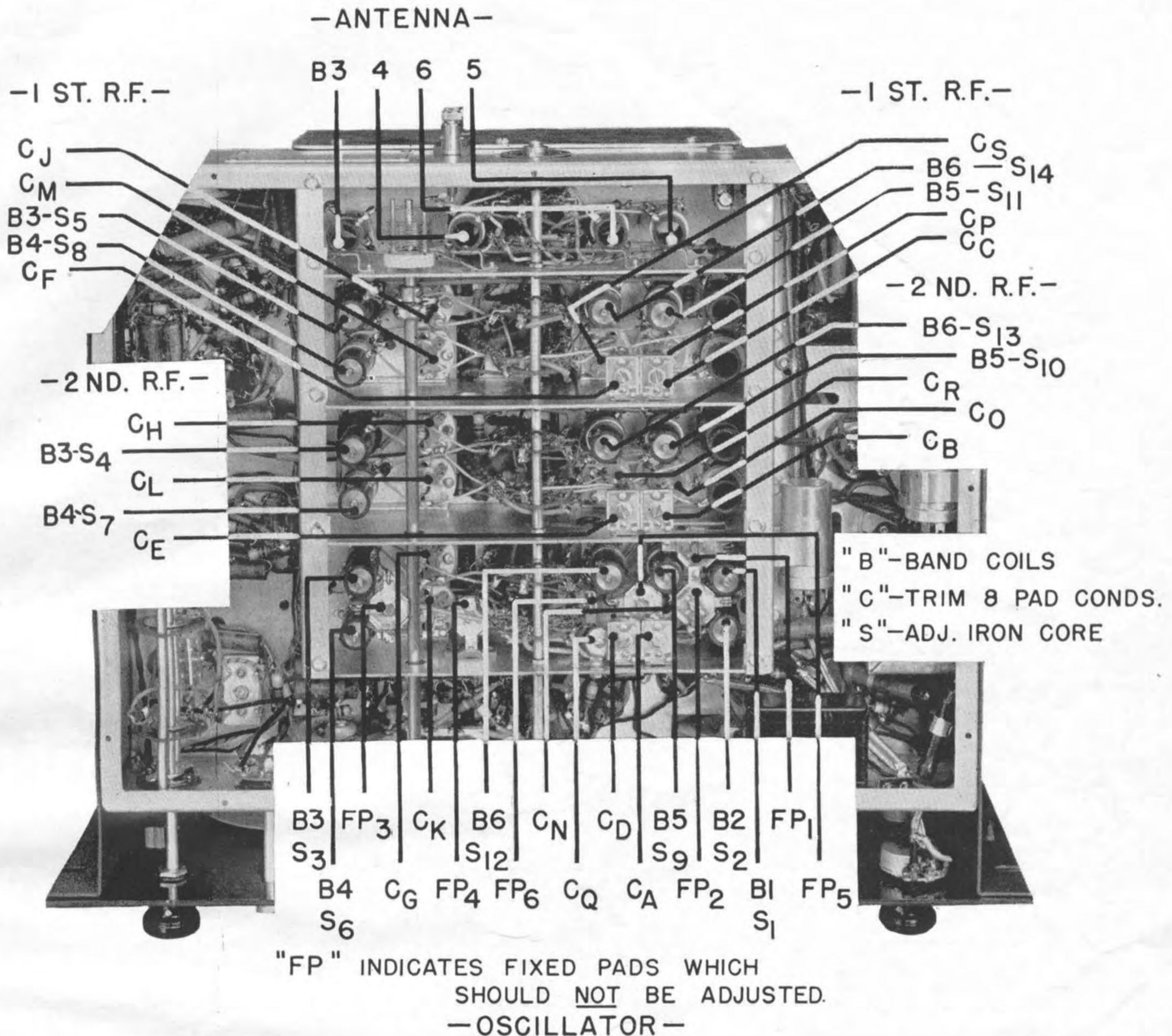

RF ALIGNMENT

Connect hot lead of signal generator to A₁—through dummy antenna shown in table. Leave jumper connected between A₂ and G. Ground of Generator to Chassis.

Band	Rec. Dial Setting	Sig. Gen. Freq.	Dummy Antenna	HIGH FREQUENCY END		LOW FREQUENCY END	
				Adjust Osc. With	Adjust Trimmers for Max. Gain	Adjust Osc. With	Permeability Tuned By
1	1.4 mc	1.4 mc	200 mmf	C _A	C _B C _C
1	.6	.6	200 mmf	S ₁
2	2.8	2.8	400 ohms	C _D	C _E C _F
2	1.6	1.6	400 ohms	S ₂
3	5.6	5.6	400 ohms	C _G	C _H C _J
3	3.2	3.2	400 ohms	S ₃	S ₄ S ₅
4	11	11	400 ohms	C _K	C _L C _M
4	6	6	400 ohms	S ₆	S ₇ S ₈
5	20	20	400 ohms	C _N	C _O C _P
5	11	11	400 ohms	S ₉	S ₁₀ S ₁₁
6	36	36	400 ohms	C _Q	C _R C _S
6	22	22	400 ohms	S ₁₂	S ₁₃ S ₁₄

The following measurements made with a 20,000 ohms per volt meter and taken from the socket terminal indicated to ground or receiver chassis. Antenna and ground were disconnected from the receiver when these measurements were taken and the RF and AF gain controls set at maximum. "DL" means Dead Lug but will indicate voltage when used as a tie. Normal tolerance allows a variation of $\pm 10\%$ from the indicated values.

TUBE	FUNCTION	SOCKET TERMINALS								
		1	2	3	4	5	6	7	8	Cap.
6SK7	RF Amp. (1)	4.15	0.1	4.15	105	6.3	227
6SK7	RF Amp. (2)	4.35	0.1	4.35	105	6.3	279
6SA7	Mixer	250	100	0.12	4.1	6.3
6SA7	HF Osc.	116	116	0.3	...	6.3	116
6L7	IF Amp. (1) Noise Limiter	245	102	6.3	4	-.075
6SK7	IF Amp. 2	4	...	4	107.5	6.3	235
6B8	2nd Det. S Meter Tube	17.2	-.255	-.255	108	6.3	...	-.17
6B8	AVC Amp.	225.5	0.2	0.2	107	6.3	2
6SK7	Noise Amp.	32	.07	32	115	6.3	300
6H6	Noise Rectifier	29.5	...	17.6 DL	6.3	29.5
6J5	Beat Osc.	140	...	-7.4	...	6.3	...	BFO ON ONLY FOR TEST
6SC7	1st Audio Amp.	...	140	137	1.4	6.3
6V6GT	P.P. Audio Amp.	310	290	...	198 DL	6.3	17
6V6GT	P.P. Audio Amp.	310	290	6.3	17
5Z3	Rectifier	320	340 AC	340 AC	320

MODEL SX28 SUPER SKYRIDER CONDENSERS

No.	Value	Voltage or Purpose	Type	No.	Value	Voltage or Purpose	Type
C 1	Band No. 1 Tuning Condenser	C44	10. mfd	300	Electrolytic
C 2	Main Tuning Condenser	C45	.05 mfd	400	Tubular
C 3	3 Plate Bandsread Condenser	C46	.05 mfd	400	Tubular
C 4	4 Plate Bandsread Condenser	C47	40 mfd	25	Electrolytic
C 5	5 Plate Bandsread Condenser	C48	30 mfd	400	Electrolytic
C 6	50 mmf	Variable Air	C49	30 mfd	450	Electrolytic
C 7	2,160 mmf	Band No. 6 Pad	Mica	C50	.02 mfd	400	Tubular
C 8	2,962 mmf	5 Pad	Mica	C51	.01 mfd	600	Tubular
C 9	2,276 mmf	4 Pad	Mica	C52	.01 mfd	600	Tubular
C10	1,600 mmf	3 Pad	Mica	C53	500 mmf	Mica
C11	876 mmf	2 Pad	Mica	C54	.05 mfd	400	Tubular
C12	515 mmf	1 Pad	Mica	C55	50 mmf	Mica
C13	Temperature Compensated	Condenser		C56	.02 mfd	400	Tubular
C14	.02 mfd	400	Tubular	C57	.02 mfd	400	Tubular
C15	.02 mfd	400	Tubular	C58	.05 mfd	200	Tubular
C16	.02 mfd	400	Tubular	C59	.05 mfd	200	Tubular
C17	.05 mfd	200	Tubular	C60	100 mmf	Mica
C18	.02 mfd	400	Tubular	C61	250 mmf	Mica in T ₁
C19	.02 mfd	400	Tubular	C62	.02 mfd	400	Tubular
C20	.02 mfd	400	Tubular	C63	.05 mfd	200	Tubular
C21	.05 mfd	200	Tubular	C64	100 mmf	Mica
C22	.02 mfd	400	Tubular	C65	.02 mfd	400	Tubular
C23	.02 mfd	400	Tubular	C66	.05 mfd	200	Tubular
C24	.02 mfd	400	Tubular	C67	.02 mfd	400	Tubular
C25	.02 mfd	400	Tubular	C68	50 mmf	Mica
C26	.05 mfd	200	Tubular	C69	50 mmf	Mica
C27	.02 mfd	400	Tubular	C70	2000 mmf	Mica
C28	.02 mfd	400	Tubular	C71	100 mmf	Mica
C29	20 mmf	Trimming Condenser		C72	25 mmf	BFO Control	Air
C30	20 mmf	Trimming Condenser		C73	500 mmf	Mica in T ₄
C31	20 mmf	Trimming Condenser		C74	.01 mfd	600	(Braided Leads)
C32	20 mmf	Crystal Phasing	Air	C75	2 mmfd	Twisted Leads
C33	.02 mfd	400	Tubular	C76	2000 mmfd	Mica
C34	.05 mfd	200	Tubular	C77	.05 mfd	200	Tubular
C35	.02 mfd	400	Tubular	C78	10 mmfd	Ceramic
C36	.02 mfd	400	Tubular	C79	5 mmfd	Ceramic
C37	100 mmf	Mica	C80	5 mmfd	Ceramic
C38	100 mmf	Mica	C81	2 mmfd	Twisted Leads
C39	.02 mfd	400	Tubular	C82	10 mmfd	Ceramic
C40	500 mmf	Mica	C83	5 mmfd	Ceramic
C41	10. mfd	25	Electrolytic	C84	5 mmfd	Ceramic
C42	.02 mfd	400	Tubular	C85	2 mmfd	Twisted Leads
C43	5000 mmf	Mica	C86	5 mmfd	Ceramic

MODEL SX28 SUPER SKYRIDER RESISTORS

No.	Value in Ohms	Wattage or Purpose	No.	Value in Ohms	Wattage or Purpose
R 1	100,000	1/3	R34	1,000	1/3
R 2	10,000	RF Gain Control	R35	500,000	Tone Control
R 3	300	1/3	R36	100,000	1/3
R 4	1,000	1/3	R37	100,000	1/3
R 5	3,000	1/3	R38	50,000	1/3
R 6	15,000	1	R39	200,000	1/3
R 7	100,000	1/3	R40	250,000	1/3
R 8	300	1/3	R41	250,000	1/3
R 9	1,000	1/3	R42	200	2
R10	3,000	1/3	R43	20,000	1
R11	100,000	1/3	R44	5,000	10
R12	400	1/3	R45	20,000	1
R13	1,000	1/3	R46	50,000	1/3
R14	3,000	1/3	R47	100,000	1/3
R15	100,000	1/3	R48	100,000	1/3
R16	300	1/3	R49	100,000	1/3
R17	1,000	1/3	R50	3,000	1/3
R18	3,000	1/3	R51	1,000	1/3
R19	100,000	1/3	R52	50,000	1/3
R20	500,000	1/3	R53	50,000	ANL Control
R21	400	1/3	R54	600	1/3
R22	1,000	1/3	R55	500,000	1/3
R23	3,000	1/3	R56	1,000	1/3
R24	50,000	1/3	R57	100,000	1/3
R25	250,000	1/3	R58	200	1/3
R26	250,000	1/3	R59	250,000	1/3
R27	500,000	1/3	R60	250,000	1/3
R28	100	1/3	R61	500,000	1/3
R29	500	"S" Meter Control	R62	500,000	1/3 Inside T ₁
R30	30,000	2	R63	3,000	1/3
R31	11,000	1 1/2 Candohm	R64	500,000	1/3
R32	4,000	7	R65	50,000	1/3
R33	500,000	AF Gain Control	R66	50,000	1/3

the hallicrafters inc

SCHEMATIC DIAGRAM - SUPER SKYRIDER - MODEL SX - 23

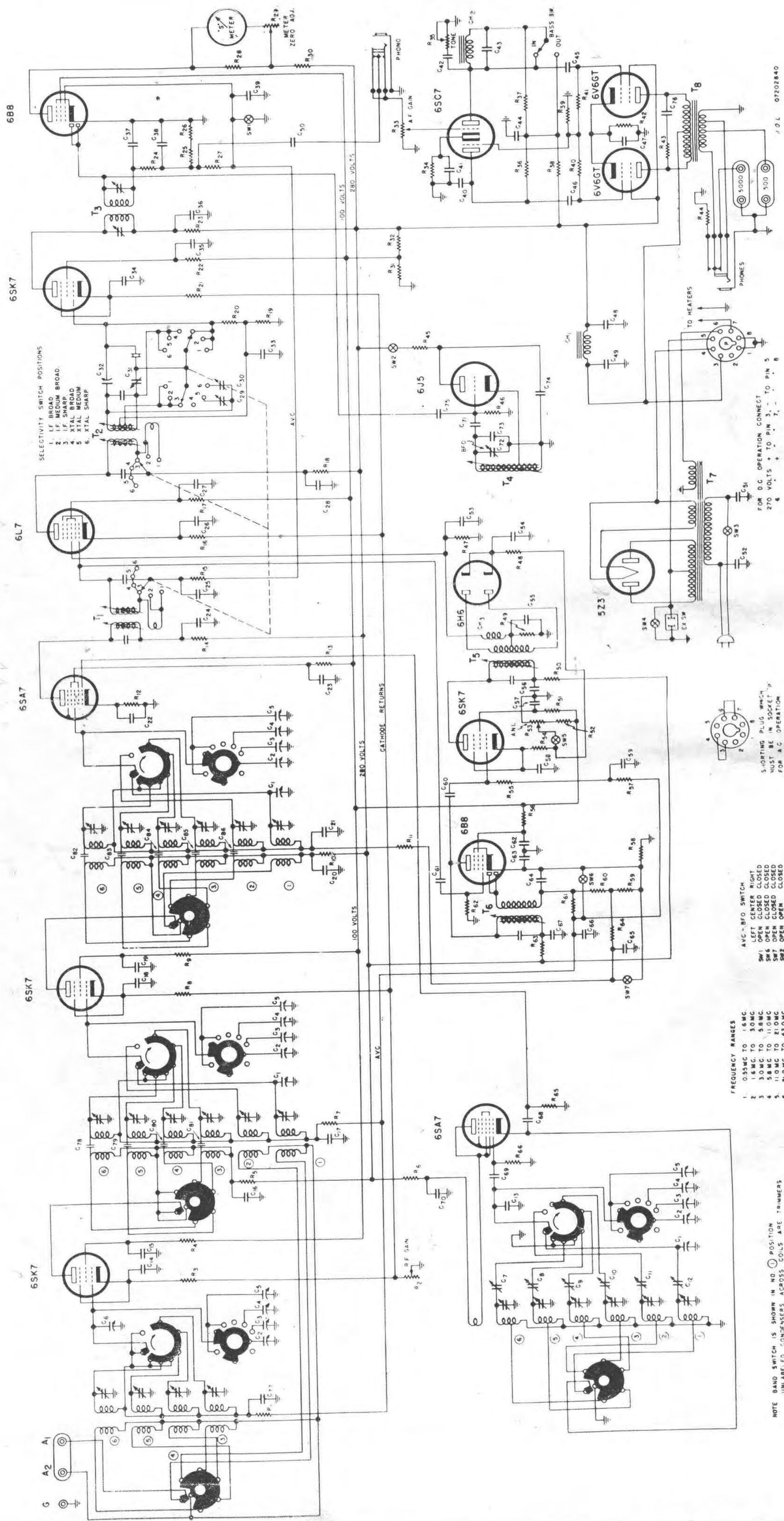

SELECTIVITY SWITCH POSITIONS
 1. IF BROAD
 2. IF MEDIUM BROAD
 3. IF SHARP
 4. XTAL BROAD
 5. XTAL MEDIUM
 6. XTAL SHARP

FREQUENCY RANGES
 1. 0.35MC TO 1.5MC
 2. 1.5MC TO 3.0MC
 3. 3.0MC TO 4.5MC
 4. 4.5MC TO 6.0MC
 5. 6.0MC TO 7.5MC
 6. 7.5MC TO 9.0MC

NOTE BAND SWITCH IS SHOWN IN NO. 1 POSITION
 UNLABELED CONDENSERS ACROSS COILS ARE TRIMMERS

AVC - BFO SWITCH
 LEFT CENTER RIGHT
 SW1 OPEN CLOSED CLOSED
 SW4 OPEN CLOSED CLOSED
 SW7 OPEN CLOSED CLOSED
 SW2 OPEN OPEN

FOR D.C. OPERATION CONNECT
 270 VOLTS + TO PIN 3, - TO PIN 5
 270 VOLTS + TO PIN 7, - TO PIN 8

107 07202840