

**INSTRUCTION MANUAL  
FOR  
MODEL JST-135**



Downloaded by  
RadioAmateur.EU

**JRC**

*Japan Radio Co., Ltd.*

**HF TRANSCEIVER**

Congratulations on your selection of the JST-135 HF transceiver.

It is a high quality transceiver with the latest digital circuits and semiconductors developed from many years of JRC's experiences and achievements in the field of radio communications. Please read through this manual before use.

Your JST-135 has been produced under strict quality control. Should you find any trouble or damage, please contact the nearby JRC branch or dealer as soon as possible.

#### NOTICE

An operation of radio transmitter is usually controlled by an Authority of each country.

Users are kindly requested to note it and operate their radio equipment in such a manner that is legally and socially accepted.

Responsibility for the incidents caused by an operation of a radio station rests with the holder of the license or user.

#### Accessories :

The following accessories are provided with your JST-135.

Please check them after unpacking.

<input type="checkbox"/> Instruction manual .....	1
<input type="checkbox"/> Key plug .....	1
<input type="checkbox"/> Accessory plug (25p) .....	1
<input type="checkbox"/> Fuse (20A) .....	4
<input type="checkbox"/> DC power cable .....	1

We recommend you to keep the curton and interior packing material for unlikely event that it is necessary to send your JST-135 for services or repair.

#### - CONTENTS -

1	FEATURES .....	3
2	SPECIFICATIONS .....	4
3	PRECAUTIONS BEFORE USE .....	5
3.1	Installation Place .....	5
3.2	Connection .....	5
4	OPERATING CONTROLS ON PANEL .....	7
4.1	Front Panel .....	7
4.2	Rear Panel .....	12
5	BASIC OPERATION .....	15
5.1	Cautions on Operation .....	15
5.2	Preliminary Setting .....	15
5.3	Frequency Setting .....	15
5.4	Check before Transmission .....	15
5.5	Operation in the SSB Mode .....	15
5.6	Operation in the CW Mode .....	16
5.7	Operation in the AM Mode .....	16

5.8	Operation in the FM Mode .....	17
5.9	Operation in the AFSK Mode .....	17
6	ADVANCED OPERATION .....	18
6.1	TWO-VFO System .....	18
6.2	Memory Function .....	19
6.3	Interference Eliminating Functions .....	20
6.3.1	NB (noise blanker) .....	20
6.3.2	PBS (pass band shift) .....	20
6.3.3	BWC (bandwidth control) .....	20
6.3.4	NOTCH (notch filter) .....	21
6.3.5	NOTCH (notch follow filter) .....	21
6.3.6	ECSS (exalted carrier selectable sideband) .....	22
6.4	Memory Scan and Sweep Functions .....	22
6.5	Priority Checking Function .....	23
6.6	RIT Function .....	24
6.7	T.F/R.F Function .....	24
6.8	VOX Operation .....	25
6.9	Voice Compressor .....	25
6.10	Break-In Operation .....	25
6.11	Synchronizing Frequency in the CW Mode .....	26
6.12	Repeater Operation .....	26
6.13	Tone Squelch Operation .....	26
6.14	Transceive Operation with an External Receiver .....	27
6.15	Connection with Peripheral Equipment .....	29
6.15.1	Electronic Keyer .....	29
6.15.2	Linear Amplifier .....	29
6.15.3	Separate Receiver and Receiving Antenna .....	29
6.15.4	RTTY .....	30
6.16	Changing the Frequency Step .....	30
6.17	User Definition .....	31
7	MAINTENANCE AND CHECK .....	34
7.1	Adjustment .....	34
7.2	Power-Down to 50W .....	34
7.3	Removal of the Covers .....	35
7.4	Layout of Units .....	35
7.5	Maintenance .....	35
8.	CAUTIONS ON OPERATION .....	37
9.	TROUBLESHOOTING GUIDE .....	38
9.1	Troubleshooting in Reception .....	38
9.2	Troubleshooting in Transmission .....	39
10.	PERIPHERAL EQUIPMENT AND OPTIONS .....	40
10.1	Peripheral Equipment and Options .....	40
10.2	Mounting of Options .....	43
10.2.1	Mounting of units .....	44
10.2.2	Mounting of IF filters .....	44
11.	BLOCK DIAGRAMS .....	45
11.1	Signal Flow .....	45
11.2	Synthesizer System .....	46
12.	CIRCUIT DIAGRAMS .....	47

Parts Identification

(While reading the text, you refer to this page for identification of parts from time to time.)

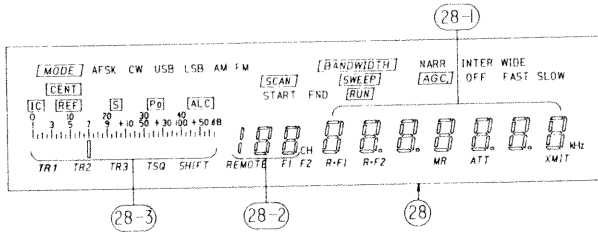
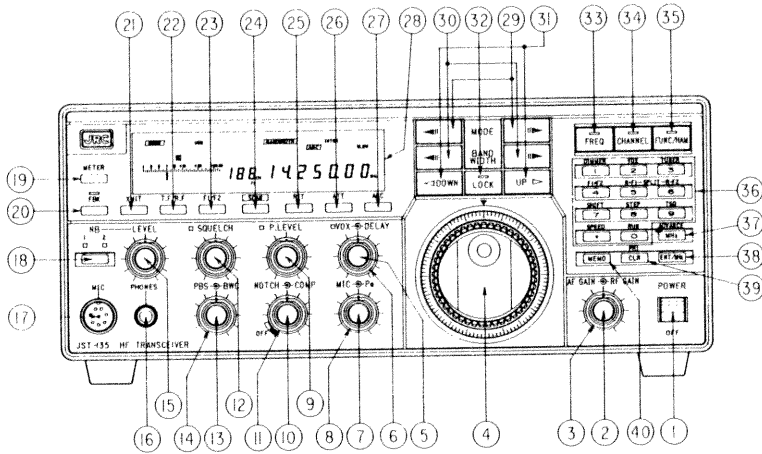

Front Panel

- ① POWER switch
- ② AF GAIN control
- ③ RF GAIN control
- ④ TUNING control
- ⑤ VOX gain control
- ⑥ DELAY (VOX delay) control
- ⑦ MIC (microphone gain) control
- ⑧ Po (power) control
- ⑨ P LEVEL (pause level) control
- ⑩ NOTCH control
- ⑪ COMP (voice compressor) control
- ⑫ SQUELCH control
- ⑬ PBS (pass band shift) control
- ⑭ BWC (bandwidth) control
- ⑮ NB LEVEL (noise blanker level) control
- ⑯ PHONES (headphones) jack
- ⑰ MIC (microphone) connector
- ⑱ NB (noise blanker) control
- ⑲ METER switch
- ⑳ FBK (full-brake-in) switch
- ㉑ XMIT (standby) switch
- ㉒ T.F/R.F (transmit frequency/receive frequency) switch
- ㉓ F1/F2 (VFO select) switch
- ㉔ SCAN switch
- ㉕ RIT (receiver increment tuning) switch
- ㉖ ATT (attenuator) switch
- ㉗ AGC switch
- ㉘ Display
- (28-1) Frequency display
- (28-2) Channel display
- (28-3) Meter
- ㉙ MODE switch
- ㉚ BANDWIDTH switch
- ㉛ UP/DOWN switches
- ㉜ LOCK switch
- ㉝ FREQ (frequency) switch
- ㉞ CHANNEL switch
- ㉟ FUNC/HAM (function/ham band) switch
- ⓪ Ten keys
- ⓫ MHz switch
- ⓬ ENT/kHz (enter/kHz) switch
- ⓭ CLR (clear) switch
- ⓮ MEMO (memory) switch

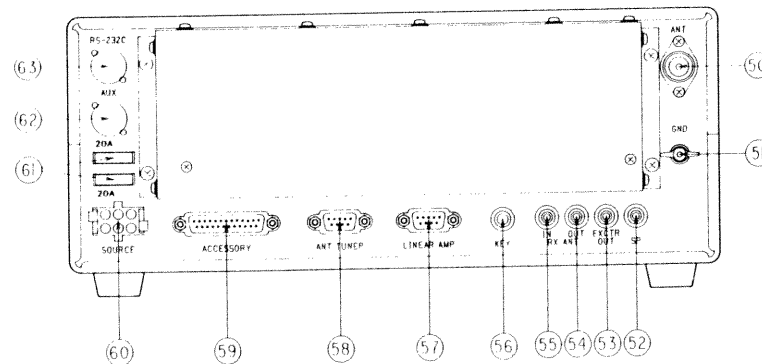

Rear Panel

- ⑤① ANT (antenna) connector
- ⑤② GND (ground) terminal
- ⑤③ SP (external speaker) jack
- ⑤④ EXCTR OUT (exciter output) jack
- ⑤⑤ RX ANT OUT (receiving antenna output) jack
- ⑤⑥ RX ANT IN (receiving antenna input) jack
- ⑤⑦ KEY jack
- ⑤⑧ LINEAR AMP (linear amplifier) connector
- ⑤⑨ ANT TUNER (antenna tuner) connector
- ⑤⑩ ACCESSORY connector
- ⑤⑪ SOURCE (DC power) connector
- ⑤⑫ FUSES (DC fuse)
- ⑤⑬ AUX (auxiliary) connector
- ⑤⑭ RS-232C connector

Downloaded by  
RadioAmateur.EU

# 1. FEATURES

## — Full Pursuit of Basic Performances —

1. **General coverage receiver, All-mode operation**

The transceiver receives the wide frequency range of 100kHz to 30MHz continuously and operates in all modes: LSB, USB, CW, AM, AFSK and 29MHz FM.
2. **Superior receiver performance owing to the variable tuning system**

The variable tuning system, as incorporated in the widely accepted JRC's professional purpose receivers, is employed (the double tuned circuit with capacitor diodes, controlled by a microcomputer). This system reduces undesired signals remarkably and improves the multi-signal characteristics.
3. **Continuous transmission**

This transceiver employs the special heat sink which provides the superior radiating effect even though this is compact and light weight, compared with the usual one. Also, by using a heavy duty power supply, the transceiver can transmit continuously at the full power.
4. **High-speed synthesizer employing one-chip DDS ICs**

The frequency synthesizer is composed of two Phase Locked Loops (PLL) and two Direct Digital Synthesizers (DDS) for high C/N and high-speed response. In the heart of this DDS, specially developed one-chip DDS ICs are employed to simplify the circuit configuration.
5. **Transceive operation with NRD-525**

Transceive operation is available by using the general-coverage receiver NRD-525.
6. **Low-distortion power amplifier**

The transmitter uses a low-distortion power amplifier which employs a large combiner-transformer and new circuits such as the class-A driver stage with the same transistor as that of the final stage, in order to reduce the third- or higher-order intermodulation distortion (IMD). The low-pass filter circuit composed three stage of Chebyshev type suppresses harmonics.
7. **Various Frequency Controls by CPU**

CPU provides various ways of frequency control such as selection of two VFOs, F1 and F2, large capacity memory of 200 channels, memory scan, frequency sweep, etc..
8. **Various interference rejections**
  - BWC (Bandwidth Control) —Option  
Interference signals can be eliminated by narrowing IF filter continuously.
  - PBS (Pass Band Shift)  
Interference signals can be eliminated by shifting the center frequency of the IF filter up or down apparently.
  - NB (Noise Blanker)  
Noise blanker circuit eliminates not only the ignition noise but also woodpecker noise.
  - Notch filter and notch follow filter  
Notch filter eliminates the beat interference adjacent to the desired signal. The notch frequency can be adjusted to follow the interference signal by using the optional notch follow filter unit.
  - ECSS (Exalted Carrier Selectable Sideband) —Option  
When receiving an AM (DBS) signal under an interference from an adjacent channel, its USB or LSB that is not affected by the interference can be picked up, ensuring effective interference rejection and high tone quality.
9. **The full-break-in operation is available in the CW mode in addition to the semi-break-in operation.**
10. **Remote control by personal computer**

The optional RS-232C interface unit allows to control frequency, mode, etc. remotely by an external device (e.g. a personal computer).
11. **Complete modular design**

Complete modular design has been applied and all the plug-in PC boards are inter-connected with the mother board. This structure contributes to unify the quality and to ensure the reliability and easy maintenance.
12. **Optional devices for grading up**

In order to enhance functions of JST-135, Automatic Antenna Tuner NFG-230, Linear Amplifier JRL-1000, etc. are available. Also, optional parts kits such as the various IF filters, high stable reference oscillator kit, etc. are prepared for grading up the performances.

## 2. SPECIFICATIONS

### General

#### Transmitting Frequency Range :

1.8MHz band 1.8 to 2.0MHz  
 3.5MHz band 3.5 to 4.0MHz  
 7MHz band 7.0 to 7.3MHz  
 10MHz band 10.1 to 10.15MHz  
 14MHz band 14.0 to 14.35MHz  
 18MHz band 18.068 to 18.168  
 MHz

21MHz band 21.0 to 21.45MHz  
 24MHz band 24.89 to 24.99MHz  
 28MHz band 28.0 to 29.7MHz

Receiving frequency range : 100kHz to 30MHz

Operating mode : SSB (LSB, USB)

CW

AME (Single Side band with full carrier)

FM

AFSK

Frequency stability : Less than  $\pm 10$ PPM from 5-minute warm-up to 60 minutes  
 Less than  $\pm 2$ PPM per hour after 60 minutes

Frequency increment : 10Hz

Number of memory channels : 200 channels

Antenna impedance : 50 $\Omega$  (unbalanced)

Input voltage : 13.8VDC  $\pm 10\%$  (nominal 13.8V)  
 Negative grounded

Power consumption : Approx. 1.5A (receiving with no signal)  
 Approx. 33A (transmitting at 150W output)

Dimension : 330 (330)W  $\times$  130 (142)H  $\times$  280 (391)

Dmm

Dimensions written in ( ) include projecting parts and controls.

Weight : Approx. 8.5kg

### Transmitter

Power output : 10 to 150W (continuously adjustable)

Carrier suppression : 50dB or more

Undesired sideband

suppression : 60dB or more (at 1.5kHz modulation)

Intermodulation : 3rd order :  $-38$ dB or less  
 Frequency response : 400 to 2600Hz (within 6dB, SSB)  
 Microphone impedance : 600 $\Omega$   
 Modulation system : SSB, AME, AFSK : Balanced modulation  
 FM : Reactance modulation  
 Maximum frequency deviation (FM) :  $\pm 5$ kHz

### Receiver

Receiving system : SSB, CW, AM, AFSK : Triple superheterodyne

FM : Double superheterodyne

Intermediate frequency : 1st IF : 70.455MHz

2nd IF : 455kHz

3rd IF : 98kHz

### Sensitivity :

	SSB, CW, AFSK	AM	FM
0.1-0.5 MHz	14dB $\mu$	24dB $\mu$	—
0.5-1.6 MHz	6dB $\mu$	16dB $\mu$	—
1.6-30 MHz	$-10$ dB $\mu$	6dB $\mu$	$-6$ dB $\mu$

(at 12dB SINAD for FM, at 10dB S/N for other modes)

Image rejection : 70dB or more

IF rejection : 70dB or more

### Selectivity :

	$-6$ dB	$-60$ dB
SSB, CW (W), AFSK (INTER)	2kHz or more	6kHz or less
FM (WIDE)	12kHz or more	—
AM (INTER)	6kHz or more	$-40$ dB, 18kHz or less

Note : Maximum two optional filters can be mounted.

RIT range :  $\pm 20$ kHz

PBS range :  $\pm 1$ kHz

BWC minimum bandwidth : Approx. 800Hz (when mounting optional BWC unit)

NOTCH filter attenuation : Approx. 40dB

AF output : 1W or more (at 4 $\Omega$  load and with less than 10% distortion)

Downloaded by  
**RadioAmateur.EU**

# 3. PRECAUTIONS BEFORE USE

## 3.1 Installation Place

Select a well ventilated area for installation. Avoid areas where the equipment would be exposed to direct sunlight, hot air, dust, vibration, moisture, etc.. Especially great care should be taken to ensure sufficient ventilation for the antenna connector side of the power amplifier unit on the rear panel because it

produces much heat.

## 3.2 Connection

Make basic connections as shown in Fig. 3.1 with the POWER switch ① off on the front panel.

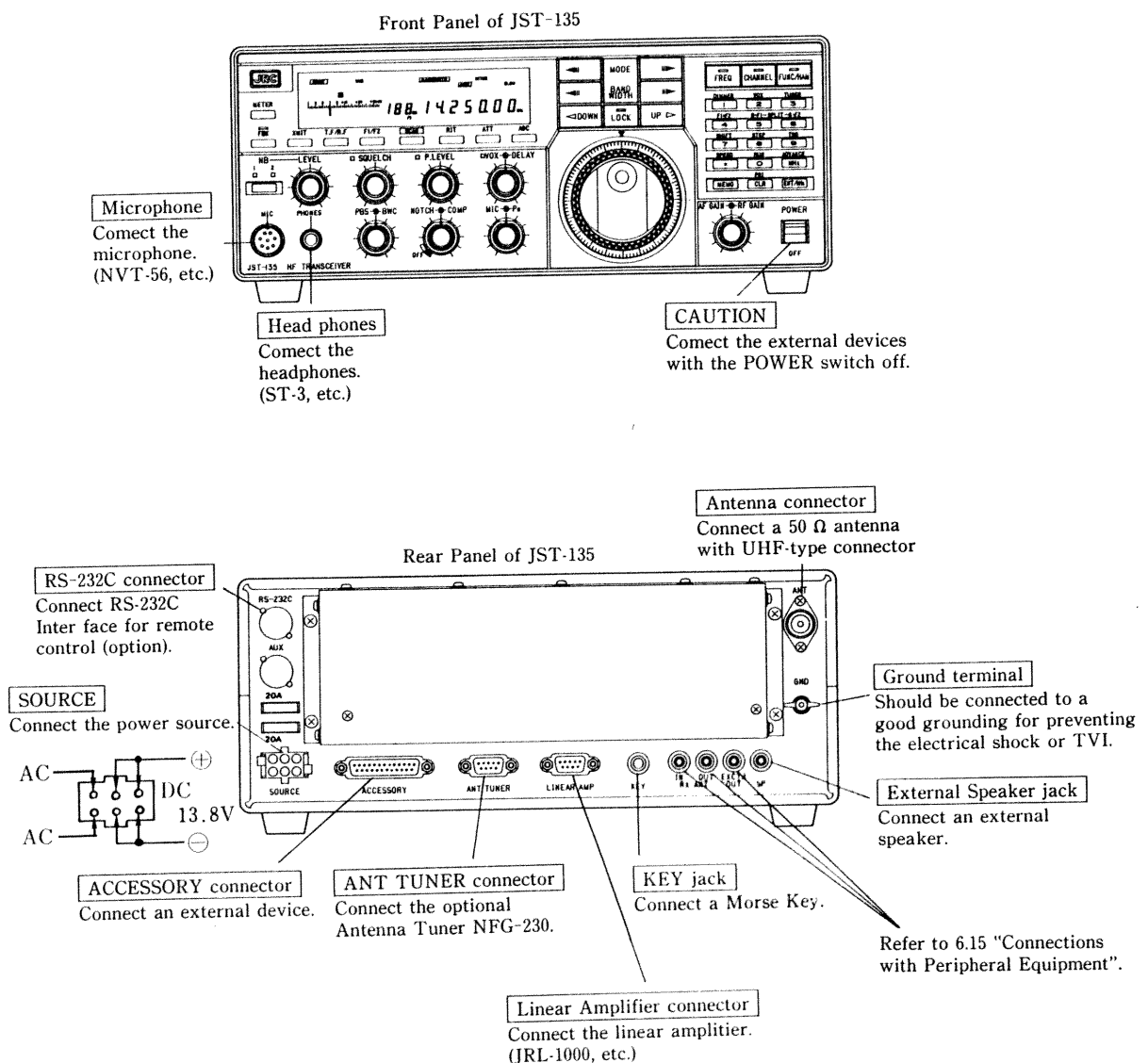

Fig. 3.1 Basic Connections of the Front and Rear Panels

### 3.2.1 Power Supply

JST-135 operates on  $13.8\text{VDC} \pm 10\%$  and requires about 30A current. First, check the voltage and current capacity of the external power source to be connected. Then, connect the equipment to the DC power source by using the supplied DC power cable. For operation on commercial AC power source, the optional power supply NBD-520 is recommended.

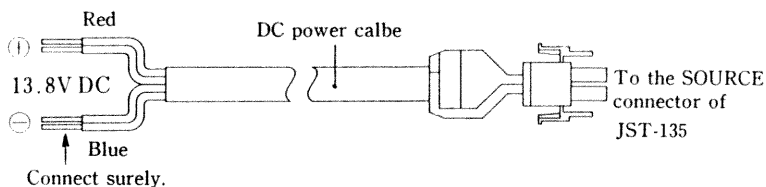

Fig. 3.2 DC power cable connection

### 3.2.2 Antenna

Since the input/output impedance of JST-135 is  $50\Omega$ , the  $50\Omega$  type antenna can be directly connected. If you wish to use other type of antenna, insert an antenna tuner (NFG-97, etc.) between JST-135 and the antenna, and tune it until correct matching is obtained.

If the matching is poor (this means high SWR), the transceiver may not provide the rated power output and moreover, this may cause TVI, BCI, etc..

### 3.2.3 Grounding

Be sure to connect the ground terminal to the ground for preventing electrical shocks and the interferences to TV, radio or other equipment. Connect the ground terminal of JST-135 and those of other related devices such as power supply unit, etc., and also connect to the ground by using a thick copper wire, copper braided wire or copper tape, etc. with the shortest run.

Never connect the ground wire to any gas pipe or cable duct. Also, there is a case where a water pipe is not grounded. Thus, we recommend you to perform grounding work exclusively.

### 3.2.4 Microphone Connection

Fig. 3.3 shows the microphone connection. When the optional microphone NVT-58 with the UP/DOWN switches is to be used, the frequency can be controlled with the UP/DOWN switches on the microphone. If you use a microphone other than the optional one, use the dynamic-type microphone which has impedance of  $600\Omega$  and sensitivity of  $-70\text{dB}$  ( $0\text{dB}$ :  $1\text{V}/\mu\text{BAR}$  at  $1000\text{Hz}$ ) or more. Also, use the FM-14-8P microphone connector (manufactured by Fuji Seimitsu, Co., Ltd.) or equivalent one.

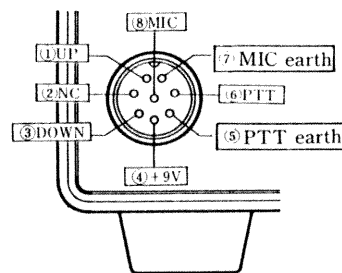

Fig. 3.3 MIC connector (seen from the front panel)

### 3.2.5 Key Connection

For CW operation, insert a Morse key to the KEY jack on the rear panel. Connect the supplied plug and a Morse key as shown in Fig. 3.4.

When using an electronic keyer, etc., use the plus keying type with low resistance at keying down.

#### CAUTION

Do not apply excessively high voltage or negative voltage to the CW keying circuit, because it operates on TTL level of +5V system.



Fig. 3.4 Key connection

### 3.2.6 Speaker Connection

Since the JST-135 is equipped with a speaker, it can be used without an external speaker. However, for better sound quality and higher sound volume, we recommend the optional external speaker NVA-88.

When using any other speaker, select the one having an impedance of 4 to 8 ohms and maximum input of 3 to 5W.

### 3.2.7 Headphones Connection

We recommend the ST-3 headphones designed specially for communication (manufactured by JRC). Also, the stereophonic headphones can be used.

### 3.2.8 Other Connection

As for connection of peripheral equipment such as linear amplifier, etc., refer to 6.15 "Connections with Peripheral Equipment."

# 4. OPERATING CONTROLS ON PANEL

## 4.1 Front Panel

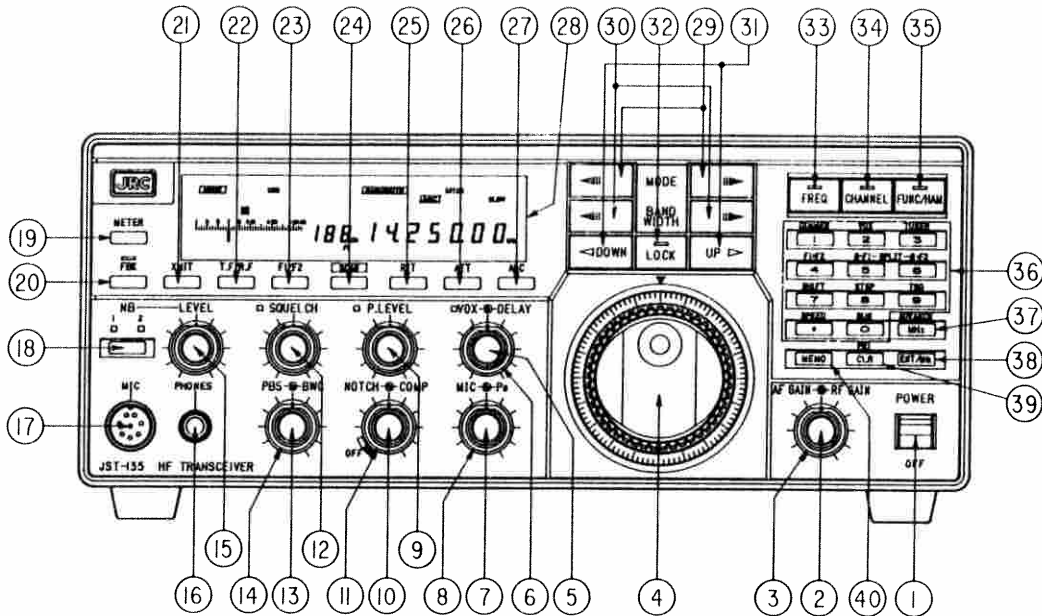

Fig. 4.1 Front Panel Controls

### ①POWER switch

Switches ON-OFF the power of JST-135. When using NBD-520 external power supply, this switch also turns ON-OFF the power supply remotely.

### ②AF GAIN control

Adjusts the sound volume. As turning the control clockwise, the volume increases.

### ③RF GAIN control

Adjusts the gain of 1st, 2nd and 3rd IF amplifiers. At the fully clockwise position, the maximum gain is provided. As rotating the control counterclockwise, the IF amplifier gain is reduced. At the same time, the S-meter starts to deflect. At the S9 position of the S-meter indication, the total gain of IF amplifier is reduced by about 40dB. At the fully counterclockwise position, the gain is reduced more, and neither the received signal nor noise can be heard. Also, at this time, the S-meter indicates the full scale.

When receiving the comparatively strong signal, adjust this control so that the S-meter indicates almost the same or a little less reading on the signal. As the result of the above adjustment, the noise will be reduced and the signal can be heard clearly. Usually, set this control at the fully clockwise position for receiving weak signals.

### ④TUNING control

Sets the operating frequency in 10Hz steps. As rotating the control clockwise, the frequency is increased. When RIT switch is on, this functions as the RIT control.

### ⑤VOX gain control

Adjusts the gain of VOX amplifier at VOX operation (where transmission and reception are automatically switched by the voice input). As rotating this control clockwise, the VOX gain is increased. Adjust the gain according to the microphone sensitivity in use.

### ⑥DELAY control

Adjusts the delay time from transmission to reception at VOX operation. As rotating this control clockwise, the delay time becomes longer. Adjust it for the best operation. Also, this control functions similarly at the semi-break-in operation in the CW mode.

### ⑦MIC (microphone) gain control

Adjusts the microphone amplifier gain. As rotating this control clockwise, the gain is increased. Adjust this control in SSB and AM mode so that the ALC meter pointer may not deflect in the red zone. In the FM mode, normally set this control to the center position.

### ⑧Po (power) control

Adjusts the transmitting output power. At the fully clockwise



position, the power becomes the rated output. As rotating counterclockwise, the output power is gradually reduced. Set it to the desired position. This control functions in all modes.

⑨P LEVEL (pause level) control

Functions as the pause level control during the memory scan or sweep and adjusts the automatic pausing signal level. As rotating clockwise, the pause level is reduced and memory scan or sweep stops at the weak input signal. During pause, the LED placed at the left over P LEVEL control lights up.

Note

When AGC is OFF, the P LEVEL control becomes inoperative and automatic pause is not activated.

⑩NOTCH control

Adjusts the notch frequency. When the received signal is beat-interfered by carrier or CW signal, set this control to the ON position by rotating clockwise and adjust it so that the beat interference becomes minimum.

In case your JST-135 is fitted with optional notch follow unit (CDD-366), the notch frequency tracks the interference signal automatically while fine tuning up to  $\pm 10\text{kHz}$  is made with TUNING control ④.

Note

The received signal may be degraded when the notch control is set to ON. Therefore, set this control to the fully counterclockwise position (OFF) unless it is needed.

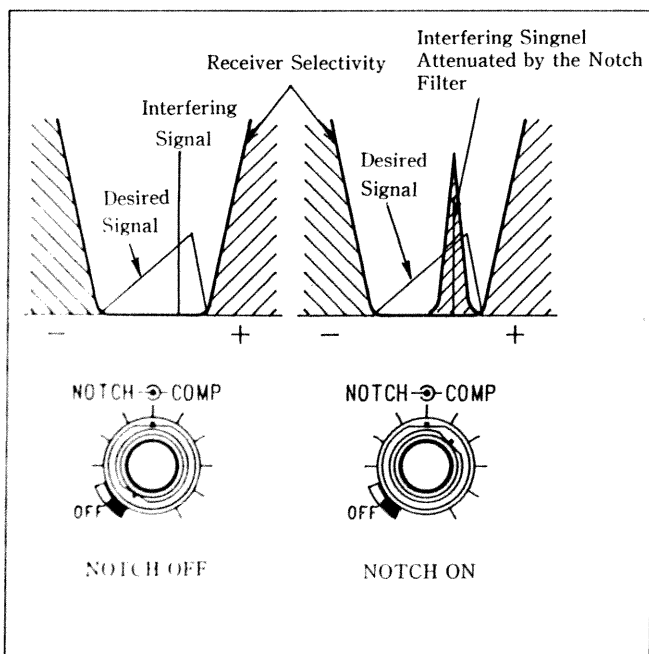

Fig. 4.2 Notch Filter Operation (in the USB mode)

⑪COMP (voice compressor) control

Adjusts the input level of the compressor circuit which increase the talk power in transmission. As rotating clockwise, the compression becomes larger. However, note that the sound quality is deteriorated with the excessive compression. When turned fully counterclockwise, the compressor becomes off.

⑫SQUELCH control

Adjusts the squelch threshold level, which mutes the audio output when no signal is received. As the SQUELCH control is turned clockwise from the off position, the squelch threshold level increases. This control works in any mode. When the squelch is closed, the LED placed on the left above the SQUELCH control lights up.

Note

The SQUELCH control does not function while AGC is OFF except in the FM mode.

⑬PBS (pass band shift) control

Apparently varies the center frequency of the IF filter continuously up to  $\pm 1\text{kHz}$  without changing the receiving frequency. This function eliminates the interfering adjacent signal by means of the filter edge when the receiving signal is interfered by the adjacent signal. When this control is rotated counterclockwise from the center position in the USB mode, the adjacent interference of higher frequency is eliminated. Please note that higher frequency part of received signal is also eliminated. The PBS works similarly in the CW and AFSK modes. In the LSB mode, the above frequency relationships are reversed.

Note

Set the control to the center position unless PBS function is required.

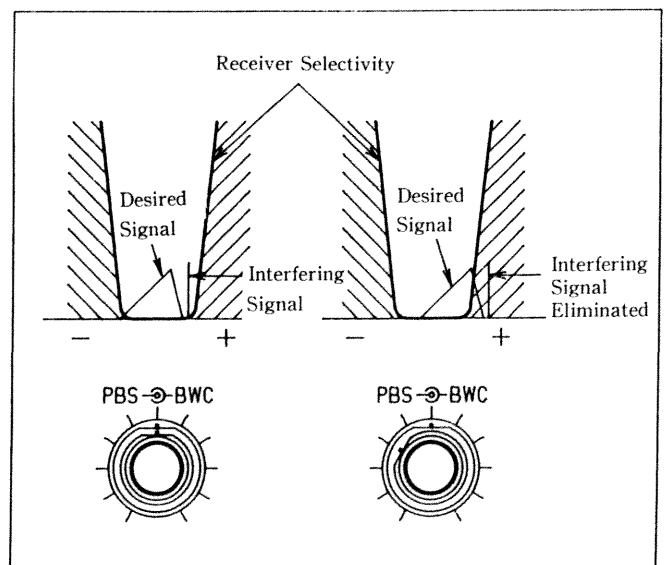

Fig. 4.3 Pass Band Shift Operation (in the USB mode)

#### ⑭BWC (bandwidth) control

BWC is valid when your JST-135 is fitted with optional BWC unit (CFL-243). It varies the pass-bandwidth of the receiver part without changing the center frequency of the pass band. As rotating clockwise, the pass bandwidth becomes narrow. Normally set this control to the fully counterclockwise position. This works in the USB, LSB and CW modes.

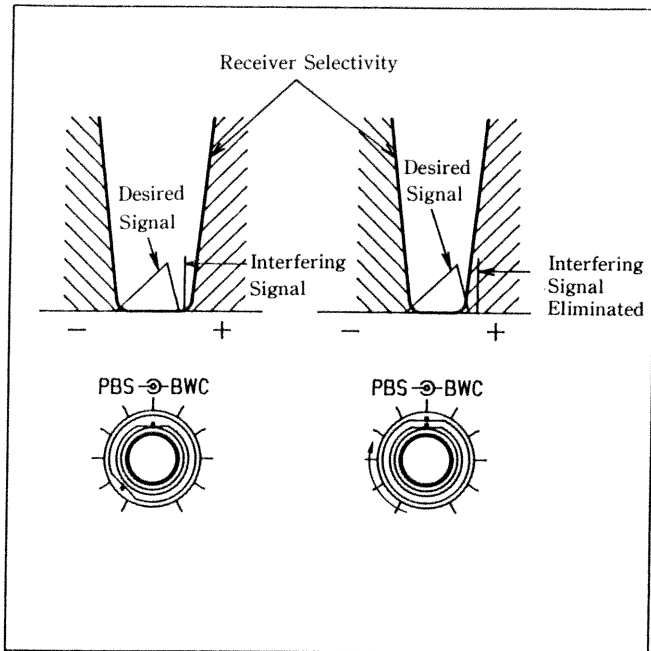

Fig. 4.4 Bandwidth Control Operation

#### ⑮NB LEVEL (noise blanker level)

Adjusts the threshold level of the noise blanker. When pulse noise interferes, set the NB switch ⑮ to ON and adjust this NB LEVEL control for eliminating noise. Adjust it for the best operation suited to the signal strength, type and level of the noise.

#### Note

Rotating the control too clockwise may deteriorate the desired signal quality.

#### ⑯PHONES (headphones) jack

Output jack for headphones. Stereophonic headphones can be used without modification. When using headphones, both internal and external speakers are automatically disconnected.

#### ⑰MIC (microphone) connector

Connector for a microphone. We recommend to use the NVT-56, NVT-57 or NVT-58 microphone. When using other microphone, refer to Paragraph 3.2.4.

#### ⑱NB (noise blanker) switch

Activates the noise blanker. The JST-135 is equipped with two "ON" positions for the noise blanker, OFF, ON (Position 1) or ON (Position 2). They are cyclically selected by this switch.

Position 1 is for ignition noise from cars, and Position 2 is for wide pulse noise like "woodpecker" noise. Selected position is indicated by the LED placed above this switch. The threshold level of the noise blanker can be adjusted by the NB LEVEL control ⑮.

#### ⑲METER switch

Selects the check meter indication during transmission. The meter (28-3) normally indicates the signal strength (S) during reception. In the FM mode, this meter can indicate the frequency center.

#### ⑳FBK (full break-in) switch

Selects either FULL (full break-in) or SEMI (semi break-in) in the CW operation. During the full break-in operation, the LED above the switch lights up.

#### ㉑XMIT (standby) switch

Changes over the transmission and reception. During transmission, XMIT indicator on the Display ㉒ lights up.

#### ㉒T.F/R.F switch

Apparent two VFOs are provided in JST-135 (actually a synthesizer and frequency memory do it). While pressed and held, VFO frequency not in-use is displayed on (28-1), and the frequency can be changed by TUNING control ④.

#### ㉓F1/F2 (VFO selector) switch

Alternately selects VFO-F1 or VFO-F2. The selected VFO is indicated by F1 or F2 indicator on the Display ㉔.

#### ㉔SCAN switch

Alternately selects the START or END channel or frequency for the memory scan or sweep (program scan). To execute memory scan or sweep, press the  $\frac{RUN}{0}$  switch. The selected conditions are indicated on the Display ㉔.

#### ㉕RIT (receiver increment tuning) switch

Enables the RIT function. When switched on, the TUNING control ④ operates as the RIT control and changes the receiving frequency by maximum  $\pm 10\text{kHz}$ . The RIT frequency is displayed on the frequency display (28-1).

#### ㉖ATT (attenuator) switch

Turns on and off the receiver front end attenuator (approx. 20dB). Set this switch to ON for better reception in case the desired signal is blocked by the strong unwanted signal or affected by the intermodulation interference. When the attenuator is on, the ATT indicator on the Display ㉗ lights up.

#### ㉗AGC switch

Cyclically selects the AGC condition, OFF, time constant-FAST or SLOW. Generally, they are selected in the following manner:

- AGC SLOW: Generally used in the SSB mode. When receiving the relatively strong signal, the noise during pauses of the

speech is suppressed to be heard clearly.

- **AGC FAST** : Generally used in the CW mode. When receiving the strong and weak signals in turn, the receiver gain quickly recovers to receive the weak signal sent after the strong signal. Thus, the weak signal can be clearly heard without losing the beginning of message.
- **AGC OFF** : Generally used in the reception of relatively weak signal. In this position, the S-meter does not read at all. When strong signal is received, adjust the RF GAIN control 3 counter-clockwise to obtain the good sound quality.

**28 Display**

A large fluorescent display is used to indicate the items illustrated below.

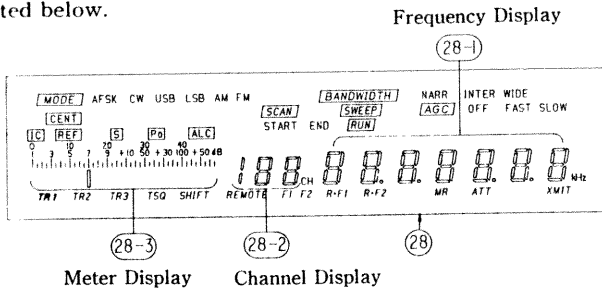

- (28-1) **Frequency Display** : Indicates the operating frequency up to 10Hz digit. When RIT is on, the RIT frequency is indicated in four digits.
- (28-2) **Channel Display** : Indicates the memory channel number.
- (28-3) **Meter Display** : Indicates the following six items by the 40 segments pseudo-analogue meter.

**CENT** : Indicates the frequency center in the FM reception. The meter indicator deflects to the right when the received frequency is higher and to the left when it is lower. When no signal exists, the indicator is at the center position.

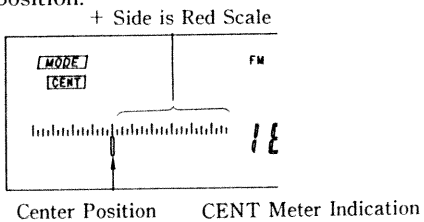

**Ic** : Indicates the collector current (Ic) of the final power amplifier transistors. The indicated unit is amperes (A).

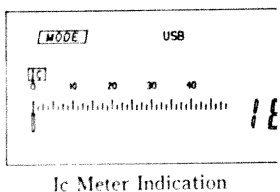

**REF** : Indicates the reflected relative power in transmission.

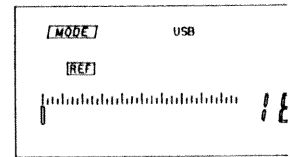

REF Meter Indication

**S** : Indicates the received signal strength in terms of S1 through S9 and S9+10dB through S9+50dB.

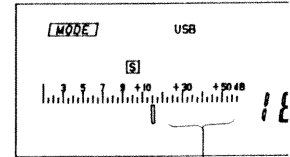

Red Scale

S Meter Indication

**Po** : Indicates the transmitter output relative power.

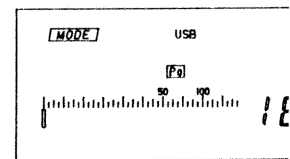

Po Meter Indication

**ALC** : Indicates the ALC voltage in transmission.

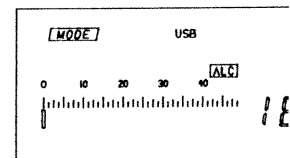

ALC Meter Indication

- MODE** : Indicates the operating mode ; AFSK, CW, USB, LSB, AM or FM.
- BANDWIDTH** : Indicates the bandwidth of the IF filter ; NARR (narrow), INTER or WIDE.
- SCAN** / **START** : Indicates that the display shows the start channel number and frequency of the memory scan.
- SCAN** / **END** : Indicates that the display shows the end channel number and frequency of the memory scan.
- SWEEP** / **START** : Indicates that the display shows the start frequency of the sweep (program scan).
- SWEEP** / **END** : Indicates that the display shows the end frequency of the sweep.
- RUN** : Indicates that the memory scan or sweep is executing.
- AGC** : Indicates the AGC condition ; OFF, FAST or SLOW. Not illuminate in the FM mode.

**TR1** : Indicates the transceive mode 1, which is the operation that the JST-135 and NRD-525 receives different frequencies at the same time and the JST-135 transmits on the frequency controlled by the NRD-525.

**TR2** : Indicates the transceive mode 2, which is the operation that the JST-135 transmits and the NRD-525 receives on the frequency controlled by either JST-135 or NRD-525.

TSQ : Indicates that the tone squelch is in operation.

SHIFT : Indicates that the JST-135 is in the shift operation such as repeater operation (the transmitting frequency is off-set from the receiving frequency).

REMOTE : Indicates that the JST-135 is remotely controlled by a personal computer and so on by using the optional RS-232C interface unit.

F1 : Indicates that the VFO-F1 is selected.

F2 : Indicates that the VFO-F2 is selected.

R·F1 : Indicates that the VFO-F1 is selected for reception and the VFO-F2 for transmission in the split operation.

R·F2 : Indicates that the VFO-F2 is selected for reception and the VFO-F1 for transmission in the split operation.

MR : Indicates that the memory channel is read out.

ATT : Indicates that the attenuator is on.

XMIT : Indicates that the transceiver is in transmission.

⑲MODE switch

Selects the operating mode by pressing the ◀||| or |||▶ switch. The selected mode is displayed on the Display ⑳.

⑳BANDWIDTH switch

Selects the bandwidth of the IF filter by pressing the ◀||| or |||▶ switch. The selected bandwidth is displayed on the Display ⑳. Table 4.1 shows the relationship between mode and bandwidth.

Table 4.1

Mode Bandwidth position	SSB	CW AFSK	AM	FM
NARR	* 1	* 1	2.0 kHz	2.0 kHz
INTER	2.0 kHz	* 2	6.0 kHz	6 kHz
WIDE	* 2	2.0 kHz	12 kHz	12 kHz

Note

- \* 1 and \* 2 are optional IF filters. Up to two filters (\* 1 and \* 2) in total can be mounted.
- The position can't be selected where the no optional filter is mounted.
- The bandwidth of \* 1 and \* 2 positions is in accordance with the optional filter mounted.

㉑UP/DOWN switches

Steps up or down the frequency, memory channel number or ham band. When the FREQ switch ㉓ is on, the frequency is stepped up or down. Similarly, when the CHANNEL switch ㉔ is on, the memory channel number, and the FUNC/HAM switch ㉕ is on, the ham band is stepped up or down.

㉒LOCK switch

Locks the TUNING control ④ and switches ⑱ to ㉔, ㉕ to ㉗ and ㉘ to ㉚ electrically. When this switch is on, the LED on the switch illuminates.

㉓FREQ (frequency) switch

Allows the ten-key ㉖ to enter the frequency. When this switch is on, the LED on the switch illuminates.

㉔CHANNEL switch

Allows the ten-key ㉖ to enter the memory channel number. When this switch is on, the LED on the switch illuminates.

㉕FUNC/HAM (function/ham) switch

Allows the ten-key ㉖ to enter the second function indicated above the keys. When this switch is on, the LED on the switch illuminates and the UP/DOWN switches step up or down the ham bands.

㉖Ten-Key

Enters the numerical values for frequency, memory channel number, or selects the second function. When keys are misoperated, a beep tone sounds through the speaker.

<sup>DIMMER</sup> 1 : Used to set "1." When the FUNC/HAM switch ㉕ is on, this key varies the brightness of the Display ⑳ in four steps from OFF to bright.

<sup>VOX</sup> 2 : Used to set "2." When the FUNC/HAM switch ㉕ is on, this key switches the VOX function ON-OFF. When the VOX function is on, the LED placed above the left of VOX control ⑤ illuminates.

<sup>TUNER</sup> 3 : Used to set "3." When the FUNC/HAM switch ㉕ is on, this key activates the automatic tuning of the NFG-23 (option).

<sup>F1 = F2</sup> 4 : Used to set "4." When the FUNC/HAM switch ㉕ is on, this key equalizes the frequency, mode, etc. of the other VFO to those of the working VFO.

<sup>R·F1</sup> 5 : Used to set "5." When the FUNC/HAM switch ㉕ is on, this key selects the split operation ; VFO-F1 for reception and VFO-F2 for transmission.

<sup>R·F2</sup> 6 : Used to set "6." When the FUNC/HAM switch ㉕ is on, this key selects the split operation ; VFO-F2 for reception and VFO-F1 for transmission.

<sup>SHIFT</sup> 7 : Used to set "7." When the FUNC/HAM switch ㉕ is on, this key activates the shift operation which off-sets the transmitting frequency by the designated value from the receiving one.

<sup>STEP</sup> 8 : Used to set "8." When the FUNC/HAM switch ㉕ is on, this key varies the frequency step of the TUNING control ④ and UP/DOWN switches ㉑.

<sup>TSQ</sup> 9 : Used to set "9." When the FUNC/HAM switch ㉕ is on, this key switches the tone squelch function ON-OFF.

**RUN**  
0: Used to set "0." When the FUNC/HAM switch ③⑤ is on, this key executes the memory scan or sweep (program scan). During executing the memory scan or sweep, RUN indicator on the Display ②⑧ illuminates.

**SPEED**  
.: Used to set ".". During executing the memory scan or sweep, this key varies the scanning/sweeping speed.

#### ③⑦ MHz switch

Enters the selected frequency in MHz unit. When the FUNC/HAM switch ③⑤ is on and the memory scan or sweep is pausing, this key restarts the memory scan or sweep.

#### ③⑧ ENT/kHz (enter/kHz) switch

Enters the selected frequency in kHz unit or reads the memory channel selected.

#### ③⑨ CLR (clear) switch

Clears the data input by ten-key ③⑥. When pressed, the data is cleared and the Display ②⑧ shows the previous data. This canceling is available before "MHz" or "ENT/kHz" key is depressed. When the FUNC/HAM switch ③⑤ is on, this switch activates the priority check function.

#### ④⑩ MEMO (memory) switch

Stores data in the memory channel.

## 4.2 Rear Panel

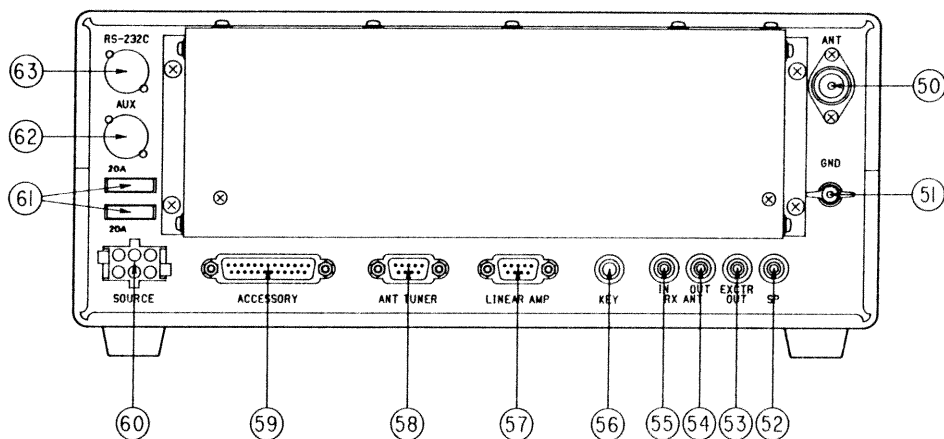

Fig. 4.5 Rear Panel

#### ⑤⑩ ANT (antenna) connector

Used to connect a 50Ω antenna.

#### ⑤① GND (ground) terminal

Used to connect the grounding wire for RF ground and safety. Connect the ground terminal to the ground together with an antenna tuner, power supply, and other peripheral units.

#### ⑤② SP (external speaker) jack

Used to connect an external speaker. When connected, the internal speaker is disconnected.

#### ⑤③ EXCTR OUT (exciter output) jack

Used to drive a transverter, etc.. The output impedance is 50Ω and the level is about 1V.

#### ⑤④ RX ANT OUT (receiving antenna output) jack

Used to connect an external receiver. When an external receiver is connected, the receiving signal from ANT connector ⑤⑩ is fed to the receiver through the transmission/reception

switching circuit. In this case, the internal receiver circuit is disconnected.

#### ⑤⑤ RX ANT IN (receiving antenna input) jack

Used to connect a receiving antenna. When a receiving antenna is connected, the signal from the antenna is fed directly to the receiver of the JST-135. In this case, the ANT connector ⑤⑩ is disconnected from the receiver.

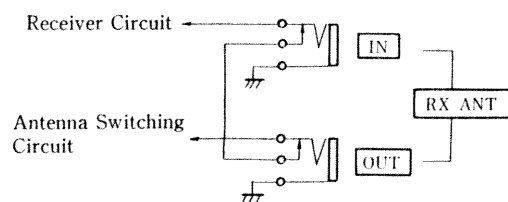

Fig. 4.6 Internal Connection of RX ANT IN/OUT Jacks

#### ⑤⑥ KEY jack

Used to connect a Morse key in the CW mode.

⑤7) LINEAR AMP (linear amplifier) connector

Used to connect a linear amplifier. When the JRL-1000 Linear Amplifier is connected, the full functions are controlled through the exclusive bus lines in this connector. Note that the full-break-in operation in the CW mode is not available for the JRL-1000 Linear Amplifier. Fig. 4.7 shows the pin connection.

Pin No.	Signal Nomenclature	Function
1	E	Chassis Earth
2	ETD	Bus line output
3	ERD	Bus line input
4	TX MUTE	Grounding inhibits the transmission.
5	ALC $\ominus$	ALC input (negative voltage)
6	$\overline{RL}$	Should be grounded for operating the linear amplifier.
7	LACM	Stand-by relay contact output (common)
8	LAMK	Stand-by relay contact output (make)
9	E	Chassis Earth

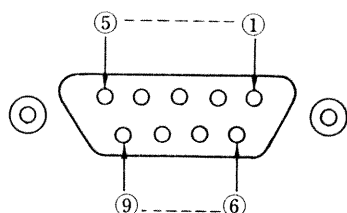

(Pin layout, seen from the rear panel)

Fig. 4.7 LINEAR AMP connector pin connection

⑤8) ANT TUNER (antenna tuner) connector

Used to connect the optional antenna tuner NFG-230. Fig. 4.8 shows the pin connection.

Pin No.	Signal Nomenclature	Function
1	SHLD	Shield Earth
2	ETD	Bus line output
3	ERD	Bus line input
4	IA	Antenna current input
5	—	—
6	13.8V	13.8V output
7	13.8V	13.8V output
8	E	Chassis Earth
9	E	Chassis Earth

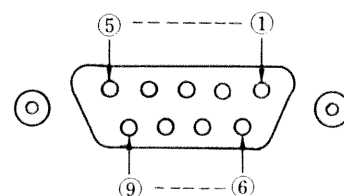

(Pin layout, seen from the rear panel)

Fig. 4.8 ANT TUNER connector pin connection

⑤9) ACCESSORY connector

For various input and output signals from and to external units. Fig. 4.9 shows the pin connection. When connecting, use the supplied 25P plug or D-sub connector (25P plug) on the mark.

Pin No.	Signal Nomenclature	Function
1	$\overline{-BK}$	When grounded, the transmitter is enabled and receiver is disabled.
2	$\overline{RXBK}$	When grounded the receiver is disabled.
3	$\overline{SEL BK}$	When grounded, the transmitter is enabled in AME mode.
4	READY	Opened when the transceiver is ready for transmit. Grounded otherwise.
5	E	Chassis Earth
6	—	—
7	AF IN	AF input to drive the speaker. (0dBm)
8	LINE OUT 1	600 $\Omega$ , 0dBm squelched line output
9	LINE OUT 2	600 $\Omega$ , 0dBm unsquelched line output
10	E	Chassis Earth
11	AM USB OUT	AM-USB demodulated output in the ECSS operation (option)
12	AM LSB OUT	AM-LSB demodulated output in the ECSS operation (option)
13	MIC MUTE	When +5V to +13.8V is applied, the microphone signal is muted. In this case LINE IN1 and LINE IN2 are enabled.
14	13.8V	13.8V output, 1A maximum
15	E	Chassis Earth
16	LINE IN 1	Line input for 600 $\Omega$ , 0dBm transmitting modulation.
17	LINE IN 2	Line input for 600 $\Omega$ , 0dBm transmitting modulation
18	PATCH IN	Phone patch input (0dBm)
19	—	—

20	ANTI	ANTI-VOX input in the transceive operation with the external receiver
21	F	Chassis Earth
22	SP	Speaker output (always on)
23	SP-E	Return earth for speaker output
24	SCAN HOLD	When grounded, the memory scan or sweepo is interrupted.
25	E	Chassis Earth

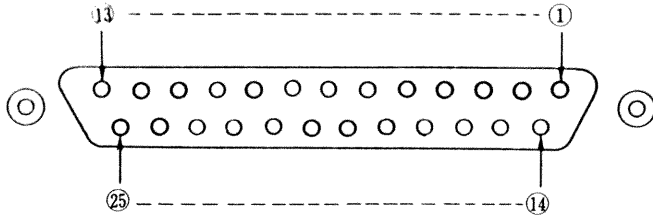

(Pin layout, seen from the rear panel)

Fig. 4.9 ACCESSORY connector pin connection

**⑥0SOURCE (DC power) connector**

Used to supply 13.8VDC to JST-135. Connect the supplied DC power cable. For AC power operation, connect the DC output cable from the NBD-520 power supply to this connector.

**⑥1FUSE (DC fuse)**

Fuses on DC13.8V line. Two 20A fuses are used.

If the fuses are blown, check the cause and replace with the same capacity.

**⑥2AUX (auxiliary) connector**

Used to mount the auxiliary connector. Will be used in the future.

**⑥3RS-232C connector**

Used to control the JST-135 remotely with a personal computer etc. using the optional RS-232C unit CMH-741. This connector is attached to the CMH-741 and is not provided as a standard accessory at the shipment.

# 5. BASIC OPERATION

This chapter describes the basic operation of JST-135. For functions of switches and controls, refer to Chapter 4 "OPERATING CONTROLS ON PANEL".

## 5.1 Cautions on Operation

There are many frequencies of radio stations for business use near the ham band and they are used. If radio waves are emitted at close distance of those radio stations, unexpected radio interference may occur even though the amateur station conforms to Radio Regulations. So, be careful when using the equipment near those business radio stations. Obtain an administrator's approval if it is required to operate the equipment.

## 5.2 Preliminary Setting

- After connecting the SOURCE (power) cable, antenna, etc., set controls as follows with the POWER switch ① off.

Table 5.1 Preliminary Setting

AF GAIN control ②	.....	Fully counterclockwise
RF GAIN control ③	.....	Fully clockwise
SQUELCH control ⑫	.....	Fully counterclockwise
PBS control ⑬	.....	Center
BWC control ⑭	.....	Fully counterclockwise
NB LEVEL control ⑮	.....	Fully counterclockwise
Po control ⑧	.....	Fully clockwise
MIC control ⑦	.....	Center
COMP control ⑪	.....	Fully counterclockwise

- Turn the POWER switch ① ON, and check that operating frequency and conditions are displayed.

## 5.3 Frequency Setting

Your JST-135 has two VFOs, i.e., VFO F1 and VFO F2. They are actually two channels of scratch-pad memory which has been realized by MPU and RAM, and store data on operating frequency, mode, bandwidth, AGC time constant and ATT ON/OFF. Afterwards, frequency setting means setting of VFO frequency which is currently selected.

Set an operating frequency by any of the following three methods :

- By the TUNING control ④

Frequency from 100kHz to 30MHz can be set in 10Hz steps. Generally, the TUNING control is used for fine tuning.

- By UP/DOWN sawitches ⑩

When the FREQ switch is on, the frequency can be stepped up or down in the minimum 1kHz steps. Generally, these switches are used for coarse tuning. When the FUNC/HAM switch ⑮ is on, these switches step the ham bands up or down.

- By ten-key ⑯

To enter the frequency by ten-key, either of the following two methods is available. In this case, be sure to turn the FREQ switch ⑩ on.

Example : To enter 12.3456MHz :

- Entry in kHz

Press 

1	2	3	4	5	.	6	ENT/kHz
---	---	---	---	---	---	---	---------

- Entry in MHz

Press 

1	2	.	3	4	5	6	MHz
---	---	---	---	---	---	---	-----

If a wrong key is pressed, press the CLR switch ⑲ and re-enter. The CLR key ⑲ clears the data just entered and displays previous frequency.

## 5.4 Check before Transmission

Note the followings before transmission :

- The antenna impedance of JST-135 is 50Ω. Please use a 50Ω antenna if you wish to connect directly without a coupler.
- Use a 50Ω dummy load for transmission test. Be sure not to transmit when the ANT connector ⑳ is open.
- The transceiver can not transmit when the set frequency is out of the amateur bands.
- Monitor the transmitting frequency before transmission not to interfere the communication which may be going.

## 5.5 Operation in the SSB Mode

Set controls and switches as follows, leaving remaining controls and switches as they were set preliminary in 5.2.

MODE switch ⑳ ..... LSB or USB

BANDWIDTH switch ㉑ ..... INTER

AGC switch ㉒ ..... SLOW

AF GAIN control ② ..... Set for suitable sound volume

Receiving frequency ..... Desired frequency



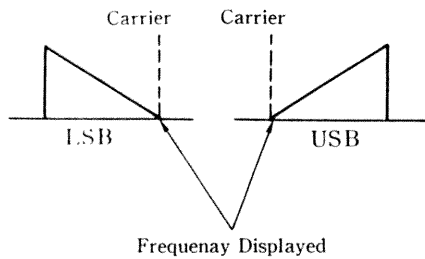

Fig. 5.1 Frequency Display in the SSB Mode

### 5.5.1 Reception

Slowly turn the TUNING control ④ to find a point where the SSB signal can be clearly heard. Ordinarily, use LSB for the frequency less than 10MHz and USB for more than 10MHz to listen amateur radio.

### 5.5.2 Transmission

- (1) Press the XMIT switch ⑳ or set the PTT switch on the microphone to ON. XMIT indicator on the Display ㉔ lights up to indicate that the transceiver becomes transmitting condition.
- (2) Change the Meter indication (28-3) to Po (transmitting output) by pressing the METER switch ㉑ and speak to the microphone. The meter deflects according to the peaks of voice.
- (3) Then, change the Meter indication (28-3) to ALC and adjust the MIC control ⑦ so that the meter reads the red scale sometimes.

## 5.6 Operation in the CW Mode

Set controls and switches as follows, leaving other controls and switches set preliminary in 5.2.

Table 5.3 Setting in the CW Mode

MODE switch ㉔	.....CW
BANDWIDTH switch ㉕	.....WIDE
AGC switch ㉖	.....FAST
AF GAIN control ②	.....Set for suitable sound volume
Receiving frequency	.....Desired frequency

In the CW mode, the Display ㉔ indicates the carrier frequency in both transmission and reception. When the receiving frequency of the own station and the transmitting frequency of the partner's station coincide each other, the demodulated tone becomes 800Hz.

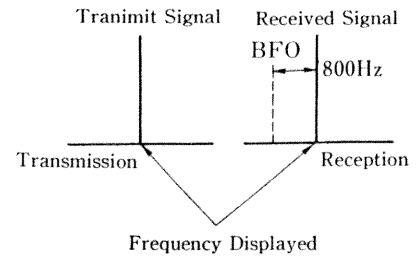

Fig. 5.2 Frequency Display in the CW Mode

### 5.6.1 Reception

Turn the TUNING control ④ slowly so that the demodulated tone becomes approx. 800Hz.

**Note**  
 INTER or NARR position of the BANDWIDTH become operative only when the optional CW filter is mounted.

### 5.6.2 Transmission

- (1) Press XMIT switch ⑳ so that the transceiver becomes transmitting condition.
- (2) Select the Po (transmitting output) scale of Meter (28-3) by pressing the METER switch ㉑.
- (3) By pressing the Morse key, the meter indication moves according to keying and the CW signal is transmitted. At the same time, the keying signal can be monitored through the speaker.

## 5.7 Operation in the AM Mode

Set controls and switches as follows, leaving remaining controls and switches as they were preliminarily in 5.2.

Table 5.4 Setting in the AM Mode

MODE switch ㉔	.....AM
BANDWIDTH switch ㉕	.....INTER
AGC switch ㉖	.....SLOW
AF GAIN control ②	.....Set for suitable sound volume
Receiving frequency	.....Desired frequency

In the AM mode, the Display ㉔ indicates the carrier frequency in both transmission and reception. The type of emission in the AM mode of this equipment is H3E.

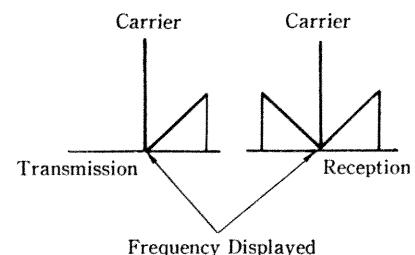

Fig. 5.3 Frequency Display in the AM Mode

### 5.7.1 Reception

Rotate the TUNING control ④ slowly so that the S meter (28-3) deflects maximum.

### 5.7.2 Transmission

- (1) Press the XMIT switch ⑫ or set the PTT switch on the microphone to ON. The XMIT indicator on the Display ⑳ lights up so that the transceiver becomes transmitting condition.
- (2) Select the ALC scale of Meter (28-3) by the METER switch ⑰ and adjust the MIC control ⑦ so that the pointer of the meter sometimes goes into red zone at the peak of your voice.

### 5.8 Operation in the FM Mode

Set controls and switches as follows, leaving other controls and switches set preliminarily in 5.2.

Table 5.5 Setting in the FM Mode

MODE switch ⑳	..... FM
BANDWIDTH switch ㉑	..... WIDE
AF GAIN control ②	..... Set for suitable sound volume
Receiving frequency	..... Desired frequency

In the FM mode, Display ㉒ indicates the carrier frequency in both transmission and reception.

**Note**

For the FM mode, the usable band is limited to the 28MHz band and usually, the frequency range is also limited from 29 to 29.7MHz excluding the range from 29.3 to 29.51MHz.

#### 5.8.1 Reception

- (1) Adjust the SQUELCH control ⑬ by turning it slowly clockwise so as to find a threshold point where the noise cannot be heard through the speaker.
- (2) Adjust the TUNING control ④ by turning it slowly so that the S-meter (28-3) deflects maximumly.
- (3) Then, select the CENT scale (center meter) of Meter (28-3) by pressing the METER switch ⑰, and confirm that the pointer reads around the center.

#### 5.8.2 Transmission

Press XMIT switch ⑫ or set the PTT switch on the microphone to ON. Then, speak to the microphone with the normal loudness. Please set the MIC control around or below the center.

### 5.9 Operation in the AFSK Mode

In the AFSK (RTTY) mode, a demodulator, or teletypewriter etc. are required. Refer to RTTY equipments described in 6.15.4

Set controls and switches as follows, leaving other controls and switches set preliminarily in 5.2.

Table 5.6 Setting in the AFSK Mode

MODE switch ⑳	..... AFSK
BANDWIDTH switch ㉑	..... INTER
AF GAIN control ②	..... Set for suitable sound volume
Receiving frequency	..... Desired frequency

In the AFSK mode, Display ㉒ indicates the center frequency of mark and space signals in both transmission and reception.

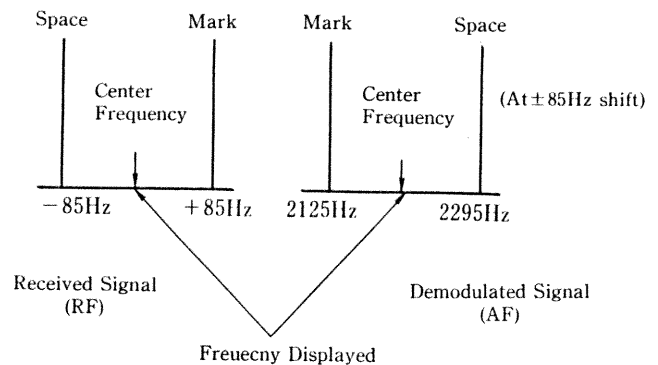

Fig. 5.4 Frequency Display in the AFSK Mode

#### 5.9.1 Reception

Turn the TUNING control ④ slowly to search an RTTY signal and adjust the control so that demodulated tone becomes about 2210Hz. Further, finely adjust the TUNING control as observing the indicator on the demodulator.

#### 5.9.2 Transmission

The transceiver becomes transmitting condition by operating the teletypewriter connected externally and the equipment transmits the AFSK (RTTY) signal.

# 6. ADVANCED OPERATION

## 6.1 Two-VFO System

JST-135 incorporates two VFOs F1 and F2 which allow not only simplex operation but also split operation.

### 6.1.1 Simplex Operation

In the simplex operation, the transmitting frequency and receiving frequency are the same. The simplex operation with VFO F1 or VFO F2 is available.

F1/F2 switch ② is used to select one of the two independent VFOs. Each time the switch is pressed, the VFO-F1 or VFO-F2 is selected alternately, and F1 or F2 indicator lights up on Display to show current VFO. VFO-F1 and VFO-F2 can be operated in the different modes and at different frequencies respectively.

**Note**

If the frequency is set out of the ham band, the transmission is disabled.

### 6.1.2 Split Operation

In the split operation, the transmitting frequency and receiving frequency are different. The different frequencies are set for two VFOs respectively and VFO-F1 and VFO-F2 are changed over corresponding to transmission and reception. If the FUNC/HAM switch ⑤ is turned on,  $\overset{R \cdot F1}{\boxed{5}}$  of ten-key ⑥ or  $\overset{R \cdot F2}{\boxed{6}}$  works as VFO selector switch for the split operation. Depress  $\overset{R \cdot F1}{\boxed{5}}$  to use VFO-F1 for reception and VFO-F2 for transmission. Or depress  $\overset{R \cdot F2}{\boxed{6}}$  to use VFO-F2 for reception and VFO-F1 for transmission.

**Notes**

In the following cases, the split operation is not applicable.

1. CW transmit mode is set while other reception mode than CW is set.
2. CW full break-in between different bands.

Example :

F1.....14.25000 MH, USB

F2.....14.30000 MHz, LSB

When frequencies are set as described above, and you wish to use F1 for reception and F2 for transmission, set the FUNC/HAM switch ⑤ to ON and press  $\overset{R \cdot F1}{\boxed{5}}$  key.

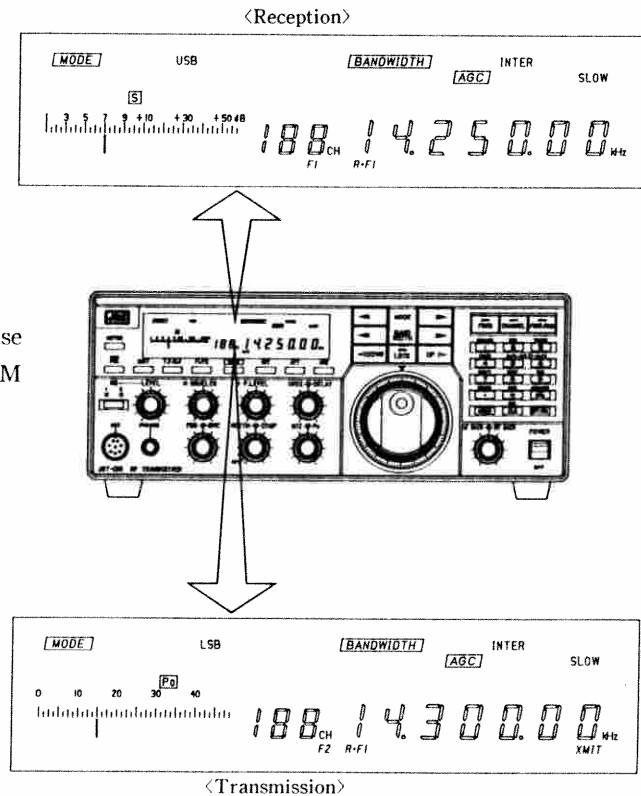

Fig. 6.1 Example in the Split Operation (R•F1)

### 6.1.3 Equalization Function

JST-135 has the equalization function which equalizes the frequency and mode of the VFO not in use to those of the other

VFO in use.

For example, suppose that VFO-F1 is set to 7MHz LSB and VFO-F2 is set to 14MHz USB, and the transceiver receives by

F1 (7MHz LSB). If the FUNC/HAM switch ③⑤ is set to ON and  $\boxed{F1-F2}$  key is depressed during the above reception, data of VFO-F2 will be erased and changed to 7MHz LSB. VFO data which can be equalized are frequency, mode, bandwidth, AGC time constant and ATT ON/OFF.

## 6.2 Memory Function

JST-135 can store 200 channels, with each channel containing the mode, bandwidth, attenuator on-off and status of AGC. Stored data are backed up by a lithium battery. In the FM mode, the memory can store tone on/off, tone frequency (when mounting optional Tone Squelch Unit CCL-212), shift on/off, and shift width, too, besides the above data.

Above data stored in the memory channel are recalled and copied on current VFO.

### 6.2.1 Recalling the Memory Channel

Following two methods are selectable for recalling memory channel.

#### ● Recalling by UP/DOWN switches ④①

Set the CHANNEL switch ④④ to ON. By pressing the UP or DOWN switch ④①, the memory channel (channel display ②⑧-②) is increased or decreased.

#### ● Setting the channel by ten-key ④⑥

The memory channel can be set by using ten-key ④⑥. For example, to set the channel No.199, set ten-key as follows.

First, set the CHANNEL switch ④④ to ON so as to use ten-key as channel entry switches.

Then, press the keys as:  $\boxed{1} \boxed{9} \boxed{9} \boxed{\text{ENT/kHz}}$ .

Now the memory channel No.199 has been recalled and 199 is displayed on the channel display ②⑧-②.

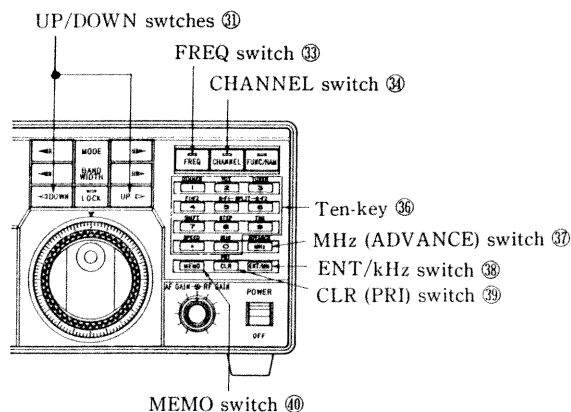

Fig. 6.2 Switches Related to Memory

### 6.2.2 Programming Memory Channel

Data are stored by any of the following methods according to the order of setting of the frequency and channel number.

#### ● To set the frequency first :

(1) Turn on the FREQ switch ④③ and set the frequency, mode bandwidth, ATT on/off and AGC. (For setting the frequency, refer to 5.3.)

(2) Turn on the CHANNEL switch ④④ and set the desired channel number. For example, to set the channel No.199, press the keys as  $\boxed{1} \boxed{9} \boxed{9}$ .

Do not press the  $\boxed{\text{ENT/kHz}}$  key ④⑧ after pressing the above keys. If it is pressed, data stored in the channel No.199 indicated on Display ②⑧ and newly set frequency, mode bandwidth, ATT on/off and AGC will be deleted.

(3) Press the  $\boxed{\text{ENT/kHz}}$  key while keeping the  $\boxed{\text{MEMO}}$  switch ④⑩ pressed. The beep sounds and the content newly set in the channel No.199. is stored.

#### ● To set the memory channel number first :

(1) Turn on the CHANNEL switch ④④ and set the desired memory channel number. (For setting the channel number refer to 6.2.1.)

(2) Turn on the FREQ switch ④③ and set the frequency, mode bandwidth, ATT on-off and AGC status which you want to store. (For setting the frequency, refer to 5.3.)

(3) By pressing the  $\boxed{\text{ENT/kHz}}$  switch ④⑧ while keeping the  $\boxed{\text{MEMO}}$  switch ④⑩ pressed, the beep sounds and the content set in the above step (2) is stored in the memory channel selected in paragraph (1).

### 6.2.3 Memory Recall

(1) Turn on the CHANNEL switch ④④ and key-in the desired memory channel number by the ten-key ④⑥. (For setting, refer to 6.2.1.)

(2) After setting the memory channel, data stored in that channel are recalled, copied on VFO currently selected and displayed on Display ②⑧. The transceiver operates on the recalled data. when recalling the stored data, MR(memory read) indicator on Display ②⑧ lights up. Also, if the CHANNEL switch ④④ is turned on at this time, the memory channel number can be increased or decreased by UP/DOWN switches ④①.

(3) Furthermore, if the FREQ switch ④③ is turned on, the frequency of the VFO can be changed by rotating the TUNING control ④ or by UP/DOWN switches ④①. But in this case, MR indicator goes off.

### 6.2.4 Clearing Stored Data

(1) Turn on the CHANNEL switch ④④ and key-in the memory channel number to be cleared by ten-key ④⑥. (For setting, refer to 6.2.1.)

(2) If the memory channel is set, data stored in that channel

will be recalled and displayed. Then, by pressing the **PRI CLR** switch ⑳ while keeping the **MEMO** switch pressed, all of the data stored in the channel are cleared.

### 6.3 Interference Eliminating Functions

#### 6.3.1 NB (noise blanker)

The noise blanker is provided to receive the signals clearly by suppressing pulse noise. JST-135 has three positions for the noise blanker, i.e., OFF, 1 and 2, and any of them can be selected in turns.

Selected position is indicated by LEDs above the switch. Use the position 1 for eliminating narrow pulse noise such as ignition noise from cars, and position 2 for wide pulse noise such as woodpecker noise. The threshold level of the noise blanker can be changed by using the NB LEVEL control ⑮. As turning this control clockwise, the sensitivity of the noise blanker becomes higher and noise with fairly low amplitude can be eliminated. Note that the noise blanking circuit may deteriorate the received signal quality when it used improperly. Thus, adjust the NB LEVEL according to the receiving condition.

**Note**

There may be a case where the blanking effect is not so high according to kinds of noise.

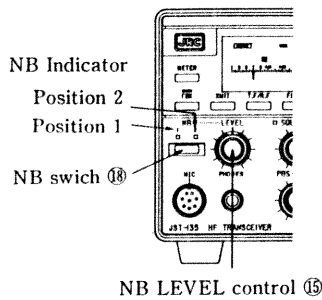

Fig. 6.3 Noise Blanking Switch and Control

#### 6.3.2 PBS (pass band shift)

The pass band of the receiving IF filter can be varied by about  $\pm 1\text{kHz}$  without changing the receiving frequency. This function allows an elimination of the adjacent interference by shifting the receiving IF filter apparently when the received signal is disturbed by the adjacent signal.

In the USB mode, if this control is turned counterclockwise from the center position, interference from higher component of the voice signal can be eliminated. At this time, the high band portion of the received signal is also cut. Also, if this control is

turned clockwise from the center position, interference from lower components of the voice signal can be eliminated. At this time, the low band portion of the received signal is cut. In the LSB, CW and AFSK modes, the above relationships are reversed.

In the CW mode, the pitch can be continuously varied by using the PBS control and RIT control together.

**Note**

If the PBS control is set far from the center position, the tone quality of the received signal is degraded. Be sure to set the PBS control to the center position unless the PBS operation is needed.

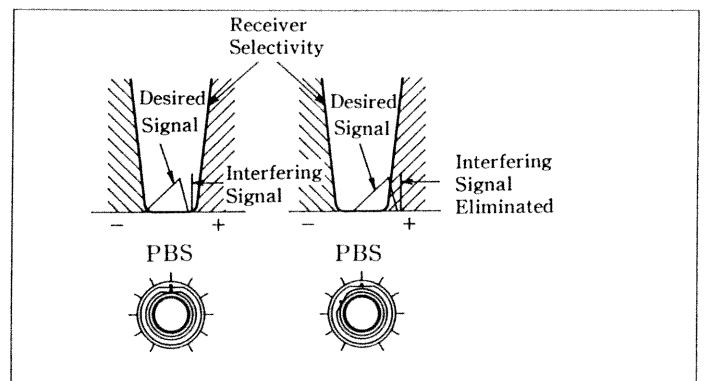

Fig. 6.4 Operation of the PBS (pass band shift)

#### 6.3.3 BWC (bandwidth control)

By mounting the optional BWC Unit CFL-243, the pass bandwidth can be varied without changing the center frequency of the receiving IF filter so as to eliminate the adjacent interference or noise.

At the fully counterclockwise position of BWC control ⑭, the pass bandwidth become widest. As rotating it clockwise, the pass bandwidth of the receiving IF filter can be made narrower up to approx. 800Hz. This BWC function works in the USB, LSB and CW modes.

This BWC control cuts upper and lower edges of the pass bandwidth equally. To make the one side (asymmetrical) narrow, use the PBS control ⑬ together with this BWC control. The apparent IF filter as you wish may be obtained.

**Note**

Too narrow IF bandwidth deteriorates the received signal quality. Set the BWC control ⑭ to fully counterclockwise position unless BWC operation is needed.

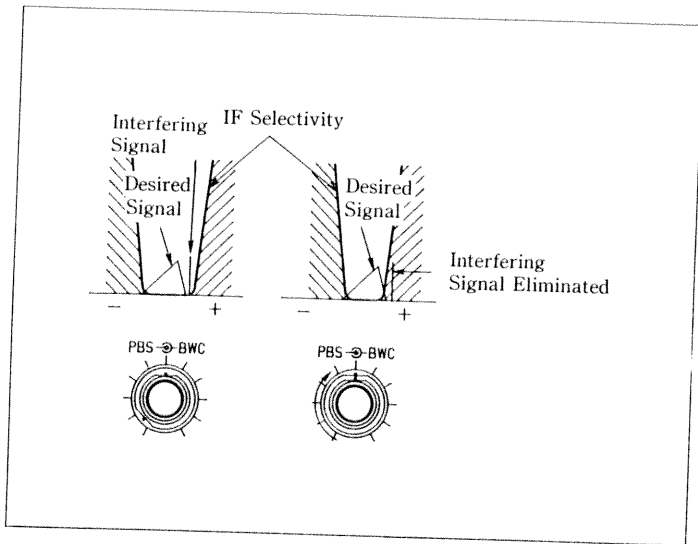

Fig. 6.5 Operation of the BWC (bandwidth) Control

### 6.3.4 NOTCH (notch filter)

If the received signal sustains the interference due to carrier or CW and unpleasant beats are contained in the demodulated sound, this notch filter eliminates this beat interference.

By turning the NOTCH control ⑩ clockwise from the fully counterclockwise position (OFF position), the notch filter is turned on. Adjust the NOTCH control so that beat interference becomes minimum. If the control is set to the center position in the LSB or USB mode, the beat interference equivalent to about 1.5kHz (AF output) can be eliminated. In the USB mode, by turning the control clockwise from the center position, the beat interference higher than 1.5kHz can be eliminated.

#### Note

While the NOTCH control is activated, the received signal may be degraded. So, please leave it at fully counterclockwise position (OFF) unless "NOTCH" is really needed.

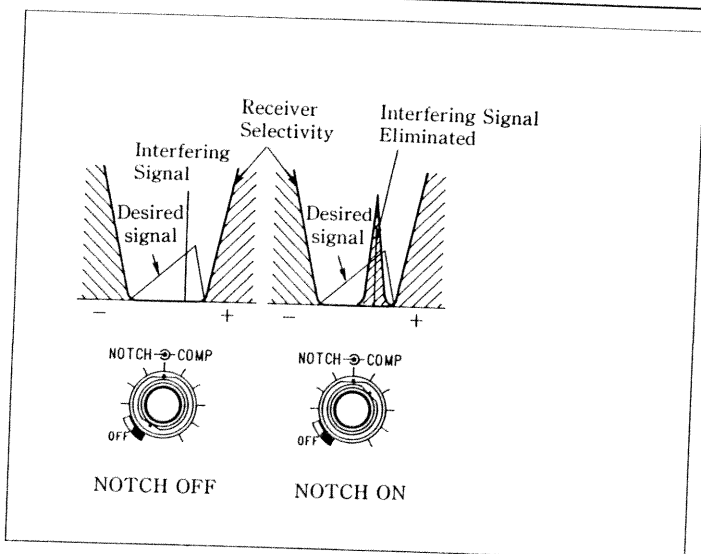

Fig. 6.6 Operation of the NOTCH (notch filter) Control

### 6.3.5 NOTCH FOLLOW (notch follow filter)

Notch filter described in 6.3.4 should be readjusted if TUNING control ④ is turned (fine tuning of the received signal) after the NOTCH control ⑩ once set at an adequate position to reduce beat interference. If you mount the optional Notch Follow Filter Unit CDD-366, you will be released from such readjustment of NOTCH. This notch follow filter compensates the fine tuning by the TUNING control ④ within  $\pm 10\text{kHz}$  without moving the notch point which once adjusted. To activate this NOTCH follow function of your JST-135 fitted with optional CDD-366, rotate the NOTCH control ⑩ while keeping the MEMO switch ④① pressed. "Fo" is displayed on the channel display (28-2) when the notch follow function is on. To turn off this function, turn the NOTCH control fully counterclockwise (OFF position) (it is not required to press the MEMO switch).

#### Notes

1. If the notch filter or notch follow filter is turned on, the received signal may be degraded. So, it should be turned fully counterclockwise (OFF), unless necessary.
2. To eliminate other beat interference after adjusting the NOTCH control ⑩ to an interference, the NOTCH control ⑩ should be adjusted again.
3. If stored data is recalled during the notch follow filter operation, the notch follow filter will automatically be turned off. Reset it if necessary.

#### "Fo" Indication for Notch Follow Function

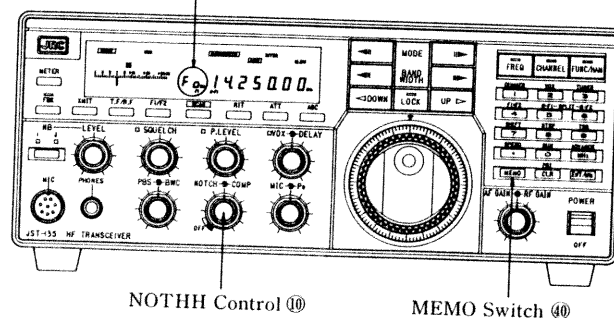

Fig. 6.7 Controls Related to the Notch Function

Downloaded by  
RadioAmateur.EU

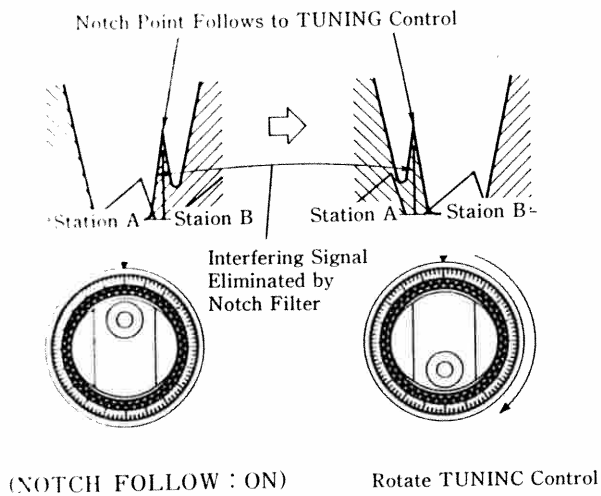

Fig. 6.8 Operation of the NOTCH FOLLOW (notch follow filter)

### 6.3.6 ECSS (exalted carrier selectable sideband)

If the optional ECSS Unit CMF-78 is mounted, the interference can be eliminated by selecting the sideband which is not interfered by the adjacent station during AM (DSB) reception. When receiving AM (DSB) signal which is interfered by the adjacent station, the side band which is not interfered is received by using the narrow band IF filter so far. This ECSS allows selecting the side band without using the narrow band IF filter, so that, the clear signal without deterioration of the tone quality can be received.

Use this function as follows: Select the AM mode by the MODE switch ⑳ to receive the AM signal. If the received AM signal is interfered by the adjacent signal, press the **SHIFT** **7** key to turn on ECSS while keeping **MEMO** switch ④① pressed. At this time AM indicator and the indicator of the side band which is being received (USB at receiving the upper side band or LSB at receiving the lower side band) light up on Display ⑳. Each time the above operation is performed, USB, LSB, or OFF is repeated in turn. Select the position according to the interference condition of the received signal.

#### Notes

1. If the received signal is detuned or no signal is received during ECSS operation, the muting circuit works and the audio output (AF) does not appear.
2. Be sure to turn off ECSS during searching signals of the new station by the TUNING control ④ or UP/DOWN switches ③①.

Indicates Received Sideband, USB or LSB

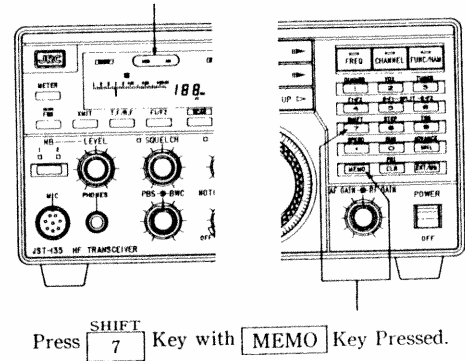

Fig. 6.9 Operation and Display of ECSS

## 6.4 Memory Scan and Sweep Functions

The scan function allows automatic scan among specified memory channels. The sweep function allows automatic sweep between specified frequencies.

### 6.4.1 Confirmation and Setting of Memory Scan Start and End Channels

- **SCAN** START :Lights up to indicate start channel of memory scan.
- **SCAN** END :Lights up to indicate the end channel of memory scan.

#### (1) Confirmation and setting of start channel

Turn on the CHANNEL switch ④. Press the SCAN switch ④ to select **SCAN** START of Display ⑳. Then, the channel number and data stored in that channel are indicated on the Display ⑳, and this channel becomes start channel. When changing the channel number, refer to 6.2.1 "Recalling the Memory Channel".

By the above operation, the start channel of the memory scan has been set.

#### (2) Confirmation and setting of end channel

Then, press the SCAN switch ④ again. **SCAN** END indicator lights up. At the same time, the channel number and data stored in that channel are displayed on the Display ⑳, and this channel becomes end channel. When changing the channel number setting, refer to 6.2.1 "Recalling the Memory Channel".

By the above operation, the end channel of the memory scan has been set.

#### (3) Exit

To exit and enter other operation, press either FREQ switch ③ or FUNC/HAM switch ⑤. At the same time, **SCAN** START or END indicator goes off.

### 6.4.2 Confirmation and Setting of Start and End Frequency of Sweep

- **[SWEEP] START**: Lights up to indicate the start frequency of sweep.
- **[SWEEP] END**: Lights up to indicate the end frequency of sweep.

#### (1) Confirmation and setting of the start frequency

Set the **FREQ** switch ③③ to ON and press the **SCAN** switch ②④ to select **[SWEEP] START** on Display ②⑧. At the same time, the start frequency is displayed on the frequency display (28-1). To change this frequency, refer to 5.3 "Frequency Setting". By the above operation, the start frequency of sweep has been set.

#### (2) Confirmation and setting of the end frequency

Then, by pressing the **SCAN** switch ②④, the **[SWEEP] END** indicator lights up. At the same time, the end frequency is displayed on the frequency display (28-1). To change this frequency, refer to 5.3 "Frequency Setting". By the above operation, the end frequency of sweep has been set.

#### (3) Exit

To exit and enter other operation, press either **CHANNEL** switch ③④ or **FUNC/HAM** switch ③⑤. At the same time, **[SWEEP] START** or **END** indicator goes off.

#### (4) Change of the speed

The running speed can be changed by pressing the **[SPEED]** key while memory scan or sweep is being executing. By pressing this key, the speed value from 1 to 10 is displayed on the channel display (28-2). Thus, set the desired speed value by using the **TUNING** control ④. The larger value is selected, the faster the speed becomes. Upon completion of setting, press **[SPEED]** again.

Be sure to set memory scan speed during memory scan execution and to set sweep speed during sweep execution.

#### (5) Exit

To exit execution, press either **FREQ** switch ③③ or **CHANNEL** switch ③④ while scan or sweep is being executed.

### 6.4.4 ADVANCE function

The transceiver stops scanning (or sweeping) automatically when it receives the signal of the level more than that set by the **P. LEVEL** control ⑨ during executing memory scan or sweep. While **FUNC/HAM** ③⑤ is on, and when **MHz (ADVANCE)** switch ③⑦ is pressed during this automatic pause, scanning (or sweeping) restarts from the channel or frequency at which execution is stopped.

### 6.4.3 Execution of Memory Scan or Sweep

#### (1) Execution

Turn on the **FUNC** switch ③⑤. Then, by pressing the **SCAN** switch ②④, **[SCAN]** indicator lights up on Display ②⑧. Each time this switch is pressed, **[SCAN]** or **[SWEEP]** is selected in turn. Select **[SCAN]** to execute memory scan, and **[SWEEP]** to execute sweep. By pressing **[RUN]** key after selecting, memory scan or sweep starts. Scan or sweep can be changed by pressing the **SCAN** switch ②④ while memory scan or sweep is being executed.

#### (2) Pause

To pause memory scan or sweep compulsorily, press **[RUN]** 0 while **[FUNC/HAM]** is ON. To restart, press **[RUN]** 0 key again.

#### (3) Adjustment of the automatic pause level

The automatic pause level can be adjusted by **P. LEVEL** control ⑨. As turning this control clockwise, the pause level lowers and scan or sweep will be stopped by the weaker signals.

If the **RF GAIN** control ③ is operated after adjusting the **P. LEVEL** control ⑨, the previously adjusted automatic pause level will be changed.

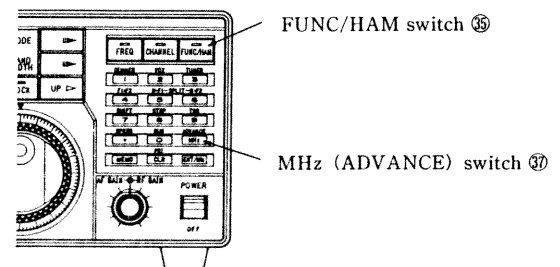

Fig. 6.10 ADVANCE Switch

### 6.5 Priority Checking Function

This function permits automatic and intermittent reception on the frequency programmed in memory channel 0 at certain intervals during reception. To turn on the priority checking function, set the **FUNC/HAM** switch ③⑤ to ON and press the **[PRI CLR]** switch ③⑨. To turn off this function, repeat the same operation. When jumping to Memory channel 0 by this function, "P" is displayed on the channel display (28-2). By pressing **[PRI CLR]** switch ③⑨ during jumping, the transceiver stays at memory channel 0. The transmitting operation turns off this function.



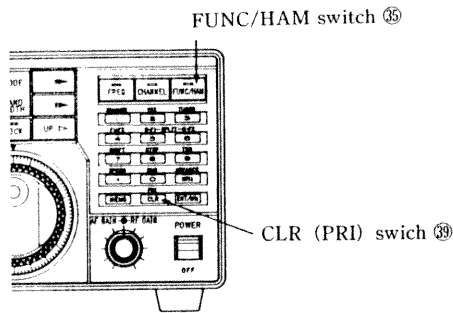

Fig. 6.11 Priority Check Switches

### 6.5.1 Priority Checking During Normal Reception

By turning on the priority checking function during reception, priority is given to reception of the frequency in memory channel 0 for one second once every five seconds.

### 6.5.2 Priority Checking During Memory Scanning

By turning on the priority checking function during memory scanning, priority is given to reception of the frequency in memory channel 0 every scanning operation.

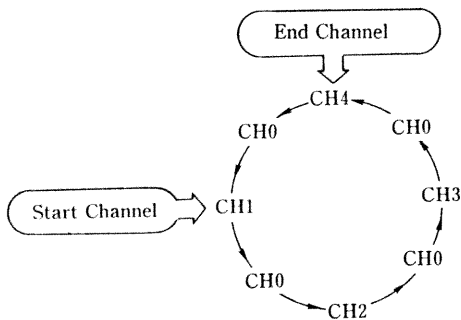

Fig. 6.12 Operating Example of Priority Checking During Memory Scanning

### 6.5.4 Priority checking during sweeping

By turning on the priority checking function during sweeping, priority is given to reception of the frequency in memory channel 0 for one second every five seconds regardless of the sweep speed.

Notes

- 1 This function can't be used when no data in memory channel 0 is stored.
- 2 This function can't be used during transmission.

### 6.6 RIT (receiver increment tuning) Function

This RIT function permits to change only the receiving frequency by maximum +10kHz without changing the transmitting frequency. In case the frequency of the partner's station is deviat-

ed during QSO, the TUNING control (4) works as RIT control for fine-tuning of the receiving frequency by turning on the RIT switch (25). During the RIT operation, the frequency display (28-1) displays the RIT frequency. By pressing the RIT switch again, this function is turned off.

By depressing CLR (PRI) switch (39) during the RIT operation, the RIT frequency is cleared.

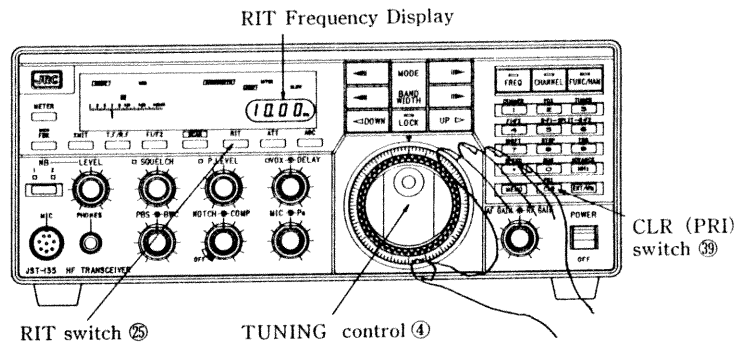

Fig. 6.13 Switches Related to the RIT Function

Notes

1. Even if the frequency display (28-1) is indicating the RIT frequency during reception, it changes to indicate the transmitting frequency when the transceiver becomes transmitting condition.
2. The transmitting and receiving frequency are different during RIT operation. Take special cares when calling other station.

### 6.7 T.F/R.F Function

T.F/R.F switch is provided for reviewing the background VFO (other than currently selected). During the T.F/R.F switch is being pressed, status of background VFO is displayed and it can be modified by usual operation regarding VFO.

For example, during reception by VFO-F1 at the simplex operation, data for background VFO-F2 are displayed on Display (28) while the T.F/R.F switch (22) is being pressed. However, the receiver works based on VFO-F1 (current VFO) and can not receive signals by VFO-F2. During the split reception, data of background VFO is displayed and moreover JST-135 can receive signals based on the background VFO while the switch (22) is being pressed.

Also, while keeping this switch pressed, its frequency can be changed by the TUNING control (4) or ten-key (36).

Note

If the transmitting frequency is set out of the ham bands, the transmitter will not work.

Table 6.1 Operation of T.F/R.F Switch

If pressing the T.F/R.F switch during reception		
	Display	Operation of the receiver
At simplex operation	Status of the background VFO	Reception by the current VFO
At split operation		Reception by the background VFO

If pressing the T.F/R.F switch during transmission		
	Status of the background VFO	* Transmission by the current VFO
At simplex operation	Status of the background VFO	* Transmission by the current VFO
At split operation		* Transmission by the current VFO

\* Reception is not permitted during transmission

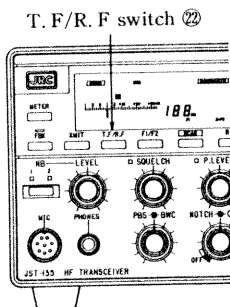

Fig. 6.14 T.F/R.F Switch

### 6.8 VOX Operation

To turn on VOX (voice operated transmission) in the SSB, AM and FM modes, set the FUNC/HAM switch (35) to ON and press the  $\text{VOX}$   $\left[ \begin{array}{c} \text{VOX} \\ 2 \end{array} \right]$  key, then LED placed above the left of the VOX control (5) lights up. Set VOX-ON at the semi-break-in operation in the CW mode.

(1) Adjustment of the VOX gain control

Adjust the gain of the VOX amplifier by the VOX control (5). As turning this control clockwise, the gain increases. Adjust this control for the best VOX operation according to your microphone.

(2) Adjustment of DELAY time

Adjust the transmitting delay time in the VOX operation by using the DELAY control (6). The clockwise rotation increases the delay time. Adjust it to the proper position.

(3) Adjustment of ANTI VOX

VOX may malfunction in response to the sound through the own speaker. Adjust the ANTI VOX volume placed at the

bottom so that VOX does not work in response to the speaker sound. In the case of the transceiver operation with NRD-525 external receiver connected, adjust EXT ANTI VOX placed at the bottom, too. ANTI VOX is not operative when using the headphones.

### 6.9 Voice Compressor

The voice compressor circuit permits to increase the talk power in transmission. The COMP control (11) adjusts the input level to the compressor circuit. The clockwise rotation increases the compression degree. Maximum 20dB compression degree can be obtained. Note that too high compression may deteriorate the sound quality. When the compression degree has been increased, reduce the MIC gain to maintain the constant overall gain by using the MIC control (7). This compressor is operative in all modes (excluding CW mode). When you don't need compression, be sure to rotate the COMP control (11) fully counterclockwise (OFF).

### 6.10 Break-In Operation

JST-135 has two kinds of break-in function, that is semi-break-in and full-break-in.

#### 6.10.1 Semi-Break-In Operation

Set the FBK switch (20) to OFF (LED goes off). Then, turn on the FUNC/HAM switch (35) and press  $\text{VOX}$   $\left[ \begin{array}{c} \text{VOX} \\ 2 \end{array} \right]$  to turn on VOX. When VOX is turned on, LED placed at the left above the VOX control (5) lights up.

By keying down in the above condition, JST-135 becomes transmitting condition and CW signals are transmitted. When the key is released, the transmitting condition is held for a certain time. Adjust this delay time of returning to reception by the DELAY control (6).

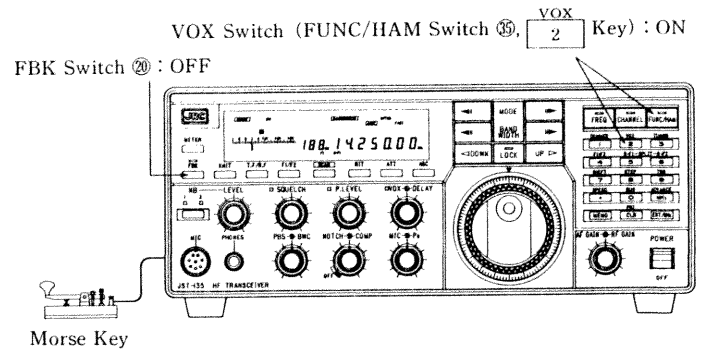

Fig. 6.15 Semi-Break-In Operation

#### 6.10.2 Full-Break-In Operation

Set the FBK switch (20) to ON (LED lights up). By keying down,

JST-135 automatically transmits. By releasing the key, JST-135 returns to receiving condition immediately. Thus, signals can be received between codes even while keying.

**Notes**

1. JRC Linear Amplifier JRL-1000 can't perform full-break-in operation
2. Full-break-in operation is not permitted between different bands even in the same CW mode at the split operation.

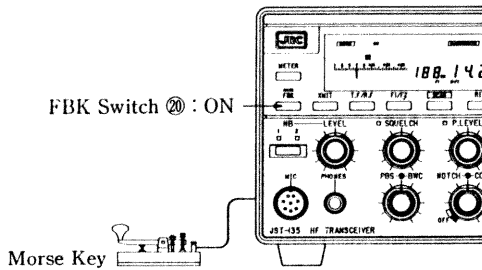

Fig. 6.16 Full-Break-In Operation

**6.11 Synchronizing Frequency in the CW Mode**

Adjust the own frequency to the partner's station's transmitting frequency by the following methods:

**6.11.1 Method (I)**

In this method, the side tone is used for synchronizing. Turn off the FBK switch 20 (LED goes off) and VOX. By pressing the Morse key, the side-tone monitor sound can be heard through the speaker. Adjust the TUNING control 4 so that the frequency of this monitor sound agrees with the tone pitch of the signal of the partner's station (zero beat). Now synchronizing has been completed. Make transmission following instruction described in 6.10 "Break-In Operation". However this method can't be applied when the BFO pitch is set out of 800Hz according to the user definition.

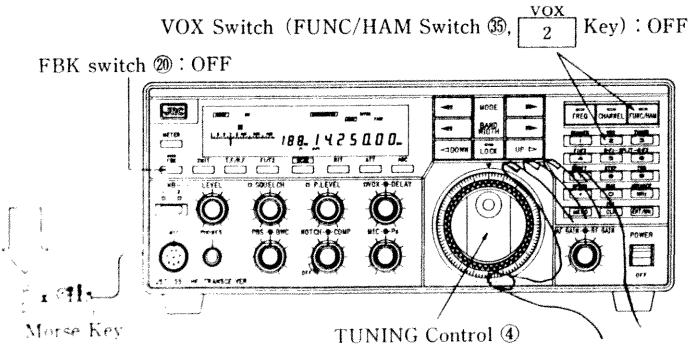

Fig. 6.17 Synchronizing Method in the CW Mode(I)

**6.11.2 Method (II)**

This method can be applied regardless of BFO setting.

The BFO frequency is compulsorily set to 455.0kHz by keeping the METER switch 19 pressed during the CW reception. Adjust the TUNING control 4 as keeping this switch pressed during the CW reception so that the signal of the partner's station gives zero beat.

This method is very convenient since it can be applied to all of BFO pitches without setting VOX to OFF, without setting the FBK switch 20 to OFF at the full-break-in operation.

Press METER Switch 20

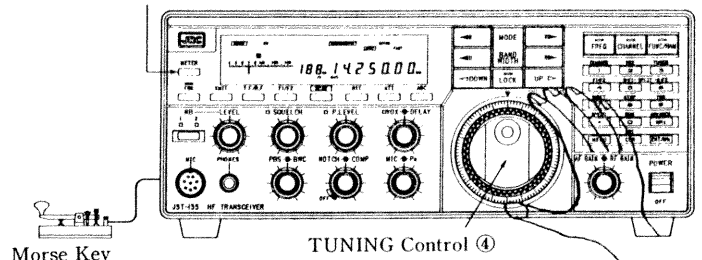

Fig. 6.18 Synchronizing Method in the CW Mode (II)

**6.12 Repeater Operation**

JST-135 can perform the repeater operation by using the shift function (off-set) in the FM mode. In case where the tone is required to activate the repeater, please order optional Tone Squelch Unit CCL-212 and mount it in your JST-135.

The shift width, tone frequency, etc. have been set at the factory as shown in Table 6.2. When activating the repeater different from the following specifications, change those items by user definition. For changing, refer to 6.17 "User Definition".

Table 6.2 Factory Setting of Shift Function

Item	Setting	User Definition No.
Shift direction at transmitting	Minus	1
Shift width at transmitting	100kHz	2
Tone frequency	*88.5Hz	5
Tone system	*CTCSS	4

The items\* are effective only when CCL-212 is mounted.

To turn on the shift function, set FUNC/HAM switch 35 to ON and press the SHIFT key in the FM mode. When the shift function is turned on, the SHIFT indicator on Display 28 lights up. By pressing the PTT switch on the microphone or XMIT switch 21, JST-135 becomes transmitting condition and the frequency is automatically shifted and indicated on the frequency display 28-1. When the optional Tone Squelch Unit is mounted, tone

is automatically added.

To release the shift (off-set) function, set FUNC/HAM switch ⑤ to ON and press <sup>SHIFT</sup> 7 key again.

- Notes
1. The shift (off-set) function is not operative in modes other than FM.
  2. When the transmitting frequency goes out of ham band by the shift (off-set) function, the shift will not work.

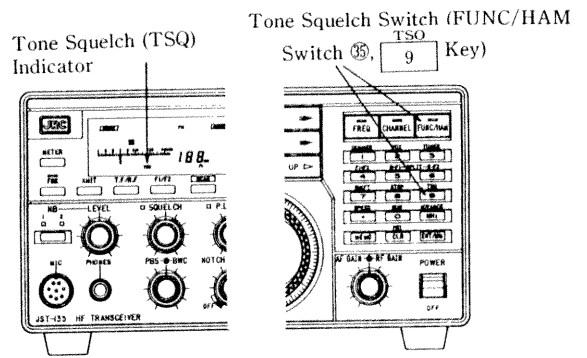

Fig. 6.20 Tone Squelch Switch and Indicator

SHIFT Switch (FUNC/HAM Switch ⑤, <sup>SHIFT</sup> 7 Key)

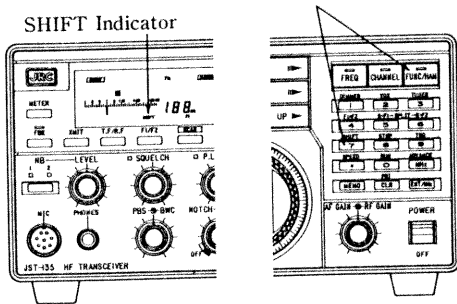

Fig. 6.19 SHIFT Switch for the Repeater Operation

### 6.13 Tone Squelch Operation

By mounting the optional Tone Squelch Unit CCL-212, the tone squelch function can be applied in the FM mode. This tone squelch circuit uses CTCSS (Continuous Tone Coded Squelch System). The tone squelch circuit opens only when the tone frequency of the tone squelch circuit of the own station and that of the partner station agree each other. For setting the tone frequency, refer to 6.14 "User Definition".

To turn on the squelch function, set FUNC/HAM switch ⑤ to ON and press <sup>TSQ</sup> 9 key in the FM mode. When the tone squelch circuit closes, LED placed at the left above the SQUELCH control ⑫ lights up. When receiving the same tone, the tone squelch will open and this LED will go off.

To release the tone squelch operation, set the FUNC/HAM switch ⑤ to ON and press <sup>TSQ</sup> 9 switch again.

- Note
- Be sure to turn the SQUELCH control ⑫ fully counterclockwise at tone squelch operation.

### 6.14 Transceive Operation with an External Receiver

JST-135 can perform the transceive operation in combination with receiver NRD-525. However, NRD-525 and JST-135 require the following optional units.

NRD-525 : RS-232C Interface Unit CMH-532

JST-135 : RS-232C Interface Unit CMH-741

Transceive Cable Set CFQ-3003

The transceive cable set consists of three cables ; interface cable, standby cable and antenna cable.

#### 6.14.1 Connections

Make up connections of transceive cables CFQ-3003 between JST-135 and NRD-525 as shown in Fig. 6.21.

For mounting optional Interface Unit CMH-525 for NRD-525 and optional Interface Unit CMH-741 for JST-135, refer to instruction manuals of those interface units.

- Notes
1. To perform the VOX operation in combination with NRD-525, NRD-525 should be modified. For detailed information, refer to the instruction manual of the transceive cable.
  2. Note that the receiving sensitivity drops by approx. 6dB when connecting the transceive cables.
  3. Very accurate master oscillators are employed in JST-135 and NRD-525. However very slight deviation of these oscillators may cause slight difference of operating frequencies of JST-135 and NRD-525.

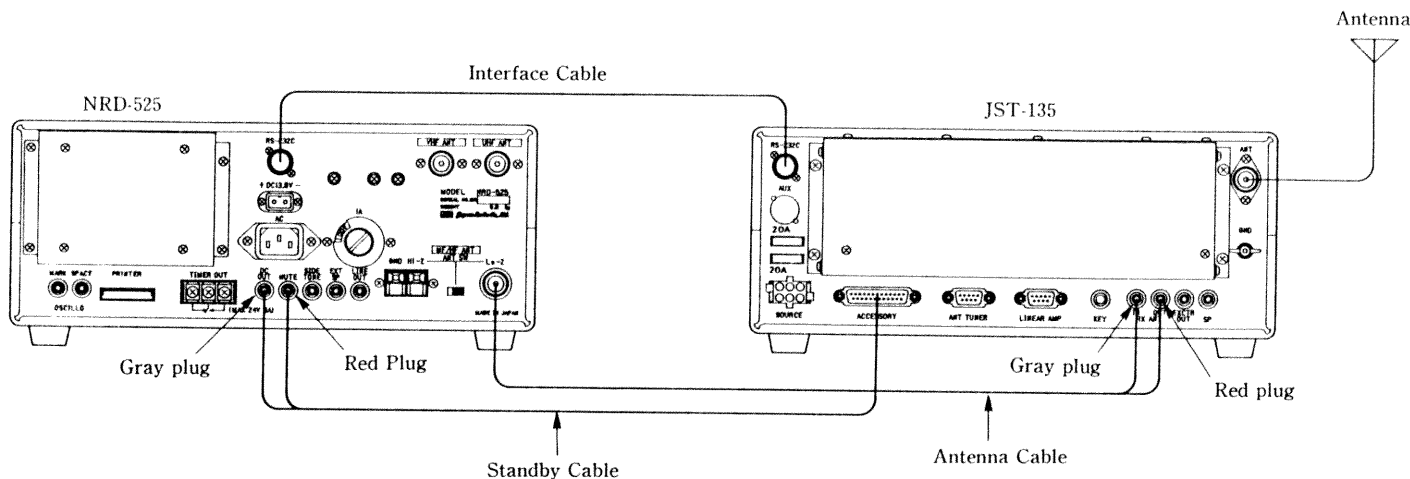

Fig. 6.21 Connections of the Transceiver Cables

### 6.14.2 Transceiver Operation

Operation in combination of JST-135 and NRD-525 is basically classified into the following three kinds of operations.

#### (1) Basic operation

JST-135 and NRD-525 can receive signals at the same time. Transmission is done at the frequency set by JST-135. Thus, JST-135 works as a usual transceiver and NRD-525 works as a usual receiver independently.

#### (2) Transceive 1 (TR1)

Two frequencies can be received at the same time like the basic operation in the above (1). However, the transmission is done at the frequency set by NRD-525. In this transceive operation, TR1 indicator lights up on Display ⑳ of JST-135.

#### (3) Transceive 2 (TR2)

JST-135 works only as transmitter, i.e., receiver part does not work. Namely, a pair of transmitter + receiver is set up. In this operation, VFOs of JST-135 and NRD-525 mutually track completely each other (one VFO follows the other). The both tuning controls work equally. In this transceive operation, TR2 indicator lights up on Display ㉑ of JST-135.

### 6.14.3 Operation

#### (1) Transceive 1 (TR1)

By pressing **DIMMER 1** key while keeping the MEMO switch ④ pressed, transceive 1 operation becomes effective and TR1 indicator lights up on Display ⑳. In this transceive operation, the split function of JST-135 can't be used. Also, by repeating the same operation again, JST-135 and NRD-525 return to the standard operation.

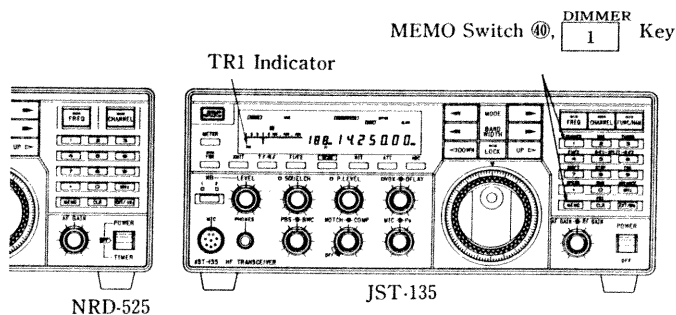

Fig. 6.22 Setting of Transceive 1

#### (2) Transceive 2 (TR2)

By depressing **VOX 2** key while keeping MEMO switch ④ pressed, Transceive 2 operation becomes effective and TR2 indicator lights up on Display ㉑. In this operation, JST-135 is at the muting condition when receiving. But, by pressing T.F/R.F switch ㉒, JST-135 can receive signals by background VFO. By repeating the same operation again, JST-135 and NRD-525 return to the standard operation.

Downloaded by  
RadioAmateur.EU

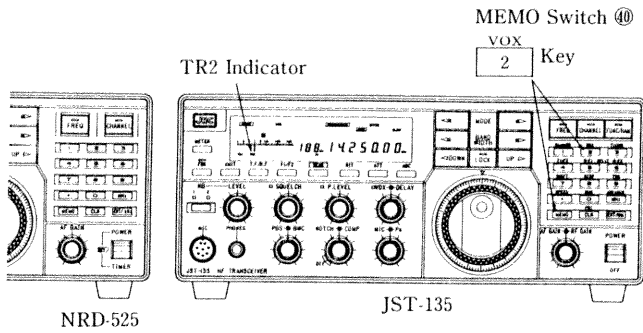

Fig. 6.23 Setting of Transceiver 2

## 6.15 Connection with Peripheral Equipment

### 6.15.1 Electronic Keyer

Connect the electronic keyer by using the supplied KEY plug as shown in Fig. 3.4. The keying circuit of JST-135 operates on +5V TTL level. Therefore, the electronic keyer which uses the mechanical contact such as relay etc. in keying circuit can be used as it is. If you wish to use a keyer composed of the semiconductor keying circuit, choose such a type that the residual resistance is as less as possible at keying down.

**Note**

Do not apply an excessive or any negative voltage to the KEY jack ㉔ because the CW keying circuit of JST-135 working on +5V TTL level may be damaged.

### 6.15.2 Linear Amplifier

When using JRC Linear Amplifier JRL-1000, connect the control cable CFQ-3015 (option) to the LINEAR AMP connector ㉗ on the rear panel of JST-135. When using a linear amplifier other than JRL-1000, refer to Fig. 6.24. In this case, use the D-sub connector on the market (9P plug).

**Note**

No full-break-in operation is available when Linear Amplifier JRL-1000 is connected.

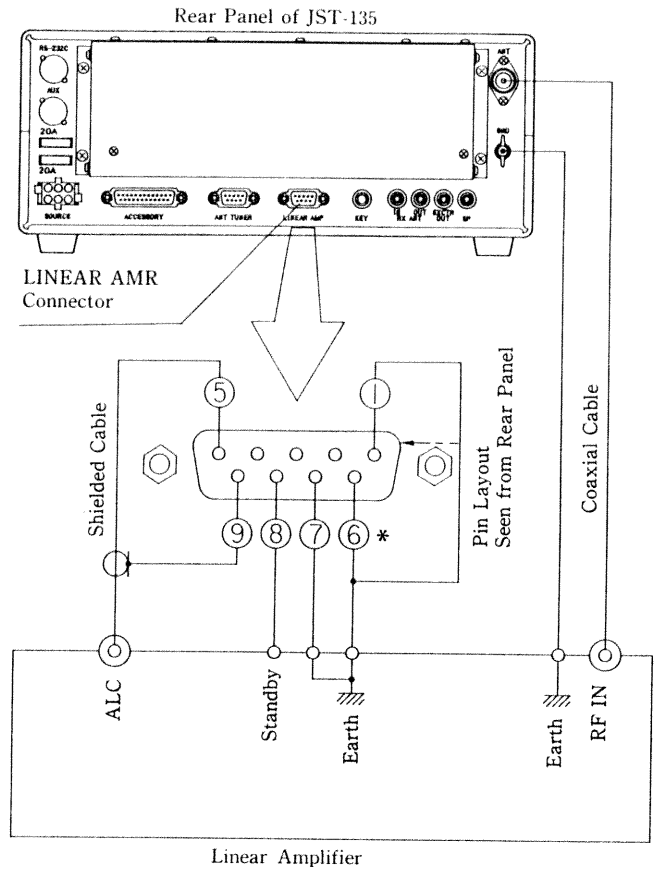

\* Ground pin 6 when using a linear amplifier.

Fig. 6.24 Linear Amplifier Connection

### 6.15.3 Separate Receiver and Receiving Antenna

When you wish to use an exclusive receiving antenna in addition to usual one, connect the antenna to RX ANT IN jack ㉕ on the rear panel. When you wish to use the separate receiver, connect the antenna of the separate receiver to RX ANT OUT jack ㉔. In this case, the internal receiver is disconnected from the antenna circuit.

As for the internal connections of RX ANT IN and OUT jacks, refer to Fig. 4.6.

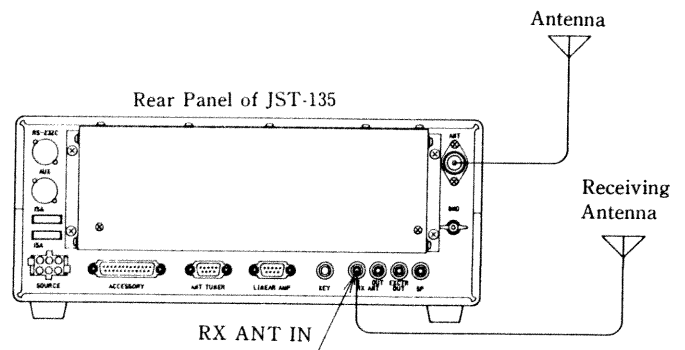

Fig. 6.25 Connection of the Exclusive Receiving Antenna

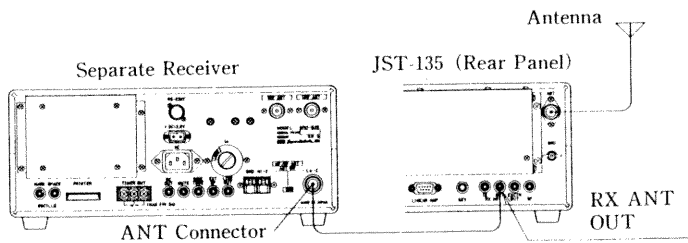
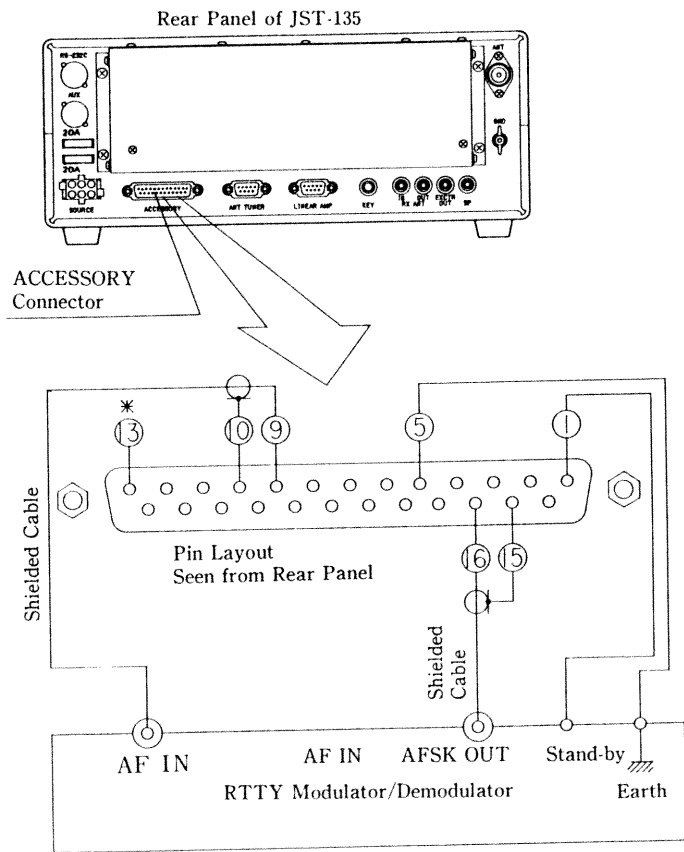

Fig. 6.26 Connection of the Separate Receiver

### 6.15.4 RTTY

To operate the system in the RTTY (AFSK) mode, special modulator and demodulator should be connected. Fig. 6.27 shows the example of connection. For detail, refer to the instruction manual of modulator and demodulator.



\* When using LINE IN1 or 2 (Pin16 or 17) as shown in the above figure, the modulating signal from microphone can be muted by applying +5 to 13.8V to pin 13.

Fig. 6.27 Connection Example of the RTTY Equipment

### 6.16 Changing the Frequency Step

The minimum frequency variable step of the TUNING control ④ (and UP/DOWN switches ⑩) can be changed by using the frequency step changing function. This step can be set for each mode. However, the ratio of the TUNING control ④ to UP/DOWN switches ⑩ is fixed to 1 : 100. The step has been set to 10Hz in all of modes at the factory.

Change the step as follows. First, set FUNC/HAM switch ⑮ to ON and press the  $\text{STEP}$  8 key. The mode and step selected at present are displayed on Display ⑳ and frequency display ㉔ 1 respectively. Select the mode to be changed by the MODE switch ㉑. At this time, USB, LSB, CW and AFSK modes are collectively treated as SSB mode. Select the desired step by the TUNING control ④. Parameters of steps are different depending on the mode. See Table 6.3. Pressing the  $\text{STEP}$  8 key completes the step entry.

Table 6.3 Parameters of Frequency step

Mode	Parameters of frequency step
SSB (USB, LSB, CW and AFSK)	10Hz, 20Hz, 100Hz
AM	10Hz, 100Hz, 1kHz, 5kHz, 9kHz, 10kHz
FM	10Hz, 100Hz, 1kHz, 5kHz, 10kHz, 12.5kHz, 20kHz 40kHz

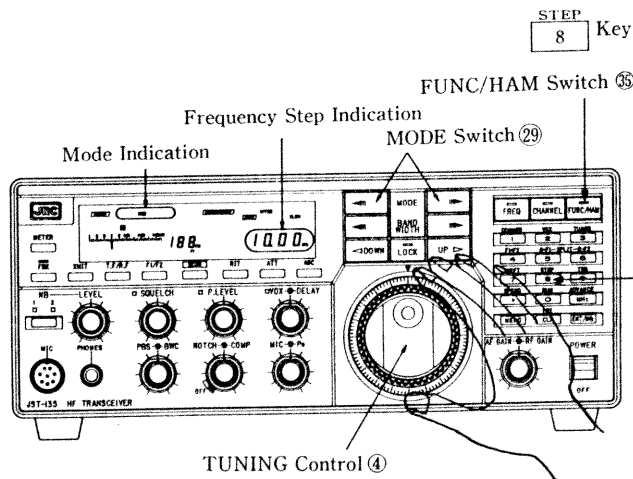

Fig. 6.28 Switches Related to Frequency Step Changing Function

#### Note

The step of RIT frequency can't be changed.

## 6.17 User Definition

JST-135 has user definition function by which some functions and parameters can be changed according to the operating condition.

### 6.17.1 Items of User Definition

#### ● Shift direction at shift function (User definition No.1)

Setting of the shift direction of the shift (off-set) function in the FM mode. Enter 0 to shift in the negative direction from the receiving frequency at transmitting. On the other hand, enter 1 to shift in the positive direction.

#### ● Shift width (User definition No.2)

Setting of the shift width (frequency) by the shift function (off-set) in the FM mode. The desired shift width can be within 0 to 30MHz. If the transmitting frequency is set out of the ham band due to the shift function, the transmitter is not operative.

#### ● Addition of tone at shift function (User definition No.3)

Setting of addition of the transmitting tone at shifting operation in the FM mode. To add the tone, enter 1. When not adding the tone, enter 0.

#### ● Tone system at shift function (User definition No.4)

Setting of the tone system when adding tone at shift (off-set) operation. Enter 0 to set CTCSS system and 1 for burst system.

#### ● Tone frequency (User definition No.5)

Setting of tone frequency to be used for tone squelch and shift (off-set) function. Select the desired one among 37 frequencies from 67.0 to 250.3Hz by the TUNING control ④.

#### ● ON/OFF of EXCTR OUT jack (User definition No.6)

Usually, signals do not appear at the EXCTR OUT (exciter output) jack on the rear panel. Thus, to use the exciter output signal, enter 1 (at this time, the transmitting output does not appear). However, be sure to enter 0 when not using. 0 has been entered at the factory.

#### ● BFO pitch in the CW mode (User definition No.7)

Setting of the BFO pitch at receiving in the CW mode. Select the desired pitch among those from 200Hz to 1.5kHz by using the TUNING control ④. 800Hz has been selected at the factory.

#### ● Selection of frequency display (User definition No.8)

JST-135 has following two kinds of frequency display methods.

##### Ⓐ Frequency indication shift

The synthesizer output frequency is maintained constant when mode is changed. Consequently you will not lose the signal currently receiving even if you change the mode.

##### Ⓑ Local frequency shift

The frequency display is maintained constant when mode is changed. It is convenient for receiving the station whose frequency and mode is known.

At the factory, the frequency indication shift Ⓐ has been selected. To select local frequency shift Ⓑ, enter 1.

#### ● Bypass of the input tuning circuit (User definition No.9)

The variable tuning circuit is provided in the reception front end. This circuit can be bypassed (through) by entering 0, if you wish to cancel very little attenuation of the input tuning circuit to pick up very weak signal. Be sure to select 1, if through condition is not required. At the factory, 1 has been set.

#### ● Baud rate of RS-232C (User definition No. 10)

Baud rate of optional RS-232C Interface Unit can be selected to match the host device connected to JST-135. Baud rate of either 300 or 1200 bauds can be selected for optional RS-232C Interface Unit CMH-741.

#### ● Beep sound (User definition No.11)

The beep sound at key operation can be turned on or off. Entering 0 turns off the beep sound and entering 1 turns on. At the factory, 1 has been set.

#### ● 10-Hz digit display (User definition No.12)

10-Hz digit of the frequency display can be turned on (displayed) or off (not displayed). At the factory, 1 has been set to turn on 10-Hz digit display. To turn off 10-Hz digit display, enter 0.

#### ● Selection of Scan (User definition No.13)

Memory scanning or sweeping will pause if JST-135 receives signal which is higher (stronger) than the level set by the P. LEVEL control ⑨ during memory scanning or sweeping. On the other hand, memory scanning or sweeping also pauses at the level which is weaker than the set level. At the factory, the former pause method (0) has been set. To select the latter method, enter 1.

#### ● Frequency change during transmission (User definition 14)

Either to enable or to disable the frequency change by using the TUNING control ④ during transmission can be selected. At the factory, disabling to change the frequency has been set (0). If 1 is entered, the frequency can be changed during transmission.



Table 6.4 List of User definitions

User definition No.	Item	Parameter	Setting method		Factory Setting
			TUNING Control	Ten-key	
1	Shift direction at shift function	0: Negative direction 1: Positive direction	○	○	0: Negative direction
2	Shift width	0 to 30MHz Arbitrary	○	○	100 kHz
3	Addition of tone at shift function	0: Not addition 1: Addition	○	○	0: Not addition
4	Tone system at shift function	0: CTCSS 1: BURST	○	○	0: CTCSS
5	Tone frequency	67.0 to 250.3Hz 37 kinds of frequency	○	×	88.5Hz
6	ON/OFF of EXCTR OUT jack	0: OFF, 1: ON	○	○	0: OFF
7	BFO pitch in the CW mode	200 to 1500Hz Arbitrary	○	×	800Hz
8	Selection of frequency display	0: Frequency indication shift 1: Local frequency shift	○	○	1: Local frequency shift
9	Bypass of the input tuning circuit	0: Bypass 1: Using	○	○	1: Using
10	Baud rate of RS-232C	0: 300 bauds, 1: 1200 bauds	○	○	1: 1200 bauds
11	Beep sound	0: OFF, 1: ON	○	○	1: ON
12	10-Hz digit display	0: Not displayed 1: Displayed	○	○	1: Displayed
13	Selection of scan	0: Pausing at the higher level 1: Pausing at the lower level	○	○	0: Pausing at the higher level
14	Frequency change during transmission	0: Disable 1: Enable	○	○	0: Disable

## 6.17.2 Setting Method

### (1) Recalling the user definition mode

The user definition mode is recalled by depressing FUNC/HAM switch ③⑤ while keeping MEMO switch ④⑩ depressed. At this time, user definition number is displayed (blinking) on the channel display (28-2), and current status is displayed on the frequency display (28-1). Refer to Table 6.4, as for the parameter of user definition number.

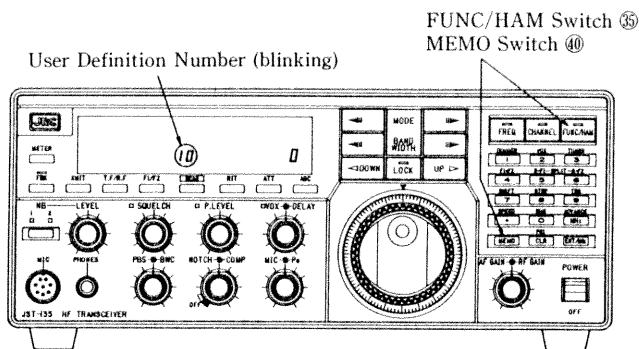

Fig. 6.29 Recalling of User Definition Mode

### (2) Selection of user definition number

User definition number displayed on the channel display (28-2) (blinking) can be changed or selected by the TUNING control ④. Select the desired one. Entry of the definition number is completed by depressing the MEMO switch after selecting, then, frequency display (28-1) blinks.

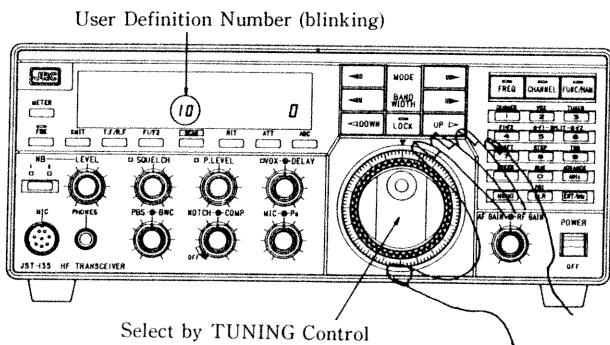

Fig. 6.30 Selection of User Definition Number

### (3) Change of parameter of definition

The parameter of user definition blinks on the frequency display (28-1) after completing entry of the user definition number in the above (2).

Change the parameter of user definition by using the TUNING control ④ or ten-key ③⑤, if necessary. Refer to Table 6.4, as for changing and selecting methods.

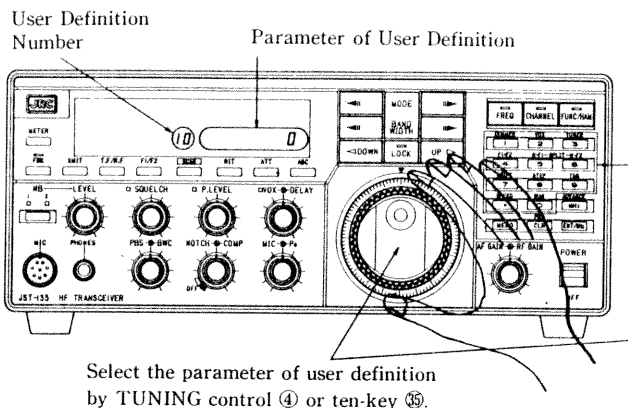

Fig. 6.31 Change of the Parameter of User Definition

### (4) Establishment of the parameter of user definition

The parameter of user definition is established by pressing the MEMO switch ④⑩ after changing or selecting by the operation described in the above (3).

User definition number blinks again on the channel display (28-2). To set other user definition, repeat the operation in and after (2).

If you finish the setting, press FUNC/HAM switch ③⑤ while keeping MEMO switch ④⑩ pressed to exit from user definition mode and return to normal operation. Also JST-135 will automatically return to the normal operation mode if the TUNING control and ten-key operation are not performed for more than five seconds.

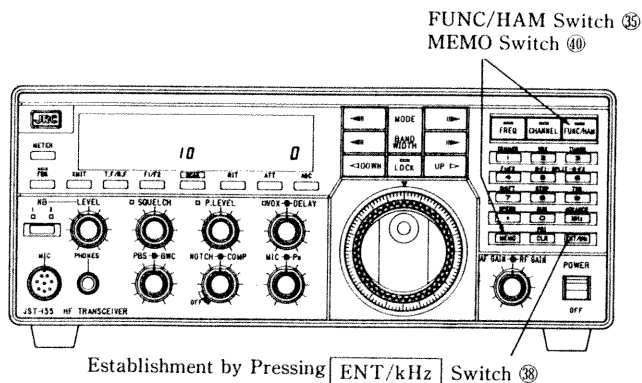

Fig. 6.32 Establishment of the parameter of User Definition and Exit

# 7. MAINTENANCE AND CHECK

JST-135 has been completely adjusted and passed the strict quality control at the factory. There is, therefore, no need to readjust before use.

Detailed adjustments other than those described in this chapter requires well trained techniques and sophisticated measuring instruments. If required, please consult the sales office where you bought the transceiver, or JRC.

## 7.1 Adjustment

Use the screw driver with sharp tip when adjusting the following trimmer.

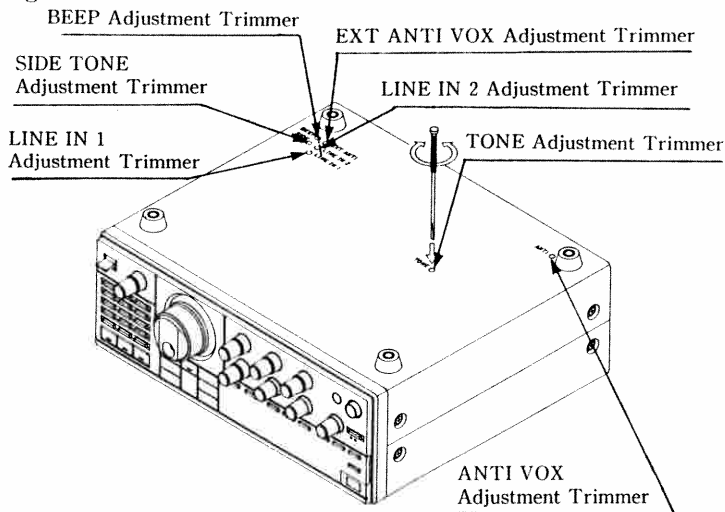

Fig. 7.1 Location of Holes for Adjustment Trimmers on the Bottom of JST-135

### (1) ANTI VOX adjustment trimmer

When VOX malfunctions due to the sound through the speaker, adjust this trimmer so that VOX operates correctly.

### (2) TONE control trimmer

Received tone is varied by this TONE control. Adjust it so as to obtain the desired tone quality.

### (3) LINE IN 1 and 2 adjustment trimmer

Trimmer for adjusting the external modulation input level of LINE IN 1 and 2 of ACCESSORY connector on the rear panel. At the factory, this trimmer was adjusted so that the rated output can be obtained at approx. 0dBm input in the SSB mode.

### (4) EXT ANTI VOX adjustment trimmer

At the VOX operation by connecting the external receiver, VOX may malfunction due to the sound through the speaker of the external receiver. In such case, adjust this trimmer so

that VOX operates correctly.

### (5) SIDE TONE adjustment trimmer

Trimmer for adjusting the sound volume of the side tone monitor in the CW mode. Adjust it to get adequate volume of side tone.

### (6) BEEP adjustment trimmer

Beep sounds through the speaker when key is pressed or erroneous operation is made. This trimmer is used for adjusting the volume of this beep.

## 7.2 Power-Down to 50W

In some countries it is regulated by the Radio Regulations that the antenna power for a mobile station is 50W. Since JST-135 has been set to 150W output at the factory, reduce the power to get 50W in the following procedure.

- (1) Remove the top cover according to 7.3 "Removal of the Covers".
- (2) Pull up the CPU Unit CDC-493A slowly and take out. Refer to 7.4 "Layout of Units" as for location of the CPU Unit.
- (3) Cut RJ0 among jumper wires placed around the center of parts mounting side of this unit.
- (4) Now, the power is set to 50W in all of bands. Place the unit and covers as they were.

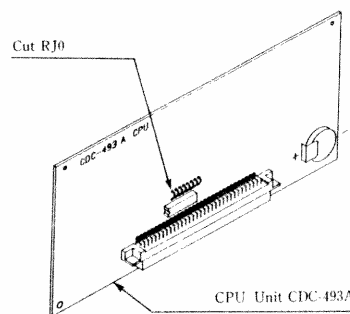

Fig. 7.2 Location of RJ0 on the CPU Unit

### Notes

1. Be careful not to break the cable of the speaker attached to the top cover when removing the cover.
2. Do not short-circuit the solder side pattern because the lithium battery for memory back-up is built in this CPU Unit.
3. Be sure to insert the unit surely when placing the unit again.

### 7.3 Removal of the Covers

The top cover and bottom cover are fixed by four screws respectively. Remove them as shown in Fig. 7.3. The speaker is attached to the top cover. Remove the speaker cable connected to the internal unit as required.

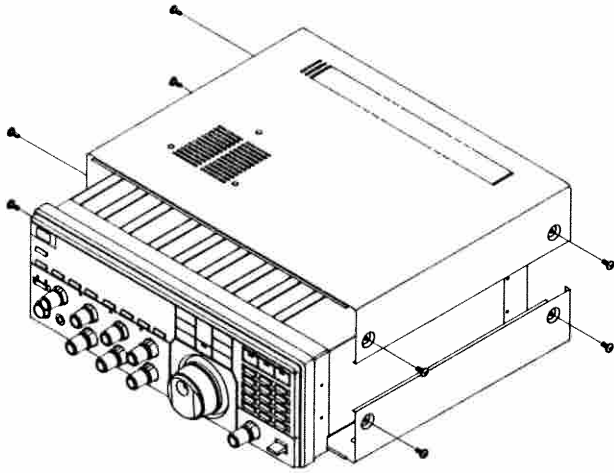

Fig. 7.3 Removal of the Covers

#### Note

Be sure to turn off the POWER switch ① and disconnect the power cable before removing the covers. Pay special attention to the loud speaker cable.

### 7.5 Maintenance

#### 7.5.1 Parts

Be careful when handling ICs, transistors and diodes because momentary short-circuiting will damage them.

#### 7.5.2 Fuses

If the power fuses have blown, check the cause of the trouble before replacement, and replace fuses with those having the same capacity. JST-135 uses two 20-A fuses. Be sure to use two fuses with the same capacity. Do not use fuses with different capacities. If you require fuses more than the supplied ones, please buy 20A auto-fuse at car dealer or gas station.

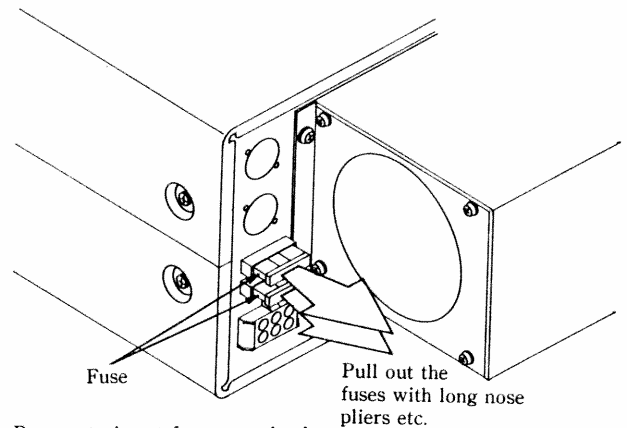

\* Be sure to insert fuses completely.

Fig. 7.5 Replacement of Fuses

#### Note

Be sure to turn off the POWER switch ① and disconnect the power cable, when replacing fuses.

### 7.4 Layout of Units

Internal units of JST-135 are located as shown in Fig. 7.4.

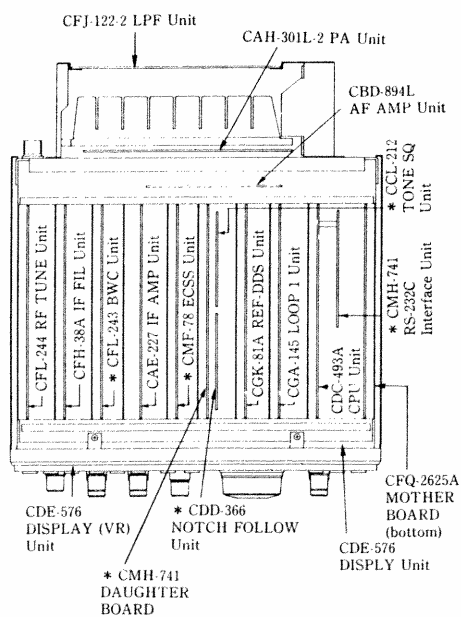

The units marked \* are optional.

Fig. 7.4 Layout of Units (seen from the top)

#### 7.5.3 Adjustment of Standard Oscillator

- (1) Remove the top cover according to 7.3 "Removal of Covers".
- (2) Do not disconnect the internal-speaker cable. If disconnection is required, connect an external speaker to the SP jack ⑫ on the rear panel.
- (3) Turn on the POWER switch ① and receive the standard frequency station (WWV, etc.) in the CW mode. At receiving tune up to 10-Hz digit.
- (4) While keeping the METER switch ⑰ pressed, adjust the trimmer on the REF-DDS Unit CGK-81A as shown in Fig. 7.6 to obtain the zero-beat.
- (5) Turn off the POWER switch ① and replace the top cover.

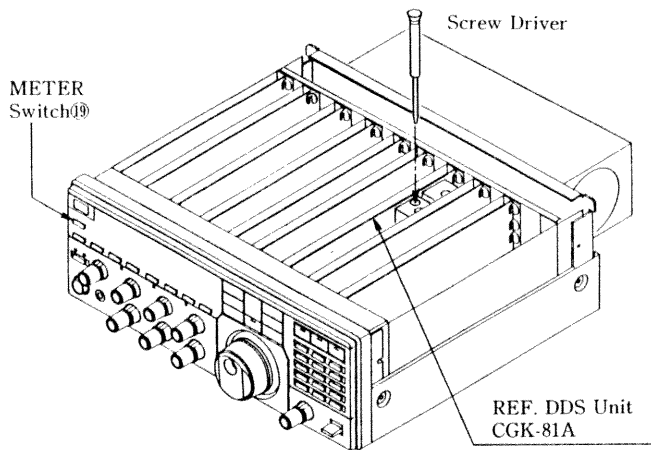

Fig. 7.6 Adjustment of Standard Oscillator

#### 7.5.4 Lithium Battery

The lithium battery is used for backup of the memory. The life of this battery is about five years.

If the stored data in the memory is abnormal or data can't be stored during operation, the life time of the battery has expired. Thus, replace the battery. The type of the battery is CR-2032FT-6 (manufactured by Sanyo; 3V). When it is hard to buy the lithium battery or you want to ask the battery replacement, please consult the sales office where you bought the transceiver, or JRC.

#### ● Replacement of lithium battery

- (1) Turn off the POWER switch ① and disconnect the power cable.
- (2) Remove the top cover according to 7.3 "Removal of Covers".
- (3) Pull up the internal CPU Unit CDC-493A slowly and take out.
- (4) Replace the lithium battery as shown in Fig. 7.7.
- (5) Place the unit to original position.
- (6) Replace the top cover.

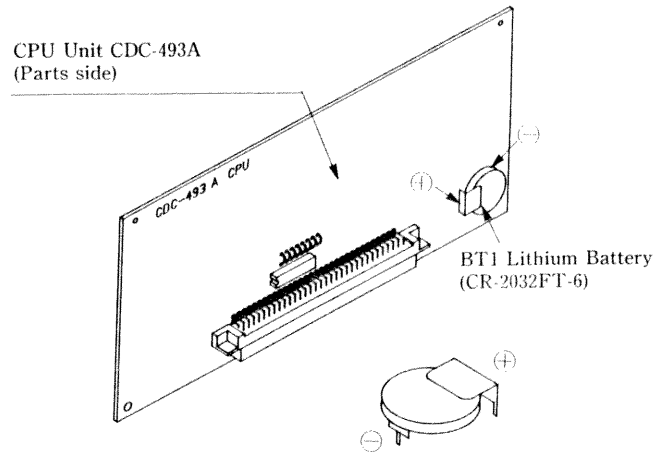

Remove the old battery, and mount the new one by soldering three points. The soldering must be performed quickly to prevent overheating the battery. Take care not to short-circuit the battery.

Fig. 7.7 Replacement of the Lithium Battery

#### Note

When the battery is replaced, frequencies, user definitions, etc. memorized will be erased. Reset them after replacement of the battery.

Downloaded by  
RadioAmateur.EU

# 8. CAUTIONS ON OPERATION

## Caution at mobile operation

There are many frequencies of radio stations for business use near the ham band and they are used. If radio waves are emitted at close distance of those radio stations, unexpected radio interference may occur even though the amateur station conforms to Radio Regulations. So, be careful when using the equipment near those business radio stations. Obtain an administrator's approval if it is required to operate the equipment.

The amateur radio wave may cause radio interference against TV, radio, stereo set, etc.. Of course, it is hard to say that all of troubles are caused by the amateur station. Radio manufacturers

also do their best to prevent undesired radiation such as spurious, etc. and adjust and inspect their products very carefully. However, if radio interference, etc. are found during operation, please stop transmission immediately and take countermeasures correctly.

- (1) An amateur station should stop transmission and check interference according to Radio Regulations, if the radio waves from the amateur station interferes the reception of TV, radio, etc..
- (2) When resulting in that the interference is caused due to own station, check the transmitter and antenna system and take proper countermeasures to the interference.

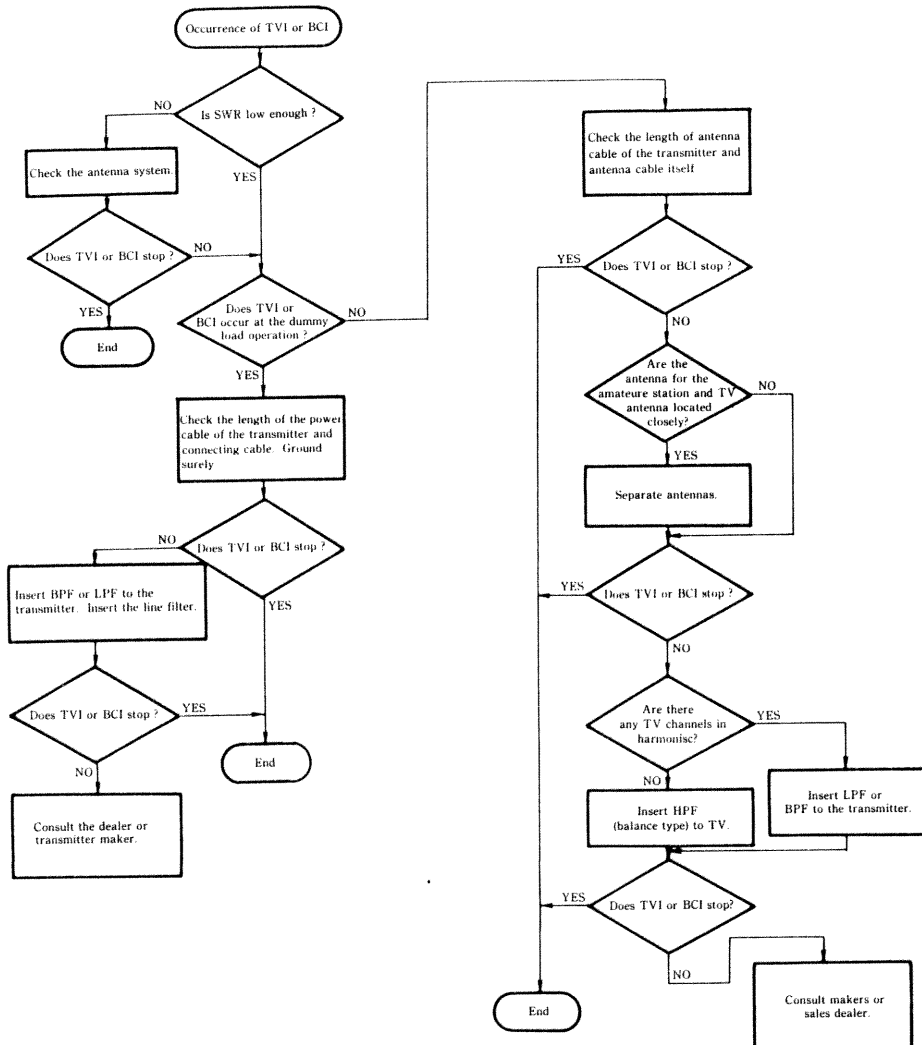

Fig. 8.1 Flow Chart for Countermeasures to TVI or BCI

## 9. TROUBLESHOOTING GUIDE

JST-135 has various functions, thus the transceiver may not operate as you desired, if operating it incorrectly. Before imputing such a case to an equipment failure, read the associated operating procedures in this manual once again.

This chapter describes various symptoms caused by misoperations and mistakes in the installation, handling and operations.

### 9.1 Troubleshooting in reception

Any of these symptoms is not failure. We hope you will thoroughly investigate them before asking for repairment. If, however, the transceiver will still not operate normally, investigate the symptom thoroughly and contact with the sales office where you bought the transceiver, or JRC.

No.	Symptom	Causes	Countermeasures
1	No display with POWER switch on	<ul style="list-style-type: none"> <li>①Poor connection at source connector</li> <li>②Fuse blown</li> <li>③Poor connection at AC power connector</li> <li>④Fuse of power supply blown</li> <li>⑤Reversed polarity of DC power supply</li> </ul>	<ul style="list-style-type: none"> <li>①Check the connection at the connector.</li> <li>②Investigate the cause and replace with new fuses with the same capacity.</li> <li>③Completely insert the connector.</li> <li>④Same as 2.</li> <li>⑤In the reversed polarity, the power will not be on. Make a correct connection.</li> </ul>
2	With POWER switch on, the frequency display works, but no sound	<ul style="list-style-type: none"> <li>①Headphones is connected.</li> <li>②Squelch is closed.</li> <li>③The XMIT indicator lights up and the transceiver is in the transmitting condition.</li> <li>④AF GAIN control is set to fully counterclockwise position.</li> </ul>	<ul style="list-style-type: none"> <li>①Disconnect the headphones.</li> <li>②Set Squelch to off.</li> <li>③Set PTT or the XMIT switch to OFF.</li> <li>④Adjust it for desired sound volume.</li> </ul>
3	Dim displays	The DIMMER control is set to the minimum position.	Set the control for desired illumination.
4	S-meter deflects at no signals	RF GAIN control is not turned fully clockwise.	Turn the RF GAIN control fully clockwise.
5	The received sound distorted and bad articulation	<ul style="list-style-type: none"> <li>①AGC is set to OFF.</li> <li>②The receiving frequency is shifted.</li> <li>③The notch filter is set to ON.</li> <li>④Wrong selection of the MODE switch</li> <li>⑤The PBS control is not set at the center.</li> <li>⑥The BWC control is not rotated fully counterclockwise.</li> <li>⑦NB operates.</li> </ul>	<ul style="list-style-type: none"> <li>①Set AGC to FAST or SLOW.</li> <li>②Retune.</li> <li>③Set the notch filter to OFF.</li> <li>④Select the correct MODE switch position according to the receiving signal.</li> <li>⑤Set the PBS control to the center position.</li> <li>⑥Turn the BWC control fully counterclockwise.</li> <li>⑦Set NB to OFF.</li> </ul>
6	No frequency change by rotating the TUNING control. Switch operations are impossible.	The LOCK switch is set to ON.	Set the LOCK switch to OFF.
7	Poor sensitivity	ATT is set to ON.	Set ATT to OFF.
8	BANDWIDTH switch is not activated in the SSB, CW and AFSK modes.	The optional filter is not mounted.	Mount the optional filter.

## 9.2 Troubleshooting in Transmission

No.	Symptom	Causes	Countermeasures
1	No output with the XMIT switch ON.	<ul style="list-style-type: none"> <li>①Po control is turned fully counter-clockwise.</li> <li>②The transmitting frequency is out of the ham band.</li> <li>③0 is displayed.</li> </ul>	<ul style="list-style-type: none"> <li>①Turn this control fully clockwise.</li> <li>②Impossible to transmit out of the ham band. Set the frequency in the ham band.</li> <li>③Transmission is impossible when frequency data is not stored in the memory.</li> </ul>
2	No output in the SSB mode	<ul style="list-style-type: none"> <li>①MIC control is turned fully counter-clockwise.</li> <li>②Poor microphone</li> </ul>	<ul style="list-style-type: none"> <li>①Turn the MIC control clockwise for the desired level.</li> <li>②Check the microphone</li> </ul>
3	No output by keying down in the CW mode	<ul style="list-style-type: none"> <li>①VOX is set to OFF in the semi-break-in operation.</li> <li>②Full-break-in operation is not selected.</li> <li>③Poor key</li> </ul>	<ul style="list-style-type: none"> <li>①Set VOX to ON.</li> <li>②Set the FBK switch to ON.</li> <li>③Check the key</li> </ul>
4	Low reading of Ic and high reading of REF on meters during transmission	<ul style="list-style-type: none"> <li>①The antenna is not connected.</li> <li>②SWR of the antenna is high.</li> </ul>	<ul style="list-style-type: none"> <li>①Check the antenna</li> <li>②Adjust the antenna.</li> </ul>
5	Poor SSB, AM and FM sound in transmission	<ul style="list-style-type: none"> <li>①The distortion is caused due to too high microphone input level.</li> <li>②The COMP control is set too high.</li> </ul>	<ul style="list-style-type: none"> <li>①Adjust the MIC control.</li> <li>②Adjust the COMP control.</li> </ul>



# 10. PERIPHERAL EQUIPMENT AND OPTIONS

## 10.1 Peripheral Equipment and Options

To operate JST-135 more effectively and comfortably, the following options are prepared.

Automatic Antenna Tuner NFG-230

This automatic antenna tuner is idealistic full-automatic antenna tuner which allows to operate in all bands with one antenna. The matching can be performed in a few seconds by one-touch operation. It is housed in a water-proof case and it can be installed at any place.

Frequency range	1.8 to 30MHz
Maximum input power	200W PEP
Matching range	Resistance 5Ω to 1kΩ Capacitance 150PF or more
Input SWR	1: 1.5 or less (depending on the antenna used)
Tuning time	2 to 4 seconds, nominal At memory, 50 milliseconds or less
Rated voltage	13.8V/24V DC ±15%
Current drain	1.5A or less
Dimensions	230×380×90mm (w/h/d) (not including projecting parts)
Weight	Approx. 3.5kg

(The control cable of 20m is supplied.)



NFG-230

NFG-97 Antenna Tuner

This antenna tuner is composed of a matching circuit which converts an impedance of antenna into 50Ω and the measuring circuits which measures SWR, forward power and reflected power. This tuner can be also applicable to new WARC bands.

Frequency range	1.8 to 29.7MHz amateur bands (including WARC bands)
Maximum input power	200W CW (1.8MHz band 200W PEP)
Matching range	SWR 1: 3.0 maximum (unbalanced)
Input impedance	50Ω
Power measurement	200W/20W/2.5W full scale (both forward and reflected power)
VSWR measurement	1: 10 maximum
Dimensions	180×130×273mm (w/h/d)
Weight	Approx. 3.3kg



NFG-97

HF Linear Amplifier JRL-1000

This linear amplifier offers you a high-power operation. The parts as those used for commercial transmitter are employed for highly reliable operation. This linear amplifier provides its utmost functions and performance in combination with JST-135.

Frequency range	1.8 to 30MHz
Rated input	2000W DC
Vacuum tube	8122×3 (RCA)
Driving power	Maximum 80W
Input impedance	50Ω (unbalanced)
Output impedance	50Ω (4.5Ω to 200Ω unbalanced)
Power supply	100/110/200/220V AC±10% 50/60Hz single phase
Power consumption	Approx. 3kVA
Dimensions	520×925×450mm (w/h/d)
Weight	Approx.100kg

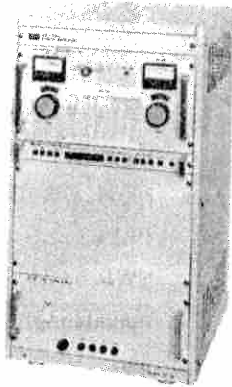

JRL-1000

Power Supply NBD-520G/U

NBD-520 is a high performance power supply for operating JST-135 on AC power source. This Power Supply has been designed to optimize proper performance of the transceiver, while taking account of safety, in addition to the appearance designed matched to JST-135 transceiver.

Input voltage	120V AC (U), 220V AC (G) ± 10%
	50/60Hz signal phase
Output	13.8V DC 30A (intermittent)
Dimensions	180 × 130 × 273mm (w/h/d)
Weight	Approx. 9kg

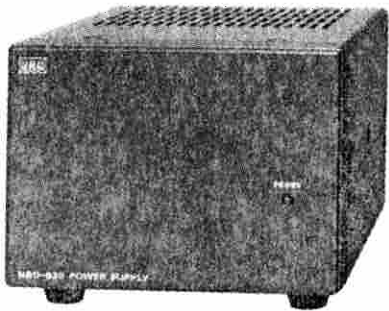

NBD-520G/U

Speaker NVA-88

Separate type speaker has been designed to match with the transceiver JST-135.

Input impedance	4Ω (nominal)
Maximum input power	3W
Dimensions	180 × 130 × 273mm (w/h/d)
Weight	Approx. 2.5kg

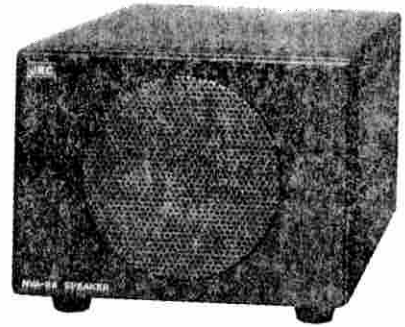

NVA-88

Desk Microphone NVT-56

Sensitivity	-70dB ± 4dB (0dB : 1V/μBAR, 1000Hz)
Impedance	600Ω (nominal)
Directivity	Non-directional
Weight	Approx. 350g

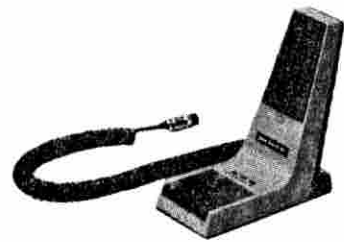

NVT-56

Hand Microphone NVT-57

Sensitivity	-70dB ± 4dB (0dB : 1V/μBAR, 1000Hz)
Impedance	600Ω (nominal)
Directivity	Non-directional
Weight	Approx. 150g



NVT-57

- Hand Microphone with UP/DOWN Switches NVT-58
- |             |                                     |
|-------------|-------------------------------------|
| Sensitivity | -70dB±4dB (0dB: 1V/μBAR,<br>1000Hz) |
| Impedance   | 600Ω (nominal)                      |
| Directivity | Non-directional                     |
| Weight      | Approx. 150g                        |



NVT-58

- BWC Unit CFL-243

CFL-243 is the BWC (bandwidth control) Unit which controls pass bandwidth continuously without changing the center frequency of the receiving IF filter. This unit can be mounted in JST-135.

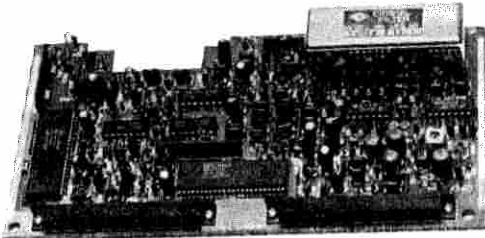

CFL-243

- ECSS Unit CMF-78

CMF-78 is the ECSS Unit which extracts the not-interfered side band without using the narrow band filter so as to eliminate the interference, in the AM reception. This unit can be mounted in JST-135.

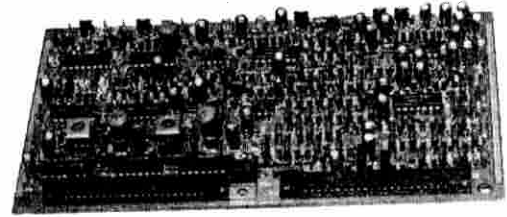

CMF-78

- RS-232C Interface Unit CMH-741

CMH-741 is the RS-232C Interface Unit which is used to remotely control the frequency, mode, etc. with an external device (such as computer) or to perform the transceive operation in combination with NRD-525. This unit can be mounted in JST-135.

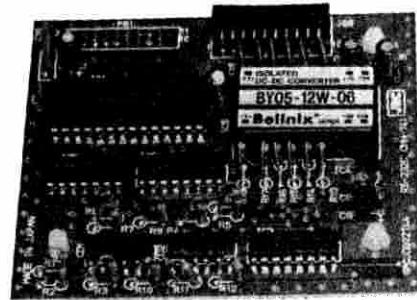

CMH-741

- Tone Squelch Unit CCL-212

CCL-212 is the Tone Squelch Unit which is used in the FM mode and in 28MHz band repeater operation. This unit can be mounted in JST-135. However, to mount this unit, the Daughter Board CMH-742 is required.

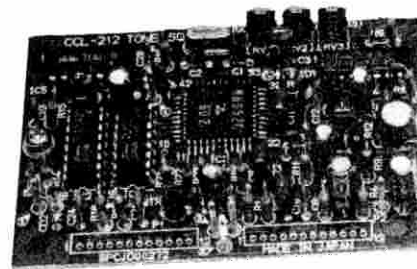

CCL-212

- Notch Follow Unit CDD-366

CDD-366 is the Notch Follow Unit used for linking the notch filter frequency to the receiving tuning frequency. This unit can be mounted in JST-135. However, to mount this unit, the Daughter Board CMH-742 is required.

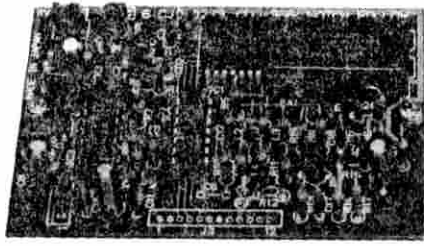

CDD-366

Daughter Board CMH-742

This Daughter Board is required to mount the Tone Squelch Unit CCL-212 and/or Notch Follow Unit CDD-366. Onto this board, both Tone Squelch Unit and Notch Follow Unit can be mounted. Thus, if this board has been already mounted to mount one of the two, the other Daughter Board is not required when mounting the other unit.

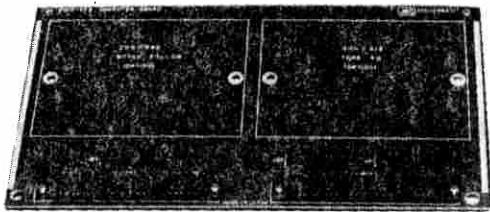

CMH-742

IF Filter

Crystal filters for SSB, CW and AFSK operations. The following five types are available. Up to two of them can be mounted in JST-135.

	6dB bandwidth
CFL-231	300Hz
CFL-232	500Hz
CFL-233	1kHz
CFL-218A	1.8kHz
CFL-251	2.4kHz

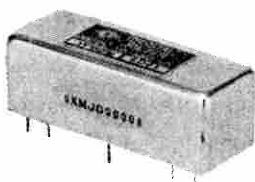

Crystal filter

High Stable Crystal Kit CGD-135

If this high stable crystal kit is attached to the reference frequency oscillator in JST-135, the frequency stability within  $\pm 0.5\text{PPM}$  can be obtained at the temperature range from  $-20^{\circ}\text{C}$  to  $+50^{\circ}\text{C}$ . (At mounting, the frequency adjustment is required.)

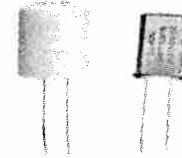

CGD-135

Transceive Cable Set CFQ-3003

Transceive cable set required for transceive operation by connecting the separate receiver NRD-525.

Morse Key KY-3A

Morse key in the CW mode

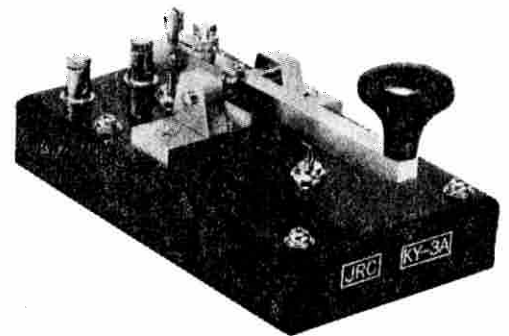

KY-3A

Headphones ST-3

Headphones designed for professional operator.



ST-3

**10.2 Mounting of Options**

Be sure to turn off the POWER switch ① and disconnect the power cable before starting to work. It is not recommended to remove units which are not related to mounting of options.

### 10.2.1 Mounting of Units

Fig. 7.4 shows the location to insert the optional units. Be careful not to insert the unit into the wrong position. As for mounting Tone Squelch Unit CCL-212, Notch Follow Unit CDD-366 or RS-232C Interface Unit CMH-741, please refer to instruction manual of the unit.

### 10.2.2 Mounting of IF Filters

Up to two IF filters including \*1 and \*2 can be mounted as shown in Table 4.1. The filter used for \*1 should be mounted to the position for FL6 of IF Filter Unit CFH-38A, and the filter used for \*2 should be mounted to the position for FL5 shown in Fig. 10.2.

● To mount :

- (1) Remove the top cover according to 7.3 "Removal of the Covers".
- (2) Take out IF Filter Unit CFH-38A.
- (3) Mount the optional IF filter(s) as shown in Fig. 10.2
- (4) Insert the unit into the right place. Be sure to insert the unit surely along the rails.
- (5) Mount the top cover.

Then, the criteria of filters which were mounted should be registered.

● To register the criteria of filters :

- (1) Press the FUNC/HAM switch ⑮ with MEMO switch ④ pressed to select user definition mode.
- (2) Enter user definition number by ten-key ⑮ following Table 10.1, depending on the mounted filter(s).

Example : To set "21" .

Press ,  and .

- (3) Set the parameter by using the TUNING control ④ or ten-key ⑮. After setting, press the ENT/kHz switch ⑮ to complete entry of the parameter.
- (4) To set more, repeat operations in and after (2).
- (5) Lastly, by repeating the operation described in (1), JST-135 returns to the normal operating condition.

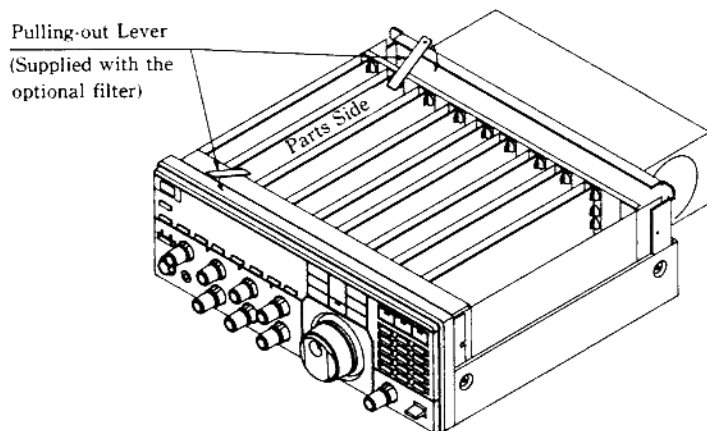
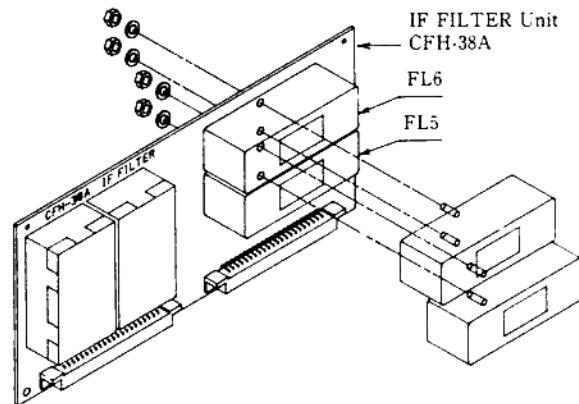

Fig. 10.1 Removing of IF Filter Unit



Mount filter(s) onto the unit by using the nuts and washers supplied with the filter(s). Solder four points for each filter after mounting.

Fig. 10.2 Mounting of IF Filter(s)

Table 10.1 Setting of the Filter According to User Definition

User definition No.	Item	Parameter
21	Distinction of FL6 filter (Position of *1 in Table 4.1)	0: No filters
		1: For CW
22	Distinction of FL5 filter (Position of *2 in Table 4.1)	2: For SSB

# 11. BLOCK DIAGRAMS

## 11.1 Signal Flow

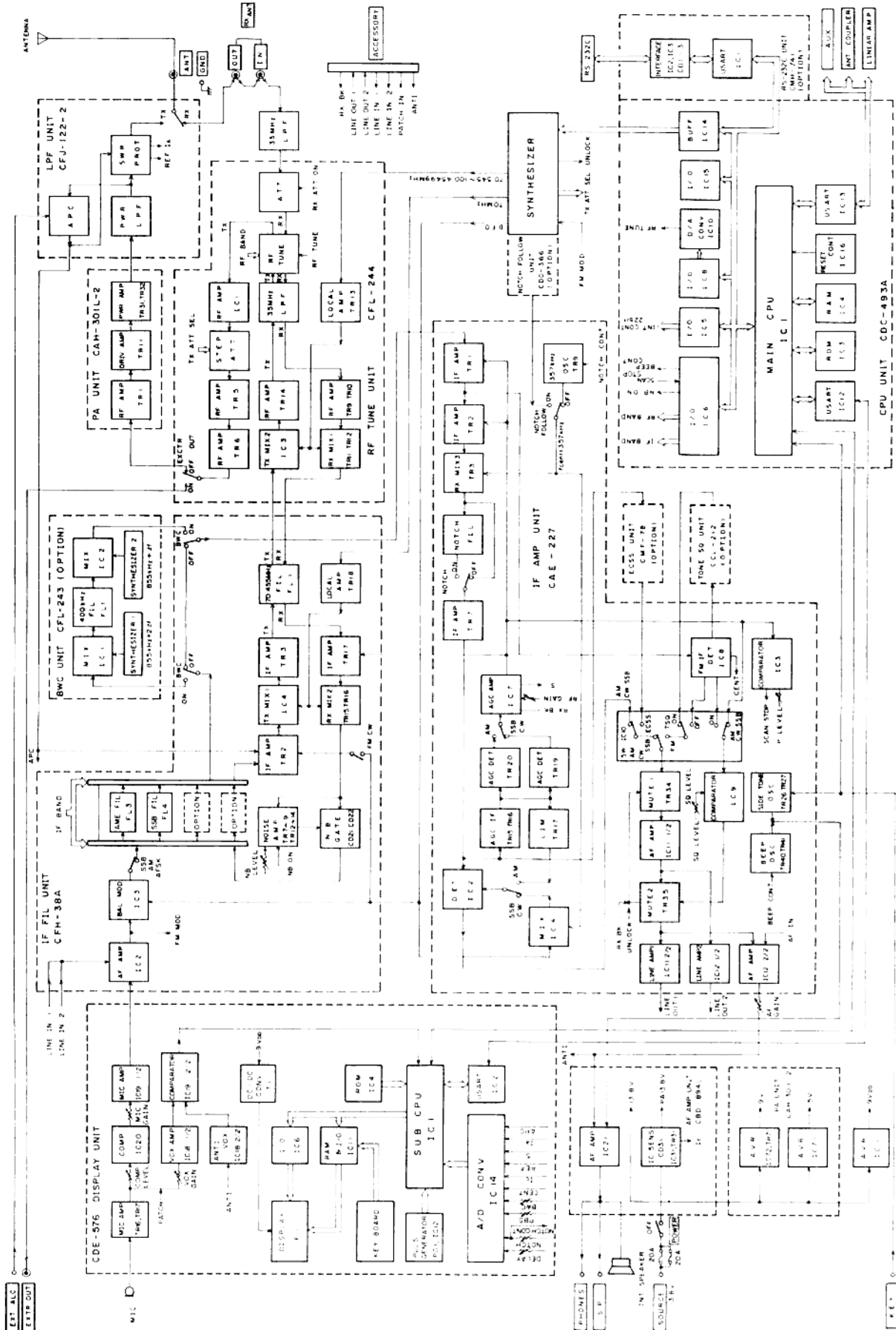

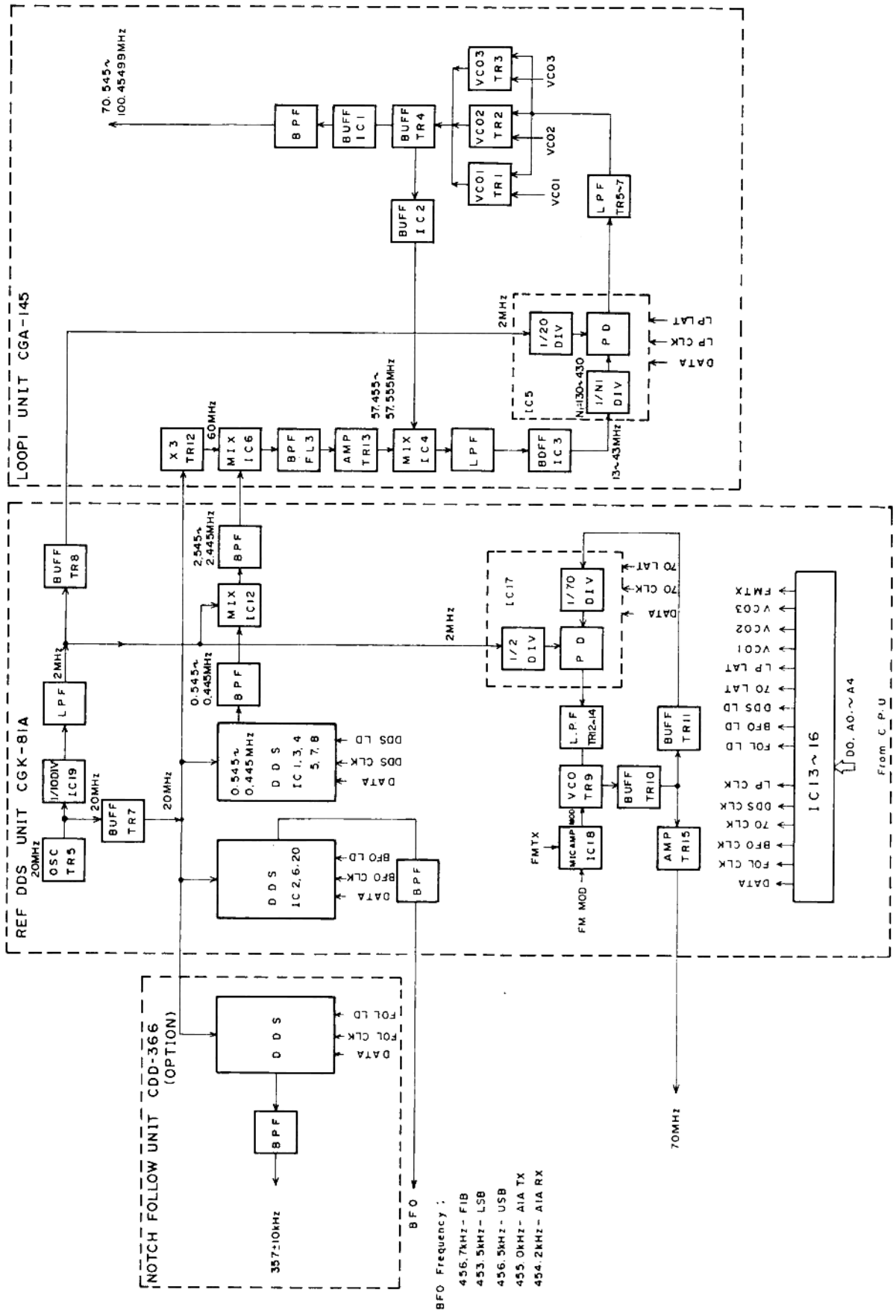

# 12. CIRCUIT DIAGRAMS

12.1	RF TUNE UNIT	CFL-244
12.2	IF FILTER UNIT	CFH-38A
12.3	IF AMP UNIT	CAE-227
12.4	PA UNIT	CAH-301L-2
12.5	LPF UNIT	CFJ-122-2
12.6	LOOP 1 UNIT	CGA-145
12.7	REF DDS UNIT	CGK-81A
12.8	CPU UNIT	CDC-493A
12.9	DISPLAY UNIT	CDE-576
12.10	DISPLAY (VR) UNIT	CDE-576
12.11	AF AMP UNIT	CBD-894L
12.12	Overall Circuit Diagram (I)	
	MOTHER BOARD	CFQ-2625A
	CHASSIS	JST-135
12.13	Overall Circuit Diagram (II)	



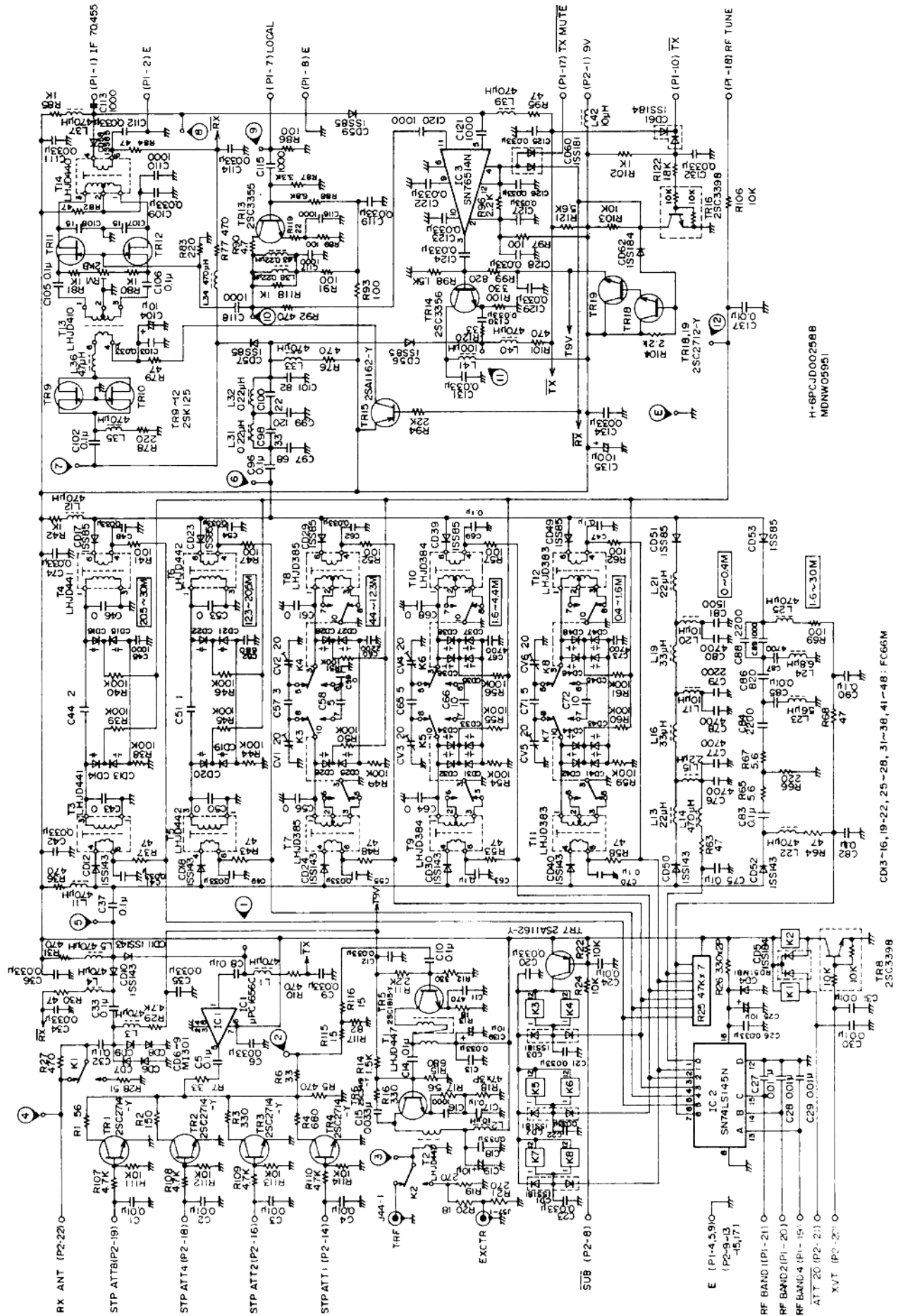

CD3-16, 19-22, 25-28, 31-38, 41-48: FC66M

H-6PCJ0002568  
MDNW05951

12.2 IF FILTER UNIT CFH-38A

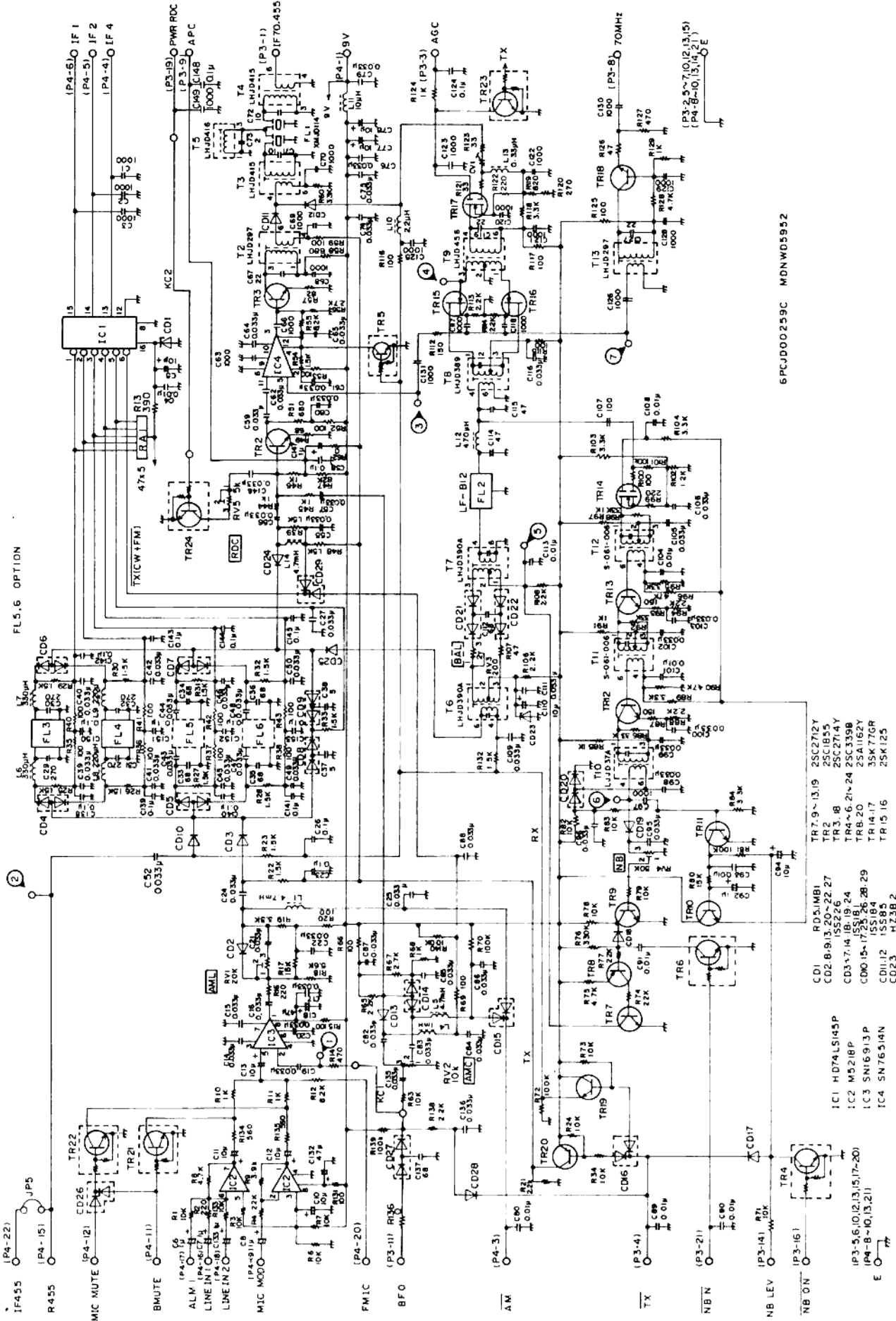

6PCJ00259C MDNWD5952

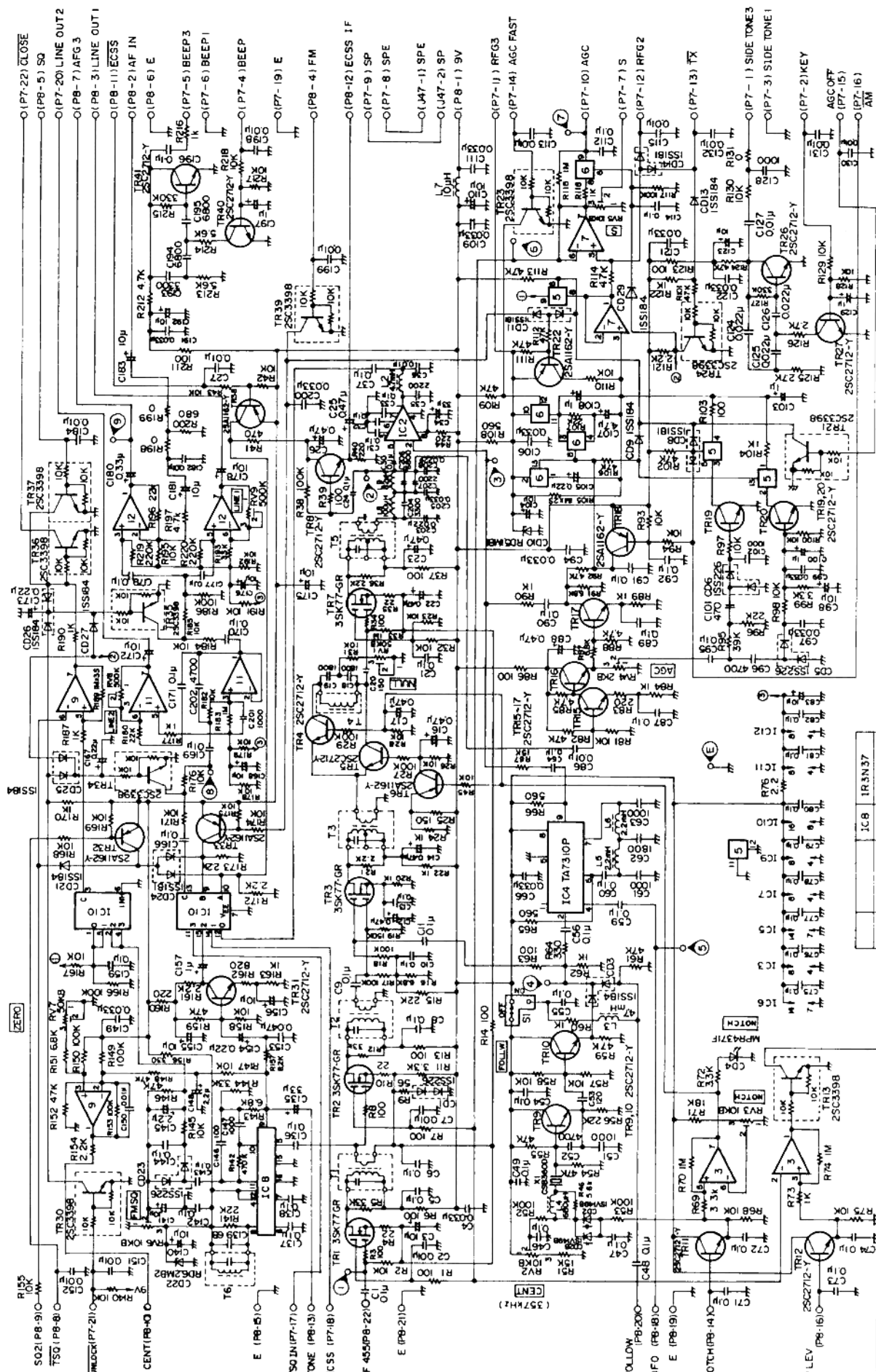

IC 8	1R3N37
IC 9	M5223L
IC 10	TC4032BP
IC 11	M5260L
IC 12	M5260L
IC 13	TC4066BP
IC 14	TC4066BP
IC 15	M5223L

H-6PCJ00260A MDHW00825

12.4 PA UNIT CAH-301L-2

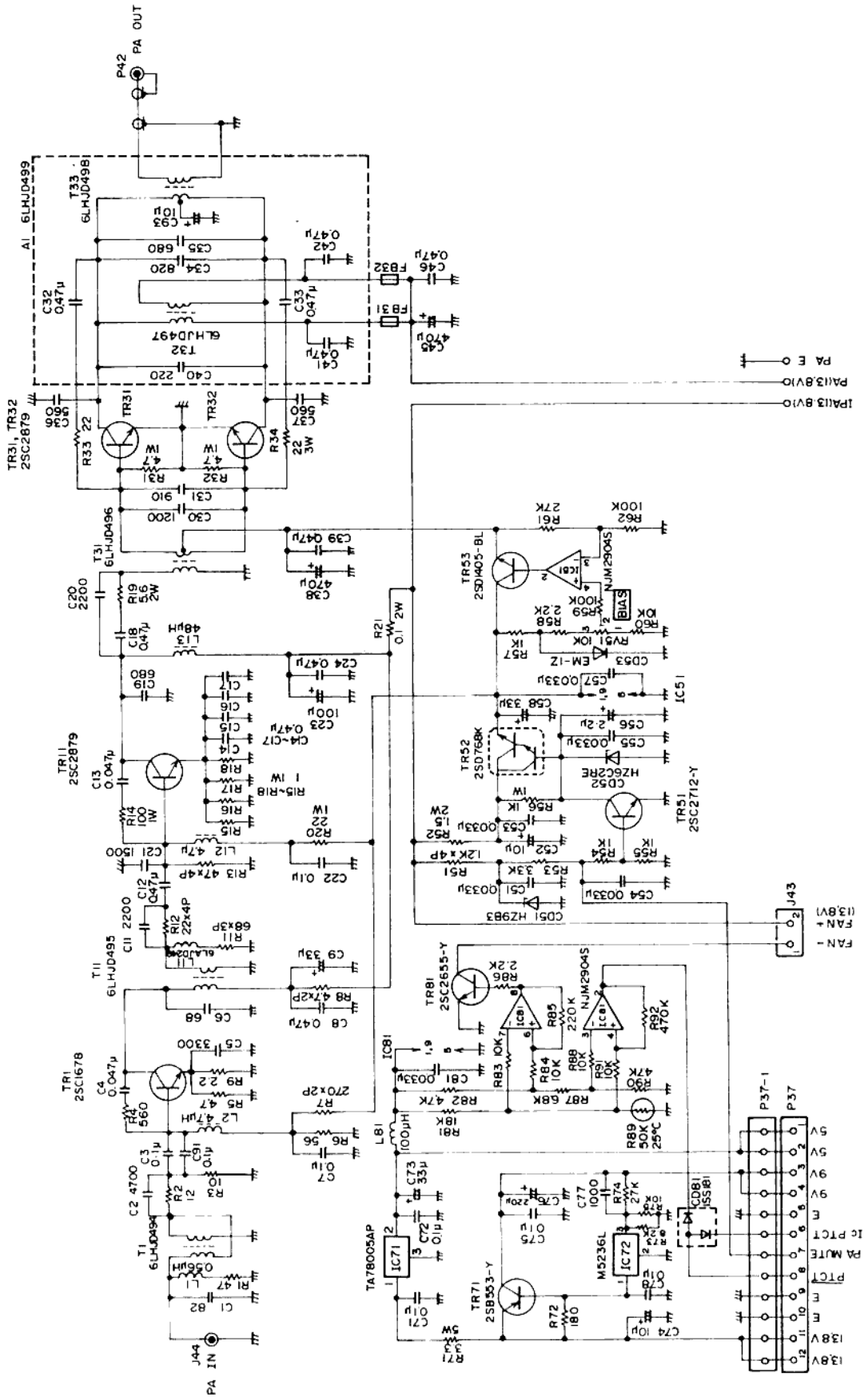

H-6PCJ000256B  
MDTW00834

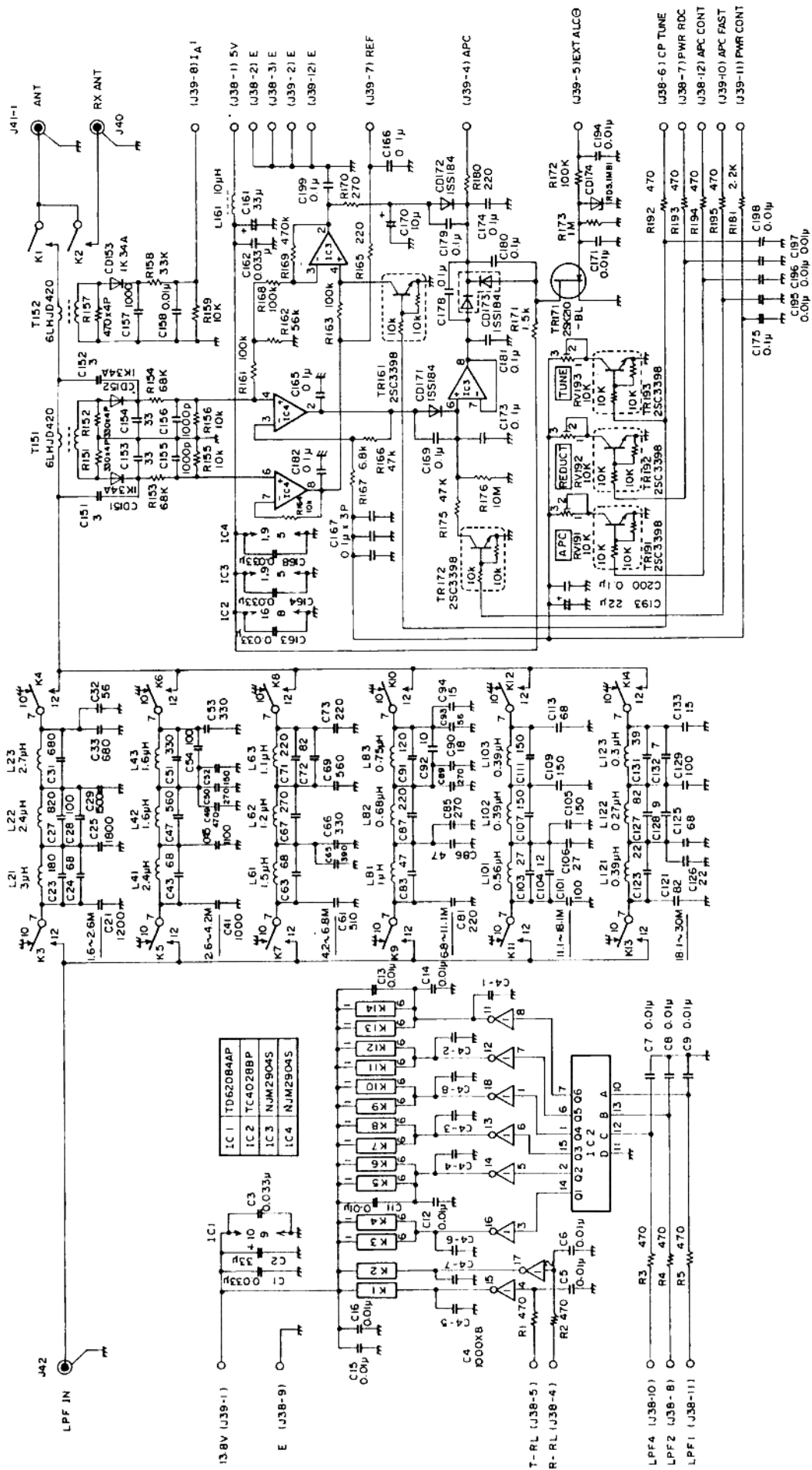

H-6PCJD002558  
MDNWC05950

12.6 LOOP1 UNIT CGA-145

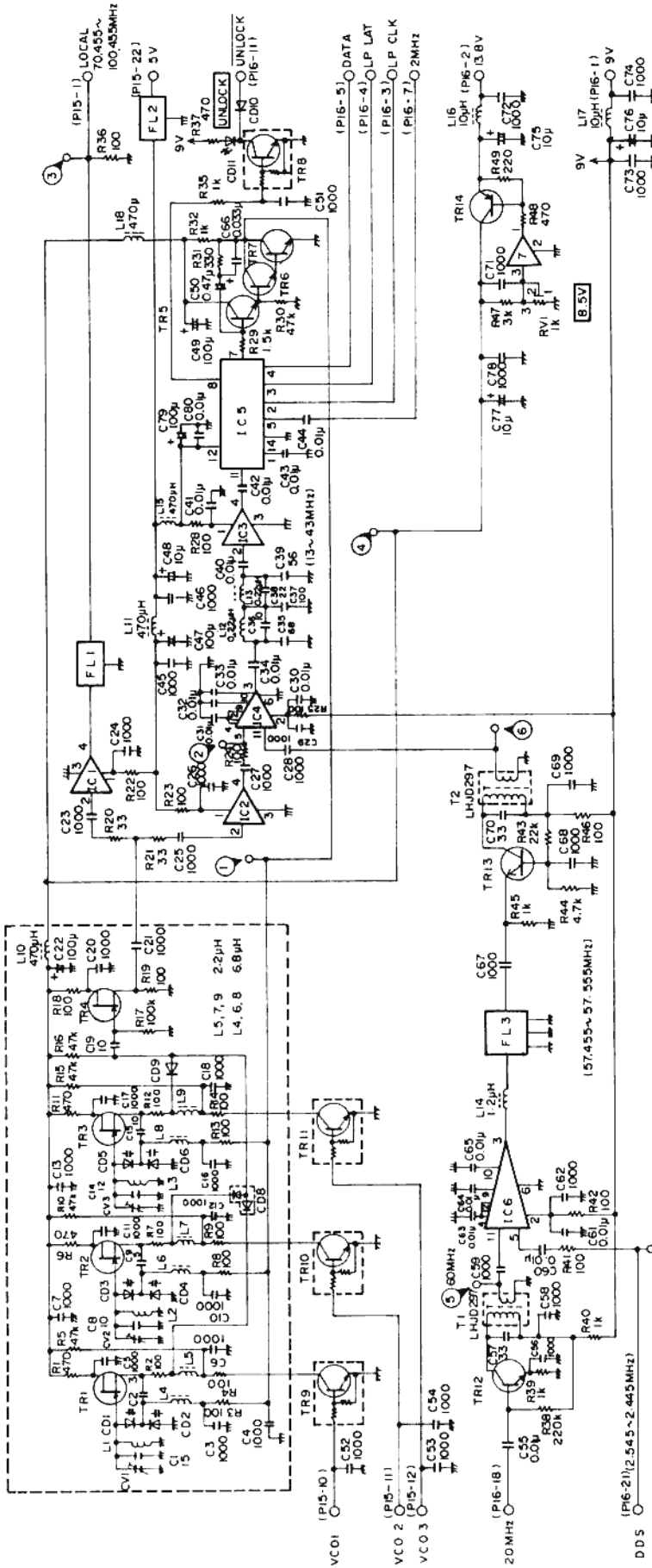

- CV1~3 TZO3Z100FR
  - CD1~6 ISV203
  - CD8,9 HSM2694
  - CD10 IS5226
  - CD11 MPR4371F
  - TR1~4 2SK210-BL
  - TR5~7 2SC3324-GR
  - TR8~11 2SC3398
  - TR12,13 2SC2714-Y
  - TR14 2SA1015-Y
- 
- BPEB1
  - DS310-45B222M
  - SAF58MH70Z
  - IC1~3 JFC1651G
  - IC4,6 SN76514N
  - IC5 CX7925B
  - IC7 M5236L
  - SC2-55T
  - SC2-45T
  - SC2-35T
- 
- FL1
  - DS310-45B222M
  - SAF58MH70Z
  - IC1~3 JFC1651G
  - IC4,6 SN76514N
  - IC5 CX7925B
  - IC7 M5236L
  - SC2-55T
  - SC2-45T
  - SC2-35T
- 
- TR12 LHJ0297
  - TR13 LHJ0297
  - TR14 LHJ0297
- 
- PI5-2-9 13~16, 19~21
  - PI6-9 10, 12~17, 19, 20, 22

SFPCJ00261A MDEW00769

TR17~19 25C3398

TRI.3 25A1162Y  
TR2.4~8,11,15 25C2714Y  
TR16 25K2712Y  
TR9-10 25K210BL  
TR12~14 25C3324GR  
RA1~3 20B-12 X-ME1

CD1,3,8 15S184  
CD2 15S181  
CD4~6 15V203  
CD7 MPR4371F  
CV1 ECR-HB010AII  
CV2 TZ03Z100FR

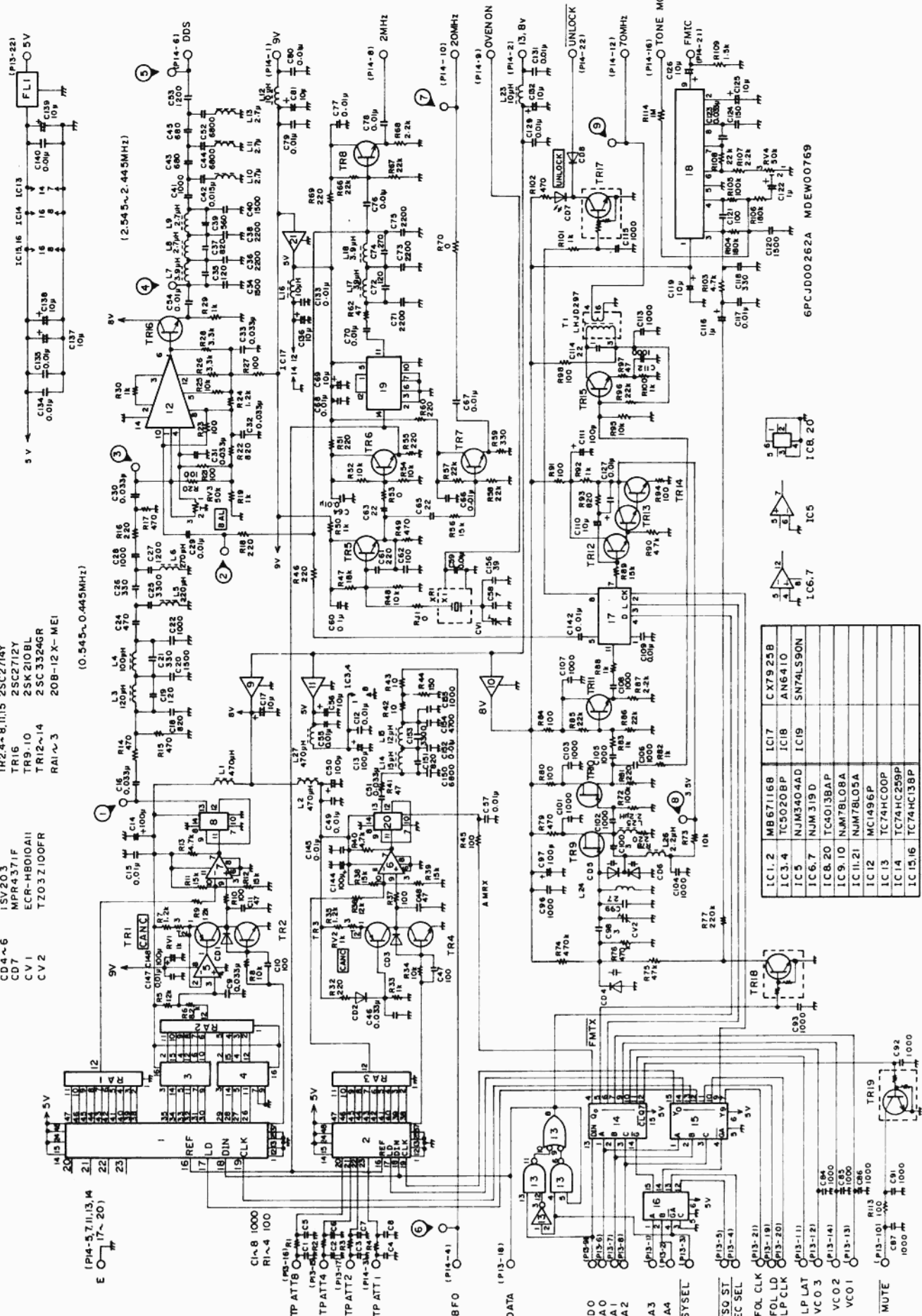

IC1.2	MB671168	IC17	CX7925B
IC3.4	TC5020BP	IC18	AN6410
IC5	NJM3404AD	IC19	SN74LS90N
IC6.7	NJM3191D		
IC8.20	TC4013BAP		
IC9.10	NM78L08A		
IC11.21	NJM78L05A		
IC12	MC1496P		
IC13	TC74HC00		
IC14	TC74HC259P		
IC15.16	TC74HC139P		

6PCJ000262A MDEW00769

12.8 CPU UNIT CDC-493A

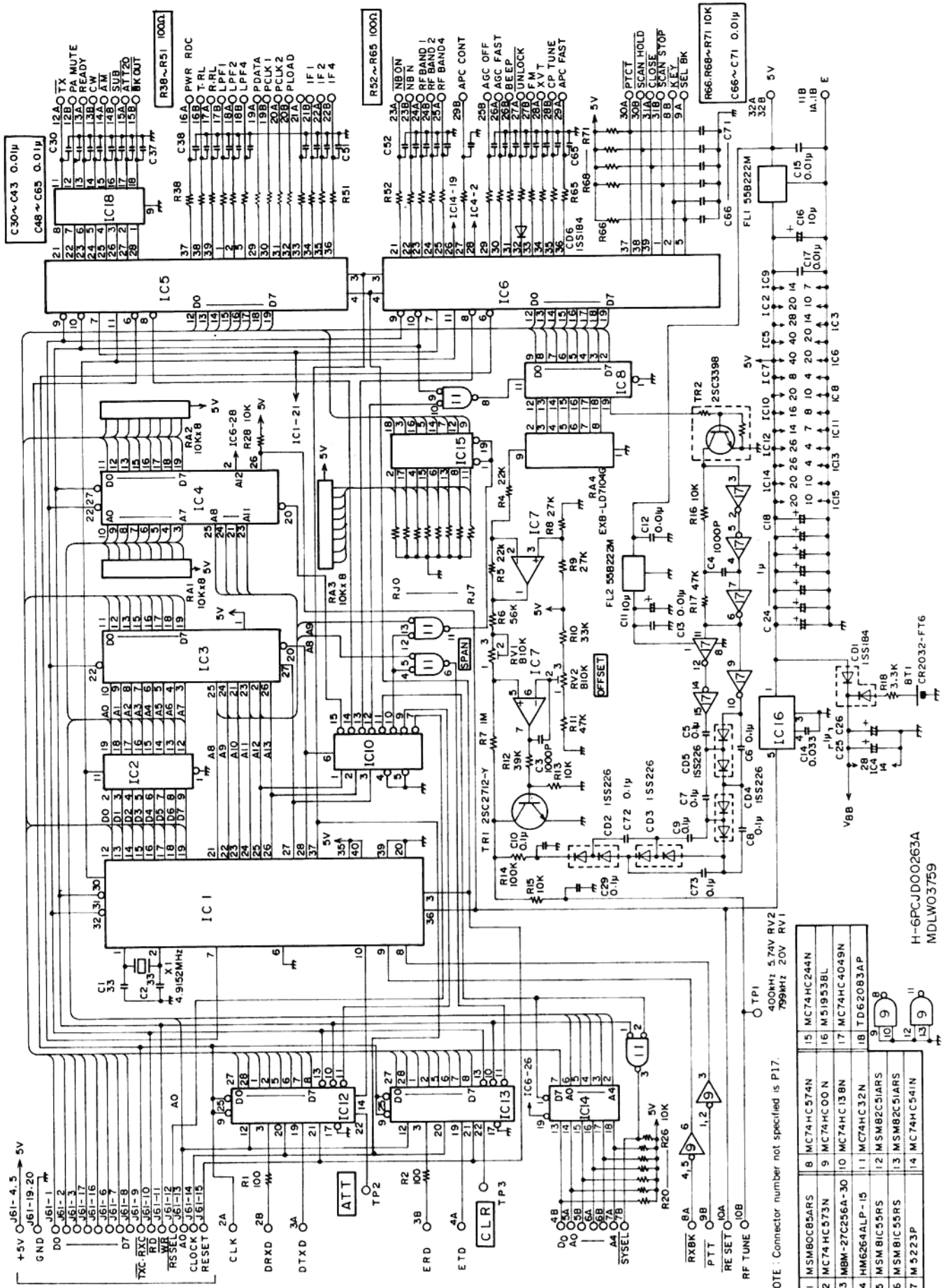

NOTE: Connector number not specified is P17.

1	MSM80C85ARS	8	MC74HC574N	15	MC74HC244N
2	MC74HC573N	9	MC74HC00N	16	M51953BL
3	MSM-27C256A-30	10	MC74HC138N	17	MC74HC4049N
4	HM6264ALP-15	11	MC74HC32N	18	TD62083AP
5	MSM81C55RS	12	MSM82C5IARS	9	
6	MSM81C55RS	13	MSM82C5IARS	10	
7	M5223P	14	MC74HC541N	11	

H-6PCJDO0263A  
MDLW03759

RS-232C



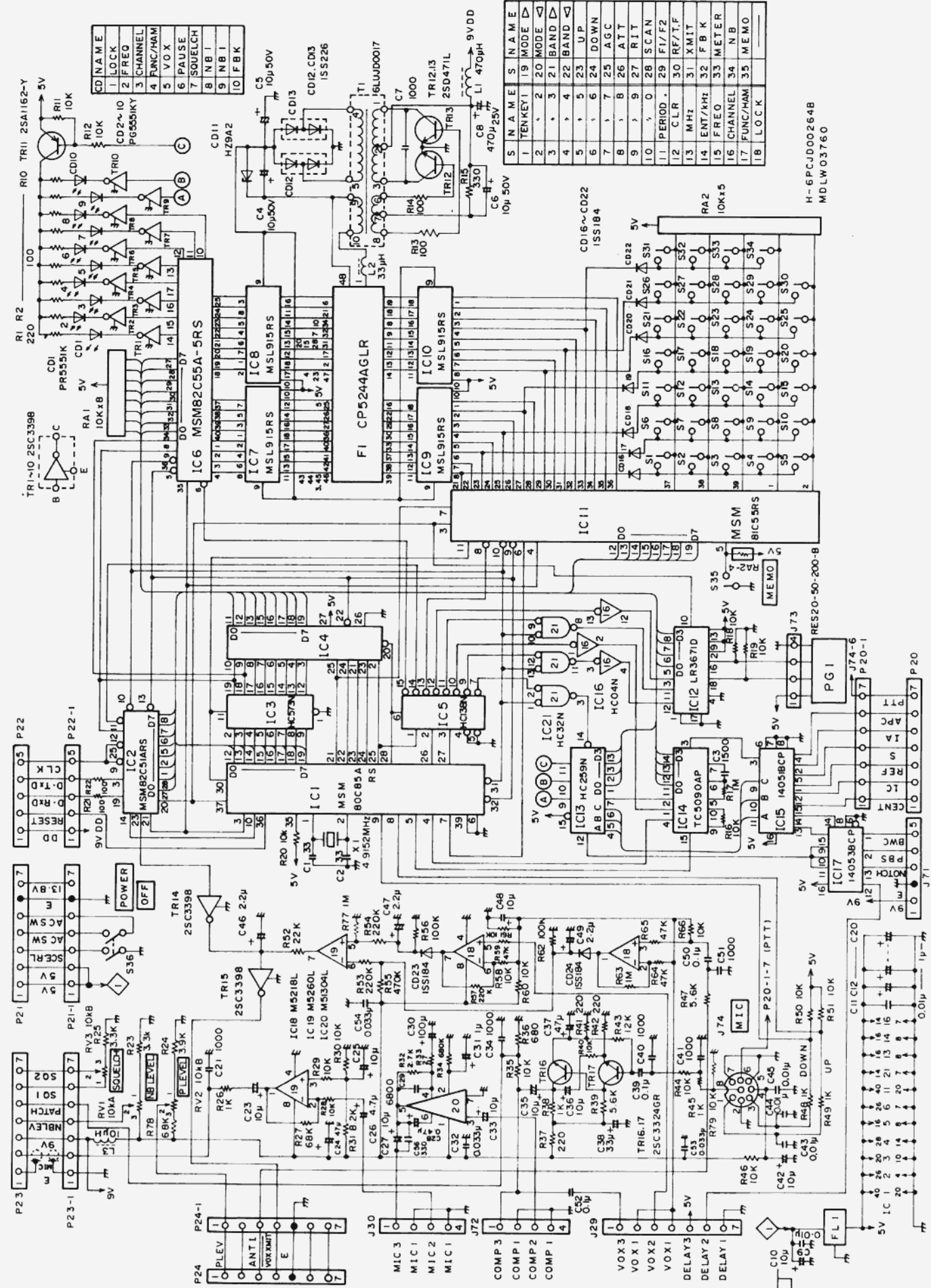

CD NAME	VALUE
1 LOCK	5V
2 FREQ	PG555IKY
3 CHANNEL	CD2~10
4 FUNC/HAM	5 VOX
5 VOX	7 PAUSE
6 PAUSE	8 INBI
7 INBI	9 INBI
8 INBI	10 FBK

S NAME	S NAME
1 TENKEY	19 MODE
2	20 MODE
3	21 BAND
4	22 BAND
5	23 UP
6	24 DOWN
7	25 AGC
8	26 ATT
9	27 RIT
10	28 SCAN
11 PERIOD	29 FI/F2
12 CLR	30 RF/T.F
13 MHz	31 XMIT
14 ENT/KH	32 FBK
15 FREQ	33 METER
16 CHANNEL	34 NB
17 FUNC/HAM	35 MEMO
18 LOCK	

H-6PCJ0002648  
MDLW03760

12.10 DISPLAY (VR) UNIT CDE-576

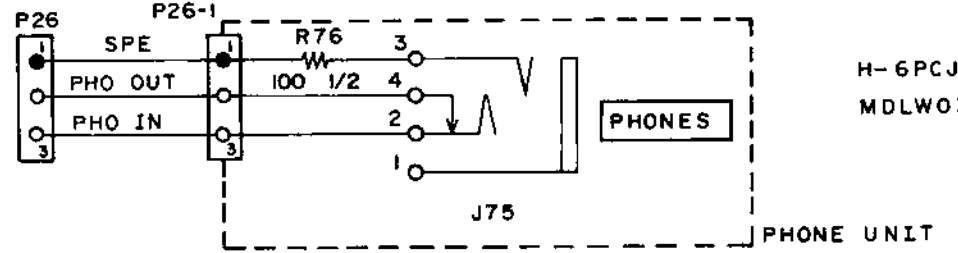
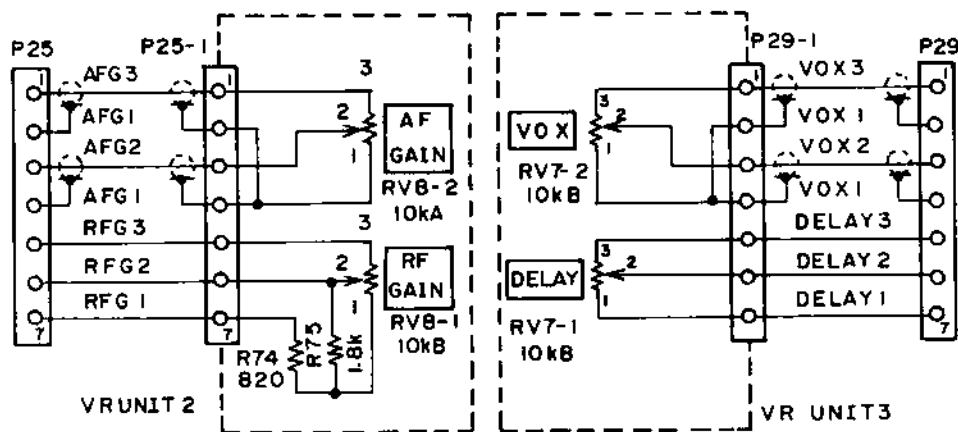
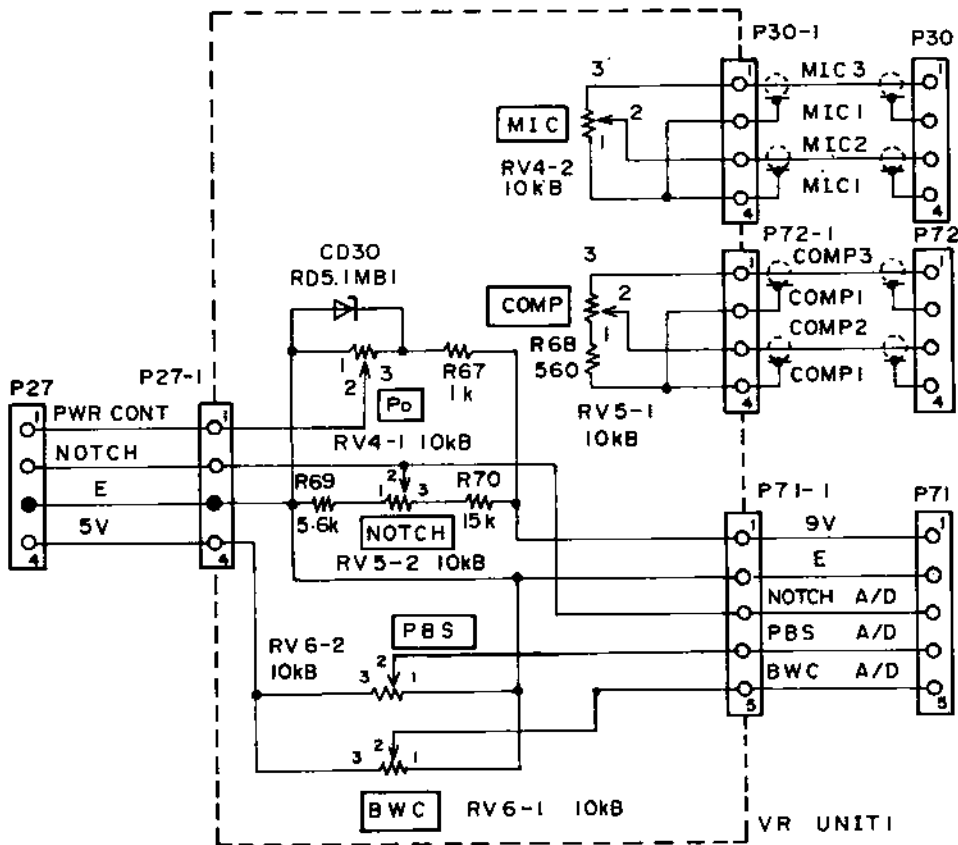

H-6PCJD00264B  
MDLW03760

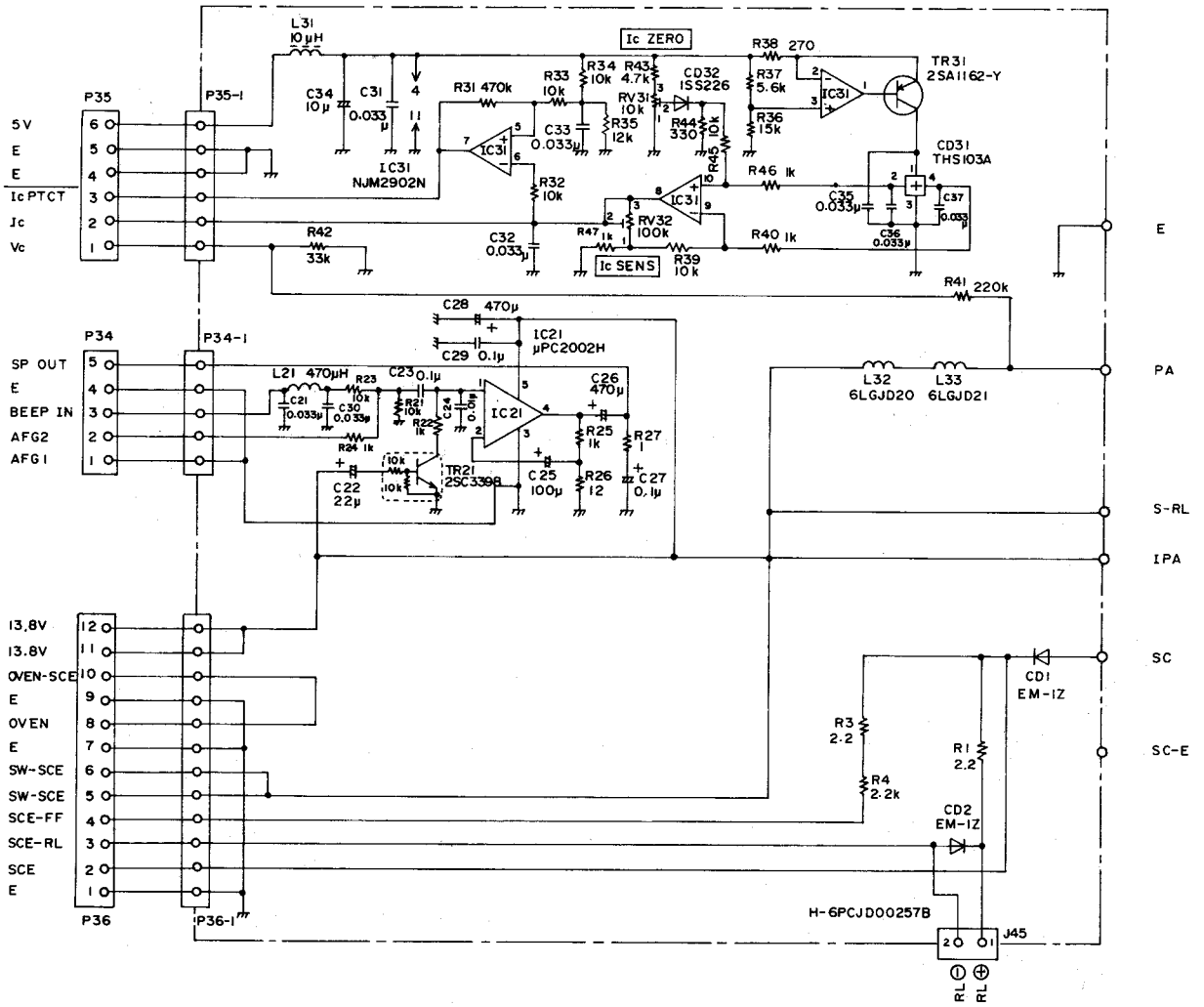

12.12 Overall Circuit Diagram (I)

MOTHER BOARD

CFQ-2625A

CHASSIS

JST-135

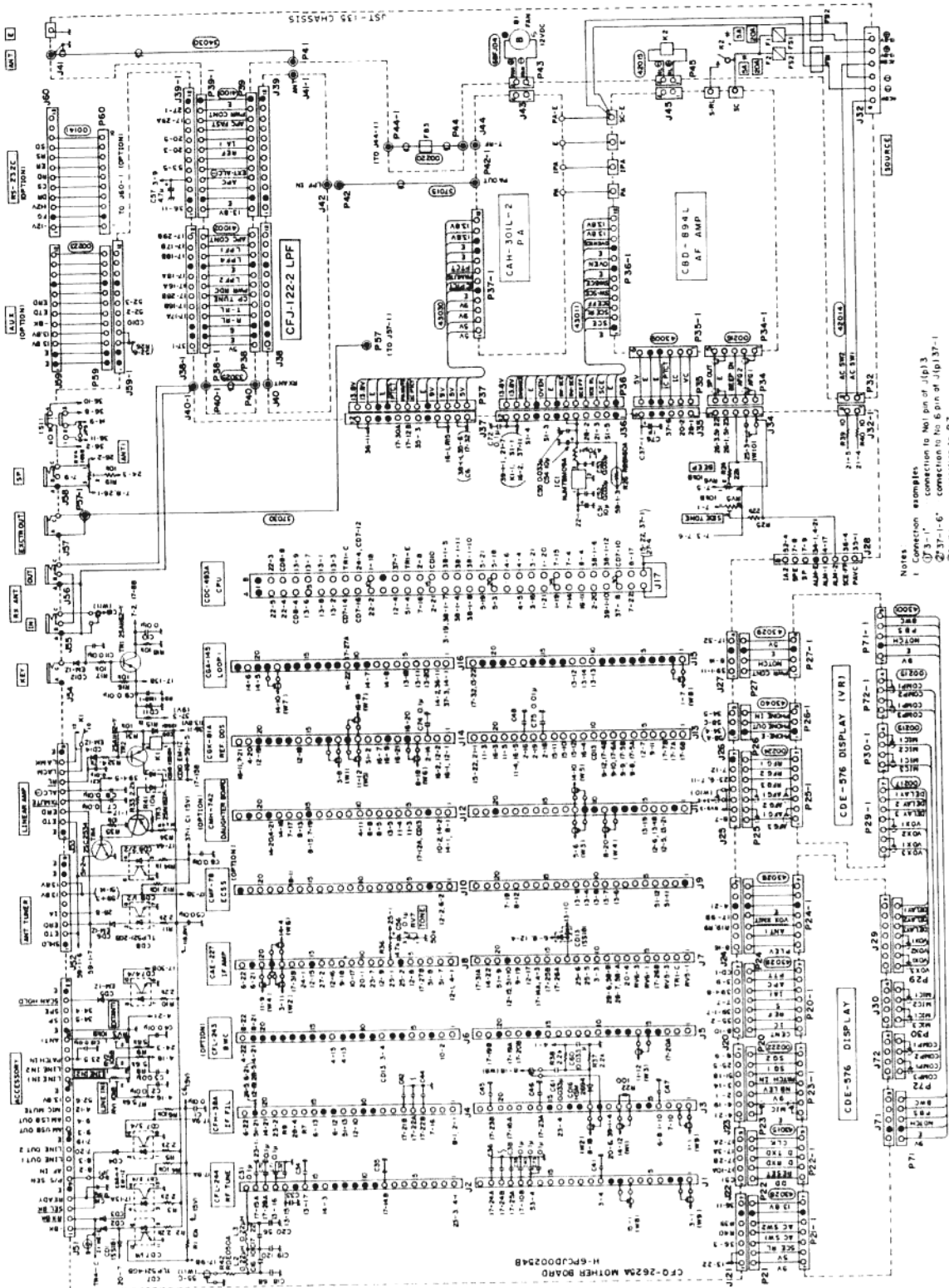

- Notes
- 1 Connection examples
  - ① 2-1' connection to No. 6 pin of J1p13
  - ② 2-3'-1'-6' connection to R7
  - ③ 2-4'-7' connection to No. 12 pin of K1
  - ④ 2-4'-12'-2' connection to No. 12 pin of K1
  - 2 Capacitance value not specified is 1000PF

CFQ-2625A MOTHER BOARD  
H-6PCJ002548

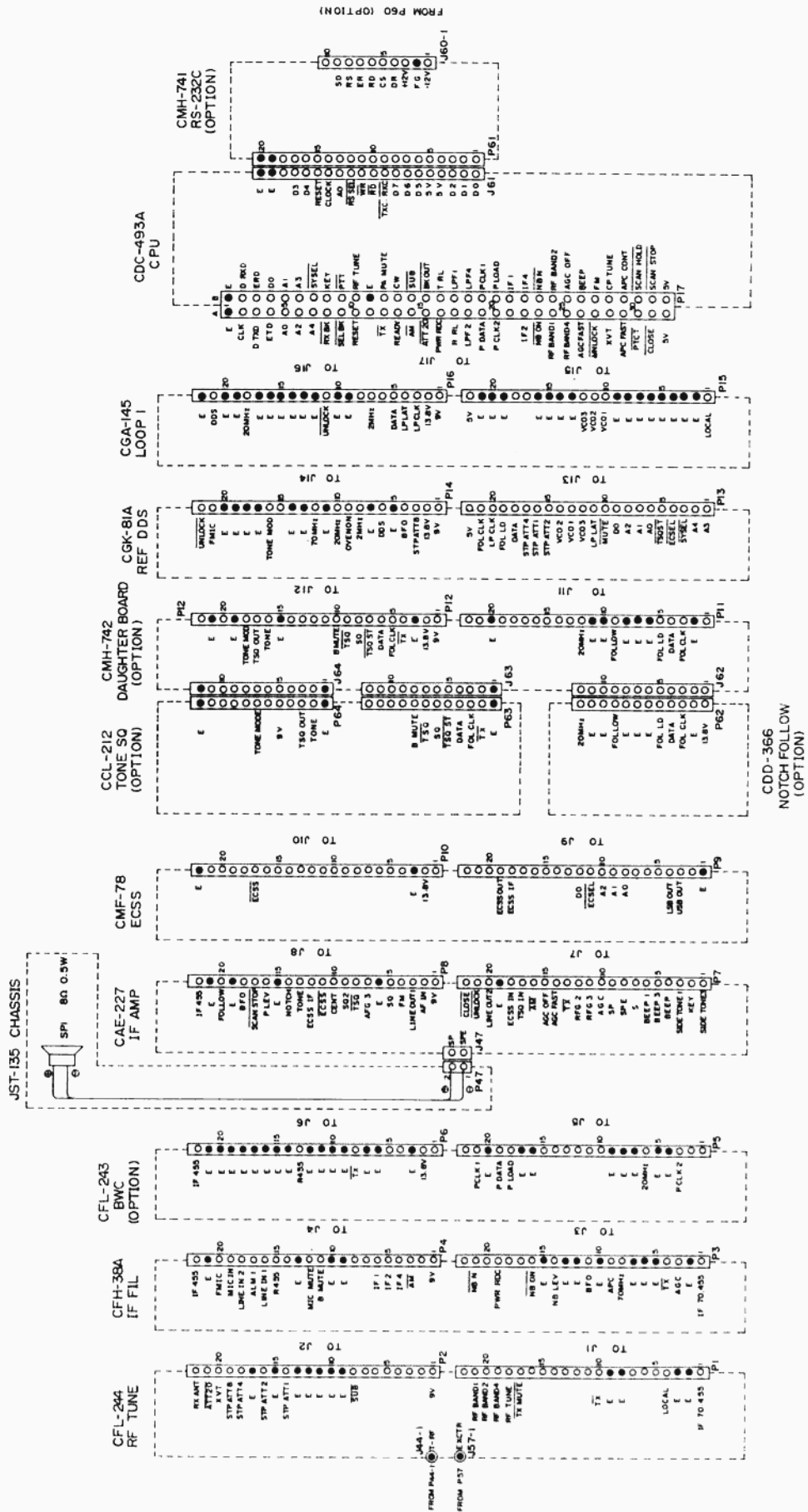

Downloaded by  
RadioAmateur.EU

*For further information contact:*

---



*Since 1915*

*Japan Radio Co., Ltd.*

**Main Office:** Akasaka Twin Tower (Main),  
17-22, Akasaka 2-chome,  
Minato-ku, Tokyo 107, JAPAN  
Telephone: Tokyo (03) 584-8750  
Telex: 2425420 JRCTOK J  
Cable: JAPANRADIO TOKYO

**Overseas Branches:** London, New York  
**Liaison Offices:** Rio de Janeiro, Jakarta, Kuala Lumpur,  
Rotterdam, Las Palmas, Paramaribo,  
Manila, Seattle