

# JETSTREAM

220 MHz 50 watt Mobile



**JT220M**

**USER'S MANUAL**

---

*Thank you very much for purchasing this excellent transceiver. We offer advanced technology, it has been tested carefully at our factory for your long term use.*

*Please read this manual completely to learn all functions. We made efforts to write this manual to be as comprehensive and easy to understand as possible. Please note that some of the operations may be explained in previous chapters. So if you read just one part of the manual, you may not understand the complete explanation of the function.*

## Precautions

---

Please observe the following precautions to prevent fire, personal injury, and/or transceiver damage:

- ⚠ This transceiver is designed for a 13.8 V power source.
- ⚠ Never use a 24 V battery to power the transceiver.
- ⚠ Do not place the transceiver in excessively dusty, humid or wet areas, nor on unstable surfaces.
- ⚠ Please make it away from interferential devices (such as TV, generator etc.) when interfering by external.
- ⚠ Do not expose the transceiver to long periods of direct sunlight nor place it close to heating appliances.
- ⚠ If an abnormal odor or smoke is detected coming from the transceiver, turn OFF the power immediately. Ensure the transceiver is safe, then send it to service station for examination.
- ⚠ Do not transmit with high output power for extended periods; the transceiver may overheat.

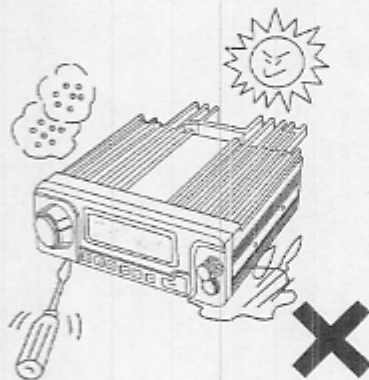

## Contents

<b>1. Function And Feature</b> .....	1
<b>2. Accessories</b> .....	2
Supplied Accessories.....	2
<b>3. Initial installation</b> .....	3-7
Mobile Installation.....	3
DC Power Cable Connection.....	4
Mobile Operation.....	4
Fixed Station Operation.....	5
Replacing Fuses.....	6
Power Supply Voltage Display.....	6
Antenna Connection.....	6
Accessory Connections.....	7
External speaker.....	7
Microphone.....	7
PC Connecting.....	7
<b>4. Getting Acquainted</b> .....	8-11
Front Panel.....	8
Rear Panel.....	8
Screen.....	10
Microphone.....	11
<b>5. Operating Basics</b> .....	12-19
Switching The Power ON/OFF.....	12
Adjusting The Volume.....	12
Adjusting The Squelch.....	12
VFO Mode.....	12
Change Frequency By Channel Stepping.....	13
Change Frequency By 1MHz Stepping.....	13
Change Channel Stepping.....	13
Operating Through Repeaters.....	14
Offset Programming Flow.....	14
Setting Offset Direction And Offset Frequency.....	14
CTCSS/DCS/2-TONE/5-TONE Setting.....	15
2-TONE/5-TONE(Optional).....	15
DTMF.....	16
Memory Channels.....	16
Memory Channels Programming.....	17
Programmable data in memory channels.....	17
Call Mode.....	18
Receiving Signals.....	18
Transmitting Signals.....	18
<b>6. Parameter Setting</b> .....	19-22
Parameter Setting Mode.....	19

## Contents

---

Details Of The Features In the Menu .....	19
Channel Step Setting .....	20
Scanning Type .....	20
Beep Sound .....	20
Time-Out Timer .....	20
TOT Resuming Time .....	21
APO-Auto Power OFF .....	21
Tone-Burst Frequency .....	21
Busy Channel Lockout .....	21
Burglar Alarm .....	21
Alphanumeric Tag .....	22
Dimmer .....	22
<b>7. Advanced Operations .....</b>	<b>23-29</b>
Scan .....	23
VFO Scan .....	23
Memory Scan .....	23
Program Scan .....	23
CTCSS Scan .....	24
DCS Scan .....	24
Key-Locked Function .....	25
Tone Burst .....	25
Wide/Narrow Band .....	25
Scrambler (Optional) .....	25
ANI Function .....	25
Auto-Dialer .....	26
Burglar Alarm .....	26
Programming Data By PC .....	28
<b>8. Microphone Operation .....</b>	<b>29-30</b>
Keys' Instruction .....	29
Functions Chart .....	29
Inputting Frequencies .....	30
Choose Memory Channel .....	30
<b>9. Maintenance .....</b>	<b>31</b>
Reset .....	31
How To Reset .....	31
Default Setting After Resetting .....	31
Trouble Shooting .....	31
<b>10. Specification .....</b>	<b>32</b>

# 1. Functions And Features

---

This new transceiver has many advanced and reliable functions; it represents the innovation and practical principle of our Company. Functions as follows:

- Display on a large LCD with adjustable brightness, convenient for nighttime use. Three different displaying modes are available, including Frequency Mode, Frequency +Channel Mode and Channel Mode.
- Distribute buttons reasonably, convenient for operation. Adopt superior quality material, better technology and high quality radiator to ensure stable and durable operation.
- 99 programmable memorized channels + 1 called channel, identified by letters and numbers.
- CTCSS/DCS encode/decode per channel (can be different encode/decode tones), rejecting extra calling from other radios.
- Various scan functions, including CTCSS/DCS scan function.
- With 2-Tone, 5-Tone and DTMF encoding/decoding function, use 5-Tone to have Send Message, Emergency, Call all, ANI, Stun, Waken, etc.
- Automatic Numbering Identification function by DTMF/ANI or 5-Tone/ANI.
- Can set compander ON/OFF.
- Can set different band width; wide band: 25K, narrow band 12.5K.
- This transceiver is designed to work in 12.5 narrow band FM mode.
- Burglar alarm provides extra safety.

## 2. Supplied And Optional Accessories

### Supplied Accessories

After carefully unpacking the transceiver, identify the items listed as below. We recommend you keep the box and packing.

- JT220M Transceiver

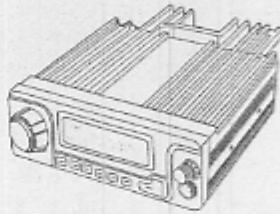

- Microphone JTMIC1 (with DTMF keypad)



- Mobile installing bracket JTMB1

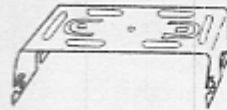

- DC power cable with fuse holder JTPC3

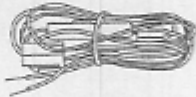

- Alarm cable A (with wire) JTAL1A



- Alarm cable B (extension use) JTAL1B



The standard accessories may vary slightly depending on the version you have purchased. Please contact the local authorized our dealer should you have any questions. **We and our authorized dealer are not responsible for any typographical errors there may be in this manual.** Standard accessories may change without notice.

### Optional Accessories

- Programming cable (JTPRG1)

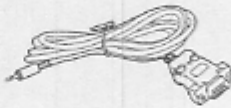

- Programming software CD



- Cigar lighter (JTCIG2)



- Regulated power supply (JTPS14B)

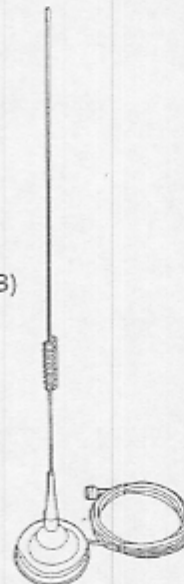

- Car antenna (JTM 220BM)

### 3. Initial Installation

#### Mobile Installation

To install the transceiver, select a safe, convenient location inside your vehicle that minimizes danger to your passengers and yourself while the vehicle is in motion. Consider installing the unit at an appropriate position so that knees or legs will not strike it during sudden braking of your vehicle. Try to pick a well ventilated location that is shielded from direct sunlight.

1. Install the mounting bracket in the vehicle using the supplied self-tapping screws (4 pcs), flat washers (4 pcs).

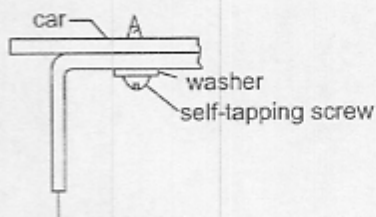
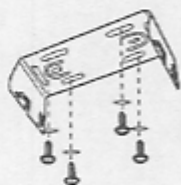

Install the mounting bracket

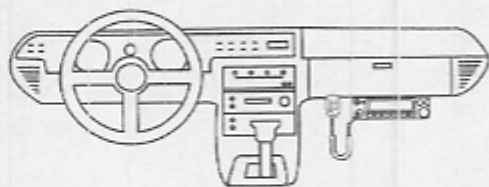

2. Position the transceiver, then insert and tighten the supplied hexagon SEMS screws (4) and flat washers (4).

- Double check that all hardware is tightened to prevent vehicle vibration from loosening the bracket or transceiver.

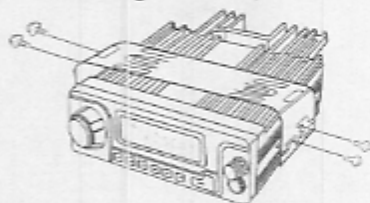

- Determine the appropriate angle of the transceiver, using the 3 screw hole positions on the side of the mounting bracket.

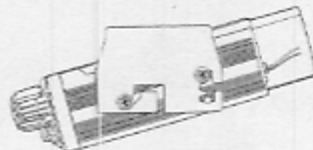
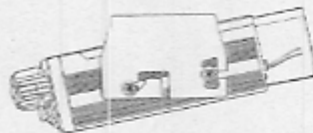
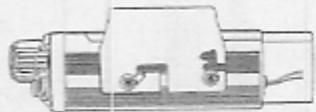

### 3. Initial Installation

## DC Power Cable Connection

**NOTE:** Locate the power input connector as close to the transceiver as possible.

### **[Mobile Operation]**

The vehicle battery must have a nominal rating of 12 V. Never connect the transceiver to a 24 V battery. Be sure to use a 12 V vehicle battery that has sufficient current capacity. If the current to the transceiver is insufficient, the display may darken during transmission, or transmit output power may drop excessively.

1. Route the DC power cable supplied with the transceiver directly to the vehicle's battery terminals using the shortest path from the transceiver.
  - If using a noise filter, it should be installed with an insulator to prevent it from touching metal on the vehicle.
  - We recommend you do not use the cigarette lighter socket as some cigarette lighter sockets introduce an unacceptable voltage drop.
  - The entire length of the cable must be dressed so it is isolated from heat, moisture, and the engine secondary (high voltage) ignition system/ cables.
2. After the cable is in place, wrap heat-resistant tape around the fuse holder to protect it from moisture and tie down the full run of cable.
3. To prevent the risk of short circuits, disconnect other wiring from the negative (-) battery terminal before connecting the transceiver.
4. Confirm the correct polarity of the connections, then attach the power cable to the battery terminals; red connects to the positive (+) terminal and black connects to the negative (-) terminal.
  - Use the full length of the cable without cutting off excess even if the cable is longer than required. In particular, never remove the fuse holders from the cable.

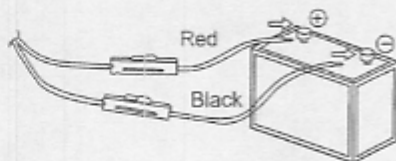

5. Reconnect any wiring removed from the negative terminal.
6. Connect the DC power cable to the transceiver's power supply connector.
  - Press the connectors firmly together until the locking tab clicks.

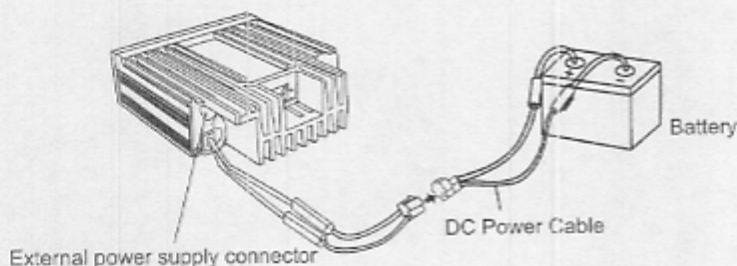



### 3. Initial Installation

If set the ignition-key **ON/OFF** (optional feature), use the optional JTCIG2 (For direct connection to the circuit on the vehicle or for a cigar plug connection) cable. Connect one of the cables between the ACC terminal or a cigar plug that operates with the vehicle ignition or ACC switch on the vehicle power jack on the rear side of the unit. (**NOTE: In many cars, the cigar-lighter plug is always powered. In this case, you cannot use it for the ignition-key ON/OFF function.**) If set this function on, the unit can be turned **ON/OFF** either manually or automatically in accordance with the ignition-key position.

1. When the ignition-key turns to ACC (speed up) or ON(start) and the radio is power off, the power switch lights on. It turns off when the ignition key is turned to be off. To turn on the unit, press the power switch while it is on. (while ignition key is at ACC or ON)
2. When the ignition-key turns to ACC (speed up) or ON (start) and the radio is power on, the unit turns on automatically and the power switch light on. Turn the ignition-key to OFF or manually turn the power switch off to shut down the radio.

The power consumption when using the additional cable is 5 mA.

For operation without this function, use the power switch to turn the unit ON/OFF.

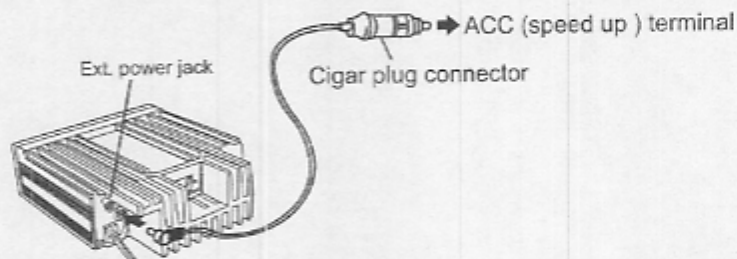

#### 【Fixed Station Operation】

In order to use this transceiver for fixed station operation, you will need a separate 13.8 V DC power supply (not included). our Co. offers excellent communication power supply as optional accessory [JTPS14B], please contact the local authorized distributor.

The recommended current capacity of your power supply is 12 A.

1. Connect the DC power cable to the regulated DC power supply and ensure that the polarities are correct (Red: positive, Black: negative).
  - Do not directly connect the transceiver to an AC outlet.
  - Use the supplied DC power cable to connect the transceiver to a regulated power supply.
  - Do not substitute a cable with smaller gauge wires.

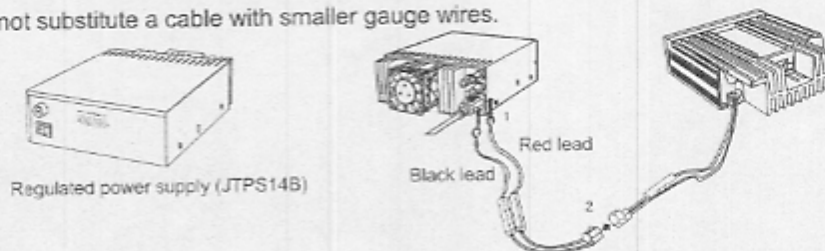

2. Connect the transceiver's DC power connector to the connector on the DC power cable.
  - Press the connectors firmly together until the locking tab clicks.

#### NOTE:

- ◆ Before connecting the DC power supply to the transceiver, be sure to switch the transceiver and the DC power supply OFF.
- ◆ Do not plug the DC power supply into an AC outlet until you make all connections.

### 3. Initial Installation

#### [Replacing Fuse]

If the fuse blows, determine the cause, then correct the problem. After the problem is resolved, replace the fuse. If newly installed fuse continues to blow, disconnect the power cable and contact your authorized dealer or an authorized service center for assistance.



Fuse Location	Fuse Current Rating
Transceiver	15A
Supplied Accessory DC power cable	20A

Only use fuse of the specified type and rating; otherwise the transceiver could be damaged.

**NOTE:** If you use the transceiver for a long period when the vehicle battery is not fully charged, or when the engine is OFF, the battery may become discharged, and will not have sufficient reserves to start the vehicle. Avoid using the transceiver under these conditions.

#### Power Supply Voltage Display

After connecting the transceiver to the power supply, the supply voltage can be confirmed by pressing SQL and FUNC at the same time. The supply voltage displays on the screen. The transceiver will return to normal operation when the power is OFF. The display immediately changes as the voltage supply changes. It also displays voltage during transmission.

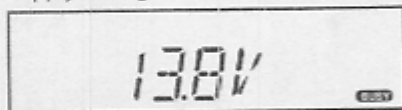

**[IMPORTANT]** The range of the displayed voltage is only from 7V-16V. Because of the displayed value is estimated, please use a voltmeter when a more precise reading is desired.

#### Antenna Connection

Before operating, install an efficient, well-tuned antenna. The success of your installation will depend largely on the type of antenna and its correct installation. The transceiver can give excellent results if the antenna system and its installation are given careful attention.

Use a 50Ω impedance antenna and low-loss coaxial feed line that has a characteristic impedance of 50Ω, to match the transceiver input impedance. Coupling the antenna to the transceiver via feed lines having an impedance other than 50Ω reduces the efficiency of the antenna system and can cause interference to nearby broadcast television receivers, radio receivers, and other electronic equipment.

**NOTE:**

- ◆ Transmitting without first connecting an antenna or other matched load may damage the transceiver. Always connect the antenna to the transceiver before transmitting.
- ◆ All fixed stations should be equipped with a lightning arrester to reduce the risk of fire, electric shock, and transceiver damage.

There are many possible antenna locations on a car. Four of the most popular are shown and discussed on the following:



### 3. Initial Installation

## Accessory Connection

### 【External speaker】

If you plan to use an external speaker, choose a speaker with an impedance of  $8\Omega$ . The external speaker jack accepts a 3.5 mm (1/8") mono (2-conductor) plug.

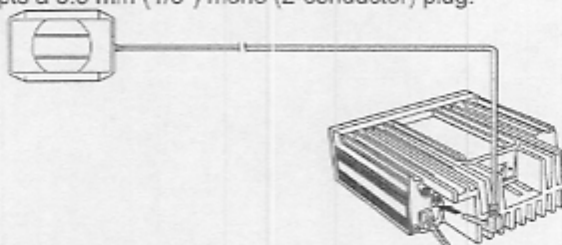

**NOTE:** External speaker adopt BTL double ports as output, please care about the connecting way. The speaker can not connect with the ground, otherwise the speaker will be fault. The wrong connecting way as the following picture:

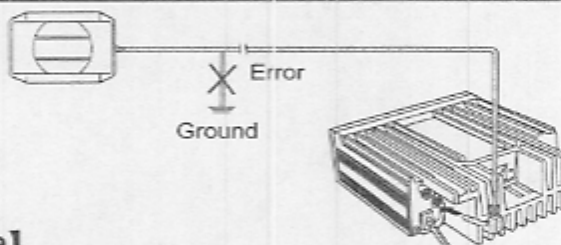

### 【Microphone】

For voice communications, connect a microphone equipped with an 8-pin modular plug into the modular socket on the front of the main unit. Press firmly on the plug until the locking tab clicks.

Attach the supplied microphone hanger in an appropriate location using the screws included in the screw set.

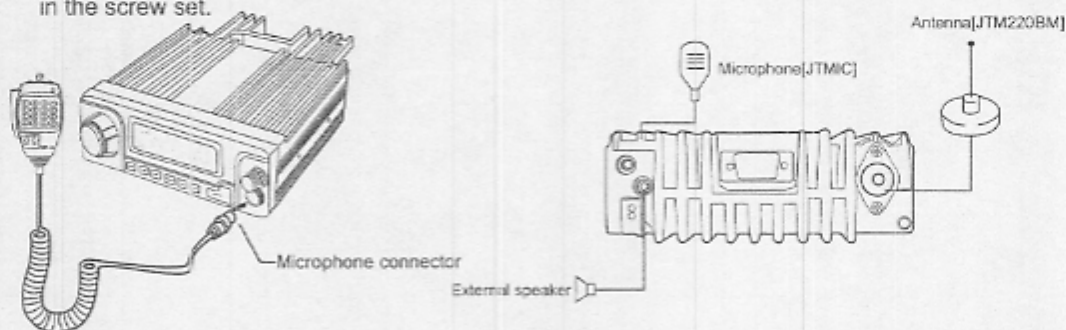

### 【PC Programming】

To utilize the optional JT-220M software, you must first connect the transceiver to your PC using an optional programming cable JTPRG1 (via the DATA jack).

**NOTE:** Ask your dealer about purchasing a Programming Cable.

## 4. Getting Acquainted

### Front Panel

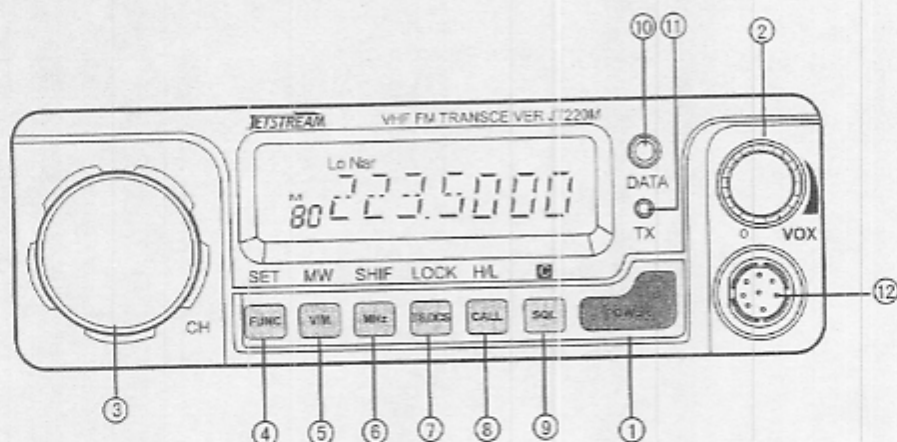

#### • Primary Function

No.	Key	Function
1	PWR (Power)	Power ON/OFF
2	VOL (Volume switch)	Adjust volume key
3	Main Dial	Change frequency, memorized channel and scan direction etc.
4	FUNC • SET	Function key
5	V/M • MW	Switches between VFO mode and memory mode
6	MHZ • SHIFT	Step key (step:1 MHz)
7	TS/DCS • LOCK	Set CTCSS and DCS value
8	CALL • H/L	Call key
9	SQL •	Squelch adjusting key
10	Data Terminal	Data reading/writing, burglar alarm functions
11	TX	Indicates when transmitting
12	Mic. Connector	Connection port for supplied microphone

#### • Press FUNC, the functions can be activated while appears.

No.	Key	Function
4	FUNC • SET	Confirm to choose function and exit the functions
5	V/M • MW	Store data to memory channels
6	MHZ • SHIFT	Set direction and frequency of offset frequency
7	TS/DCS • LOCK	Set key lock function
8	CALL • H/L	Switch between HI, MID and LOW power transmission
9	SQL •	Enter into the compander communication mode

## 4. Getting Acquainted

- Set function by pressing FUNC and one of the following keys at the same time

No.	Key	Function
1	PWR	Reset to default setting
5	V/M • MW	Delete the channel memory
6	MHZ • SHIFT	Switch between wide/narrow band
7	TS/DCS • LOCK	Set the auto dialer
9	SQL • 	Enter the power supply voltage indication mode

**NOTE:** When pressing **FUNC** key, simultaneously press **CALL • H/L** key, it will display **CLONE**, meanwhile transceiver disables all operation, for **CLONE** has been prohibit. Now you should turn off the power and turn on transceiver once.

- Set functions by pressing the keys continuously

No.	Key	Function
4	FUNC • SET	Press and hold for 2 seconds to enter the setting mode
9	SQL • 	Press and hold for more than 1 second to monitor function

## Rear Panel

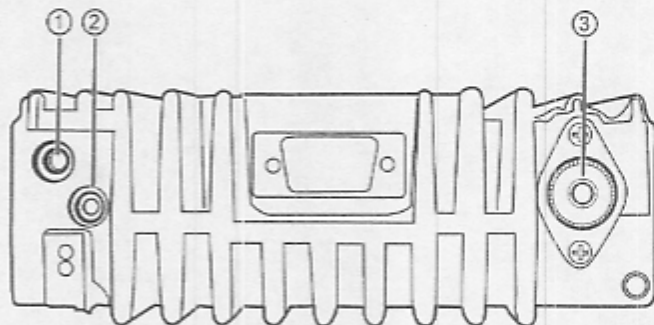

No.	Key	Function
1	Ext. Speaker Terminal	Terminal for optional external speaker
2	Ext. Power Jack	Terminal for connecting optional cable for use with ignition key on/off function
3	Antenna Connector	Use for connecting the 50 ohm coaxial cable with antenna

## 4. Getting Acquainted

### Screen

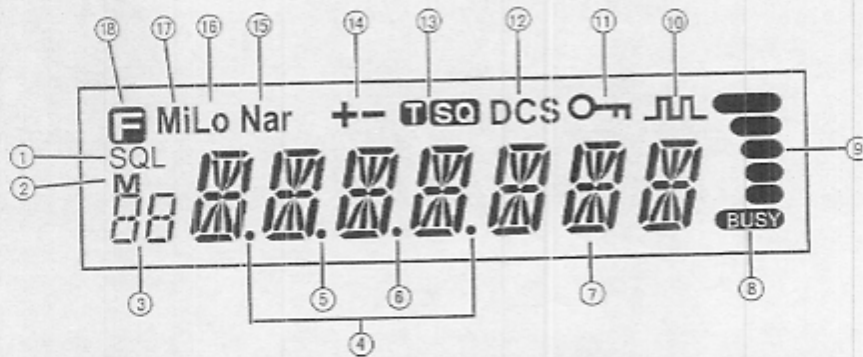

No.	Icon	Function
1	SQL	Appears when setting the squelch level
2	M	Appears when in memory mode
3	88	Indicates the memory channel number in memory mode
4	.Decimal point	Appears when setting the burglar alarm function
5	.Decimal point	Appears when setting the skip level
6	.Decimal point	Indicates the decimal point of frequency and the scanning function
7	XXXXXXXXXX	Indicates the frequency or memory name
8	BUSY	Appears when a signal is being received and monitor function is ON
9	S-meter	Indicates the relative signal strength of transmitting and receiving
10	Waveform icon	Appears when in compander mode
11	Key lock	Appears when setting the key lock function
12	DCS	Appears when setting the DCS function
13	CTCSS	Appears when setting CTCSS
14	+ -	Appears when setting direction of offset frequency
15	Nar	Indicates narrow band
16	Lo	Indicates low power
17	ML	Indicates medium power
18	FUNC Key	Appears when pressing FUNC Key

## 4. Getting Acquainted

### Microphone

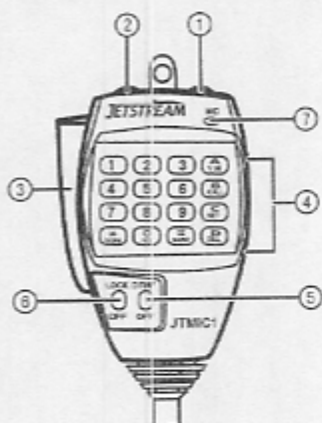

No.	Key	Function
1	Up	Increase frequency value, memory channel serial number, or setting value
2	Down	Decrease frequency value, memory channel serial number, or setting value
3	PTT	Push-To-Talk, get into transmitting state
4	DTMF	Set functions, input VFO frequency or dial DTMF, etc.
5	DTMF OFF	Switch between dual-tone frequency dialing and function operating
6	LOCK OFF	Key lock (Lightening turns off when locking)
7	MIC	Speak here during transmitting

Mic. Connector Diagram (While looking in the front view of the connector)

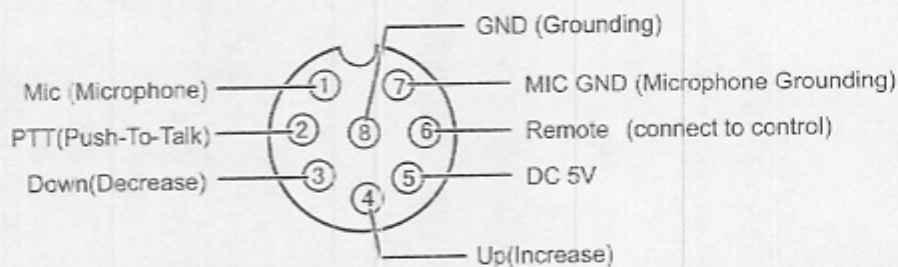

## 5. Operating Basics

### Switching The Power ON/OFF

Press the power switch or turn the ignition key to ACC according to the selected mode when installed to power ON. Press again the power switch or turn the ignition key to OFF to power OFF.

### Adjusting The Volume

Turn the VOL control clockwise to increase the audio output level and counterclockwise to decrease the output level. Set it at the desired level.

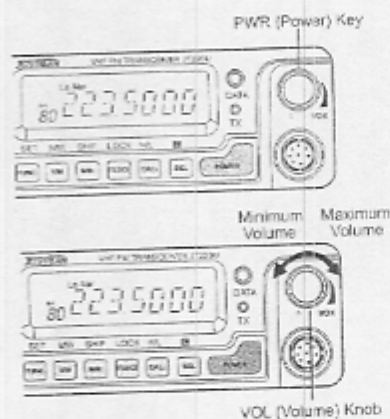

### Adjusting The Squelch

The purpose of Squelch is to mute the speaker when no signals are present. With the squelch level correctly set, you will hear sound only while actually receiving signals. The higher the selected squelch level, the stronger the signals must be received. The appropriate squelch level depends on the ambient RF noise conditions.

1. Press **SQL** Key. SQL icon displays on the screen and the squelch level will be shown where the memory number is displayed. 21 levels total (from 0 to 20) "0" is the lowest setting value.
2. Adjust desired squelch level by turning the main dial or by using the **UP/DOWN** keys on the microphone. To return to normal use mode, press **PTT** or any key on the front panel, or if there are no operations within five seconds, the unit will store the setting and will return to its original status.

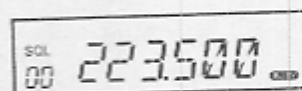

Squelch Level

The new squelch level will be stored in the CPU until another adjustment is done.

### VFO Mode

VFO tuning is set as a default mode at the factory. VFO (Variable Frequency Oscillator) allows you to change the frequency in accordance with the selected channel step as you rotate the main dial or by using the **UP/DOWN** keys on the microphone. VFO mode is also used to program the data to be stored in the memory channels.

1. Identify the current mode by checking the screen. If "M" or "C" icon is NOT displayed on it, the unit is already in the VFO mode.
2. Otherwise press **V/M** key until those icons are gone.

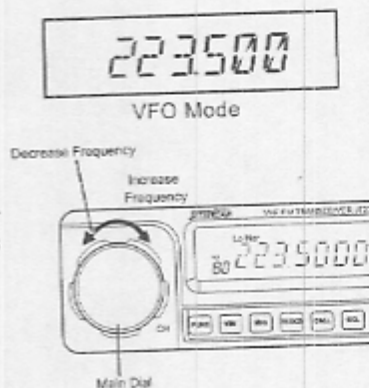



## 5. Operating Basics

### 【Change Frequency By Channel Stepping】

Turn the main dial clockwise to increase the frequency value, counterclockwise to decrease. The UP/DOWN keys on the microphone act in the same way (This transceiver takes 12.5KHz as channel stepping).

### 【Change Frequency By 1MHz Stepping】

This will enable a quick change of frequency in 1 MHz steps:

1. Press **MHz** key. The digits after 100KHz will disappear on the screen.

2. Turn the main dial or press **UP/DOWN** key on Mic.

### Change Channel Stepping

1. Be sure the unit is in VFO mode. Refer to page 23 to enter the SET mode.

Displaying channel stepping

2. Select the channel step parameter setting by using the tuning knob. The current channel step will be displayed as below.

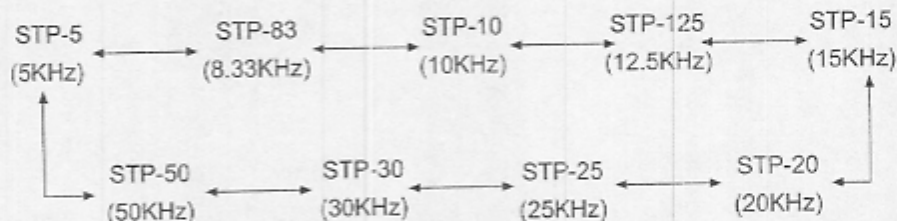

3. Press **PTT** or any key except **SQL** on the front panel to enter the desired step into memory. The screen will then return to the original status.

**NOTE:** Settings below 10KHz may be automatically corrected according to the selected step.

### Operating Through Repeaters

Repeaters, which are often installed and maintained by radio clubs, are usually located on mountain tops or other elevated locations. They generally operate at higher ERP (Effective Radiated Power) than a typical station. This combination of elevation and high ERP allows communications over much greater distances than communicating without using repeaters.

Most repeaters use a receive and transmit frequency pair with a standard or non-standard offset (odd-split). In addition, some repeaters must receive a tone from the transceiver to be accessed. For details, consult your local repeater reference.

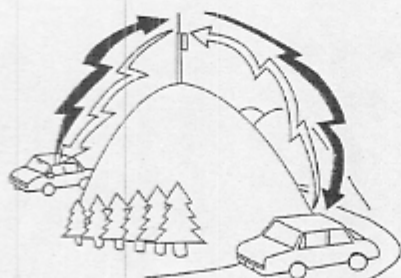

TX: 223.040MHz  
TX Tone: 88.5Hz  
RX: 224.640MHz

TX: 223.040MHz  
TX Tone: 88.5Hz  
RX: 224.640MHz

## 5. Operating Basics

### 【Offset Programming Flow】

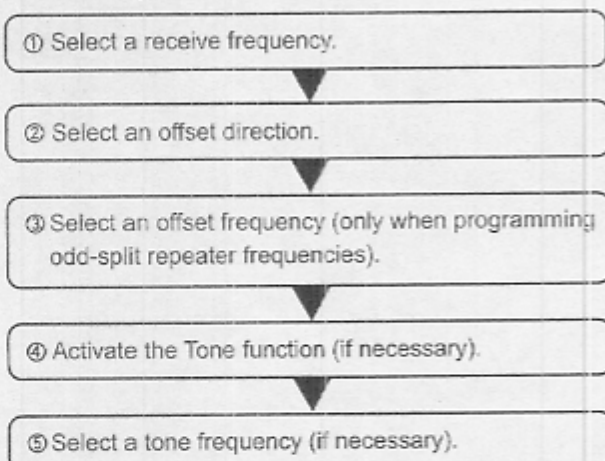

If you store all the above data in a Memory Channel, you will not need to reprogram the parameters every time. Refer to "MEMORY CHANNELS".

### 【Setting Offset Direction And Offset Frequency】

Repeater receives a signal (UP-LINK) on the frequency and re-transmits on another (DOWN-LINK). The difference between these two frequencies is called the offset frequency. The default offset frequency on VHF band is 1.6 MHz; If the UP-LINK frequency is higher than the DOWN-LINK frequency, the shift direction is positive, and if it is lower, the shift direction is negative. The offset is variable between 0 to 5.000MHz on JT-200M unit.

Press the **FUNC** key. While the screen displays "G" icon, press **MHz** key. Screen shows the current status of offset direction and offset frequency. The default value is 5 MHz in the negative direction. Press **MHz** key until the desired offset direction is set. If **SIMPLEX** mode (without changing transmit and receive frequency) is desired, select the position where both - and + icons disappears.

1. Turn the dial or use **UP/DOWN** keys on the microphone to change the offset frequency. It changes in accordance with the channel step setting value.
2. The offset range of this unit is 5 MHz, the offset frequency which can be set up to 5MHz.
3. In this mode, if press the **FUNC** key again, the offset frequency can be changed in 1 MHz steps for faster setting.
4. Press any other key except **FUNC** or **MHz** to return to the original status.

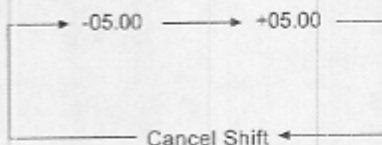

## 5. Operating Basics

### CTCSS/DCS/2-TONE/5-TONE Setting

Many repeaters have CTCSS(Continuous Tone Code Squelch System) or DCS(Digital Coded Squelch) as a "key" to access the system, so-called "selective call". The audio can be heard ONLY when the matching CTCSS tone/DCS code signal is received. The combination of CTCSS squelch and DCS function is not available, only one or the other may be used for a given memory channel. But 5-TONE/2-TONE can combine with CTCSS/DCS to use, DTMF/ANI, 5-Tone/ANI function can show the calling code of the opposite party.

1. Press **TS/DCS** key. The current setting will display with T/SQ/DCS icons and relative frequency/code. Press the same key to select T/SQ/DCS setting.



2. The numbers (such as 88.5) represent the CTCSS frequency in Hz. When it is displayed with "T" only, the unit transmits CTCSS (encode) infrasonic frequency tone when pressing **PTT** (encode) and the repeater access is enabled (assuming the repeater is using 88.5)
3. Press the same key again so that "67" shows on the screen. This is the CTCSS decode frequency. This enables CTCSS squelch (or tone squelch, TSQ)
4. Press it again so that "DCS" icon, normal code and inverted code of DCS are displayed. Normal code icon is 023N; inverted code icon is 023I. They enable DCS encoding and decoding.

For item 2-4, turn the main dial or press the **UP/DOWN** keys to change CTCSS or DCS normal and inverted codes. Press any key (except **TS/DCS, UP/DPWN** keys) to confirm to enter the setting and return to original status. The TS/SQ/DCS icon will remain on the screen to show the current status. To exit, simply press the **TS/DCS** key until the relative status icon T/TQ/DCS disappears.

The CTCSS encoding and decoding frequencies may be set differently. The encode setting frequency automatically relates to the decode setting, but decode setting does not affect encode. The standard set of 50 different CTCSS tones are available as shown on the chart below. DCS encode/decode cannot be separated and are selectable from 104 codes as shown below.

67.0	69.3	71.9	74.4	77.0	79.7
82.5	85.4	88.5	91.5	94.8	97.4
100.0	103.5	107.2	110.9	114.8	118.8
123.0	127.3	131.8	136.5	141.3	146.2
151.4	156.7	159.8	162.2	165.5	167.9
171.3	173.8	177.3	179.9	183.5	186.2
189.9	192.8	196.6	199.5	203.5	206.5
210.7	218.1	225.7	229.1	233.5	241.8
250.3	254.1				

CTCSS Tone Frequency (Hz)

023	025	026	031	032	036	043	047	051	053	054
065	071	072	073	074	114	115	116	122	125	131
132	134	143	145	152	155	156	162	165	172	174
205	212	223	225	226	243	244	245	246	251	252
255	261	263	265	266	271	274	306	311	315	325
331	332	343	346	351	356	364	365	371	411	412
413	423	431	432	445	446	452	454	455	462	464
465	466	503	506	516	523	526	532	546	565	606
612	624	627	631	632	654	662	664	703	712	723
731	732	734	743	754						

DCS Code

### 2-TONE/5-TONE (Optional)

2-Tone, 5-Tone code is similar to the function of CTCSS/DCS, as a "key" to access the system, so-called "selective call". And 5-Tone code also has special call function, including Send Message, Emergency, Call all, ANI, Stun, Waken, etc.

## 5. Operating Basics

- When a certain channel has set 2-Tone, only when suited 2-tone has been received, the function can be performed, and open squelch.
- When a certain channel has set 5-Tone, only when suited 5-tone has been received, the function can be performed, and open squelch.
- When a certain channel has set 2-Tone and CTCSS or DCS, only when suited 2-tone and CTCSS or DCS have been received, the function can be performed as the two conditions met together, and open squelch.
- When a certain channel has set 5-Tone and CTCSS or DCS, only when suited 5-tone and CTCSS or DCS have been received, the function can be performed as the two conditions met together, and open squelch.

### DTMF

This transceiver provides you 8 SPR storage, C0 is DTMF number of transceiver. C1-C6 can be DTMF number, combined number or number of the opposite party. CP is the last received oppsite code, which is a temporarily station, and can't be changed. The default value: 000

#### NOTE:

1. In long distance, when signal is weak, the incoming DCS coded-signal may have deviation, and then your transceiver may not turn on DCS squelch. If it occurs, please press **TS/DCS** key to get into setting mode and press **CALL** key, a decimal point appears on the 10 MHz order, at this moment, if DCS squelch has BEEN turned on once, even if the DCS code deviation is large or signal is weak transmitted by opposite party, DCS squelch will always be ON state. When DCS code value has been changed, DCS squelch will be OFF. To exit this setting please press **CALL** key again, decimal point disappearing on the 10 MHz order indicates to exit, and press again any keys except **CALL** key to back to original state. This setting can also be stored in a certain memory channel.
2. DTMF/ANI/2-Tone/5-Tone only can be preset by programming software, to invoke or switch them please consult microphone operation(P34).

### Memory Channels

In Memory Channels, you can store frequencies and related data that you frequently use so that you do not need to reprogram that data every time. You can quickly recall a programmed channel through simple operation.

The memory mode on this transceiver provides up to 99 channels (1-99, 1-80 as fixed channel, 81-99 as programmable channel), 1 call (quick recall channel) and a pair of program-scan "edge memory" channels for quick, easy access to the preprogrammed frequencies with different parameter settings.

1. Press **V/M** key. "**M**" appears on the screen to indicate that the unit is in the memory mode. Repeat to switch the mode between VFO and memory.
2. In memory mode, turn the main dial or press **UP/DOWN** keys to change the memory channel number. Also can directly input the no. by DTMF keypad.
3. If change the number by units of 10, press **FUNC** and rotate the main dial or press **UP/DOWN** keys while "**10**" displays on the screen.

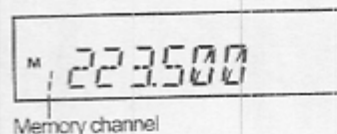
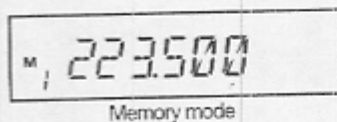

## 5. Operating Basics

### 【Memory Channels Programming】

1. Return to VFO mode by pressing **V/M** key. In this mode, program the desired frequencies and relative data. About CTCSS frequency and DCS code please refer to the settings on forenamed list.

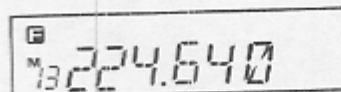

Channel has entered

2. When all the settings are complete, press **FUNC** key. "C" and "M" appears and a memory channel number will be indicated on the screen.

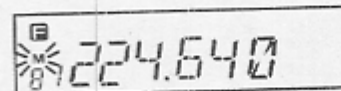

Channel has not entered(empty)

3. Turn the main dial or press the **UP/DOWN** keys to select the desired memory channel number into which the current VFO settings will be stored. An empty channel is shown with a flashing "M". It may be a good practice to allocate memory channels in order, such as 1-9 for local repeaters, 10-19 local simplex, 20-49 repeaters within the area, 50-79 for reserve, 80-98 simplex reserve. It makes references easier for the operation and future modifications of the memory channels.
4. While "C" displays on the screen press **V/M** key. The VFO settings are stored to the memory channel and a beep will sound. The memory channel can be over-written if a previously programmed channel is selected (the memory channels shown with stable M).  
Note: 1-80 as fixed channels which can not done frequency, only can done other parameters.
5. To program the **CALL** channel (quick recall) select the channel shown with **C** icon on the screen. Save CH-99 to store the setting used for the Alarm operation, which will be explained later. Use **PL** and **PH** for Program scan setting, which will be explained in the Advanced Operations chapter).
6. To delete a programmed channel, select it in memory mode, press **FUNC** key then press the **V/M** key while "C" is on. The memory is deleted and a beep sounds. The "M" starts flashing showing that this channel is now empty. If you want to delete or change the other parameters of 1-80 fixed memory channels, please take the steps above to set done in VFO mode.
7. To cancel "Delete", repeat 6. However, the cancel function becomes impossible once the channel or the mode is changed.

### 【Programmable data in memory channels】

Some features will be explained later so please read this instruction manual thoroughly prior to programming memories. Memory channels (including 1-99 and CALL) can store following.

- Frequency
- Offset Frequency
- Offset Direction
- CTCSS Tone both Encode and Decode
- DCS Code (Encode and Decode)
- Scan Skip Channel
- Busy Channel Locked Setting
- Prior Monitoring Frequency (PC programming required)
- Normal/Narrow FM Width
- 2-Tone/5-Tone code

#### NOTE:

1. In the programmed memory channels, you only can temporarily modify or delete some certain parameter values.
2. Only the frequency can be stored in **PH** and **PL** channels to determine the edges of the program scan range.

## 5. Operating Basics

### Call Mode

This is a memory mode that allows the transceiver to quickly recall the assigned memory channel by simply pressing the **CALL** key, regardless of the current status of the unit. Default CALL frequency: 223.500MHz

1. Press **CALL** key. The C icon appears on the screen and the transceiver enters the CALL mode. In this mode, the main dial or the **UP/DOWN** keys cannot change the frequency or memory channels.
2. Press **CALL** key again or press **V/M** key to exit CALL mode.
3. No scan functions are available in CALL mode.

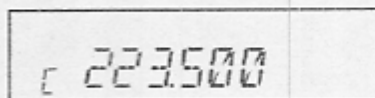

To store a desired setting in the CALL channel, follow the memory mode programming instructions and assign your selected settings to memory channel C. The call channel can be modified but cannot be eliminated or hidden.

### Receiving Signals

1. Be sure to have connected the unit with the appropriate antenna, powered on, set the audio volume and squelch level properly.
2. Select the desired receiving frequency or scanning different frequencies to monitor ongoing communications. The S-meter shows relative signal strength between BUSY and FULL when the transceiver detects an incoming signal.
3. If the S-meter indicates an incoming signal but nothing is heard from the speaker, check audio level, squelch level, and CTCSS/DCS decoding status, which are explained elsewhere in this manual.
4. The Monitor function is available to receive weaker signals. Press and hold **SQL** key for more than 1 second. Regardless of the squelch, it will be opened and "**BUSY**" displays on the screen. Press any key on the front panel to exit.

### Transmitting Signal

1. Select the desired frequency. Be sure that you are authorized to operate on the selected frequency. Check the system and monitor the frequency to make sure that you are not going to disturb any ongoing communication.
2. Select the output power. Press **FUNC** key and then press **CALL** key while "**C**" displays on the screen. As the **CALL** key is pressed, the output power changes among 3 levels. The "**Lo**" stands for LOW power setting, "**Mi**" for MEDIUM power. When the transceiver is set at HIGH power, no icon will display. The output power level cannot be changed during transmission.
3. Default setting is High power. Press the **PTT** key on the microphone to transmit, release it to receive. During transmission, the relative power output is shown on the S-meter as:

LOW power = 2 segments

MID power = 3 segments

HIGH power = 5 segments

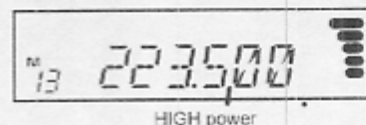
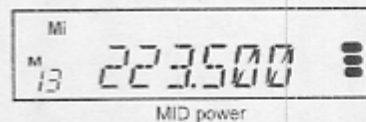
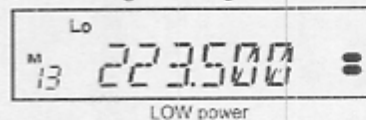

## 6. Parameter Setting

**[IMPORTANT]** Please read the following content thoroughly before changing any parameters. By entering the Parameter Setting mode, some of the transceiver's operating parameters can be changed to suit your application. The following is the Selectable Parameters' Menu.

**NOTE:**

1. The Alphanumeric Channel Tag setting will not appear in the menu until memories have been programmed first!
2. Only in VFO mode, the setting value of channel spacing step will appear in MENU.

### Parameter Setting Mode

1. Press **FUNC** key for more than 2 seconds to enter the Parameter Setting. Use **SQL** key or **UP/DOWN** keys to select menu.

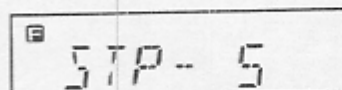

Default setting

2. Rotate the main dial to select the desired settings.
3. Press **SQL** or **UP/DOWN** keys again to enter the selected setting into the radio's memory. The transceiver is now ready for additional Parameter adjustment.
4. Press any other key except **SQL/UP/DOWN** to exit the Parameter mode. The only exception is the Channel Tag setting which accepts only **PTT, FUNC, MHz** and **TS/DCS** keys to exit.

### Detail Of The Feature In Menu

Please refer to "Parameter Setting" for setting operations. The operation procedures of some features are explained later in detail.

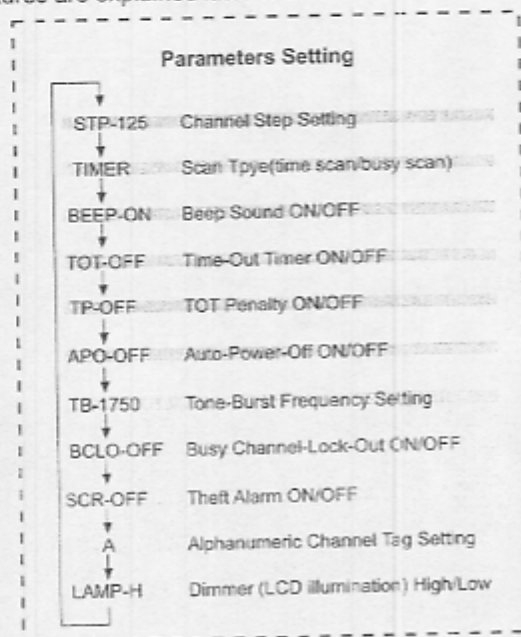

## 6. Parameter Setting

### Channel Step Setting

This is to select the channel step to be used in the VFO (Variable Frequency Oscillator) mode. Refer to the chart below for the relation of the actual step frequency and how it is displayed.

STP-5

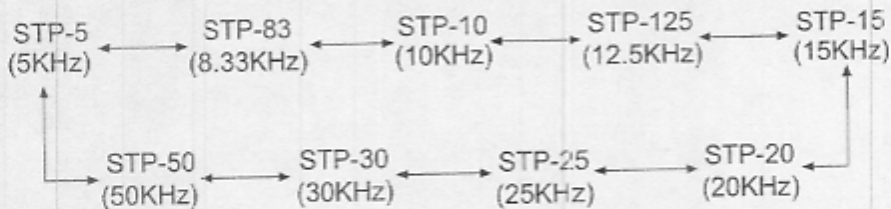

### Scanning Type

This is to select the scan resume condition. TIMER (calculagraph) setting allows the radio to resume scanning after 5 seconds, regardless of the signal receiving status, BUSY setting resumes scanning when the received signal has gone. The scan mode will be explained later.

TIMER

### Beep Sound

BEEP-ON setting enables a beep that sounds after some keys are touched and/or setting is done. BEEP-OFF shows that the beep function is off.

BEEP-ON

### Time-Out Timer

The TOT feature is popular in repeater systems. It prohibits the users from transmitting after a certain period of time. By setting this function and activating it according to the repeaters' requirement, the radio alerts the user by a beep 5 seconds before stop transmitting. When the time is expired, transmitting stops and the transceiver automatically returns to receiving mode. This avoids the repeater going into its TOT mode. Until the PTT is pressed once again, the transceiver will not transmit.

1. In this Menu the default screen shows TOT-OFF.
2. Turn the main dial to select time-out timer. Screen should change as shown. The number followed by TOT is the time-out timer in seconds.
3. The TOT feature is selectable up to 450 seconds (7.5 minutes).

TOT-OFF

TOT-60

during the setting time of 60 seconds



## 6. Parameter Setting

### TOT Resuming Time

When the transmission is shut down in the TOT mode, this function prohibits another transmission for a selected time period.

1. During the TOT resuming period, the beep sounds when the **PTT** is pressed but the radio does not transmit.
2. Default setting is TP-OFF (TOT resume stop). Rotate the main dial to select the resuming time, up to 15 seconds.

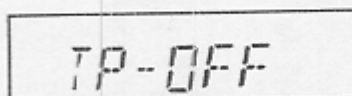

TP-OFF

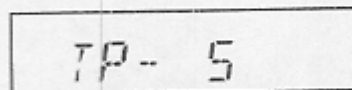

TP- 5

during the setting time of 5 seconds

### APO—Auto Power OFF

This feature will automatically turn off the transceiver. It is useful for mobile operation to avoid draining the car battery. If there is no activity or use of the radio, it will turn off automatically after 30 minutes. In one minute before turning off, transceiver will sound beep for seconds.

1. Default is APO-OFF (automatic turn off function disable).
2. Turn dial to select APO-ON to activate the function.

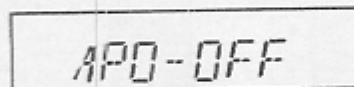

APO-OFF

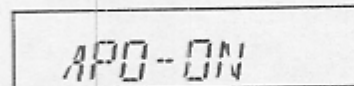

APO-ON

during the ON setting

### Tone—Burst Frequency

This is to access Tone-Burst repeater which require a certain pitch of audible tone to activate "sleeping" repeater. Usually, a repeater system does not require the tone once the repeater is activated.

1. The default is TB-1750, which is 1750Hz tone.
2. It is selectable from 1000, 1450, 1750, 2100Hz.

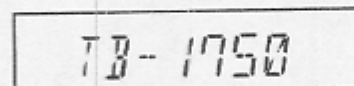

TB- 1750

during the 1750Hz frequency

### Busy Channel Lockout

This function prohibits transmission as there is a signal indication icon on the receiving frequency position. The default is BCLO-OFF, which means the function is OFF. To set this function ON, the radio transmits only when:

1. No signal is received on the receiving frequency.
2. Matching CTCSS tone or DCS code is received.

Otherwise, when press **PTT**, a beep sounds, but the unit does not transmit.

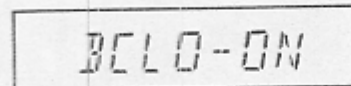

BCLO-ON

during the ON setting

### Burglar Alarm

Default is SCR-OFF. Select ON or DLY (delay) to activate the function. When the SCR-ON is selected, 100MHz and 100KHz order decimal points will appear on the screen. Operation way of the transceiver will be show later.

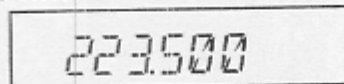

223.500

## 6. Parameter Setting

---

### Alphanumeric Tag

---

The memory channels stored in the memory-mode can be displayed with an alphanumeric tag instead of the default frequency display. Program the memory channel first. There are 67 characters available including A-Z, 0-9.

1. Enter the set mode while the units is in memory mode(refer to page 23).

2. Select alphanumeric tag setting by rotating the main dial or pressing the **UP/DOWN** keys. **A** flashes on the screen.

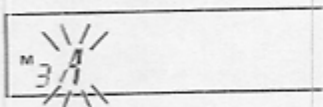

3. Turn the main dial to select a character. Press the **V/M** key. The character stops flashing and is entered.

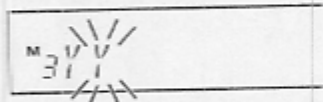

4. The same flashing character appears next to it, ready for entering the next character. Repeat the same sequence, up to seven characters.

5. To delete all characters during programming press **CALL**.

6. To exit after setting is done, press **PTT, FUNC, or TS/DCS**.

After programming, the alphanumeric tag will be displayed on the designated channels, instead of the frequency, when in memory mode. The memory channel number and other icons will also be displayed. If you wish to see the programmed frequency, press **FUNC** and it will be displayed for 5 seconds. To return to the alphanumeric display, wait 5 seconds or in succession press **FUNC** to return to normal operation.

---

**[IMPORTANT]** This function cannot be enabled without preprogramming the memory channels.

---

### Dimmer

---

The screen illumination can be dimmed.

1. "LAMP-H" is displayed as default.

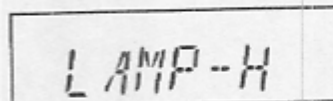

2. Turn the dial to choose brighter (H) or darker (L).

## 7. Advanced Operation

Your transceiver offers different features for advanced operations.

### Scan

Use this function to automatically search for signals. 6 different scan types are available in the unit. In parameter setting mode, choose Timer mode or Busy mode to determine the desired resuming condition. If the CTCSS (TSQ) squelch or DCS squelch is set, the audio can be heard only when the CTCSS tone/DCS code matches the incoming signal. Otherwise, scanning stops but no audio will be heard. The direction of scan, upward or downward, can be changed during the scan by rotating the main dial or pressing **UP/DOWN** keys in the desired direction.

#### [VFO Scan]

Scans all VFO channels in regard to the preset tuning step.

1. Enter VFO mode.
2. Press **UP** (to go upward) or **DOWN** (to go downward) key for more than 1 second.
3. The scan starts. It stops at the frequency where the incoming signal is detected, and resumes the scan according to the resume setting.
4. Press any key (other than **UP/DOWN** keys) to exit.

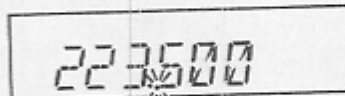

#### [Memory Scan]

Scans all memory channels unless Memory skip feature is selected for a given memory.

1. Enter Memory mode.
2. Sequence is the same as in VFO scan. Use **UP/DOWN** keys for commands.

#### NOTE: Memory Skip Feature

This feature allows determined memory channels to be skipped during the scan.

1. In memory mode, select the channel to be skipped. Press **FUNC** key. While "M" is visible on the display, press **V/M** key. Repeat the sequence to delete the setting.
2. When the memory channel is set to skip, the 10 MHz order decimal point will be displayed.
3. The 1-80 memory channels and the 99th channel are the burglar warning channel, which can not be set to skip.
4. CALL, PL and PH are always skipped during Memory scan.

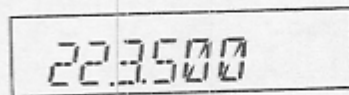

lights up

#### [Program Scan]

This is a type of VFO scan, but by setting the frequency range of the VFO into PH and PL channels, it only scans between those frequencies. With setting the PH and PL properly, up to 3 program scan ranges will be available.

1. Enter the VFO mode and set the desired scanning frequencies into the designated PL and PH memory channels. Refer to Memory Channel Setting for the proper sequence.
2. Return to VFO mode by pressing **V/M** key. Set the VFO to the frequency within the range to be program-scanned.

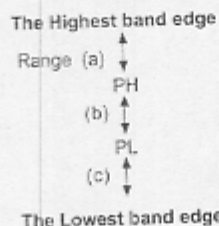

## 7. Advanced Operation

---

3. Press **MHz** key for more than 1 second to start scanning. During this scan mode, "P" flashes after memory channel display.
4. Use main dial or **UP/DOWN** keys to change the direction. Press any key (other than the **UP/DOWN** keys) to exit.

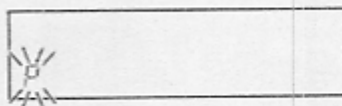

### **【CTCSS Scan】**

This function automatically searches for the CTCSS tone an incoming signal might carry. This feature is useful to search the encoding tone of a repeater, or to communicate with a station operation in TSQ (CTCSS squelch) mode.

1. Press **TS/DCS** key to enter CTCSS decode setting mode.
2. Press **UP/DOWN** key for more than 1 second but less than 2 seconds to start scanning. It scans 50 tones in order.
3. The decimal point on the tone frequency will flash, and it stops when the matching tone is detected.
4. The scan won't resume until the operation is repeated.
5. Press any key (other than **UP/DOWN** keys) to exit.

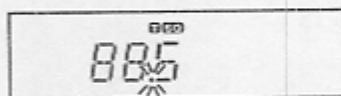

### **【DCS Scan】**

Same as previous, but for DCS normal and inverted code search.

1. Press **TS/DCS** key to enter DCS setting mode.
2. Press **UP/DOWN** key for more than 1 second but less than 2 seconds to start. It searches the 104 DCS normal and inverted codes in order. Normal code shows 023N; inverted code shows 023I.
3. The 1 MHz order decimal point will flash.
4. The scan stops when the matching code is detected.
5. The scan won't resume until the operation is repeated.
6. Press any key (other than **UP/DOWN** keys) to exit.

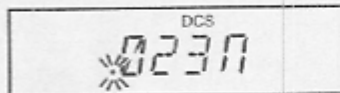

## 7. Advanced Operation

### Key-Locked Function

This will lock several keys to avoid unintentional operating transceiver.

1. Press **FUNC** key and press **TS/DCS** key while "☐" is on the screen.
2. The "On" icon appears.
3. With this function activated, only the following commands can be accessed:
  - **PTT**
  - **FUNC + TS/DCS** to cancel this function
  - Monitor function (to release squelch for weak signal receiving)
  - Squelch setting
  - **UP/DOWN** keys

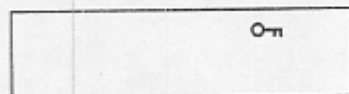

### Tone Burst

Press the **DOWN** key while **PTT** is pressed. The tone burst will be transmitted as long as both keys are pressed together. Usually just a few seconds of burst is enough to activate the repeater.

### Wide/Narrow Band

This unit is fixed to work in narrow band mode. Switching wide/narrow band mode:

1. Press **MHz** key while keeping **FUNC** key pressed. "Nar" appears on the LCD screen and the transceiver enters to **NARROW** mode.
2. Repeat the same sequence to switch between the **WIDE/NARROW** modes. When the transceiver is in the **WIDE** mode, "Nar" disappears on screen.
3. In the **NARROW** mode, the microphone gain and modulation during transmission and the demodulation range during receiving will be lower.

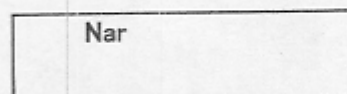

### Compander Function

This function can decrease the background noise and improve the audio quality.

1. Press **FUNC**, and then press **SQL** when "☐" displays on the screen. While "⏏" shows this function is ON.
2. Repeat the above operation, the transceiver switches between ON/OFF Compander function. "⏏" disappears on screen while set OFF this function.

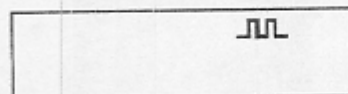

### ANI Function

This transceiver uses DTMF/5-TONE to realize ANI function. When channels have been programmed to have ANI function, press **PTT** to send the reprogrammable DTMF/5-TONE codes, it will display caller information to realize ANI function after called transceiver has decodes.

## 7. Advanced Operation

### Auto-Dialer

This will automatically transmit pre-programmed DTMF tones. DTMF (Dual-Tone-Multi-Frequency) are the same tones used in the telephone system, and they are often used to remote control electronic devices or AUTOPATCH phone systems available on some repeaters.

#### To program tones in the Auto-dialer memory:

1. Press **FUNC** key and **TS/DCS** key at the same time to enter the setting mode. Default display is 1 on the right end of the screen. Memory channel icon displays which of the 9 auto-dial memories(1~9) is in use.
2. Use **UP/DOWN** keys to select the desired channel.
3. Rotate the main dial to select the first digit, then press **TS/DCS** key to enter. The Cursor moves toward right. Repeat sequence to complete.
4. Use **"--"** for pause. The display scrolls when the 7th digit is entered. The numbers 0 to 9, pause, \* and # can be stored (Max.16 digits).
5. To check the entered digits, press **FUNC** then rotate the main dial while **"☐"** displays on the screen.
6. To delete, press **CALL** key. Press **PTT**, **V/M**, **MHz** or **SQL** keys to exit and return to original status.

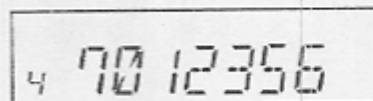

Ex. Dialer set mode

#### Dialing numbers in the Auto-dial memory:

1. Choose the desired communicating frequency or memory channel.
2. Press **FUNC** and **TS/DCS** at the same time to enter setting mode. Choose autodialing memory channels.
3. Press **PTT** and **UP** at the same time to transmit a group of numbers stored in the Auto-dialer memories.

### Burglar Alarm

This alert uses a beep sound when the unit is about to be removed in an unwarrantable way. This function is useful when the unit is installed in a vehicle.

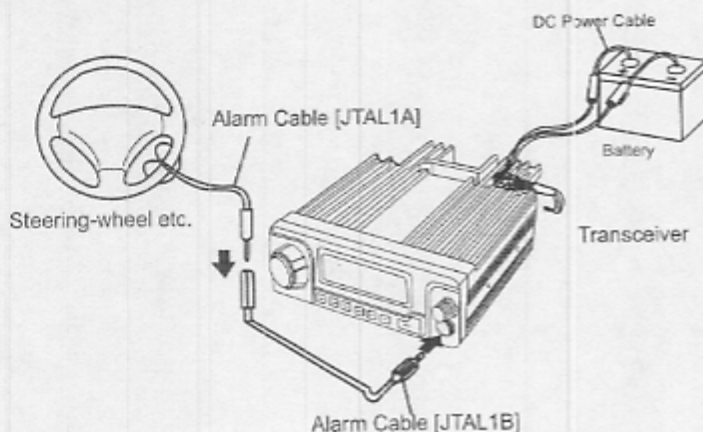

## 7. Advanced Operation

---

### **【Operation 1】**

**Setting:** Connect the provided alarm DC cable directly to the battery.

1. Connect the provided alarm cable to the DATA jack on the front panel as shown. Secure the other end of the cable to an object that stays fixed in the vehicle.
2. Enter the Parameter Setting mode by pressing **FUNC** key for more than 2 seconds. Use **SQL** or **UP/DOWN** keys to select menu and rotate the dial to set SCR-ON. Press any key other than **SQL/UP/DOWN** key to enter the setting and exit.
3. Turn off the unit with PWR switch. The TX LED will light.

To turn off the alarm function, turn on the unit, enter the Parameter setting mode again, and select SCR-OFF. When alarm is activated, the decimal points on 100 MHz and 10kHz order will flash on screen.

---

#### **NOTE:**

1. The alarm function is ON only when the unit is turned off.
  2. When alarm is activated (SCR-ON or DLY), the ignition key function does not work.
- 

#### **Function:**

1. When the alarm cable is removed from the DATA jack or cut without using the proper sequence, the alarm sounds for 10 minutes. During the alarm, the unit goes to receive on memory channel 99, according to its pre-programmed setting (TSQ/DCS received).
2. When a signal is received on Channel 99, the alarm stops.
3. Turning on the unit with SQL key pressed also cancels the alarm.
4. Turn the unit off again with the alarm cable connected properly. It returns to the alarm mode.

### **【Operation 2】**

Choose this operation when a delay period is desired.

1. Enter the Parameter setting mode as described previously and select SCR-DLY. Follow the previous instruction to set.
2. Turn off the unit. Display will disappear but the LCD illumination stays on. After 20 seconds TX LED lights up, illumination dims, and alarm functions. The system won't work during the 20-second "DELAY" period.
3. The alarm sounds under the same condition as described previously. There is a 20 second delay until the alarm sounds. During the 20-second period, only the display illumination is lit. Turn ON the unit during "DELAY" period to cancel the alarm function.  
**Do set SCR-OFF during normal operation.**

---

#### **NOTE:**

1. Start alarming, the unit will switch between transmitting and receiving signals per 5 seconds (lasts 1 minute), and then the audio-alarm sounds for 10 minutes.
  2. Setting and operating this function is same with other models, it allows you to monitor and control alarm far away on memory channel 99.
-

## 7. Advanced Operation

---

### Programming Data By Computer

---

This feature will program data and memory channel parameter by computer.

#### **[Connection]**

Turn off the transceiver, connect the unit with computer using the optional programming cable. Program and write the data into transceiver by using the optional programming software.

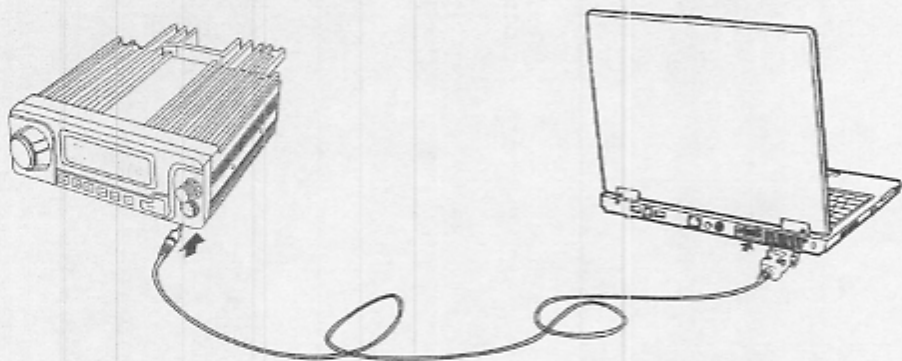



## 8. Microphone Operation

### Keys' Instruction

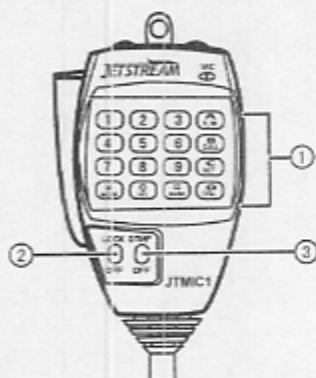

1. Dual-audio keypad -- setting functions, inputting VFO frequency or dialing DTMF, etc.
2. LOCK/OFF--Key locks (Lightening turns ON/OFF in synchrony).
3. DTMF OFF and DTMF keypad switch between dual-audio dialing, functions operating, etc.

### Functions Chart

Key	Transceiver corresponding key	Function
0-9	—	Input frequency directly and choose memory channel no.
A	V/M	Switches between VFO and Memory mode
B	CALL	Switch to Call Mode
C	Press <b>FUNC</b> for more than 2 seconds	Switch parameter setting modes, matches with # key to check the value of DTMF/ANI/2Tone 5Tone
D	<b>FUNC</b> + TS/DCS	Program auto dialer values
*	Press <b>SQL</b> for 1 second	Monitor function
#	—	Switch to DTMF/ANI/2-Tone/5-Tone mode
0	H/L	Switches transmission output among HI, MID and LOW.

#### NOTE:

1. Under the Parameter setting mode, press **UP** or **DOWN** to choose menu, press \* or # to choose the desired setting, press any other key except \*, #, **UP** or **DOWN** to exit the Parameter setting mode.
2. Setting the auto dialer, press **UP** or **DOWN** to choose memory channels, input the numbers on the keypad. Press \* or # to choose numbers or symbols, press **A** to enter, press **C** to clear, press **B**, **D** or **PTT** key to return to the initial status.
3. Only DTMF/ANI/2-TONE/5-TONE mode has been selected, **C** key matches with # key to check the value of DTMF/ANI/2-TONE/5-TONE. In addition, press and hold **FUNC** key for 3 seconds to enter, the value also can be checked by matching with **UP** or **DOWN** key.

## 8. Microphone operation

---

### Inputting Frequencies

---

Frequencies can be entered directly by pressing the numerical (1~0) keys.

1. Set the microphone DTMF OFF to OFF.

2. DTMF keys can be used to enter frequencies from 222MHz(Transceiver frequency range: 222-225.0000MHz).

(Ex.) When want to set 223.500MHz, correspondingly channel tuning step to input "2", it displays

Input (2) (2) (3) (5) (0) (0)

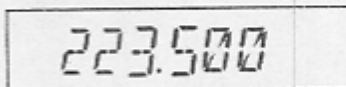

After inputting "5" and "0", a slightly longer beep is heard and the input is complete. The output frequencies cannot be input.

3. Cancelling the entry : Press PTT, or any key other than the numerical keys.

### Choose Memory Channel

---

In memory channel, press DTMF keypad(1~0) to choose directly.

1. Switch the OFF key on MIC DTMF to the OFF position.

2. (EX.)When you want to choose "1" memory channel, directly press key"1", it will switch to "1" memory channel after 2 seconds.If the memory channel no. is double-digit, it will directly switch to the desired channel after entering the no.

---

**NOTE:** Only the programmed memory channels can be chosen.

---

## 9. Maintenance

### Reset

Resetting the transceiver by returning all programmed setting to default setting. If the trouble continuously appears, this function can solve the problems and return to the normal operation status.

### How To Reset

Press **FUNC** for 3 seconds and power ON the transceiver, all the icons will display on the LCD screen, and then display the default setting.

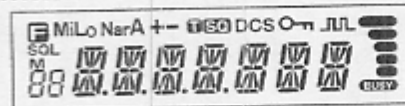

all icons display on the LCD screen

**NOTE:** All the settings would be initialized, therefore pay more attention on resetting operation.

### Default Setting After Resetting

VFO Frequency	223.500MHz	CTCSS Frequency	88.5Hz
CALL Frequency	223.500MHz	DCS Setting	—
Memory Channels (0~99)	—	DCS Code	023N
Offset Direction	—	Output Power	HI
Offset Frequency	1.6MHz	Key Locked Setting	No Use
Channel Stepping	12.5k-Hz	TOT	No Use
CTCSS Setting	—	APO	No Use
		Squelch Level	0

### Trouble Shooting

If the transceivers malfunctions, check the fauewing chart for trouble shooting.

Trouble	Shooting Guide
Unit will not power on	The battery pole is reversed. Connect the Red lead to positive terminal of the DC power, connect the Black lead to negative terminal.
The fuse is blown	Check out the problem and solve, replace a new fuse.
The screen is too dim	Setting the dimmer LAMP-L to LAMP-H.
No sound from the speaker	Decrease the squelch level when it is set to mute. Set the Tone-Burst or DCS squelch function ON. Set OFF the CTCSS/DCS function.
The keys and main dial will not work	Set ON the Tuning-Locked function. Set it OFF.
The main keypad couldnot change the memory channel.	The transceiver is on CALL or VFO mode.
Press PTT but cannot transmit signals	The microphone is installed incorrectly. Please connect correctly again.

## 10. Specification

General Specification	
Frequency Range	TX:222.000-225.000Mhz RX:216.000-280.000Mhz
Mode	16KOF3E (FM) 8K50F3E (Narrow band FM)
Frequency Rate	12.5 kHz
Number of Channels	99 channels
Antenna Impedance	50 $\Omega$ Imbalance
Frequency Stability	$\pm$ 5ppm
Microphone Impedance	2 k ohm
Regulate Voltage	DC 13.8V $\pm$ 15% (11.7-18.5)
Current	Transmit: $\leq$ 9A Receive: $\leq$ 600mA
Working Temperature	-10°C ~ +60°C (+14° F ~ +140° F)
Grounding	Negative
Size	145(W)X47(H)X190(D)mm
Weight	about 1.2kg
Transmitter	
Output Power	50W (high) 25W (medium) 1W (low)
Modulation	FM
Residual Radiation	-60dB or below
Max. Fre. Deviation	$\pm$ 5KHz, $\pm$ 2.5KHz (Narrow band mode)
Receiver	
Circuit	Double conversion
Sensitivity	-12.0 dBu (0.25 $\mu$ V) or below 12dB SINAD
If Frequency	First: 21.7MHz, Second: 450KHz
Squelch Sensitivity	-16.0 dBu (0.1 $\mu$ V)
Selectivity	>60dB/12.5KHz >70dB/25KHz
Intermodulation	>65dB
Audio Power	2.0 W (8 $\Omega$ , 10% distortion)

## **Customer's records**

---

The serial number of this product can be found on its body.

You should note this serial number in the space provided below and retain this book plus your purchase receipt as a permanent record of your purchase to aid an identification in the event of theft of lose, and for warranty service purposes.

MODEL NUMBER: \_\_\_\_\_

SERIAL NUMBER: \_\_\_\_\_

---

We sincerely hope that this manual can bring you convenience! With the development of the technology and the lapse of time, we reserve the right of revision in terms of the standard, technical requirement and all kinds of product specifications referred to in this manual. Please understand if not keeping you informed of the new information.



Licensing requirements

This device complies with part 15 of the FCC Rules. Operation is subject to the following two conditions: (1) This device may not cause harmful interference, and (2) this device must accept any interference received, including interference that may cause undesired operation.

**FCC ID: W48JT220M**

**Caution**

Changes or modifications not expressly approved by the party responsible for compliance could void the user's authority to operate the equipment.

Web site: [www.jetstream-USA.com](http://www.jetstream-USA.com)

Address: 100 Hancock Ave., Hamilton, Ohio 45011, USA

Tel: 800-524-4889

513-868-1353

Fax: 513-868-6574

