



JOHNSON
ELECTRONIC
EQUIPMENT

E. F. JOHNSON COMPANY
WASECA MINNESOTA

OPERATING MANUAL
JOHNSON VIKING II
RADIO
TRANSMITTER

E. F. JOHNSON CO. VIKING II TRANSMITTERS

SPECIAL WARNING

In the Viking II transmitter, reserve grid driving capability has been provided so as to insure adequate excitation on all frequencies and to allow for variations in individual wiring.

The RCA type 6146 beam power tubes used in the final amplifier have a maximum D. C. grid current rating of 4 ma. per tube.

When 6146 tubes have been overdriven it is evidenced by a negative D. C. grid current reading.

The total grid current should not exceed 8 ma. at any time as exceeding this value may possibly damage the tube and will void the guarantee of the tube manufacturer.

DO NOT EXCEED 8 MA. GRID DRIVING CURRENT AT ANY TIME.

VIKING
II

295

SPECIAL SET-UP INSTRUCTIONS FOR FACTORY WIRED TRANSMITTERS

1. Remove all packing materials and accessories from inside the transmitter including the transformer shipping braces. Pull the nails from the braces, slide blocks toward front panel. The long brace may then be turned slightly and lifted out.
2. Remove bottom plate and take out the three wood blocks. Do not yet replace the bottom plate.
3. Install 6146 tubes in sockets X7 and X17 and install plate caps. (Reference figure 9 in instruction manual.) Check to see that all tubes are seated in their sockets with shields and plate cap connectors in place. Shields are not used for V28, 6AQ5 screen clamper and V11, 6AL5 bias rectifier.
4. Attach knobs to shafts per instructions on pages 7 and 8 of operating manual. Place "Fil" and "Plate" toggle switches in off (down) position.
5. Initial checks should now be made, using if possible, a dummy load. A standard 100 watt lamp will serve very well for this purpose. Connect the center contact of the lamp to the center contact of J3 (refer to figure 10 of manual). Connect the shell of the lamp base to the ground terminal adjacent to J3.
6. With the line cord connected to a 117 volt 60 cycle power source and before installing a crystal or VFO, turn on the low voltage supply (left hand toggle switch on front panel).
7. Oscillator current should rise to between 17 and 23 ma. Set the "drive" control at mid-position.
8. Screen voltages for the 6146 amplifiers V7 and V17 and for the 807 modulators V3 and V4 have already been adjusted by means of the tap on R13 and the potentiometer R30 (adjacent to L10). DO NOT CHANGE THESE ADJUSTMENTS UNLESS THE TEST UNDER STEP 9, FOLLOWING, INDICATE IT IS NECESSARY.
9. Switch the phone/CW switch to the CW position. Turn on high voltage (right hand toggle switch) and observe "plt" current. The plate current should be less than 25 ma. It may prove to be as low as 10 ma. however and this is quite normal. Should the "plt" current exceed 25 ma. turn high voltage switch off at once. (There will be output during this test.)
10. If the "plt" current in step 9 exceeds 25 ma. readjust the screen clamper tube per the instructions on page 11.
11. With plate current normal as in step 9, you are now ready to proceed with the tuning instructions beginning on page 9.
12. The transmitter is normally tuned in the CW position. When the transmitter is delivering full output and the excitation to the 6146s is 6 ma. it will exceed 8 ma. when the high voltage is switched off. Therefore when making tuning adjustments on CW always reduce drive when the high voltage is cut off.
13. After thoroughly testing the transmitter, replace the bottom plate and secure all screws.

Johnson TRANSMITTER

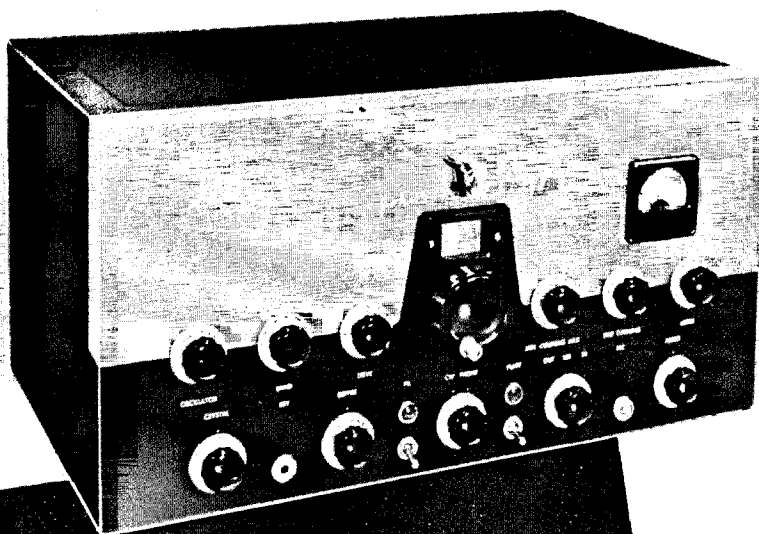

FEATURES:

Amplitude Modulation
Instant Band Switching
VFO Input Provision

Dual Power Supplies
Self Contained, No Plug-in
Coils
Pi-Network Coupling Out-
put Amplifier

RATINGS:

100 Watts Phone Output
130 Watts CW Output

135 Watts Phone Input
180 Watts CW Input

TUBE LINE-UP:

6AU6 crystal oscillator
6AQ5 buffer/doubler
Parallel 6146s final amplifier
6AU6 voltage amplifier

6AU6 driver
807 pp modulators
5R4GY HV rectifiers
5V4G LV rectifier
6AL5 bias rectifier

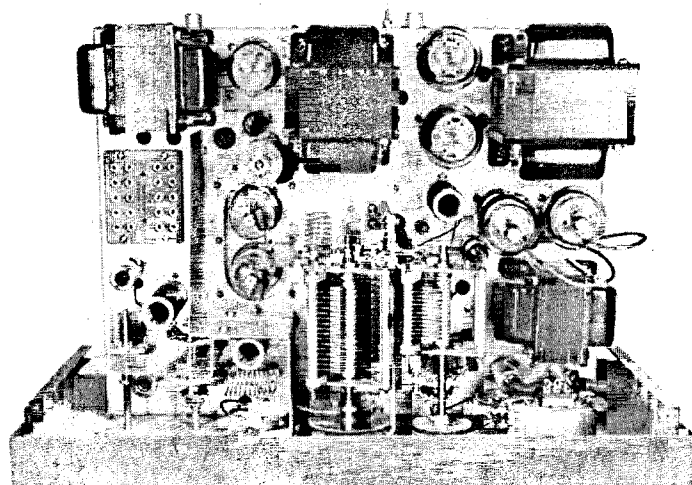

Figure 1. Chassis, Top View

HERE IT IS! The JOHNSON Viking II, successor to the Viking I, and the most versatile, most complete transmitter kit on the market. More than just a kit, the JOHNSON Viking II is an expertly designed and engineered transmitter, furnished unassembled but complete to the last detail.

Includes all necessary parts, hardware, tubes, wiring harness, cabinet and complete assembly instructions. The Viking II performs excellently on every amateur band from 10 to 160, including 15 meters. Output ratings of 100 watts phone, and 130 watts CW were established on the 10 meter band; efficiency on other bands is comparable. The Viking II provides full excitation to the final amplifier on all frequencies; the complete output range of the unit is listed below:

Band	Low Freq. Limit	High Freq. Limit	Band	Low Freq. Limit	High Freq. Limit
160	1.8 mcs.	2.4 mcs.	20	9.8 mcs.	15.0 mcs.
80	2.9 mcs.	4.4 mcs.	15	15.0 mcs.	21.8 mcs.
40	5.2 mcs.	8.0 mcs.	10	21.0 mcs.	30.0 mcs.

POWER SUPPLIES—The low voltage power supply furnishes 300 volts for exciter and speech amplifier plates. In addition to the 5V4G rectifier, a 6AL5 diode rectifying the tapped transformer secondary winding, furnishes well regulated fixed bias for the final amplifier, modulator, and the 6AQ5 buffer/doubler. The 600 volt supply with parallel 5R4GY rectifiers furnishes plate and screen voltage for the 6146s and 807 modulators. High vacuum rectifiers in both power supplies eliminate the need for hash suppression and time delay circuits. Line power consumption is approximately 375 watts when delivering full phone output; primary fusing protects the equipment from accidental overloads. Available for 115 volt 50/60 cycle ac operation only.

The output of the JOHNSON Viking II transmitter, for practical purposes, is uniform throughout its entire range, and the exciter design is such that a minimum number of crystals is required. The pi-section output stage enables the transmitter to be matched to unbalanced antennas with impedances from 50 to 600 ohms. Whether feeding antennas or antenna couplers, the pi-network can tune out several hundred ohms reactance as well. The final tank coil is a Steatite insulated, variable inductor with variable pitch winding maintaining high tank circuit Q throughout its range. The inductor and the band switching exciter entirely eliminate coil changing. Using a crystal microphone, sufficient audio gain and power are available for 100% modulation of the transmitter's maximum input.

RF SECTION—The rf section of the transmitter consists of a 6AU6 crystal oscillator driving a 6AQ5 buffer/doubler which in turn drives the parallel 6146's of the final amplifier. The oscillator utilizes a JOHNSON crystal selector assembly which permits the selection of any one of

Viking II

KIT

ten crystal frequencies from the front panel. An eleventh position on the crystal switch provides for use of an external VFO. The 6AQ5 buffer/doubler is "loafing" when driving the parallel 6146's to full output on all bands. A potentiometer in the screen of the 6AQ5 gives smooth front panel control of amplifier excitation. Parasitics have been effectively suppressed, amplifier neutralization is not required.

KEYING—Fixed bias voltages of the 6AQ5 buffer and the 6146 final amplifier are very near cut-off. Oscillator cathode keying may be used for either crystal controlled or VFO operation.

METERING—Transmitter metering is provided by a milliammeter used as a millivoltmeter and switched across permanently connected shunts. Prevents accidental circuit opening due to meter switching.

AUDIO SYSTEM—100% amplitude plate and screen grid modulation of the 6146 RF amplifiers is achieved with pp class AB₁ 807 modulators. The speech amplifier consists of a 6AU6 voltage amplifier and 6AU6 driver, designed for high impedance microphones. Frequency response is centered in the speech range for most effective voice communication. Degenerative feedback is used to smooth out the response curve and good audio quality is maintained through extremely simple modulator design. Full output of the audio system is also available at nominal 500 ohms impedance for driving a high powered modulator.

EXCITER—A unique crystal oscillator circuit is used in the Viking II. In this oscillator, a Pierce circuit uses the screen of the 6AU6 as a plate, and the oscillator output is electron coupled to the plate. The circuit is a good frequency multiplier, has low crystal current, and requires only a slight amount of excitation from a VFO.

The exciter design is extremely flexible even though only two tubes are used and the circuit is band-switching. On the 160, 80, and 40 meter bands the 6AQ5 is used as a buffer, as a doubler or tripler on 20, 15 and 10 meters. If crystals are used in the manner recommended and their frequencies properly chosen, there is almost no possibility of obtaining output from the exciter which falls outside the amateur band.

VFO REQUIREMENTS—When used with an external VFO the transmitter is easily driven. Less than six volts of

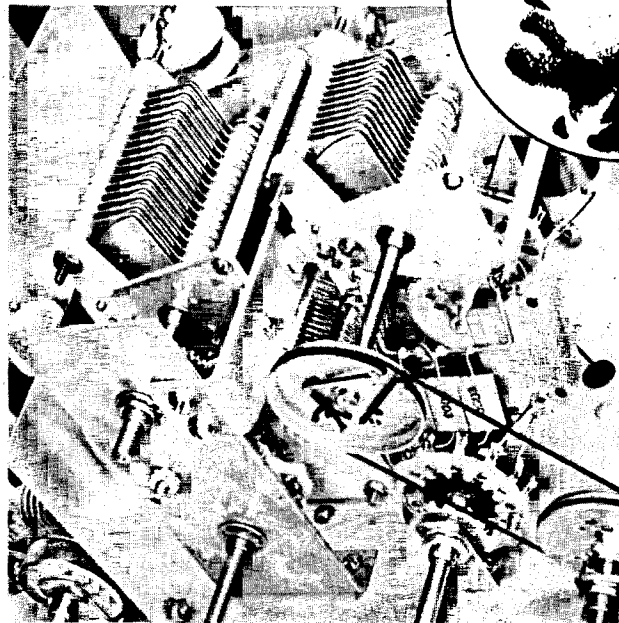

Figure 2. Pi-network Coupling System

7.5 mc. RF is required for full output at 30 mcs., less for the 14 and 7 mc. bands. Two volts of 1.75 mc. VFO output is ample excitation for 1.75 and 3.5 mc. output.

An octal socket on the rear of the chassis provides 6.3 volts ac at 0.6 amperes for VFO filaments and 30 milliamperes at 300 volts dc unregulated for VFO plate voltage. The 240-122 Viking VFO may be keyed from the transmitter, and simply plugs into the chassis for instant operation.

The variable inductor tuning of the amplifier saves space without appreciable loss of efficiency. Separate coils, sufficiently large to handle the amplifier circulating current, would consume a prohibitive amount of cabinet space. Plug in coils would compromise the transmitter's flexible design. The final tank tuning condenser is ganged to the variable inductor and maintains a nearly constant L/C ratio across the entire tuning range.

In order to cover the 160 meter band, additional series inductance is switched into the circuit. The output coupling capacitor consists of a 400 mmf. variable and additional fixed capacitors which can be switched in parallel to match low impedance loads to the amplifier. Maximum value of the coupling capacitor is 2,050 mmf.

Xtal Freq.	Output Band						
	160	80	40	20	15	10	11
1.8-2.0 mc	✓	✓	✓				
3.5-4.0 mc		✓	✓	✓	✓		
7.0-7.3 mc			✓	✓	✓	✓	
14-14.4 mc				✓			
6.7-6.85 mc							✓

The chart above indicates the crystals which may be used for full output on the amateur bands covered by the transmitter.

TVI Suppression Features

Copper Plated Steel
Cabinet

Copper Plated
Meter Shield

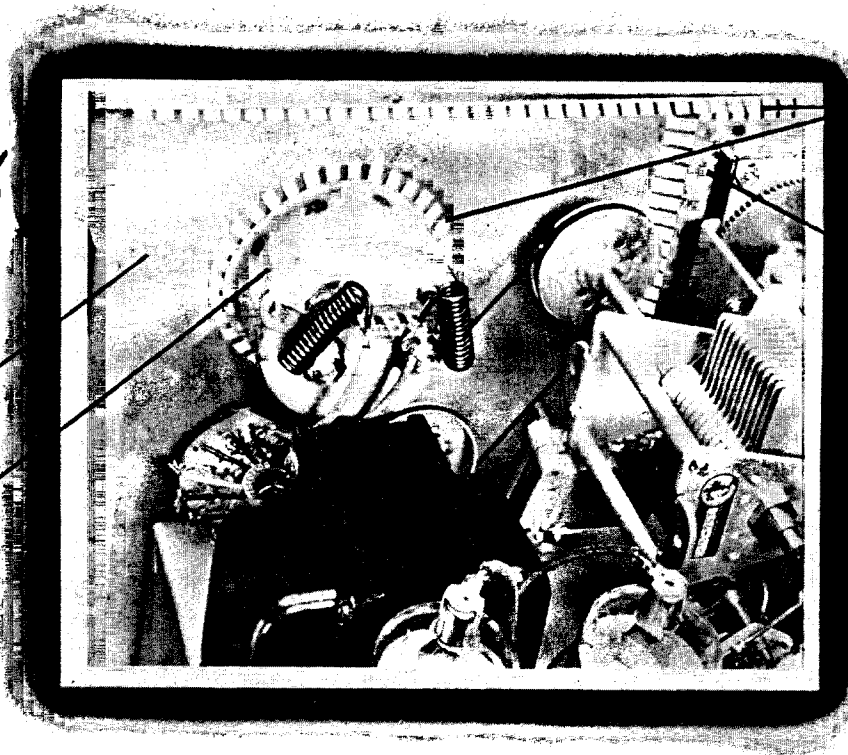

Silver Plated, Phosphor
Bronze Bonding Fingers

Copper Plated Dial
Window Shield

Filters, located at: Power-
line, Keying Jack, Micro-
Phone Connector, Antenna
Relay Connector, and VFO
Power Socket.

Figure 3. TVI Suppression Features

TVI SUPPRESSION MEASURES—The Viking II is completely enclosed in a steel cabinet, heavily copper plated. Top and bottom are perforated to permit free circulation of cooling air. The lid, easily removed as shown in **Figure 4**, is bonded with silver plated, phosphor bronze contact fingers. Special shields for meter, dial window, and VFO power receptacle maintain effective TV shielding. Filters, consisting of low inductance chokes and ceramic disc capacitors, are located at the: power line, keying jack, microphone connector and VFO power socket. The antenna relay connector, energized by the "plate" switch

is likewise filtered. Additional filters are used to suppress spurious output frequencies at their source. Coaxial output and VFO input connectors keep shielding intact.

SCREEN VOLTAGE REGULATOR—A triode connected 6AQ5 regulator protects the 6146 amplifiers by maintaining normal screen voltage under key up conditions or in the event of an excitation failure. This circuit affords the Viking II the advantages of a series screen dropping resistor with resultant good output under conditions of low line voltage, yet with perfect safety.

ANTENNAS AND LOADING—The pi-section tank circuit of the Viking II can be loaded into random length single wire antennas, permitting operation on several bands without any change in the antenna system.

In areas with television service, it may prove necessary to use a low pass filter, to avoid television interference. If so, then the load must be a "flat" coaxial line, the impedance of which is equal to the characteristic impedance of the filter. The pi-network tank circuit is capable of perfectly matching the impedance of any commonly used low pass filter at any amateur frequency throughout the range 1.8 - 29.7 mcs. The JOHNSON 250-20 Low Pass Filter is available as a separate accessory and when used can provide an additional 75 db harmonic attenuation.

For novice operation, the final amplifier input may be reduced to 75 watts by means of the front panel "coupling" controls. Adjustment of the screen voltage or modification of the transmitter is not required.

ASSEMBLY—The Viking II was designed as a kit and can be assembled by a novice as well as the experienced amateur. Instructions include photographs of each stage of assembly, schematic diagram, wiring harness diagram, tube socket connections, codes used to mark components, test methods and data. No outside source of information is required. Thus the appearance and performance of the completed Viking II will be equal to that of our laboratory models.

The chassis, panel, and cabinet are formed and punched at the factory. No drilling or other metal work is required. Complete to the last detail, the parts kit includes brackets, dial, cord, solder, terminals, washers, spacers, wire, grommets and all other small hardware items. A wiring harness containing all ac and dc power leads is furnished, reducing the possibility of incorrect wiring and giving the appearance of a factory assembled unit.

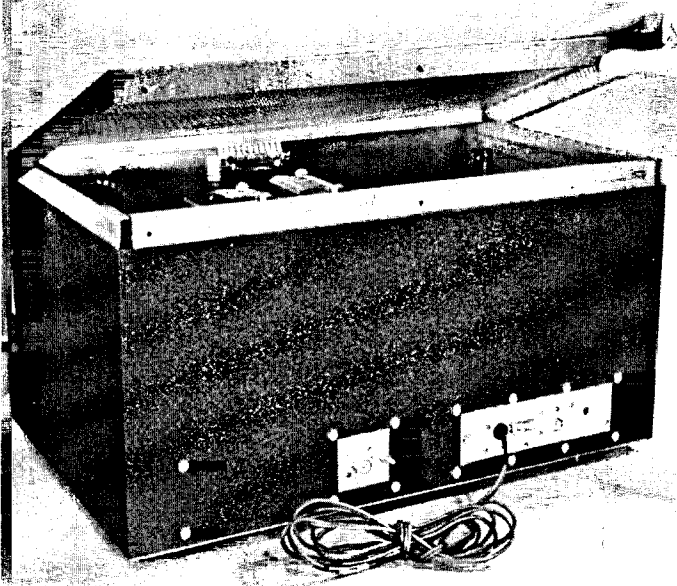

Figure 4. Lid Removal, Showing Phosphor Bronze Bonding Fingers

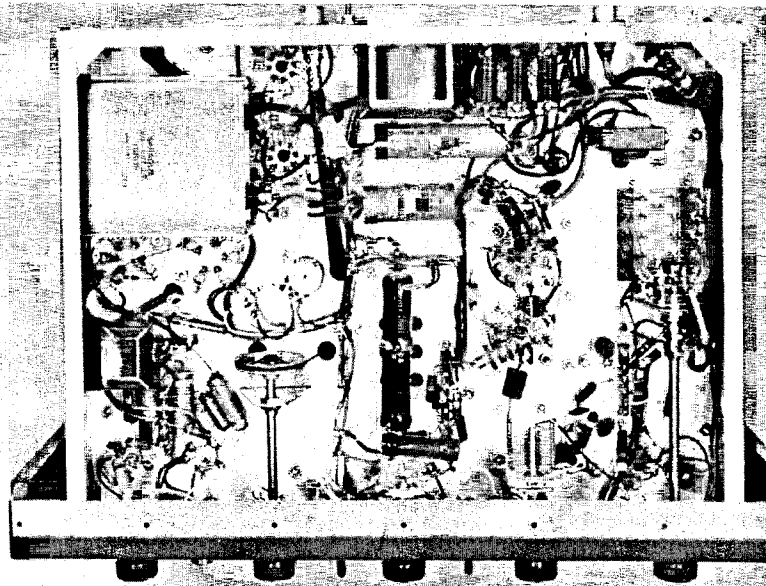

Figure 5. Chassis, Bottom View

APPEARANCE—Microphone input connector, keying jack and all controls are conveniently located on the front panel. The antenna relay connector, VFO input, and power receptacles are located on the rear of the chassis. The transmitter is housed in dark maroon wrinkle finished desk cabinet, 10⁷/₈" x 13-3/16" x 20", weight when assembled is approximately 65 pounds. Front panel has a matching gray and maroon two tone finish. The skirted knobs furnished with the kit were designed especially for the Viking and accent its finished, commercial appearance.

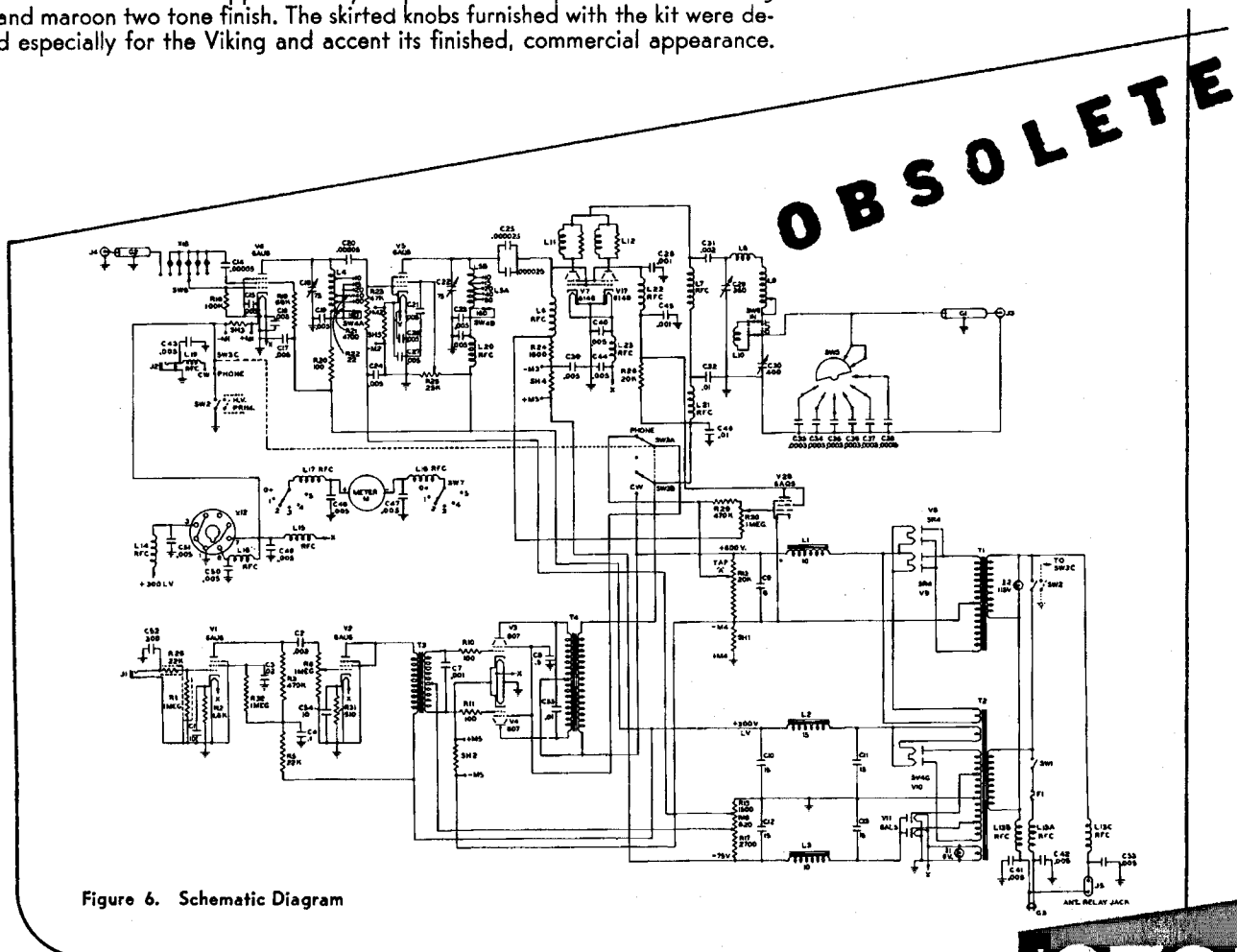

Figure 6. Schematic Diagram

OBSOLETE

The Viking II is available wired and tested by factory-authorized wiremen. The cost is nominal, see your JOHNSON distributor.

Amateur Net Complete with tubes, less crystals, key and mike
In Kit Form

\$279⁵⁰

JOHNSON *Viking* VFO KIT

Ideal for Use with most Transmitters

**COMPANION UNIT FOR THE
VIKING II . . .**



The JOHNSON VFO is truly a precision instrument, engineered to the same high standards of appearance and performance which characterize the Viking II transmitter.

OUTPUT—VFO output is more than sufficient to drive the Viking or similar transmitters to full output on all amateur bands from 10 to 160 meters. Two entirely separate oscillator tanks are used, one delivering 8 to 10 volts on the 7.0 to 7.425 MC range, the other delivering 5.5 to 7.5 volts on the 1.75 to 2.0 MC range. Thus the maximum frequency multiplication required is 4X to cover the 10 meter band. The transmitter oscillator stage is utilized as an isolating RF amplifier or frequency doubler when driven by the VFO.

TUBE COMPLEMENT—The tube complement consists of a 6AU6 electron coupled oscillator and an OA2 regulator. Excellent isolation between oscillator and output circuits, and nearly perfect screen grid voltage regulation account for the clean keying and add to the overall stability of the VFO.

KEYS IN THREE DIFFERENT WAYS

1. Keying VFO alone.
2. Keying the transmitter alone.
3. Keying both the VFO and transmitter simultaneously. The latter is highly satisfactory and provides perfect "break-in" operating conditions on all bands.

POWER SUPPLY REQUIREMENTS—All voltage requirements are amply supplied from the VFO supply socket on the Viking Transmitter. No other power supply required, all necessary cables and plugs furnished. If the JOHNSON VFO is used without the Viking II, power supply requirements are 250 to 300v, unregulated at 15 ma and 6.3 v at .3 amp., ac or dc, usually available from existing transmitter power supplies.

ASSEMBLY—Assembly and calibration are simple. A 5" dial, calibrated for transmitter output on all amateur bands from 10 to 160 meters is furnished. Instructions contain simple methods of alignment, insuring that output frequency agrees with dial calibration. A special tank assembly board is provided with the kit, to insure correct component mounting and wiring. The instruction manual contains complete details and schematics for operation with transmitters other than the Viking II.

Factors contributing to the excellent stability of the Viking VFO are:

A special JOHNSON ceramic, soldered, tuning capacitor

Ceramic insulated air dielectric trimmers

Temperature compensated ceramic padders

Ceramic coil form

Rigid construction

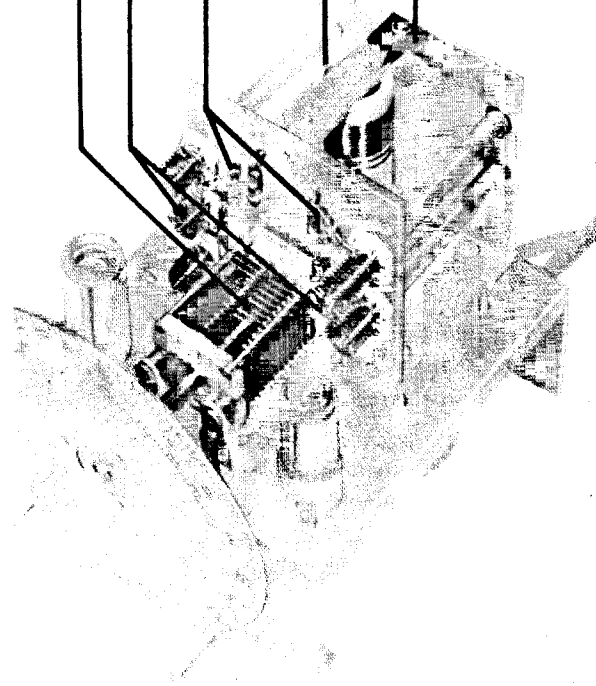

FOR INCREASED

Harmonic Attenuation!

JOHNSON 250-20 LOW PASS FILTER

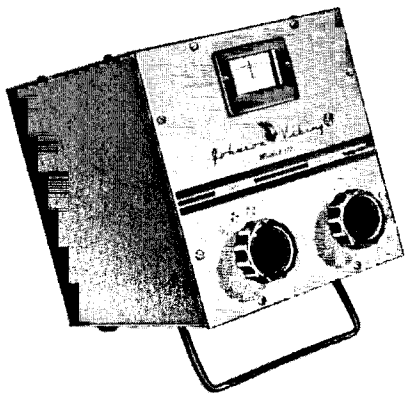
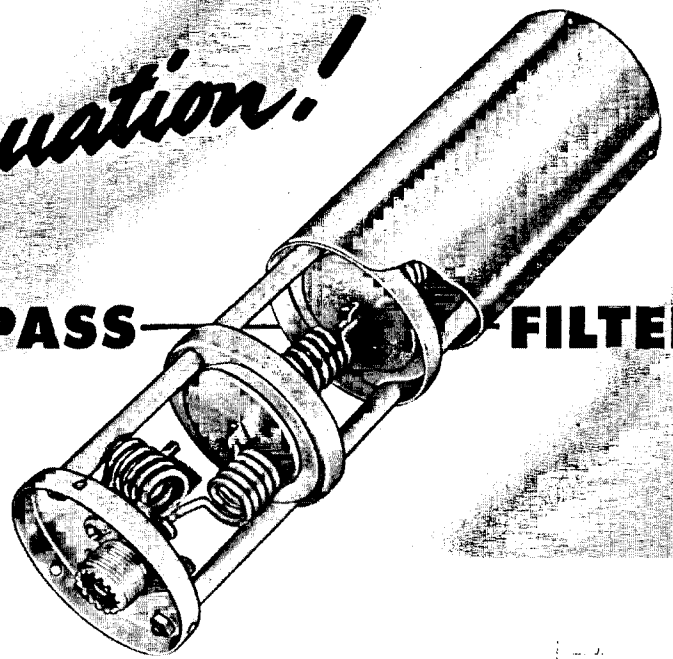

BUILT-IN TILT BRACKET

Features:

1. **Accurate Frequency Calibration**
(All bands—160 thru 10 meters)
2. **5" Calibrated Dial with 6:1 Reduction**
3. **High Stability—Clean Keying**
4. **Simple Assembly**
5. **Perfect "Break-In" on all bands**

JOHNSON VIKING VFO KIT, complete, less tubes, in dark maroon finished cabinet.

Size 7"x6⁷/₈"x6 9/16"
Amateur Net

\$42⁷⁵

The JOHNSON 250-20 low pass filter consists of four individually shielded sections capable of handling more than 1000 watts amplitude modulated RF. Cut-off frequency is 45 mcs. with "M" derived end sections adjusted to provide maximum attenuation at 57 mcs., the center of TV channel 2. Attenuation of harmonic and spurious frequencies above 54 mcs. is 75 DB or more. Insertion loss is less than .25 DB. The 250-20 is immediately adaptable to any transmitter with a 52 ohm output. When properly terminated, the maximum voltage developed across capacitors is nominal, even at 1 KW power. In designing the JOHNSON Low Pass Filter, consideration was given the fact that the RF voltage could rise to extremely high values if the load were accidentally removed. Therefore, to enable the user to service the unit, the interior of the filter case has been made readily accessible and fixed capacitors have replaceable Teflon insulation.

With the many amateur transmitters, using low impedance links to couple to balanced antenna systems, some type of antenna coupler is required and use of a fixed impedance filter does not unduly complicate antenna loading. The antenna coupling shown in diagram is simple and quite flexible.

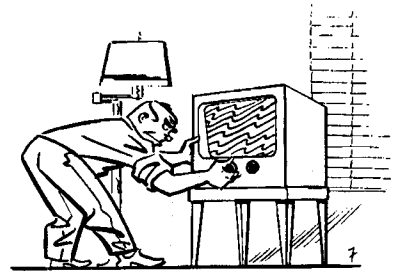

Owners of transmitters such as the JOHNSON Viking will have no difficulty feeding a 52 ohm line since the pi-network amplifier can match this impedance throughout its tuning range. The pi-network is also capable of tuning out considerable reactance.

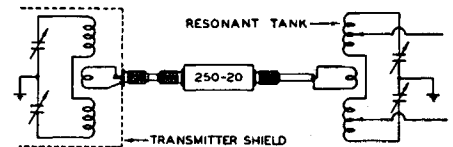

Standard SO-239 coaxial connectors are used for input and output terminals. Completely assembled, pre-tuned and equipped with convenient mounting hardware.

250-20 Amateur Net

\$16⁵⁰

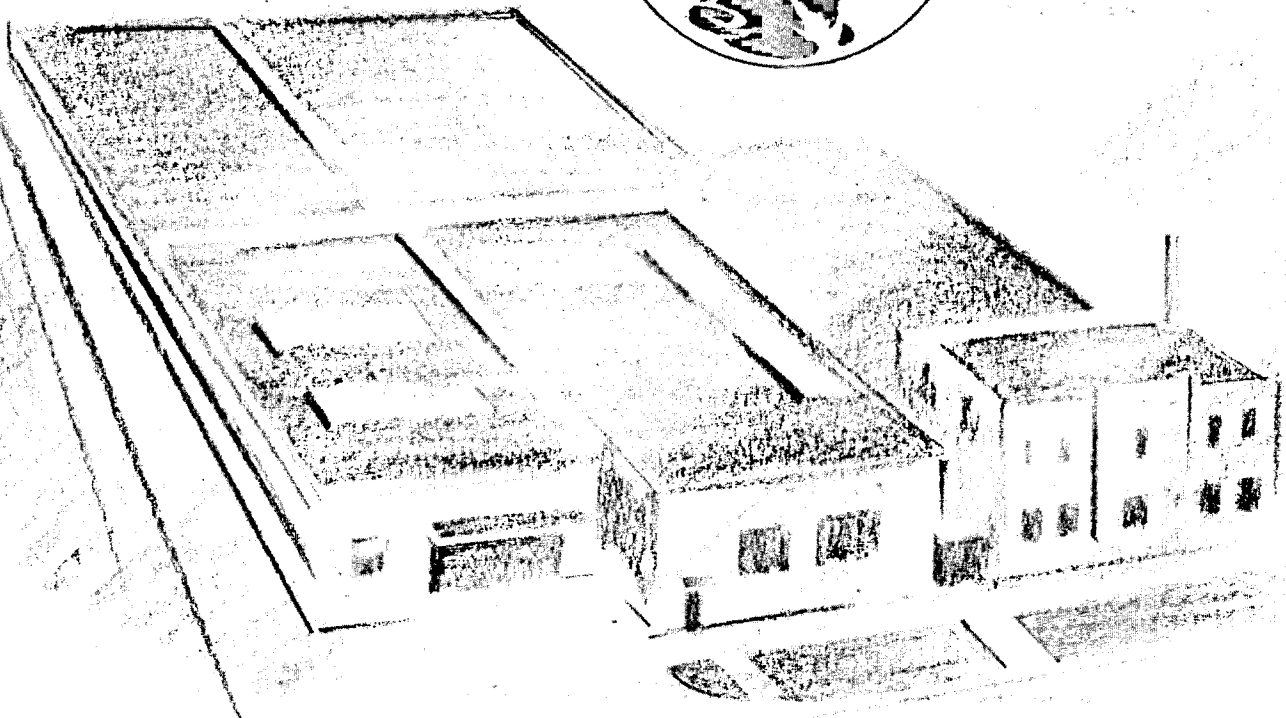

E . F . J O H N S O N C O M P A N Y

WASECA, MINNESOTA

Viking II Transmitter Installation and Operation

The successful operation of any radio equipment is largely dependent on the operator's understanding of the equipment. This operating instruction manual is set up in several parts, each with the purpose of making the operator more familiar with the Viking II. The main parts are:

	Special Setting Up Instructions for Factory Wired Transmitters	
A	Theory of Operation	Page 3
B	Initial Installation	Page 7
	Novice Operation	Page 9
C	Viking II Tuning Details	Page 9
D	Pi Network Tuning and Harmonic Suppression	Page 14
E	Trouble Shooting	Page 20
F	Photographs, Charts, and Schematic Diagrams	Page 25
G	Parts List	At rear of book

WARNING

The voltages encountered in this piece of equipment are high enough to cause fatal injury! Practice safety rules until they are second nature. Always turn off the high voltage before making any adjustment inside the transmitter. Never depend on a bleeder resistor to discharge filter condensers. After the power is turned off, short circuit the high voltage circuit. Never operate the transmitter with any other than the recommended fuse in the primary circuit. The fuse will protect your equipment, in the case of accidental contact with the high voltage, it may save your life. If children have access to the transmitter, always disable the primary circuit by removing the fuse, or the high voltage circuits by removing the rectifiers.

STANDARD WARRANTY

Adopted and Recommended by the
Radio and Television Manufacturers Association

The E. F. Johnson Company warrants each new radio product manufactured by it to be free from defective material and workmanship and agrees to remedy any such defect or to furnish a new part in exchange for any part of any unit of its manufacture which under normal installation, use and service disclosed such defect, provided the unit is delivered by the owner to us or to our authorized radio dealer or wholesaler from whom purchased, intact, for our examination, with all transportation charges prepaid to our factory, within ninety days from the date of sale to original purchaser and provided that such examination disclosed in our judgment that it is thus defective.

This warranty does not extend to any of our radio products which have been subjected to misuse, neglect, accident, incorrect wiring not our own, improper installation, or to use in violation of instructions furnished by us, nor extend to units which have been repaired or altered outside of our factory, nor to cases where the serial number thereof has been removed, defaced or changed, nor to accessories used therewith not of our own manufacture.

Any part of a unit approved for remedy or exchange hereunder will be remedied or exchanged by the authorized radio dealer or wholesaler without charge to the owner.

This warranty is in lieu of all other warranties expressed or implied and no representative or person is authorized to assume for us any other liability in connection with the sale of our radio products.

A THEORY OF OPERATION

1. The Viking II block diagram

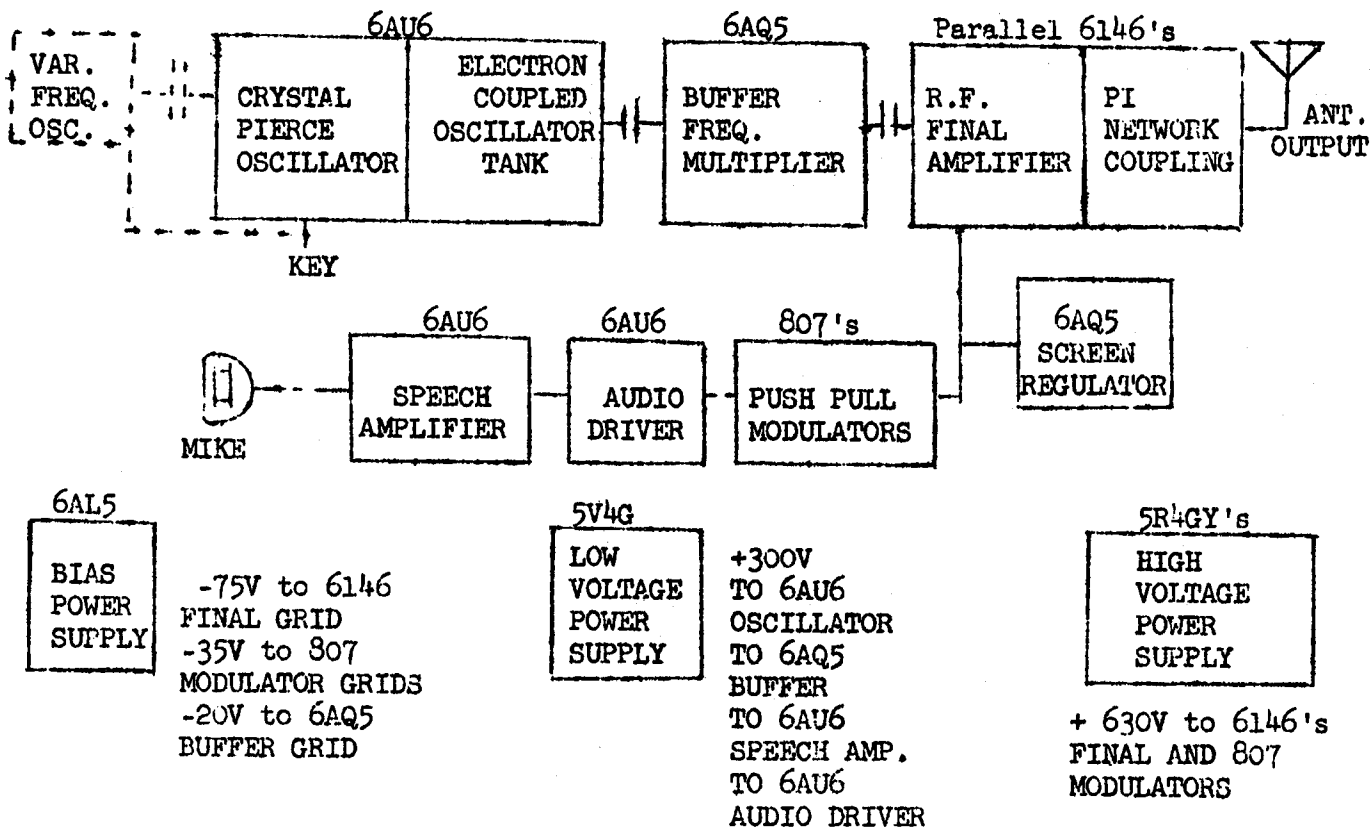

2. The general specifications, frequency coverage, and main features of the Viking are covered in the Brochure at the front of this book.
3. The OSCILLATOR: The "crystal" switch will select any of 10 crystal positions on the crystal board or connect the 6AU6 grid to the VFO receptacle at the left rear of the chassis (the VFO is the 0 position). The Pierce Oscillator part of the 6AU6 will oscillate efficiently with most crystals in the range of 1.75 mc to 7.5 mc. The plate of the 6AU6 is electron coupled to the oscillator which makes this stage a good frequency doubler on the high frequency range of the Viking II. The tuning range of the oscillator tank is that of the indicated wavelength on the 160, 80, and 40 meter positions; is the 40 meter range on the 20 and 15 meter switch position; and 20 meter range on the 10 meter bandswitch setting. The approximate frequency coverage of either the oscillator or buffer stage can be determined from the tuning curves on the sheet following page 10. Oscillator cathode current is indicated on the "osc" position of the meter switch. A drop in oscillator current can be expected when a crystal is switched into the oscillator circuit. The Viking II oscillator stage becomes simply an amplifier or frequency multiplier when a VFO is used. It is necessary to isolate the Viking II 6AU6 oscillator grid with a blocking condenser of 50 mmfd to 150 mmfd in the connection between the Viking II

and the VFO if a DC path exists in the VFO output. (Not required when using the Viking VFO.)

4. The BUFFER: Frequency multiplication takes place in the 6AQ5 buffer stage on the 20, 15, and 10 meter band positions. Straight through operation is used on all lower frequency bands. The buffer stage power output is controlled by the "drive" screen grid potentiometer control. Buffer tuning is best indicated by the 6146 final "grid" current, while the oscillator tank tuning is best indicated by maximum buffer cathode current read in the "bfr" meter switch position. The "grid" current must be held below 8 ma. at all times. 6 ma is adequate to drive the 6146s to full output. Buffer no signal current is limited by a fixed bias of approximately 25 volts applied to the 6AQ5 grid.
5. The R.F. POWER AMPLIFIER: The grid circuit of the final 6146 has a fixed bias of 75 volts with an additional 20 to 30 volts of self bias added by the drive signal. Under no-signal conditions the 6146s are almost completely cut off. The tank of the 6146s is part of a pi network matching-coupling circuit. The main tuning inductor, L9, and geared condenser, C29, tune the range of 80 through 10 meters. The "160 in-out" switch adds an additional auxiliary coil to cover the 160 meter band. Frequency coverage is shown on curve 1 of the sheet following page 10. The screen and plate current of the 6146s is read in the "plt" meter switch position. Note that the final grid current is not included in the "plt" reading. The screen grid voltage of the 6146s is obtained from the high voltage supply through a 20,000 ohm series dropping resistor.
6. The PI NETWORK ANTENNA COUPLING: The complete pi network consists of the main tuning inductor, L9, as the series element; the main tuning condenser, C29, as the input shunt element; and the output shunt capacitance made up of a variable condenser, C30, labeled "fine coupling" and a group of fixed mica condensers, C33 through C38, switched in parallel with C30 by a switch labeled "coupling". This combination provides a continuous output capacity range of 20 to 2050 mmfd. The pi tuning-coupling network is designed to match the 6146s into antenna resistances of nominally 50 to 600 ohms and tune out several hundred ohms of antenna reactance over the frequency range of the Viking II. The range of antenna impedance matching extends roughly from 25 to 2000 ohms at frequencies higher than 7.0 mc. In general high impedance loads will require small output coupling capacities (advanced settings). Reactance cancellation takes place automatically when the "final" control is tuned to the proper plate current dip with the meter switch in the "plt" position. The net tank plate reactance is dependent on the load characteristics and the output coupling capacity but the plate current dip indicates that the 6146 plates are loading into a resonating tank. The plate current dip becomes less and less pronounced until the final 6146s are properly loaded. Advancing the coupling controls beyond the 20 ma dip point usually causes over-coupling resulting in inefficiency and poor harmonic suppression.
7. The MODULATOR: The modulator consists of a pair of 807's operating in class AB2 push-pull, driven by a transformer coupled 6AU6 driver, and a 6AU6 resistance-capacitance coupled speech amplifier. The "audio" gain is a potentiometer control of audio input to the driver stage. When the "cw-phone" switch is in the "cw" position the secondary of the modulation

transformer is shorted and the screens of the 807 tubes are opened. The "phone" position removes the short and applies screen voltage to the 807's from the high voltage bleeder-divider tap. Sections of the high voltage primary "plate" switch and the "cw-phone" switch are inter-connected in the keying circuit so that the keying circuit is opened whenever the "plate" is off and the "cw-phone" switch is in the "phone" position. This eliminates oscillator interference while listening to a station operating on the same frequency as the Viking II. Frequency response provides excellent quality with ordinary crystal communication microphones.

8. The POWER SUPPLIES: The Viking II has three power supplies:
- a. The 6AL5 BIAS SUPPLY furnishes approximately 75 volts bias to the 6146 grid circuit, 35 volts bias to the 807 modulator grids and 25 volts bias to the 6AQ5 buffer-frequency multiplier.
 - b. The 5V4G LOW VOLTAGE SUPPLY furnishes power to all filaments and 290 to 310 volts (loaded) to the RF exciter and 6AU6 audio amplifier stages. The L.V. power transformer is rated at 95 ma. D.C. at the high potential terminals.
 - c. The HIGH VOLTAGE SUPPLY furnishes 620 to 660 volts (loaded) to the 6146 final amplifier and 807 modulators. The parallel 5R4GY tubes and 10 henry choke input filter provide good regulation in the operating range of the Viking II. The B- side of the H.V. supply is above ground potential by the 6146 meter shunt voltage (100 millivolts full scale).
 - d. 6AQ5 SCREEN VOLTAGE REGULATOR: This tube prevents excessive rise of 6146 screen grid voltage with key up on CW or in the event of an excitation failure while operating on phone. The 6AQ5 is used as a triode with its screen grid and plate connected together to the source of 6146 positive screen voltage. The cathode of the 6AQ5 is connected to the center tap of the high voltage transformer (B-). A 470,000 to 500,000 ohm resistor and 1 megohm potentiometer are connected in series between the slider on the voltage divider R13 and the most negative point of the bias supply at the junction of choke L6 and resistor R24. The grid of the 6AQ5 regulator is connected to the movable arm of the 1 meg potentiometer. Thus by adjusting the potentiometer any desired grid voltage can be applied to the regulator.

When operating on CW with key down, the regulator tube has cut-off bias applied and draws no current. When the key is opened there is no longer any 6146 grid current flowing thru resistor R24 and the voltage at the junction of L6 and R24 becomes less negative. This results in the grid bias of the 6AQ5 regulator shifting in a positive direction. This positive shift causes the 6AQ5 to draw current applying a load at the source of 6146 screen grid voltage, holding the voltage down even though the 6146 screen grid current has dropped essentially to zero. Should the excitation to the 6146s fail, while operating on phone, the same change in grid voltage occurs and 6146 screen voltage is again restrained. Modulation of the 6146s doubles their screen voltage on peaks but the 6AQ5 bias is sufficiently high so that it remains cut-off.

9. METERING: The cathode currents of the oscillator, buffer, and modulator may be read on the meter when the meter switch is placed on the indicated position. The 6146 power amplifier combined screen grid and plate currents

are read in the "plt" position, and 6146 grid current is read in the "grid" position. All shunts are cut for 100 mv drop for a full scale meter indication. The "osc" or "grid" currents are read on the lower 0-25 ma scale, the "bfr" current on the upper scale (assuming 50 ma full scale), and the "plt" and "mod" current on the 0-500 ma upper scale.

10. KEYING of the VIKING II is done in the 6AU6 oscillator cathode circuit. The keying circuit is broken by the H.V. switch (off position) on phone operation as previously described under "Modulator", so the RF exciter tuneup must always be done in the "cw" position of the cw-phone switch. As may be expected with any conventional oscillator keying, the quality of the keyed characters may depend slightly on the oscillator tank tuning when "straight through" operation is used. The oscillator tuning control can be adjusted for clean stable keying.

11. VFO EXCITATION: The "O" position of the crystal selector switch connects the VFO receptacle at the rear of the chassis directly to the 6AU6 oscillator grid through approximately one foot of RG59U cable. An isolating condenser of 50 to 150 mmfd is necessary between the VFO and Viking II input unless the VFO has a capacity coupled output (the Johnson VFO may be directly coupled). 6 volts of 40 meter RF at the grid of the Viking II 6AU6 oscillator stage will drive the final to full excitation on 10 meters. The lower frequency bands require less VFO output. The VFO frequency range should be nominally the same as the crystal frequencies which would normally be used. There is a danger of overdriving the 6AU6 with a VFO resulting in grid blocking. Grid blocking actually reduces the effectiveness of the stage to the point where it attenuates the input signal greatly rather than passing or amplifying the input signal or generating the required harmonics.

When the Viking II is fed with a VFO, it is well to remember that the specified voltage is that required at the Viking II 6AU6 grid and that the VFO transmission line must be loaded in a manner to provide the required voltage at the grid of the 6AU6. An example of this problem is a four foot length of RG59U. It will appear as approximately 85 mmfd of shunting capacity at the VFO output and should be treated as such at frequencies below 10 mc unless excessive VFO output is available and the attenuation of the transmission line is desired.

The VFO must be sufficiently well shielded so that feedback does not exist between the transmitter and the VFO. Monitoring a VFO driven transmitter should be done more carefully than with crystal operation. Keep the VFO and transmitter decoupled from the monitoring receiver to avoid overloading the receiver. Receiver blocking or local oscillator shift due to overloading often causes an unreliable indication of transmitter keying or frequency.

12. The VIKING II as an EXCITER for a LARGER TRANSMITTER:
 - a. When the Viking II is used as an RF exciter only, tuning and loading procedure will be essentially the same as used with normal transmitter operation. The output of the Viking can be link coupled to the grid stage of the power amplifier. Enough power should be required at the power amplifier grid circuit to load the Viking to at least 30 watts. Shunt dissipating resistors can be added if the grid requirement is too small to load the Viking II sufficiently.

- b. Conversion of the Viking II Modulator to serve as an audio driver is shown on the previous sheet. Figure A suggests how a switch or transfer terminal board may be used to connect the Viking II modulator to drive the grids of a larger modulator directly and allow normal Viking II operation upon switching or moving the transfer jumpers to the alternate position shown. Figure B shows the connections for feeding the larger modulator grids through a 500 ohm line and audio driver transformer. A hole may be punched in the rear of the Viking cabinet to bring out the audio leads conveniently either directly or through an appropriate connector. Lead filter components, L1 and C1 should be placed inside the transmitter as close as possible to the point where the leads leave the cabinet. These filters are for harmonic suppression.
- c. Connection of the Viking II as an audio driver in a permanent installation suggests itself in Figures A and B. The switches are shown in the driver exciter position; permanent connections can be made ignoring the alternate normal Viking II operating position. The secondary winding of Figure B may be isolated from B+ and grounded which will eliminate the need of the 0.1 mfd D.C. isolating condenser.

13. a. ANTENNA RELAY OPERATION

The twin ceramic terminals on the rear of the chassis provide 115V AC for operation of an antenna relay. The terminals are energized only when switch SW2 (high voltage switch) is "on". The antenna relay coil or other load connected at this point must be insulated from ground. Fuse F1 protects the circuit from accidental overload.

B Initial Set-Up Instructions

1. NOTICE! The regulations of the Federal Communications Commission require a suitable license for operation of this equipment. Refer to publications of the Federal Communications Commission or the American Radio Relay League for the latest rules governing station and operator licensing.
2. Be sure to return the enclosed warranty registration card. This will register your transmitter at the factory. If it becomes necessary to write to the factory regarding your transmitter, refer to it by serial number.
3. Remove loose packing material and the packages of parts inside of the cabinet. Inspect the transmitter for any indication of damage. Report any damage to the transportation company immediately.
4. The wired Viking II will arrive with shipping supports consisting of wood blocks and a brace for the transformers.
 - a. The transformer blocks and cross support piece should be removed.
5. Attach knobs to the shafts. The setscrew may be anchored securely in place (after the knob has been properly positioned) by first tightening down, loosening slightly and retightening. The knob-dials should be put on and positioned as follows:

- a. CRYSTAL - a 10-0 dial. The 0 located on the maximum counterclockwise position.
 - b. OSCILLATOR - 100-0 dial. The 0 located on the maximum capacity (low frequency) position.
 - c. BAND - the 160 80 40 20 15 10 dial. The 160 located on the maximum counter clockwise switch position.
 - d. BUFFER - a 100-0 dial. The 0 located on the maximum capacity (low frequency) position. The buffer condenser can be seen through the perforated bottom.
 - e. DRIVE - a 10-0 dial. The 0 located on the maximum counter clockwise potentiometer position.
 - f. CW-PHONE - a single marker dial. The marker located on CW with the switch in the counter clockwise position.
 - g. FINAL - the large spinner knob. No special positioning is required.
 - h. 160 - a single marker dial. The marker located on OUT with the switch in the counter clockwise position.
 - i. COUPLING - the 7-1 dial. The 1 located on the maximum counterclockwise switch position. (Maximum capacity position)
 - j. FINE COUPLING - a 100-0 dial. The 0 located on the maximum capacity position of the variable condenser.
 - k. AUDIO - a 10-0 dial. The 0 located on the maximum counterclockwise potentiometer position.
 - l. METER - the MOD PLT GRID BFR OSC OFF dial. The OFF position located on the maximum counterclockwise switch position.
6. Insert tubes as follows (the socket locations can be determined from the designations by referring to Figure 1 at the rear of this book):
- a. The 6AQ5 buffer in X5 with a 2 1/4" shield.
 - b. A 6AU6 oscillator in X6 with a 1 3/4" shield.
 - c. A 6AU6 speech amplifier in X1 with a 1 3/4" shield.
 - d. A 6AU6 audio driver in X2 with a 1 3/4" shield.
 - e. The 6AL5 bias rectifier in X11, no shield.
 - f. The 5V4G L.V. rectifier in X10.
 - g. Two 5R4GY H.V. rectifiers in X8 and X9.
 - h. Two 807 modulators in X3 and X4, connect plate caps.
 - i. The 6146s in X7 and X17 attach plate caps.

- j. The 6AQ5 screen voltage regulator into X28.
- k. Turn the shaft of the 6AQ5 bias control R30 to its full counterclockwise position.

The Viking II should now be ready for its initial operation but do not attempt to turn it on until the Tuneup section has been studied.

NOVICE OPERATION

Current FCC regulations require that operators with Novice Class Amateur Operator's Licenses limit their final amplifier input to 75 watts. This may be accomplished with good efficiency by reducing output coupling.

In the "plt" position of the meter switch, the meter indicates 6146 cathode current, the sum of plate and screen grid currents. With 6146 grid current at 6 ma. and the amplifier resonant and drawing 140 ma. cathode current, the screen current will be 30 ma. and the net plate current will be 110 ma. This is slightly less than 75 watts input with 660 volts plate voltage. Amplifier output can exceed 55 watts under these conditions.

C VIKING II TUNING DETAILS

1. TYPICAL TUNING: 40 METER tuneup procedure will serve to acquaint the operator with the usual steps involved. Deviations of procedure for other bands will follow.
 - a. Connect a good ground wire or counterpoise to the ground terminal at the rear of the chassis. If there is some question of ground effectiveness read the section "How to Obtain a Good Ground" under the Pi Network tuning and Harmonic Suppression topic on page 15. Connect an antenna or dummy load (a 100 watt light bulb may be used with appropriate leads) to the output receptacle at the rear middle of the chassis.
 - b. Plug in a 7.00 to 7.30 mc crystal in position 1 of the crystal selector socket. 3.5 to 3.65 mc crystals are usually very satisfactory, 1.750 to 1.825 mc crystals may be used but with caution as it is possible to obtain output at 5.250 to 5.475 mc.
 - c. Set the "crystal" dial on "0".
 - d. "Band" on "40".
 - e. "Drive" on "0".
 - f. "Final" (large spinner knob) on "0" (Full tank in).
 - g. "CW-phone" on "cw".
 - h. "Plt" (High voltage) bat handle switch off (down).
 - i. "Coupling" on "1".

- j. "Fine Coupling" on "0".
- k. "160" switch on "out".
- l. Approximate settings of the oscillator and buffer may be obtained from tuning curves on the sheet following page 10.
- m. Throw "fil" switch SW1 on (up). This applies all voltages except plate and screen voltages for the 6146 final and 807 modulators.
- n. Turn "crystal" switch to position 1. The "osc" current should drop perceptibly.
- o. Turn "meter" to "bfr" and advance "drive" to about position 3 in the clockwise direction.
- p. Tune "oscillator" slowly for a rise in buffer current. Adjust tuning for maximum buffer current. In some cases a slight dip of buffer current may occur between two maximum current points. This is true with very active crystals or a strong 6AU6 oscillator tube. Correct tuning, when this occurs, is usually on the dip between the maximum points.
- q. Turn meter to "grid" and note 6146 grid current. If it should be over 8 ma, reduce it at once by turning "drive" counterclockwise. Usually there would be no grid current at this point but the buffer tuning could happen to be nearly correct.
- r. Tune "buffer" for maximum grid current keeping the grid reading below 8 ma by means of the "drive" control. After "buffer" has been properly adjusted, turn "drive" to its 0 position.
- s. Turn meter to "plt" position and "plate" on. Turn "drive" clockwise until plate current rises to 100 ma.
- t. Tune "final" toward 100 until plate current dips sharply. Be certain that the final is tuned to the first dip in plate current thus assuring that the amplifier is tuned to the fundamental and not to a harmonic.
- u. Turn meter to "grid", and touch up buffer tuning for maximum grid current. Advance "drive" until 6 ma of grid current is obtained. Turn meter to "plt".
- v. Proceed to load the antenna or dummy load by advancing the coupling control toward higher numbers, retuning the "final" for a dip after each adjustment of the coupling control. Continue this procedure, adjusting coupling control and retuning final, until a meter reading of approximately 200 ma. is obtained under resonant conditions (final dipped).
- w. A minimum coupling capacity equivalent to that of position "6" of "coupling" should be maintained in any case on 40 meters. The antenna is usually out of the range of the Viking II if less than a total of 150 mmfd of output capacity is required on 40 meters. If "coupling" is turned to 7, "fine coupling" should be advanced no further than 60 on 40 meters in the following step, x.

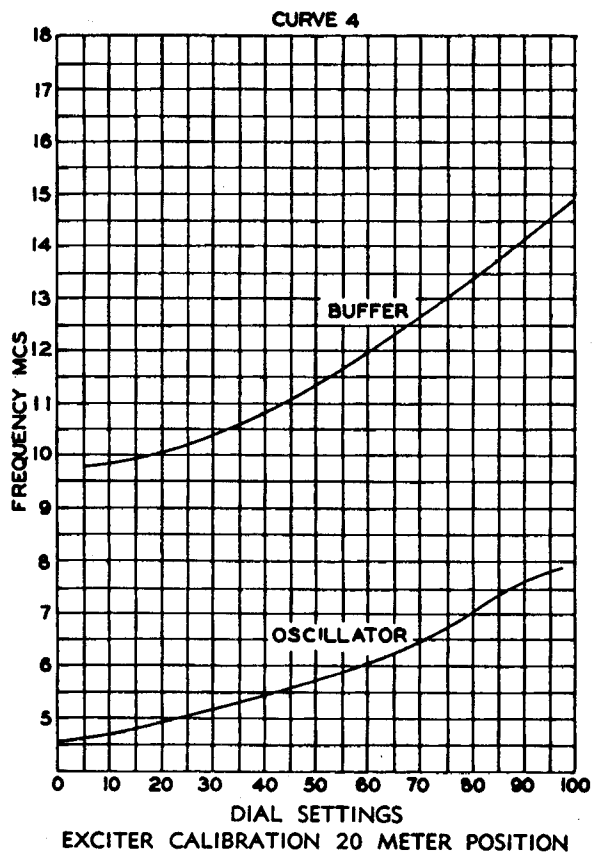
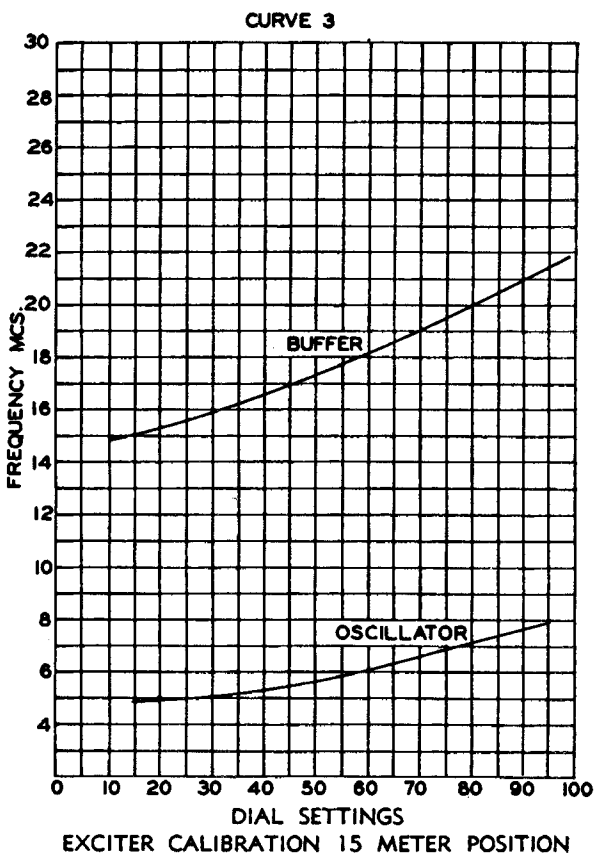
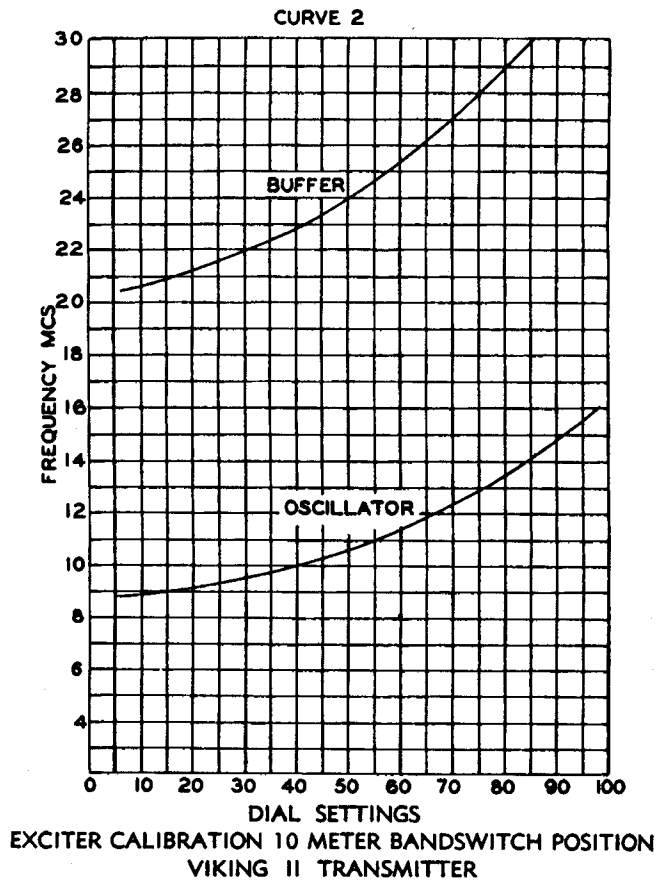
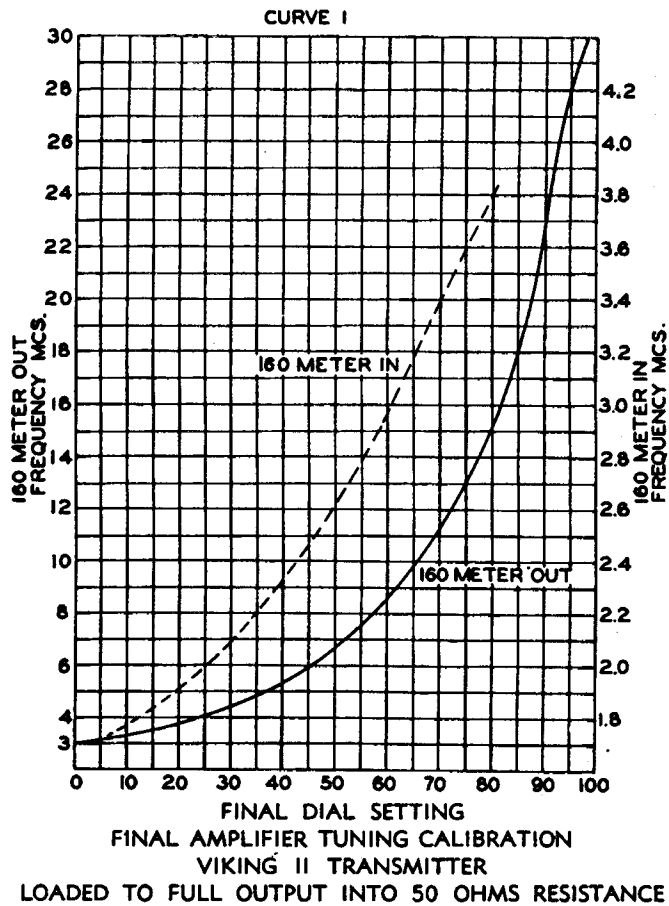

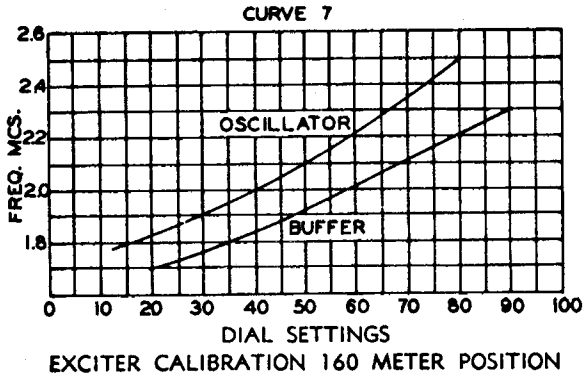
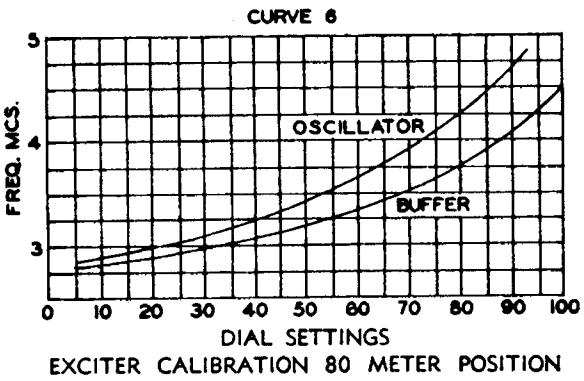
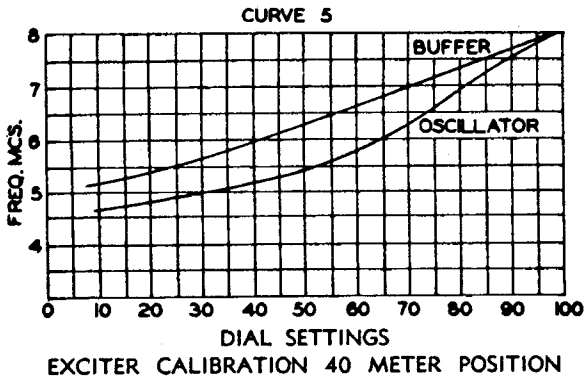

TABULATED DATA
Typical conditions, amplifier fully loaded into 50 ohms resistance

Curve No. 1

Freq.	Final Tuning Setting	Coarse Coupling	Fine Coupling	Remarks
30 MC	98.5	7	55	160 Meter Out
28	95	7	55	"
21	88	7	48	"
14	77	6	45	"
7	51.5	4	98	"
3.839	20	2	74	"
3.610	15	2	70	"
3.610	79	7	100	160 Meter In*
1.994	23	4	38	"
1.805	11	3	50	"

*Not fully loaded

Curve No. 2

MO or XTAL Freq. MC	Oscillator Setting	Buffer Setting	Buffer Output Freq.	P. A. Grid M. A. MC	Minimum M. O. Voltage Required For P. A. Grid M. A.
15 MO	92	86	30	6 ma.	0.8 V
14	85	75	28		0.95
					0.95
					1.95
					6.4
					1.4
12.8	77	62	25.6		
10.8	51	20	21.2		
9.34	23				
9.07	17				
7.00 XTAL	85	75	28		
7.00 MO	85	75	28		5.6

Curve No. 3

Freq. MC	Oscillator Setting	Buffer Setting	Buffer Output Freq.	P. A. Grid M. A. MC	Minimum M. O. Voltage Required For P. A. Grid M. A.
7.6 MC	88	100	22.8	6 ma.	XTAL
7.0	79	85	21.0		2.2 V
7.0	79	85	21.0		7.0
6.0	58	58	18.0		XTAL
5.0	25	25	15.0		XTAL

Curve No. 4

Freq. MC	Oscillator Setting	Buffer Setting	Buffer Output Freq.	P. A. Grid M. A. MC	Minimum M. O. Voltage Required For P. A. Grid M. A.
7.3	83	93	14.6	6 ma.	1.4 V
7.0	80	86	14.0		1.1 V
7.0	80	86	14.0		XTAL
6.0	60	61	12.0		1.4 V
5.0	26	16	10.0		XTAL
4.95	23	98	14.85		XTAL
4.80	16	4	9.60		XTAL

Curve No. 5

Freq. MC	Oscillator Setting	Buffer Setting	Buffer Output Freq.	P. A. Grid M. A. MC	Minimum M. O. Voltage Required For P. A. Grid M. A.
8.0	100	98	8	6 ma.	1.0 V
7.6	90	85	7.6		.92 V
6.0	67	42	6.0		.45 V
5.0	34	0	5.0		XTAL

NOTE: The use of 80 meter crystals and doubling in the oscillator stage is satisfactory for 40 meter operation.

Curve No. 6

Freq. MC	Oscillator Setting	Buffer Setting	Buffer Output Freq.	P. A. Grid M. A. MC	Minimum M. O. Voltage Required For P. A. Grid M. A.
4.53	85	100	4.53	6 ma.	XTAL
4.00	72	87	4.00		XTAL
3.5	52	66	3.50		2 V
3.0	22	34	3.00		.25 V
2.8	5	11	2.80		.7 V

Curve No. 7

Freq. MC	Oscillator Setting	Buffer Setting	Buffer Output Freq.	P. A. Grid M. A. MC	Minimum M. O. Voltage Required For P. A. Grid M. A.
2.4	73	97	2.4	6 ma.	.3 V
2.3	65	87	2.3		.3 V
2.0	38	57	2.0		.35 V
1.9	30	50	1.9		.35 V
1.8	15	34	1.8		.45 V

- x. Turn "fine coupling" toward higher numbers until the "plt" reading rises to about 250. Dip the plate current with "final" adjustment again and follow this procedure until a desired plate current between 250 and 300 ma has been reached. If the desired coupling cannot be obtained with the "coupling" setting of step w, turn the "fine coupling" to 0 and advance "coupling" another step (normally not beyond 6 on 40 meters) and readjust "final" and "fine coupling". "Plate" current on CW should not exceed 300 ma.

The above steps completes the normal tuning procedure. However, when initially setting up the equipment the 6AQ5 clamper tube must be adjusted and once adjusted will remain stable and need not be changed over long periods of time.

2. CLAMPER TUBE ADJUSTMENT

- a. Turn the shaft of the 6AQ5 bias control R30 to its full counter-clockwise position.
- b. Loosen the tap on the voltage divider R13 completely and adjust its position to between 1 3/4 and 2 inches from the rear end terminal (if not already adjusted).
- c. Switch to the phone position. Decrease the amplifier loading to 230 ma "plt" current by means of the coupling controls, bringing the amplifier back to resonance (minimum "plt" current) by means of the main tuning dial ("final") after each coupling adjustment. Reset the drive control for 6 ma grid current when the plate current is exactly 230 ma.
- d. Now note the modulator cathode current with the audio gain control in the counterclockwise position. This current should be between 60 and 80 ma. If the modulator current is less than 60 ma., loosen the tap on R13 (REMOVE ALL VOLTAGES FIRST) and move it toward the rear about 1/8" at a time. If the current is more than 80 ma., move the tap toward the panel.
- e. After having established the modulator current between 60 and 80 ma., with grid current at 6 ma., "Plate" current at 230 ma., switch the high voltage off, switch to the CW position. Turn R30 to its full clockwise position, tune "crystal" switch to "0", turn on the high voltage.
- f. BE CAREFUL AT THIS POINT SINCE FULL VOLTAGE IS APPLIED! AN INSULATED SCREWDRIVER IS RECOMMENDED FOR THIS ADJUSTMENT. Switch the meter to read plate current. Turn R30 in a counter-clockwise direction until current rises perceptibly, adjust to 10 ma., the first mark on the meter scale above zero.
- g. Switch back to the phone position. Amplifier "plate" current should be less than 50 ma. Turn off high voltage, set the crystal switch to the desired crystal position.
- h. This completes adjustment of the clamper tube. This adjustment should remain stable over long periods and need not be changed even though the line voltage varies widely.

C.W. OPERATION may now be carried on by simply plugging in the key. If

keying is slightly erratic, retune the "oscillator" slightly until keying is crisp and clean. For CW operation the final (power) amplifier may be loaded to any "plt" current up to 300 ma. For phone operation "Plt" current should be limited to 230 ma.

3. 160 METER TUNING: Proceed as on 40 meters with the following exceptions:
 - a. "160" switch on "in" (do not turn unless "plate" is off).
 - b. Use 1.8 to 2.0 mc crystals in crystal socket position corresponding to "crystal" setting.
 - c. Final tuning will be very broad. With high impedance antennas the "final" may be against the stop on the "0" end when resonance is indicated. In this case leave the main dial at "0" and advance "coupling" toward higher numbers. Do not advance "coupling" beyond 6 and "fine coupling" beyond 50 in any case. A further reduction in output capacity indicates that the antenna terminal impedance is out of the range of the transmitter. Although you may feel the tank is out of resonance, the circuit is so broad that good resonance conditions still exist and its efficiency is not impaired.

4. 80 METER TUNING:
 - a. "160" switch on "out" ("plate" off while changing).
 - b. Use 1.75 to 2.0 mc or 3.5 to 4.0 mc crystals.
 - c. Do not attempt to use "coupling" beyond step 6 or "fine coupling" beyond 50 in cases of high antenna impedance as in the case of 160 meter tuning.

5. 20 METER TUNING:
 - a. 7.0 to 7.2 mc, or 4.666 to 4.8 mc (14.0 to 14.4 mc harmonic) crystals may be used. 3.5 to 3.6 mc and 1.750 to 1.8 mc crystals may be used but caution must be exercised as it is possible to obtain output at 10.5 to 12 mc. Reduced drive will be noted with the latter crystals.
 - b. In nearly all cases of 20 meter operation the "coupling" switch can be set at 7 and loading accomplished by "fine coupling" alone. The "fine coupling" should never be advanced beyond a setting of 70 for 20 meters with "coupling" at 7.

6. 15 METER TUNING:
 - a. 7.0 to 7.15 mc crystals are preferred. 3.5 to 3.575 mc crystals may be used with limited 6146 grid drive.
 - b. Set "coupling" at 7. The "fine coupling" control should never be advanced beyond 80 in any case on 15 meters.

7. 10 and 11 METER TUNING:
 - a. 7.0 to 7.425 mc or 6.74 to 6.8075 mc crystals are recommended. 14.0 to 14.85 mc or 13.48 to 13.615 mc crystals (usually harmonic cut but oscillate

at 1/3 of their indicated frequency) may be used with somewhat lower final drive. 3.5 to 3.7125 mc crystals will drive the final (5 to 8 ma grid current) but caution is necessary as 24.5 to 25.987 mc output is possible.

- b. Set "coupling" at 7. Do not advance "fine coupling" beyond 90.
- c. Touch up tuning. Final will have setting near 100.

7A. If difficulty is experienced in obtaining a "grid" indication on the 10, 11, and 15 meter bands due to weak crystal activity or double peaks on buffer current tuning, the "plt" current may be used to determine the initial settings as follows (this procedure is rarely needed as the Viking is normally very easy to tune on these bands):

- a. Tune oscillator stage as usual for maximum buffer current.
- b. Turn "drive" to 0.
- c. Turn "meter" to "plt".
- d. Turn "plate" switch on.
- e. Turn "driver" up to about 4 while watching the plate current.
- f. Tune buffer and oscillator for maximum plate current, limiting the "plt" reading to 100 ma by means of the "drive" control during tuning. Do not leave "plate" on while final is untuned for periods of more than 30 seconds.
- g. Turn "plate" switch off and check "grid" current. Log settings if difficulty is anticipated in retuning under the same conditions.

8. PHONE OPERATION:

- a. Tune up Viking II in "cw" position.
- b. Turn the "plate" switch off.
- c. Turn "phone-cw" switch to "phone" turn plate switch on, adjust for 6 ma grid current, 230 ma. "plt" current (Plate current should not exceed 230 ma for phone operation). Turn plate switch off.
- d. Turn "audio" to "0" and connect a high impedance crystal or high output dynamic microphone to the connector marked "mic".
- e. Turn meter switch to "mod". Turn plate switch on. The modulator no signal current should be between 60 to 80 ma.
- f. Talking into the microphone, advance audio until the "mod" current rises to 120 to 130 ma on audio peaks. 120 to 130 ma of modulator current corresponds to 100% modulation. A small downward reading of "plt" is normal during modulation.
- g. Check 6AQ5 clamper tube adjustment by switching crystal out of the oscillator circuit momentarily. "Plate" current should drop to less than 50 ma.

If plt current is above 50 ma, refer to clamper tube adjustment section C, 2, (page 11).

9. VFO OPERATION:

- a. Review the discussion of VFO excitation under "Theory of Operation".
- b. Plug the VFO output cable into the VFO coax receptacle at the left rear of the Viking II chassis. A 50 to 150 mmfd isolating condenser may be needed in the center conductor of the connecting cable to prevent the 6AU6 grid from being short circuited if the VFO output has a continuous D.C. path to ground. (The isolating capacity is unnecessary when the Viking VFO is used.)
- c. Use the VFO in the same manner as crystals are used for output on the band selected. Only two volts of 160 meter signal at the Viking II 6AU6 grid will drive the transmitter to full output on 160 to 80 meters. The 160 meter VFO signal will also drive 40 meters satisfactorily. Six volts of 40 meter VFO excitation at the 6AU6 grid will be sufficient to drive the Viking II to full output on all bands, 40 meters through 10 meters. The R.F. Voltage at the 6AU6 grid should be limited to a value of less than 15 to 20 volts to prevent the stage from blocking.
- d. It should be borne in mind that any tendency of a VFO to chirp or drift is multiplied when the transmitter's output frequency is two, three, or four times the V.F.O. output.
- e. Zero beating a received signal in cw operation is accomplished by simply closing the key (with "plate" off) and adjusting the VFO for a zero beat with the received signal in the receiver. If the coupling of the Viking II exciter stages to the receiver is so close that the receiver tends to block, the exciter stage can be disconnected from the VFO by tuning the "crystal" switch to the #5 or #6 vacant crystal positions while adjusting the VFO. (Enough VFO coupling takes place in the #1 and #2 positions to partially excite the 6AU6.)
- f. Zero beating signals in phone operation is done by turning the "phone-cw" switch to "cw" and proceeding as described previously. In cases of very weak signals the receiver BFO may aid in making the VFO zero beat setting.

D VIKING II PI-NETWORK TUNING AND HARMONIC SUPPRESSION

The pi tuning/coupling network in the Viking II is designed to load the final amplifier into antenna resistances of nominally 50 to 600 ohms throughout the frequency range of the transmitter. In addition, it is capable of "tuning out" series antenna reactances up to several hundred ohms to complete a good match to most unbalanced antenna systems. The range of antenna impedances which may be matched by the pi network at frequencies higher than 7.0 mcs. extends from roughly 25 to 2000 ohms.

When the transmitter is well grounded and properly tuned, the higher harmonic suppression is excellent, generally much better than with other conventional methods of antenna coupling. This should be of interest to amateurs afflicted with TVI or other high frequency interference problems.

1. Importance of grounding:

To obtain proper tuning, coupling and harmonic suppression with any transmitter antenna coupling system, the part of the circuit designed to operate at RF ground potential must be at RF ground potential. A "room full of RF" is evidence that a high RF potential exists on something in or near the room. In many cases the source of RF is the transmitter's chassis and power cord. This condition is very undesirable for several reasons. The power cord is very closely coupled to the chassis by the electrostatic fields of the power transformers. Three objectional factors which obviously affect the loading of the transmitter when poor grounds are involved are:

- a. The impedance that the output terminal of the transmitter looks into includes not only the true antenna to ground impedance as presented by the antenna feedline but also the transmitter chassis to ground impedance. This additional impedance in some cases will raise the apparent antenna impedance to such a high value that it cannot be loaded by the pi network.
- b. Part of the transmitter's power is lost in the ground system due to radiation of the ground lead, power cord or cabinet. This power is quickly dissipated in surrounding objects and contributes nothing to effective radiated power except to distort the antenna's normal field pattern.
- c. It is conventional, in designing a transmitter, to bypass harmonics or any possible sources of stray high frequency currents to the chassis on the assumption the chassis will be kept as near ground potential as possible. When a high impedance is presented to these currents at the chassis they are able to radiate to some extent rather than be passed harmlessly to ground.

2. How to obtain a good ground:

What may appear to be a good ground at one frequency may prove to be a poor ground at another. A single ground lead may have "standing waves" on it due to its length. While it may seem difficult to obtain a good ground over a wide range of frequencies, it can be done and will be well-worth the trouble when increased radiation efficiency, ease of antenna loading and reduced TVI and BCI result. There is also reduced danger of damaging microphones, receivers and other associated equipment with excessive RF fields.

Avoid using the power line, power line conduit or gas lines for RF grounding. Some suggestions which may help to obtain a good ground are:

- a. Water pipes or metal building structural members are usually good sources of earth grounds.
- b. Use heavy conductors (#14 or larger) between the connection at the ground point and the transmitter. Copper ribbon is excellent for this purpose.
- c. The use of several ground leads, each of a different length and selected at random may be helpful in keeping grounding impedance low at the transmitter, even though the transmitter is some distance from a true earth ground. The possibility of obtaining an effective ground at any frequency

throughout the transmitter's range is quite good. If at any one frequency, one of the ground leads presents a low impedance at the chassis, the chassis is effectively grounded. By changing the length of one of the ground leads experimentally, a good ground can often be obtained at a frequency which has been troublesome. In bringing several leads to the transmitter, small closed loops near the transmitter or antenna feed line should be avoided. Induction fields will tend to raise the impedance of the ground leads.

- d. In cases where it is impossible to obtain a good earth ground, connecting the transmitter chassis to some system of conductors having a very low effective impedance to ground compared to the antenna impedance may be helpful. Usually this artificial "ground" takes the form of a system of radial wires spread horizontally on the floor, a gridwork of wires, or a large metal sheet on the floor below the transmitter. To be most effective, the minimum area covered by the metal conductors should be roughly equivalent to a square, the length of one side of which approaches a quarter wavelength. This system of "grounding" should be experimented with before committing the location of any permanent installation.
- e. A simple counterpoise made up of a single wire attached to the chassis may be helpful. On 10 meters a length of 6 to 8 feet may be attached and the open end cut off 4 inches at a time until the chassis becomes "cold". The open wire may be allowed to drop along the floor although its open end will be somewhat "hot".
- f. A rough check on the effectiveness of the transmitter ground may be made by touching the chassis while watching the PA plate current and grid current with the transmitter operating into an antenna. A change in current upon touching the chassis is indicative of an ineffective ground. If a neon bulb, held between the fingers, can be ignited by touching it to the chassis, the RF present is excessive and is another indication of an ineffective ground. In cases where the transmitter is feeding a low impedance antenna, the test by touching the chassis is more reliable since 50 to 60 volts is required to ignite the neon lamp.

3. Loading Random Antennas with the Pi Network:

With the transmitter chassis well grounded, correctly designed antenna systems having relatively "flat" unbalanced feeder systems, can easily be loaded by following the instructions already given, provided the antenna terminal impedances fall within the range of the pi network. Feeding a balanced system with a feedline over a quarter of one wavelength long, may prove to be surprisingly successful if the transmitter chassis is held at ground potential. The transmission line between the transmitter and antenna will tend to assume a partial balance at the antenna. Some standing waves will result but may not be excessive. The Johnson Matchbox, a universal all band, bandswitched antenna coupler will permit loading of the Viking transmitter to any practical antenna system. In addition, it provides for the use of the Johnson 250-20 Low Pass Filter for increased harmonic suppression.

Antennas having random lengths, random feed points and various types of feed lines will exhibit widely different resistance and reactance characteristics. It is well to remember that the feedline is a very important

part of the system. A common example of the random antenna is a horizontal wire fed by a single wire feed line. The feedline in this case actually becomes part of the radiating system. An antenna of this type can, in most instances, be fed by the pi network directly but there are critical dimensions where the antenna series reactance (inductive or capacitive) becomes too high and the antenna resistance can become either too high or too low to be matched by the pi network.

Antennas with high terminal resistance or reactance can usually be recognized while loading the final stage of the Viking II. The final amplifier is normally loaded by reducing the output coupling capacitor (C30) in small steps, retuning the amplifier to resonance each time. This results in an increase in PA cathode (plt) current and is continued until full loading is achieved. If however, a point is reached where decreasing the output coupling capacitor (C30) does not result in a marked increase in PA cathode (plt) current and the PA is not fully loaded, the antenna can be assumed to have a high resistance or reactance at this frequency.

Antennas with low terminal impedance (resistance and reactance both low) can usually be recognized by a noticeable lack of coupling condenser effect in the range of settings normally used at the operating frequency. There will be little or no detuning evidenced as the coupling control is changed.

Several things can be tried in an effort to bring the antenna system into the tuning range of the pi network:

- a. Change the length of the feeder line between the antenna and transmitter experimentally $1/8$ to $1/4$ wavelength.
- b. Change the point of connection of the feedline to the antenna $1/8$ to $1/4$ wavelength.
- c. Change the antenna length $1/3$ to $1/4$ wavelength. Antennas shorter than $1/8$ wavelength (antenna and feeder) may be difficult to load. They present a high capacitive reactance to the transmitter output terminals. Effective antenna lengths in the vicinity of $1/2$ wavelength will in general exhibit characteristics of high resistance, high reactance (inductive or capacitive), or both.
- d. "Load" the antenna feeder by placing an inductor or capacitor in series to cancel out the reactance of the antenna feeder. This may require considerable cut and try and will affect only the reactive component of the antenna impedance. However, it can prove useful in some cases.
- e. L type matching networks of inductance and capacitance may be used to aid impedance matching. Much discussion of this more elaborate method of bringing the antenna impedance within the range of the pi network could be included, however, the few cases where it is necessary do not justify inclusion herein. Textbook and handbook discussions will be helpful if work along this line is pursued. There is danger of resonating the coupling condenser of the pi network when using an external coil. This should be watched as excessive voltage built up across the coupling condensers can cause damage. Improper coupling or loading will take place under these conditions.

4. Dangers to be avoided and hints which may further aid in harmonic and TVI reduction.
- a. When loading high impedance antennas there is a temptation to "squeeze" the last watt into the antenna by opening the coupling condensers as much as possible. Harmonic suppression is dependent, to a great extent, on the amount of coupling capacity in the circuit. It is wise to use as much coupling capacity as practical at all times. The proper amount of coupling when the antenna impedance is high, can be conveniently determined by holding a neon lamp against the antenna feeder. The coupling condenser can then be opened until little increase in glow is noticed when the coupling condenser and tuning controls are adjusted for maximum output. A decrease in coupling capacitance beyond this point may cause a higher plate current reading due to reduced plate circuit efficiency. Higher harmonic output will also result as the coupling capacity is reduced beyond the point where the output has leveled off. The random antenna system may present a more favorable impedance to harmonic output than the output on the fundamental frequency; hence it is well to use as much coupling capacity as is practical. It is well to remember that the amount of coupling capacitance needed is dependent on the operating frequency. For example, 2,000 micro microfarads at 3.5 mcs. corresponds to 160 micro microfarads at 28.0 mcs. These are the values necessary to couple resistive loads of approximately 50 ohms, at the frequencies stated.
 - b. The low frequency bands (80 to 160 meters) may present the danger of doubling in the final stage when the antenna impedance is high. If the coupling condensers are reduced to values comparable to the capacity of the tuning condenser (C29) the net plate tuning capacity is reduced, as these condensers are effectively in series, and it becomes very possible to inadvertently tune to the second harmonic instead of the fundamental of the intended output frequency. To avoid doubling in the final, the initial tuning should be done with all the output coupling capacity in the circuit and the final tuning control starting from its zero setting. The first dip of the amplifier cathode current, as the tuning control is advanced from zero setting, is the resonant point for the fundamental output frequency. As the coupling condensers are reduced the tuning control should be reset, toward zero, for minimum cathode current so that the original plate circuit resonant frequency is maintained. Avoid reducing the coupling condenser values below the point where the output levels off as discussed previously. No danger of doubling in the final will occur if the proper tuning method is followed. For some high impedance coupling conditions on the low frequency end of the 160 meter band, much of the output coupling capacity may be out of the circuit as the antenna is loaded and the tuning control may approach the maximum tank capacity setting (dial zero) and tend to go beyond. The amplifier is quite broad on 160 meters and if, under these conditions, the tuning control is left at zero, the output coupling capacity has been reduced excessively, and the efficiency will be quite good.
 - c. If the power line voltage is low or the high voltage rectifiers have low emission, the loaded plate current may not reach the normal value. This condition should not be confused with the inability of the pi network to load an antenna system.

5. Coupling to balanced antennas:

Balanced antennas such as center fed "Zepps", beams and folded dipoles normally use a two wire transmission line and should have equal voltages, 180 degrees out of phase, applied to each feedline terminal. Since the output of the Viking II is single ended, unbalanced, a coupler is required for balanced antenna systems. The Johnson Matchbox, a universal all band, bandswitched antenna coupler will permit loading of the Viking Transmitter to any practical antenna system. In addition, it provides for the use of the Johnson 250-20 Low Pass Filter for increased harmonic suppression. A simple coupler for this purpose is shown below. The tank circuit is resonant at the operating frequency and can be excited by a coaxial line and coupling link. Line impedance is not critical although 52 ohm line will be most desirable if a JOHNSON Low Pass Filter is to be used.

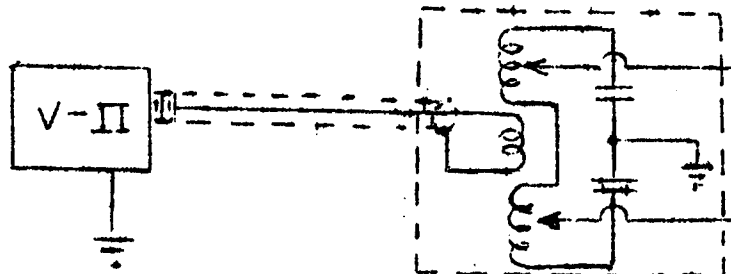

Feedpoint impedance of the coupler is adjusted by means of the inductor taps. Tap adjustment unnecessary with Johnson Matchbox. Final amplifier loading is adjusted with the transmitter output coupling controls.

Tuning of the coupler can be made quite broad by making the L/C ratio as high as possible (low "Q") while still permitting the desired loading. Inductive reactance of the coupling link may make it impossible to reduce the SWR of the coaxial line to or below 1 1/2 to 1. If so, the link circuit may be made series resonant by adding capacitor C1 as shown below:

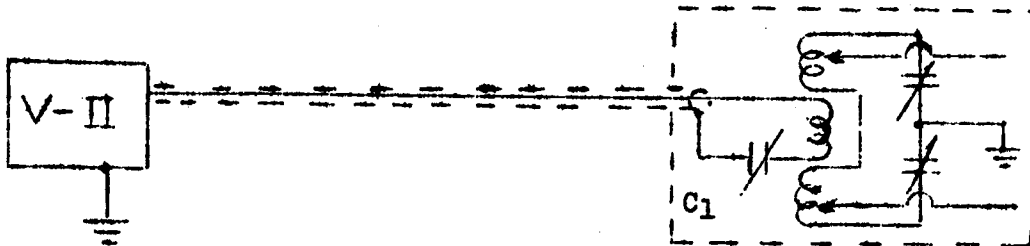

6. Use of low pass filters:

Depending upon how it is tuned, 2nd harmonic attenuation of the Viking II amplifier can be as high as 30 db. Since this will permit operation in many locations without television interference, the JOHNSON 250-20 Low Pass Filter is not an integral component of the Viking II but is available as an optional accessory. This filter will provide an additional 75 db or more harmonic attenuation with insertion loss less than .25 db. Characteristic impedance is 52 ohms, power rating 1 KW.

The low pass filter may be inserted in the coaxial line between the transmitter and the antenna coupler. Coaxial connectors are used at the transmitter and at both ends of the low pass filter to preserve the shielding

provided by the coaxial line. It is important that the standing wave ratio on the coaxial line be maintained at 1 1/2 to 1 or less, therefore the impedance of the line between the Viking and the coupling link should be the same as the characteristic impedance of the filter. (The JOHNSON 250-20 Low Pass Filter and Johnson Matchbox are 52 ohms impedance.) The section of coaxial line between the transmitter and the low pass filter should be as short as possible and electrical quarter waves should be avoided. An RF bridge such as the Johnson 250-25, for measuring SWR will prove invaluable for both initial set-up and for operational checks.

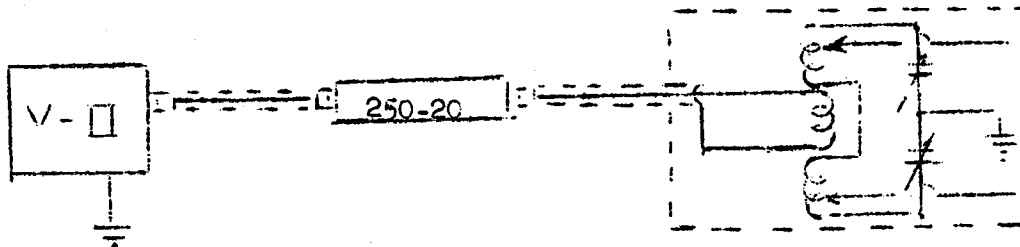

An end fed half-wave antenna may present loading problems, both from the standpoint that its impedance is higher than can be matched by the pi-network amplifier of the Viking or that the low output coupling capacitance used reduces inherent harmonic attenuation below tolerable values. Therefore the use of a half wave antenna may create TVI problems while other antennas prove perfectly satisfactory. In these cases it is recommended that the Johnson Matchbox be used.

E TROUBLE SHOOTING

1. SCHEMATICS, PHOTOGRAPHS, AND CHARTS aid greatly in trouble shooting; use them. Part 2 and 3 list typical voltage, current and winding resistance values; individual transmitters may vary somewhat from the values shown but generally no more than 10 to 20%. Parts 4 through 13 list symptoms of trouble and suggestions for their location and cure.

Figures 9, 10, 11, 12, and 13 on the last sheets of this book will facilitate component and wire location in the Viking II.

BE CAREFUL when making HIGH VOLTAGE measurements. DO NOT TAKE CHANCES. Do not depend on the bleeder resistor to drain the high voltage condenser but use a well insulated screwdriver to short any high voltage point to chassis by first grounding the screwdriver to the chassis and bringing the shank to the terminal to be discharged.

All power supplies must be off and discharged before making ohmmeter measurements.

2. Typical Viking II voltages and currents with the 6146 Final loaded into a 50 ohm load:
 - a. CW operation 115V 60 cycle ac, input voltage measurements made with 20,000 ohm/volt voltmeter.

Frequency 28.868

P.A. screen and plate current ("plt")	300 ma
P.A. grid current ("grid")	6.0 ma
P.A. plate voltage	+660 V
P.A. screen voltage	+175
P.A. grid bias (total)	- 97 V (-77 V no sig)
Power output	135 watts
Buffer current	20 ma
Oscillator current	8.0 ma
Low Voltage B+	+310 V
Bias Supply Voltage	- 80 V (with 6.0 ma 6146 grid current)
6AQ5 fixed bias	- 25 V "
807 fixed bias	- 37 V "
6AU6 speech amplifier (socket X1) screen voltage	+ 70 V (no sig)
6AU6 speech amplifier plate voltage	+ 60 V "
6AU6 audio driver (socket 2) screen voltage	+180 V "
6AU6 audio driver (socket 2) plate voltage	+300 V "

- b. Phone operation with the above input conditions. Only readings which vary significantly from cw operation or apply only to phone operation are recorded. Approximately 30% modulation was applied during measurements.

P.A. screen and plate current	230 ma
P.A. plate voltage	+620 V
P.A. screen voltage	+185 V
Power output	110 watts (carrier and side bands) 102 watts (no signal)
Modulator cathode current	90 ma (75 ma no signal)

The no signal "mod" current should be between 60 to 80 ma.
This may be adjusted by moving the tap nearest the rear of the chassis on the high voltage divider R13. (WITH POWER OFF) If the R13 tap is adjusted, R30 should be readjusted.

3. Transformer and choke winding resistances and open circuit voltages.

	<u>Winding</u>	<u>Color of Leads</u>	<u>Resistance</u>	<u>Open ckt ac voltage (112 V 60 cy input)</u>
T1 P1781	115 V pri.	black to black	1.0 ohms	---
	secondary	red to yel-rd yel-rd to other red	105 96	865 volts 865
T2 P1893	115 V pri.	black to black	2.5	---
	L.V. sec.	red to yel-rd	97	298
		yel-rd to other red	95	298
	Bias sec.	blue to blue	46	140
	Fil	green to green	less than .1	6.4
	L.V. rect.	brown to brown	.2	5.1
	H.V. rect.	yel to yel	.1	5.2
L1 P1783	H.V. choke		95	
L2 P1501	L.V. choke		280	
L3 P1784	Bias choke		440	
T3 P1503	Audio pri.	red to blue	210	<u>Open circuit 1000 cycle inductance</u> approx 2.6 H
	Sec.	black to yel black to green	110 105	
T4 P1992	Mod. pri.	red to brown	100	1.5 to 1.75 H
		red to blue	95	1.5 to 1.75 H
	Mod. sec.	Gn-yel to green rd-yel to yel	36 36	(.01 bypass condensers C32 and C46 must be disconnected before measuring inductance)

No attempt has been made to anticipate all troubles, operating errors, or component failures in parts 4 through 13, but a few symptoms with a discussion of probable causes may suggest means of analyzing other symptoms related to those mentioned.

NEVER REPLACE FUSE WITH A VALUE HIGHER THAN 5 AMPERES

Under no circumstances should a Fusetron type fuse be used in this transmitter because of the high values of current that it will hold for long periods of time.

4. Fuse blows when "Fil" is turned on:

- a. Check 6AL5, 5V4G, 6AU6's and 6AQ5 tubes for shorts between plate and other elements.
 - b. Look at tube socket terminals and T2 primary ac wiring for shorts.
 - c. The low voltage B+ may be shorted. An ohmmeter test of the exciter (oscillator or buffer) coils to chassis should show approximately 25,000 ohms.
 - d. If no short is found on the B+ line, check the transformer windings for shorts to ground or shorted turns. Open circuit voltage data may be useful in finding turn-to-turn shorts.
 - e. Check X10 wiring also shield of VFO power socket X12.
5. FUSE BLOWS when "plate" is turned on:
- a. Check for condensed moisture on 5R4 sockets X8 and X9.
 - b. Check 5R4, 6146, and 807 tubes for shorts.
 - c. Check High Voltage B+ line for shorts (violet leads 42, 43 and 44 may be conveniently isolated at the H.V. bleeder-divider resistor R13).
 - d. Check H.V. primary wiring and "plate" indicator pilot light.
 - e. If no ground is found on H.V. B+ line, test H.V. transformer for shorts to ground or winding to winding.
6. R.F. EXCITER:
- a. No "osc" current may be due to "cw-phone" switch on phone, key open, 6AU6 filament being open, or no L.V. B+.
 - b. "Grid" current low and "bfr" current low - may be due to a weak buffer or oscillator tube. A few 6AQ5's or 6AU6 may show good emission in a tube tester but will prove to be poor R.F. amplifiers. Check tuning curves to be certain tuning is near the expected setting.
 - c. Key up "bfr" current being excessive may be caused by failure of the bias supply.
 - d. Erratic keying usually can be corrected by adjusting the "oscillator" tuning. If this does not correct the condition the crystal may be suspected as normally the Viking keys cleanly with most crystals.
 - e. Failure to oscillate is usually due to the crystal but it may be well to check the position of the "crystal" dial to be certain it corresponds to the crystal socket number.
7. Inability to tune Final:
- a. Check position of 160 meter switch.
 - b. Check for loose connections in the tank and loading circuits.

8. Inability to Load Final:
 - a. Check ground connections.
 - b. Check antenna connections.
 - c. Read discussion on pi network loading.
9. Report of excessive harmonics:
 - a. Check tuning to make certain doubling is not taking place in the final.
 - b. Examine antenna to make certain that its efficiency at the harmonic is not many times greater than at the fundamental.
 - c. Read discussion on Pi Network Tuning and Harmonic Suppression.
 - d. In checking harmonics remember that an excessive fundamental signal to the receiver may cause harmonic generation in a receiver stage - hence a false indication may be noted.
10. Report of signals 20 to 60 KC away from either side of carrier.
 - a. These spurious signals originate in the crystal. A few crystals will show some excitation near the fundamental mode of oscillation. Oscillator tuning may clear this condition in a few cases but usually the crystal must be replaced.
11. R.F. on Chassis or Mike:
 - a. Ineffective grounds or a very low impedance at the antenna termination at the transmitter may cause this - usually the former.
 - b. Read discussion on grounds in the pi network tuning discussion. Page 15.
 - c. R.F. pickup can result if an unshielded antenna lead-in is used with a high standing wave.
12. High 6146 "plt" current with Key up:
 - a. A fixed bias failure is indicated. Check 6AL5 tube.
 - b. Check bias voltage on second terminal from the rear of X21 (white wire).
 - c. Check the resistance of the bias supply terminal to ground. This should be in the neighborhood of 5000 ohms.
 - d. Check adjustment of R30 and R13.
13. A Squeal is heard on "phone":
 - a. If a squeal or howl takes place when the audio is turned up, acoustical feedback between the mike and receiver may be the cause.

- b. A microphone 6AU6 in the speech amplifier can originate a ringing or squealing noise.
- c. A poorly shielded mike connection or lead can cause feedback conditions.

VIKING II MODULATION TRANSFORMER CONNECTED TO DRIVE A
LARGER MODULATOR WITH SWITCHING OR TRANSFER FOR NORMAL OPERATION

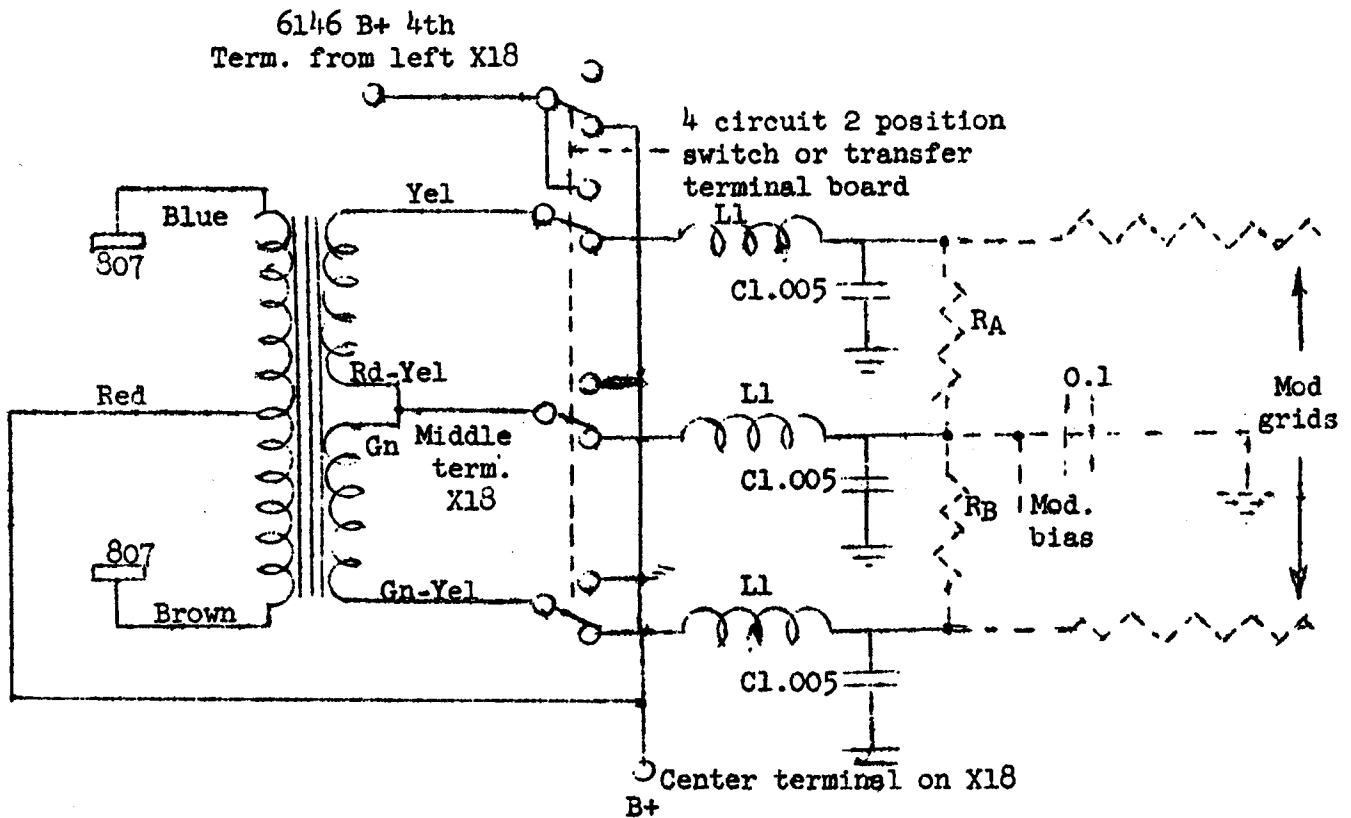

FIGURE A
DIRECT GRID CONNECTION

1. Refer to Figure 2 at the rear of the book for terminal locations. The yellow and gn-yel modulation transformer leads in Figure A and the yellow and rd-yel leads of Figure B must be disconnected from present terminations.
2. A 4 circuit 2 position switch may be mounted on the side of the chassis above X4 or a transfer terminal block may be mounted on the outside rear of the chassis. No attempt will be made to provide mounting details as available switches or terminal boards will differ markedly. Steatite switches or terminal boards should be insulated for 1200V between terminals.
3. RA, RB, or RC may be chosen to load Viking II Modulator if quality is impaired by light loading.
4. Permanent connections for exciter operation can be made as indicated by the closed circuits in the switch positions shown above, eliminating the switch or transfer board.

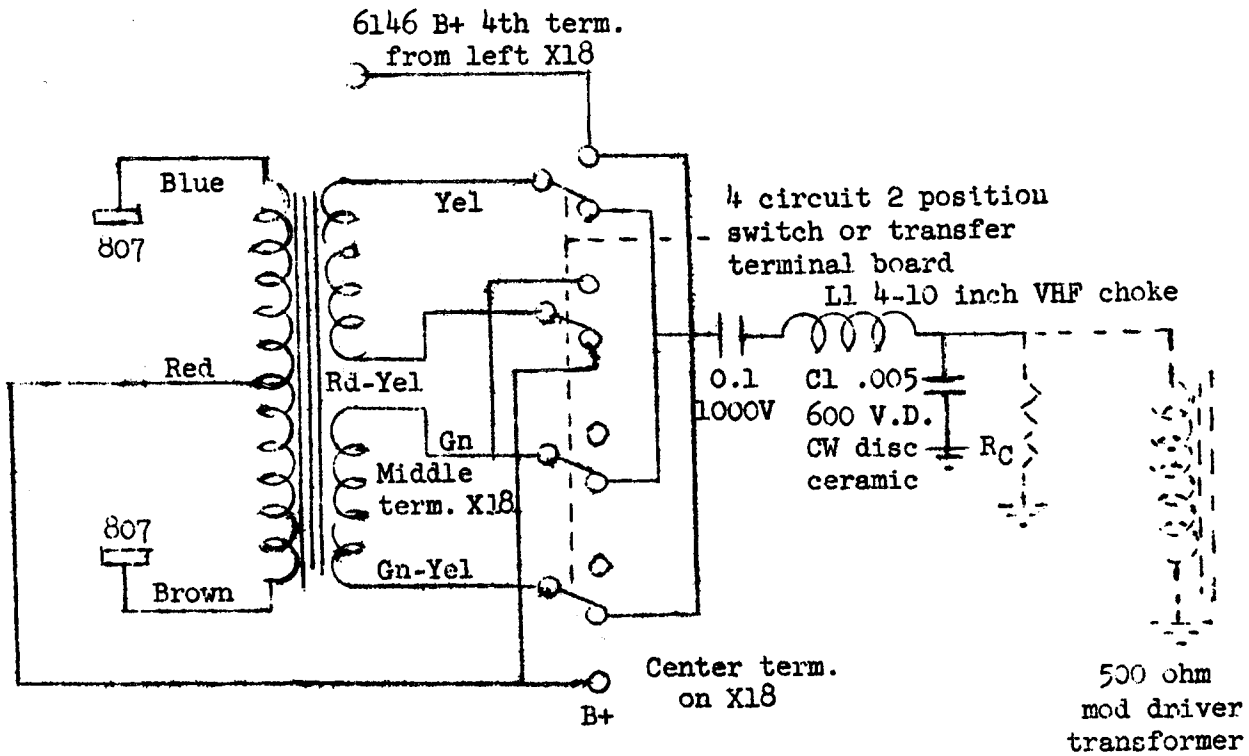

FIGURE B
CONNECTION THROUGH 500 OHM PRIMARY
OF MODULATOR DRIVER TRANSFORMER

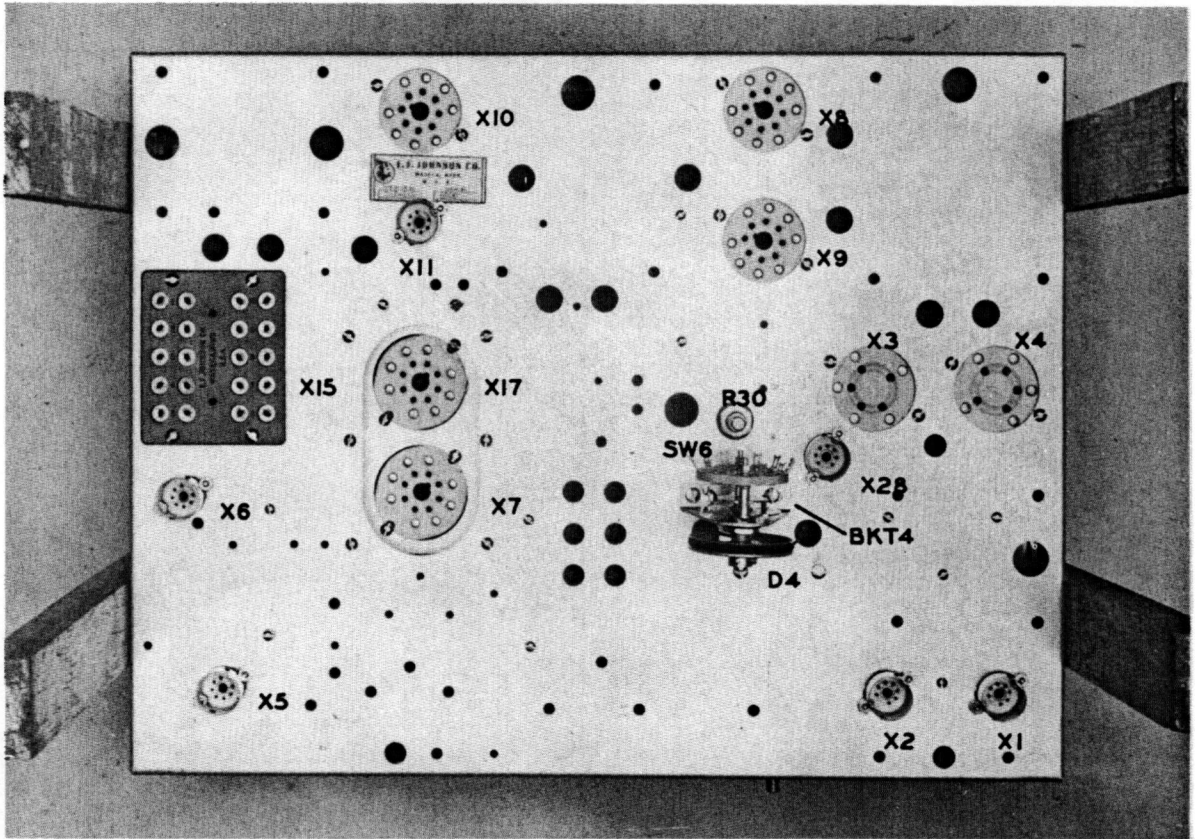

Figure 1 — Socket Mounting

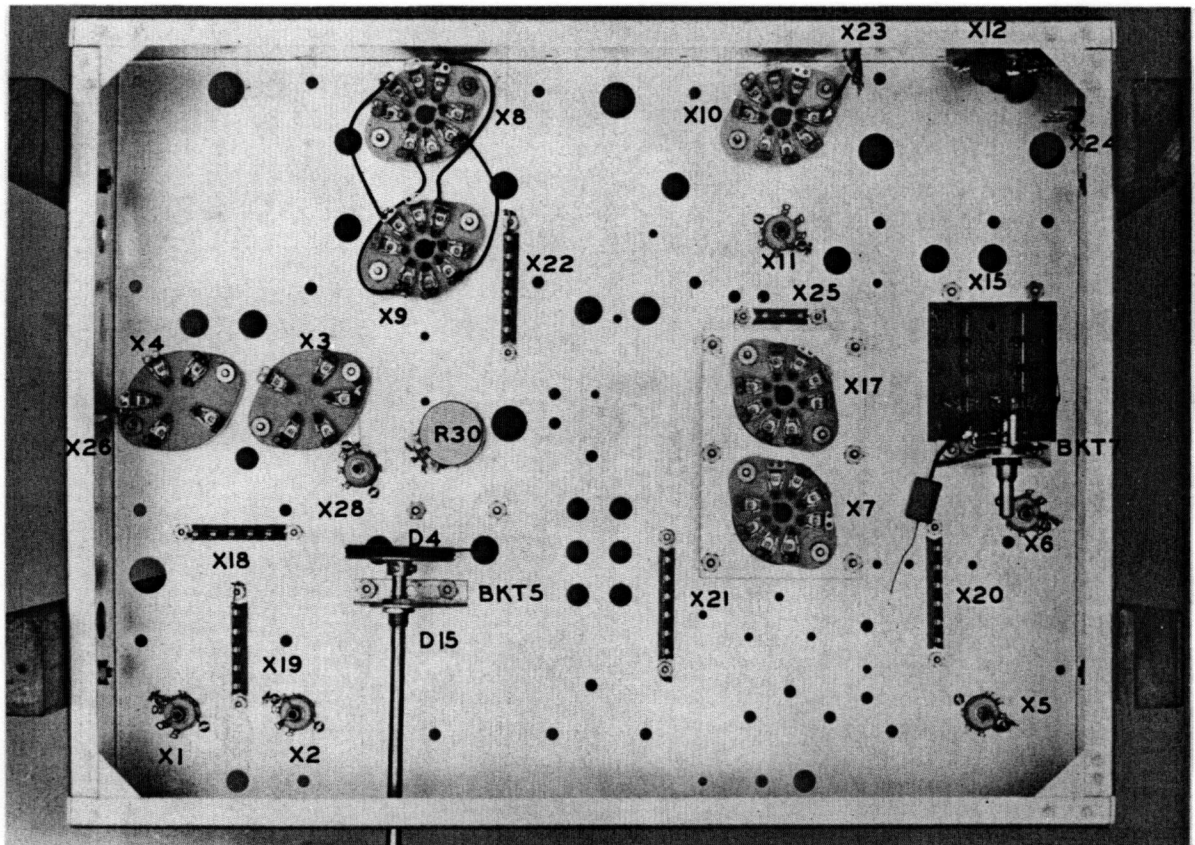

Figure 2 — Socket and Terminal Board Mounting

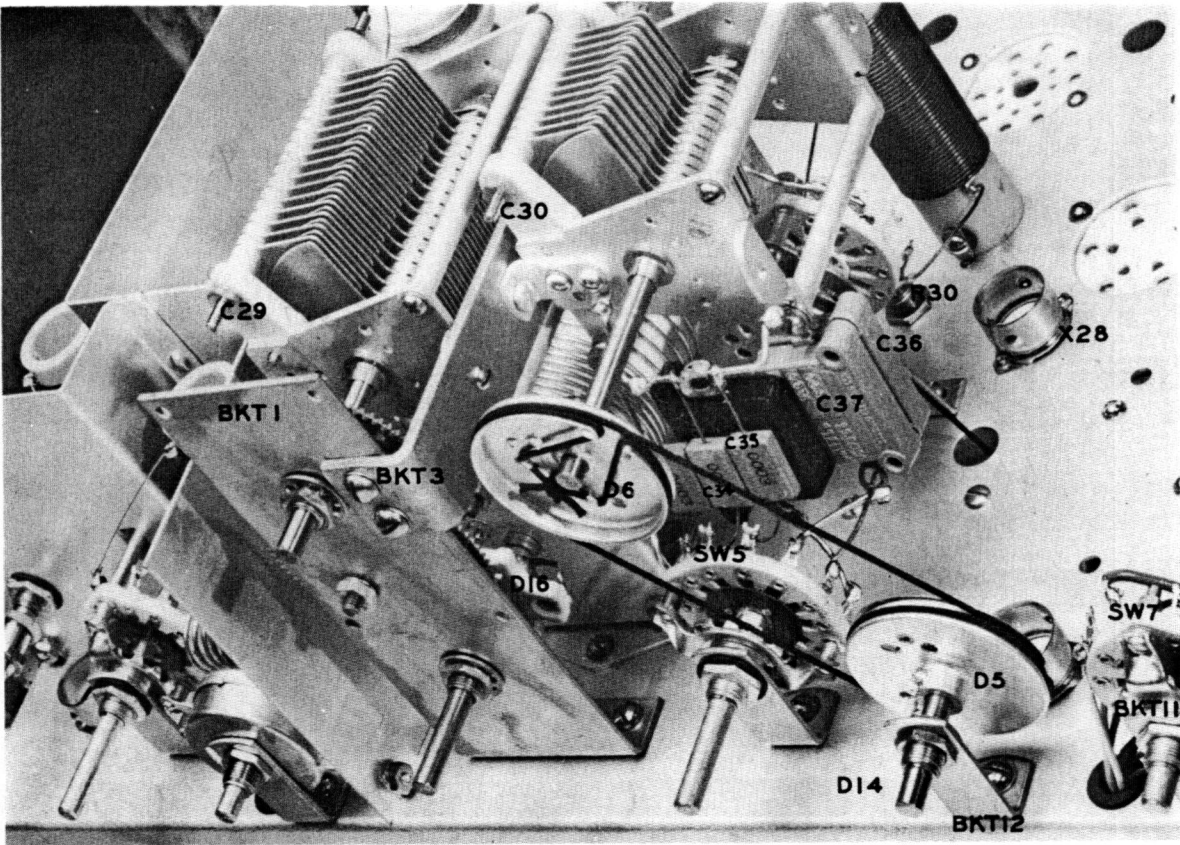

Figure 3 — PA Assembly Detail

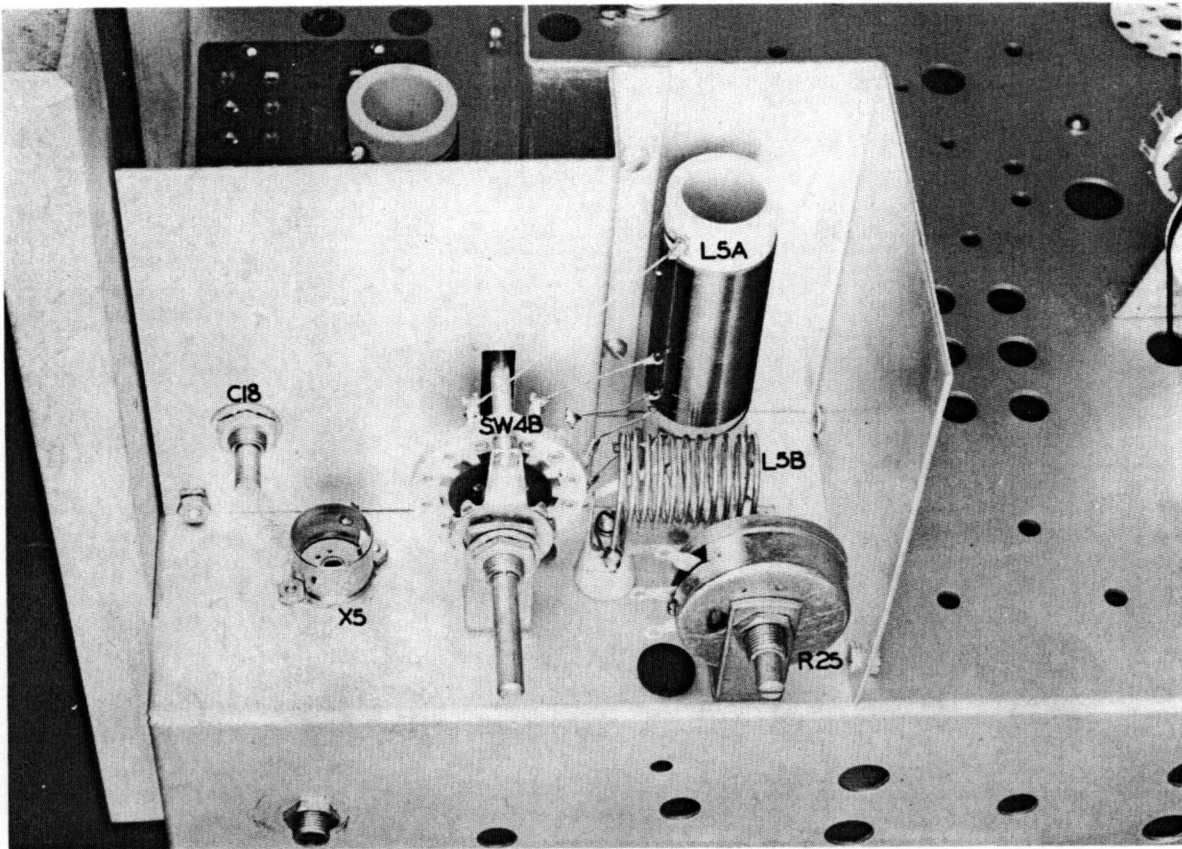

Figure 4 — Buffer Assembly Detail

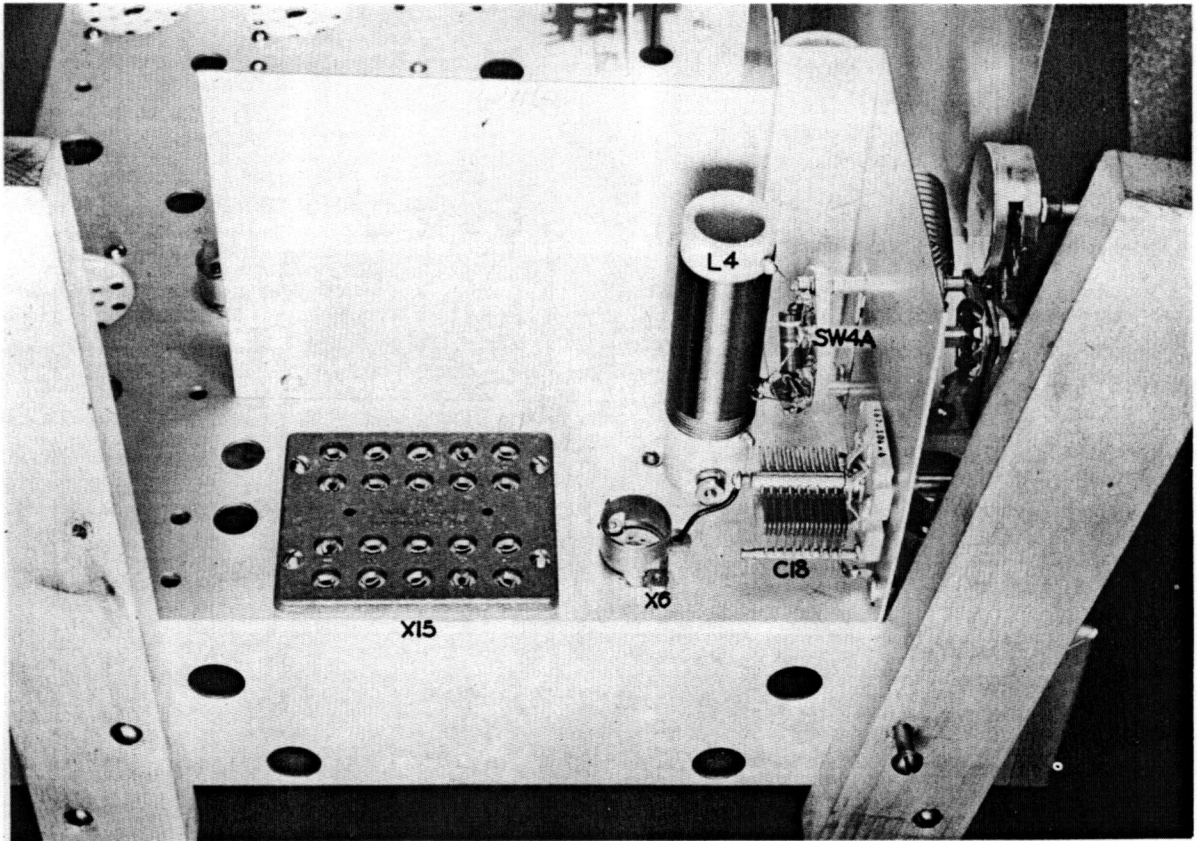

Figure 5 — Oscillator Assembly Detail

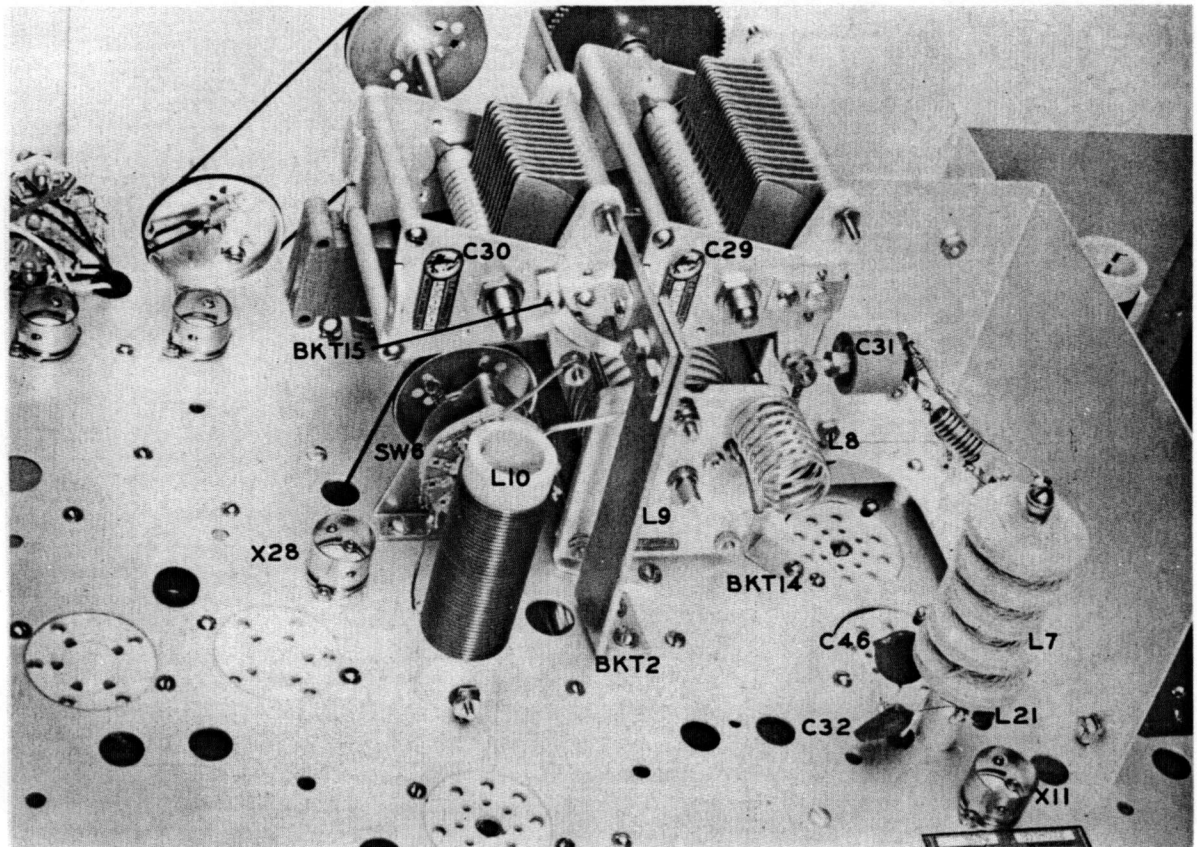

Figure 6-7 — PA Assembly Detail

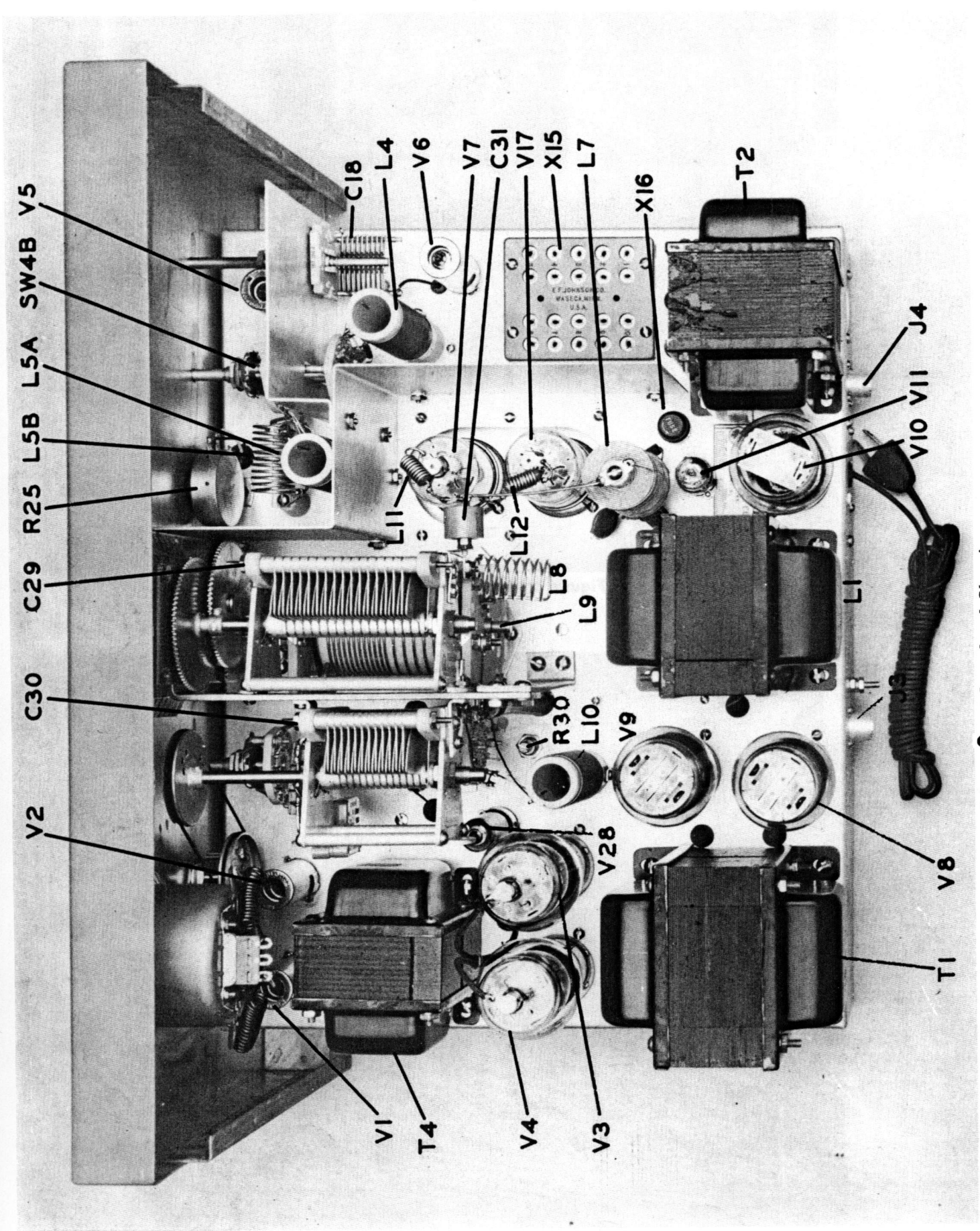

Figure 9 — Completed Chassis

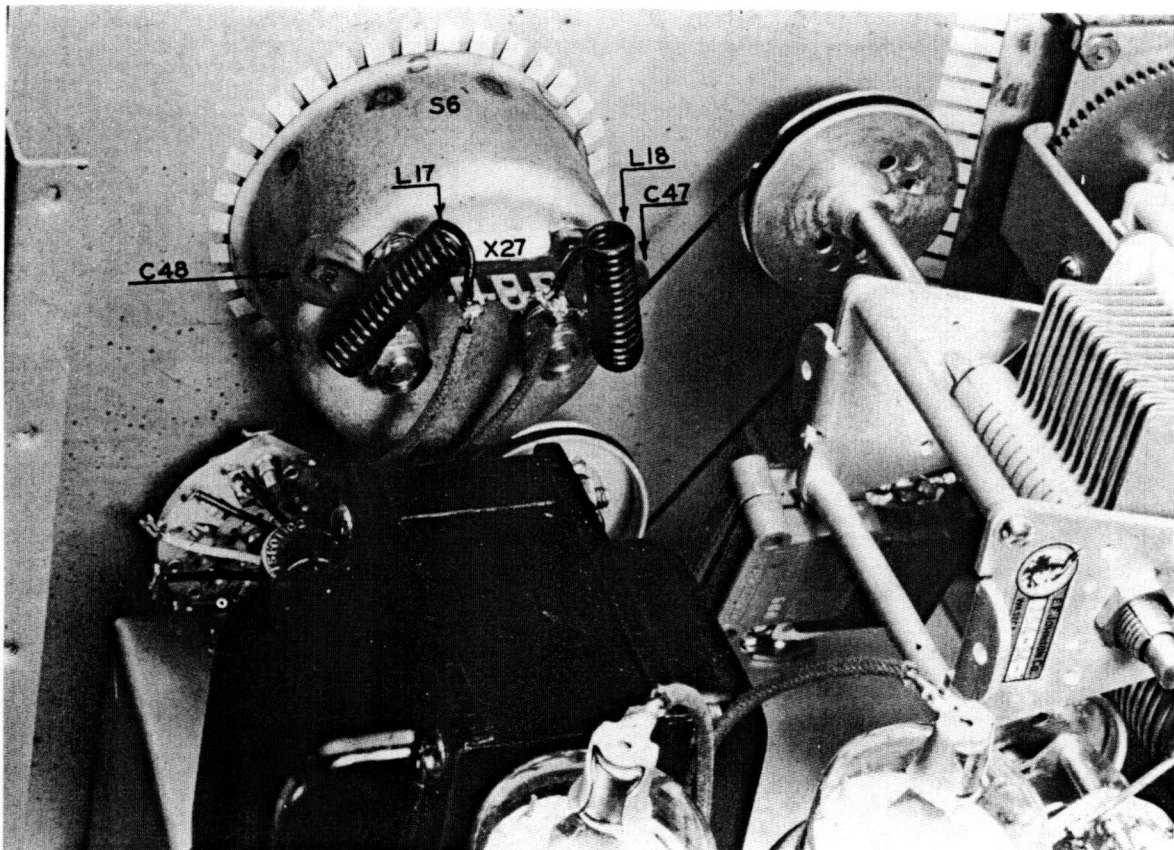

Figure 10a — Meter Filter Detail

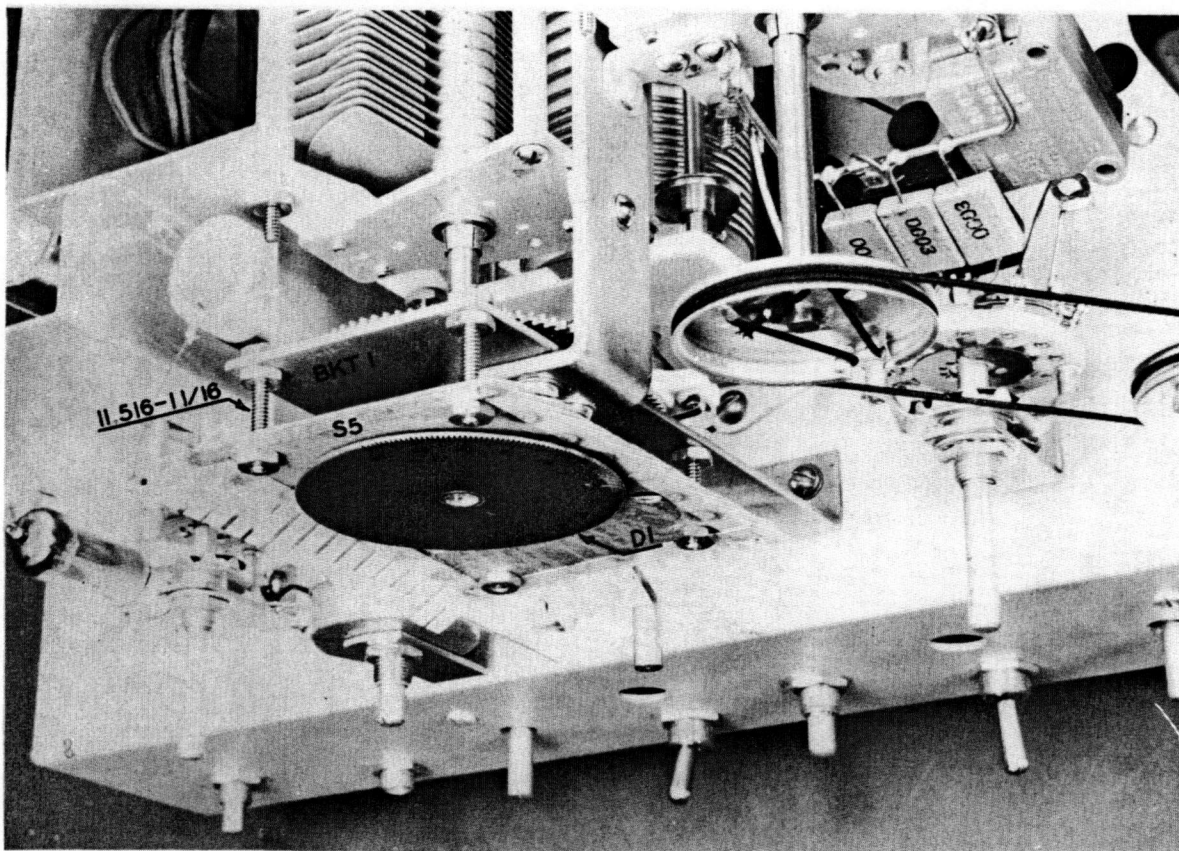

Figure 10b — Dial Window Shield Detail

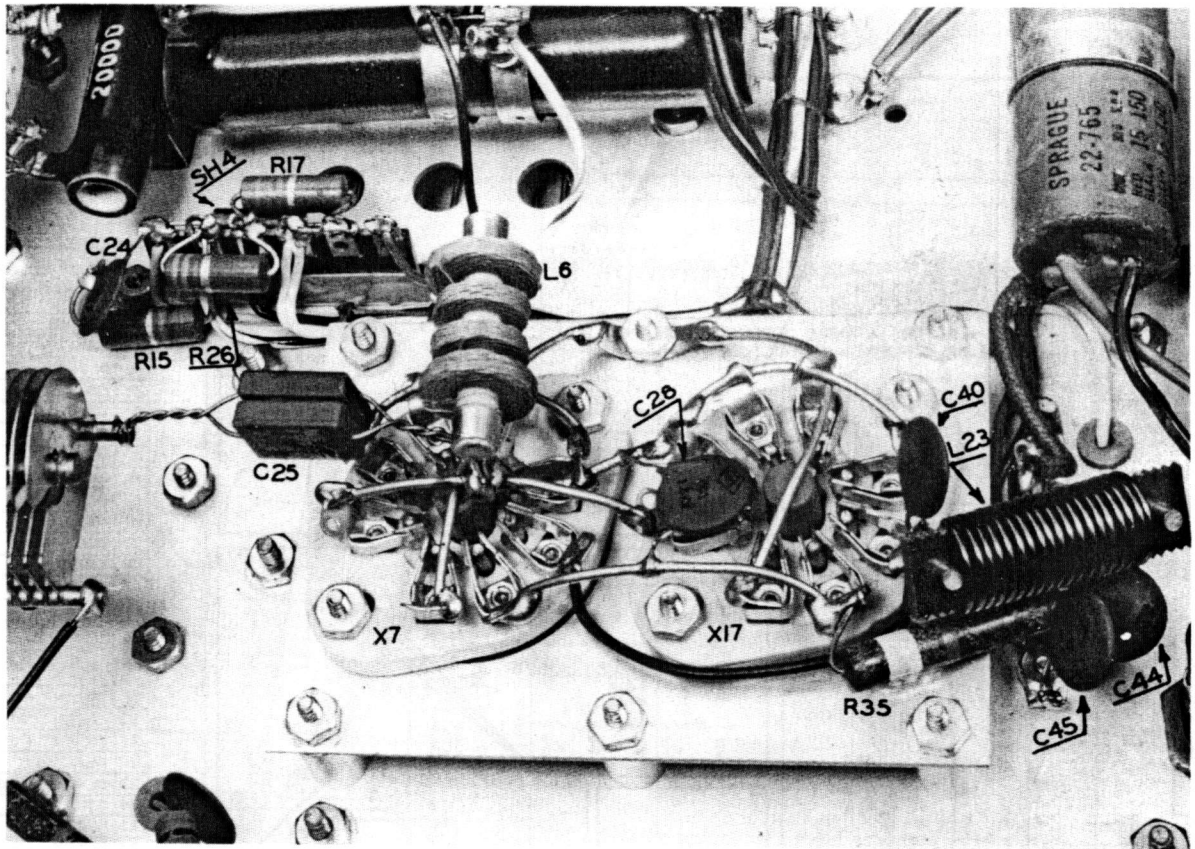

Figure 10c—6146 Socket Wiring

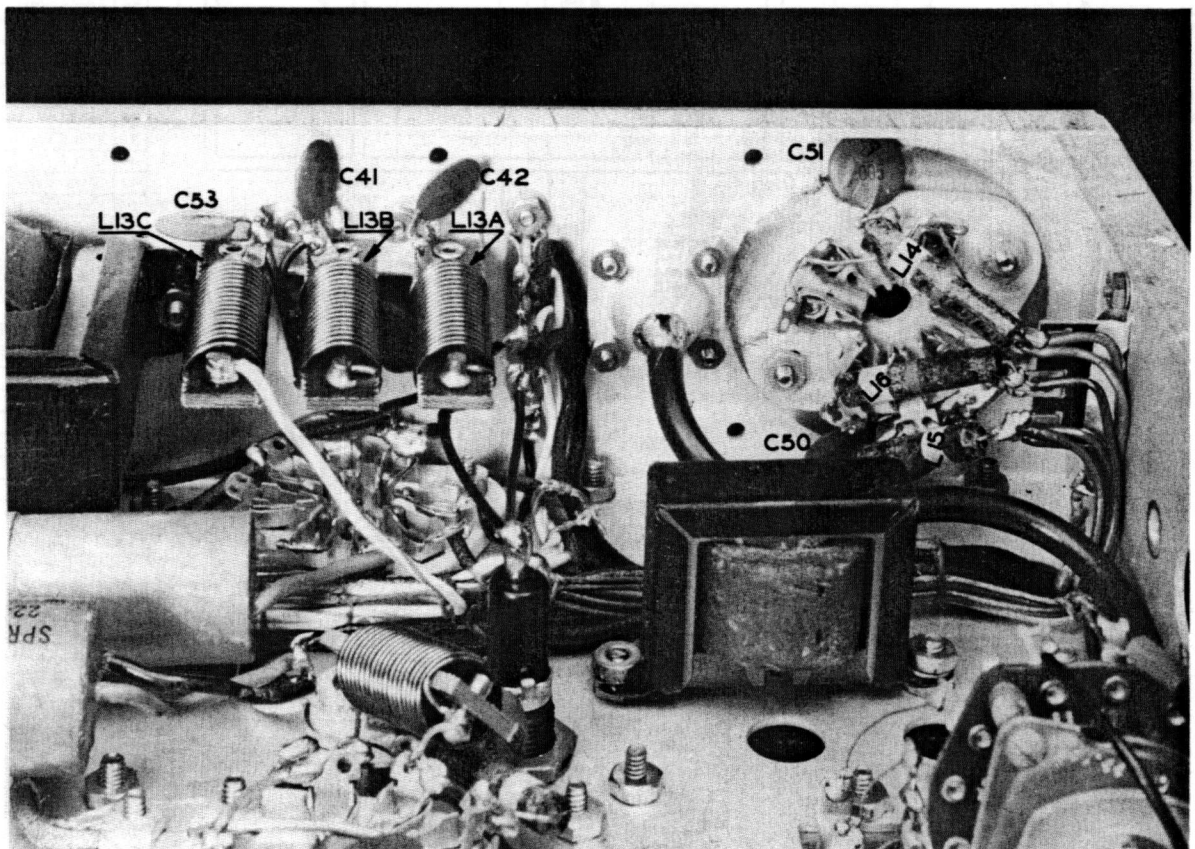
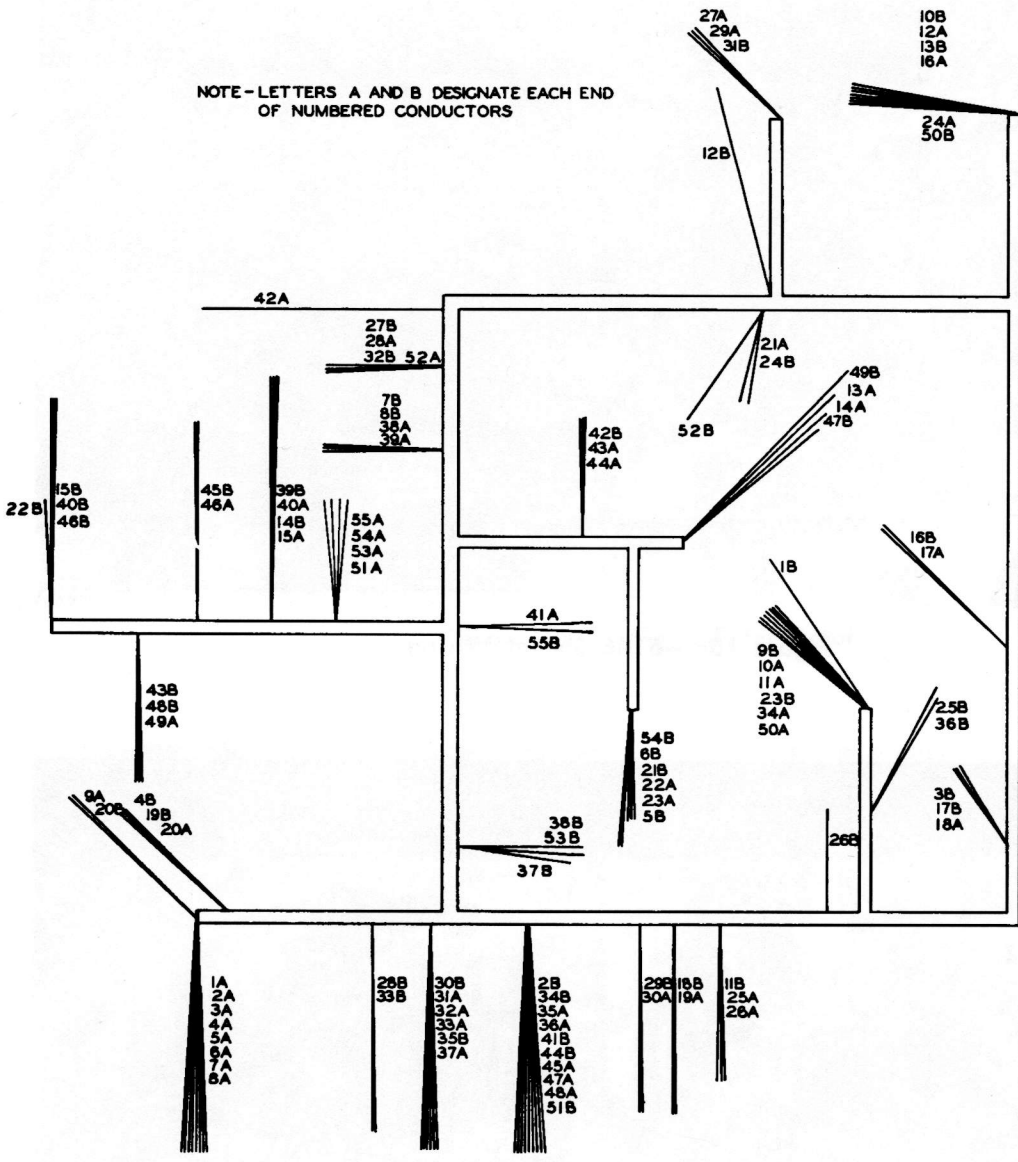

Figure 10d—Line Filter, VFO Socket Wiring Detail



LEAD COLORS	
1	BLUE
2	BROWN
3	GREY
4	BLACK
5	ORANGE
6	WHITE
7	YELLOW
8	VIOLET
9	RED
10	RED
11	RED
12	RED
13	GREEN
14	GREEN
15	GREEN
16	GREEN
17	GREEN
18	GREEN
19	GREEN
20	GREEN
21	WHITE
22	BLACK
23	BLACK-BROWN
24	GREEN
25	WHITE
26	BLACK
27	BLACK-BROWN
28	BLACK-BROWN
29	WHITE
30	BLUE-ORANGE
31	BLUE-ORANGE
32	GREY-RED
33	GREY-RED
34	BROWN
35	ORANGE
36	BLUE
37	BLACK
38	YELLOW
39	VIOLET
40	VIOLET
41	GRAY-RED
42	VIOLET
43	VIOLET
44	VIOLET
45	YELLOW-BLUE
46	YELLOW-BLUE
47	GREY
48	GREEN-WHITE
49	GREEN-WHITE
50	BROWN
51	RED
52	GREY-RED
53	YELLOW
54	BLUE
55	GREY-RED

Figure 11 — Wiring Harness

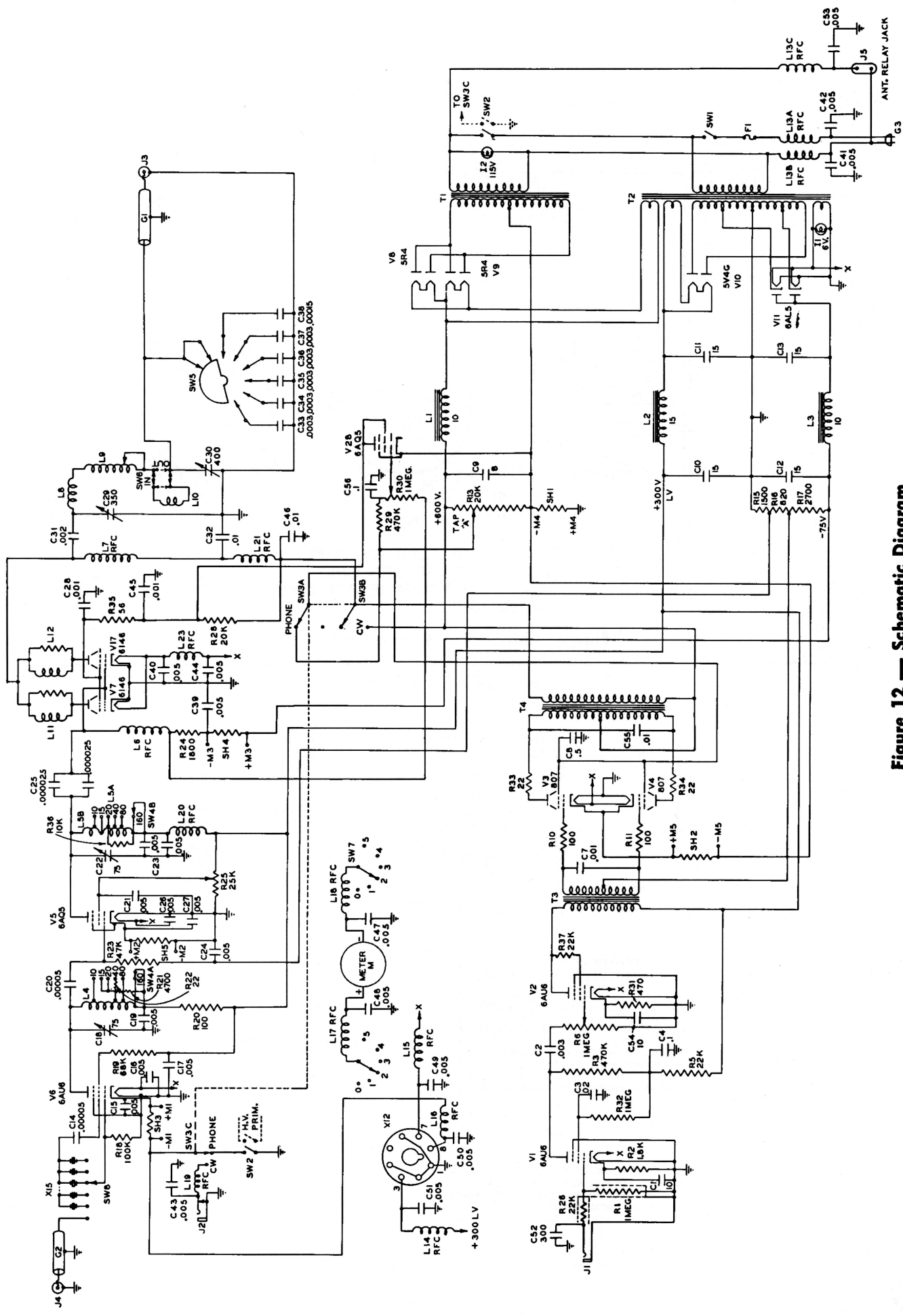

Figure 12 — Schematic Diagram

TUBE SOCKET CONNECTIONS BOTTOM VIEW

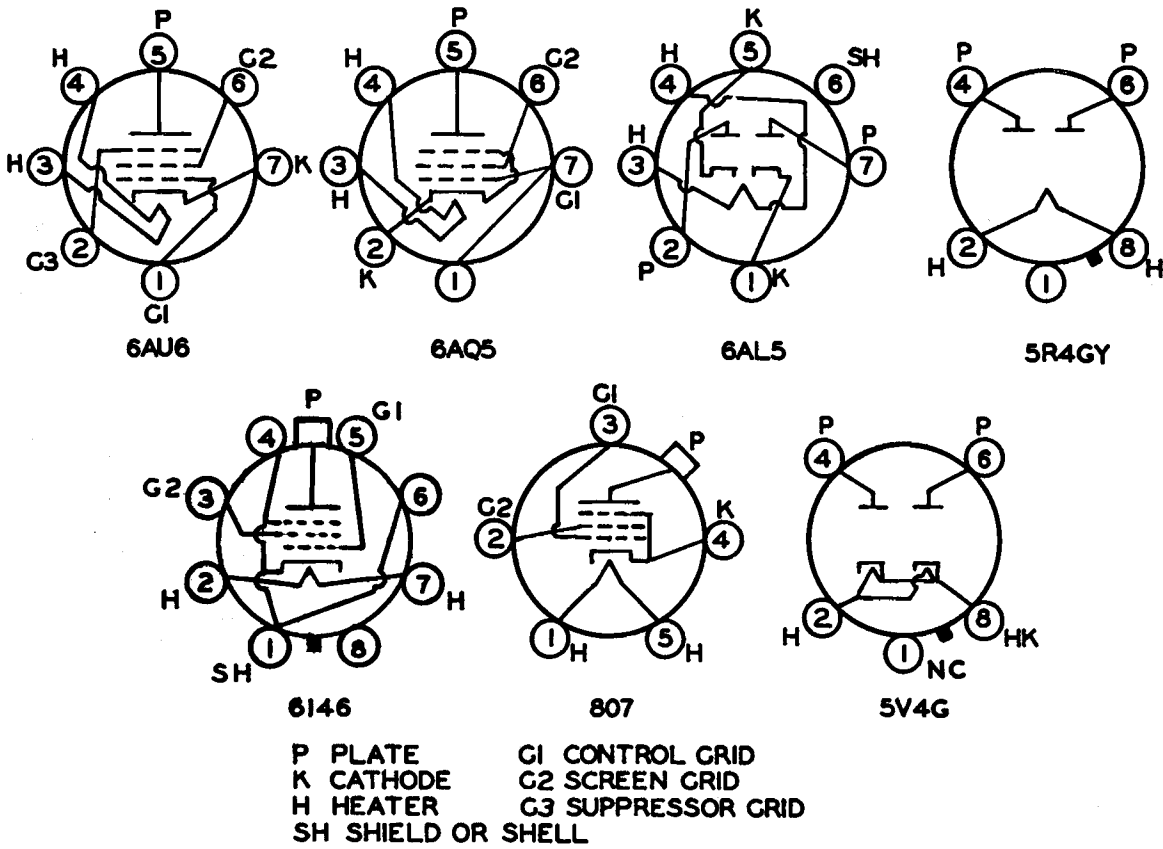

Figure 13—Socket Connections

CONDENSER-RESISTOR COLOR CODE

COLOR	SIGNIFICANT FIGURE	DECIMAL MULTIPLIER	TOLERANCE (%)	VOLTAGE RATING*
BLACK	0	1	1	100
BROWN	1	10	2	200
RED	2	100	3	300
ORANGE	3	1,000	4	400
YELLOW	4	10,000	5	500
GREEN	5	100,000	6	600
BLUE	6	1,000,000	7	700
VIOLET	7	10,000,000	8	800
GRAY	8	100,000,000	9	900
WHITE	9	1,000,000,000	5	1,000
COLD	-	0.1	10	2,000
SILVER	-	0.01	20	500
NO COLOR	-	-	-	-

* APPLIES TO CONDENSERS ONLY



COLOR CODING OF FIXED RESISTORS

- A—FIRST SIGNIFICANT FIGURE OF RESISTANCE IN OHMS
- B—SECOND SIGNIFICANT FIGURE
- C—DECIMAL MULTIPLIER
- D—RESISTANCE TOLERANCE IN PERCENT. IF NO COLOR SHOWN TOLERANCE IS $\pm 20\%$.

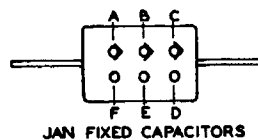

JAN FIXED CAPACITORS

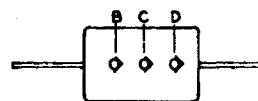

RMA 3-DOT CODE 500VOLT $\pm 20\%$

- COLOR CODING OF FIXED CONDENSERS**
- A—TYPE: MICA BLACK, PAPER SILVER
 - B—FIRST SIGNIFICANT FIGURE OF CAPACITY
 - C—SECOND SIGNIFICANT FIGURE
 - D—DECIMAL MULTIPLIER
 - E—TOLERANCE
 - F—CHARACTERISTIC
 - G—THIRD SIGNIFICANT FIGURE
 - H—VOLTAGE RATING

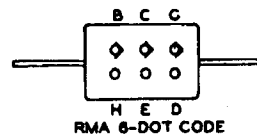

RMA 6-DOT CODE

Figure 14—Resistor, Capacitor Color Code

Viking II Transmitter

Parts List

Part No. or Drawing No.	Item No.	Qty.	Description
197-127-2	CH 1	1	Cabinet
17.810	CH 2	1	Chassis
17.811	CH 3	1	Final tube mounting plate
23.900-2	BKT 1	1	Final Tuning Drive Assembly
17.754-2	BKT 3	1	Bracket - Final Cond. Mounting
17.752-1	BKT 2	1	Bracket - Final Tank Support
16.857-2	BKT 4-7	4	Bracket - Crystal Sel. and Mounting
16.1001-1	BKT 8-12	5	Bracket - Component Mounting
16.1044-2	BKT 13	2	Bracket - H.V. Filter Cond.
16.1089	BKT 14	1	Tank Grounding Strap
16.1088	BKT 15	1	Jumper Strap
23.906-2	D 1	1	0-100 Final Tuning Dial and Hub
23.908-1	D 2	1	Final Tuning Index and Escutcheon Plate Assembly
23.909	D 3-6	4	Drive Pulley Hub Assembly
42.47-150	D 7-8	8-1/2 ft.	Dial Cord
16.1027-1	D 9-10	2	Dial Cord Tension Springs 9/16 x 3/16 x .033 Wire
14.145-7	D11	1	1/4" D. NFB Shaft Extension 5-1/2" long
14.145-6	D 13	1	1/4" D. NFB Shaft Extension 2-1/4" long
115-256-15	D 14	1	Shaft and Bearing Assembly 1-5/8" length
115-256-16	D 15	1	Shaft and Bearing Assembly 5-1/16" length
104-250-51	D 16	1	Insulated Coupling
13.123-7	D 17	2	Panel Bearing
104-258	D 18-19	2	Split Sleeve Coupling
23.910-2	K 1	1	Knob - Final Tuning
16.86-1	D 20	5	Tension Spring
23.907-12	K 2-4	3	Knob Dial (100-0)
23.907-13	K 5-7	3	Knob Dial (10-0)
23.907-14	K 8-9	2	Knob Dial (Single Marker)
23.907-17	K 10	1	Knob Dial (Meter)
23.907-15	K 11	1	Knob Dial (7-1)
23.907-16	K 12	1	Knob Dial (Bandswitch)
		1	#4 Hardware Envelope
		1	#6 Hardware Envelope
		1	#8 Hardware Envelope
		1	#10 Hardware Envelope
		1	3/8" Hardware Envelope
		1	Terminal and Lug Hardware Envelope
29.387		1	15/32 I.D. x 59/64 O.D. Special Washer
13.49-9		6	Spacer 1/2" length x 3/8" O.D. Aluminum
23.08-2		1	Envelope Assembly for C30 Condenser
133-278-7	S1 S2 S5	3	1 3/4" Miniature Tube Shield
133-278-8	S6	1	2 1/4" Miniature Tube Shield

17-755	S4A	1	Oscillator Buffer Shield
17.756	S4B	1	Oscillator Buffer Shield
23.1003	S5	1	Final Window Shield
23.1004	S6	1	Meter Shield
17.814	S7	1	VFO Socket Shield
120-277B-1	XI X2 X5	6	Shielded 7 Pin Miniature Socket
	X6 X11 X28		
122-225	X3 X4	2	5 Pin Wafer Socket
122-228	X8 X9 X10	6	Octal Wafer Socket
	X7 X17 X12		
147-620	X13A	1	115 V Candelabra Socket
147-600	X14A	1	6 V Miniature Socket
147-310-56	X13B	1	Faceted Jewel - red
147-310-57	X14B	1	Faceted Jewel - green
126-120	X15	1	Crystal Mounting Board
22.739-2	X16	1	Fuse Extractor Post
22.740-5	X18-19	2	"2005" Jones Terminal Strip
22.740-6	X20-22	3	"2006" Jones Terminal Strip
22.740-3	X23-27	5	"2003" Jones Terminal Strip
71.32-170	G1	10-7/16"	RG8U Cable (cut to length)
71.32-178	G2	14"	RG59U Cable (cut to length)
22.741	G3	1	Line cord and plug
22.113-1	G4-10	7	Rubber Grommet 9/16 OD
22.113-5	G11-15	5	Rubber Grommet 11/32 O.D.
22.742	F1	1	5 AMP 3AG Type or MTH Type 250 Volt Fuse
42.24-77	G16	8 in.	.034 ID Black extruded plastic tubing
42.24-107	G17	5 in.	.133 ID Black extruded plastic tubing
26.231	W1	1	Wiring Harness
71.91-100	W2	13 1/2 ft.	Black Plastic Covered #20 Hookup wire
71.27-125	W3	7 ft.	#24 Tinned Copper Wire
71.27-110	W4	4 ft.	#14 Tinned Copper Wire
71.49-105	W5	1/2 ft.	#20 Stranded Shielded Wire
42.49-140	W6	6 ft.	#4 Waxed Lacing Cord
22.21	I1	1	#6S6 120 Volt candelabra Bulb
22.743	I2	1	#40 6-8 volt Min. Screw Bulb
119-852	TC 1-4	4	.360 Tube Cap
22.744	J1	1	PCLM Mic. Connector
22.224	J2	1	Ckt. Closing Jack
22.746	J 3-4	2	83-1R Receptacles
126-105	J5	1	Socket (Crystal Holder)
23.1031	J6	1	Plug relay connection
22.747	H1 H2	2	83-1H Hood
23.914-1	SH1-SH2	2	100 M.V. Shunt for 500 ma
22.711	SH3 SH4	2	100 M.V. Shunt for 25 ma (5.1 ohm-5% tolerance)
22.712	SH5	1	100 M.V. Shunt for 50 ma (2.2 ohm-10% ")
22.748	L1	1	10 h 350 ma Filter Choke SNC #P1783
22.749	L2	1	15 h 95 ma Filter Choke SNC #P1501
22.750	L3	1	10 h 35 ma Filter Choke SNC #P1784
23.902-1	L4	1	Oscillator Coil
23.902-2	L5A	1	Buffer Coil
23.913	L5B	1	H.F. Buffer Coil
102-750	L6	1	#750 R.F. Choke
102-754-2	L7	1	#754 R.F. Choke

23.911	L8	1	Residual H.F. Final Coil
229-201	L9	1	Final Tuning Inductor, variable
23.902-3	L10	1	160 Meter Aux. Coil
23.912	L11 L12	2	Parasitic Suppressor
23.1001	L13	1	Line Filter, VHF Choke Assembly
23.1000	L14 L16 L19	5	VHF Filter Chokes
	L20 L21		
23.1002-1	L23	1	Filament VHF filter choke
22.751	T1	1	H.V. Plate Transformer SNC #1781
22.752	T2	1	L.V. and Fil. Transformer SNC #1893
22.753	T3	1	Audio Driver Transformer SNC #1503
22.754	T4	1	Modulation Transformer SNC #1992
22.755	SW1	1	SPTS (6A-125V) Bat Handle Toggle Switch
22.756	SW2	1	DPDT (6A-125V) Bat Handle Toggle Switch
22.886	SW3	1	4 Pole 2 Pos. (CW-PH) Switch
22.758	SW4	1	2 Pole 6 Pos. (Band) Switch
22.759	SW5	1	1 Pole 7 Pos. (Coupling) Switch
22.760	SW6	1	2 Pole 2 Pos. (160M) Switch
22.761	SW7	1	2 Pole 6 Pos. (Meter) Switch
22.628	SW8	1	1 Pole 11 Pos. (Crystal) Switch
167-104-3	C22	1	75L15 Variable Condenser
167-104-4	C18	1	75L15 Variable Condenser
154-2-3	C29	1	350E20 Variable Condenser
154-34-3	C30	1	400E15 Variable Condenser
22.763	C1 C54	2	10 mfd 25 V.W. Electrolytic Condenser
22.764	C10 C11	1	Dual 15-15 mfd 450 V.W. Electrolytic Cond.
22.765	C12 C13	1	Dual 15-15 mfd 150 V.W. Electrolytic Cond.
22.835	C7	1	.001 mfd 400 V.W. Paper Condenser
22.766	C2	1	.003 mfd 400 V.W. Paper Condenser
22.767	C3	1	.02 mfd 400 V.W. Paper Condenser
22.768	C4 C56	2	.1 mfd 400 V.W. Paper Condenser
22.769	C8	1	.5 mfd 600 V.W. Paper Condenser
22.771	C9	1	8 or 10 mfd 1000 V.W. Condenser
22.772	C36 C37	2	300 mfd 600 V.W. Mica Condenser
22.773	C14	1	50 mmfd 500 V.W. Molded Mica Condenser
22.774	C33 C34 C35	4	300 mmfd 500 V.W. Molded Mica Condenser
	C52		
22.827	C15-17 C19	22	.005 mfd 600 V.W. Ceramic Disc Condenser
	C21 C23 (2)		
	C24 C26-27		
	C39-44 C47-51		
	C53		
22.776	C20	1	50 mmfd 500 V.W. Silver Mica Condenser
22.777	C25	2	25 mmfd 500 V.W. Silver Mica Condenser
22.778	C38	1	150 mmfd 1200 V.W. Mica Condenser
22.828	C28 C45	2	.001 mfd 1500 V.W. Ceramic Disc Cond.
22.836	C31	1	.002 mfd 1500 V.W. Ceramic Transmitting Type Condenser
22.826	C32 C46 C55	3	.01 mfd 1500 V.W. Ceramic Disc Cond.
22.719	R1 R32	2	1 megohm - 1/2 Watt Carbon or Composition Resistor
22.715	R24 R2	2	1800 ohm - 1/2 Watt Carbon or Composition Resistor

22.718	R3 R29	2	.47 - 0.51 megohm - 1/2 watt Carbon or Composition Resistor
22.716	R5 R26 R37	3	22,000 ohm - 1/2 Watt Resistor
22.830	R10 R11	2	100 ohm - 1/2 Watt Resistor
22.572	R18	1	.1 Megohm - 1/2 Watt Resistor
22.713	R22 R33 R34	3	22 ohm - 1/2 Watt Carbon Resistor
22.717	R23	1	47-51,000 ohm - 1/2 Watt Resistor
22.801	R31	1	450 to 510 ohm - 1/2 Watt Carbon or Composition Resistor
22.722	R15	1	1500 ohm - 1 Watt Resistor
22.721	R16	1	820 ohm - 1 Watt Resistor
22.724	R17	1	2700 ohm - 1 Watt Resistor
22.853	R19	1	68,000 ohm - 1 Watt Resistor
22.720	R20	1	100 ohm - 1 Watt Resistor
22.725	R21	1	4700 ohm - 1 Watt Resistor
22.832	R6 R30	2	1.0 Megohm Linear Potentiometer
22.732	R25	1	25,000 ohm W. W. Potentiometer
22.729-1	R13	1	20,000 ohm W.W. adjustable Resistor
22.833	R28	1	20,000 ohm W.W. Fixed Resistor
22.914	R35	1	56 ohm 1 Watt Carbon or Composition Resistor
22.871	R36	1	10,000 ohm \pm 10% 2 Watt Carbon or Composition Resistor
22.762-2	M1	1	5 ma meter 20 ohm Special Scale
22.780	V1 V2 V6	3	6AU6 Tubes
22.783	V3 V4	2	807 Tubes
22.781	V5 V28	2	6AQ5 Tube
22.788	V7 V17	2	6146 Tubes
22.784	V8 V9	2	5R4GY Tubes
22.791	V10	1	5V4G Tube
22.786	V11	1	6AL5 Tube



REPRESENTATIVES:

Atlanta 5, Ga., James Millar Associates, 1036 Peachtree St., N. E., ELgin 0919

Boston 6, Mass., Paul R. Sturgeon, 25 Huntington Ave., COpley 7-2562

Chicago 31, Ill., Ellinger Sales Co., 6540 Northwest Highway, ROdney 3-1570

Columbus 15, Ohio, Wm. E. McFadden, 150 East Broad St., MAIn 3363

Denver 3, Colo., Ronald G. Bowen, 825 Broadway, Rooms 307-309, ACOma 5211

Highland Park 3, Mich., A.B.M. Sales Company, 15850 Third Ave.,
TOWnsend 8-0044

Kansas City 8, Mo., Herbert A. Roes & Co., 2601 Cherry St., HAarrison 2036

Los Angeles 15, Calif., Don C. & Wm. H. Wallace, 1206 Maple Ave.,
Bendix Building, Richmond 7-0401

Minneapolis 1, Minn., Fred B. Hill Co., 256 1st Ave. No., MAIn 8353

New York 16, N. Y., F. Edwin Schmitt Co., 136 Liberty St., WOOrth 2-6550

Philadelphia 2, Pa., S. K. MacDonald, Inc., 1531 Spruce St., KIngsley 5-1205

Phoenix, Ariz., Harry A. Moore Sales Co., 4142 North 18th St., AMherst 5-4662

Pittsburgh 22, Pa., S. K. MacDonald Inc., 715 State Theatre Building,
335 Fifth Ave., ATLantic 1-2253

Portland 10, Ore., Dave M. Lee Co., 2712 N. W. Raleigh St., BEacon 2241

San Francisco, Calif., Logan Sales Co., 530 Gough St., HEmlack 1-5127

Seattle 1, Wash., Dave M. Lee Co., 2517 Second Ave., MAIn 5512

Syracuse 4, N. Y., Wally B. Swank, 2310 Bellevue Avenue, 74-8056

Washington, D. C., S. K. MacDonald Inc., 217 Riggs Bank Building,
3308 14th St., N. W., COlumbia 3938

CANADA

Toronto 12, Ont., A. C. Simmonds & Sons Ltd., 100 Merton St., MAyfair 9111

EXPORT

New York 7, N. Y., M. Simons & Son Co., 25 Warren St., BArdlay 7-5513
Cable Address—Simonrice

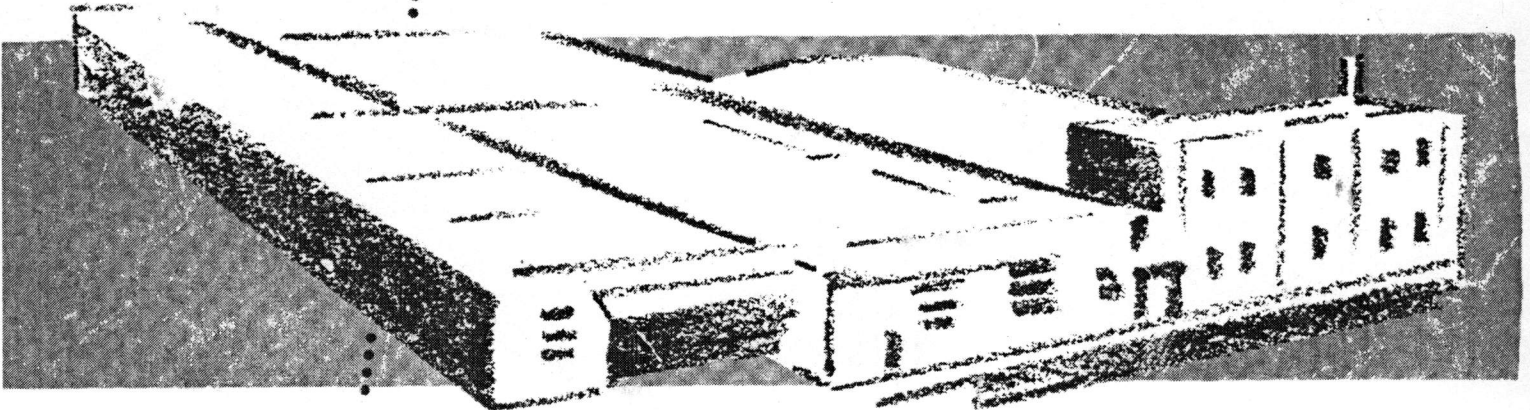

E. F. JOHNSON COMPANY

WASECA, MINNESOTA • U. S. A.