

### **To Customers**

**Thank you very much for using our FM VHF/UHF Two Way Radio. This radio of modern design is reasonable structure with stable functions. It is designed to meet customer's needs for the high quality with easy operation and perfect capability.**

**We believe you are pleased with the finished shape and the reasonable price.**

**This manual is suitable for using the model of PX888.**

**Downloaded by  
RadioAmateur.EU**

## Contents

Maintenance - - - - -	1
Features - - - - -	1
Main indicators/controls - - - - -	2
Main indicators/controls-description - - - - -	3
LCD display - - - - -	4
Basic operations - - - - -	5-12
Store/Delete - - - - -	13-14
Advanced Operationsz - - - - -	15-25
Enclosed chart - - - - -	26
Troubleshooting Guide - - - - -	27

## UNPACKING AND CHECKING EQUIPMENT

Carefully unpack the radio. We recommend that you identify the items listed in the following table before discarding the packing material. If any items are missing or have been damaged during shipment, file a claim with the carrier immediately.

### Supplied Accessories

ITEMS	QUANTITY
Radio	1
Antenna	1
Battery	1
Charger	1
Belt Clip	1
User's Manual	1

### Optional Accessories

ITEMS
Earphone
Microphone
Connecting cable
Programmable software

## Maintenance

Your Two Way Radio is an electronic product of exact design and should be treated with care. The suggestions below will help you to fulfill any warranty obligations and to enjoy this product for many years.

- Do not attempt to open the unit. Non-expert handling of the unit may damage it.
- When using regulated power supply, take notice of power voltage must be between 6V and 8V to avoid damaging the unit.
- Do not store the Radio under the sunshine or in hot areas. High temperatures can shorten the life of electronic devices, and warp or melt certain plastics.
- Do not store the Radio in dusty, dirty areas.
- Keep the Radio dry. Rainwater or damp will corrode electronic circuits.
- If it appears that the Radio diffuses peculiar smell or smoke, please shut off its power immediately and take off charger or battery in the Radio, then contact with local agency.
- Do not transmit without antenna.

## Features

- VHF 5W/UHF 4W Output power
- Two lines dot-matrix display
- Double channel watch
- 128 groups of memory channels
- Automatic Numbering Identification (ANI) code
- Built-in Voice Operate Transmit (VOX) function
- All channels scan and priority channel scan
- Scrambler
- Emergency alarm
- Programmable by pc with software
- 50 CTCSS and 104 DCS Normal/Inverted selectable
- Time-out Timer (TOT)
- Busy channel lockout
- 2 tone/MSK/DTMF encode and decode
- Built-in FM radio receiver

## Main indicators/controls

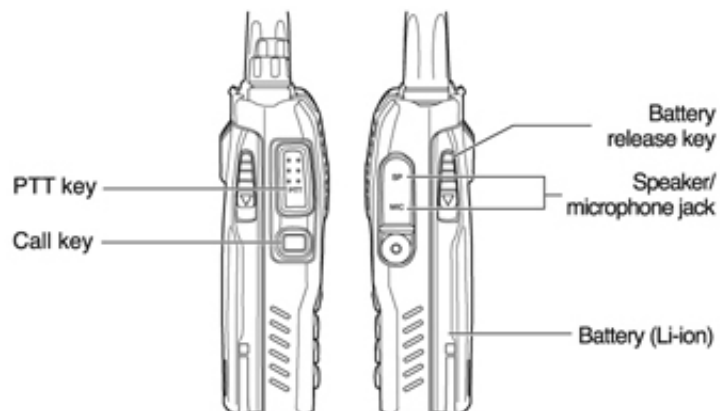
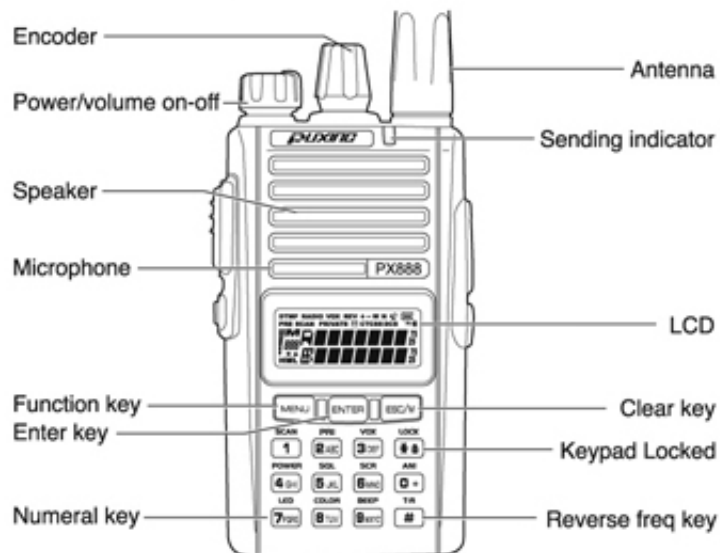



## Main indicators/controls-description

### Key, Knob, Switch, Indicator

■ Power/volume On-off	To turn on/off the radio and adjust the volume level.
■ Sending indicator	When the PTT is pressed, it glows to indicate the transmitting status.
■ Busying indicator	When the channel is busy, the display shows 
■ PTT key	When pressed, it enables the transmission
■ ESC/M	To exit the menu and to switch from Channel mode to Frequency mode.

### Socket and connector









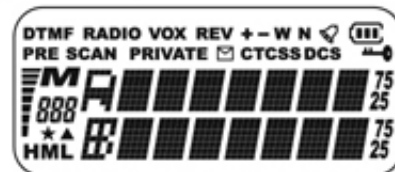





■ SMA Connector	For connecting the supplied antenna
■ Speaker/microphone jack	If you want to use a speaker or a microphone, connect them to this socket. If not, prevent water from dropping into it.

**Downloaded by  
RadioAmateur.EU**

## LCD display

Many icons are shown on the display when the radio is on. The following table can help you to identify each of them.



■ 	Battery level indicator
■ 	Shows the TX offset direction in relation to the Rx frequency
■ 	Power level indicator (HI=High/LO=Low)
■ 	Keypad locked
■ 	Display when DCS is turned on
■ 	CTCSS turned on
■ 	VOX turned on
■ 	Call Function
■ 	Display reverse frequency
■ 	Priority scan activated
■ 	Received signal strength and TX power
■ 	Frequency in use
■ 	Function menu
■ 	Priority channel
■ 	Displays narrow or wide band

## Basic operations

### Supplied antenna

Insert the base of the supplied antenna into the SMA connector and rotate it clockwise. Make sure the antenna has set down. Take out the antenna from the base by rotating it counter-clockwise rotation.

### Turn on and off the power

If you want to turn on the power, rotate the PWR/VOL knob clockwise until a beep sound is heard .All icons and frequencies appeared on the screen. You can adjust your desired volume by turning the knob.

To turn off the power, rotate the PWR/VOL knob counter-clockwise rotation. All the icons on the display will disappear and the radio is off.

### Adjusting volume

After turning on the radio, rotate the PWR/VOL knob clockwise to increase the volume and counter-clockwise to decrease.

### Transmitting/Receiving

Firstly, hold down briefly the MONI button to make sure that the frequency is not busy and then press the PTT. Speak 4/10cm far from the unit.

The TX indicator lights up.

Release the PTT key to receive.

### Emergency Alarm

Hold down the CALL key which was defined as emergency alarm, the radio will switch to emergency alarm and send ANI.

### Keypad Lock

To Lock or unlock the buttons.

In channel/Frequency mode, press and hold down  key for two seconds. The keypad will Lock.

Repeat the same procedure to unlock it.

### Setting Reverse Frequency Function





This function is possible only when you are linked to a repeater:

It permits to invert the TX frequency with the RX frequency.In Channel/Frequency mode, hold down  for two seconds until "REV" appears on the display. Repeat the same procedure to return to the previous frequency setting.

### Scanning

The Scan version is very useful to monitor the channels before transmitting.

### Scan all the channels

In Channel/Frequency status, press  +  +  . The radio will scan from the channel in use through all the channels, whenever any activity is detected, the radio will suspend the scan for 5 seconds. It will then continue to scan unless you press PTT or  key to end scanning. Otherwise it continues to scan until you press any key.





### Priority channel scan

In Channel Mode, **MENU** + **2 sec** + **ENTER** the radio will always scan priority channel. For example, if channel 3 is priority channel, the radio will scan like this: 3 → 1; 3 → 2; 3 → 3; 3 → 4; 3 → 5.

### Select scan type

Press **MENU** and rotate the Encoder until the display shows "SCANS ?". Press **ENTER** and turn the Encoder knob again to select the scan type (TO/CO/SE). Confirm your selection with **ENTER** and exit by pressing **SCAN** twice.

#### ■ TO: Time-operated scan

Even though the channel is busy, radio locks on a busy channel for a period of 5 seconds, it will continue scanning the other channels.

#### ■ CO: Carrier-operated scan

The radio stops on a busy channel until there is no activity, there is 2 seconds interval time and then radio begins scanning the other channels.

#### ■ SE: Search scan

The radio stops on a busy channel and exits the Scan mode.

### Flank keys

#### Call key defined as:

- 1) Optional tones (DTMF , 2-Tone, MSK)
- 2) Emergency call
- 3) Send 1750HZ tone
- 4) Moni

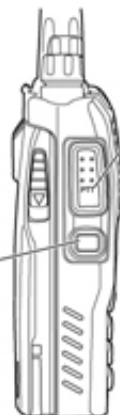

PTT : Press PTT to send singal and release it to receive

### DTMF Encode and Decode

The radio can get the function of selective call, group call and broadcast call via DTMF tone. This function can be set by your dealer.

#### DTMF CALL

##### 1. Two ways to call via DTMF manually

- 1) Press and hold PTT and input keypad numbers, 0-9 , a-d , \* and # available.
- 2) Press  into the "DTMF IN" then input the number you want. The numbers you can input are : 0-9, a-d , \* and # . You can turn channel selector to delete or exit. Then press PTT to call.

##### 2. Auto-dial

You need store the DTMF code(max 16 numbers) in nine different memory position for auto dial. Press [CALL]+ Number (1- 9) to dial the preset numbers automatically.

#### DTMF RECEIVE

When you receive the correct tone signal, the squelch will be cut off and you can receive a call or send a call.

1. When receive the single tone, the radio will sound "d ū d ú d ũ d ù" for response. It indicates that call is successful.
2. When receive the group call tone, the radio will ring. You can press [PTT] key to send message or receive message. The function of selective call, group call, and broadcast call can be enable/disable by dealers.

### 2-Tone encode and decode

1. 2-tone call: When [CALL] key defined as 2-tone, press [CALL] key to send a 2-tone.
2. 2-tone encode: There are 32 groups of 2 tone encode and 8 groups of 2-tone decode which can be set by dealer.

#### 2-Tone receive

When radio receive the correct 2-tone, the radio will sound "d ū d ú d ũ d ù".

### MSK encode and decode

MSK encode and decode can be set by dealers, 9 groups in total. You can input 0-9, a-d , \* and # . You can set 4 numbers every group. MSK call: When [CALL] key defined as MSK,you can press [CALL] key to send a MSK.

MSK receive: When radio receive the correct MSK tone, the radio will sound "d ū d ú d ũ d ù".

#### Select Mode

Three modes (1) double channel mode (2)channel mode (3)frequency mode can be switch by pressing .

##### 1. Double channel mode

Hold down  and turn on the power, the radio can enter or exit the double channel mode .

When you enter this mode you will see A or B on the display. A indicates this channel can receive and transmit but the other channel can receive only. B indicates this channel can receive and transmit but the other channel can receive only.

A and B channel can be switched by press  + [PTT].

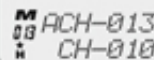

M  
03 ACH-013  
i CH-010

## 2. Channel Mode

There are three kinds of Channel Mode.  Shows that current channel is the fifth channel.

1) Show the channel name and channel number.

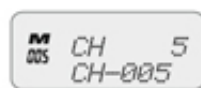

CH 5: indicate channel name, it can be edited by user.

CH-005: indicate the current channel is the fifth channel.

2) Show the channel name and the frequency



CH 5: indicate channel name, it can be edited by user.

455.00: indicate the frequency of the current channel.

3) The transmit and receive frequency of current channel

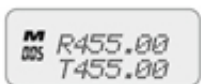

R 455.00: indicate the receive frequency of current channel.

T 455.00: indicate the transmit frequency of current channel.

## 3. Frequency mode

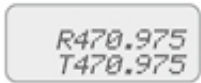

R 470.975: indicate the receive frequency

T 470.975: indicate the transmit frequency

The difference between channel mode and frequency mode is that if the left of the LCD show  .

## FM Radio Receiver Function

FM radio receiver was built-in the transceiver.

1) You can access to the radio receiver by pressing

 + SIDE KEY2.

You can input radio receivers frequency by keypad directly or rotate the channel selector with 100 kHz frequency adjustment.



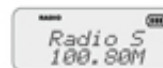

2 Store radio station channels: Press  + number key (0 to 9) to store the station you want.



3) Read a stored radio station, press  and the stored channel number to enter the pre-stored radio station.



4) Search: To search radio station frequency press "  " or "  ". When receive a signal it will stop searching and show the detected frequency on the LCD display.





## Store/Delete

### To store a frequency

To store a frequency and its settings (CTCSS, DCS, SHIFT REPEATERS etc) follow the procedure below:

1. At first, choose all the settings to store;
2. Press the **MENU** button;
3. Then, push **ESC/V** ;
4. Rotate the Encoder knob and select the memory number where you want to store the frequency and its settings;
5. Confirm your selection by pressing **ESC/V** ;

(**Note:**a triangle displayed underneath the channel number indicates that it has already been stored).

### Delete a memory

#### 1. Delete one store channel

In Channel Mode turn off the power.

Hold down the **ESC/V** key and turn on the unit.

"DEL?" and stored channel number will be displayed. Turn the Encoder knob or select the channel to delete. Push **ENTER** until "YES?" appears on the display; push it again to confirm or press **ESC/V** to exit.

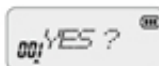

#### 2. Reset (Delete all the settings in Frequency mode)

Hold down the **MENU** and turn on the unit until "RESET?" is displayed. Press **ENTER** until "VFO?" is shown on the display; push it again for confirmation.



#### 3. Delete all settings

Hold down **MENU** and turn on the unit until display "VFO?" is shown on the display. Turn the Encoder knob to select "FULL ? ", then press **ENTER** to delete all the settings in Frequency and Channel mode.

 A rectangular display area showing the text "FULL ?" in a monospaced font.

## Advanced Operations

### Selecting the VOX sensitivity level

The VOX function is deactivated by default. To activate it follow the procedure here below:

1. Press the **MENU** button;
2. Turn the Encoder knob until the display shows " <sub>003</sub> VOX? ";
3. Push the **ENTER** key;
4. Turn again the Encoder knob and select the desired VOX level (you can choose amongst 9 different levels);
5. Push the **ENTER** key again;
6. To exit, press twice **BACK** ;



To activate and select rapidly the VOX function, you can do it also by operating on the fast menu: press the **MENU** key and then **4** and follow the procedure above described starting from point 3.

Downloaded by  
RadioAmateur.EU

### Setting the transmission power

To select desired power level:

1. Press the **MENU** button;
2. Turn the Encoder knob until the display shows " <sub>004</sub> POWER? ";
3. Push **ENTER** ;
4. Turn again the Encoder knob and select the desired power level (you can choose between 2 levels: "H" and "L" ); press **\*** to increase power and press **#** to decrease power;
5. Press **ENTER** ;
6. Press twice the **BACK** knob to exit;





To activate and select rapidly the power level, you can also use the fast menu: press the **MENU** key and then **4** and follow the procedure above described starting from point 3.

### Setting squelch

To select the squelch level:

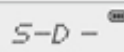
1. Press the **MENU** button;
2. Turn the Encoder knob until " <sub>005</sub> SQL ? " is displayed;
3. Push **ENTER** ;
4. Turn the Encoder knob and select the desired squelch level (9 different levels are available);
5. Press **ENTER** ;
6. Press twice the **BACK** knob to exit;

To activate and select rapidly the squelch level, you can also use the fast menu: press the **MENU** key and then **5** and follow the procedure above described starting from point 3.

### Scrambler on/off

To activate the scrambler, follow this procedure:

1. Press the **MENU** button;
2. Turn the Encoder knob until "006 SCRM ?" is displayed;
3. Push **ENTER** ;
4. Turn the Encoder knob and activate/deactivate the scrambler (ON=activated; OFF=deactivated);
5. Press **ENTER** ;
6. Press twice the **ESC/W** knob to exit;

To activate/deactivate rapidly this function, you can also use the fast menu: press the **MENU** key and then **6 FWD** and follow the procedure above described starting from point 3.

### Backlight on/off

To select the LCD backlight, follow this procedure:

1. Press the **MENU** button;
2. Turn the Encoder knob until "007 LED ?" is displayed;
3. Push **ENTER** ;
4. Turn the Encoder knob and activate/deactivate the function: 3 different options are available (AUTO, ON, OFF);
5. Press **ENTER** ;
6. Press twice the **ESC/W** knob to exit;

To activate/deactivate rapidly the backlight, you can also use the fast menu: press the **MENU** key and then **7 ZPD** and follow the procedure above described starting from point 3.



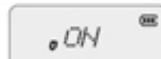



### Select backlight color

To activate the backlight colour:

1. Press the **MENU** button;
2. Turn the Encoder knob until "008 LIGHT " is displayed;
3. Push **ENTER** ;
4. Turn the Encoder knob and choose the desired colour (3 different colours are available);
5. Press **ENTER** ;
6. Press twice the **ESC/W** knob to exit;

To select it rapidly, you can also use the fast menu: Press the **MENU** key and then **8 REV** and follow the procedure above described starting from point 3.

### Beep on/off

The keypad beep is activated by default. To deactivate it:

1. Press the **MENU** button;
2. Turn the Encoder knob until "009 BEEP " is displayed;
3. Push **ENTER** ;
4. Turn the Encoder knob and activate/deactivate the beep (ON=beep enabled; OFF=beep disabled);
5. Press **ENTER** ;
6. Press twice the **ESC/W** knob to exit;

To activate/deactivate rapidly the keypad beep, you can use the fast menu: Press the **MENU** key and then **8 REV** and follow the procedure above described starting from point 3.

### Automatic Numbering Identification (ANI) on/off

You can set an automatic number identifier visible from the radio's display of your partner each time you send a call signal.

To activate this function:

1. Press the **MENU** button;
2. Turn the Encoder knob until "010 ANI" is displayed;
3. Push **ENTER** ;
4. Turn the Encoder knob and activate/deactivate the function. (ON=activated; OFF=deactivated;)
5. Press **ENTER** ;
6. Press twice the **ESC/N** knob to exit;



To activate/deactivate this function, you can also use the fast menu: press the **MENU** key and then **0** and follow the procedure above described starting from point 3.

### Repeater shift (for communications through repeaters)

To activate this function, follow these steps:

1. Press the **MENU** button;
2. Rotate the Encoder knob until "019 S-D?" is displayed;
3. Push **ENTER** ;
4. Turn the Encoder knob and select the repeater shift. You can choose amongst the following options +, - and 0;
5. Press **ENTER** again;
6. Press twice the **ESC/N** to exit;





To select the repeater shift, you can also use the fast menu: press the **MENU** key and then **0** and follow the procedure above described starting from point 3.



### Repeater shift adjustment (for communications through repeaters)

1. Press the **MENU** button;
2. Rotate the Encoder knob until "015 DIFFR?" is displayed;
3. Push **ENTER** ;
4. Turn the Encoder knob and select the repeater shift. You can also enable it by inputting the frequency directly on the keypad;
5. Press **ENTER** ;



### Select the frequency step

1. Press the **MENU** button;
2. Rotate the Encoder knob until "020 STEP?" is displayed;
3. Push **ENTER** ;
4. Turn the Encoder knob and select desired frequency step. You can choose amongst: 5KHz, 10KHz, 6.25KHz, 12.5KHz and 25KHz;
5. Press twice the **BGM** key to exit;



### Select CTCSS and DCS tones

To select a CTCSS tone

1. Press the **MENU** button;
2. Rotate the Encoder knob until "016 C-CDC" is displayed;
3. Push **ENTER** ;
4. Turn the Encoder knob and select the desired subaudio tone;
5. Press **ENTER** to confirm;

To select a DCS tone:

1. Select "016 C-CDC" either with the Encoder knob or with fast access;
2. Push **ENTER** ;
3. Press the **FS** button;
4. Turn the Encoder knob and select the desired DCS level;
5. Press **ENTER** again for confirmation;

While selecting the DCS codes, if you press **#** , you will select the normal (N) or inverted (I) DCS codes.

### Voice function (Both in English and Chinese)

With this function, you activate a voice that informs about any operation/selection you are doing. To activate it. Follow these steps:

1. Press the **MENU** button;
2. Rotate the Encoder knob until "014 VOICE?" is displayed;
3. Push **ENTER** ;
4. Turn the Encoder knob and activate/deactivate the function. (ON=enable; OFF=disable);
5. Press **ENTER** again;
6. Press twice the **BGM** knob to exit;

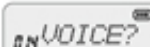

**Notice:** The programming software can program the Chinese or English voice.

### Menu Operation

To operate with all the parts/settings of the menu, you have to follow these general steps:

1. Press the **MENU** button.
2. Turn the Encoder to select the desired menu.
3. Press **ENTER** and turn the Encoder to choose the desired settings.
4. Press **ENTER** to confirm.

## Menu Operation List

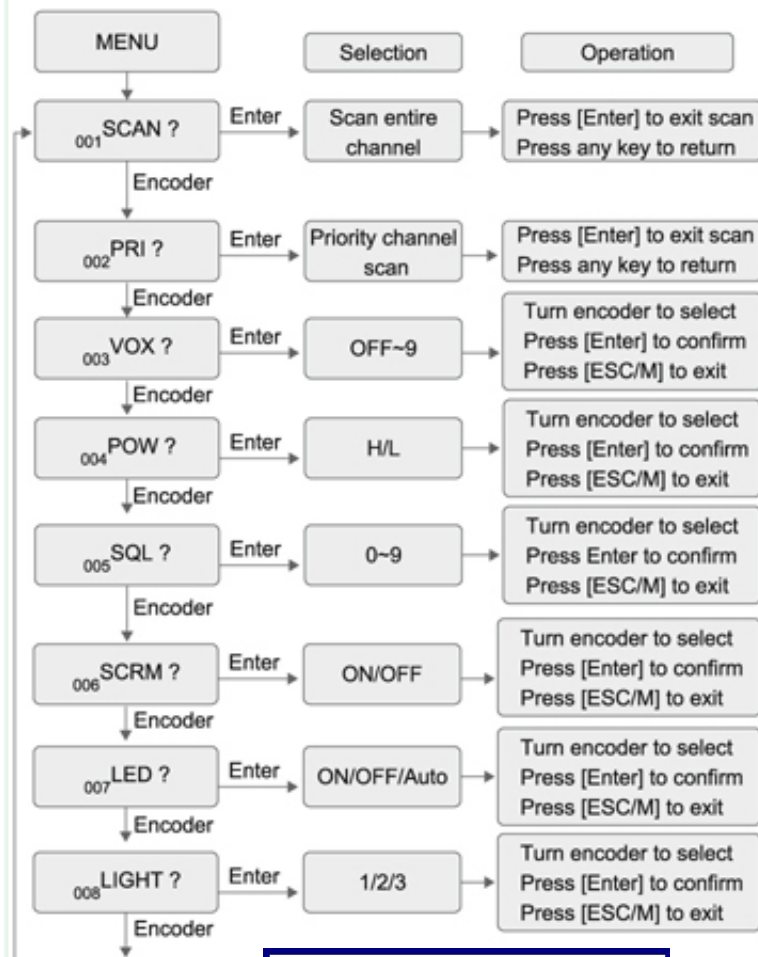

Downloaded by  
RadioAmateur.EU

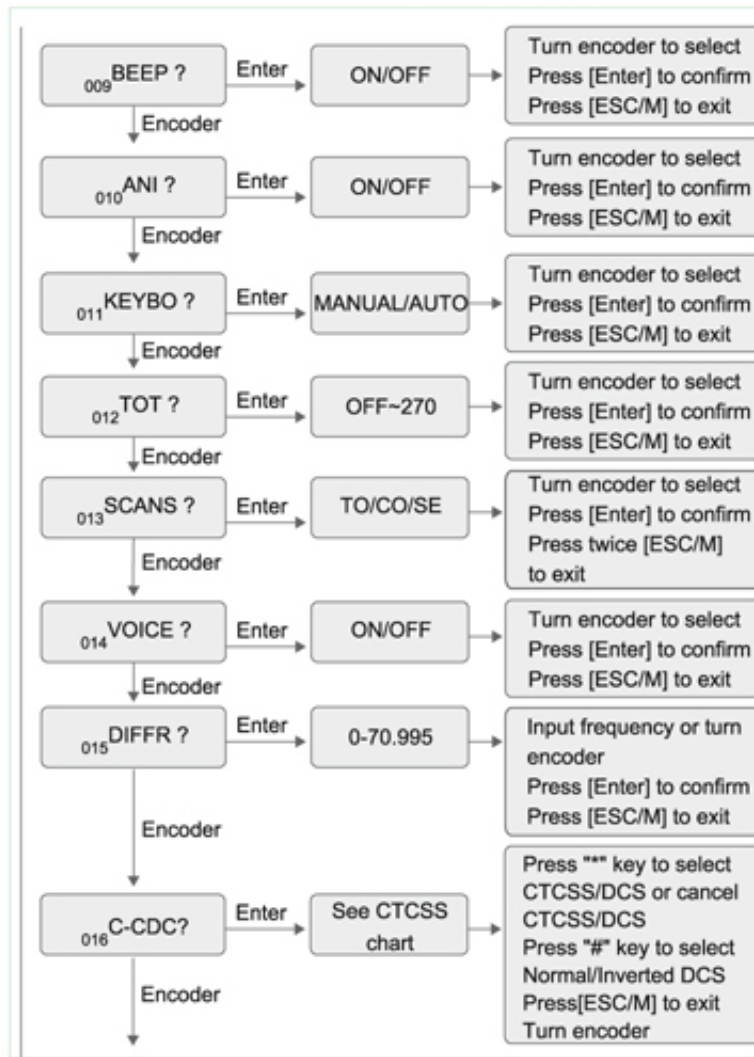

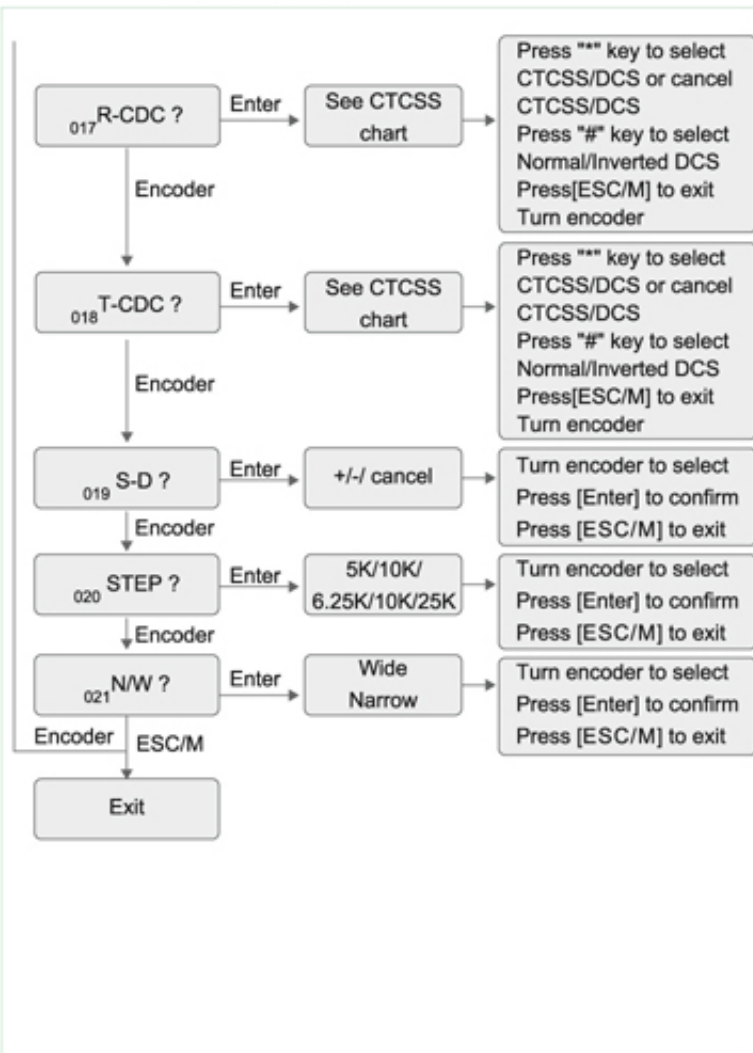

## Enclosed chart

50 CTCSS frequency code (Hz)

67.0	85.4	107.2	136.5	165.5	186.2	210.7	254.1
69.3	88.5	110.9	141.3	167.9	189.9	218.1	
71.9	91.5	114.8	146.2	171.3	192.8	225.7	
74.4	94.8	118.8	151.4	173.8	196.6	229.1	
77.0	97.4	123.0	156.7	177.3	199.5	233.6	
79.7	100.0	127.3	159.8	179.9	203.5	241.8	
82.5	103.5	131.8	162.2	183.5	206.5	250.3	

104+1 DCS code

023	065	132	205	255	331	413	465	612	723
025	071	134	212	261	332	423	466	624	731
026	072	143	223	263	343	431	503	627	732
031	073	145	225	265	346	432	506	631	734
032	074	152	226	266	351	445	516	632	743
036	114	155	243	271	356	446	523	645	754
043	115	156	244	274	364	452	526	654	
047	116	162	245	306	365	454	532	662	
051	122	165	246	311	371	455	546	664	
053	125	172	251	315	411	462	565	703	
054	131	174	252	325	412	464	606	712	



## TROUBLESHOOTING GUIDE

PROBLEM	SOLUTION
No Power	<ul style="list-style-type: none"> <li>• The battery pack may be dead.Recharge or replace the battery pack.</li> <li>• The battery pack may not be installed correctly. Remove the battery pack and install it again.</li> </ul>
Battery power dies shortly after charging	<ul style="list-style-type: none"> <li>• The battery pack life is finished.Replace the battery pack with a new one.</li> </ul>
Cannot talk to or hear other members in your group	<ul style="list-style-type: none"> <li>• Make sure you are using the same frequency and CTCSS/DCS tone as the other members in your group.</li> <li>• Other group members may be too far away. Make sure you are within range of the other radios.</li> </ul>
Other voices (besides group members) are present on the channel.	<ul style="list-style-type: none"> <li>• Change the CTCSS/DCS tone. Be sure to change the tone on all radios in your group.</li> </ul>

**Downloaded by  
RadioAmateur.EU**