



STANDARD

TWIN BANDER

C568/C568A/C568S

Twin band FM Transceiver

OWNER'S MANUAL

Thank you for purchasing our Transceiver.

To use this Transceiver correctly, please read this manual thoroughly before uses.

Keep this manual handy for reference.



MARANTZ JAPAN, INC.

INTRODUCTION page 3

BASIC OPERATIONS page 7

ADVANCED OPERATIONS page 17

MEMORY FUNCTIONS page 25

SCAN page 31

REPEATER OPERATIONS page 41

ADDITIONAL FUNCTIONS page 45

GROUP FUNCTIONS page 53

REFERENCE page 69

How to use this manual

This Transceiver covers both VHF and UHF bands. This manual's descriptions are based on the UHF (430 MHz) band of C568S.

This manual uses the following symbols.



An item requiring special attention or strict compliance.



Useful advice or suggestions.



Reference to another page.



Set mode.
(Set mode is a list of menu options)



Function mode.



When the PTT switch is to be pressed.

This device complies with part 15 of the FCC Rules. Operation is subject to the following two conditions: (1) This device may not cause harmful interference, and (2) this device must accept any interference received, including interference that may cause undesired operation.

After Unpacking, Make Sure That the Following Items Are Included.

- | | |
|--------------------------------------|---|
| 1. Transceiver | 1 |
| 2. Owner's manual | 1 |
| 3. Block diagram | 1 |
| 4. Antenna (BNC type) | 1 |
| 5. Wall charger (CWC150A) | 1 |
| Attached to only the C568A | |
| 6. Ni-Cd battery pack (CNB171) | 1 |
| Attached to the C568A | |
| Battery case (CBT171) | 1 |
| Attached to the C568 or C568S | |
| 7. Tone squelch unit (CTN560) | 1 |
| Attached to only the C568A | |

DISPOSE THE Ni-Cd BATTERY

To dispose of the Ni-Cd (=Nickel-Cadmium) battery, check with your dealer for the requirements in your area. The battery must be recycled or properly disposed.



NI-Cd

Table of Contents

INTRODUCTION	3	MEMORY FUNCTIONS	25
Precautions	4	The Memory Function	26
Attaching the Antenna	5	Storing Memory	26
Battery Insertion and Removal	6	Recalling Memory	27
BASIC OPERATIONS	7	Changing the Memory	27
Turning the Transceiver On	8	Erasing the Memory	28
Adjusting the Volume	8	Changing Memory Temporarily (Memory Shift)	28
Adjusting the Squelch	9	Saving Various Modes in a Memory	29
Selecting the Main Band (Frequency Band)	9	Protecting Memory (Memory Protect)	29
VFO State	10	Inserting or Removing the Memory Unit	30
Receiving	10	About the Memory Unit	30
Transmitting	11	SCAN	31
Resetting the VFO (VFO Reset)	12	Scan Function	32
Resetting all Settings (All Reset)	12	Scan within 1 MHz (1MHz Scan)	33
Operation and Function of Parts	13	Scan the Entire Band Width (All Scan)	33
ADVANCED OPERATIONS	17	Scan a Specific Range (Program Scan)	34
Changing the Frequency Step	18	Scan Frequencies in Memory (Memory Scan)	34
Changing the Frequency in 100 kHz, 1 MHz or 10 MHz Steps	18	Scan Specific Memory Frequencies (Memory Scan Memory)	35
Using the CALL Frequency	19	Scan a Block (Block Memory Scan)	36
Changing the CALL Frequency	19	Scan Specific Memory Frequencies within Blocks	37
Changing the CALL Frequency Temporarily (CALL Shift)	20	Scan the Tone Frequency (Tone Squelch Scan)	37
Storing Associated Data with the CALL Frequency	20	Dual Watch	38
Using the Key Lock	21	Using the Dual Watch to VFO Frequency	
Using the Selector in the Key Lock Mode	21	and Memory Address M00	38
Using the SQL OFF	22	Using the Dual Watch to VFO Frequency	
Changing the Transmitting Power	22	and Other Memory Address	39
Turning Sub Band Off (Band Off)	23	Using the Dual Watch to VFO Frequency and Call Frequency	39
Changing the Band	23	Using the Dual Watch to VFO Frequency and Memory Scan	40
Changing the Set Mode Function	24	Changing the Dual Watch Time	40
Lighting the Display Lamp	24		

REPEATER OPERATIONS	41
Repeater Operation	42
Setting the Repeater Mode	42
Changing the Offset Frequency during Repeater Operation	43
Using a Repeater which Require a 1750 Hz Tone Burst	43
Reversing the Repeater Transmission/ Reception Frequency (Reverse)	44

ADDITIONAL FUNCTIONS	45
Preventing Unintentional Transmission (PTT lock)	46
Inputting 1kHz Digit on the Keypad	46
Using the Auto Power Off	47
Battery Save	47
Stopping the Transmission Automatically (Time-Out Timer)	48
Turning the Beep On or Off	48
Reducing Pop Noise when Squelch Is Opened	49
Muting the Sub-band (Sub-band mute)	49
Switching the External Speaker	50
Setting the Auto AM Reception Mode	50
Setting the AM Reception Mode Manually	51
Setting the Cross-band Repeater	51
Setting the Delay Time for Cross-band Repeater Transmission	52
Beep Sound	52

GROUP FUNCTIONS	53
Paging	54
Code-squelch	54
Setting the Individual Code	55
Setting the Code of Your Partner's Paging/ Code Squelch Codes	55
Setting a Group Code	56
Paging during Transmission	56
Paging during Reception	57
Paging without Voice	57
Delayed Paging Sending Time	58
Changing Beeps while in Paging / Wake-up	58

Using Code Squelch	59
Wake-Up	59
Setting Your Individual Wake-up Code	60
Setting Your Partner's Wake-up Code	60
Selecting the Wake-up Code's Digit	61
Waiting in Wake-up	61
Calling Wake-up	62
Using DTMF	63
Holding down the PTT Switch and Sending a DTMF Code	63
Storing the DTMF Code	64
Erasing a DTMF Code	64
Sending DTMF Memory Addresses	65
Confirming the Stored DTMF Code	65
Changing the Interval Sending Time of the DTMF Code	66
Using the Tone Squelch	66
Using the Tone Encode/Tone Squelch	67
Changing the Frequency of the Tone Signal	67

REFERENCES	69
Trouble Shooting	70
List of the Set Mode Functions	72
Options	73
Example of TNC (Packet Controller) Connection	73
Specifications	74
Index	75

INTRODUCTION

Precautions	4
Attaching the Antenna.....	5
Battery Insertion and Removal	6

Precautions

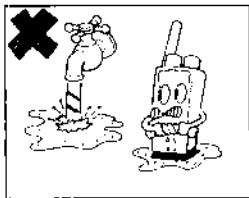

This Transceivers is water resistant. Avoid wet or humid places. If water is splashed on the Transceiver, wipe off the moisture with a dry cloth.

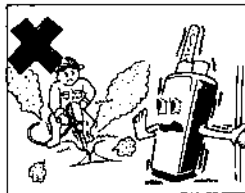

Avoid exposing the Transceiver to excessive vibrations. Avoid dusty places.

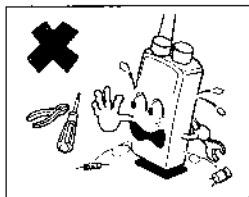

Never disassemble the Transceiver. Never touch the Transceiver's core. It is adjusted for optimum performance.

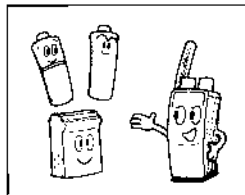

An applicable battery is either AA-size manganese/alkaline type or nickel-cadmium battery pack CNB170 series. Never use any other batteries.

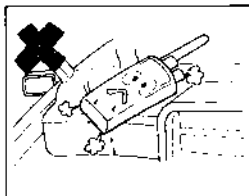

Avoid hot places and locations exposed to direct sunlight.

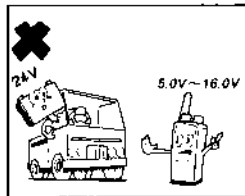

This Transceiver requires 5 to 16 volts DC. Never use voltage out of this range. If a voltage out of this range is used, the Transceiver may be damaged.

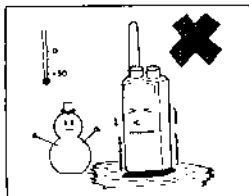

Avoid extremely cold places.

Attaching the Antenna

Attach the included antenna to the BNC antenna terminal. Place the antenna on the antenna terminal and turn the antenna base clockwise.

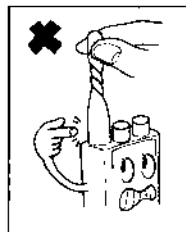
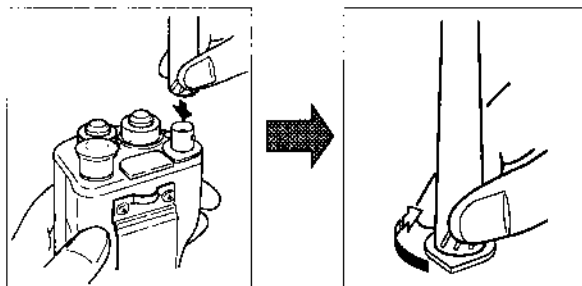

- ◆ Do not twist the top of antenna. Do not turn the antenna too fasten it.



- ◆ Do not carry the Transceiver by the antenna, this may cause intermittent operation.
- ◆ Do not transmit without an antenna. This could cause permanent damage.

Battery Insertion and Removal

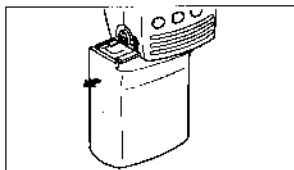

- 1 Slide the battery lock button up to release the battery case. Slide the battery case off.

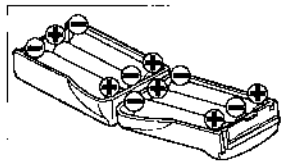

- 2 Open the battery case.
- 3 Confirm the location and polarity of the battery cells, and replace when required.

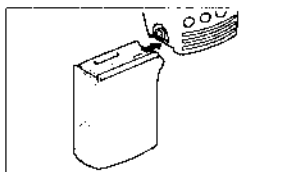

- 4 Close the battery case.
- 5 Slide the battery case onto the Transceiver.



- ◆ Never use an old battery cell and a new battery cell together.
- ◆ Never throw used batteries into a fire.
- ◆ Flashes on the outside of the battery indicate a voltage higher than the voltage suggested. If the voltage is higher than the suggested voltage the Transceiver may be damaged.



- ◆ A battery mark on the display indicates the following:



Supply voltage is 10.5 to 16 V.



Supply voltage is 4 to 10.5 V.

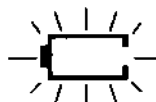

Supply voltage has reached 4 V or less. To continue use, recharge or replace the batteries. In this state, when a key is pressed a low pitched beep is sounded.

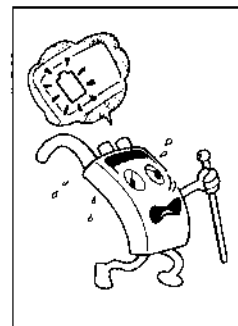

BASIC OPERATIONS

Turning the Transceiver On	8
Adjusting the Volume	8
Adjusting the Squelch	9
Selecting the Main Band (Frequency Band)	9
VFO State	10
Receiving	10
Transmitting	11
Resetting the VFO (VFO Reset)	12
Resetting all Settings (All Reset)	12
Operation and Function of Parts	13

Turning the Transceiver On

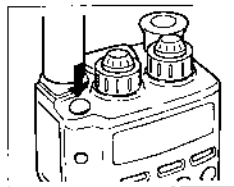

- 1 Push the **PWR** key for 0.5 seconds or more.

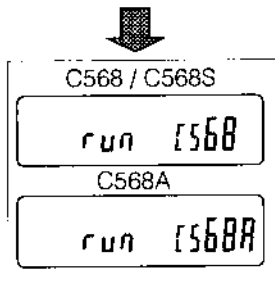

- 2 Power is confirmed by the display on the display panel and the power up sound. The initial frequencies are follows:

BAND	VHF	UHF
MODEL		
C568	146.00	433.00
C568A	146.00	446.00
C568S	145.00	433.00

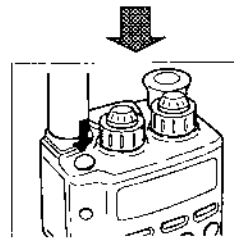

- 3 To turn off, press the **PWR** key for 0.5 seconds or more.



- ◆ If the Memory Unit is not installed, the display is not the same as shown in step 2, the frequency is displayed.

Adjusting the Volume

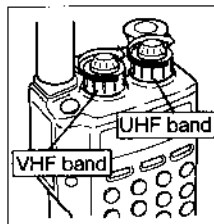

- 1 To increase the volume, turn the VOL knob clockwise.

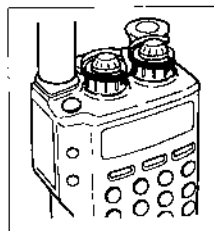

- 2 To decrease the volume, turn the VOL knob counterclockwise.



- ◆ Remember to reduce the volume before using the optional headsets.

Adjusting the Squelch

- When the FM Transceiver is not receiving a signal and the squelch control is fully counterclockwise, squelch noise will be sounded. The squelch control is used to cancel this noise.

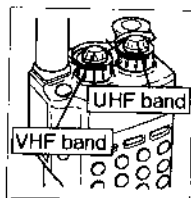

- 1 Slowly turn the SQL knob clockwise.

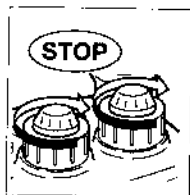

- 2 Stop immediately after the noise disappears.



- ◆ If the SQL knob is turned clockwise past the level in step 2, weak signals are not received.
"Squelch off": The noise appears when turning the SQL knob counterclockwise.
"Squelch on": The noise disappears when turning the SQL knob clockwise.
- ◆ In squelch on, the Transceiver can be changed to squelch off. (P.22)

Selecting the Main Band (Frequency Band)

- The main band is indicated by "MAIN". The main band can be switched from VHF to UHF. Changing the frequency, transmit and wake-up function are done in the main band.



- 1 Press the **MONO MAIN** key.
- 2 Confirm the main band has been switched.



- ◆ The sub band is the band not indicated by "MAIN".
The VHF band can receive and transmit 144.00 to 147.995 MHz (C568/C568A) 144.00 to 145.995 MHz (C568S)
The UHF band can receive and transmit 430.00 to 439.995 MHz and 1240.00 to 1299.99 MHz (C568/C568S) 438.00 to 449.995 MHz and 1240.00 to 1299.99 MHz (C568A)

VFO State

- The VFO (Variable Frequency Oscillator) is the state in which frequencies can be changed using the Rotary Channel Selector or the key pad. This is the state of the Transceiver when shipped and immediately after resetting.



1 Press the **[MONO MAIN]** key and select the main band.

2 Confirm the Indicator.



3 If "M" is displayed (Memory mode), press the **[ENT V/M]** key to return the VFO mode.



If "C" is displayed (Call mode), press the **[SFT CALL]** key to return the VFO mode.



If frequency is changed (Scan mode), press the **[* PS CL]** key to return the VFO mode.



If frequency is switching between two frequency (Dual-watch mode), press the **[* PS CL]** key to return the VFO mode.

4 Confirm the VFO.



- In memory mode or call mode, if the displayed frequency is a VFO frequency press the **[* PS CL]** key.

Receiving

- Receiving is the process of selecting a frequency to a desired channel and listening. This Transceiver has two methods that change the frequency.

Using the rotary channel selector

(Referred to as **Selector** in this manual)

1 Select the main band, and set to the VFO.



2 The frequency increases if the Selector is turned clockwise.



3 The frequency decreases if the Selector is turned counterclockwise.

Using the key pad

1 Select the main band, and set to the VFO.

2 Input, starting with a 100 MHz digit.



4- - - 43- - - 433- - 4332- 43320



- This Transceiver has a Quick Encoder, when the Selector is turned fast, the frequency changes accordingly.
- If there is a mistake while inputting a frequency using the key pad, press the **[* PS CL]** key to return the original value.

Transmitting

- By setting Transceivers to the same frequency and press the **PTT** switch, you can communicate directly with another party.

1 Set to the VFO.

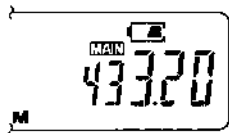

2 Turn the Selector to set the desired frequency.

3 Before transmitting confirm, the frequency is not being used by other parties.

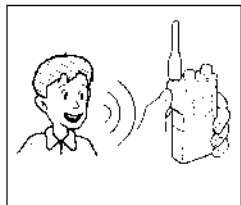

4 Hold down the **PTT** switch and speak into the microphone.

Resetting the VFO (VFO Reset)

- When this is done, the Transceiver is set to the VFO, and the Set mode is reset to its original state. If the original state is requested, use this function.

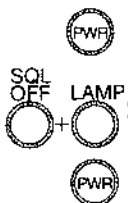

1 Press the **[PWR]** key to turn the power off.

2 Hold down the **[SQL OFF]** and **[LAMP]** key and press the **[PWR]** key.

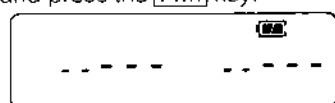

3 Release the keys, and confirm the display is in its original state.

Resetting all Settings (All Reset)

- When this is done, the Transceiver is set to its original factory state. All contents of the VFO and the memories are erased.

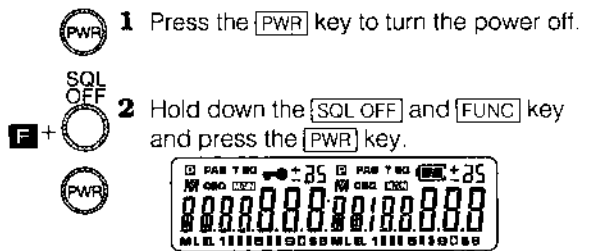

1 Press the **[PWR]** key to turn the power off.

2 Hold down the **[SQL OFF]** and **[FUNC]** key and press the **[PWR]** key.



3 Release the keys, and confirm the display is in its original state.

Operation and Function of Parts

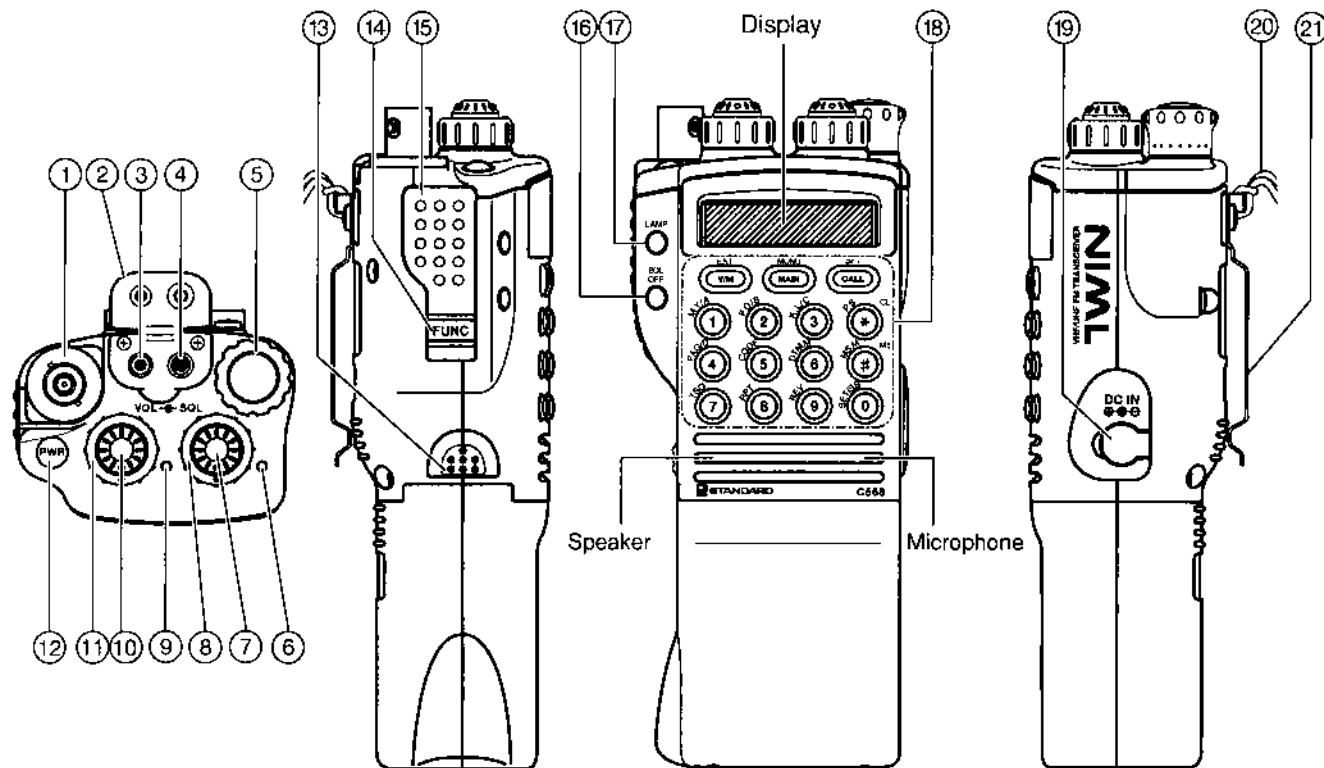

- ① **Antenna Connection Terminal (BNC type)**
To attach the antenna.
- ② **Microphone/Speaker Cap**
Ensure this cap is in place when not using the microphone or speaker terminals.
- ③ **MIC**
External microphone terminal.
To attach an optional microphone.
- ④ **SPK**
External speaker terminal.
To attach an optional speaker. If an external speaker is used, the audio from the VHF and UHF can be split between the internal and external speaker. (P 50)
- ⑤ **Rotary Channel Selector switch**
This is used to change the transmission and reception frequency (P 10). It is also used to turn on and off or select various settings.
Its Referred to as Selector in this manual.
- ⑥ **TX BUSY Indicator (UHF)**
Lit in red during transmission and green during reception or when the squelch is off in the UHF band.
- ⑦ **SQL (UHF)**
This is used to adjust squelch in the UHF band (P 9).
- ⑧ **VOL (UHF)**
This is used to adjust volume in the UHF band (P 8).
- ⑨ **TX BUSY Indicator (VHF)**
lit in red during transmissions and green during reception or when the squelch is off in the VHF band.
- ⑩ **SQL (VHF)**
This is used to adjust squelch in the VHF band.

- ⑪ **VOL (VHF)**
This is used to adjust volume in the VHF band.
- ⑫ **PWR key**
Press this key and the power supply is enabled or disabled.
- ⑬ **Battery Lock Button**
- ⑭ **FUNC key**
Hold down this key to enter the function mode: used in combination with another key, enables various other functions.
F: Function mode.
- ⑮ **PTT Switch**
When pressed, switches between transmit and receive.
PT: When the PTT switch is to be pressed.
- ⑯ **SQLOFF key**
Press this key and the squelch is opened.
F: Squelch off in sub band.
PT: Squelch off in sub band.
- ⑰ **LAMP key**
Press this key and the lamp lights the display for five seconds.
F: Lamp lock
- ⑱ **Keypad**
ENT V/M key
Press this key to switch between VFO and memory modes.
F: Sets clear memory.
F: Erases the memory while in memory mode.
PT: Sets DTMF memory sending mode.

MONO MAIN key

Press this key to switch the main band.

[F]: Sets the mono band.

SFT CALL key

Press this key to recall the CALL frequency.

[F]: Sets the shift mode.

1 MY/A key

Inputs of numeral 1

[F]: Recalls and stores the set modes.

(Dual watch is originally set when shipped)

[F]: Inputs A when in DTMF memory mode.

[PT]: Sends the DTMF signal 1.

2 PO/B key

Inputs of numeral 2

[F]: Changes the transmission power.

[F]: Inputs B when in DTMF memory mode.

[PT]: Sends DTMF signal 2.

3 K./L/C key

Inputs of numeral 3

[F]: Turns on/ off the key lock.

[F]: Inputs C when in DTMF memory mode.

[PT]: Sends DTMF signal 3.

4 PAG/D key

Inputs of numeral 4

[F]: Changes the paging and code squelch.

[F]: Inputs D when in DTMF memory mode.

[PT]: Sends DTMF signal 4.

5 CODE key

Inputs of numeral 5

[F]: Sets the paging code.

[PT]: Sends DTMF signal 5.

6 DTMF.M key

Inputs of numeral 6

[F]: Sets the DTMF code.

[PT]: Sends DTMF signal 6.

7 TSQ key

Inputs of numeral 7

[F]: Sets the tone encoder and tone squelch.

[PT]: Sends DTMF signal 7.

8 RPT key

Inputs of numeral 8

[F]: Turns on/off the repeater mode.

[PT]: Sends DTMF signal 8.

9 REV key

Inputs of numeral 9

[F]: Reverses the repeater transmitting or receive frequency.

[PT]: Sends DTMF signal 9.

0 SET/SB key

Inputs of numeral 0

[F]: Recalls the set mode.

[F]: Change the scan type.

[PT]: Sends DTMF signal 0.

*** PS CL**

To cancel previous function.

Inputs the asterisk (*) when in DTMF memory mode.

[F]: Starts or stops the scan.

[PT]: Sends the DTMF signal * .

MS.M MS

Starts the memory scan.

Inputs of # in DTMF memory mode.

[F]: marks the memory scan memory with ▼.

[PT]: Sends the DTMF signal #.

⑲ DC IN

External power supply connection terminal.
Ensure the Transceiver is off when plugging in or unplugging the external power supply.

⑳ Hand strap

㉑ Belt clip

Display Indications

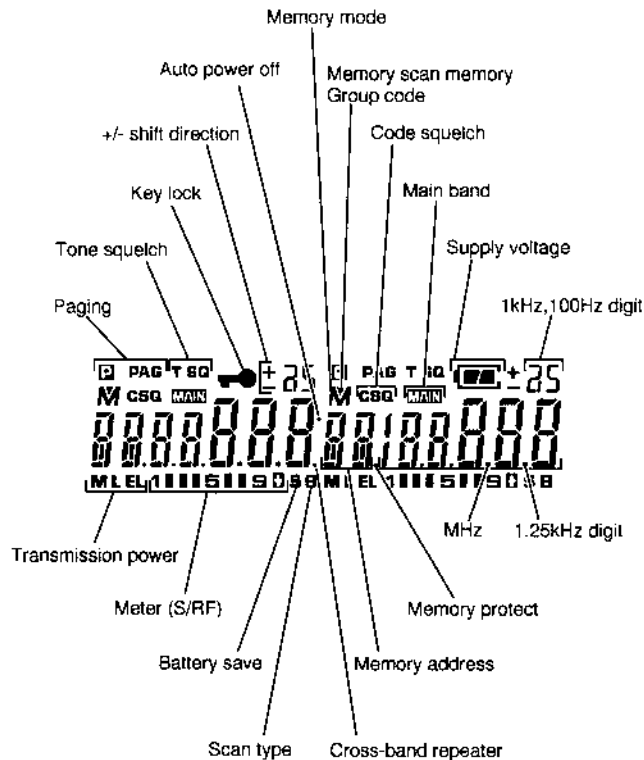



ADVANCED OPERATIONS

Changing the Frequency Step	18
Changing the Frequency in 100 kHz, 1 MHz or 10 MHz Steps	18
Using the CALL Frequency	19
Changing the CALL Frequency	19
Changing the CALL Frequency Temporarily (CALL Shift)	20
Storing Associated Data with the CALL Frequency	20
Using the Key Lock	21
Using the Selector in the Key Lock Mode	21
Using the SQL OFF	22
Changing the Transmitting Power	22
Turning Sub Band Off (Band Off)	23
Changing the Band	23
Changing the Set Mode Function	24
Lighting the Display Lamp	24



Changing the Frequency Step

- The factory settings are 5 kHz and 25 kHz (1.2 GHz band) in the set menu.

To change the frequency step:

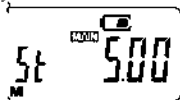

-  +  Hold down the **[FUNC]** key and press the **[0 SET/SB]** key.
-  Turn the Selector to change the Set menu display to "St 5.00".

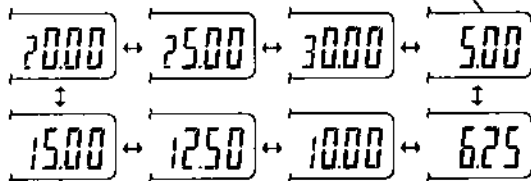

-  +  Hold down the **[FUNC]** key and turn the Selector to change the frequency step.

Short middle beep tone



-  +  Hold down the **[FUNC]** key and press the **[0 SET/SB]** key.

- In 1.2 GHz band, frequency steps are as follows; 10, 12.5, 20, 25, and 30 kHz.
- A dot appears when the 6.25 kHz step is selected. 1.25 kHz is added to the displayed frequency. This example shows 433.23125 MHz.





Dot



Changing the Frequency in 100 kHz, 1 MHz or 10 MHz Steps

- The 10 MHz Steps is not available for C568S.



To change the frequency by a 100 kHz.



-  +  Hold down the **[FUNC]** key and turn the Selector.

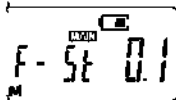

To change the frequency by a 1 MHz or 10 MHz.

-  +  Hold down the **[FUNC]** key and press the **[0 SET/SB]** key.
-  Turn the Selector to change the Set menu display to "F-St 0.1".



-  +  Hold down the **[FUNC]** key and turn the Selector to change the frequency step from 0.1 to 1.0 or 10.0. (C568S cannot indicate 10.0)

-  +  Hold down the **[FUNC]** key and press the **[0 SET/SB]** key.

-  +  To change the frequency, hold down the **[FUNC]** key and turn the Selector.

Using the CALL Frequency

- When shipped, the CALL frequency is the 145.00 MHz in the VHF band and 433.00 MHz in the UHF band. For other model refer to the table below.

1 Select the main band and set to the VFO.



2 Press the [SFT CALL] key.

3 Confirm that CALL frequency and "C" are displayed.



4 To return the VFO press the [SFT CALL] key.



BAND \ MODEL	VHF	UHF
C568	146.00	433.00
C568A	146.00	446.00
C568S	145.00	433.00

- The CALL frequency becomes the VFO frequency by turning the Selector.
- In Procedure 4, the displayed frequency becomes a VFO frequency by pressing the [* PSC] key.

Changing the CALL Frequency

- To change the CALL frequency.

1 Select the main band and set to the VFO.

2 Set the new CALL frequency.



3 Hold down the [FUNC] key and press the [ENT V/M] key.



4 Press the [SFT CALL] key.

5 Confirm VFO and "C" are displayed for about one second.

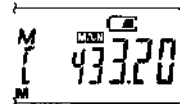

Changing the CALL Frequency Temporarily (CALL Shift)

- CALL frequency can be changed temporary.



- 1 Select the main band and set to the VFO.
- 2 Press the **[SFT CALL]** key.
- 3 Confirm the CALL frequency and "C" are displayed.



- 4 Hold down the **[FUNC]** key and press the **[SFT CALL]** key. Confirm the "C" is blinking.

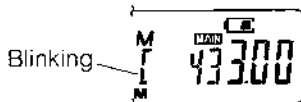

- 5 Set the temporary CALL frequency.

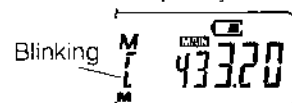

- 6 To Return to the CALL frequency, press the **[SFT CALL]** key.



- ◆ In step 6, the displayed frequency becomes the CALL frequency by holding down **[FUNC]** key and pressing the **[ENT V/M]** key.

Storing Associated Data with the CALL Frequency

- Various settings can be stored with the CALL frequency. These are the Repeater mode, Offset frequency, Paging mode, Code Squelch mode, Tone Encode modes, Tone Squelch modes and tones.



- 1 Select the main band and set to the VFO.
- 2 Press the **[SFT CALL]** key.
- 3 Confirm the CALL frequency and "C" are displayed.



- 4 To set the various setting, refer to the specific setting.
 Repeater Mode (P.42)
 Offset frequency (P.43)
 Paging Mode (P.55)
 Code Squelch Mode (P.59)
 Tone Encode Mode (P.67)
 Tone Squelch Mode (P.67)
 Tones (P.67)



- 5 To Return the VFO, press the **[SFT CALL]** key.



- ◆ In step 4, the offset frequency, tone frequency of the repeater or the tone frequency can be changed in the CALL mode.

Using the Key Lock

- This function locks the frequency to prevent accidental changes.

- F** +  **3**
- 1 Hold down the **[FUNC]** key and press the **[3 K.L/C]** key.
 - 2 Confirm that the key symbol is displayed.

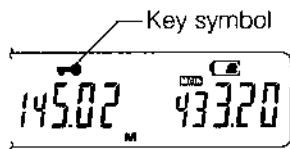

- ◆ To cancel this setting, hold down the **[FUNC]** key and press the **[3 K.L/C]** key.
- ◆ The functions available in the key lock are **[FUNC]**, **[LAMP]**, **[SQL OFF]**, **[PWR]** key, and the **[2 PO/B]** key by holding down the **[FUNC]** key.

Using the Selector in the Key Lock Mode



- The Selector cannot be used in the Key Lock mode. To enable the Selector while in the Key Lock mode perform the following steps:

- F** +  **0**
- 1 Hold down the **[FUNC]** key and press the **[0 SET/SB]** key.
 - 2 Turn the Selector to change the Set menu display to "FLCH OFF".



- F** +  **3**
- 3 Hold down the **[FUNC]** key and turn the Selector to change the display from "OFF" to "on".
 - 4 Hold down the **[FUNC]** key and press the **[0 SET/SB]** key.



- ◆ To cancel this setting, change the display from "on" to "OFF" in step 3.

Using the SQL OFF

- While squelch is on, weak signals may be either blocked or interrupted. If this happens temporarily turn off the squelch.



1 To turn the squelch off, press the **[SQL OFF]** key.



2 When the **[SQL OFF]** key is released, squelch is on.



- In the sub band's the squelch is turned off by holding down the **[FUNC]** key and pressing the **[SQL OFF]** key.
- The sub band's squelch is turned off by pressing the **[SQL OFF]** key during transmission.

Changing the Transmitting Power

- The transmitting power can be changed by four steps in the main band.



1 Hold down the **[FUNC]** key and press the **[2 PO/B]** key. Each press changes the display.

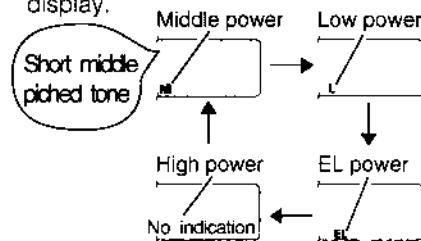

Battery	CNB172	CNB171 CNB173	CBT171
Transmitting Power			
High power	5.0 W	2.6 W	2.5 W
Middle power	2.5 W	2.5 W	2.5 W
Low power	0.35 W	0.35 W	0.35W
EL power	50mW	50mW	50mW

- The transmitting power varies with the condition of batteries to some extent.
- The transmitting power on the 1.2 GHz band is approximately 35 mW and EL (Extreme Low) is displayed.

Turning Sub Band Off (Band Off)



1 To select the main band, press the **[MONO MAIN]** key.



2 Hold down the **[FUNC]** key and press the **[MONO MAIN]** key.

3 Confirm the sub band is turned off. The display only shows one band.



◆ To cancel the sub-band off, press the **[MONO MAIN]** key.

Changing the Band

- The VHF band can be changed to the UHF band, and the UHF band can be changed to the VHF band (VU or UV). The UHF band is 430 MHz in its original state, it can be changed to the 1.2 GHz band.

To change the VHF band into UHF band.

1 Set the main band to the VHF band and set the VFO.

2 Press the **[4 PAG/D]** key.

3 Confirm the display has changed to the UHF band. A frequency can be inputted.

4 To input a frequency use the key pad.



To turn the UHF band into a VHF band.

1 Set the main band to the UHF band and set the VFO.

2 Press the **[1 MY/A]** key.

3 Confirm the displayed state has changed to the VHF band. A frequency can be inputted.

4 To input a frequency use the key pad.

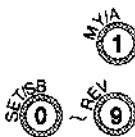

To turn the UHF band into a 1.2 GHz band.

1 Set the main band to the UHF band and set the VFO.

2 Press the **[2 PO/B]** key.

3 Confirm displayed state has changed to the 1.2 GHz band. A frequency can be inputted.

4 To input the frequency use the key pad.

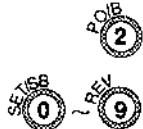

- ◆ 1.2 GHz band transmitting power is EL. The UHF band can be changed to 1.2 GHz band. The VHF band cannot be changed to 1.2 GHz band.

Changing the Set Mode Function

- Certain Set Mode functions as listed on **P** 72 can be stored as a personalized function, or "My key". The dual watch mode is stored originally from the factory.

Changing the set mode function

F +  Hold down the **[FUNC]** key and press the **[1 MY/A]** key.

Storing set mode into **[1 MY/A]** key

F +  **1** Hold down the **[FUNC]** key and press the **[0 SET/SB]** key.

2 Turn the Selector to select the set mode to be stored.

F +  **3** Hold down the **[FUNC]** key and press the **[1 MY/A]** key.



- ◆ A short middle-pitched tone is sounded when the set mode function returns to the initial state. A short high-pitched tone is sounded when the set mode function is not set to the initial state.
- ◆ The low-pitched tone is sounded, the set mode function cannot be stored as selected in step 3.
- ◆ The dual watch is restored when an all reset is done.

Lighting the Display Lamp

- The lamp can be lit for five seconds, or locked in the on position for use in the dark.

Lighting the display lamp



Press the **[LAMP]** key.

Locking the display lamp



F + **1** Hold down the **[FUNC]** key and press the **[LAMP]** key.

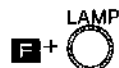

F + **2** To cancel this function, hold down the **[FUNC]** key and press the **[LAMP]** key.



- ◆ The lamp stays lit if keys are continually pressed within five seconds period, this applies to all keys except the **[PTT]**, **[SQL OFF]**, **[FUNC]** key or Selector.

MEMORY FUNCTIONS

The Memory Function	26
Storing Memory	26
Recalling Memory	27
Changing the Memory	27
Erasing the Memory	28
Changing Memory Temporarily (Memory Shift)	28
Saving Various Modes in a Memory	29
Protecting Memory (Memory Protect)	29
Inserting or Removing the Memory Unit	30
About the Memory Unit	30

The Memory Function

- Often used frequencies can be stored in the Memory Unit. Up to 20 channel frequencies can be stored in each band. Change the Memory Unit from the CMU160 to CMU161 (optional), and up to 100 channel frequencies can be stored in each band.
- Memory mode: storing the memory, when recalling the memory or using the memory the M is lit.
- The memory address is the location where a frequency is stored. The number of the memory address is used to recall the frequency stored at that location. Memory address number are 00 to 19. When changing the Memory Unit to the CMU161 (optional), memory address number expands 00 to 99.
- The Repeater mode, Offset frequency, Paging mode, Code Squelch mode, Tone Encode mode, Tone Squelch mode and tones can be stored with each frequency. (P 29)
 - Repeater mode (P 42)
 - Offset frequency (P 43)
 - Paging mode (P 55)
 - Code Squelch mode (P 59)
 - Tone Encode mode (P 67)
 - Tone Squelch mode (P 67)
 - Tones (P 67)
- Memory Protect function is used to protect memory settings from accidental erasing. (P 29)

Storing Memory

- The frequencies used most often should be memorized.

- 1 Select the main band, and set to the VFO.
- 2 Set the frequency to be stored.

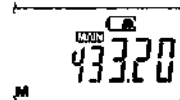

- 3 Hold down the **[FUNC]** key and press the **[ENT V/M]** key.
- 4 Confirm a frequency can be stored.

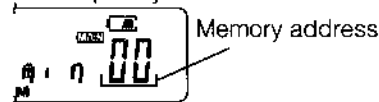

- 5 Hold down the **[FUNC]** key and press the **[ENT V/M]** key.
- 6 Confirm that the "M" is displayed for one second and returns to the VFO.



- The frequency cannot be changed until step 3 is completed and returned to the VFO.
- In step 4, the lowest empty memory address is displayed.
- In step 4, if the memory has no empty address numbers, "min --" is displayed, to change this refer to "Changing the Memory (P 27)".
- In step 4, other address numbers can be displayed by using the Selector.
- In step 4, although a frequency may be stored in the lowest memory address, the new frequency can be stored in any selected memory address by using the keypad.

Recalling Memory

- There are two methods for recalling stored memory, using the Selector, and the key pad.

Using the Selector

1 Select the main band, and set to the VFO.



2 Press the **[ENT V/M]** key



3 Turn the Selector to select a memory address. (where the information is to be stored)



4 Press the **[ENT V/M]** key to return to the VFO.

Using the key pad

1 Select the main band, and set to the VFO.



2 Press the **[ENT V/M]** key



3 Use the key pad to set a memory address. (where the information is to be stored)

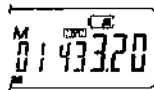

4 Press the **[ENT V/M]** key or the **[* PS/CL]** key to return to the VFO.



- A blinking "M" indicates the memory address has no memory, this state is called empty memory.

Changing the Memory

- To change a stored frequency to another frequency.

1 Select the main band, and set to the VFO.

2 Select the new frequency.

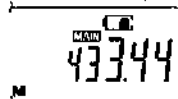

3 Hold down the **[FUNC]** key and press the **[ENT V/M]** key.



4 Input the new memory address number using the key pad.

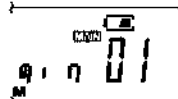



5 Confirm the beep after the last digit is inputted from the keypad. The display verifies the frequency selected and returns to the VFO.



- A frequency can be changed by using the "Memory Shift". (D 28)

Erasing the Memory

- Stored memory can be erased.

- 1 Select the main band, and set to the VFO.
 - 2 Press the **[ENT V/M]** key.
 - 3 Select the memory to be erased.
- 
- 4 Hold down the **[FUNC]** key and press the **[ENT V/M]** key.
 - 5 Confirm "CLR" is displayed.
- 
- 6 Hold down the **[FUNC]** key and press the **[ENT V/M]** key.
 - 7 Confirm the "M" is blinking and a high pitched beep is sounded. (where the frequency is to be erased)
 - 8 Press the **[ENT V/M]** key to return to the VFO.



- ◆ When step 6 is completed, the memory has been erased and cannot be retrieved.
- ◆ If you do not want to erase the memory, press the **[* PS CL]** key before step 6.
- ◆ When the Memory Protect is activated, the memory protected can not be erased this is indicated by a low pitched beep in step 4.

Changing Memory Temporarily (Memory Shift)

- The memory frequency can be changed temporarily.

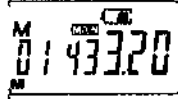
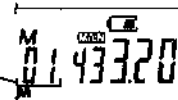
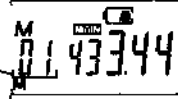
- 1 Select the main band, and set to the VFO.
 - 2 Press the **[ENT V/M]** key.
 - 3 Select a memory address.
- 
- 4 Hold down the **[FUNC]** key and press the **[SFT CALL]** key, and confirm a memory address number is blinking.
- 
- 5 Change the frequency.
- 
- 6 Press the **[* PS CL]** key to return to the memory mode and to its original frequency.



- ◆ In step 6, hold down the **[FUNC]** key and press the **[ENT V/M]** key to store the changed frequency. The memory address number lights from blinking. Press the **[ENT V/M]** key to return to the original VFO frequency.

Saving Various Modes in a Memory

- Each of the following modes can be saved with the frequency and stored in memory.

1 Select the main band, and set to the VFO.



2 Press the [ENT V/M] key.

3 Select a memory address where the various modes are to be stored.

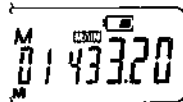

4 Select various modes.

The modes are:

Repeater mode (P 42)

Offset frequency (P 43)

Paging mode (P 55)

Code Squelch mode (P 59)

Tone Encode mode (P 67)

Tone Squelch mode (P 67)

Tones (P 67)



5 Press the [ENT V/M] key to return to the VFO.



- In step 4, while in the memory channel address all selected modes are stored automatically and do not need to be re-entered.

Protecting Memory (Memory Protect)



- This protects stored setting so they are not be changed or erased by mistake. This function is set for each memory and call frequency.

1 Select the main band, and set to the VFO



2 Press the [ENT V/M] key.

3 Select the memory address to be protected.

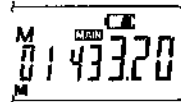

4 Hold down the [FUNC] key and press the [0 SET/SB] key.



5 Turn the Selector to change the Set menu display to "Pro OFF".



6 Hold down the [FUNC] key and turn the Selector to change the display from "OFF" to "on".



7 Hold down the [FUNC] key and press the [0 SET/SB] key.

8 Confirm the memory protect is activated.

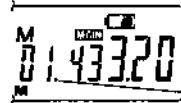

Memory protect



- This function does not protect the memory against an All Reset. (P 12)

Inserting or Removing the Memory Unit

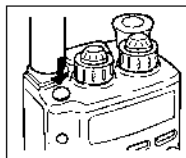

1 Turn the power off.

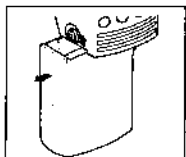

2 Remove the battery case or battery pack.

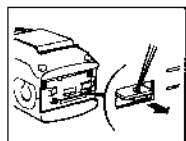

3 To remove the Memory Unit from Transceiver, insert the point of a pair of tweezers into the hole of the Memory Unit, and slide the Memory Unit out.

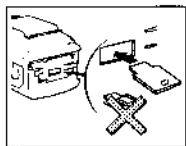

4 Confirm the proper position and direction (components side facing the keypad), and insert the Memory Unit. (Do not forcibly insert the Memory Unit. If this is done damage to the Transceiver's connector or the Memory Unit may occur)



- ◆ Be sure to fully insert the Memory Unit. If not, fully inserted intermittent operation or other problems may occur. If the Memory Unit is mounted incorrectly damage may occur. Never try to insert the Memory Unit the wrong way.

About the Memory Unit

- ◆ If the memory unit that you have installed does not operate properly a beep is sounded and the display shows Error (Err). To correct this condition, turn off the power and replace the memory unit with the correct memory unit.



- ◆ When the Memory Unit of other STANDARD Transceivers are used like the C168, C468, C178, C478 and C558 series, the display shows the same indication as above. To use these Memory Unit do an all reset. Note; if all reset is done, all stored memory on the unit are erased.
- ◆ This Transceiver has the capability of protecting the stored memory, when the battery level becomes low. This function becomes activated when the battery icon blinks and low pitched beep is sounded.
- ◆ When the Memory Unit is not installed, the memory channels and DTMF memories does not operate. The frequency in the VFO only activates.

SCAN

Scan Function	32
Scan within 1 MHz (1MHz Scan)	33
Scan the Entire Band Width (All Scan)	33
Scan a Specific Range (Program Scan)	34
Scan Frequencies in Memory (Memory Scan)	34
Scan Specific Memory Frequencies (Memory Scan Memory)	35
Scan a Block (Block Memory Scan)	36
Scan Specific Memory Frequencies within Blocks	37
Scan the Tone Frequency (Tone Squelch Scan)	37
Dual Watch	38
Using the Dual Watch to VFO Frequency and Memory Address M00	38
Using the Dual Watch to VFO Frequency and Other Memory Address	39
Using the Dual Watch to VFO Frequency and Call Frequency	39
Using the Dual Watch to VFO Frequency and Memory Scan	40
Changing the Dual Watch Time	40

Scan Function

- This function automatically scans frequencies and searching for a signal.
- This transceiver has seven scanning methods. The following seven scan functions can be available.

1MHz Scan

Scans 1MHz beyond the operating frequency.

All Scan

Scans the entire band.

Program Scan

Scans a specific range.

Memory Scan

Scans memorized frequencies.

Memory Scan Memory

Scans specific memory frequencies.

Block Memory Scan

Scans memories in a block.
A block consists of 10 memory address.

Tone Squelch Scan

Scans tone frequencies in the tone squelch mode. Only busy scan can be used.
(C568 and C568S needs optional (CTN560) tone squelch unit for this scan.)

- There are three types of scan that can be selected within the scanning function.

Pause Scan

The scan stops when a signal is received. It resumes in five seconds.

Busy Scan

The scan stops while a signal is being received. It resumes two seconds after the signal ends.

Hold Scan

The scan stops when a signal is received. The frequency remains unchanged when the signal has stopped receiving. The scan is restarted by turning the Selector.

To change the scan type.

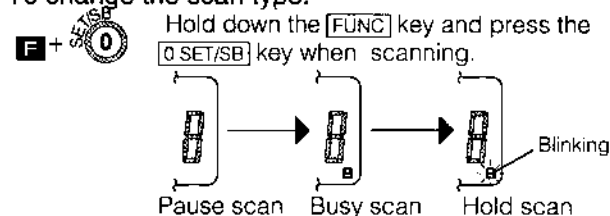

To start the scan, turn the SQL knob till no noise is sounded.

- ◆ The 1MHz scan, all scan and program scan uses a frequency step in scanning. If the scan frequency step is changed, so is the Transceivers frequency scan step.

Scan within 1 MHz (1MHz Scan)

- The scan goes 1 MHz beyond the operating frequency displayed.

- Select the main band, and set to the VFO.
- Set the frequency where the scan is to start.

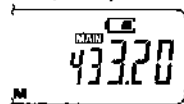

- Hold down the **[FUNC]** key and press the *** PS CL** key to start the scan.

- Confirm the scan has started.

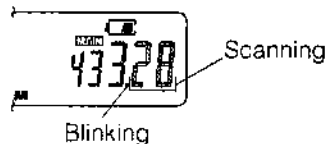

- Press the *** PS CL** key to stop the scan.



- The digits of the scanned MHz section can be changed by holding down the **[FUNC]** key and turning the Selector.

Scan the Entire Band Width (All Scan)

- The entire bandwidth is scanned.

- Select the main band, and set to the VFO.



- Press the **[SFT CALL]** key, and confirm the Call frequency.

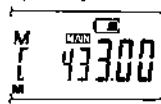

- Press the **[FUNC]** key and press the *** PS CL** key.

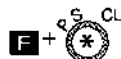

- Confirm the scan has started.

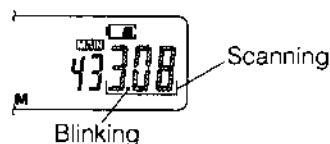

(The Scan start frequency is the originally VFO frequency before setting the Call frequency.)



- Press the *** PS CL** key to stop the scan.

Scan a Specific Range (Program Scan)

- The range is determined by the stored memory frequencies and scans between them.

- 1 Select the main band, and set to the VFO.
- 2 Press the **[ENT V/M]** key to set memory mode.
- 3 Select the memory address where the scan frequency is to start.
- 4 Hold down the **[FUNC]** key and press the **[* PS CL]** key.
- 5 Confirm "Pin - -" is displayed.



- 6 Input the memory address where the scan ends using the keypad.
- 7 Confirm the scan has started.

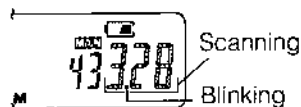

- 8 Press the **[* PS CL]** key to stop the scan.

- ◆ If the lower frequency is selected first, the scan direction is low to high. If higher frequency is selected first, the scan direction is high to low.
- ◆ If an empty memory address is selected, a beep is sounded and the scan does not start.

Scan Frequencies in Memory (Memory Scan)

- To scan all frequencies in the memory.

- 1 Select the main band, and set to the VFO.

- 2 Press the **[# M.S.M MS]** key.

- 3 Confirm the scan has started.



- 4 Press the **[* PS CL]** key to stop the scan.

- 5 Press the **[ENT V/M]** key to return the original VFO frequency. Press the **[* PS CL]** key to return VFO as the displayed frequency.



- ◆ In step 2, if nothing is stored in memory, a low pitched beep is sounded and the scan does not start.

Scan Specific Memory Frequencies (Memory Scan Memory)

- To scan only the specially marked memory address.

Procedures:

The memory address to be scanned must be assigned to memory.

- 1 Select the main band, and set to the VFO.



- 2 Press the [ENT V/M] key to set memory mode.

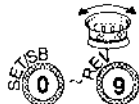

- 3 Input the memory address using the Selector or Key pad.

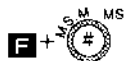
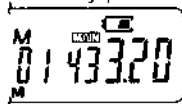

- 4 Hold down the [FUNC] key and press the [# MS.M MS] key

- 5 Confirm (▼) is displayed on the "M".



- 6 When other memory address are to be selected, repeat step 3 to 5.



- 7 Press the [ENT V/M] key to cancel this procedure.

To scan

- 1 Select the main band, and set to the VFO.



- 2 Hold down the [FUNC] key and press the [# MS.M MS] key.

- 3 Confirm (▼) is displayed.

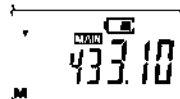

- 4 Press the [# MS.M MS] key

- 5 Confirm the scan has started.

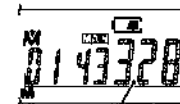

Blinking



- 6 Press the [* PS CL] key to stop the scan.



- 7 Press the [ENT V/M] key to return the original VFO frequency. Press the [* PS CL] key to return VFO as the displayed frequency.



- ◆ While scanning in the memory scan, hold down the [FUNC] key and press the [# MS.M MS] key to change the memory scan to memory scan memory.

- ◆ In step 2, if nothing is stored in memory, a beep is sounded and the scan does not start.

Scan Specific Memory Frequencies (Memory Scan Memory)

- To scan only the specially marked memory address.

Procedures:

The memory address to be scanned must be assigned to memory.

- 1 Select the main band, and set to the VFO.



- 2 Press the [ENT V/M] key to set memory mode.

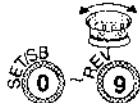

- 3 Input the memory address using the Selector or Key pad.

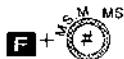
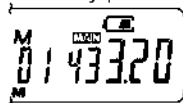

- 4 Hold down the [FUNC] key and press the [# MS.M MS] key

- 5 Confirm (▼) is displayed on the "M".

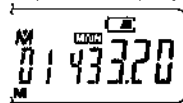

- 6 When other memory address are to be selected, repeat step 3 to 5.



- 7 Press the [ENT V/M] key to cancel this procedure.

To scan

- 1 Select the main band, and set to the VFO.



- 2 Hold down the [FUNC] key and press the [# MS.M MS] key.

- 3 Confirm (▼) is displayed.

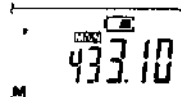

- 4 Press the [# MS.M MS] key

- 5 Confirm the scan has started.

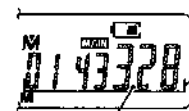

Scanning

Blinking



- 6 Press the [* PS CL] key to stop the scan.



- 7 Press the [ENT V/M] key to return the original VFO frequency. Press the [* PS CL] key to return VFO as the displayed frequency.



- ◆ While scanning in the memory scan, hold down the [FUNC] key and press the [# MS.M MS] key to change the memory scan to memory scan memory.

- ◆ In step 2, If nothing is stored in memory, a beep is sounded and the scan does not start.

Scan a Block (Block Memory Scan)

- The memory is scanned in blocks.
- 10 frequency channels in the memory is considered a block, during the Block Scan mode.
- The relation of block numbers and the memory addresses are shown in the table below. If you use block numbers 2 to 9, the optional CMU161 memory unit is required.

The Block Number	Memory Number
0	M00 - M09
1	M10 - M19
2	M20 - M29
3	M30 - M39
4	M40 - M49
5	M50 - M59
6	M60 - M69
7	M70 - M79
8	M80 - M89
9	M90 - M99

1 Select the main band, and set to the VFO.



2 Press the **[# MS.M MS]** key.

3 Confirm the memory scan has started.

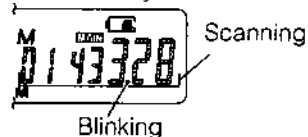

4 Input the block number in the block memory scan using the Key pad.



5 Press the **[* PS CL]** key to stop the scan.



6 Press the **[ENT V/M]** key to return the original VFO frequency. Press the **[* PS CL]** key to return VFO as the displayed frequency.





- ◆ In step 5, press the **[# MS.M MS]** key to restart the memory scan.
- ◆ In step 4, If nothing is stored in the memory block, a beep is sounded and the scan does not start.

Scan Specific Memory Frequencies within Blocks



- The scan only the specially marked memory frequencies within a block.

1 Select the main band, and set to the VFO.

 +  2 Hold down **[FUNC]** key and press the **[#MS.M MS]** key.

3 Confirm (▼) is displayed.

 4 Press the **[#MS.M MS]** key to start memory scan memory.

  5 Input the block number in the block memory scan using the Key pad.

 6 Press the **[*PS CL]** key to stop the scan.

 7 Press the **[ENT V/M]** key to return the original VFO frequency. Press the **[*PS CL]** key to return VFO as the displayed frequency.





- In step 6, press the **[#MS.M MS]** key to start memory scan memory. In step 6, hold down the **[FUNC]** key and press the **[#MS.M MS]** key to start block memory scan.
- In step 5, if nothing is stored in the memory block or (▼) symbol is not marked, a beep is sounded and the scan does not start.

Scan the Tone Frequency (Tone Squelch Scan)

- The tone frequency is scanned on one set frequency.
- Busy scan is only provided.
- The Tone Squelch unit CTN560 is necessary for this operation. CTN560 is optional for C568 and C568S.

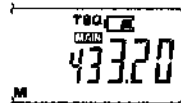

1 Select the main band, and set the tone squelch mode. (D 67)



 2 Hold down the **[FUNC]** key and press the **[0 SET/SB]** key.

 3 Turn the Selector to change the Set menu display to "CF 100.0".

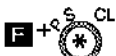

 +  4 Hold down the **[FUNC]** key and press the **[*PS CL]** key.

5 Confirm the Tone Frequency Scan has started.

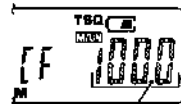

Blinking



6 Press the **[*PS CL]** key to stop the scan.

Dual Watch





- The Dual Watch is used to monitor two frequencies by switching between them. This can be done between the VFO and the Call frequency or any memory address.
- If the selected memory address is empty, a low pitched beep is sounded and the function does not start.
- When memory or call frequency is received, the dual watch pauses on the frequency until the signal ends.
- When a VFO frequency is received, the dual watch is continues. The VFO reception may be interrupted, during Dual Watch.
- Dual watch is set in the **[1 MY/A]** key. (when shipped)
Hold down the **[FUNC]** key and press the **[0 SET/SB]** key to turn off the dual watch.

To start the dual watch when not set in **[1 MY/A]** key.

- 1 Hold down the **[FUNC]** key and press the **[0 SET/SB]** key.
- 2 Turn the Selector to change the Set menu display to "duAL OFF".

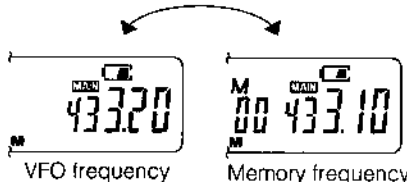
- 3 Hold down the **[FUNC]** key and turn the Selector to start dual watch.

Using the Dual Watch to VFO Frequency and Memory Address M00

- 1 Select the main band, and set to the VFO.
- 2 Hold down **[FUNC]** key and press the **[1 MY/A]** key.

- 3 Confirm the dual watch starts.

- 4 Press the **[* PS CL]** key to stop the dual watch.

- ◆ If memory address M00 is empty, a low pitched beep is sounded and this function does not start.
- ◆ The receiving frequency switches to the memory frequency every 3 second when a VFO frequency is received.
- ◆ If a memory frequency is received, the receiving frequency is the memory frequency until the transmission ends.

Using the Dual Watch to VFO Frequency and Other Memory Address

1 Select the main band, and set to the VFO.



2 Press the [ENT V/M] key to set memory mode.



3 Select the memory address using Selector or Key pad.

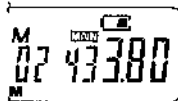

4 Hold down the [FUNC] key and press the [1 M/Y/A] key.

5 Confirm the memory frequency is received every three seconds.

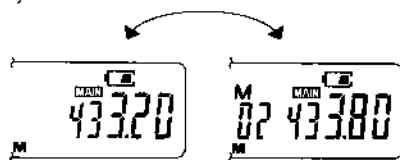

6 Press the [* PS CL] key to stop the dual watch



- ◆ This procedure is able to use memory address M00.
- ◆ If the selected memory address is empty, a low pitched beep is sounded and this function does not start.

Using the Dual Watch to VFO Frequency and Call Frequency

1 Select the main band, and set to the VFO.



2 Press the [SFT CALL] key to recall the call frequency.

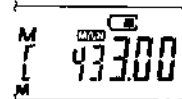



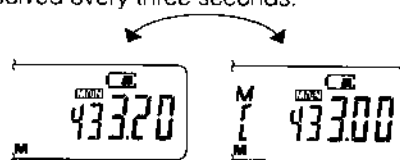

3 Hold down the [FUNC] key and press the [1 M/Y/A] key.

4 Confirm the memory frequency is received every three seconds.





5 Press the [* PS CL] key to stop the dual watch.





Using the Dual Watch to VFO Frequency and Memory Scan

- 1 Select the main band, and set to the VFO.
 - 
 2 Press the **[# MS.M MS]** key.
 - 3 Confirm the memory scan starts.
 - 
 4 Hold down the **[FUNC]** key and press the **[1 MY/A]** key.
 - 5 Confirm the memory frequency is received every three seconds.
 - 
 6 Press the **[* PS CL]** key to stop the dual watch.
- 
 • Memory scan memory, block memory scan or block memory scan memory is possible in dual watch, to do this set each scan before step 4.

Changing the Dual Watch Time

- In ordinary dual watch, reception time is three seconds in the VFO and 0.25 second in the memory frequency. This time period can be changed to 0.6 second in the VFO and 0.6 second in the memory frequency.

- 
 1 Hold down the **[FUNC]** key and press the **[0 SET/SB]** key.
 - 
 2 Turn the Selector to change the Set menu display to "duSPnor".



 - 
 3 Hold down the **[FUNC]** key and turn the Selector to change the display from "nor" to "FSt".
 - 
 4 Hold down the **[FUNC]** key and press the **[0 SET/SB]** key to return the original display.
- 
 • To cancel this setting, change the display from "FSt" to "nor" in step 3.

REPEATER OPERATIONS

Repeater Operation	42
Setting the Repeater Mode	42
Changing the Offset Frequency during Repeater Operation	43
Using a Repeater which Require a 1750 Hz Tone Burst	43
Reversing the Repeater Transmission/ Reception Frequency (Reverse)	44

Repeater Operation

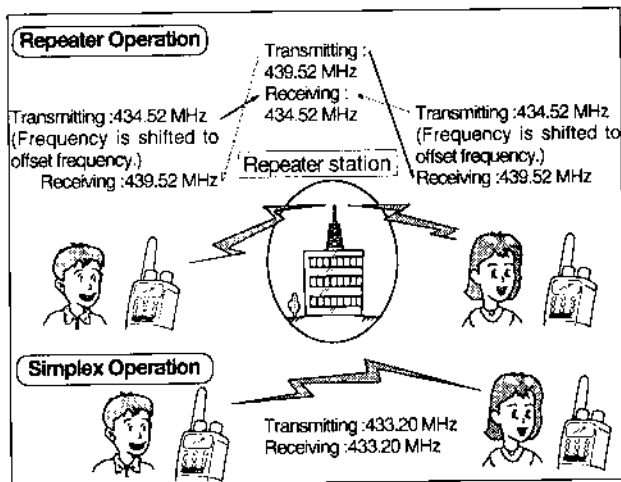
- Communicating through a repeater is known as repeater operation.
- Communication with a location where signals do not directly reach can be done using a repeater station.
- In Repeater Operation, the frequencies for transmission and reception are different. The difference is called the offset frequency. The offset frequency depends on the repeaters operation and band being used.
- Some repeaters require CTCSS sub-audible tone frequencies.



Setting the Repeater Mode

- The Transceiver can be set to - offset, + offset or no offset (simplex). When the offset is + the transmission frequency is plus the offset and when the offset is - the transmission frequency is minus the offset.

- 1 Set the receiving frequency the same as the out put frequency of the repeater station.

- 2 Hold down the **[F]** + **[8]** key and press the **[RPT]** key to select the direction of the offset.

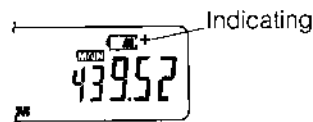

- : Sets the offset frequency lower.
- +: Sets the offset frequency higher.
- OFF: Does not set an offset frequency.



- ◆ When the transmission frequency is out of the offset limits or the direction of the shift, there is no transmission or reception.
- ◆ When the transmitting frequency is different from the repeater operation you can not key the repeater station, change the offset.

Changing the Offset Frequency during Repeater Operation

- This Transceiver has the capability of changing the offset frequency. This allow the possibility of using non-standard offset.

F +  **1** Hold down the **[FUNC]** key and press the **[0 SET/ISB]** key.



2 Turn the Selector to change the Set menu display to "OF 0.00".

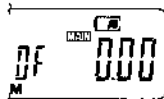

F +  **3** Hold down the **[FUNC]** key and turn the Selector to set the new offset frequency.

F +  **4** Hold down the **[FUNC]** key and press the **[0 SET/ISB]** key.



- ◆ When using the Key pad, the offset can be inputted starting at the 1 MHz digit.
- ◆ When shipped, the offset frequency is set as follows:

BAND	VHF	430MHz	1200MHz
C568	0.00	0.00	35.0
C568A	0.60	5.00	12.0
C568S	0.00	0.00	35.0



Using a Repeater which Require a 1750 Hz Tone Burst

- This function transmits a tone burst signal to gain access to a repeater station.

1 Set frequency of the repeater station.

2 Set offset frequency.

3 Set repeater mode.

 +  **4** Hold down the **[PTT]** switch and press the **[SFT CALL]** key.
(While the **[SFT CALL]** key is pressed, 1750 Hz tone burst signal is transmitted.)

5 Release the **[PTT]**. (Switched to enter the receiving state.)

Reversing the Repeater Transmission/ Reception Frequency (Reverse)

- This function reverses the reception and transmission frequency. This allows you to listen on the input frequency of the repeater to determine if it is possible to change to simplex operation.

1 Set the frequency of the repeater station.

F + **REV** **9** **2** Hold down the **[FUNC]** key and press the **[9 REV]** key.

3 Confirm "-" or "+" is blinking.
(The repeater frequency input is displayed.)



F + **REV** **9** **4** To cancel the reverse, hold down the **[FUNC]** key and press the **[9 REV]** key.



- ◆ When the reversed frequency is out of limits, a low pitched beep is sounded.

ADDITIONAL FUNCTIONS

Preventing Unintentional Transmission (PTT lock)	46
Inputting 1kHz Digit on the Keypad	46
Using the Auto Power Off	47
Battery Save	47
Stopping the Transmission Automatically (Time-Out Timer)	48
Turning the Beep On or Off	48
Reducing Pop Noise when Squelch Is Opened	49
Muting the Sub-band (Sub-band mute)	49
Switching the External Speaker	50
Setting the Auto AM Reception Mode	50
Setting the AM Reception Mode Manually	51
Setting the Cross-band Repeater	51
Setting the Delay Time for Cross-band Repeater Transmission ..	52
Beep Sound	52

Preventing Unintentional Transmission (PTT lock)



- To prevent unintentional transmission the PTT switch can be locked.



- 1 Hold down **[FUNC]** key and press the **[0 SET/SB]** key.



- 2 Turn the Selector to change the Set menu display to "PL OFF".



- 3 Hold down the **[FUNC]** key and turn the Selector to change the display from "OFF" to "on".



- 4 Hold down **[FUNC]** key and press the **[0 SET/SB]** key.

- 5 Confirm that a low pitched beep is sounded and there is no transmission when the **[PTT]** switch is pressed.



- To cancel this setting, change the display from "on" to "OFF" in step 3.

Inputting 1kHz Digit on the Keypad



- 1kHz can be inputted using the Key pad.



- 1 Hold down **[FUNC]** key and press the **[0 SET/SB]** key.



- 2 Turn the Selector to change the Set menu display to "inP1 OFF".

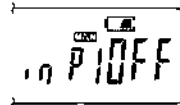

- 3 Hold down the **[FUNC]** key and turn the Selector to change the display from "OFF" to "on".



- 4 Hold down **[FUNC]** key and press the **[0 SET/SB]** key.

- 5 Input from 100 MHz to 1 kHz digit.



Displayed until fourth digit is inputted.
Blinking when fifth digit is inputted
The sixth digit is displayed to except and input.





- When a unacceptable digit is inputted, the frequency is automatically revised.

Using the Auto Power Off



- The Transceiver can shut off automatically if the unit is not being used in the receive, transmit or keypad entry mode for a period of 30 minutes. A warning beep is sounded 1 minute before the power is shut off.

F +  **1** Hold down [FUNC] key and press the [0 SET/SB] key.

 **2** Turn the Selector to change the Set menu display to "APO OFF".



F +  **3** Hold down the [FUNC] key and turn the Selector to change the display from "OFF" to "on".

Indicated during Auto Power Off



F +  **4** Hold down [FUNC] key and press the [0 SET/SB] key.





- To cancel this setting, change the display from "on" to "OFF" in step 3.
- To prevent unwanted battery consumption, use this function.

Battery Save



- This function is used to extend the life of the battery. The battery save function actually turns off the Transceiver for a set period of time and then turns on the Transceiver to check for a signal.

F +  **1** Hold down [FUNC] key and press the [0 SET/SB] key.

 **2** Turn the Selector to change the Set menu display to "SA OFF".

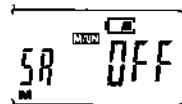

F +  **3** Hold down the [FUNC] key and turn the Selector to change the display from "OFF" to select the time setting. (Time is seconds)

Middle pitched beep

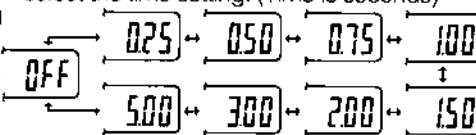

F +  **4** Hold down [FUNC] key and press the [0 SET/SB] key.

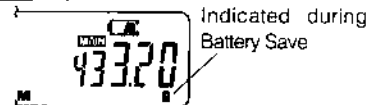



- When this function is used, the beginning of a reception may be interrupted.
- This function should be turned off when using paging and code squelch.

Stopping the Transmission Automatically (Time-Out Timer)



- When a transmission exceeds a specific time, the transmitter is automatically stopped. The time can be set at 2, 3, 4, 5, 7, 10, 12, 15 minutes or off. A warning beep is sounded 30 seconds before stopping the transmission.

F +  **0** 1 Hold down **[FUNC]** key and press the **[0 SET/SB]** key.

 **2** Turn the Selector to change the Set menu display to "tot OFF".



F +  **3** Hold down the **[FUNC]** key and turn the Selector to change the display from "OFF" to select the time setting.

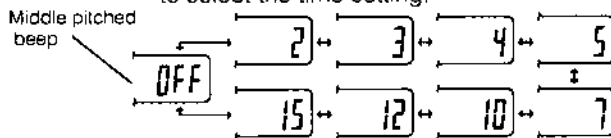



(Each value indicates the time, in minutes, that can be continuous transmitted)

F +  **0** **4** Hold down **[FUNC]** key and press the **[0 SET/SB]** key.

Turning the Beep On or Off



F +  **0** 1 Hold down **[FUNC]** key and press the **[0 SET/SB]** key.

 **2** Turn the Selector to change the Set menu display to "bEEP on".



F +  **3** Hold down the **[FUNC]** key and turn the Selector to change the display from "on" to "OFF".

F +  **0** **4** Hold down **[FUNC]** key and press the **[0 SET/SB]** key.



- To cancel this setting, change the display from "OFF" to "on" in step 3.
- When the time-out timer, Auto Power Off, Paging or Wake-up are activated, this setting must be in the "OFF" position.

Reducing Pop Noise when Squelch Is Opened





- This function reduces the squelch pop noise sounded in the receiver.

F +  **1** Hold down [FUNC] key and press the [0 SET/SB] key.

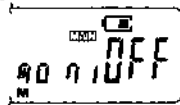

2 Turn the Selector to change the Set menu display to "moni OFF".



F +  **3** Hold down the [FUNC] key and turn the Selector to change the display from "OFF" to "on". (When selected, the pop noise is reduced.)

F +  **4** Hold down [FUNC] key and press the [0 SET/SB] key.



- ◆ To cancel this setting, change the display from "on" to "OFF" in step 3.
- ◆ In this function, battery consumption is slightly higher.

Muting the Sub-band (Sub-band mute)



- Sub-band reception can be muted during transmission in the main-band.

F +  **1** Hold down [FUNC] key and press the [0 SET/SB] key.



2 Turn the Selector to change the Set menu display to "mutE OFF".



F +  **3** Hold down the [FUNC] key and turn the Selector to change the display from "OFF" to "on".

F +  **4** Hold down [FUNC] key and press the [0 SET/SB] key.



- ◆ To cancel this setting, change the display from "on" to "OFF" in step 3.

Switching the External Speaker



- When an external speaker is connected to the speaker jack, both VHF and UHF can be sounded at the same time. Through the menu selection of this Transceiver you can turn on and off the internal or external speakers.



1 Hold down [FUNC] key and press the [0 SET/SB] key.



2 Turn the Selector to change the Set menu display to "SP 11".



3 Hold down the [FUNC] key and turn the Selector to change the display from "H" to select the setting.

Middle pitched
beep

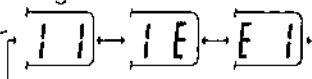

External speaker

Indication	VHF sound	UHF sound
	External speaker	External speaker
!E	Internal speaker	External speaker
E	External speaker	Internal speaker

No external speaker

Indication	VHF sound	UHF sound
	Internal speaker	Internal speaker
!E	Internal speaker	Nothing
E	Nothing	Internal speaker



4 Hold down [FUNC] key and press the [0 SET/SB] key.

Setting the Auto



AM Reception Mode

- When a frequency is set from 100.00 MHz to 139.995 MHz, the Transceiver is switched from FM to AM reception mode automatically. The frequency is automatically switched to the FM mode if the frequency is outside of the 100.00 MHz to 139.995 MHz limit.
- This function is not available for C568S.



1 Hold down [FUNC] key and press the [0 SET/SB] key.



2 Turn the Selector to change the Set menu display to "AmAt OFF".



3 Hold down the [FUNC] key and turn the Selector to change the display from "OFF" to "on".



4 Hold down [FUNC] key and press the [0 SET/SB] key.



- To cancel this setting, change the display from "on" to "OFF" in step 3.
- This function cannot be used in the UHF band.
- In AM mode, "A" is indicated in the 100 MHz digit space.

Setting the AM Reception Mode Manually

- The Transceiver can be switched from FM to AM reception mode manually in the VHF band.
- This function is not available for C568S.

F +  **0** **1** Hold down **[FUNC]** key and press the **[0 SET/SB]** key.



2 Turn the Selector to change the Set menu display to "Am OFF".

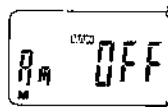

F +  **3** Hold down the **[FUNC]** key and turn the Selector to change the display from "OFF" to "on".

F +  **0** **4** Hold down **[FUNC]** key and press the **[0 SET/SB]** key.



- ◆ To cancel this setting, change the display from "on" to "OFF" in step 3.
- ◆ This function cannot be used in the UHF band.
- ◆ In AM mode, "A" is indicated on 100 MHz digit.

Setting the Cross-band Repeater

- When this function is active, the reception signal is sent on another band.
- This function is not available for C568S.

F +  **0** **1** Hold down **[FUNC]** key and press the **[0 SET/SB]** key.



2 Turn the Selector to change the Set menu display to "rPt OFF".



F +  **3** Hold down the **[FUNC]** key and turn the Selector.

4 Confirm the Cross-band repeater is activated. (Middle pitched beep is sounded)

Indicated during
Cross-band repeater

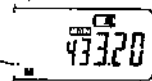

- ◆ To cancel this setting, do the procedure 1 or press the **[MAIN]** key.
- ◆ This function cannot be set if mono-band mode is active.
- ◆ This function cannot be set when the frequencies are in the same band.
- ◆ This function cannot be activated when transmission or reception frequency are set out of limits.

Setting the Delay Time for Cross-band Repeater Transmission



- When this function is activated, the transmission is held for 2 seconds after receiving signal stop.
- This function is not available for C568S.



1 Hold down **[FUNC]** key and press the **[0 SET/SB]** key.



2 Turn the Selector to change the Set menu display to "rPtt OFF".



3 Hold down the **[FUNC]** key and turn the Selector to change the display from "OFF" to "on".



4 Hold down **[FUNC]** key and press the **[0 SET/SB]** key.



- ◆ To cancel this setting, change the display from "on" to "OFF" in step 3.
- ◆ This function cannot be activated when cross-band repeater is activated.

Beep Sound

- If the keypad is in the locked, the musical scale can be sounded. If the LAMP key is held down, each musical note drops one octave.
- When the keypad is not locked, each key has a different beep sound according to the function that is used. Each key pad number (1 - 0) has a musical note assigned and can be used to locate a keypad number.
- The following is the relationship between keys and assigned musical note.

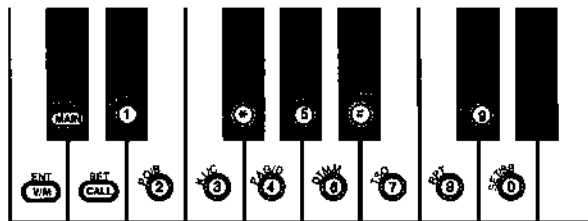

GROUP FUNCTIONS

Paging	54
Code-squelch	54
Setting the Individual Code	55
Setting the Code of Your Partner's Paging/ Code Squelch Codes	55
Setting a Group Code	56
Paging during Transmission	56
Paging during Reception	57
Paging without Voice	57
Delayed Paging Sending Time	58
Changing Beeps while in Paging / Wake-up	58
Using Code Squelch	59
Wake-Up	59
Setting Your Individual Wake-up Code	60
Setting Your Partner's Wake-up Code	60
Selecting the Wake-up Code's Digit	61
Waiting in Wake-up	61
Calling Wake-up	62
Using DTMF	63
Holding down the PTT Switch and Sending a DTMF Code	63
Storing the DTMF Code	64
Erasing a DTMF Code	64
Sending DTMF Memory Addresses	65
Confirming the Stored DTMF Code	65
Changing the Interval Sending Time of the DTMF Code	66
Using the Tone Squelch	66
Using the Tone Encode/Tone Squelch	67
Changing the Frequency of the Tone Signal	67

- This Transceiver can call a specific Transceiver or a group. To do this, the paging code must match that of the other Transceivers. This Transceiver has a wake-up function which allows the Transceiver to wait in a dormant state until called.

Code-squelch

- Code-squelch is the process of sending a coded DTMF signal to another Transceiver that has the same code programmed as the transmitting unit. When received, communications can begin.
- This function does not have an alarm associated with it.

Paging

- The Paging function requires the sending Transceiver and the receiving Transceiver use matching personal or group paging codes. The same group code must be used by each member of the group. When the code is matched, the code is displayed and an alarm is sounded.

Using your partner's code
Individual code: C0 111



Individual code: C0 222

Using group code
Individual code: C0 111
Group code: C2 050

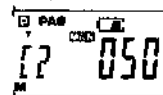

Group code:
C2 050

Individual code:
C0 222

Group code:
C2 050

Individual code:
C0 333

Group code:
C2 050

Individual code:
C0 444

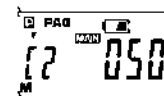
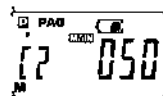
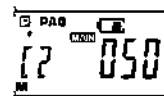
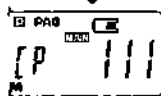

Setting the Individual Code

- An individual code is necessary to call and receive your partner. The individual code is stored in memory address C0.

F + **CODE 5** **1** Hold down the **FUNC** key and press the **5 CODE** key.

2 Turn the Selector to set the individual address code C0.

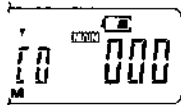

SET/SEL 0 **REV 9** **3** Input the first digit on the Key pad.

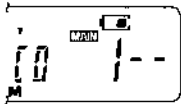

4 Confirm the beep is sounded when the third digit is inputted.

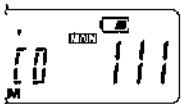

F + **CODE 5** **5** To return the original state, hold down **FUNC** key and press the **5 CODE** key.

Setting the Code of Your Partner's Paging/Code Squelch Codes

- It is necessary to set your partner's code before calling. Your partner code is stored in memory address C1 to C6.

F + **CODE 5** **1** Hold down the **FUNC** key and press the **5 CODE** key.



2 Turn the Selector to set your partner's individual address code. (Set this code in address C1 to C6.)

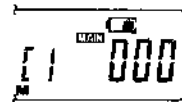

SET/SEL 0 **REV 9** **3** Input the first digit on the Key pad.

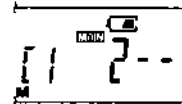

4 Confirm the beep is sounded when the third digit is inputted.

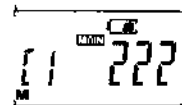

F + **CODE 5** **5** To return the original state, hold down **FUNC** key and press the **5 CODE** key.

Setting a Group Code

F + **CODE** **5** **1** Hold down the **[FUNC]** key and press the **[5 CODE]** key.



2 Turn the Selector to set the your partner's code address. (Set this code in address C1 to C6)

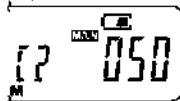

F + **MS M MS** **#** **3** Hold down the **[FUNC]** key and press the **[# MS.M MS]** key.

4 Confirm (▼) mark is displayed on the address code.
(In this step, group code is set.)

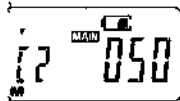

F + **CODE** **5** **5** To return the original state, hold down the **[FUNC]** key and press the **[5 CODE]** key.



◆ If a group code is not set (▼), the Transceiver is not called if a group code is transmitted.

Paging during Transmission



1 Hold down the **[FUNC]** key and press the **[4 PAG/D]** key.

2 Confirm "PAG" is displayed.

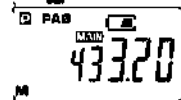

3 Hold down the **[FUNC]** key and press the **[5 CODE]** key.



4 Turn the Selector to set your partner's code address.



5 Press the **[PTT]** switch to transmit.

6 Confirm "PAG" blinks and the alarms sounds when your partner replies.

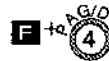
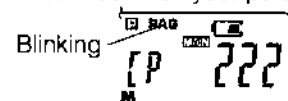

7 Hold down the **[FUNC]** key and press the **[4 PAG/D]** key.

8 Press the PTT switch to respond.



- ◆ If continued communication with the same partner is required, you do not have to repeat steps 3 and 4.
- ◆ Press the **[FUNC]** key to stop the alarm, during the paging reception.



Paging during Reception

F +  **1** Hold down the **[FUNC]** key and press the **[4 PAG/D]** key.

2 Confirm "PAG" is displayed.

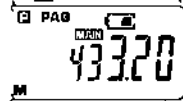

3 Confirm "PAG" blinks and the alarm sounds when your partner replies.

 **4** Press the **[PTT]** switch to respond.

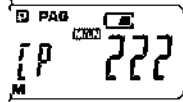

F +  **5** Hold down the **[FUNC]** key and press the **[4 PAG/D]** key twice.

6 Press the **[PTT]** switch to respond.



- ◆ "CP" is displayed, when your individual code is called.
- ◆ "Cn" is displayed, when your call group code is called, and "n" indicates the group number.

Paging without Voice

- When receiving a page, the voice reception can be muted, but the partner code is displayed and alarm is sounded.

F +  **1** Hold down **[FUNC]** key and press the **[0 SET/SB]** key.



2 Turn the Selector to change the Set menu display to "PSq OFF".

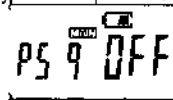

F +  **3** Hold down the **[FUNC]** key and turn the Selector to change the display from "OFF" to "on".

F +  **4** Hold down **[FUNC]** key and press the **[0 SET/SB]** key.



- ◆ To cancel this setting, change the display from "on" to "OFF" in step 3.

Delayed Paging Sending Time

- To prevent the first part of the signal from being interrupted when sent by a repeater, the signal can be delayed. When shipped from the factory, the signal is set at a 450 milliseconds delay. This time can be set to 750 milliseconds.

F +  **1** Hold down **[FUNC]** key and press the **[0 SET/SB]** key.

 **2** Turn the Selector to change the Set menu display to "PA dL 450".

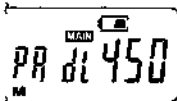

F +  **3** Hold down the **[FUNC]** key and turn the Selector to change the display from "450" to "750".

F +  **4** Hold down **[FUNC]** key and press the **[0 SET/SB]** key.



- To cancel this setting, change the display from "750" to "450" in step 3.
- This function is only active in the repeater mode.

Changing Beeps while in Paging / Wake-up

- The number of beeps sounded during paging and Wake-up functions can be changed. The original setting can be changed from 5 beeps to 1.

F +  **1** Hold down **[FUNC]** key and press the **[0 SET/SB]** key.



2 Turn the Selector to change the Set menu display to "PABP 5".

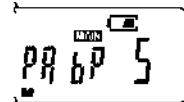

F +  **3** Hold down the **[FUNC]** key and turn the Selector to change the display from "5" to "1".

F +  **4** Hold down **[FUNC]** key and press the **[0 SET/SB]** key.



- To cancel this setting, change the display from "1" to "5" in step 3.

Using Code Squelch

F + **4** **G/D**
4 1 Hold down the **[FUNC]** key and press the **[4 PAGE/D]** key twice.

2 Confirm "CSQ" is displayed.

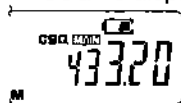

F + **5** **CODE**
5 3 Hold down the **[FUNC]** key and press the **[5 CODE]** key.



4 Turn the Selector to set the code to the same as partner or group.

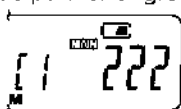

F + **5** **CODE**
5 5 Hold down the **[FUNC]** key and press the **[5 CODE]** key to wait.



6 Press the **[PTT]** switch to transmit.
 (upon reply from your partner, the squelch is opened)



◆ Once communication with your partner's code is made, the code does not have to be set again, steps 3 and 4 can be skipped.

Wake-Up

- The Wake-up function lets the Transceiver wait in a dormant state until called.
- Call other Transceivers according to there individual codes, when the Transceiver is in Wake-up and is called the individual code is displayed.
- The Wake-up function has two types of codes, one for the paging function (3-digits) and one for the Wake-up function (4-digits). It is necessary to set individual code and partner's code.
- The Wake-up function of the C568 series can be used to call the other Transceivers such as the C188 and C488 series if the 4 digit Wake-up codes are used.

4-digits	○○○○ * △△△△	Your individual code ○○○○	Wake up code 0
		Partner's individual code △△△△	Wake up code 1, 2, P
3-digits	○○○ * △△△	Your individual code ○○○	Paging code 0
		Partner's individual code △△△	Paging code 1 to 6, P

Setting Your Individual Wake-up Code



- To use the Wake-up code an individual (4-digits) code must be set.

- 1 Hold down **[FUNC]** key and press the **[0 SET/SB]** key.
- 2 Turn the Selector to change the Set menu display to "W0 0000".
(The individual code is set in memory address W0.)

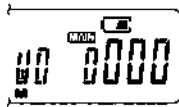

- 3 Input the code on the key pad.

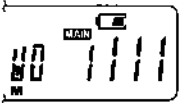

- 4 To return the original display, hold down **[FUNC]** key and press the **[0 SET/SB]** key.

Setting Your Partner's Wake-up Code



- To use the Wake-up code, the partners (4-digits) code must be set.

- 1 Hold down **[FUNC]** key and press the **[0 SET/SB]** key.
- 2 Turn the Selector to change the Set menu display to "W0 xxxx".
(The individual code is set in memory address W0.)

- 3 Hold down the **[FUNC]** key and turn the Selector to change the display to "W1 000" or "W2 0000". (Partner code is set in memory address W1 and W2.)

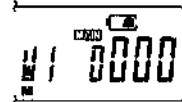



- 4 Input the code on the key pad.





- 5 To return the original display, hold down **[FUNC]** key and press the **[0 SET/SB]** key.



Selecting the Wake-up Code's Digit

Select a 3 digits code (paging code) or 4 digit code (Wake-up code).

- 
1 Hold down the **[FUNC]** key and press the **[0 SET/SB]** key.
- 
2 Turn the Selector to change the Set menu display to "WmodE 4".



- 
3 Hold down the **[FUNC]** key and turn the Selector to select the code's digits. Select "4" when using 4 digit code (Wake-up code). Select "3" when using 3 digit code (paging code).
- 
4 To return the original display, hold down **[FUNC]** key and press the **[0 SET/SB]** key.
 - ◆ Match your partners code with your own code. If you do not match the digits of your partner, you can not receive when you are called by your individual code.

Waiting in Wake-up

- 
1 Hold down **[FUNC]** key and press the **[0 SET/SB]** key.
- 
2 Turn the Selector to change the Set menu display to "WUP OFF".

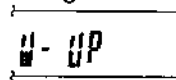

- 
3 Hold down the **[FUNC]** key and turn the Selector to change the display from "OFF" to "on" or "P on".
 When "on" and called, the alarm sounds and the display indicates the partner's code or waiting code. When "P-on" and called, turn the Transceiver on and the alarm sounds.
- 4** Turn the power off, and Confirm the following is indicated;



(Selected "on")

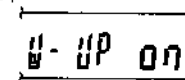

(Selected "Pon")



- ◆ To cancel this setting, change the display to "OFF" in step 3.
- ◆ Waiting code is displayed when using a 4-digit code and called from C188 or C488 series Transceiver.
- ◆ This function is available on main band. The display in step 4 is indicated in main-band.

Calling Wake-up

Preparation

- 1 Select the wake up code digit's. (P. 61)
- 2 Select the partner's code as follows.



When selecting 3-digit

- a Hold down the [FUNC] key and press the [5 CODE] key.



- b Turn the Selector to select the partner's code.



When selecting 4-digit

- a Hold down [FUNC] key and press the [0 SET/5B] key.



- b Turn the Selector to change the Set menu display to "W0 xxxx".

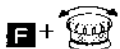

- c Turn the Selector to select the partner's code.

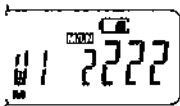

Calling your partner



- 1 Hold down the [FUNC] key and press the [0 SET/5B] key.



- 2 Turn the Selector to change the Set menu display to "Wmode 3" or "Wmode 4".

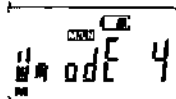

- 3 Hold down the [FUNC] key and turn the Selector to set the partner's digit.
Wmode 3: Partner select 3-digit code.
Wmode 4: Partner select 4-digit code.



- 4 Press the PTT.

- 5 Confirm the display and wake up code is transmitted and is sent approximately 3 seconds later.

Using DTMF

- The following two methods are available for transmitting DTMF signals.

Method 1: Hold down the PTT switch and use the keypad.

Method 2: Store DTMF code in memory and transmit the code.

Memory and display of DTMF codes.

- DTMF code can be stored in a DTMF memory address.
- Up to 15 digits can be stored in one DTMF memory address.
- There are total 7 DTMF memories for UHF and VHF.
- 15-digits code is divided into three blocks and is displayed as follows:

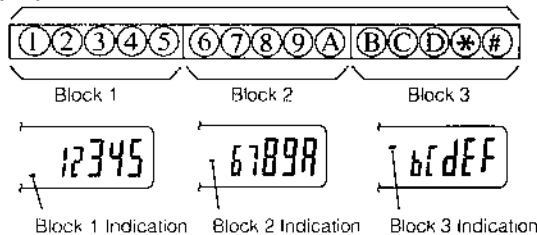

- The codes that can be stored are numbers, letters A to D, and * and #. On the display, the codes are indicated as follows:

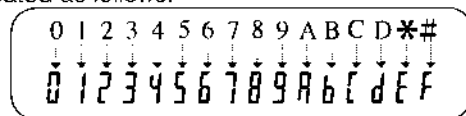

Holding down the PTT Switch and Sending a DTMF Code



- Hold down the **PTT** Switch and press numbers, letters * and # key.



- The DTMF code is sent while pressing the key.

Storing the DTMF Code

- If the DTMF code is stored in a memory address, this allows for easier operation.

-  1 Hold down the **[FUNC]** key and press the **[6 DTMF.M]** key.
-  2 Turn the Selector to change the memory address.
(Memory addresses 0 to 6 can be used.)

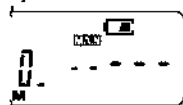

- 3 Input the code from 1st digit to 15th digit on the key pad.
(It is automatically stored when the 15th digit is inputted.)

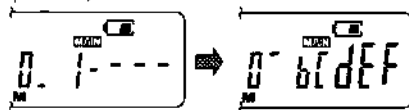



To input numbers, * and # keys, press each key. To input letters A to D, hold down the **[FUNC]** key and press the 1 to 4 key.

-  4 To return the original state, hold down the **[FUNC]** key and press the **[6 DTMF.M]** key.

- ◆  When the input codes are shorter than 15 digits, hold the **[FUNC]** key and press the **[ENT V/M]** key, the code is then inputted.

Erasing a DTMF Code

-  1 Hold down the **[FUNC]** key and press the **[6 DTMF.M]** key.
-  2 Turn the Selector to change the memory address to be erased.
(Memory addresses 0 to 6 is used.)

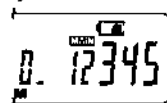

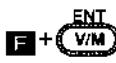
-  3 Hold down the **[FUNC]** key and press the **[ENT V/M]** key.
- 4 Confirm "CLr" is displayed.

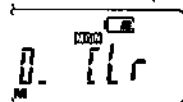

-  5 Hold down the **[FUNC]** key and press the **[ENT V/M]** key.



- ◆ The DTMF memory is erased when step 5 is completed.
- ◆ To cancel this function, hold down the **[FUNC]** key and press the **[6 DTMF.M]** key in step 5.

Sending DTMF Memory Addresses



- 1 Hold down the [PTT] switch and press the [ENT V/M] key.
- 2 Confirm the frequency display is blank.
- 3 Hold down the [PTT] switch and input the DTMF memory address on the keypad.
- 4 Confirm the sending of the DTMF code.



- ◆ Hold down the [PTT] switch to select another memory address as in step 3.
- ◆ In step 3, if nothing is stored in the DTMF memory address that is selected, the display shows the selected DTMF memory number but the DTMF code is not sent.
- ◆ In step 4, the DTMF code can be sent manually. If the [ENT V/M] key is pressed, the code digits can be entered the numbers, *, and # key.

Confirming the Stored DTMF Code



- 1 Hold down the [FUNC] key and press the [6 DTMF.M] key.
- 2 Turn the Selector to change the memory address to be confirmed.
(Memory addresses 0 to 6 is used.)

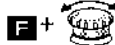
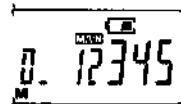

- 3 Hold the [FUNC] key and turn the Selector.

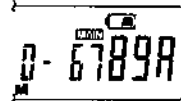

- 4 To return the original state, hold down the [FUNC] key and press the [6 DTMF.M] key.



- ◆ The stored code is displayed by blocks of 5 digits.

Changing the Interval Sending Time of the DTMF Code

- The DTMF code is sent every 50 milli seconds. This interval can be changed to 100 milli seconds.



1 Hold down **[FUNC]** key and press the **[0 SET/SB]** key.



2 Turn the Selector to change the Set menu display to "dtSP nor".

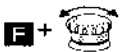

3 Hold down the **[FUNC]** key and turn the Selector to change the display from "nor" to "Lo".



4 To return the original display, hold down **[FUNC]** key and press the **[0 SET/SB]** key.



- To cancel this setting, change the display from "Lo" to "nor" in step 3.
- When using this function (100 milli seconds), during weak signal conditions the receiving station has a better chance of decoding the signal
- This setting can be used for sending DTMF code, paging code, code squelch code and wake-up codes.

Using the Tone Squelch

- When the Transceiver has the tone squelch unit installed, (T)one, (SQ)uelch, the encode and decode function can be used.

Transmitting frequency 433.20 MHz

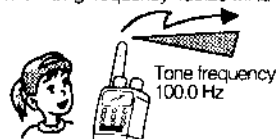

- The tone encoder transmits with the sub-audible tone signal.

- When the selected sub-audible encode tone is transmitted with the carrier signal, the receiving station must have the same frequency and tone set in-order to receive the audio. If they do not match, no audio is received.

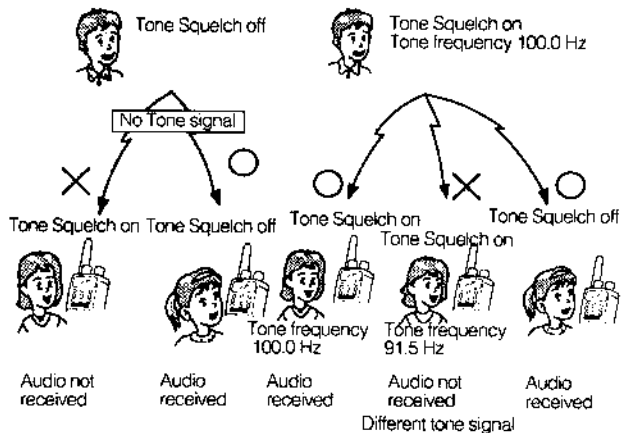





Using the Tone Encode/ Tone Squelch

Using the tone encode

F +  **1** Hold down the **[FUNC]** key and press the **[7 TSQ]** key.

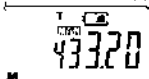
2 Confirm "T" is indicated.



F +  **3** To return the original display, hold down the **[FUNC]** key and press the **[7 TSQ]** key twice.

Using the tone squelch

1 Confirm "T" is indicated.
(When "T" is not indicated, refer to "Using the tone encoder" and indicate "T".)

F +  **2** Hold down the **[FUNC]** key and press the **[7 TSQ]** key.

3 Confirm "TSQ" is indicated.

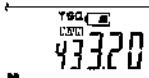

F +  **4** To return the original display, hold down the **[FUNC]** key and press the **[7 TSQ]** key.



- ◆ Hold down the **[FUNC]** key and press the **[7 TSQ]** key when the tone squelch unit is not installed, a beep is sounded and this function is not activated.

Changing the Frequency of the Tone Signal

F +  **1** Hold down the **[FUNC]** key and press the **[0 SET/SB]** key.



2 Turn the Selector to change the Set menu display to "CF 100.0".

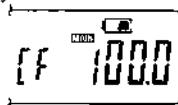

F +  **3** Hold down the **[FUNC]** key and turn the Selector to set a new frequency of the tone signal.

F +  **4** Hold down the **[FUNC]** key and press the **[0 SET/SB]** key.

Chart of tone frequencies that can be selected (Hz)

67.0	69.3	71.9	74.4	77.0	79.7
82.5	85.4	88.5	91.5	94.8	97.4
100.0	103.5	107.2	110.9	114.8	118.8
123.0	127.3	131.8	136.5	141.3	146.2
151.4	156.7	162.2	167.9	173.8	179.9
186.2	192.8	203.5	210.7	218.1	225.7
233.6	241.8	250.3			

The factory setting is 100.0 Hz.

REFERENCES

Trouble Shooting	70
List of the Set Mode Functions	72
Options	73
• Example of TNC (Packet Controller) Connection	73
Specifications	74
Index	75

Trouble Shooting

- Please check the following list of problems before consulting your dealer.

The power cannot be turned on.

- The battery is consumed.
- The memory unit is not properly installed.

The Transceiver is initialized Every time t the power is turned on.

- The memory unit is not properly installed.

VHF or UHF band is not displayed.

- The "Band off" is set.

Low-pitched tone is sounded when pressing each key.

- The battery is consumed. (The is blinking.)

The frequency can not be changed.

- The "Key lock" is set. (The is displayed.)

Not receiving.

- The antenna is not properly connected.

Only Strong signals are received.

- The antenna is not properly connected.
- The squelch knob is turned fully clockwise.

The squelch is not closed. (Noise is sounded.)

- The squelch knob is turned fully counterclockwise.
- The "Squelch off" is set.

No received audio is sounded.

- The volume knob is fully counterclockwise.
- The Paging, Code squelch or Tone squelch are set.
- External speaker function is set.

Not transmitting.

- The "PTT lock" is set.
- The battery is consumed. (The is blinking.)
- The transmitting frequency is not properly set in the repeater mode

The transmission power is low.

- The antenna is not properly connected.
- The battery is consumed. (The is blinking.)
- The band is set to 1.2 GHz. (The transmission power is EL power in 1.2 GHz.

The memory is not stored.

- The memory unit is not properly installed.
- The "Memory protect" is set.
- The battery is consumed. (The is blinking.)

Will not scan.

- The squelch knob is turned fully counterclockwise.
- The "Squelch off" is set.

Memory is not scanned.

- The frequency is not stored or one frequency is stored.
- The memory scan is not set or one memory scan is set in memory scan memory.

The "Dual watch" is not operated from VFO.

- The memory address M00 is not stored.

The repeater station is not accessed.

- The repeater station is too far away.
- The tone frequency is different.
- The offset frequency is different.
- The direction of the shift is different.

The Paging/Code squelch is not operational.

- Your partner is too far away.
- The code is different.
- The group code is not set or is different.





The Wake up is not operational.

- Your partner is too far away.
- The mode (3-digits or 4-digits) is different.
- The code is different.

The Tone squelch is not operational.

- The tone squelch unit (CTN560) is not installed.
- Your partner is too far away.
- The tone frequency is different.

List of the Set Mode Functions

C568 SET MODE		Recall / Set  + 	
* : cannot be stored in MY key.		Select  + 	
★ : not available for C568S			
Initial indication	Function		
St 500	* Changing the frequency step. (P18)	du SPnor	Changing the Dual watch speed. (P40)
OF 000	* Changing the offset frequency. (P43)	Pr o OFF	Setting the memory protect. (P29)
TF 1000	* Changing the tone frequency. (P67) (When using CTN560)	Pl OFF	Setting the PTT lock. (P46)
SR OFF	* Changing the battery save time. (P47)	to t OFF	* Setting the time out timer. (P48)
in P10FF	Inputting 1 kHz digits on the key pad. (P46)	AP 0 OFF	Setting the auto power off. (P47)
F- St 0.1	Changing the frequency in 100 kHz/1 MHz. (P18)	SP 1 1	* Selecting external/internal speaker. (P50)
FL [X]OFF	Setting the Selector for use in the key lock. (P21)	mutE OFF	Muting the sub-band. (P49)
dt SPnor	Changing the interval sending time of the DTMFcode. (P66)	NO n OFF	Reducing pop noise when squelch is opened (P49)
PS 9 OFF	Waiting in the Paging without voice. (P57)	Wa odE 4	Selecting the digit of wake-up code (P61)
PR dt 450	Setting the Paging mode delay time. (P58)	WU P OFF	* Setting wake-up. (P61)
PR bP 5	Changing the number of beeps in Paging/Wake-up. (P58)	WU 0000	* Setting the wake-up code. (P60)
bE EP on	Setting the beep on/off. (P48)	Ra Rt OFF	* Setting the auto AM reception mode in VHF. (P50)
du Rl OFF	Setting the Dual watch. (P38)	Ra OFF	* Setting the AM reception mode manually in VHF. (P51)
		rPt OFF	* Setting the cross-band repeater mode . (P51)
		rPt t OFF	* Setting the the delay time for cross-band repeater transmission. (P52)

Options

CHP111	Head Set with PTT
CHP150	Head Set with VOX
CMP111	Microphone & Speaker
CMP113	Tiepin-Type Microphone & Speaker
CMP115	Small-Sized Microphone & Speaker
CNB171	Standard-type Rechargeable Battery Pack
CNB172	High Power Rechargeable Battery Pack
CNB173	Long Life Rechargeable Battery Pack
CBT171	Battery case (AA-size batteries x 6 pcs.)
CSA181(A/E)*	Desk Top Charger
CWC150(A/E)†	Wall Charger (for CNB171/CNB173)
CWC151(A/E)*	Wall Charger (for CNB172)
CMC150	Mobile Charger (for CNB171/CNB173)
CTN560 *	Tone Squelch Unit
CMU160	Memory unit (4kbit 40 channels)
CMU161	Memory unit (16kbit 200 channels)
CAW150	Mobile Power Cable
CAW151	Power Cable for Base Station
CAW152	Mobile Power Cable with Noise Filter
CLC560	Soft Case (for CNB171/CBT171)
CLC561	Soft Case (for CNB172/CBT173)
CLC562	Hard Case
CLC555	Handy Pouch
CAX03	Bottom Cover
CMB112	Mobile Bracket
CMB600	Helmet Clip for CHP150

*: A for 120 VAC, E for 220VAC.

† C568A has the CTN560 installed.

Example of TNC (Packet Controller) Connection

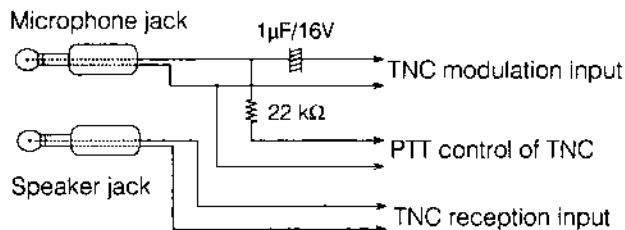

Specifications

General

Frequency Range	144.000 - 147.995MHz(C568/C568A)
	144.000 - 145.995MHz(C568S)
	430.000 - 439.995MHz(C568/C568S)
	438.000 - 449.995MHz(C568A)
	1240.000 - 1299.990MHz
Transmission Type	F2,F3
Microphone Input Impedance	600 Ω
Speaker Impedance	8 Ω
Operating Voltage	DC4.5V - 15.0V (Using battery terminal)
	DC5.0V - 16.0V (Using external supply terminal)
Rated Voltage	DC7.2V
Current Consumption (transmitted in 13.8V)	
..... [Hi 5W] Approx.1100mA (144MHz band)	
	Approx.1300mA (430MHz band)
	[Mid 2.5W]Approx.850mA (144MHz band)
	Approx.950mA (430MHz band)
Current Consumption (transmitted in 7.2V)	
..... [Hi 2.6W]Approx.880mA (144MHz band)	
	Approx.980mA (430MHz band)
	[Mid 2.5W]Approx.850mA (144MHz band)
	Approx.950mA (430MHz band)
Current Consumption (transmitted in 13.8/7.2V)	
..... [Low 0.35W]Approx.480mA (144MHz/430MHz band)	
Current Consumption (transmitted in 13.8/7.2V)	
..... [EL 50mW]Approx.100mA (144MHz/430MHz band)	
Current Consumption (transmitted in 13.8/7.2V)	
..... [EL 35mW]Approx.120mA (1200MHz band)	
Current Consumption (in waiting)	
..... Approx. 68mA(twin mode)	
	Approx. 37mA(144MHz mono band mode)
	Approx. 48mA(430MHz mono band mode)
	Approx. 52mA(1200MHz mono band mode)
Current Consumption (at SAVE 0.75sec)	Approx. 28mA

Dimensions of Main Body (Including Battery but not including projections)	
.....	47.0(W) x 130.5(H) x 34.0(D)mm(C568/C568S)
	47.0(W) x 134.5(H) x 34.0(D)mm(C568A)
Weight (including Battery and antenna)	Approx.360g(C568/C568S)
	Approx.390g(C568A)

Reception

Reception System	Double super heterodyne system
Intermediate Frequency	
..... (Left side of display) 1st IF 21.8MHz/2nd IF 455kHz	
..... (Right side of display) 1st IF 23.05MHz/2nd IF 450kHz	
Reception Sensitivity	(Left side of display) 144MHz band 0.16μV
	430MHz band 0.18μV
	(Right side of display) 144MHz band 0.16μV
	430MHz band 0.16μV
	1200MHz band 0.28μV
S/N Ratio with Input of 0.5μV	30dB more
Squelch Open Sensitivity	0.1μV
Audio Output	250mW(8W, 10% distortion)

Transmission

Transmission Output(Hi)	
Using CBT171	Approx.2.5W(144MHz /430MHz band)
Using CNB171/173	Approx.2.6W(144MHz/430MHz band)
Using CNB172	Approx.5.0W(144MHz/430MHz band)
Transmission Output(Mid)	Approx.2.5W(144MHz/430MHz band)
Transmission Output(Low)	Approx.0.35W(144MHz/430MHz band)
Transmission Output(EL)	Approx.50mW(144MHz band)
	Approx.50mW(430MHz band)
	Approx.35mW(1200MHz band)
Modulation System	Reactance modulation
Max. Frequency Deviation	± 5kHz
Spurious Radiation	60dB more
Built-in Microphone	Electret Condenser Microphone

Index

1 MHz Scan	33	Frequency Step	18	Paging	54
All Reset	12	Group Code	56	Pause Scan	32
All Scan	33	High Power	22	Program Scan	34
Antenna	5	Hold Scan	32	PT	Front Cover-reverse
Auto AM Reception	50	Individual Code	55	PTT	11
Auto Power Off	47	Key Lock	21	Receiving	10
B	32	L	22	Repeater	42
Battery Save	47	Lamp	24	Reset	12
Band Off	23	Low power	22	Reverse	44
Beep Sound	52	M	22	Scan	32
Block	36	Main	9	Set Mode ... Front Cover-reverse,	72
Block Memory Scan	36	Main Band	9	Simplex Operation	42
Busy Scan	32	Memory Address	26	T	67
CALL Frequency	19	Memory Protect	29	Time Out Timer	48
Code-squelch	54	Memory Scan	34	Tone Burst	43
CSQ	59	Memory Scan Memory	35	Tone Encoder	66
DC IN	16	Memory Sift	28	Tone Squelch	66
Display	16	Memory Unit	30	Transmitting	11
DTMF	63	Meter (S/RF)	16	Transmitting Power	22
Dual Watch	38	Middle Power	22	TSQ	67
EL	22	My key	24	VFO	10
EL Power	22	Offset Frequency	43	VFO Reset	12
External Speaker	50	PAG	56	Wake-up	59
F	Front Cover-reverse				
Frequency Band	9				

BLOCK DIAGRAM

Model C568 Series

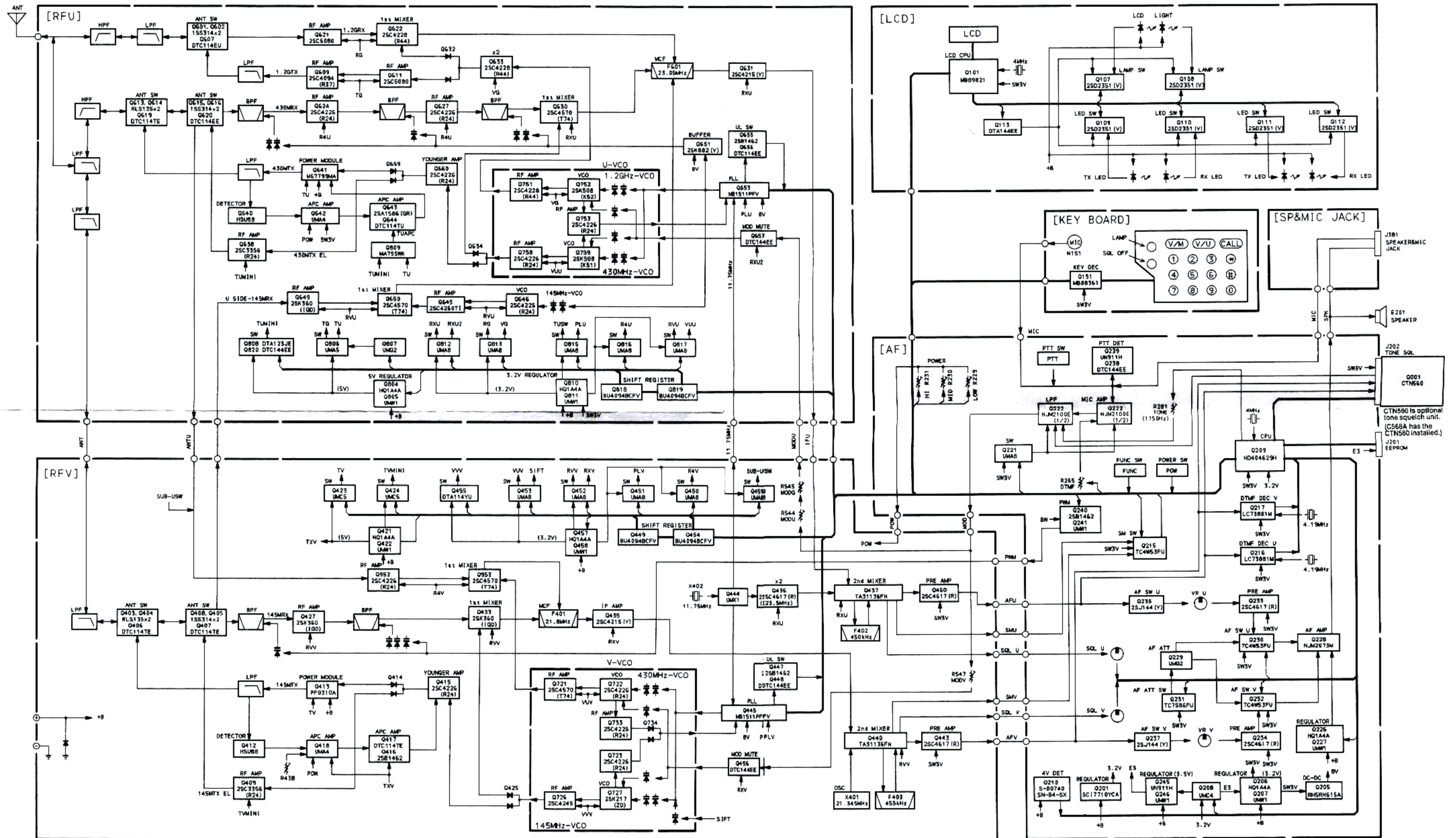

CTN560 is optional tone squelch unit. (C568A has the CTN560 installed.)