

OPERATING INSTRUCTIONS



STANDARD

C828M

2m FM 10W



WWW.HED-RADIO.DE

We are happy you have chosen our new product **STANDARD C828M**, the full solid state FM transceiver for the amateur radio in 2m band.

The Model **C828M** has been developed by your **STANDARD COMMUNICATIONS CORP** with unsparing applications of its traditionally held ultraminiaturization techniques and with its personal considerations given from the standpoint of the users. It is carefully designed in every respect and manufactured at **STANDARD's** modern factory. We are sure that a number of features and excellent reliability will provide you with great satisfaction.

TABLE OF CONTENTS

1. Features of C828M	2
2. Cautions Prior to Use.....	6
3. Installation Procedures	8
4. Communication Procedures	9
5. Repeater Offset Oscillator	10
6. "Busy" Indicator Lamp.....	10
7. Meter	11
8. Stand	11
9. Adjustment of Microphone Sensitivity	12
10. Microphone Connector	12
11. Accessory Terminal.....	13
12. Channel Increase	14
13. Accessory Parts.....	15
14. Connection of External Speaker	15
15. Antenna and Coaxial Cable	16
16. Noise Prevention Measures for Use as Mobile Station	17
17. C828M Specification.....	18
18. Block Diagram	19
19. Circuit Diagram	20

1. Features of C828M

We know that lighter and smaller high-performance equipment creates new application, and this is quite true of C828M. Such features and many others of this Model as mentioned below will enable all of you—from beginners to veterans—to enjoy a broader scope of the usages.

1. small Size and Light Weight :

This new FM transceiver, smaller in volume than a half size of the comparable products of this Company and as light as 0.96 kg, has succeeded in finding its installation space for mobile station use at vehicle driver's seat area instead of assistant driver's which has been exclusively used for this purpose in the past, ushered in the debut of a new type mounting metal bracket.

2. Push-In/Push-Out Bracket :

This metal bracket has simplified the attaching and detaching processes of C828M on a single motion basis. For attaching, just snap your transceiver into the bracket. The reverse consequence can be obtained by simply snapping it off toward you.

The bracket with the transceiver off therefrom is an evenly faced metal, which therefore prevents rattling causable during the vehicle operation and also protects your feet against a possible hazard from a sharp projection. Such attaching and detaching processes do not require you to put in your hands on the sides of the rig. Thus, the attaching process brings the sides of the rig into a close contact with their corresponding parts. The rig's occupancy of small space serves for the efficient employment of the limited interior room of the car.

3. Single Crystal System Common to Transmission and Reception :

The adoption of the single crystal system, in which one crystal is used for both transmission and reception of signals, has opened the way to an economical installation of additional channels and the very expedient experiment or operation in joint use of multifarious external oscillators.

4. One Action Repeater Changeover System :

The transceiver has 3 built-in offset oscillators including SIMPLEX. This feature together with the full advantages of the single crystal system permits changeover to the repeater channel with a finger action of switch on the front panel.

5. Call switch for Tone Burst Signal Transmission :

C828M incorporates tone burst device (CTN-5). By pressing the call switch (momentary switch) for operation of repeater channel, a high power tone burst signal is transmitted, thus assuring stabilized operation of repeater.

6. Hi-Low Power Changeover :

By setting the function switch on the front panel from "high" to "low" power position, the antenna output is reduced from 10W to 1W with resultant decrease of power consumption. This prevents radio interference and other disturbances during local QSO, providing smooth and efficient operation.

7. Remote Control System for External Oscillator Changeover :

Connection of external oscillator to the transceiver can be made simply by flipping the external oscillator switch on the microphone.

8. Professional-minded Circuit Design :

FET's, silicon transistors and diodes are abundantly used in the circuitry de-

signed with professional minded techniques and latest technical knowhow.

(a) Receiver

(1) High Sensitivity

High sensitivity design as represented by the $-3\text{dB QS } 20\text{dB}$ and the over 23dB S/N at 0dB input.

(2) Excellent Cross-Modulation Characteristics

The excellent cross-modulation characteristics are due to the use of FET's for the radio frequency amplifier and the first and second mixers, also due to the removal of the first intermediate frequency (IF) amplifier and the gains distribution made with our new technical approach.

(3) Ceramic Filter

The two ceramic filters in the second IF amplifying stage play a role for the alleviation of ripples within pass band for better selectivity characteristics.

(4) Integrated Circuits

The second IF amplifying stage consists of 3-stage amplifying unit plus the integrated circuitry, thus showing very good limiter effect.

(5) Squelch Circuit

The squelch circuit is a noise rectifier type enjoying an established reputation for mobile station use, and the circuit operates securely, thanks to the high gains resulting from the 2-stage noise amplification.

(6) Squelch Time Constant

With the squelch unit (accessory) connected to the accessory terminal on the rear panel, the squelch time constant can be changed to the best suitable value for respective uses as mobile and fixed stations.

(7) 3W of Audio Output

The maximum audio output is as high as 3W, permitting the operation of your transceiver at optimum sound level even in a noisy expressway.

(8) "Busy" Indicator Lamp

The green lamp turns off and on in association with the squelch circuit, regardless of the position of the volume control knob, to clearly indicate which rig is receiving the signal. This lamp is convenient in a parallel operation at 50MHz, 430MHz and other bands.

(9) Highly Sensitive Incoming Signal Meter

This incoming signal meter, containing a meter amplifier designed to swing the pointer in response even to weak incoming signal, can show the exact change in the input voltage of the antenna.

(b) Transmitter

(1) High-gain, High-efficiency Transistors

Newly developed high-gain, high-efficiency transistors are used. The final stage is equipped with 2N6082 providing sufficient margin to the operation.

(2) Offset Mixer Provided with FET

The MOS FET incorporated in the offset mixer of the signal transmitting section reduces the occurrence of spurious radiation.

(3) Direct FM Modulation System

The 22.0MHz frequency from the offset oscillator undergoes direct FM modulation. This eliminates the difference of modulation degree between

channels.

(4) Twisted Wire

Twisted wire is used for stable impedance conversion and wide bandwidth characteristics.

(5) Splatter Filter

The RC network filter and the transistor operated splatter filter provide high clarity and high average level of modulation, and cause no interference with other channels through expansion of the band occupancy.

(6) Microphone Gain Control

A semi-fixed resistor for microphone gain control is mounted on the main printed wiring board for transmitter.

(7) Transmitter Indicator Lamp and Meter

When the push button on the microphone is pressed, the red pilot lamp illuminates to show that the transmitter is in transmitting mode. During the transmission, the meter indicates the relative value of the transmitting output.

(8) Channel Selector With Short-circuiting Ring

The channel selector of C828M is provided with a short-circuiting ring to prevent possible interference caused when additional channels are installed or when the frequencies of neighboring channels are adjusted, thereby helping make the frequency alignment much easier during the installation of additional channels. The trimmer capacitor for delicate alignment for both the transmitter and receiver performs accurate adjustment of all the channel frequencies.

(9) Uncasing Possible with No Help of Tools

Uncasing is possible with the two screws in the rear removed by the fingertip operation. This feature lends itself to the addition of the channel and other purposes.

(10) Anodized Aluminum Chassis

Anodized aluminum is used for both the case and chassis. The main chassis is 2mm thick for an adequate mechanical strength and designed to show good heat sink effect.

(11) Antenna Connector

The M-shaped antenna connector screws have their pitches available commonly in both inch and millimeter.

(12) Microphone Connector with Speaker Terminal

A 4-pin connector is used for microphone connection. Since audio output is connected to No. 4 pin, this connector permits connection of telephone handset as well as the microphone.

(13) Accessory Terminal (A.T.)

A 9-pin accessory terminal is provided on the rear for connections of accessory units from outside.

(14) Wide Range of Operating Temperature

The operating temperature ranges from -30°C to $+60^{\circ}\text{C}$. This is good enough for mobile operation even in severely cold environments.

(15) Microphone with Switches

The microphone is equipped with external oscillator switch and P.T.T. switch (microswitch). Sharp switching from transmission mode to reception

mode or vice versa is assured.

(16) Detachable Stand

The detachable stand furnished facilitates the use of C828M as a fixed station.

(17) Power Supply Protective Circuit

The power supply circuit is provided with a protective function so as to keep the internal circuit from any possible damage caused in wrong connection of the power supply.

(18) Ant, Protector

Antenna protector circuit starts to work on, when antenna becomes to open or short circuit, or degradation of SWR. Transmitting LED goes to dark when there is no more RF output. In this occasion try to find out abnormal point on the antenna circuit and reset radio to a normal condition of the transmission. Accordingly the antenna protector circuit is automatically released to its normal condition.

2. Cautions Prior to Use

The following precautions must be observed for the maximum performance of your C828M and for your enjoyment of better ham life:

1. DO NOT Connect or disconnect the power supply cord when the power supply switch is in ON position.
2. DO NOT connect or disconnect the antenna or external speaker when the power supply switch is in ON position.
3. DO NOT push the microphone switch with the antenna left disconnected.
4. BE SURE to replace the blown-off fuse with a new one rated at 3A.
5. CHECK to see the polarity of the electrical system prior to the power supply connection. C828M is designed for negative grounding; the black lead should be connected to the ground.

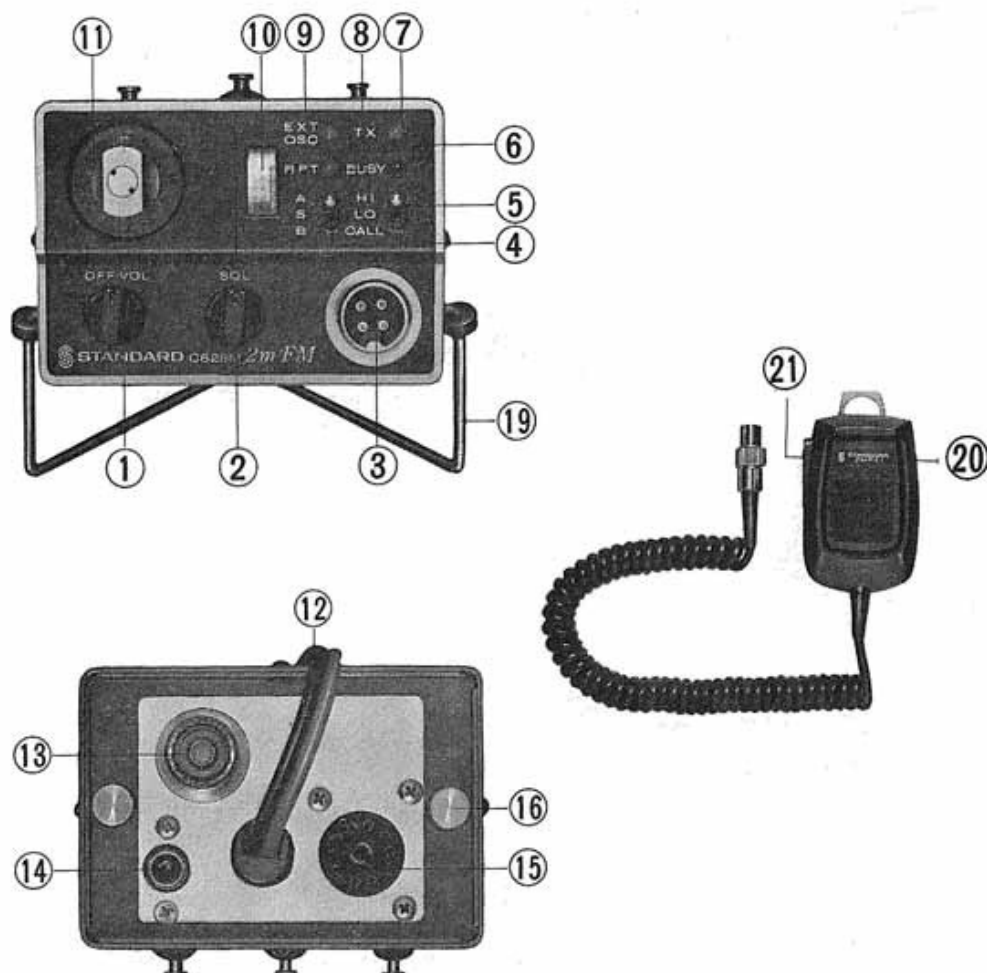

Figure 2-1

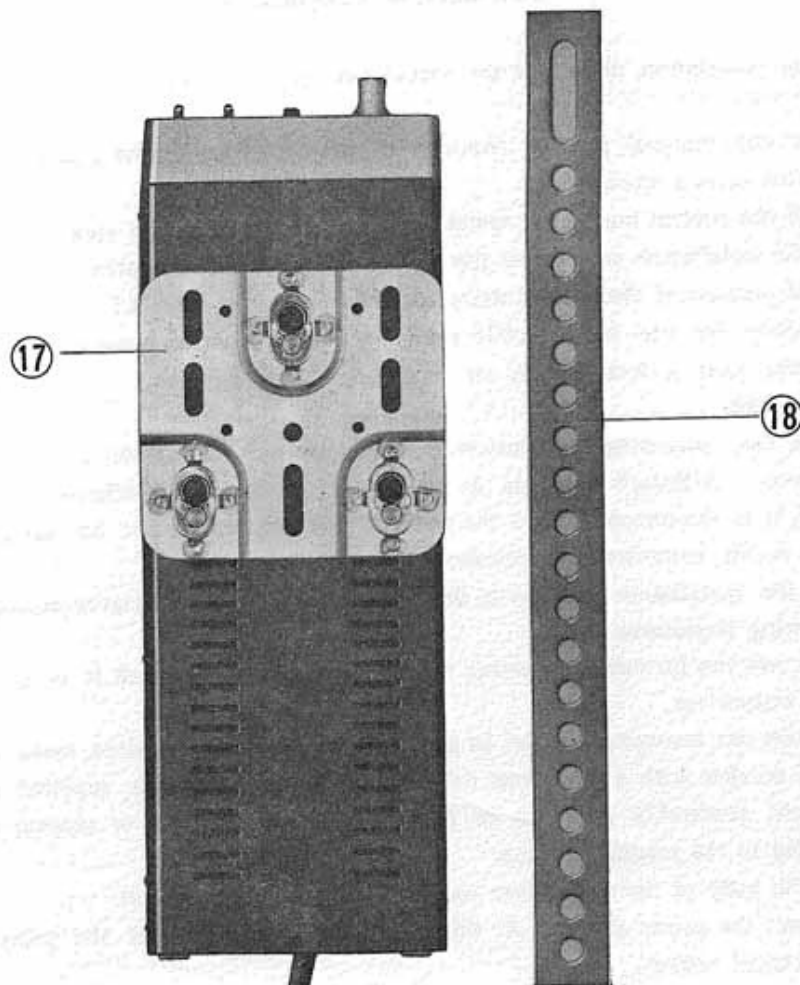

Figure 2-1

①	Volume Control Knob/ Power Switch	⑨	EXT-OSC Indicator Lamp	⑰	Mounting Metal Bracket
②	Squelch Control Knob	⑩	Meter	⑱	Auxiliary Mounting Metal Bracket
③	Microphone Connector	⑪	Channel Selector	⑲	Stand
④	REPEATER/SIMPLEX Select Switch	⑫	Power Supply Cord	⑳	EXT-OSC Switch
⑤	Hi-Low Power and Call Select Switch	⑬	Antenna Connector	㉑	P.T.T. Switch
⑥	"Busy" Indicator Lamp	⑭	External Speaker Terminal		
⑦	Transmission Indicator Lamp	⑮	Accessory Terminal		
⑧	Repeater Indicator Lamp	⑯	Case Mounting Screws		

3. Installation Procedures

Prior to installation, determine the installation position observing the following points:

- * I there any unusual posture required in the operation of the channel Selector and other control knobs?
- * Are all the control knobs and meter scale face located in plain view?
- * Isn't the installation position of the rig for use as a mobile station impeding the general motions of the vehicle driver or the operator of C828M?
- * Specifically for use as a mobile station, make sure not to place the transceiver anywhere near a heater duct, air conditioner's exhaust mouth, air intake mouth and the like.
- * Refrain from mounting the transceiver on such places as exposed to rainfall and sea water. Although there is no restriction as to the installation posture of C828M, it is recommended that the body of the transceiver be set upright for use in yachts, commercial vehicles etc.

After the installation position is determined, install the transceiver according to the following procedures:

1. Take out the furnished mounting metal bracket (17) and attach it to the body of the transceiver.
2. Position the mounting bracket in predetermined installation place, make a bore for the bracket with a 5—5.5mm drill, and secure it with the supplied screws and nuts, preferably at three or more places. Use wooden or tapping screws according to the mounting plane.
3. Set the body of the transceiver again on the mounting bracket.
4. Connect the power supply. At this time, again make sure of the polarity of the electrical system.
5. Firmly secure the antenna to the antenna connector (13). Refer to Fig. 2-1.
6. Connect the microphone to the microphone connector (3) on the front of the transceiver, and fix the supplied microphone hanger on a convenient place for lifting (see Fig. 2-1).

The above completes the installation, and you are now ready to start communication.

4. Communication Procedures

1. Preparation for Communication

First, turn the SQL knob (2) fully counterclockwise, and then set the channel selector (1) to the channel you desire to use.

2. Turn on the power supply switch.

Turn the VOL OFF knob (1) clockwise until it clicks. The channel selector lamp and the meter lamp will light up to show that the power is on.

3. Adjust the volume.

As you turn the VOL OFF knob (1) clockwise, you will come to a point where a rustling noise—or the conversation in the case someone is talking over the channel—becomes audible. Set the knob for suitable volume while listening to the noise or the conversation.

4. Set the squelch control.

Turn the channel selector and set the SQL knob (2) using an empty channel. Turn the knob slowly in the clockwise direction until you come to a point where the noise suddenly goes off.

Set the SQL knob on this point and you will hear no noise but the incoming signal alone through the speaker. In this case, if the signal is unclear because of the squelch circuit being off and on due to the signal condition of your party's station, turn the SQL knob slightly further to the right.

5. Transmission :

Set the repeater switch and hi-low power switch to the desired positions.

Take up the microphone and press the push button on the microphone. Speak into the microphone slowly and distinctly in normal tone of voice. At this time, the red lamp in the front illuminates to show the transmitting status as long as the push button remains pressed. Simultaneously, the meter indicates the comparative value of the transmission power. Now, your voice is out on the air.

5. Use of Repeater Offset Oscillator

The transceiver is provided with 3 offset oscillators including one for Simplex. Crystals are built in the first offset oscillator (22.0 MHz) for simplex and the second offset oscillator (21.4 MHz) for REPEATER A position, while the third offset oscillator for REPEATER B position is provided with a crystal socket so that a system other than repeater system, whose transmit frequency is deviated 600 kHz from the receive frequency, can be used. When the transceiver is used in the simplex mode, set the toggle switch on the front panel to the "S" position. The first offset oscillator (22.0 MHz) is operated and the transmit and receive frequencies become the same.

With the switch set to REPEATER position A, the second offset oscillator (21.4 MHz) is operated and the transmit frequency is lowered to 600 kHz below the receive frequency; thus, changeover to the repeater channel can be accomplished by one finger action. The frequency used for the first local oscillator for the repeater channel is therefore referred to the receive frequency (see "Ordering the Crystal Oscillator Element").

6. "Busy" Indicator Lamp

The green "busy" indicator lamp on the front panel turns off and on according to the emitter voltage of Q307 which is varied by the ON/OFF operation of the squelch circuit. This indicator lamp, being independent of the audio output, illuminates in green to show that signals are being received, even if the volume control is turned down; and when in parallel use of the rigs for 50 MHz, 430 MHz and others, the green lamp tells from which rig the signal is being received.

7. Meter

Meter (10) indicates the strength of the incoming signal in the receiving mode and the comparative value of transmission power in the transmitting mode. During reception of receive signal, the incoming signal strength to swing the pointer by 8 graduations is equivalent to $5\mu\text{V}$ (14 dB). The indication of receive signal output is set to about 8 graduations. See Fig. 7-1 for the relationship between the incoming signal and the scale of the meter.

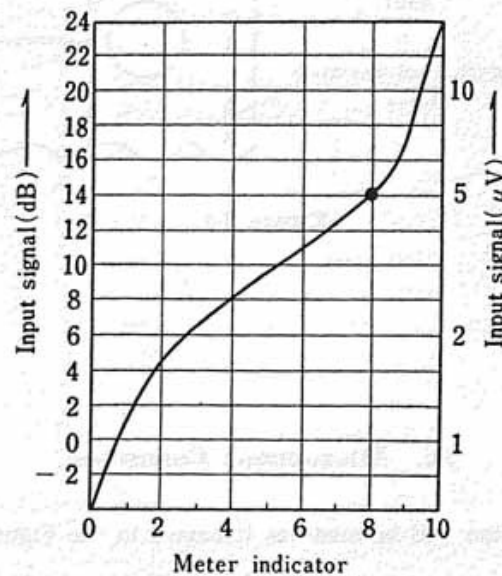
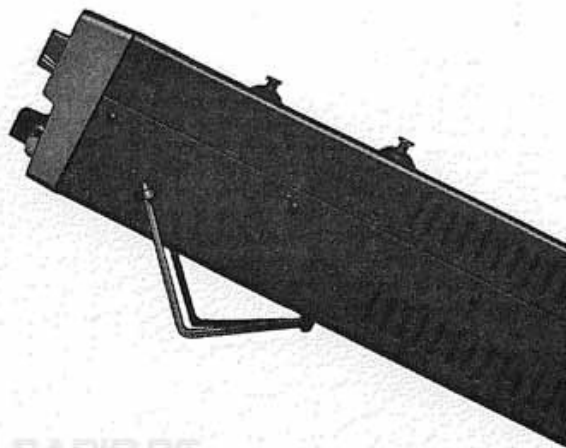

Figure 7-1

8. Stand

C828M is provided with the stand (19) for use as a fixed station. Insert the stand into the small bores on both sides of the case as shown in photo below.



9. Adjustment of Microphone Sensitivity

The microphone sensitivity is adjusted to best meet the purpose of mobile and fixed stations. However, any further adjustment of the sensitivity will be made of the semifixed resistor R301 as shown in Fig. 9-1 below.

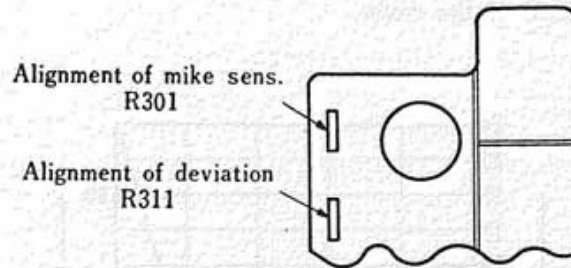
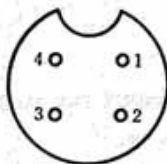

Figure 9-1

10. Microphone Connector

Microphone connection will be made as indicated in the Figure below.

Figure 10-1



- No. 1 Hot microphone terminal (common with AT-2)
- No. 2 Grounding terminal (common with AT-1)
- No. 3 Microphone push-button terminal (common with AT-3)
- No. 4 Audio output terminal (common with AT-7)

11. Accessory Terminal

The accessory terminal connection will be made as shown in Fig. 11-1. You can devise various accessory connections, using this terminal.

Terminal No.	Connection
AT-1	Grounding
AT-2	External oscillator switching
AT-3	N.C.
AT-4	N.C.
AT-5	First local oscillator input
AT-6	FM detector output
AT-7	External oscillator VFO input
AT-8	+13.8 V (receiving time)
AT-9	+13.8 V ; power supply before power supply switch is turned on

Fig. 11-1

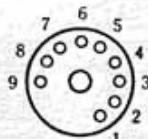

AT

12. Channel Increase

1. Specifications of Crystal Oscillating Unit

Use the crystal oscillating unit of the size of HC25/U. The first local oscillator frequency of C828M is based on 8-multiplication system, and the first intermediate frequency is 22.0 MHz. Therefore, the frequency of the crystal oscillating unit can be obtained from the following formula :

$$f_o = \frac{f_r - 22.0}{8}$$

f_o : Frequency of crystal oscillating unit (MHz)

f_r : Wanted transmit/receive frequency (MHz)

2. Crystal Oscillator Installation Procedures

When the crystal oscillating unit of your desired frequency is ready, take out the chassis of this transceiver from the case by removing the two case mounting screws from the rear. For the arrangement of the socket of the crystal oscillating unit, see Fig. 12-1 below.

CRYSTAL LOCATION

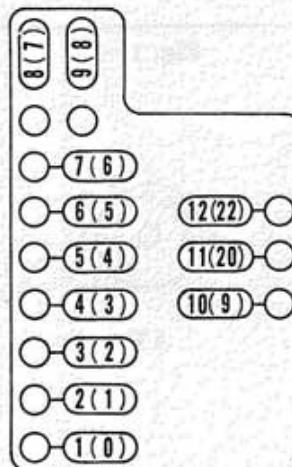

Figure 12-1

3. Frequency Adjustment

The offset oscillator of C828M and the frequencies of the actually loaded channels have been precisely adjusted. However, if additional channels are installed, be sure to perform necessary channel frequency adjustments. In case that a frequency counter is not available, conduct the adjustments according to the following procedures, using the accessory terminal :

First, connect a 30 to 50 μ A amperemeter to the accessory terminal No. 1 and No. 6 pins.

- (a) Align the receiving frequency of your station with the frequency of your party's station. While in reception of the signal from your party's station, adjust the trimmer capacitor in the crystal oscillating circuit so that the connected amperemeter indicates zero graduation. If the sound is distorted or you hear

no sound with the amperemeter pointing to zero, then make further adjustment on the trimmer capacitor till you get proper adjustment.

(b) Adjust the frequency of your party's station to your station. In this case, your party's station should be provided with a fine adjusting circuit for transmit and receive frequencies. Have him adjust his transmit and receive frequencies in the same manner.

13. Accessory Parts

The following accessory parts are available for C828M:

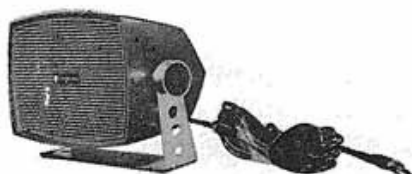

(1) Speaker box, C205K (4 ohms)



(2) AC Power supply,
C12/120-5, 13.8 V 3A



(3) AC power supply,
C12/120-2, 9~16 V 6.5A



(4) VFO, CV110

14. Connection of External Speaker

If large sound volume is desired, connect external speaker to SPK terminal on the rear panel.

Note: Use an external speaker rated at 4~8 ohms of impedance

15. Antenna and Coaxial Cables

The performance of your C828M depends on the quality of antenna and coaxial cables. Pay attention to the following when you purchase your antenna and coaxial cables.

Antenna :

1. Use the antenna having a matched impedance of 50 ohms.
2. Install the antenna as high as possible. Roof top is recommended for installation for mobile station use.
3. Use the antenna of high performance.

Coaxial Cable :

1. Use the coaxial cable having a matched impedance of 50 ohms. Do not use 3C-2V, 5C-2V, etc., because they are rated at 75 ohms of impedance.
2. The coaxial cable should be preferably as large as possible in size. If the cable length is less than 5m, use RG-58U, 5D-2V, etc. If the cable length is longer than 5m, use RG-8U, 8D-2V, 10D-2V, etc. See Fig. 15-1 below.

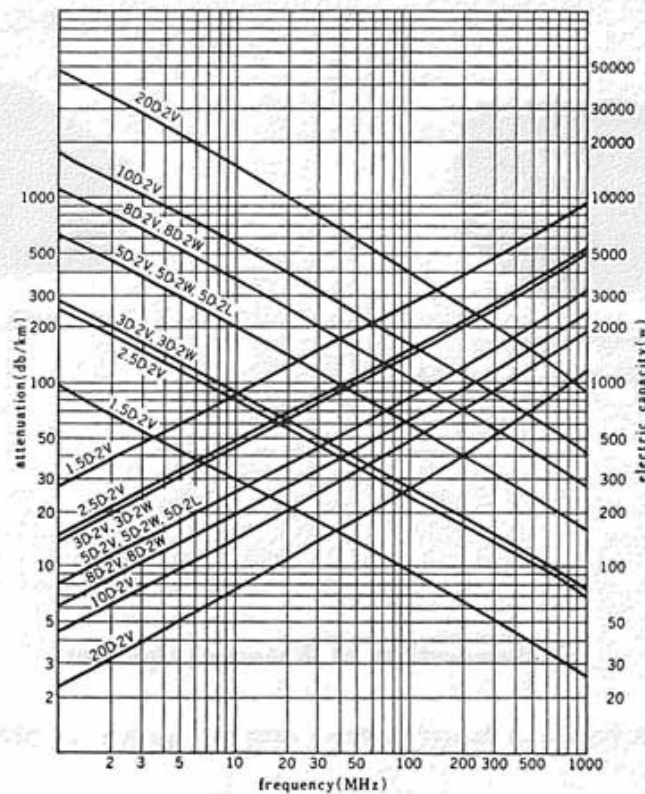

Figure 15-1

16. Noise Prevention Measure for Use as Mobile Station

Precautions for installation of this transceiver in cars and others have been mentioned previously. The following measures will be effective for installation in specific types of cars and motor-boats whose engine may produce excessive noises :

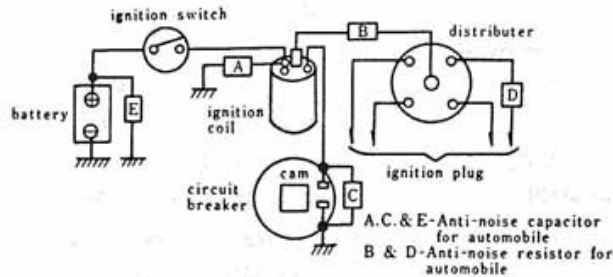

Figure 16-1

The noise prevention capacitors and resistors may be inserted in the places shown as A, B, C, D and E in Fig. 16-1 above. In some cars, the noise can be prevented with such insertion at only one place. In some other cars, noise can be decreased if C828M is powered by car or motor-boat battery directly wired to the transceiver.

17. C828M Specification

General

- | | |
|--|--|
| 1. Application : | 144 MHz and FM amateur transceiver |
| 2. Number of Channels for Transmitter/Receiver : | 12 channels |
| 3. Frequency Range : | 144.0~146.0 MHz, 145.0~147.0 MHz and 146.0~148.0 MHz |
| 4. Operating Temperature Range : | -30°C~+60°C |
| 5. Microphone : | Dynamic type with memory switch (with Neoprene coiled cord) |
| 6. Power Supply Voltage : | 13.8 V DC±20% (negative grounding) |
| 7. Power Consumption : | In transmission : 2.6A
In reception (Max. Output): 0.8A
In standby : 0.32A |
| 8. Semi-Conductor : | 37 transistors, 20 diodes and 1 IC |
| 9. Dimensions : | 84(W)×58(H)×235(D) mm |
| 10. Weight : | 0.96 kg |

Transmitter :

- | | |
|----------------------------------|---|
| 1. Transmitting Radio Wave : | F3 |
| 2. Transmitting Output : | 10W min-Hi-power 1W nom-Low power |
| 3. Output Impedance : | 50 ohms |
| 4. Maximum Frequency Deviation : | ±5 kHz |
| 5. Modulation System : | Direct FM modulation by offset oscillator |
| 6. Frequency Stability : | Less than 0.002% |
| 7. Frequency Multiplication : | 8 times, 1 heterodyne |
| 8. Modulation Distortion : | Less than 10% |
| 9. S/N : | Better than 45 dB |

Receiver :

- | | |
|--|---|
| 1. Receiver Model : | Double conversion superheterodyne |
| 2. Intermediate Frequency : | First IF 22.0 MHz
Second IF 455 kHz |
| 3. First Local Oscillator Frequency Multiplication : | 8 times |
| 4. Frequency Stability : | Less than 0.003% |
| 5. Sensitivity (20 dB QS) : | Better than -3 dB (0 dB=1μV) |
| 6. S/N at 0 dB Input : | Better than 23 dB |
| 7. Squelch Threshold Sensitivity : | Better than -10 dB |
| 8. Bandwidth : | 10 kHz or more |
| 9. Selectivity : | 75 dB or more (25 kHz detuning) |
| 10. Spurious Response : | 70 dB or more |
| 11. Allowable Maximum Frequency Deviation : | ±5 kHz |
| 12. Audio Output : | External speaker (4 ohms)-Max. Output 3 W |

Blockschaltbild und Schaltplan / Block-Diagramm and schematic STANDARD C-828

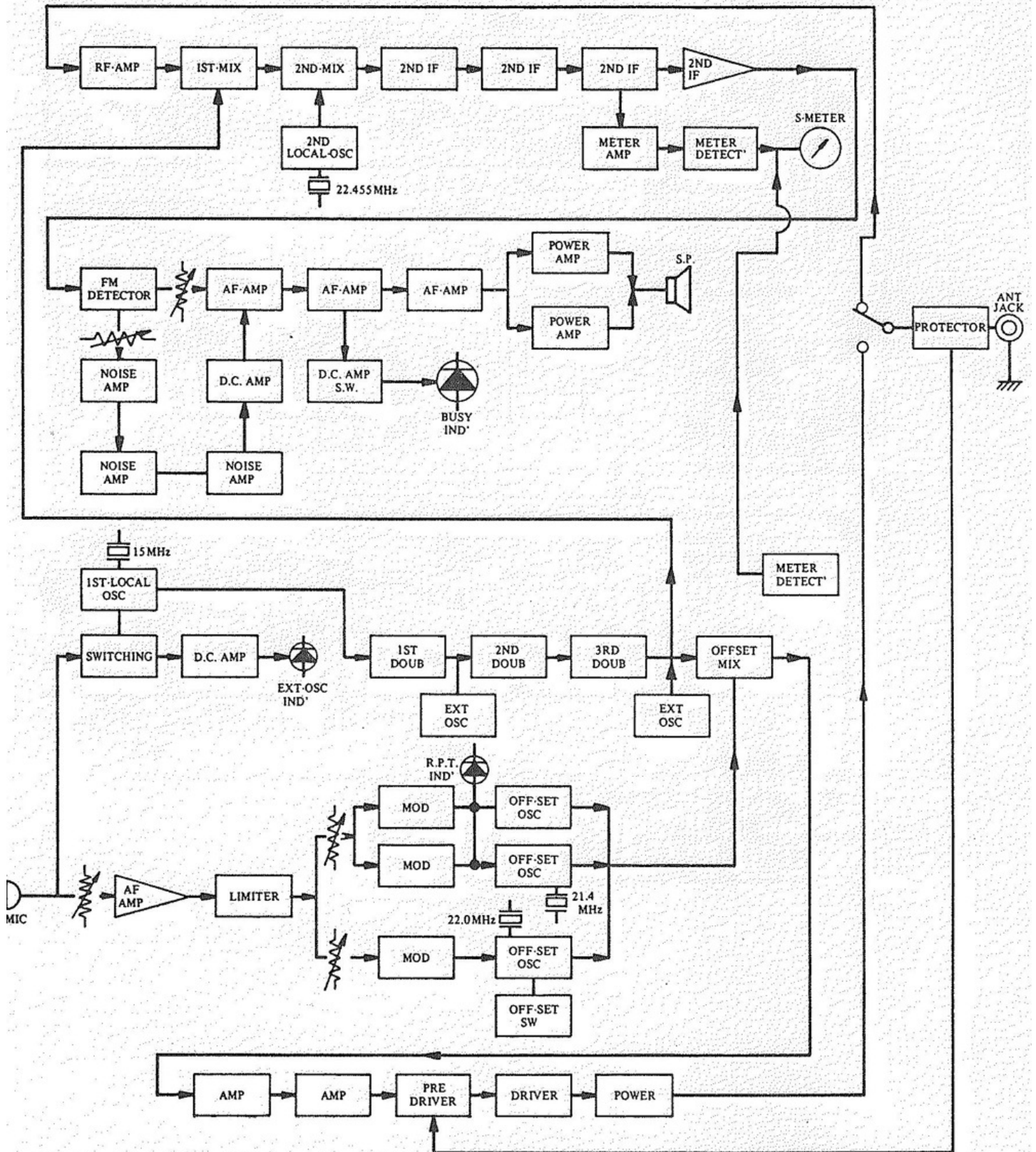

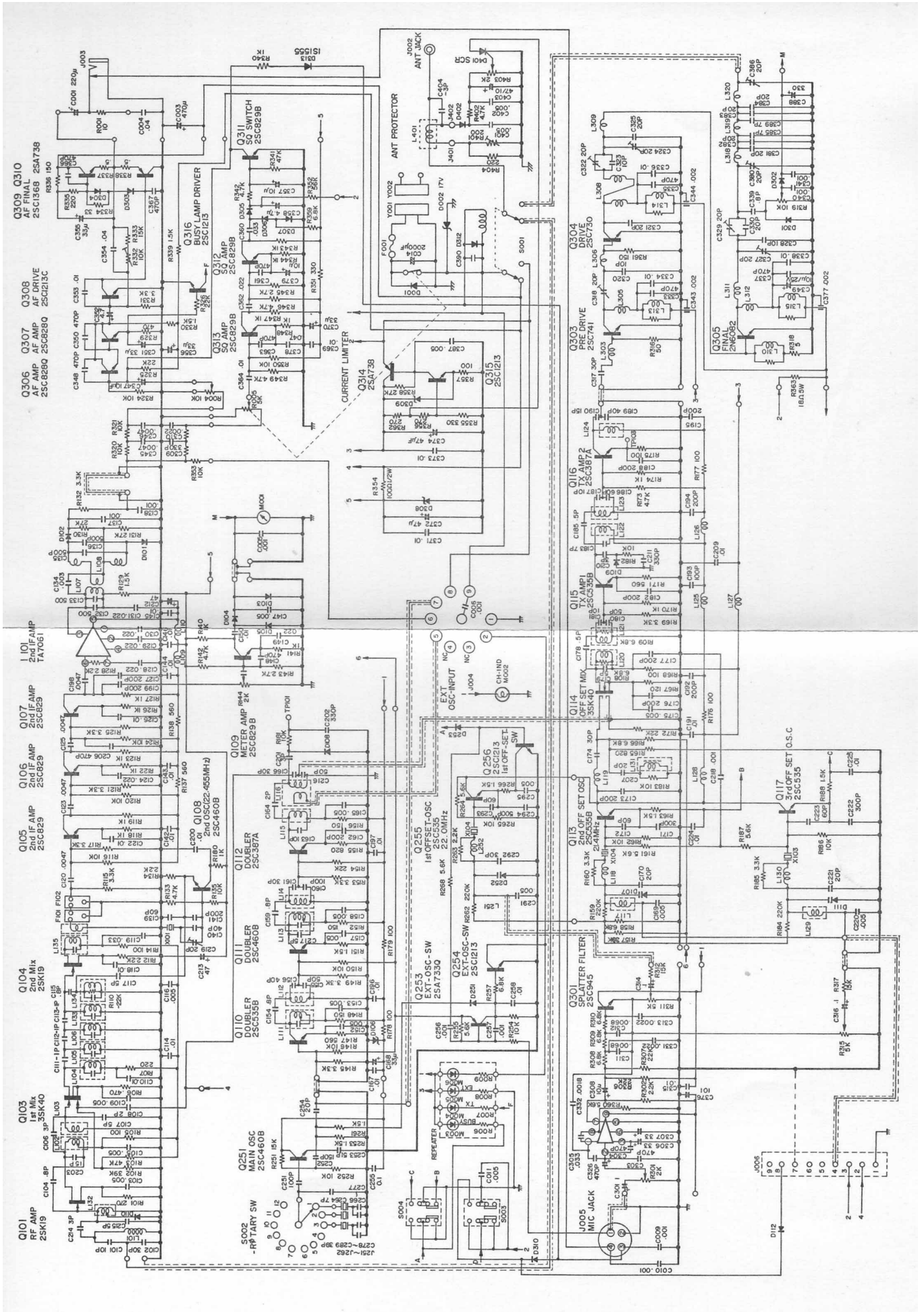

Schaltplan / shematic microphone CMP-31

CMP-31 Schematic Diagram

