

Thanks for buying the  Wouxun KG-UV950P mobile radio.

This mobile radio offers latest design, enhanced features, solid performances and easy accessibility. We believe you will be pleased with the high quality and reliable features for all your communication needs.

Read this important information on the safe and efficient operation before using mobile radio. This manual is suitable for KG-UV950P.

Safety information



The KG-UV950P is an electrical apparatus, as well as a generator of RF(Radio Frequency) energy, and you should exercise all safety precautions as are appropriate of this type of device. These safety tips apply to any device installed in a well-designed amateur radio station.

- ⚠ Explosive atmospheres(gases, dust, fumes, etc.).Turn OFF your mobile radio while taking on fuel or while parked in gasoline service stations. Do not carry spare fuel containers in the trunk of your vehicle if your mobile radio is mounted in the trunk area.
- ⚠ Injury from radio frequency transmissions. Do not operate your mobile radio when somebody is either standing near to or touching the antenna, to avoid the possibility of radio frequency burns or related physical injury.
- ⚠ Dynamite blasting caps. Operating the mobile radio within 150m(500 feet) of dynamite blasting caps may cause them to explode. Turn OFF your mobile radio when in a area where blasting is in progress, or where "TURN OFF TWO-WAY RADIO" signs have been posted. If you are transporting blasting caps in your vehicle, make sure they are carried in a closed metal box with a padded interior. Do not transmit while the caps are being placed into or removed from the container.
- ⚠ Never allow unsupervised children to play in the vicinity of your mobile radio or antenna installation.
- ⚠ Be certain to wrap any wire or cable splices thoroughly with insulating electrical tape, to prevent short circuits.
- ⚠ Do not route cables or wires through door jambs or other locations where, through wear and tear, they may become frayed and shorted to ground or to each other.
- ⚠ Do not stand in front of a directional antenna while you are transmitting into that antenna. Do not install a directional antenna in any location where humans or pets may be walking in the main directional lobe of the antenna's radiation pattern.

Safety information

- ⚠ In mobile installations, it is preferable to mount your antenna on top of the roof of the vehicle, if feasible, so as to utilize the car body as a counterpoise for the antenna and raise the radiation pattern as far away from passengers as possible.
- ⚠ During vehicular operation when stopped(in a parking lot, for example), make it a practice to switch to Low power if there are people walking nearby.
- ⚠ Never wear dual-earmuff headphones while driving a vehicle.
- ⚠ Do not attempt to drive your vehicle while making a telephone call on an autopatch using the DTMF microphone. Pull over to the side of the road, whether dialing manually or using the auto-dial feature.

Notice

- » All of the above advice is suited to the use of your  Wouxun mobile radio and its accessories. If they do not function normally, please get in touch with the  Wouxun dealer immediately.
- » If you use components or accessories not sold by Wouxun Company, Wouxun will not guarantee the safety and usability of the transceiver.

Checking the equipment	1
Standard accessories	1
Description of functions	2
Technical specifications	3
Pre-use installation	4-12
Transceiver installation	4-5
Connecting power source	6
Antenna connection	7
Front panel installation	8-11
Accessories installation	12
Getting started	13-16
Front panel	13
LCD	14
Back panel	15
Side panels	15
Hand microphone	16
Your first QSO	17-20
Adjusting the volume	18
Selecting frequency	18-20
Selecting output power	20
Transmitting	21
Shortcut operation chart	22-23
Menu operation sheet	24-27

Function description	28
Hotkey function guide	29-34
Menu operations	35-36
Step frequency settings (STEP) ---- Menu 1	35
Wide/Narrow bandwidth settings (W/N) ---- Menu 2	35
Two medium level power settings (MPOWSET) ---- Menu 3	35
Offset frequency settings (OFF-SET) ---- Menu 4	36
Transmission prompt settings (ROGER) ---- Menu 5	36
Beep prompt settings (BEEP) ---- Menu 6	36
Voice prompt settings (VOICE) ---- Menu 7	36-37
Busy channel lock-out (BCL) ---- Menu 8	37
Mute settings (SP-MUTE) ---- Menu 9	37-38
Scan mode settings (SC-REV) ---- Menu 10	38
Transmission time-out timer (TOT) ---- Menu 11	38
Transmission overtime alarm (TOA) ---- Menu 12	38-39
Caller ID transmission settings (ANI-SW) ---- Menu 13	39
Ring time (RING) ---- Menu 14	39
Editing Caller ID (ANI-EDIT) ---- Menu 15	39-40
DTMF sidetone settings (DTMFST) ---- Menu 16	40
Caller ID transmission mode (PTT-ID) ---- Menu 17	40-41
Transmission backlight (TX-LED) ---- Menu 18	41

Contents

Standby backlight (WT-LED) ----- Menu 19	41
Receiving backlight (RX-LED) ----- Menu 20	41
Deleting a channel (DEL-CH) ----- Menu 21	41-42
Editing a channel name (CH-NAME) ----- Menu 22	42
Priority channel switch (PRICH-SW) ----- Menu 23	42-43
Speaker settings (SPK- CONT) ----- Menu 24	43
Keypad autolock (AUTOLOCK) ----- Menu 25	43
Receiving CTCSS (RX-CTC) ----- Menu 26	43-44
Receiving DCS (RX-DCS)----- Menu 27	44
Transmitting CTCSS (TX-CTC) ----- Menu 28	44
Transmitting DCS (TX-DCS) ----- Menu 29	44-46
Repeater speaker switch (RPT-SPK) ----- Menu 30	46
Repeater PTT switch (RPT-PTT) ----- Menu 31	46
Repeater settings (RPT-SET) ----- Menu 32	46-49
Scan add (SCAN-ADD) ----- Menu 33	49
Automatic power-off (APO-TIME) ----- Menu 34	49-50
Single-tone pulse frequency (ALERT)----- Menu 35	50
Compand (COMPAND)----- Menu 36	50
Overheating detection (FAN-SET) ----- Menu 37	50-51
Voltage testing (LOW -V) ----- Menu 38	51
Voice scrambler (SCRAM) ----- Menu 39	51-52

Saving scanned CTCSS/DCS (SC-QT) ----- Menu 40	52
CTCSS scanning (SC-CTC) ----- Menu 41	52-53
DCS scanning (SC-DCS) ----- Menu 42	53
Scan group settings (SC-GROUP) ----- Menu 43	53-54
Remote control (RC-SW) ----- Menu 44	54
Side key setting (PF1-SET) ----- Menu 45	54
Repeater receipt tone (RPT-TONE) ----- Menu 46	54-55
Reset settings (RESET) ----- Menu 47	55
FM radio function (FM-RADIO) ----- Menu 48	55
AM frequency auto-recognize switch (AUT.AM) ----- Menu 49	55-56
AM setting (AM-SW) ----- Menu 50	56

*Note: Menu48/49/50 can only be set on A (left) area.

How to operate the FM radio	56-57
Turning on	56
Tuning radio stations	56-57
Storing and calling out FM radio stations	57
Exiting the FM radio mode	57
Repeater usage	58-60
Repeater PTT option	58
Repeater SPK option	58
Cross-band repeater entry and exiting	58

Contents

Hand microphone encoding function	61
Remote control function	62-69
Remote control activation	62-63
Stun	63
Kill	63
Monitoring	63
Inspection	63
Remote control power on / off	64
Remote changing settings	64-69
Wire-clone function	69
Optional accessories	70
Troubleshooting	71
Announcement	72

Checking the equipment

Carefully unpack the transceiver. We recommend that you identify the items in the following table before discarding the packing material.

If any item is missing or has been damaged during shipment, please notify your **Wouxun** dealer.

Standard Accessories

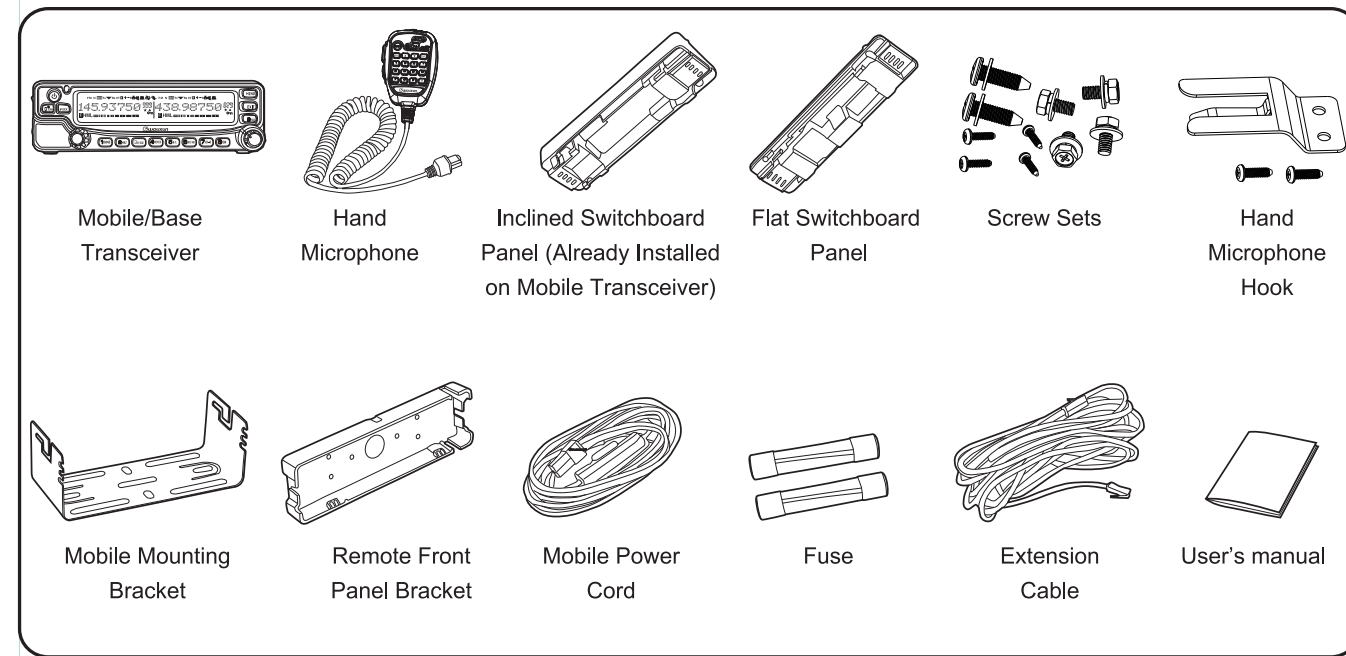

Description of functions

1. Full Duplex Cross-band repeater
2. Both Stations can Form Combined Same or Different Band (s) Repeat
3. Full Duplex Working Mode on A/B Areas (e.g.: A area transmitting and B area receiving at the same time, vice versa)
4. Dual Speaker & Dual Output
5. Same or Different Band (s) Simultaneous Reception: UU,VV,UV or VU
6. Frequency Range Suitable for any Region of any Country:
RX: 26.000-29.995MHz & 50.000-53.995MHz
108.000-179.995MHz & 320.000-349.995MHz
400.000-479.995MHz & 700-985MHz
TX: 26.000-29.995MHz & 50.000-53.995MHz
136.000-174.995MHz & 400.000-479.995MHz
7. Dual Display (Large LCD Dual Frequency Display, two Completely Independent Operating Systems)
8. Over 999 Memory Channels (Area Scanning Management)
9. Remote-head Mounting Capacity (Multiple Installation Types, Convenient Usage)
10. UV or VU Duplex Cross-band Repeat (Offset Frequency Programmable)
11. Air Band Receiving Function & AM Mode Receiving Capacity
12. High Output Power: VHF 50W, UHF 40W
13. CTCSS/DCS Encoding & Decoding, CTCSS/DCS Scanning
14. Multiple Speaker Output Settings
15. DTMF Hand Microphone with Speaker, TX/RX Indicator and Volume Controller
16. Incoming (Caller) ID Display
17. DTMF Encoding & Decoding
18. Group Calls, All Calls and Selective Calls
19. 8 Groups Scrambler
20. Priority Channel Scanning
21. APO Power Management
22. Bandwidth Selectable
23. Chinese/English Voice Guide
24. Automatic Temperature Testing
25. Minimum Operating Voltage Settings
26. Stun and Kill Function
27. 2100Hz / 1750Hz / 1450Hz / 1000Hz Single Tone Pulse Frequency (Used when activating repeater signal)
28. Three Colors Backlight Selectable
29. Remote Control Setting
30. Frequency / Channel Scanning with CTCSS / DCS Detection
31. Multiple Cooling Ways
32. Simultaneous Scanning on AB Areas

Technical specifications

General		Receiver	Wide bandwidth	Narrow bandwidth	
Frequency Range	Frequency Range Suitable for any Region of any Country: RX: 26.000-29.995MHz & 50.000-53.995MHz 108.000-179.995MHz & 320.000-349.995MHz 400.000-479.995MHz & 700-985MHz TX: 26.000-29.995MHz & 50.000-53.995MHz 136.000-174.995MHz & 400.000-479.995MHz	Adjacent Channel Selectivity	≤ 70dB	≤ 60dB	
		Intermodulation	≤ 65dB	≤ 60dB	
		Spurious Response	≤ 70dB	≤ 70dB	
		Audio Response	+1~-3dB(0.3~3KHz)	+1~-3dB(0.3~2.55KHz)	
Step Frequency	5KHz / 6.25KHz / 10KHz / 12.5KHz / 20KHz / 25KHz / 30KHz / 50KHz / 100KHz	Signal to Noise Ratio	≥ 45dB	≥ 40dB	
Memory Channels	999	Audio Distortion	≤ 5%		
Work Mode	F2D / F3E	Audio Power	Transceiver ≤ 3W Hand Microphone ≤ 1W		
Operating Temperature	-20℃~+40℃	Sensitivity	400.000-479.995MHz:0.25uV(13dB SINAD)		
Antenna Impedance	50Ω		136.000-174.995MHz:0.25uV(13dB SINAD)		
Power Requirement	13.8VDC ± 15% (Negative Grounded)		50.000-53.995MHz:0.25uV(13dB SINAD)		
Weight	1437.8g (including microphone)		26.000-29.995MHz:0.25uV(13dB SINAD)		
Dimensions	140 x 44 x 207 (mm)	320.000-349.995MHz:0.25uV(13dB SINAD)		700.000-985.995MHz:-97.0dBm(13dB SINAD)	
Transmitter	Wide bandwidth	Narrow bandwidth	Transmitter	Wide bandwidth	Narrow bandwidth
Type of Modulation	16K F3E	11K F3E	Max. Frequency Deviation	± 5KHz	± 2.5KHz
Adjacent Channel Power	≥ 70dB	≥ 60dB	Frequency Stability	± 5ppm	
Spurious	≥ 60dB	≥ 60dB	Audio Distortion	≤ 5%	
Audio Response	+1~-3dB(0.3~3KHz)	+1~-3dB(0.3~2.55KHz)	Output Power	50W/20W/10W/5W(VHF)	
				40W/20W/10W/5W(UHF)	

Note: Different countries or areas are differing from the specific applicable working frequencies and parameters.

Pre-use installation

Transceiver installation

Choose a safe place inside your vehicle, one which would to the greatest extent reduce possible harm to passengers inside the car while the car is moving. It is recommended to install the transceiver on the lower part of the front meter gauge, it will prevent the transceiver from colliding with the driver in the instance of emergency or sudden braking. Install the transceiver in an area with good ventilation and avoid installing in a place with direct contact with the sun.

1. Use the supplied self-tapping screws to install the support bracket to the vehicle.

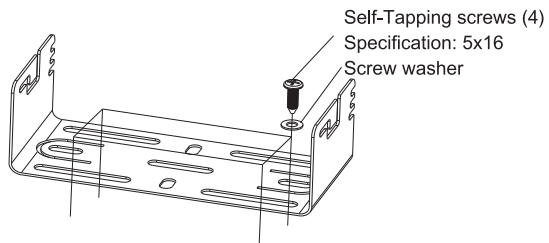

2. Set the transceiver in the bracket, then insert the supplied combined screws and tighten, insure that the screws are fastened tightly. This will insure the support bracket and the transceiver do not get bumped lose when the vehicle hits bumps or shakes.

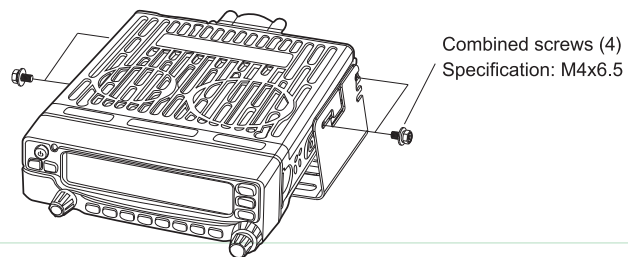

3. Use every screw slot along the side of the support bracket, you can set the transceiver to be installed at a different angle.

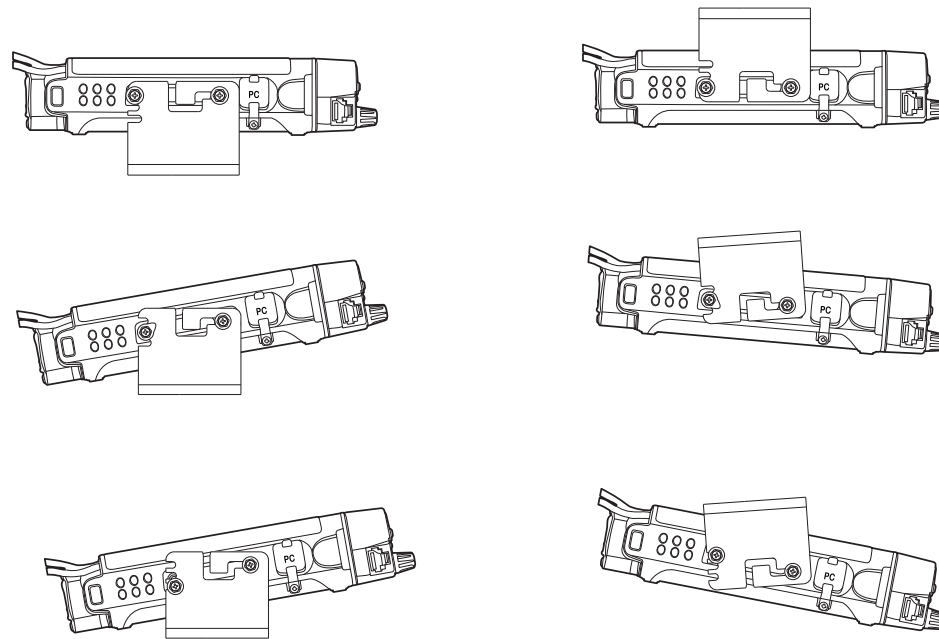

Connecting power source

The transceiver power source usage ranges from $13.8V \pm 15\%$. When your power source (or vehicle power source) reaches levels up to 16V, TX will be forbidden, however RX will operate as normal. When your power source (or vehicle power source) reaches levels as low as 11.5V, the transceiver will automatically shut off. So the transceiver does not exhaust the vehicles battery and affect the vehicles normal operation. (This feature is set by the Menu 38, see instruction on P49-50)

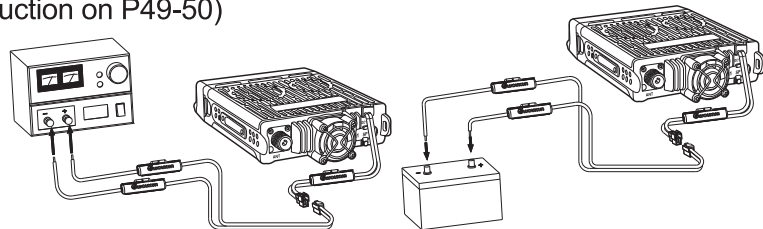

Special Reminder

» This transceiver's working voltage is $13.8V \pm 15\%$ DC.

■ Replacing the fuse

In the instance that the transceiver blows a fuse, first find out the reason, then solve the malfunction. If after installing the new fuse it once again blows a fuse, please sever the power source and immediately contact a local authorized **Wouxun** dealer or service center for assistance.

The specified fuse current is 15A, The specified power source current is 20A and above.

See the Fuse installation diagram on the right, after installation the fuse should be firmly secured to the copper set!

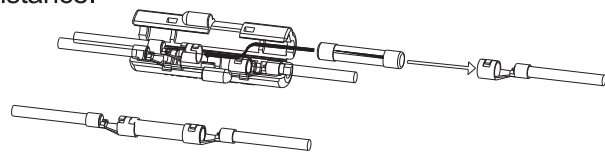

Antenna connection

Before operation, you must effectively install and adjust the antenna, installation success depends upon the type of antenna and whether or not the antenna is set up correctly. If you use the most suitable antenna and the antenna is installed correctly, the transceiver will attain the greatest results.

The transceiver antenna's impedance is 50 ohms, if the impedance is not at 50 ohms it will reduce the performance of the transceiver and possibly interfere with nearby broadcasting stations as well as other antenna's receivers, it could even harm the transceiver.

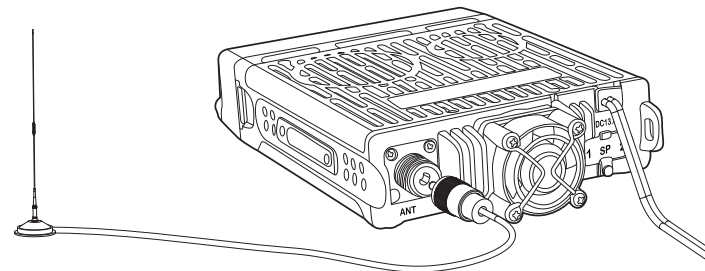

Front panel installation

The transceiver is supplied with two kinds of switchboard panels: Inclined switchboard panel and a flat switchboard panel.

■ Install inclined switchboard panel

(1) Lower alignment

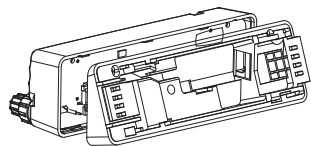

(2) Cover alignment

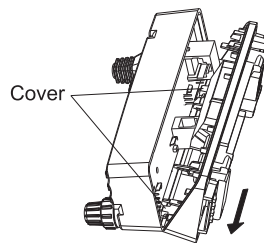

(3) Close in the direction shown by the arrows

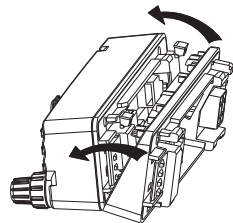

(4) Use the supplied screws to fasten

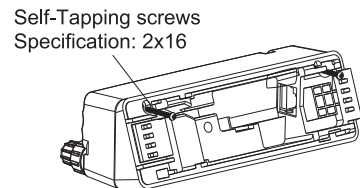

■ Install flat switchboard panel

(1) Lower alignment

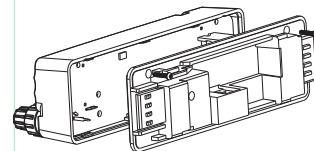

(2) Cover alignment

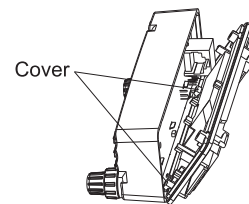

(3) Close in the direction shown by arrows

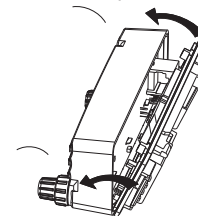

(4) Use the supplied screws to fasten

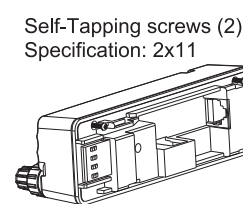

■ Front panel and main station installation

(1) Connect the cable to the transceiver's 8 point socket.

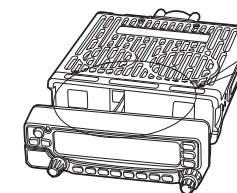

(2) Proceed according to the arrow shown.

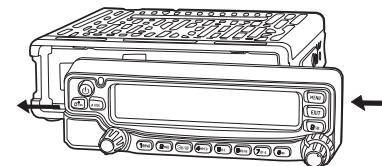

Front panel installation

Connection method for transceiver station to operating front panel:

The vehicle transceiver connection line uses 8 facets and 8 lead conducting wires (diagram 1),

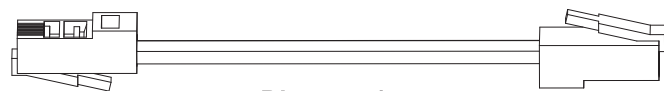
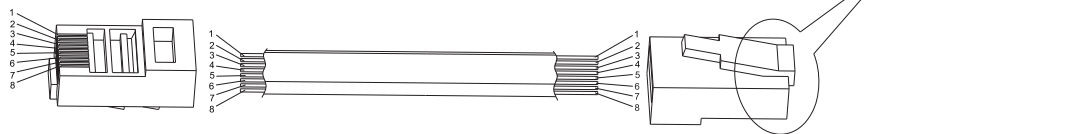

Diagram 1

The two ends of the facets connect to the corresponding line: (Take note that direction of the connection lines on the left and right sides of the facet are not the same)



Left facet connection point 1
Left facet connection point 2
Left facet connection point 3
Left facet connection point 4
Left facet connection point 5
Left facet connection point 6
Left facet connection point 7
Left facet connection point 8

Connect through the conducting wire to right facet 1
Connect through the conducting wire to right facet 4
Connect through the conducting wire to right facet 3
Connect through the conducting wire to right facet 2
Connect through the conducting wire to right facet 5
Connect through the conducting wire to right facet 6
Connect through the conducting wire to right facet 7
Connect through the conducting wire to right facet 8

Therefore the conducting wires connection to the left facet is corresponding and the connection to the right facets 2 and 4 are swapped.

Special Reminder

» If the connection wires are not Wouxun Company supplied or dealer approved, Wouxun Company does not guarantee its safety and operational effectiveness!

■ Dismantling the front panel and transceiver

(1) Disconnect cover in the direction of the arrow

(2) Remove in the direction shown by the arrow

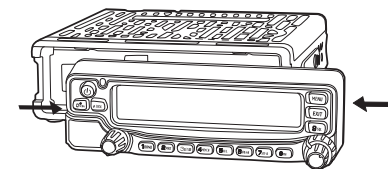
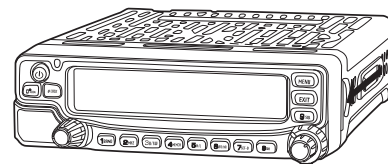

■ Installation of front panel support bracket

When the transceivers front panel is installed separately from the main platform, there is a supplied front panel support bracket designed especially for installation.

(1) First secure the support bracket with the supplied screws

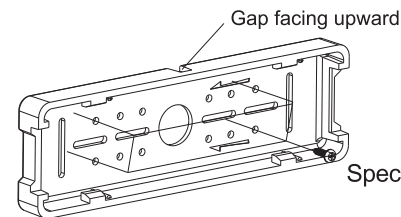

Specification: 2.3X8 (4pcs)

Accessories installation

(2) First string the connection line through opening in the center of the support bracket, then close the bracket cover directly as shown by the arrows.

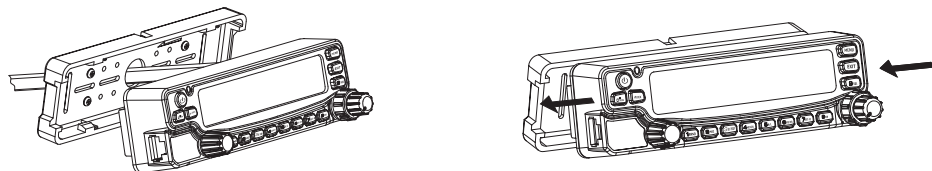

Outer speakers

The external speaker jacks can be connected to a 3.5mm single outlet. There are two speaker outlets located on the back of the transceiver.

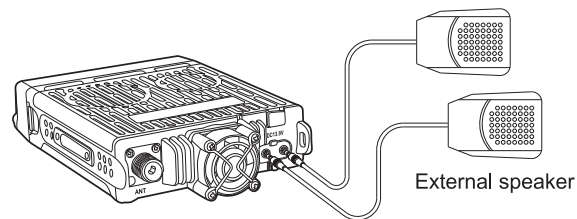

Hand microphone installation

The transceiver comes supplied with two different types of hand microphone: Encoded hand microphone and unencoded hand microphone. Plug the connection cable into the 8 point socket located on the front panel.

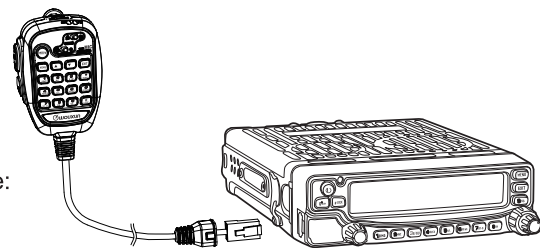

Getting started

Front panel

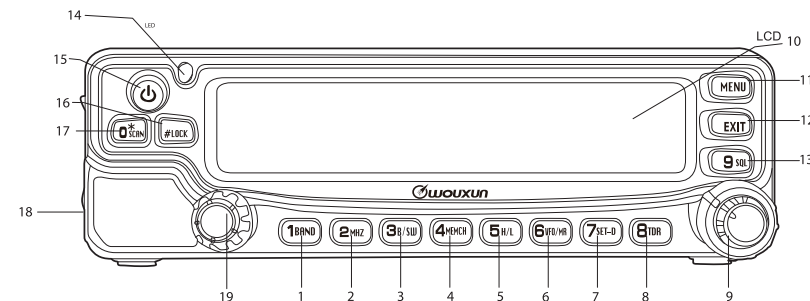

- | | |
|---|---|
| 1 Master frequency set up hot key (See hot key operation 1)
/Single-tone pulse key (see Menu 35) | 11 Function keys / enters keys |
| 2 Frequency or channel selection. (See hot key operation 2) | 12 Exit / Cancel keys |
| 3 Band switching hot key (See hot key operation 3) | 13 Squelch level adjustment hot key (See hot key operations 9) |
| 4 Save channel hot key (see hot key operation 4) | 14 Status indicator light
Orange standby indicator light
Green RX indicator light
Red TX indicator light |
| 5 Power output settings hot key | 15 Power switch button |
| 6 VFO/MR switch over hot key (see hot key operation 6) | 16 Keyboard lock key (See keyboard lock) |
| 7 Frequency shift direction hot key (See hot key operation 7) | 17 Scanning key (See scanner function) |
| 8 TDR Single and dual display switch hot key
(See hot key operation 8) | 18 Hand microphone outlet |
| 9 Volume control (See volume control) | 19 Channel encoder |
| 10 LCD | |

Getting started

LCD

All kinds of performance parameters can be selected on the LCD screen. Sometimes, you may be unable to think of what they mean or how to change them. The following table will be extremely useful at such times.

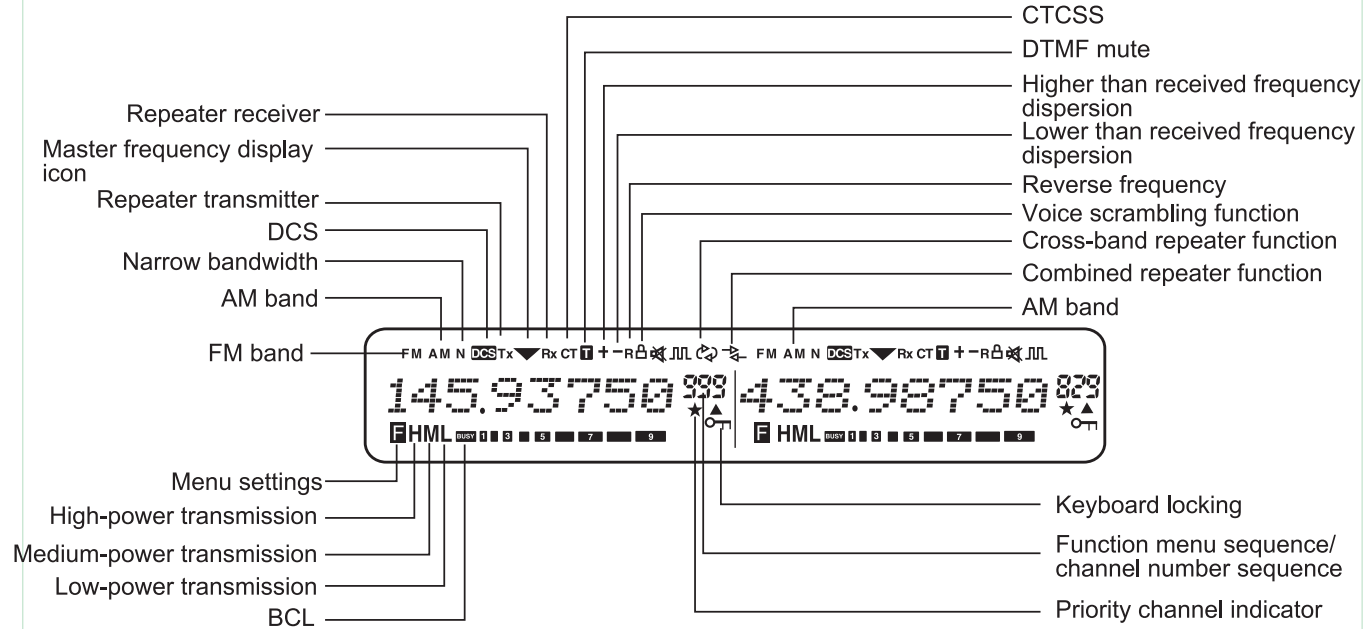

Back panel

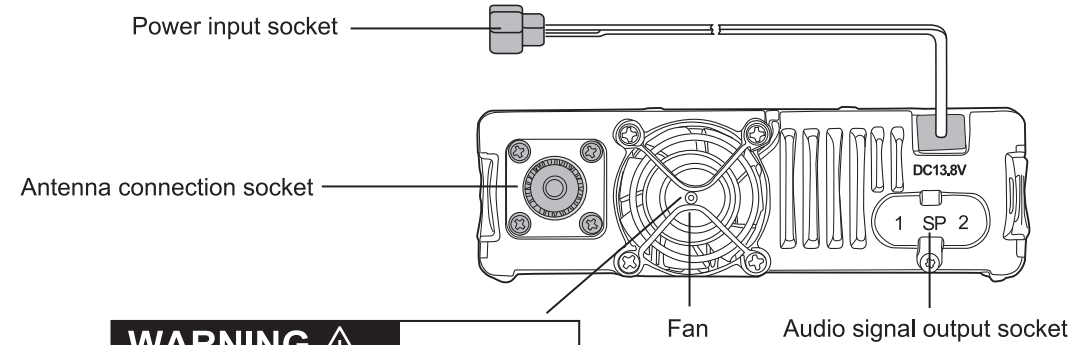

WARNING

» Hazardous moving parts, keep fingers and other body parts away.

Side panels

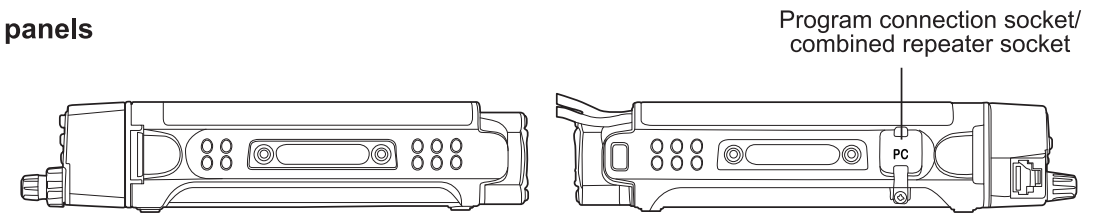

Getting started

Hand microphone

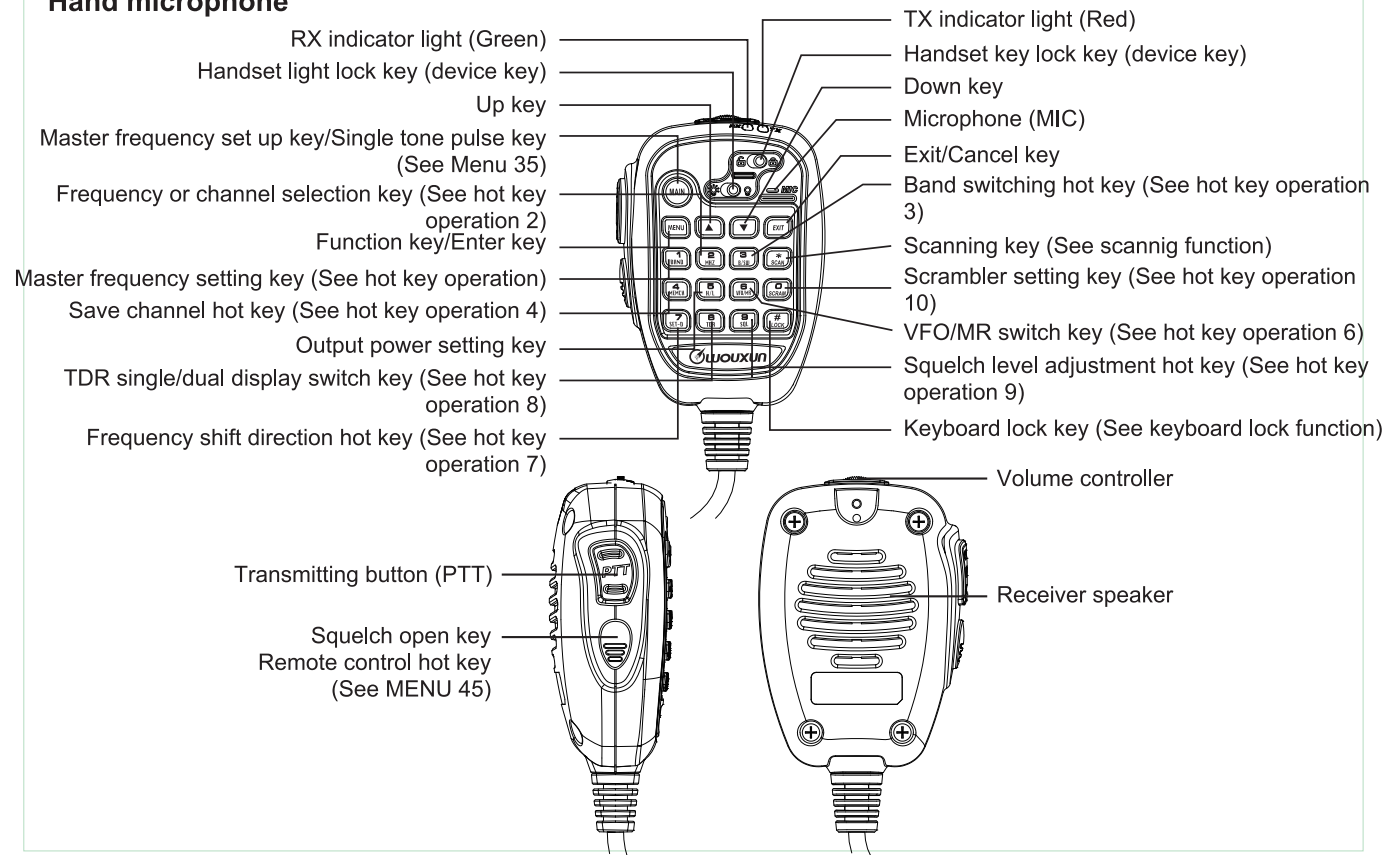

Your first QSO

First QSO

Do you want to hurry up and use your transceiver? After reading these chapters and sections you will know how to broadcast your voice out into the sky. Following is a quick instruction manual. If you encounter any problems or need further explanation, please read the detailed explanation later in this manual.

1. Installing the transceiver. (See pre-usage installation)
2. Installing the antenna. (See pre-usage installation)
3. Connecting the power source, or vehicle power source. (See pre-usage installation)
4. Press  to turn on the transceiver, the transceiver will make a long double beeping tone, the transceivers brand and model will be displayed and the transceiver will enter standby status.

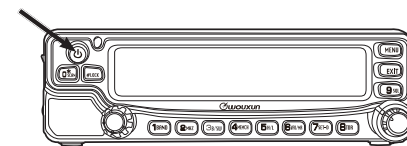

Press the key shown by the arrow



Display brand and model

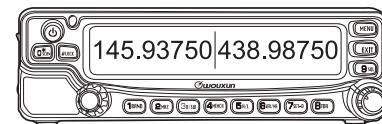

Enter standby status

Adjusting the volume

Rotate the VOL1 and VOL 2 knobs clockwise in order to increase the volume, rotate the knobs counter-clockwise to decrease volume, the corresponding volume level will be displayed on the LCD.

The volume control knobs have upper and lower control devices. The upper control device is the channel and frequency RX volume control on the left side of the screen, the lower level control device is the channel and frequency RX volume control on the right side of the screen.

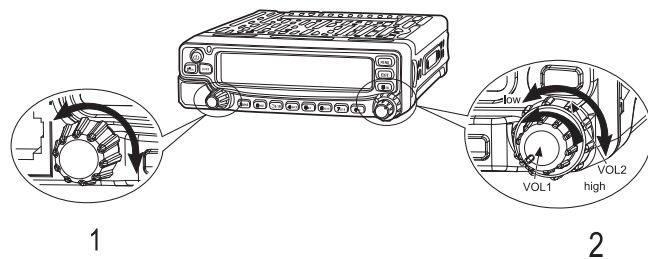

Turn the volume knob clockwise to increase the volume and the RX volume. The maximum volume is level 16. Turn the knob counter-clockwise to decrease the volume and the RX volume. Continue turning the knob counter-clockwise to shut off.

Selecting Frequency

(1) Frequency mode (VFO)

VFO Mode is the basic mode for changing the operating frequency, through rotating the TURNING (Tuning) control knobs you can change the operating frequency. Turn the knobs clockwise to increase the frequency and counter-clockwise to decrease.

You can also enter the desired frequency using the keypad.

Changing the operating frequency using the keypad:

While in standby mode, press the (2) key to enter in the operating frequency selection. After the LCD screen displays 8 whiffletrees, enter in the 6 figures in order which the frequency will automatically confirm according to the "frequency automated correction" verification. And will then display on the LCD screen.

Automatic frequency correction:

An operating frequency has a total of 8 digits, the method for verifying the last two digits after inputting 6 digits using the keyboard is as follows:

When the 5th and the 6th are entered in as "31" or "81" the final two digits will be "25".

When the 6th digit is entered in as "0" or "5" the last two digits will be "00".

If the 6th digit is not entered as shown above, it will be automatically corrected to 6.25K step match frequency.

Example frequency 1: 445.95500MHz standby mode:

Press 2 key	Display: <input type="text" value="-----"/>
Input [4]	Display: <input type="text" value="4 -----"/>
Input [4]	Display: <input type="text" value="4 4 -----"/>
Input [5]	Display: <input type="text" value="4 4 5 -----"/>
Input [9]	Display: <input type="text" value="4 4 5 . 9 -----"/>
Input [5]	Display: <input type="text" value="4 4 5 . 9 5 -----"/>
Input [5]	Display: <input type="text" value="4 4 5 . 9 5 0 0"/>

Example frequency 2: 445.56875MHz : standby mode

Press 2 key	Display: <input type="text" value="-----"/>
Input [4]	Display: <input type="text" value="4 -----"/>
Input [4]	Display: <input type="text" value="4 4 -----"/>
Input [5]	Display: <input type="text" value="4 4 5 -----"/>
Input [5]	Display: <input type="text" value="4 4 5 . 5 -----"/>
Input [6]	Display: <input type="text" value="4 4 5 . 5 6 -----"/>
Input [8]	Display: <input type="text" value="4 4 5 . 5 6 8 7 5"/>

Your first QSO

(2) Channel mode (CH)

Rotate the (TUNING) control knobs in channel mode to change the operating channel in order to get to the selected operating frequency, or use the keypad to select the operating channel.

Changing the operating channel using the keypad:

In standby mode press the [2] key, at this the time hundredth place of the channel number will appear. After entering the desired hundredth digit, the tenth place digit will appear, after entering the 10th place digit, the single place digit will appear, then enter the desired single place digit of the channel.

Example: Selecting Channel CH-901

In standby mode, after pressing [2] , enter “9”, “0”, “1” in sequence.

Example: Selecting Channel CH-088

In standby mode, after pressing [2] , enter “0”, “8”, “8” in sequence

Example: Selecting Channel CH-008

In standby mode, after pressing [2] , enter “0”, “0”, “8” in sequence

Selecting output power

While in standby mode, press the [5] key on the front panel or the [5] key on the encoded handheld microphone, to select the output power. Every time the output power is changed, the sequence will be 

The transceivers medium output power is M 2, for setup See “Menu 3”(MPOWSET)

Special Reminder

» when selecting the output power only do so in relation to the master frequency, See the hotkey operation chart for how to change the master frequency.

Commonly used basic operations

Transmitting

(1) In order to transmit signal first grab hold of the handheld microphone, and place about 5 CM away from your mouth, press the [PTT] key, and then speak normally into the microphone. When transmitting, The LCD backlight will change to your set color (For TX backlight color settings see instructions on P39), the LCD display screen will display a TX-LED indicator light. If you press the PTT key while transmitting outside of the coverage area you will hear an error sound.

(2) Release the [PTT] key, to end transmission.

Special Reminder

» If the transmission time exceeds the “Menu 11 (Transmission time-out timer) set time, you will hear a warning indication tone, the transceiver will also stop transmitting and will limit further transmission. After releasing the [PTT] key, the tone will continue for 10 seconds after which the transmission limitation will be lifted. Note: if you press the [PTT] key anytime within the 10 seconds while the tone is sounding, you will hear a warning tone.

Commonly used basic operations

Squelch settings: Press the [9] key in standby mode, and the muting level will be displayed on the screen, Press the ▼ / ▲ to choose the desired level of muting, to confirm press the [MENU] key.

Single / dual display: Press the [8] key in standby mode to select single or dual display.

Switching modes: In standby mode, press the [6] key to select VFO frequency mode or MR channel mode. (For detailed operation see hot key 6)

Switching working bands: In standby mode, press the [3] key to select the working band, this transceiver with quad band available.(For detailed operation see P30)

Shortcut operation chart (See P29-34 for explanation)

Key name	Function Name	Entering hotkey or operation	Remark
MAIN / 1BRND	Master frequency settings	In standby mode, press / to change master frequency	The LCD display screen will display a icon for the master frequency.
2MHZ	Selecting channel or frequency	In standby mode, press to enter the Channel or frequency selection.	See operations P30 "Frequency or channel selection hotkey" instructions
3B/SW	Switching working band	In standby mode, press to switch working band.	See operations P30 "Band switching" instructions
4MEMCH	Saving channels	In standby mode, press to save a channel.	See operations P30-31 "Save channel hotkey" instructions
5H/L	Output power level settings	In standby mode, press to change the output power settings.	Press the desired output power to change level of settings, sequence is as .
6VFD/MR	Switching frequency mode and channel mode	In standby mode, press to change the display mode.	See P31 "Frequency / Channel switch hotkey"
7SET-D	Frequency shift direction	In frequency standby mode, press Frequency shift direction settings. In channel standby mode, press for reverse frequency or to turn off reverse frequency.	See P32 "Frequency shift direction switch hotkey"
8TDR	Single and dual display settings	In standby mode, press to enter single display or turn off single display.	Only for secondary frequency set up.
9SQL	Squelching level settings	In standby mode, press to enter squelching level settings.	See P32 "Squelch level setting hotkey"
0*SCRN / *SCAN	Scanning function	In standby mode, press / to enter the scanning function.	Transceiver panel/Hand microphone key function
0SCRAM	Scrambler settings	In standby mode, press to enter the scrambler settings.	Hand microphone key settings, see P29 "voice scrambler function key (optional)"
#LOCK	Keypad lock settings	In standby mode, press to lock the keyboard or to turn off keyboard lock.	Transceiver panel / Hand microphone key function

Note: Frequency mode and channel mode are of identical operation (Besides independent indication mode).

Note:When Menu Available is not selected on programming software, some functions are available on menu in channel mode.

Available functional keys:

UP :To select the prior channel as working channel

Down :To select the next channel as working channel

:Press this key to change the master frequency.

:Press this key to the selective channel calling.

:Press this key to change the output power settings.

:Press this key to set reverse frequency or to turn off reverse frequency.

:Press this key to enter single display or turn off the single display.

:Press this key to enter squelching level settings.

:Press this key to enter the scanning.

:Press this key to lock the keypad or turn off the keypad lock.

Menu operation sheet (See P34-56 for explanation)

Function Code	Function Name	Enter function set	Screen display	Select parameter	Selectable Parameter Explanation	Confirm	Back	See page
1	Step frequency settings	MENU → 1 BAND	STEP 001	Press the ▲ key or the ▼ key to choose an index	9 types of step frequency: 5.0K, 6.25K, 10.0K, 12.5K, 20.0K, 25.0K, 30.0K, 50.0K, 100.0K	MENU → EXIT		P34
2	Wide/narrow bandwidth settings	MENU → 2 MHZ	WID 002	Press the ▲ key or the ▼ key to choose an index	WIDE: wide bandwidth(25K) NARR:narrow bandwidth(12.5K)	MENU → EXIT		P34
3	Two medium level power settings	MENU → 3 B/SW	MPOWSET 003	Press the ▲ key or the ▼ key to choose an index	MPOW1: 20W MPOW2: 10W	MENU → EXIT		P34
4	Offset frequency settings	MENU → 4 MEMCH	OFF-SET 004	Press the ▲ key or the ▼ key to choose an index	Selectable in the range 0-599.995	MENU → EXIT		P35
5	Transmission prompt settings	MENU → 5 H/L	ROGER 005	Press the ▲ key or the ▼ key to choose an index	BOT: When the PTT key is pressed, the transmission will prompt. EOT: when the PTT is released, the transmission will prompt. BOTH: When pressing and releasing the PTT key, the transmission will prompt. OFF: Transmission beep will not prompt when off.	MENU → EXIT		P35
6	Beep prompt settings	MENU → 6 VFO/MR	BEEP 006	Press the ▲ key or the ▼ key to choose an index	ON: Activate beep prompt OFF: Deactivate beep prompt	MENU → EXIT		P35
7	Voice prompt settings	MENU → 7 SET-D	VOICE 007	Press the ▲ key or the ▼ key to choose an index	CHINESE: Chinese prompts ENGLISH: English prompts OFF: Deactivate voice prompts.	MENU → EXIT		P35-36
8	Busy channel lock-out	MENU → 8 TOR	BCL 008	Press the ▲ key or the ▼ key to choose an index	ON: Activate BCL function OFF: Deactivate BCL function	MENU → EXIT		P36
9	Mute settings	MENU → 9 SQL	SP-MUTE 009	Press the ▲ key or the ▼ key to choose an index	There are three squelch settings: QT*DTMF, QT+DTMF, QT	MENU → EXIT		P36-37
10	Scan mode	MENU → 1 BAND → 0 SCRAM	SC-REV 010	Press the ▲ key or the ▼ key to choose an index	SE: Carrier wave scanning 2 TO: Time scanning CO: Carrier wave scanning 1	MENU → EXIT		P37
11	Transmission time-out timer	MENU → 1 BAND → 1 BAND	TOT 011	Press the ▲ key or the ▼ key to choose an index	There are 60 levels on TOT, each corresponding to 1 minute	MENU → EXIT		P37
12	Transmission overtime alarm	MENU → 1 BAND → 2 MHZ	TOA 012	Press the ▲ key or the ▼ key to choose an index	There are 1-10 level on TOA, each corresponding to 1 second OFF: Deactivate TOA	MENU → EXIT		P37-38

13	Caller ID transmission settings	MENU → 1 BAND → 3 B/SW	ANI-SW 013	Press the ▲ key or the ▼ key to choose an index	ON: Activate OFF: Deactivate	MENU → EXIT		P38
14	Ring time	MENU → 1 BAND → 4 MEMCH	RING 014	Press the ▲ key or the ▼ key to choose an index	Level 1-10, each corresponding to 1 second OFF: Deactivate	MENU → EXIT		P38
15	Editing Caller ID	MENU → 1 BAND → 5 H/L	ANI-EDIT 015	Press the ▲ key or the ▼ key to choose an index	Individual Caller IDs can be chosen within the range 100-999999, and cannot begin with 0	MENU → EXIT		P38-39
16	DTMF sidetone settings	MENU → 1 BAND → 6 VFO/MR	DTMFST 016	Press the ▲ key or the ▼ key to choose an index	DT-ST: Keypad sidetone will be activated when transmitting ANI-ST: Caller ID sidetone will be activated when transmitting DT-ANI: Caller ID sidetone and keypad sidetone will be activated when transmitting OFF: Deactivate all	MENU → EXIT		P39
17	Caller ID transmission mode	MENU → 1 BAND → 7 SET-D	PTT-ID 017	Press the ▲ key or the ▼ key to choose an index	BOT: Press PTT to transmit caller ID. EOT: Release PTT to transmit caller ID. BOTH: Press and release PTT will both transmit caller ID.	MENU → EXIT		P39-40
18	Transmission backlight	MENU → 1 BAND → 8 TOR	TX-LED 018	Press the ▲ key or the ▼ key to choose an index	WHITE: White backlight BLUE: Blue backlight GREEN: Green backlight OFF: Deactivate	MENU → EXIT		P40
19	Standby backlight	MENU → 1 BAND → 9 SQL	WT-LED 019	Press the ▲ key or the ▼ key to choose an index	WHITE: White backlight BLUE: Blue backlight GREEN: Green backlight OFF: Deactivate	MENU → EXIT		P40
20	Receiving backlight	MENU → 2 MHZ → 0 SCRAM	RX-LED 020	Press the ▲ key or the ▼ key to choose an index	GREEN: Green backlight WHITE: White backlight BLUE: Blue backlight OFF: Deactivate	MENU → EXIT		P40
21	Deleting a channel	MENU → 2 MHZ → 1 BAND	DEL-CH 021	Press the ▲ key or the ▼ key to choose an index	There are 999 channels, which the priority channels of 1st and 2nd cannot be deleted.	MENU → EXIT		P40-41
22	Editing a channel name	MENU → 2 MHZ → 2 MHZ	CH-NAME 022	Press the ▲ key or the ▼ key to choose an index	Channel name can be up to 8 digits long and can be made up of upper-case or lower-case letters, numbers, or symbols	MENU → EXIT		P41
23	Priority channel switch	MENU → 2 MHZ → 3 B/SW	PRICH-SW 023	Press the ▲ key or the ▼ key to choose an index	ON: Activate OFF: Deactivate	MENU → EXIT		P41-42

Menu operation sheet (See P34-56 for explanation)

- 24 Speaker settings**
 MENU → 2 MHz → 4 MEMCH → SPK-CONT → MENU → Press the ▲ key or the ▼ key to choose an index → MENU → EXIT P42
 SPK1: The transceiver-mounted speaker is activated
 SPK2: The hand speaker is activated
 SPK1+2: Both the transceiver-mounted speaker and the hand speaker are activated.
- 25 Keypad auto lock**
 MENU → 2 MHz → 5 H/L → AUTOLOCK → MENU → Press the ▲ key or the ▼ key to choose an index → MENU → EXIT P42
 ON: Activate
 OFF: Deactivate
- 26 Receiving CTCSS**
 MENU → 2 MHz → 6 VFO/MR → RX-CTC → MENU → Press the ▲ key or the ▼ key to choose an index → MENU → EXIT P42-43
 Press the ▲ key or the ▼ key to choose an index
 Standard CTCSS: 50 groups
 Non-standard CTCSS: 65.0Hz-255.0Hz
 OFF: Deactivate
- 27 Receiving DCS**
 MENU → 2 MHz → 7 SET-B → RX-DCS → MENU → Press the ▲ key or the ▼ key to choose an index → MENU → EXIT P43
 Press the ▲ key or the ▼ key to choose an index
 Standard negative & positive DCS: 105 groups
 Non-standard DCS: D000N-D7661
 OFF: Deactivate
- 28 Transmitting CTCSS**
 MENU → 2 MHz → 8 TOR → TX-CTC → MENU → Press the ▲ key or the ▼ key to choose an index → MENU → EXIT P43
 Press the ▲ key or the ▼ key to choose an index
 Standard CTCSS: 50 groups
 Non-standard CTCSS: 65.0Hz-255.0Hz
 OFF: Deactivate
- 29 Transmitting DCS**
 MENU → 2 MHz → 9 SQL → TX-DCS → MENU → Press the ▲ key or the ▼ key to choose an index → MENU → EXIT P43-45
 Press the ▲ key or the ▼ key to choose an index
 Standard negative & positive DCS: 105 groups
 Non-standard DCS: D000N-D7661
 OFF: Deactivate
- 30 Repeater speaker switch**
 MENU → 3 QT/DT → 0 SCRAM → RPT-SPK → MENU → Press the ▲ key or the ▼ key to choose an index → MENU → EXIT P45
 Press the ▲ key or the ▼ key to choose an index
 ON: Speaker is activate when repeating
 OFF: Speaker is deactivate when repeating
- 31 Repeater PTT switch**
 MENU → 3 B/SW → 1 BAND → RPT-PTT → MENU → Press the ▲ key or the ▼ key to choose an index → MENU → EXIT P45
 Press the ▲ key or the ▼ key to choose an index
 ON: PTT transmission activated when repeating
 OFF: PTT transmission blocked when repeating
- 32 Repeater settings**
 MENU → 3 B/SW → 2 MHz → RPT-SET → MENU → Press the ▲ key or the ▼ key to choose an index → MENU → EXIT P45-47
 Press the ▲ key or the ▼ key to choose an index
 X-DIRPT: Directional cross band repeat
 X-TWRPT: Two-way cross band repeat
 RPT-RX: Repeater Reception
 T-W RPT: Two way repeater
 RADIO: Transceiver mode
- 33 Scan add**
 MENU → 3 B/SW → 3 B/SW → SCAN-ADD → MENU → Press the ▲ key or the ▼ key to choose an index → MENU → EXIT P48
 Press the ▲ key or the ▼ key to choose an index
 ON: When scanning channels, they will be added to the scanning table
 OFF: Channels will not be added to the table when scanning
- 34 Automatic power-off**
 MENU → 3 B/SW → 4 MEMCH → APO-TIME → MENU → Press the ▲ key or the ▼ key to choose an index → MENU → EXIT P48
 Press the ▲ key or the ▼ key to choose an index
 Levels 1-5, each level corresponding to 30-minute.
 OFF: Deactivate automatic power-off
- 35 Single-tone pulse frequency**
 MENU → 3 B/SW → 5 H/L → ALERT → MENU → Press the ▲ key or the ▼ key to choose an index → MENU → EXIT P48-49
 Press the ▲ key or the ▼ key to choose an index
 There are 4 single-tone pulse frequency options: 1750; 2100; 1000; 1450
- 36 Compand**
 MENU → 3 B/SW → 6 VFO/MR → COMPAND → MENU → Press the ▲ key or the ▼ key to choose an index → MENU → EXIT P49
 Press the ▲ key or the ▼ key to choose an index
 ON: Activate compand
 OFF: Deactivate compand

- 37 Overheating detection**
 MENU → 3 B/SW → 7 SET-B → FAN-SET → MENU → Press the ▲ key or the ▼ key to choose an index → MENU → EXIT P49
 Press the ▲ key or the ▼ key to choose an index
 TX: Turn on fan when transmitting
 HI-TE/TX: Turn on fan when transmitting or in hi-temperature
 ALWAYS: Turn on fan when turn on the transceiver
- 38 Voltage testing**
 MENU → 3 B/SW → 8 TOR → LOW-V → MENU → Press the ▲ key or the ▼ key to choose an index → MENU → EXIT P49-50
 Press the ▲ key or the ▼ key to choose an index
 ON: Activate voltage testing
 OFF: Deactivate voltage testing
- 39 Voice scrambler**
 MENU → 3 B/SW → 9 SQL → SCRAM → MENU → Press the ▲ key or the ▼ key to choose an index → MENU → EXIT P50
 Press the ▲ key or the ▼ key to choose an index
 1-8: There are 8 voice scrambler groups
 OFF: Cancel voice scrambler
- 40 CTCSS / DCS scanner**
 MENU → 4 MEMCH → 0 SCRAM → SC-QT → MENU → Press the ▲ key or the ▼ key to choose an index → MENU → EXIT P51
 Press the ▲ key or the ▼ key to choose an index
 ALL: Save both RX and TX CTCSS / DCS
 DEC: Save RX CTCSS / DCS
 NEC: Save TX CTCSS / DCS
- 41 CTCSS scanning**
 MENU → 4 MEMCH → 1 BAND → SC-CTC → MENU → Press the ▲ key or the ▼ key to choose an index → MENU → EXIT P51
 Press the ▲ key or the ▼ key to choose an index
 In receiving mode, press MENU to activate CTCSS scanning
- 42 DCS scanning**
 MENU → 4 MEMCH → 2 MHz → SC-DCS → MENU → Press the ▲ key or the ▼ key to choose an index → MENU → EXIT P52
 Press the ▲ key or the ▼ key to choose an index
 In receiving mode, press MENU to activate DCS scanning
- 43 Scan group setting**
 MENU → 4 MEMCH → 3 B/SW → SC-GROUP → MENU → Press the ▲ key or the ▼ key to choose an index → MENU → EXIT P52
 Press the ▲ key or the ▼ key to choose an index
 All: scan all 1-10 groups
- 44 Remote control**
 MENU → 4 MEMCH → 4 MEMCH → RC-SW → MENU → Press the ▲ key or the ▼ key to choose an index → MENU → EXIT P53
 Press the ▲ key or the ▼ key to choose an index
 ON: Turn on remote control
 OFF: Turn off remote control
- 45 Side key setting**
 MENU → 4 MEMCH → 5 H/L → PF1-SET → MENU → Press the ▲ key or the ▼ key to choose an index → MENU → EXIT P53
 Press the ▲ key or the ▼ key to choose an index
 OFF: No definition
 KILL/STUN/MON/INSPECTION
- 46 Repeater receipt tone**
 MENU → 4 MEMCH → 6 VFO/MR → RPT TONE → MENU → Press the ▲ key or the ▼ key to choose an index → MENU → EXIT P53
 Press the ▲ key or the ▼ key to choose an index
 ON: Activate
 OFF: Deactivate
- 47 Reset setting**
 MENU → 4 MEMCH → 7 SET-B → RESET → MENU → Press the ▲ key or the ▼ key to choose an index → MENU → EXIT P53-54
 Press the ▲ key or the ▼ key to choose an index
 VFO: Reset menu functional parameters
 ALL: Reset all (menu & channel) functional parameters
- 48 FM radio function**
 MENU → 4 MEMCH → 8 TOR → FM-RADIO → MENU → Press the ▲ key or the ▼ key to choose an index → MENU → EXIT P54
 Press the ▲ key or the ▼ key to choose an index
 ON: Enter FM radio
 OFF: Deactivate
- 49 Air band auto-recognize**
 MENU → 4 MEMCH → 9 SQL → AUT-AM → MENU → Press the ▲ key or the ▼ key to choose an index → MENU → EXIT P54
 Press the ▲ key or the ▼ key to choose an index
 ON: Activate
 OFF: Deactivate
- 50 AM setting**
 MENU → 5 H/L → 0 SCRAM → AM-SW → MENU → Press the ▲ key or the ▼ key to choose an index → MENU → EXIT P54-55
 Press the ▲ key or the ▼ key to choose an index
 ON: Activate AM receiving function
 OFF: Deactivate

Function description

I. The vehicle transceiver has multiple functions:

(1) Work mode of transceiver

(2) Directional cross-band repeater or two way cross-band repeater work mode

(3) Repeater receiver and two way repeater operating mode.

Note: Can be set through Menu 32 (See P45-47 instructions).

(1) The vehicle transceiver control panel LCD is divided into two display settings, A and B, displaying the two vehicle transceiver operating frequencies.

The master frequency will be indicated by “▼”. This icon is very important. All operating instructions are all concerning the master frequency indicated by this icon. If the frequency does not have the “▼” icon, it will be called a secondary frequency.

The master and secondary frequency will be separated by a vertical bar on the display device.

(2) While the vehicle transceiver is in transceiver mode, only A area (left) can be set to the FM receiver (76-108MHz) function.

(3) The vehicle transceiver's two operating areas parameters can be set. Before changing the parameter settings, first set the desired channel to the master frequency.

(Master frequency settings see P29 “Master frequency settings”)

(4) When the vehicle transceiver is operating in cross-band repeater mode, or repeater receiver / two way repeater mode, some Transceiver functions will be prohibited.

Hotkey function guide

II. Hotkey function guide.

The settings menu is divided into quick start and operating menu settings, and aside from their shared operating settings, all of the functional operations of work areas A and B are oriented at the master frequency.

Special Reminder



» The vehicle transceiver operating frequency parameters can be separately set. (Example: STEP step frequency, W/N Wide/narrow bandwidth frequency, VFO/MR display mode, OFF-SET frequency, BCL busy channel lockout, SP-MUTE mode operations). As well as system parameters (Example: RX-LED receiver backlight color function etc.) are AB's two operational channels. When setting the main frequency it will change the system parameters.

■ Rapid search function

When using the device or setting any functional parameters you can search the data above or below it by pressing the ▲ or ▼ keys.

(I) Quick operation

(0) Voice scrambler function key (Optional)

When the machine is standby, press the  key to enter voice scrambling settings, then press the ▲ / ▼ key or a number from 1-8 to choose a voice scrambling group, and press the  key to confirm, exit settings and return to standby. Voice scrambling has a total of 1 – 8 groups, OFF Shuts down the voice scrambling function. If the vehicle transceiver does not come with this option, pressing this key will be of no effect!

NOTE: This scrambler function is not workable when the equipment is working in the cross-band repeating mode or repeater/transmitter mode.

(1) Master frequency settings hotkey

When the transceiver is standby, press the  key on the handset or transceiver to switch between master frequency and secondary

frequency.

Special Reminder

- » When the A or B Areas or the display screen display an “▼” icon, this indicates that that area is the master frequency, and the other area is secondary frequency, this icon is very important, all of the functional operations are oriented at the master frequency.

(2) Frequency or channel selection hotkey

■ When the transceiver is standby (frequency mode), press the  key to enter frequency settings, and 8 whiffletrees will appear, just input 6 digits frequency, the last 2 digits will be automatically recognized. This recognition according to the following standards:

- (1) When the 6th digit is 0 or 5, then the 7th and 8th digits will be 0.
 - (2) When the 6th digit is not 0 or 5, the 7th and 8th digits will be 25, 50 or 75 according to the 5th digit's 6.25k step frequency.
- During inputting the 6 digits frequency, if press any other keys except 0-9, it will exit the frequency setting.

(3) Band switching hotkey

This transceiver with multiple band available, which with flexible operation.

In standby mode, press  to switch the working band.

Area A (left) with 6 bands selectable: 430MHz → 29MHz → 50MHz → 320MHz → 700MHz → 144MHz → 430MHz →

Area B (right) with 2 bands selectable: 144MHz → 430MHz → 144MHz →

This transceiver can be programmed to work as V-V or U-U.

KG-UV950P can receive strong signal from the image frequency, and/or when it is in the twin reception, some frequencies at A area and B area may affect the sensitivity more or less.

If you receive some unknown signals which may be caused by the interference from the image frequency, please use the following formulas to confirm whether it is from the image frequency or not.

(Frequency at A area ± 45.05MHz)Xn1-((Frequency at B area*47.25MHz)Xn2=the middle frequency at A area OR the middle frequency

at B area

(28MHz at A area ± 45.05MHz)Xn=the frequency at B area

(n should be positive integer)

Special Reminder

- » Air band 108.000MHz-135.995MHz can only be activate on area A.
- » When you get a poor receiving signal on 700MHz band, please use the following formula to check whether the value can be divided exactly.

$$y=(F_x-45.05M)/(Step*2)$$

NOTE:

F_x is the current frequency while Step is 5K or 6.25K. If y can be divided exactly by one of these two steps, then the transceiver receives normally. If y is a number with the decimal points, then there is receiving error and the equipment is with poor reception.

(4) Save channel hotkey

When in Channel/Memory (MR) mode, it will copy this channel's information to the specified channel except the Channel Name and Channel Scanning Add setting.

When in Frequency (VFO) mode, you can set the different offset frequency (see MENU 4) and frequency shift direction (see MENU 7) as well as other parameters, and then save it to the specified channel, this way you can set the same band but different RX/TX frequencies channel or different bands and different RX/TX frequencies channel.

Example: Save 'RX frequency: 450.025MHz, RX CTCSS: 67.0Hz, TX frequency: 460.025MHz' to Channel 10.

1. In Frequency mode, input 450.025 frequency, press  +  +  enter the Receiving CTCSS setting, press  /  to select 67.0, and then press  to confirm.
2. Press  +  to set the Offset frequency as 10.000MHz, then press  to select the Frequency shift direction as '+'.

Hotkey function guide

3. Press **MEMCH** to enter Save channel function, the screen shows , and now enter **SCRAM** **BRND** **SCRAM** to select Channel 10, then press **MENU** to confirm the setting and return to standby mode.

Special Reminder

» The default channel 1 and 2 can only save the UHF or VHF frequency, other band frequencies cannot be saved here.

(5) **H/L** Output power settings switch key

H/L function key, is an output power switch hotkey

When the transceiver is standby, the **H/L** key will quickly switch power; every time **H/L** the key is pressed, the power will shift in the following direction: High power (H) → Medium power (M) → Low power (L)

Medium output power has two levels. Please view the "Medium output level" of MENU 3 for the detailed instructions.

(6) **VFO/MR** Frequency / Channel switch hotkey

The vehicle transceiver operating channel can be set as VFO Frequency mode and MR channel mode, Amongst those MR channel mode has three different display types.

A. Channel number mode B. Frequency+Channel number display mode C. Channel name display mode. The VFO Frequency mode and MR channel mode sometimes are setup with passcode limitations; they need a correct password in order to be able to switch between the two. However the MR channel mode does not need a passcode to switch between the 3 different channel display modes.

VFO/MR(Frequency / Channel switch) switching is shown below:



When the setup is setup with a switch passcode, press the **VFO/MR** key, The LCD will display: 

At this time enter a 6 digit passcode, if the passcode is correct the mode will switch successfully, If the passcode is incorrect the mode switch will be ineffective, a double tone will follow and you will exit the program. The only way to set up the passcode is through our companies supplied software. If 6 0's are entered this will turn off the password function.

(7) **7** Frequency shift direction switch hotkey

• In Frequency mode, press the **7** key to rapidly switch direction as shown below:

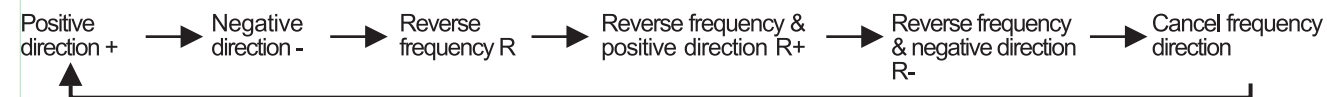

When rapidly switching frequencies, the frequency direction will be skipped automatically if the frequency direction results in frequency error.

• In channel mode, press the **7** key this will only set "reverse frequency R" or "turn off reverse frequency R" function.

(8) **8** Single or dual display switch hotkey

When in standby, press the **8** key, and you can switch between single and dual display.

(9) **9** Squelch level settings hotkey

The SQL function rapidly switches between squelching settings.

When in standby, press the **9** key and the muting level in the area will be displayed on the screen, then press **▲** / **▼** or directly press 0-9 to choose the desired squelch level, press **MENU** to confirm, then press **EXIT** to exit settings.

(10) *** SCAN** Scanning Key

In standby mode, press the handheld microphone *** SCAN** key or the panel *** SCAN** key, to start scanning. Frequency mode will start scanning by "step frequency" in intervals, channel mode will start scanning in the current channel, press the **▲** / **▼** keys while scanning to change the scanning direction (higher or lower), press any key to stop scanning. Please see menu 10 SC-REV Scan settings for details of scan types.

Simultaneous Scanning on AB Areas

1. AB areas can scan at the same time. The A master frequency area activate scanning, press **(MAIN)** to change to B area, then press Scan key to

Hotkey function guide



activate the scanning on B area. This is the AB area simultaneous scanning.

2. During the scanning on the Secondary frequency area, press PTT on the Master frequency area to transmit, the Secondary area will stop scanning temporarily, after end transmitting (release PTT), the scanning on Secondary area will resume.



Special Reminder

» During the scanning on the Secondary frequency area, some settings on the Master frequency area will be prohibited: saving channel (MEMCH), scanning mode (SC-REV), deleting channel (DEL-CH), channel name editing (CH-NAME) and repeater setting (RPT-SET).

(11) Keypad lock key.

When the transceiver is standby, press the  key locks the keyboard of the master frequency area. When the keyboard is locked, both the keypad on the handset and the keypad on the front panel are locked, except key  can change to the Secondary frequency area.

(12) Up key

- In frequency mode, press the  key to set a new frequency: "current frequency" + "step frequency".
- In channel mode, press the  key to call out the lower channel as the working channel.

(13) Down key

- In frequency mode, press the  key to set a new frequency: "current frequency" - "step frequency".

Menu operations

- In channel mode, press the  key to call out the higher channel as the working channel.

(14) Confirmation key

 key is a confirmation key, as well as a key to enter Menu function setup hotkey.

Menu Operations

Step frequency settings (STEP) - Menu 1





When the transceiver is standby, press the  +  keys and the screen will display: 

Press the  key to access the menu, and after pressing the  /  key to select the required step frequency type, press the  key to confirm, and the  key to return to standby.

This transceiver has 9 types of step frequency: 5KHz, 6.25K, 10KHz, 12.5KHz, 20KHz, 25KHz, 30KHz, 50KHz, 100KHz.

Wide/Narrow bandwidth settings (W/N) - Menu 2





When the transceiver is standby, press the  +  keys and the screen will display: 

Press the  key, then Press the  /  keys to choose the desired wide/narrow bandwidth set up and press the  key to confirm. Press the  key to return to standby mode.

This transceiver's bandwidth settings are divided into: wide bandwidth (25KHz) and narrow bandwidth (12.5K).

Two medium level power settings (MPOW-SET) - Menu 3

When the transceiver is standby, press the  +  keys and the screen will display: 

Press the  key, then press the  /  to choose the required output level, and press the  key to confirm. Press the  key to return to standby mode.

This transceiver has two medium level power set ups separated as MPOW1:20W ; MPOW2:10W.

Special Reminder

» Medium output power settings is a system setting, after changing these settings, the vehicle transceivers two operating frequencies medium output power settings will simultaneously be set.

Menu operations

Offset frequency settings (OFF-SET) - Menu 4

When the transceiver is standby, press the **MENU** + **4** keys and the screen will display:

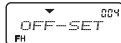

Press the **MENU** key to access the menu, and the screen will display:

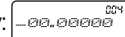

And the first digit will simultaneously flash, after inputting the required offset frequency or pressing the **▲** / **▼** keys to increase or reduce the offset frequency, press the **MENU** key to confirm, and press the **EXIT** key to return to standby.

The transceiver's frequency range is from 0-599.99500MHz, and the KHz of input offset frequency will be automatically confirmed by step frequency.

This function can be prohibited while the vehicle transceiver is in cross-band repeater or repeater receiver or repeater transmitter mode.

Transmission prompt settings (ROGER) - Menu 5

When the transceiver is standby, press the **MENU** + **5** keys and the screen will display:



Press the **MENU** key to access the menu, and after pressing the **▲** / **▼** keys to choose the required prompt mode, press the **MENU** key to confirm, or the **EXIT** key to return to standby.

The transceiver features 4 kinds of prompt: BOT (beginning of transmission), EOT (end of transmission), BOTH (beginning and end of transmission), and OFF (prompts deactivated).

ROGER Dual tone prompt method, can be set through the supplied programming software. It can be set through (at most 6 digit number) as well as remaining mode or in intervals. (See programming software for help)

Beep prompt settings (BEEP) - Menu 6

When the transceiver is standby, press the **MENU** + **6** keys and the screen will display:

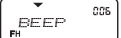

Press the **MENU** key to access the menu, and after pressing the **▲** / **▼** keys to choose the required voice prompt to confirm, press the **EXIT** key to return to standby mode.

The transceiver has 2 Beep Prompt modes: ON or OFF

Voice prompt settings (VOICE) - Menu 7

When the transceiver is standby, press the **MENU** + **7** keys and the screen will display:



Press the **MENU** key to access the menu, and after pressing the **▲** / **▼** keys to choose the required prompt mode, press the **MENU** key to confirm,

or the **EXIT** key to return to standby.

This transceiver has 3 voice prompt settings: CHINESE, ENGLISH, and OFF.

Special Reminder

» If you need to turn all prompts off, you must turn off both the setting of voice prompt (Menu 7) and the beep prompt (Menu 6).

Busy channel lock-out (BCL) - Menu 8

When the transceiver is standby, press the **MENU** + **8** keys and the screen will display:



Press **MENU** the key to access the menu, and after pressing the **▲** / **▼** keys to choose the required prompt mode, press the **MENU** key to confirm, or the **EXIT** key to return to standby.

The transceiver has 2 BCL modes: ON (activate) and OFF (deactivate).

Mute settings (SP-MUTE) - Menu 9

When the transceiver is standby, press the **MENU** + **9** keys and the screen will display:

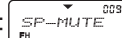

Press **MENU** the key to access the menu, and after pressing the **▲** / **▼** keys to choose the required prompt mode, press the **MENU** key to confirm, or the **EXIT** key to return to standby.

Squelch settings: set the conditions which determine when the speaker shall be turned on, these settings are used during selective calling, group calling and all calling.

The Transceiver's mute mode include:

QT: when the transceiver is set to this mode, all signals on the same CTCSS frequency will activate the speaker.

QT+DTMF: only those signals which both satisfy the requirements of CTCSS mode and whose dual-tone multi-frequency carrier wave signal also match the transceiver will activate the speaker in this mode.

QT*DTMF: When this mode is active, only those signals which either meet QT requirements or DTMF requirements will activate the speaker.

A. Used in All call: Press PTT to transmit, after send out the transceiver's ID code, press ***SCAN** + **#LOCK**.

B. Used in Group call: Press PTT to transmit, after send out the transceiver's ID code, press [Group Number] + ***SCAN** + **#LOCK**.

Menu operations

Note: Group number refers to the first digit ID code. If some transceivers with the same first digit ID code, then they are in the same group. The first digit can be set from 1-9, means there are 9 groups maximum. See the detailed instructions on MENU 15 (ANI-EDIT).

C. Used in Selective call: Press PTT to transmit, after send out the transceiver's ID code, input the specified selective call's ID code.

Scan mode settings (SC-REV) - Menu 10

When the transceiver is standby, press the **MENU** + **1 BAND** + **0 SCAN** keys and the screen will display:

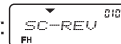

Press the **MENU** key to access the menu, and after pressing the **▲** / **▼** keys to select the required setting, press the **MENU** key to confirm, and the **EXIT** key to return to standby.

The transceiver has 3 scan modes: TO, CO, and SE:

TO: after finding a carrier wave signal, scanning will continue if no operations are carried out within 5 seconds.

CO: scanning will stop when a carrier wave signal has been found, and scanning will continue if the carrier wave signal is lost for 3 seconds.

SE: scanning will stop when a carrier wave signal is found.

Special Reminder

- » This function is prohibited if the transceiver is in Cross-band repeat or Repeater relay or Repeater transmitter mode.
- » If you prefer to ignore the CTCSS/DCS settings when scanning frequency/channel, please set 'SCAN-DET (Scanning CTCSS/DCS detection)' OFF via programming software under the configuration settings column.

Transmission time-out timer (TOT) - Menu 11

When the transceiver is standby, press the **MENU** + **1 BAND** + **1 BAND** keys and the screen will display:

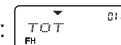

Press the **MENU** key to access the menu, and after pressing the **▲** / **▼** keys to select the required time, press the **MENU** key to confirm, and the **EXIT** key to return to standby.

The TOT can be set for up to 60 minutes, 1 level of the setting corresponding to 1 minute.

Transmission overtime alarm (TOA) - Menu 12

When the transceiver is standby, press the **MENU** + **1 BAND** + **2 MENU** keys and the screen will display:

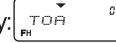

Press the **MENU** key to access the menu, and after pressing the **▲** / **▼** keys to select the required time, press the **MENU** key to confirm, and the **EXIT** key to return to standby.

The TOA has a maximum length of 10 seconds, each level corresponding to 1 second. OFF: Deactivate TOA.

Special Reminder

- » When the transmission time exceeds the "Time-out timer" set time, a continuous error tone will prompt, release the [PTT] key to stop it. The transmission function will be stopped for 10 seconds and it can not transmit by pressing the [PTT] key, simultaneously a double tone will prompt. After 10 seconds, the transmission function will be restored (Transmission time-out punishment).

Caller ID transmission settings (ANI-SW) - Menu 13

When the transceiver is standby, press the **MENU** + **1 BAND** + **5 MENU** keys and the screen will display:

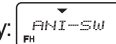

Press the **MENU** key to access the menu, and after pressing the **▲** / **▼** keys to select the required setting, press the **MENU** key to confirm, and the **EXIT** key to return to standby.

Caller ID transmission: ON activate, OFF deactivate.

Ring time (RING) - Menu 14

When the transceiver is standby, press the **MENU** + **1 BAND** + **4 MENU** keys and the screen will display:



Press the **MENU** key to access the menu, and after pressing the **▲** / **▼** keys to select the required time, press the **MENU** key to confirm, and the **EXIT** key to return to standby.

The transceiver has 10 levels of ring time, each corresponding to 1 second. OFF: ring deactivated.

Editing caller ID (ANI-EDIT) - Menu 15

The transceiver's caller ID is composed of the Arabic numerals 0-9: the first digit cannot be 0, and ID numbers can be as short as 3 digits and as long as 6.

When the transceiver is standby, press the **MENU** + **1 BAND** + **5 MENU** keys and the screen will display:

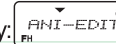

Menu operations

Press the **MENU** key to access the settings menu, and after inputting the required digits, press the **MENU** key to confirm, and the **EXIT** key to return to standby.

Example 1: editing a 6-digit caller ID number (901285)

When the transceiver is standby, press the **MENU** + **1 BAND** + **5 I/L** keys and the screen will display:

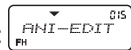

After pressing the **MENU** key, the first digit will flash, then input the required value:



Press the **MENU** key to confirm, and press the **EXIT** key to return to standby.

Example 2: editing a 3-digit caller ID number (901)

When the transceiver is standby, press the **MENU** + **1 BAND** + **5 I/L** keys and the screen will display:

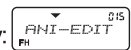

After pressing **MENU** the key, if a caller ID number has already been input, it will be displayed, and the first digit will flash. If no caller ID number has been input, 101 will be displayed, and the first digit will flash, input **9 SOL** **0 SCRAM** **1 BAND**, and after the third digit has been input, the symbol "<" will flash in the 4th digit, press the **MENU** key to confirm, and the **EXIT** to return to standby.

Special Reminder

>> Each transceiver can have only one caller ID number, which is shared by Areas A and B.

DTMF sidetone settings (DTMFST) - Menu 16

When the transceiver is standby, press the **MENU** + **1 BAND** + **6 VO/M** keys and the screen will display:

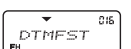

Press the **MENU** key to access the menu, and after pressing the **▲** / **▼** keys to select the required setting, press the **MENU** key to confirm, and the **EXIT** key to return to standby.

The transceiver has the following DTMF modes; 1. DT-ST: Keypad sidetone will be activated when transmitting; 2. ANI-ST: caller ID sidetone will be activated when transmitting; 3. DT+ANI: keypad and caller ID sidetone are both activated when transmitting.

Caller ID transmission mode (PTT-ID)- Menu 17

When the transceiver is standby, press the **MENU** + **1 BAND** + **7 SET-D** keys and the screen will display:

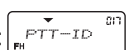

Press the **MENU** key to access the menu, and after pressing the **▲** / **▼** keys to select the required setting, press the **MENU** key to confirm, and the

EXIT key to return to standby.

The transceiver features 3 kinds of ID transmission: BOT (beginning of transmission), EOT (end of transmission), BOTH (beginning and end of transmission).

Transmission backlight (TX-LED)- Menu 18

When the transceiver is standby, press the **MENU** + **1 BAND** + **8 TDR** keys and the screen will display:

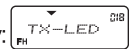

Press the **MENU** key to access the menu, and after pressing the **▲** / **▼** keys to select the required backlight color, press the **MENU** key to confirm, and the **EXIT** key to return to standby.

The transceiver has 3 backlight colors: BLUE; GREEN; WHITE; OFF: Deactivate.

Standby backlight (WT-LED) - Menu 19

When the transceiver is standby, press the **MENU** + **1 BAND** + **9 SEL** keys and the screen will display:



Press the **MENU** key to access the menu, and after pressing the **▲** / **▼** keys to select the required backlight color, press the **MENU** key to confirm, and the **EXIT** key to return to standby.

The transceiver has 3 backlight colors: BLUE; GREEN; WHITE; OFF: Deactivate.

Receiving backlight (RX-LED) - Menu 20

When the transceiver is standby, press the **MENU** + **2 MRZ** + **0 SCRAM** keys and the screen will display:

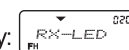

Press the **MENU** key to access the menu, and after pressing the **▲** / **▼** keys to select the required backlight color, press the **MENU** key to confirm, and the **EXIT** key to return to standby.

The transceiver has 3 backlight colors: BLUE; GREEN; WHITE; OFF: Deactivate.

Deleting a channel (DEL-CH) - Menu 21

When the transceiver is standby, press the **MENU** + **2 MRZ** + **1 BRND** keys and the screen will display:



Press the **MENU** key to access the menu, and after pressing the **▲** / **▼** to select the channel you wish to delete or manually inputting the channel code, press the **MENU** key to confirm and the **EXIT** key to return to standby.

Special Reminder

» The 1st, 2nd and the Priority Channels are fixed channels and cannot be deleted.

Editing a channel name (CH-NAME) - Menu 22

Channel names can only be edited in channel mode, and only the name of the present channel can be edited- this operation is ineffective in frequency mode.

When the transceiver is standby, press the **MENU** + **2 MRZ** + **2 MRZ** keys and the screen will display: 

Press the **MENU** key to access the menu, and the first digit will flash (which indicates that this digit is being edited)

Press the **#** key to switch character sets (this switches between special characters, upper-case letters, lower-case letters, and numbers), press the **▲** key to choose the required character, press **▼** to edit the next character, and press **+ SCAN** to clear the character you are currently editing.

When you have finished editing the name, press **MENU** to confirm, and press **EXIT** to exit the editing screen.

Note: 1. Channel names can be a maximum of 8 characters long, and the first character may not be 0.

2. When all 8 characters are empty, the channel will be displayed on the screen as CH-*** (*** being the current channel number).

3. This function will be prohibited if the other area in scanning mode or the transceiver is not working in radio mode.

Priority channel switch (PRICH-SW) - Menu 23

When the transceiver is standby, press the **MENU** + **2 MRZ** + **3 ST/ST** keys and the screen will display: 

Press the **MENU** key to access the settings, and after pressing the **▲** / **▼** key to activate or deactivate the speaker, press the **MENU** to confirm, and press the **EXIT** key to return to standby

The priority channel switch can be set to ON or OFF.

Special Reminder

» While in frequency mode or channel mode, you only need to turn on the priority channel, and the priority channel will scan in 3 second intervals. The priority channel is only used for receiving, if you need to transmit, please set the priority channel as the present channel.

Special Reminder

- » If the master frequency is in Area A, the priority channel can be set as any band and can receive, while if the master frequency is Area B, the priority channel can only be set as UHF or VHF, if set other bands then cannot receive. Example, if the priority channel is 50MHz band, then it can be only in A area can receive, if in Area B, cannot receive.
- » This function will be prohibited if the transceiver is not working in radio mode.

Speaker settings (SPK-CONT) - Menu 24

When the transceiver is standby, press the **MENU** + **2 MRZ** + **4 MEME** keys and the screen will display: 

Press the **MENU** key to access the menu, and after pressing the **▲** / **▼** keys to select the desired setting, press the **MENU** key to confirm, and press the **EXIT** key to return to standby.

There are 3 speakers on the transceiver, 2 are for the transceiver that is separated by Area A/B and 1 is for hand microphone. You can activate the hand microphone as the only one speaker. You can also both activate the transceiver and hand microphone.

SPK1: only the transceiver unit speaker is activate.

SPK2: only the hand microphone is activate.

SPK1+2: the transceiver-mounted speaker and the hand microphone are both activate.

Keypad autolock (AUTOLOCK) - Menu 25

When the transceiver is standby, press the **MENU** + **2 MRZ** + **5 B/L** keys and the screen will display: 

Press the **MENU** key to access the menu, and after pressing the **▲** / **▼** keys to select the desired setting, press the **MENU** key to confirm, and press the **EXIT** key to return to standby.

Receiving CTCSS settings (RX-CTC) - Menu 26

When the transceiver is standby, press the **MENU** + **2 MRZ** + **6 WFO/MB** keys and the screen will display: 

Press the **MENU** key to access the menu, and after pressing the **▲** / **▼** key to select the CTCSS you desire, press the **MENU** key to confirm, and

Menu operations

press the **EXIT** key to return to standby.

Standard CTCSS: 50 groups; Non-standard CTCSS: 65.0Hz-255.0Hz; OFF: Deactivate.

Receiving DCS settings (RX-DCS) - Menu 27

When the transceiver is standby, press the **MENU** + **2 MRZ** + **7 SETD** keys and the screen will display: 

Press the **MENU** key to access the menu, and after pressing the **▲** / **▼** key to select the DCS you desire, press the **MENU** key to confirm, and press the **EXIT** key to return to standby.

Standard negative & positive DCS: 105 groups; Non-standard DCS: D000N-D766I; OFF: Deactivate.

Transmitting CTCSS settings (TX-CTC) - Menu 28

When the transceiver is standby, press the **MENU** + **2 MRZ** + **8 TOR** keys and the screen will display: 

Press the **MENU** key to access the menu, and after pressing the **▲** / **▼** key to select the CTCSS you desire, press the **MENU** key to confirm, and press the **EXIT** key to return to standby.

Standard CTCSS: 50 groups; Non-standard CTCSS: 65.0Hz-255.0Hz; OFF: Deactivate.

Transmitting DCS settings (TX-DCS) - Menu 29

When the transceiver is standby, press the **MENU** + **2 MRZ** + **9 SOL** keys and the screen will display: 

Press the **MENU** key to access the menu, and after pressing the **▲** / **▼** key to select the DCS you desire, press the **MENU** key to confirm, and press the **EXIT** key to return to standby.

Standard negative & positive DCS: 105 groups; Non-standard DCS: D000N-D766I; OFF: Deactivate.

How to set the Non-standard CTCSS

1. The non-standard CTCSS code is from 65.0-255.0Hz
2. The minimum spacing is 0.1Hz

After in CTCSS setting, press the desired CTCSS code via the keyboard and then press **MENU** to confirm.

Example: Set the receiving CTCSS as 100.5Hz

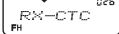
In standby, press **MENU** + **2 MRZ** + **6 W/MR**, the screen will display: , press **MENU**, and input **1 BAND** + **0 SCRAM** + **0 SCRAM** + **5 RL**, then press **MENU** to

confirm, and press **EXIT** to return to standby.

How to set the Non-standard DCS

1. The non-standard DCS code is from 000-766 except any code with 8 or 9 number. (Such as 680.719 is not the legal non-standard DCS code)
2. After set the non-standard DCS code, you can press **# LOCK** to select the Positive or Negative code, press **5 SCAN** to select off.

After in DCS setting, press the desired DCS code via the keyboard and then press **# LOCK** to select the Positive or Negative code, and then press **MENU** to confirm.

Example 1: Set the receiving DCS as D105N

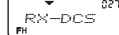
In standby, press **MENU** + **2 MRZ** + **7 SETD**, the screen will display: , press **MENU**, and input **1 BAND** + **0 SCRAM** + **5 RL**, then press **# LOCK** to select the Positive code, now the screen will display D105N. Press **MENU** to confirm, and then press **EXIT** to return to standby.

Example 2: Set the receiving DCS as D105I

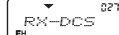
In standby, press **MENU** + **2 MRZ** + **7 SETD**, the screen will display: , press **MENU**, and input **1 BAND** + **0 SCRAM** + **5 RL**, then press **# LOCK** to select the Negative code, now the screen will display D105I. Press **MENU** to confirm, and then press **EXIT** to return to standby.

CTCSS

1	67.0	11	94.8	21	131.8	31	171.3	41	203.5
2	69.3	12	97.4	22	136.5	32	173.8	42	206.5
3	71.9	13	100.0	23	141.3	33	177.3	43	210.7
4	74.4	14	103.5	24	146.2	34	179.9	44	218.1
5	77.0	15	107.2	25	151.4	35	183.5	45	225.7
6	79.7	16	110.9	26	156.7	36	186.2	46	229.1
7	82.5	17	114.8	27	159.8	37	189.9	47	233.6
8	85.4	18	118.8	28	162.2	38	192.8	48	241.8
9	88.5	19	123.0	29	165.5	39	196.6	49	250.3
10	91.5	20	127.3	30	167.9	40	199.5	50	254.1

DCS (positive code)

1	D023N	16	D074N	31	D165N	46	D261N	61	D356N	76	D462N	91	D627N
2	D025N	17	D114N	32	D172N	47	D263N	62	D364N	77	D464N	92	D631N
3	D026N	18	D115N	33	D174N	48	D265N	63	D365N	78	D465N	93	D632N
4	D031N	19	D116N	34	D205N	49	D266N	64	D371N	79	D466N	94	D645N
5	D032N	20	D122N	35	D212N	50	D271N	65	D411N	80	D503N	95	D654N
6	D036N	21	D125N	36	D223N	51	D274N	66	D412N	81	D506N	96	D662N
7	D043N	22	D131N	37	D225N	52	D306N	67	D413N	82	D516N	97	D664N
8	D047N	23	D132N	38	D226N	53	D311N	68	D423N	83	D523N	98	D703N
9	D051N	24	D134N	39	D243N	54	D315N	69	D431N	84	D526N	99	D712N
10	D053N	25	D143N	40	D244N	55	D325N	70	D432N	85	D532N	100	D723N
11	D054N	26	D145N	41	D245N	56	D331N	71	D445N	86	D546N	101	D731N
12	D065N	27	D152N	42	D246N	57	D332N	72	D446N	87	D565N	102	D732N
13	D071N	28	D155N	43	D251N	58	D343N	73	D452N	88	D606N	103	D734N
14	D072N	29	D156N	44	D252N	59	D346N	74	D454N	89	D612N	104	D743N
15	D073N	30	D162N	45	D255N	60	D351N	75	D455N	90	D624N	105	D754N

NOTE

» The difference of the negative and positive code is the last letter (I for negative, N for positive). E.g.: D023N, D025N... is the positive code, see the upper right chart, while D023I, D025I... is the negative code.

Repeater speaker switch (RPT-SPK) - Menu 30

When the transceiver is standby, press the **MENU** + **3** + **SCREEN** keys and the screen will display:

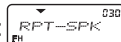

Press the **MENU** key to access the settings, and after pressing the **▲** / **▼** key to activate (ON) or deactivate (OFF) the speaker, press the **MENU** to confirm, and press the **EXIT** key to return to standby.

Repeater PTT switch (RPT-PTT)- Menu 31

When the transceiver is standby, press the **MENU** + **3** + **1** keys and the screen will display:

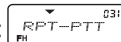

Press the **MENU** key to access the settings, and after pressing the **▲** / **▼** key to activate (ON) or deactivate (OFF) the PTT transmission, press the **MENU** to confirm, and press the **EXIT** key to return to standby.

Repeater settings (RPT-SET) - Menu 32

This transceiver has 5 settings available.

1. RADIO: Normal transceiver's communication mode
2. X-DIRPT: Directional cross-band repeater mode

Note: The master frequency area defines as the cross-band receiver (only for receiving), and the secondary frequency area as the cross-band transmitter (only for transmitting).

Example: The master frequency area A is 150MHz, the secondary frequency area B is 430MHz, the area A receiving signal (Area B cannot receive any signal under X-DIRPT mode), the secondary frequency area B will automatically activate the transmitting work and transmit the 430 MHz frequency.

3. X-TWRPT: Two-way cross-band repeater mode

Note: In standby, both master and secondary areas are receiver, whichever area receives an effective carrier wave signal, the other area will be

the transmitter and start transmitting. The transmitter and receiver is unfixed under two way cross-band repeater model. The first received area is receiver and relatively the other one is transmitter.

Example: The master frequency area A is 150MHz, the secondary frequency area B is 430MHz, if area A receiving signal in advance then Area B will transmit, if area B receiving signal in advance then Area A will transmit. It means the different frequencies cross-band repeater.

4. RPT-RX: Repeater receiving mode (Repeater receiver, only can be used when combining two transceivers as a repeater)

Note: The master frequency area defines as the repeater receiver (only for receiving)

5. T-W RPT: Two-way cross-band relay mode (Repeater transceiver, only can be used when combining two transceivers as a repeater)

Note: The master frequency area can be defined as transmitter or receiver, it can transmit or receive accordingly.

Special Reminder

- » In Directional cross-band repeater mode (X-DIRPT), Two-way cross-band repeater mode (X-TWRPT) or Two-way cross-band relay mode (T-W RPT), if the channel or frequency set the reverse frequency, offset frequency, or frequency shift direction, its transmitting frequency would out of the transceiver's frequency range, then it will not transmit.
- » In cross-band repeater mode, the two channels/frequencies must be two different bands (UV or VU). E.g. the receiving frequency is UHF in Area A, while transmitting frequency must be VHF in Area B, vice versa.
- » Repeater receiver (RPT-RX) and Repeater transceiver (T-W RPT) can be combined as a directional cross-band repeater, while combining two Repeater transceivers (T-W RPT) can be set as a two-way repeater.

You can select whether the speaker will be on or not, and whether the PTT is available for transmitting during the Cross-band repeater or repeater RX/TX mode via MENU 30 (RPT-SPK) and MENU 31 (RPT-PTT) respectively. But, if activated the RPT-PTT, the signal will be temporarily interrupted if press PTT during these cross-band repeater modes.

When the transceiver is standby, press the **MENU** + **3** + **2** keys and the screen will display:

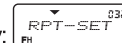

Press the **MENU** key to enter settings, press the **▲** / **▼** key to select the required type, and press the **EXIT** key to confirm.

Special Reminder ⚠

- » In cross-band repeater mode, the middle of the screen will display . When in repeater transmitting / receiving mode, the screen will display .
- » In order to use the repeating well, there is the Repeating Receipt which is set by MENU46. The repeating receipt timely and effectively reports the working status and increases the efficiency of repeating.
- » The Repeating Hold Timer is used for avoiding to press or release PTT too frequently in order to read out the message. When the mobile receiver was released PTT, the hold time is able for the equipment keeping transmitting for a while during waiting for the response. If there is no efficient QT/DQT detected within the hold time, then the transmitter will be released PTT. The repeating hold timer is setting the hold time for the transmitter to keep transmitting after the QT/QDT receiving signal disappears. This function is programmable by the programming software accordingly.

How to combine two transceivers as a repeater

Through MENU 32 RPT-SET, you can set the two transceivers as Repeater transceivers (T-W RPT) or one set Repeater receiver (RPT-RX) and the other set as the Repeater transceiver (T-W RPT), and then connect these two transceivers with a cable with 8 pins crystal head on both ends (The connecting interface is on the side of the transceiver where with a rubber cover marked PC). Now this two combined transceivers can be work as a repeater.

Repeater receiver (RPT-RX): It only for receiving.

Repeater transceiver (T-W RPT): It can be transmit or receive. In T-W RPT standby, when receiving the matching signal carrier it works as the Repeater receiver, when receiving the Repeater receiver's transmitting signal, it works as the Repeater transmitter.

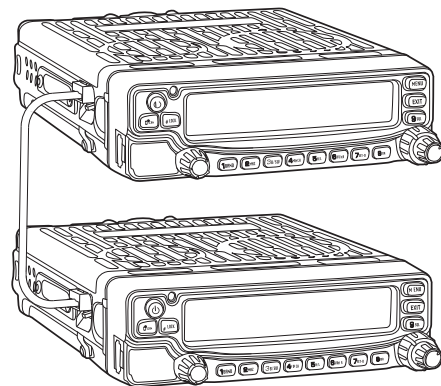

Special Reminder ⚠

- » The connection way of the two transceivers as the repeater is the same as the connection way of the base station and front panel, see details instruction on P47.
- » The 8 pins connection cable can use the supplied 5M extension cable (SCO-002).
- » Combine the two transceivers as the Repeater receiver (RPT-RX) and the Repeater transceiver (T-W RPT) can work as a directional repeater, while combine the two transceivers as Repeater transceivers (T-W RPT) can work as a two-way repeater.

Scan add (SCAN-ADD) - Menu 33

Scan add determines whether a given channel is added to scan. As a result, this function can only be used in channel mode, can only be used with the present channel, and is ineffective in frequency mode.

When the transceiver is in channel mode, press the **MENU** + + keys and the screen will display: .

Press the **MENU** key to access the menu, and after pressing the / keys to select the required parameter, press the **MENU** key to confirm, and the **EXIT** key to return to standby.

Scan Add has 2 parameters: ON (add), OFF (cancel).

Note: This function will be prohibited if the transceiver is not working in radio mode.

Automatic power-off (APO-TIME) - Menu 34

When the transceiver is standby, press the **MENU** + + + keys and the screen will display: .

Press the **MENU** key to access the settings menu, and after pressing the / keys to select the desired parameters, press the **MENU** key to confirm, and the **EXIT** key to return to standby.

If the transceiver undertakes no operations, and does not receive or transmit any signals within a set period of time, the Automatic Power off function will automatically power the transceiver off.

Menu Operations

There are 5 kinds of automatic power off in total: 30 minutes, 60 minutes, 90 minutes, 120 minutes, and 150 minutes. OFF: Turning off the automatic power off function, it is prohibited in repeater or relay mode.

Note: This function will be prohibited if the transceiver is not working in radio mode.

Single-tone pulse frequency (ALERT) - Menu 35

Some of the relay systems used for single-tone pulse transmission need a single-tone pulse signal to activate, if a repeater is already active, however, this signal is not needed. The following pulse signal frequencies can be selected: 1750Hz, 2100Hz, 1000Hz, 1450Hz.

When the transceiver is standby, press the **MENU** + **9** (9/01) + **5** (5/17) keys and the screen will display:



Press the **MENU** key to access the menu, and after pressing the **▲** / **▼** keys to select the desired parameter, press the **MENU** key to confirm, and the **EXIT** key to return to standby.

Special Reminder

- » When in transmitting mode, you can send the single-tone pulse frequency you've selected by pressing key " **1** (BAND) " on the panel or the **(MAN)** on the hand microphone.

Compand (COMPAND) - Menu 36

The compand function effectively minimizes noise, and its results are especially evident when transmitting over long distances.

When the transceiver is standby, press the **MENU** + **9** (9/01) + **5** (5/17) keys and the screen will display:

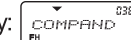

Press the **MENU** key to access the menu, and after pressing the **▲** / **▼** keys to select the desired parameter, press the **MENU** key to confirm, and the **EXIT** key to return to standby.

There are two kinds of compand: ON (activate), OFF (deactivate).

Note: This function will be prohibited if the transceiver is not working in radio mode.

Overheating detection (FAN-SET) - Menu 37

The transceiver has a built-in temperature detection system that will activate a cooling fan if required.

There are three ways to activate the cooling fan;

TX: In transmitting mode, it will activate the cooling fan.

HI-TE/TX: When the transceiver's temperature reaches a pre-set value or in transmitting mode, it will activate the cooling fan.

ALWAYS: When turn on the transceiver, the fan will always in cooling mode.

When the transceiver is standby, press the **MENU** + **9** (9/01) + **7** (7/SET-B) keys and the screen will display:

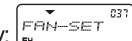

Press the **MENU** key to access the settings menu, and after pressing **▲** / **▼** keys to select the required parameters, press the **MENU** key to confirm, and the **EXIT** key to return to standby.

Voltage testing (LOW-V) - Menu 38

When the transceiver is installed in a car or another unstable power source (such as a car battery, etc), please activate this function in order to prevent the transceiver from consuming electricity over an extended period, rendering the equipment unable to supply electricity for regular work.

When the transceiver is standby, press the **MENU** + **9** (9/01) + **8** (8/TDR) keys and the screen will display:

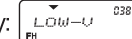

Press the **MENU** key to access the settings menu, and after pressing **▲** / **▼** keys to select the required parameters, press the **MENU** key to confirm, and the **EXIT** key to return to standby. ON (activate) or OFF (deactivate)

Special Reminder

- » When the voltage is too low, a voice prompt will sound every 10 seconds, and if Voltage Testing is active, the transceiver will automatically power off when the voltage is insufficient. If the voltage is found to be too high, transmission will be blocked.
- » When you need the transceiver continues to work under the low voltage, please turn on the under-voltage transmission setting via *Wouxun* supplied programming software.
- » The transceiver can set the lowest voltage via *Wouxun* supplied programming software. The under-voltage threshold value is from 9.5V to 10.5V.

Voice scrambler (SCRAM) - Menu 39

This function is a kind of special speech handling, activating voice scrambling avoids the user's speech being overheard by users of transceivers who are not using the scrambling function.

Menu Operations

Press the **MENU** + **3** **07/07** + **0** **SEL** keys, and the screen will display:



Press the **MENU** key to access the settings menu, and after pressing **▲** / **▼** keys to select the desired setting, press the **MENU** key to confirm, and the **EXIT** key to return to standby.

There are 8 voice scrambling groups (1-8) selectable, and OFF deactivates.

Special Reminder

- » The voice scrambler is optional!
- » This function will be prohibited if the transceiver is not working in radio mode.

Saving scanned CTCSS / DCS (SC-QT) - Menu 40

When the transceiver is in CTCSS/DCS scanning, there are 3 saving types to save the detected CTCSS/DCS from the others to your transceiver:

1. Save as your transceivers decoder and encoder (ALL).
2. Save as your transceivers encoder (ENCODER).
3. Save as your transceivers decoder (DECODER).

When the transceiver is standby, press the **MENU** + **4** **MEMCH** + **0** **SCRAM** keys and the screen will display:

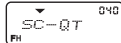

Press **▲** or **▼** to select, press the **MENU** to confirm, and press the **EXIT** key to exit.

NOTE

- » Saving scanned CTCSS/DCS is ineffective in cross-band repeat or repeater or reception/transmission mode.
- » This function will be prohibited if the transceiver is not working in radio mode.

CTCSS scanning (SC-CTC) -- Menu 41

This function scan all the frequencies/channels which with CTCSS setting, in case to confirm if the transmitter transmits the CTCSS code. When your CTCSS code is not matching with the other member on your group, you can activate this function to confirm the CTCSS code.

When the transceiver is in receiving mode, press **MENU** + **4** **MEMCH** + **1** **BRND**, the screen displays:



, and then press **MENU** to enter the CTCSS

scanning.

Special Reminder

- » When the current frequency or channel is not receiving any carrier wave signal, then it cannot activate this CTCSS scanning function.
- » If you want to scan the frequencies or channels counterclockwise, then you can press **▲** / **▼** or rotate the channel knob to change the scanning direction.
- » When scans the CTCSS frequency, it will show on the screen, you can press **MENU** to save. If the scanned CTCSS is unwanted, then you can press *** SCAN** to continue scanning, until scans the one you wanted.

DCS scanning (SC-DCS) --- Menu 42

This function scan all the frequencies/channels which with DCS setting, in case to confirm if the transmitter transmits the DCS code. When your DCS code is not matching with the other member on your group, you can activate this function to confirm the DCS code.

When the transceiver is in receiving mode, press **MENU** + **4** **MEMCH** + **2** **MRZ**, the screen displays:



, and then press **MENU** to enter the DCS scanning.

Special Reminder

- » When the current frequency or channel is not receiving any carrier wave signal, then it cannot activate this DCS scanning function.
- » If you want to scan the frequencies or channels counterclockwise, then you can press **▲** / **▼** or rotate the channel knob to change the scanning direction.
- » When scans the DCS frequency, it will show on the screen, you can press **MENU** to save. If the scanned DCS is unwanted, then you can press *** SCAN** to continue scanning, until scans the one you wanted.

Scan group settings (SC-GROUP) - Menu 43

The scan group settings are the way that a transceiver can divide the programmed channels into different scan groups. It will scan all channels in this group.

Menu Operations

Scan group settings have: ALL channel, as well as 1-10 individual scanning groups.

When the transceiver is standby, press the **MENU** + **MEMBER** + **DISCAN** keys and the screen will display: 

Press **▲** or **▼** to select, press **ENTER** to confirm, and press **MENU** the **EXIT** key to return.

NOTE

- » The Scan group setting is ineffective in Cross-band repeat or repeater reception mode / transmission mode.
- » This function will be prohibited if the transceiver is not working in radio mode.

Remote control (RC-SW) - Menu 44

When the transceiver is standby, press the **MENU** + **MEMBER** + **MEMBER** keys and the screen display: 

Press the **MENU** key to access the settings menu, and after pressing **▲** / **▼** keys to select the required settings, press the **MENU** key to confirm, and the transceiver will reboot automatically.

There are two settings of remote control setting: ON(activate), OFF(deactivate)

Side key setting (PF1-SET) ---- Menu 45

Note: This side key is the second button under the PTT key of the supplied DTMF hand microphone, is not on the transceiver's base station.

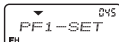
In standby, press **MENU** + **MEMBER** + **HL**, the screen displays . Press **MENU** to enter, press **▲** / **▼** to select the desired setting, then press **MENU** to confirm.

You can define the side key as: OFF (no definition), KILL, STUN, MONI, INSPECTION.

When press PTT to talk, press this side key to activate the above defined setting. The detailed operation instruction, please refer to the remote control setting.

If in standby, press this side key will activate the squelch monitoring.

Repeater receipt tone setting (RPT-TONE) --- Menu 46

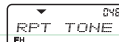
In standby, press **MENU** + **MEMBER** + **REPEAT**, the screen displays . Press **MENU** to enter, press **▲** / **▼** to select the desired

setting, then press **MENU** to confirm and return to standby mode.

ON: Activate the repeater receipt tone function; OFF: Deactivate.

Reset settings (Reset)- Menu 47

Functional Parameter Reset (VFO): resets all functional settings to factory default values, but channel parameters are not reset.

Total Parameter Reset (ALL): resets all of the transceiver's functional settings and channel parameters to factory values.

When the transceiver is standby, press the **MENU** + **MEMBER** + **SET** keys and the screen will display: 

Press the **MENU** key to access the settings menu, and after pressing the **▲** or **▼** keys to select the desired parameter, press **MENU**, the screen will display: , then press **MENU** and the screen will display: 

After the transceiver resets (VFO / ALL), it will restart and return to standby mode.

FM radio function (FM-RADIO) - Menu 48

You can enter the FM radio by using this function.

When the transceiver is standby, press the **MENU** + **MEMBER** + **TDR** keys and the screen will display: 

Press the **▲** or **▼** keys to select, when select ON, press the **MENU** key to enter FM radio, when select OFF, press **MENU** to return to standby mode.

NOTE

- » The FM-Radio function is ineffective in Cross-band repeat or repeater reception mode / transmission mode.
- » This function will be prohibited if the transceiver is not working in radio mode.
- » This function can only be set on Area A.

AM frequency auto-recognize switch (AUT.AM) --- Menu 49

Note: This transceiver will automatically recognize the AM receiving frequency.

In standby, press **MENU** + **MEMBER** + **SCA**, the screen displays . Press **MENU** to enter, press **▲** / **▼** to select the desired setting, then press **MENU** to confirm, and press **EXIT** to return to standby.

Menu Operations

ON: Activate this function, it will automatically recognize 108.000MHz - 135.995MHz as the AM receiving mode; OFF: Deactivate.

Note: This function can only be set on Area A.

AM setting (AM-SW) --- Menu 50

Note: It will set the transceiver in AM receiving mode.

In standby, press **MENU** + **5** **RL** + **0** **SCRAM**, the screen displays . Press **MENU** to enter, press **▲** / **▼** to select the desired setting, then press **MENU** to confirm, and press **EXIT** to return to standby.

ON: Activate; OFF: Deactivate.

Note: This function can only be set on Area A. Each band can set the AM receiving mode respectively.

How to Operate the FM Radio

1.Turning ON

When the transceiver is standby, press the **MENU** + **4** **MEMCH** + **8** **TDR** key, select "on", and press **MENU** to enter FM Radio.

2.Tuning Radio Stations

When in FM radio mode, press the **2** **MRZ** key to enter frequency settings, at this time the screen will display: 

Now, input the desired frequency (4 digits), and if the input frequency is within the scope of the transceiver's range, it will be successfully established.

If the input frequency is beyond the transceiver's range, the setup will fail and the transceiver will revert to the last set frequency.

Example 1:Setting FM Waveband 105.9MHz

When the transceiver is standby, press the **MENU** + **4** **MEMCH** + **8** **TDR** keys to access the FM radio function, (at this point the screen will display the default frequency or the one previously used, and the screen will display "FM" on the top-right of the screen).

Press the **2** **MRZ** key to access frequency settings, and the screen will display 8 horizontal lines; press **1** **BAND** **0** **SCRAM** **5** **RL** **0** **SO** in order, and the screen will display 105.9MHz, and frequency setup is complete.

Example 2:Setting FM Waveband 90.4MHz

When the transceiver is standby, press the **MENU** + **4** **MEMCH** + **8** **TDR** keys to access the FM radio function, press **2** **MRZ** to access FM settings, and 8 horizontal lines will be displayed on the screen; press **9** **SO** **0** **SCRAM** **4** **MEMCH** in order, and the screen will display 90.4MHz, and frequency setup will complete.

In FM radio mode, press **5** **SCAN** to scan the FM radio station, it will stop until scans a FM station. During the scanning, press any other key to stop the scanning except **▲** / **▼** key.

3.Storing and calling out FM radio stations

The transceiver can store 20 FM radio channels.

Saving an FM Reception Channel:

When in FM Waveband mode, press the **MENU** key, and the screen will display: 

After pressing the **▲** / **▼** key, select the channel number you wish to save, press **MENU** to confirm, and the transceiver will automatically return to the FM waveband frequency display interface.

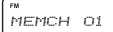
Example: when in FM waveband mode, save the displayed frequency to channel "5" while in FM waveband mode, press the **MENU** key, and the screen will display: 

Press **▲** / **▼** or the **5** **RL** key, and the LCD screen will display: 

Press the **MENU** key to confirm, and the transceiver will automatically return to the FM waveband frequency display interface.

Calling out the FM memory channel:

When in FM waveband mode, press the **#** key, and the screen will display: 

Press **▲** / **▼** key to select the desired FM memory channel, and then press **MENU** to confirm, the transceiver will automatically enter the selected FM channel and display the FM radio frequency.

4.Exiting the FM Radio Mode

When in receiver mode, press the **EXIT** key, and the screen will display: 

Press the **MENU** key to exit the FM radio mode.

Repeater usage

1. "RPT-PTT" repeater PTT selection

When the transceiver is standby, press the **MENU** + **3** (DISCAN) + **1** (BAND) keys and the screen will display:

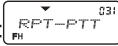

Press the **MENU** key to access the settings menu, and after pressing **▲** / **▼** keys to select ON, press the **MENU** key to confirm, and the **EXIT** key to return to standby.

When two-way cross-band repeater "RPT-PTT" is ON, you only need to press the [PTT] to stop repeater transmission and reception. When this happens you can directly transmit through the directional frequency using the transmitter to transmit, Release the [PTT] key to switch to two-way cross-band repeater mode.

2. "RPT-SPK" Repeater SPK selection

When the transceiver is standby, press the **MENU** + **3** (DISCAN) + **0** (A) keys and the screen will display:

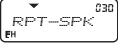

Press the **MENU** key to access the settings menu, and after pressing **▲** / **▼** keys to select ON, press the **MENU** key to confirm, and the **EXIT** key to return to standby.

When the two-way cross-band repeater "RPT-SPK" is ON, if it receives an effective carrier wave signal, the speakers will emit a tone, and simultaneously send out the received signal out into space on another frequency.

3. Cross-band repeater entry and exiting

When the transceiver is standby, press the **MENU** + **3** (DISCAN) + **2** (MRZ) keys and the screen will display:

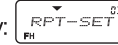

Press the **MENU** key to access, press **▲** / **▼** to select the directional cross-band repeater (X-DIRPT) or two-way cross-band repeater (X-TWRPT), and then press **MENU** to confirm.

At this time the transceiver will restart and enter the directional cross-band or two-way cross-band repeater mode.

4. In the cross-band repeating mode

When the transceiver is standby, press the **MENU** + **3** (DISCAN) + **2** (MRZ) keys and the screen will display:

Press the **MENU** key to access, press **▲** / **▼** to select the RADIO mode(RADIO), and then press **MENU** to confirm.

5. In the cross-band repeating mode, if you set the "RPT-PPT" to be "ON", then press PTT to stop transmitting or receiving, but get the frequency on the master area transmitted as the TX frequency of the transmitter, while releasing PTT to access to standby for the Two-Way Repeating mode.

6. In the cross-band repeating mode, set the "RPT-SPK" to be ON, if any receiver of the cross-band repeat receives the effective carrier signal, the speaker will be ON, and at the same time, the equipment will transmit out the receiving audio signal by another frequency.

7. The difference between the directional cross-band repeating and Two-way cross-band repeating is the fixed or unfixed receiver and transmitter. Directional cross-band repeating: Use the Master RX frequency as the RX frequency of the repeating receiver, while the Sub TX frequency is the TX frequency of the cross-band repeating transmitter.

Two-way cross-band repeating: There is not specified for the receiver or transmitter. In standby, the master or sub area can be either as the receiver. Either of them receives the effective carrier, the other side can be as the transmitter to activate the transmission accordingly.

Example:

Directional cross-band repeating: The master frequency 150MHz at A area, while sub frequency 430MHz at B area. When the master frequency receives the signal(the sub frequency can not receive the effective signal in the directional cross-band repeating mode), the sub frequency 430MHz will be activated to transmit out.

Two-way cross-band repeating: The master frequency 150MHz at A area, while sub frequency 430MHz at B area. When there is A area receiving the signal on 150MHz firstly, then the B area will be immediately activated to send out 430MHz. While there is B area receiving the signal on 430 MHz firstly, then the A area will be activated to send out 150MHz instead.

NOTE

>> If select radio (RADIO), it will exit the cross-band repeater mode and return to the regular radio communication mode.

Special Tips

KG-UV950P can receive strong signal from the image frequency, and/or when it is in the twin reception, some frequencies at A area and B area may affect the sensitivity more or less.

If you receive some unknown signals which may be caused by the interference from the image frequency, please use the following formulas to confirm whether it is from the image frequency or not. These formulas can be also used to design the high-end measuring tool like Notch table etc.

Repeater usage

- 144MHz as TX frequency at B area-100.35MHz=the middle frequency or the second harmonic frequency at B area
- 28MHz as TX frequency at A area-11.7MHz=the middle frequency or the second harmonic frequency at B area
- 50MHz as TX frequency at A area-58.5MHz=the middle frequency or the second harmonic frequency at B area
- (144MHz as RX frequency at B area-47.25MHz)x n1-(28MHz as TX frequency at A area)x n2=the middle frequency or the second harmonic frequency at B area
- (430MHz as RX frequency at B area-47.25MHz)x n1-(50MHz as TX frequency at A area)x n2=the middle frequency or the second harmonic frequency at B area
- (50MHz as TX frequency at A area+45.05MHz)x n1-(144MHz as TX frequency at B area)x n2=the middle frequency or the second harmonic frequency at B area
- 144MHz as TX frequency at B area-(50MHz as RX frequency at A area+45.05MHz)x n1=the middle frequency or the second harmonic frequency at A area
- 144MHz as TX frequency x n1- (430MHz as RX frequency-45.05MHz)x n2=the middle frequency or the second harmonic frequency at A area
- 144MHz as TX frequency x n1- (430MHz as RX frequency-45.05MHz)x n2+11.15MHz= the middle frequency or the second harmonic frequency at A area
- 430MHz as TX frequency at B area x n1-(50MHz as RX frequency at A area + 45.05MHz)x n2= * the middle frequency or the second harmonic frequency at A area
- 430MHz as TX frequency x n1- (144MHz as RX frequency+ 45.05MHz)x n2= the middle frequency or the second harmonic frequency at A area

Hand microphone encoding function

DTMF Encoding (Hand Microphone)

This device features DTMF encoding; press the number pad or other keys on the handset when transmitting to activate dual-tone multifrequency encoding.

The number pad corresponds to DTMF encoding code as follows:

MENU	▲	▼	EXIT	→	A	B	C	D
1 BAND	2 MRZ	3 BT/ET	* SCAN	→	1	2	3	*
4 MEM1	5 RL	6 MR/MR	0 SCAN	→	4	5	6	0
7 SET-D	8 TDR	9 SC	# LOCK	→	7	8	9	#

The transceiver encoding function usage:

When pressing the [PTT] key under transmission mode press the key on the hand microphone and it will transmit dual tone multi-frequency (DTMF) encoding.

Remote Control Function

To use the remote control function you must first activate it, at the same time you must set the transceivers I.D number, and master control number.

These settings can only be set via the programming software.

- 1.Open the KG-UV950P programming software.
- 2.Connect the transceiver to your PC (Computer)

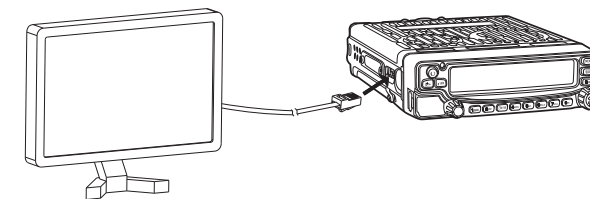

Remote control function

I. How to activate the remote control function

The precondition to activate the remote control function is set the transceiver's ANI ID code (Default ID:101), and different controlling functions need to be set different controlled code or other settings. For example:

- 1.If the transceiver is the controlled one, it should set a controlled ID (SCC-EDIT).
- 2.If the transceiver is the master controller, then it should also set a master controlled ID (MCC-EDIT).
- 3.If activate the remote power on/off function, then is should be also select the RC POWER options as to -
RC OPEN: It allows remote control to power on or off the transceiver.
RC STOP: Deactivate the remote control function (see the following detailed instructions).
- 4.If activate the remote change settings, then it should be also set the control code.

All the above code can be set from 3-6 digits, and the first digit cannot be 0, if the code set 000 or 000000, means this function is inactivate!

All the above code can be programmed ONLY via our company's programming software.

RC POWER			
<input type="radio"/> RC STOP	<input checked="" type="radio"/> RC OPEN		
ANI-EDIT	<input type="text" value="123456"/>		
MCC-EDIT	<input type="text" value="654321"/>		
SCC-EDIT	<input type="text" value="654321"/>		
CONTR CODE	<input type="text" value="654321"/>		
Kill	<input type="text" value="AB"/>	Monitor	<input type="text" value="DA"/>
Stun	<input type="text" value="CB"/>	Inspection	<input type="text" value="DB"/>
TYP-SW CO	<input type="text" value="AA"/>	RC SW-CO	<input type="text" value="BB"/>
RESET CO	<input type="text" value="AD"/>	RC-CO CO	<input type="text" value="AC"/>

Set the control code of the master controller and the controlled code of the controlled transceiver as 654321. If the master controller only control the other transceiver and not be controlled by the others, then it must set the controlled code as 000000, vice verse, if the controlled transceiver only be controlled by the others and not control the other transceiver, then it should set the master control code as 000000. The following remote stun, kill, monitoring and inspection function with the same principle.

(1) Stun

Press PTT+  (front panel) of the master controller, it will send out its controller ID+CB(Stun code) +ANI ID code (123456).

If the controlled ID sent by the master controller is same with the controlled transceiver's controlled ID, and the ANI ID of the two transceivers is the same, it will activate the Stun function.

(2) Kill

Press PTT+  (front panel) of the master controller, it will send out its controller ID+AB(Kill code) +ANI ID code (123456).

If the controlled ID sent by the master controller is same with the controlled transceiver's controlled ID, and the ANI ID of the two transceivers is the same, it will activate the Kill function.

(3) Monitoring

Press PTT+  (front panel) of the master controller, it will send out its controller ID+DA(Monitoring code)+ANI ID code (123456).

If the controlled ID sent by the master controller is same with the controlled transceiver's controlled ID, and the ANI ID of the two transceivers is the same, it will activate the Monitoring function (The monitoring time is 15 seconds).

(4) Inspection

Press PTT+  (front panel) of the master controller, it will send out its controller ID+DB(Inspection code) +ANI ID code (123456).

If the controlled ID sent by the master controller is same with the controlled transceiver's controlled ID, and the ANI ID of the two transceivers is the same, it will activate the Inspection function.

NOTE

>> The remote stun, kill, monitoring and inspection function of the controlled transceiver will not be controlled while in repeater mode.

Remote control function

II. Remote control power on/off

Controlled transceiver setting:

The controlled transceiver's ANI ID code is 654321, and click the remote control power (RC POWER) as RC OPEN.

Special Reminder

» When manually sending code, if the ANI ID/Master controller ID/Controlled transceiver ID is less than 6 digits, the last digit will be #, otherwise, it will show the complete ID number. For example: 654#+BB+123#

(1) Remote Power OFF

The Controlled Transceiver can be turned OFF by manually sending 654321 (the controlled transceiver Controlled ID) + BB (Remote control power on/off code) + 123456 (the controlled transceiver ANI ID code) on the Master controller transceiver

Note: After remote powered OFF by the master controller, the standby orange indicator of the controlled transceiver is ON.

(2) Remote Power ON

The Controlled transceiver can be turned OFF by manually sending 654321 (the controlled transceiver Controlled ID) + BB (Remote control power on/off code) + 123456 (the controlled transceiver ANI ID code) on the Master controller transceiver.

Note: After remote powered OFF by the master controller, if you want to manually turn on the controlled transceiver, you can press the front panel  key twice.

III. Remote changing settings

In standby, press the  +  +  keys of the controlled transceiver, the screen will display: 

Press the  /  keys to select ON, and press  key to confirm, then the transceiver will reboot with keypad locking.

Hold the PTT of the handheld or mobile transceiver (the controller) and sending out the controlled transceiver's controlled code (CONTR CODE) + AC (Remote control code), and then release the PTT.

If heard a beep prompt from the controller (means the remote control changing function is activated), then you can remote control on the master



VFO and change the secondary VFO's frequency, output power, CTCSS setting, etc. See the following detailed instructions:

1. Change frequency (01 + 8 digits frequency)

It will only change the secondary VFO's frequency, the transmitting and receiving frequency will be the same after changed.

NOTE

» The two frequencies must be two different bands (UV or VU), otherwise it cannot be changed. E.g. the master VFO A is UHF, while the desired changing frequency of secondary VFO B must be VHF, vice versa.
Remote change frequency will cancel the offset shift direction of the changed secondary VFO.

After activated the remote changing function of the controlled transceiver, hold the controller's PTT and pressing the  +  + Frequencies (total 8 digits), and then release the PTT.



The controller will have a beep prompt, and the controlled transceiver will reboot with the updated frequency on the secondary VFO display which you've just set remotely. If heard none beep prompt from the controller, the setting was failed, please repeat the above settings and try again.

2. Change channel number (02 + 3 digits channel number)

It will change the repeating channel number in cross-band mode, while in radio communication mode, it will change the secondary VFO's channel.

NOTE

» The two channels must be two different bands (UV or VU), otherwise it cannot be changed. E.g. the master VFO A is UHF, while the desired changing channel of secondary VFO B must be VHF, vice versa.

After activated the remote changing function of the controlled transceiver, hold the controller's PTT and pressing the  +  + Channel number (total 3 digits), and then release the PTT.

The controller will have a beep prompt, and the controlled transceiver will reboot with the updated channel number on the secondary VFO display which you've just set remotely. If heard none beep prompt from the controller, the setting was failed, please repeat the above settings and try again.



Remote control function

3.Change repeater mode (03 + matching mode code)

It will change the transceiver to normal Radio communication mode (code 1: RADIO), Directional cross-band repeater mode (code 2: X-DIRPT) or two way cross-band repeater mode (code 3: X-TWRPT).

NOTE



» If changed to Directional cross-band repeater mode, the receiving VFO will be defined as the master VFO, it will be also defined by the none DTMF microphone if used.



After activated the remote changing function of the controlled transceiver, hold the controller's PTT and pressing the  +  + 1 (RADIO) / 2 (X-DIRPT) / 3 (X-TWRPT), and then release the PTT.

The controller will have a beep prompt, and display the controlled transceiver's ANI ID code, after that, the controlled transceiver will reboot with the updated repeating mode which you've just set remotely. If heard none beep prompt from the controller, the setting was failed, please repeat the above settings and try again.

4.Change transmitting power (04 + matching power code)

It will change the transceiver's transmitting power temporarily (both VFOs). After reboot the transceiver, it will return to the transceiver's original power setting.



(1). After activated the remote changing function of the controlled transceiver, hold the controller's PTT and pressing the  +  + 1 (Low power) / 2 (Middle power) / 3 (High power) of the controller, and then release the PTT. There is a beep prompt from the controller, which means the setting is succeed, if heard nothing, please repeat the above settings and try again.



(2). After changed, hold the controller's PTT and pressing  + , and then release the PTT, at this time the controller will beep and show the ANI ID code of the controlled transceiver, which means exit the remote changing mode.

(3). If you want to cancel the changed power level, you can turn off and then turn on the transceiver, it will be back to the previous setting.

5.Change receiving CTCSS tone (05 + 4 digits CTCSS tone)

It will change the transceiver's receiving CTCSS tone temporarily (both VFOs). After reboot the transceiver, it will return to the transceiver's original CTCSS setting.



(1). After activated the remote changing function of the controlled transceiver, hold the controller's PTT and pressing the  +  + 4 digits CTCSS tone (if only 3 digits should add a 0 at the beginning), and then release the PTT. There is a beep prompt from the controller, which means the setting is succeed, if heard nothing, please repeat the above settings and try again.



(2). After changed, hold the controller's PTT and pressing  + , and then release the PTT, at this time the controller will beep and show the ANI ID code of the controlled transceiver, which means exit the remote changing mode.

(3). If you want to cancel the changed CTCSS tone, you can turn off and then turn on the transceiver, it will be back to the previous setting.

6.Change receiving DCS tone (06 + DCS tone)

It will change the transceiver's receiving DCS tone temporarily (both VFOs). After reboot the transceiver, it will return to the transceiver's original DCS setting.

(1). After activated the remote changing function of the controlled transceiver, hold the controller's PTT and pressing the  +  + 4 digits DCS tone (first digit 0 for positive code, e.g. 0023 for D023N, while 1 for negative code, e.g.1023 for D023I), and then release the PTT. There is a beep prompt from the controller, which means the setting is succeed, if heard nothing, please repeat the above settings and try again.

(2). After changed, hold the controller's PTT and pressing  + , and then release the PTT, at this time the controller will beep and show the ANI ID code of the controlled transceiver, which means exit the remote changing mode.



(3). If you want to cancel the changed DCS tone, you can turn off and then turn on the transceiver, it will be back to the previous setting.

Special Reminder

» In remote changing mode, if the controlled transceiver doesn't receive any DTMF tone from the controller after 30 seconds, it will automatically exit the remote connection. Also, you can input   to exit.

» In remote control mode, the priority functions are prohibited.

Special Reminder

- » In remote control mode, after got a beep prompt, the speaker will turn off, and the other VFO cannot receive.
- » If the transceiver is low voltage, excessive voltage, or in repeating transmitter/receiver mode, it will not activate the remote control connection function.
- » After activated the remote control setting, the PTT and all keypads will not work except the ,  and  keys.

E.g.: The original settings of the controlled transceiver are,

VFO A: RX Freq.: 440.02500MHz, TX Freq.: 445.02500MHz,

VFO B: RX Freq.: 140.02500MHz, TX Freq.: 145.02500MHz

VFO A and B: TX/RX CTCSS Tone: 67Hz, Control code (CONTR CODE): 654321

1. Change the VFO A's working frequency to 443.02500MHz (same transmitting and receiving frequency).

(1). Set the controller handheld or mobile transceiver:

TX Freq.: 140.02500MHz, RX Freq.: 145.02500MHz.

(2). After activated the remote changing function (MENU 44), hold the PTT, and pressing 654321 + AC, then release the PTT, with the beep prompt heard, the transceiver enters the remote control mode, meanwhile, it will reboot, and then,

(3). Hold the PTT again, and pressing  +  +  +  +  +  +  +  +  + , then release the PTT. With a beep prompt heard, the controlled transceiver will reboot and show the new TX and RX frequency 443.02500MHz on VFO A, there is no change on VFO B.



2. Change the VFO A's receiving CTCSS tone to 151.4Hz (But it will change the two VFO'S CTCSS tone simultaneously).

(1). Set the controller handheld or mobile transceiver:

TX Freq.: 440.02500MHz, RX Freq.: 445.02500MHz.

(2). Hold the PTT, and pressing 654321 + AC, then release the PTT, with the beep prompt heard, the transceiver enters the remote control mode, meanwhile, it will reboot, and then,

(3). Hold the PTT again, and pressing  +  +  +  +  + , then release the PTT. With a beep prompt heard. At this time, the new RX CTCSS of both VFOs is 151.4Hz, but the TX CTCSS is still 67Hz, which will not be changed.

(4). Exit remote changing mode: Hold PTT and pressing  + , and then release the PTT. The controller will show the controlled transceiver's ANI ID and then return to standby.

Wire-clone Function

Connect the two transceivers with the connection cable on the PC jack, press  key of the source transceiver, the two transceivers' screen will display CommUtaio Data, it starts copying.

After finishing the copying, the two transceivers will reboot, if failed copying, they will return to standby mode.

Optional accessories

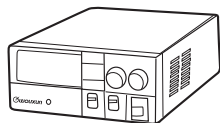

Switching Power Supply (30A)

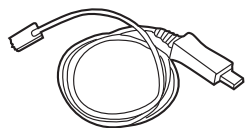

USB Programming Cable



Mobile Speaker / Mic



Omni-antenna

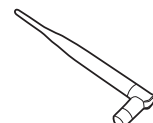

Omni-antenna



Directional-Antenna



Clamps Install Mount

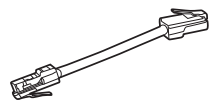

Connection Cable

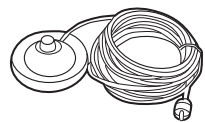

Strong Magnetic Mount

Troubleshooting

Before assuming your transceiver is broken, please check your transceiver according to the following table; if the problem persists, you can reset the transceiver, which sometimes resolves problems with settings.

Fault	Solution
Reception prompt remains but speaker is silent	<ul style="list-style-type: none"> » Check that the volume knob has been set to maximum. » Please reset sub-audio settings to check whether different channels from other group members have been set. » Check whether squelch settings are correct.
Keypad is unresponsive	<ul style="list-style-type: none"> » Check whether keypad has been locked. » Check whether other keys have been pressed.
Other voices (not from group members) appear in the channel.	<ul style="list-style-type: none"> » Please change the CTCSS / DCS code.
Receive regular voice pause (About 3 second intervals)	<ul style="list-style-type: none"> » Please see if the "PRICH-SW" (Priority scanning switch) is turned on.
Can not enter scanning mode	<ul style="list-style-type: none"> » Please see if the scan group channel, Scan Add function is turned on.
Transceiver automated activation/deactivation switch	<ul style="list-style-type: none"> » Please make sure all used power sources are under 11.5V, or if the "APO" switch is on.
When pressing the transceiver PTT key to transmit, there is no output power and no reception	<ul style="list-style-type: none"> » See if it has been stunned or killed.
Cannot set up the cross-band repeater	<ul style="list-style-type: none"> » Please make sure A/B area is on the cross-band repeaters operating frequency.
Cannot transmit in repeat mode	<ul style="list-style-type: none"> » Please check to see if the receivers squelch and CTCSS / DCS settings are correct.

Wouxun endeavors to achieve the accuracy and completeness of this manual, but it is still not perfect for any possible omissions or printing errors. All the above is subject to be updated without prior notice.