

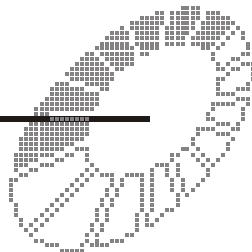

BARRETT 2050

ADVANCED HF SSB TRANSCEIVER



Operating and Installation Manual



BCM20500/18 - © Barrett Communications

www.barrettcommunications.com.au

Head Office:

Barrett Communications Pty. Ltd.
8-10 Port Kembla Drive
Bibra Lake, Western Australia, 6163
P O Box 1214, Bibra Lake, Western Australia,
6965
AUSTRALIA
Toll free number (within Australia) 1800 999 580
Telephone: +618 9434 1700
Facsimile: +618 9418 6757

European Office:

Barrett Europe Ltd.
Unit 9, Fulcrum 2, Victory Park
Solent Way

Whiteley PO15 7FN
UNITED KINGDOM

Telephone: +44 1420 542254
Facsimile: +44 1420 543373

Americas Office:

Barrett USA LLC
15941 W 65th Street
Suite 373

Shawnee 66217
UNITED STATES OF AMERICA

Telephone: +1 913 320 1111
Facsimile: +1 913 270 1111
Email: information@barrettusa.com

Email: information@barrettcommunications.com.au
Web Site: www.barrettcommunications.com.au

Email: sales@barretteurope.co.uk

Email: information@barrettusa.com

Barrett 2040,Barrett 2050 Compliance..... 9

FCC RF Exposure Compliance Statement..... 9

FCC RF Exposure Warning 10

FCC Modulation Modes 10

Industry Canada Modulation Modes 10

About this Operating and Installation Manual..... 11

Icons and Standards..... 11

 Scroll keys..... 11

Abbreviations and Acronyms..... 11

Introduction..... 13

Operation..... 14

User Controls 14

 2050 transceiver front panel description 14

 Power on/off button 14

 IR port 14

 Alert button..... 14

 Keypad..... 15

 Locking and Unlocking the Keypad..... 17

 2050 transceiver control head rear view 19

 Microphone socket 19

 Interconnect cable 19

 2050 transceiver rear panel description..... 20

Switching on the Transceiver..... 21

 Switching on the transceiver – without a pin number 21

 Switching on the transceiver – with a pin number 21

 Switching off the transceiver..... 21

Display..... 22

 Receive mode 22

 Transmit mode 22

 Secure mode..... 23

 Channel attributes 23

Adjusting the Audio Volume 24

Selecting a Channel..... 24

 Using channel Up/Down keys..... 24

 Direct channel number entry..... 25

Using the Microphone 26

Contacting Another Station - Using Selective Call “Selcall” and Telcall..... 27

 General..... 27

 International 27

 OEM 1 27

 CCIR 27

 ALE FED STD 188 / MIL STD 188-141B (option) 27

 Selective call –“Selcall”..... 28

 Selective call “Telcall”..... 28

 Special notes when using OEM 1 selective call protocol..... 28

 Entering station ID’s and using the address and telephone books 28

 When asked to enter a station ID:- 29

 When asked to enter a telephone number:- 31

 Checking for the best channel to use between two stations - Beacon Call..... 32

Sending a Beacon Call	32
Receiving a Beacon Call.....	33
Sending a Selcall	33
Receiving a Selcall.....	34
Receiving a Selcall directed to your transceiver.....	34
Receiving all calls, group calls and sub-group calls	35
Emergency calls.....	37
Receiving an emergency call.....	39
Direct dial telephone calls - Telcalls.....	40
Making a direct dial telephone call - sending a Telcall	40
Last number redial.....	41
Hang-up call	42
Making a preset (abbreviated number) telephone call.....	43
Call History.....	45
Erasing Calls From History.....	45
Scanning Channels.....	47
Selcall scan	47
Signal strength scan (SSL scan).....	47
Voice (syllabic) scan.....	47
Selecting a scan table	48
Initiating scan	48
Clarifier	49
Noise Reduction Selection.....	50
Mute (squelch) Selection.....	51
Mode Selection.....	52
Tune.....	52
Advanced Selective Call Functions	53
Requesting another station's GPS position.....	53
Sending your GPS position to another station	55
Text messaging – “Pagecall”, “SMS”	56
Sending a “Pagecall” “SMS”	56
Receiving a “Pagecall” “SMS”.....	58
Remote station operational status – “Statcall”	59
Requesting another stations status.....	59
Person to person(s) secure call.....	61
Tuning the Receiver.....	62
Scanning with the Tunable Receiver	63
Setting up scan frequencies	63
Start receiver scanning.....	64
Menu Functions	65
Menus	65
Standard Menu	66
Identification	66
Display Options.....	68
Backlight level	68
Backlight timeout.....	69
Call History.....	70
New Call.....	70
Inbox	70
Outbox	71
Address Books.....	73
Selcall ID Book – add a new entry	73

Selcall ID Book – edit an entry.....	75
Selcall ID Book – erase an entry.....	76
Phone book - add a new entry.....	77
Phone book - edit an entry.....	79
Phone book - erasing an entry.....	80
IR Enable	82
Audio Scrambler	83
To enable scrambled mode.....	84
To disable scrambled mode	84
2040 Antenna Select (available when 2050 deployed in 2040 manpack adaptor)	85
Protected Menu	86
General	86
Microphone Up/Down keys.....	86
Transmit “over beep”	87
Transmit timeout	88
Channel labels	89
Edit labels.....	89
Delete a label	90
Add an entry.....	91
Setting the clock.....	92
Setting the date.....	93
B.I.T.E. test	94
Option installation.....	95
Hopping PIN number entry.....	96
Secure call code.....	97
Security Level	98
Upload pack	99
Internal Modem	100
Scan Tables.....	102
Adding channels to a scan table.....	102
Editing channels in a scan table.....	103
Erasing entries in a scan table.....	104
Changing scan table labels	106
Scan Settings	108
Scan rate.....	108
Scan dwell.....	109
Scan resume time	110
Scan table select.....	111
Mute Settings	112
Syllabic mute sensitivity	112
Signal strength mute level	113
Selcall Settings	114
Selcall ID 1 – setting 4 digit Selcall self ID	114
Selcall ID 2 – setting 4 digit Selcall self ID	114
Setting six digit ID – setting 6 digit Selcall self ID.....	115
Setting Selcall MMSI – GMDSS Selcall self ID (for future use)	115
Selcall alarm	116
Selcall transmit tones audio level	117
Selcall pre-amble length setting.....	118
TXCVR lock	119
OEM pagecall key.....	121
Audio Settings.....	122
Audio bandwidth.....	122

"Beep" volume level.....	123
Receiver audio path configuration	124
Transmitter audio path configuration	125
Line audio	126
Noise reduction	127
RF Settings.....	128
Optional IF filter enable	128
Receiver pre-amplifier	129
Clarifier range	130
Noise blanker threshold.....	131
RF power level	132
I/O Settings.....	134
RS-232 out.....	134
External alarm.....	135
Antenna type.....	136
GPS receiver enable	137
Line output level adjust.....	138
Line input level adjust.....	139
Frequency Hopping (Option - Export Permit Required)	140
Selecting the hop band.....	140
Entering the security code.....	140
Security codes and bandwidths	140
To enable hopping mode.....	141
To disable hopping mode	141
Security code management.....	142
Changing the hop code	142
Code distribution	142
Network planning and contingencies	142
Automatic Link Establishment (ALE) (Option).....	143
ALE system overview.....	143
Operation overview	143
To commence scanning	144
Linking to another station in an ALE network.....	145
Making a Netcall.....	148
Sending an ALE text message to another station in an ALE network.....	151
Making a telephone call via ALE stations with telephone interconnect facilities	156
Selecting ALE station ID's	160
Receiving an ALE call	161
Receiving an ALE message	164
Receiving an ALE telephone call	166
Receiving an ALE Netcall.....	168
Closing individual ALE links.....	170
Closing an all ALE links.....	172
Remote station closes the ALE link.....	173
Combined ALE / Selective Call Capability.....	174
Overview	174
To commence scanning	174
Transmitting an ALE call	175
Receiving an ALE call	175
Receiving and transmitting a Selective call (Selcall)	175
ALE Configuration Menus	176

ALE enable	176
ALE scan list select	177
Auto transmit.....	178
Transmit control	179
Sounding control	180
Sounding address	181
Link quality analysis (LQA) exchange.....	182
Link quality analysis (LQA) exchange mode	183
LQA averaging	184
Link quality analysis (LQA) decay rate.....	185
Threshold test	186
SINAD threshold	187
BER threshold.....	188
ALE fill mode.....	189
Programming Functions.....	190
Programming using the Barrett 2050 programming software	190
Programming using the Barrett cable P/N BCA90023/BCA204020.....	190
Programming using the IrDA link.....	191
Programming a channel from the front panel	192
Transmit and receive frequencies.....	192
Channel use labels.....	193
Operating mode.....	193
Transmitter power setting	194
Antenna socket selection.....	194
Selcall format	195
Cloning (programming) from another transceiver.....	196
2050 Transceiver in the 2040 Manpack Adaptor	198
Fitting the 2050 into the 2040 manpack adaptor	199
Removing the battery cartridge.....	199
Powering and charging the Barrett manpack	200
Charging a 10Ah lithium ion battery cartridge outside the manpack.....	201
Battery charge indicator when charging the 2040	202
Operation in the Manpack Configuration	203
Manpack operation using the automatic antenna tuner.....	203
Using the whip.....	203
Using the throw over long-wire antenna.....	204
Using the counterpoise.....	205
Operation of the Manpack in Frequency Hopping Mode.....	206
Operation of the Manpack in Temporary Base Stations.....	207
Deploying the end fed single wire low power broadband	207
Deploying the tactical rapid deploy, tuned, end fed, low power dipole.....	208
Connectors.....	209
Auxiliary socket	209
ESU/CW socket	210
Handset Socket.....	210
Power socket	211
Installing the Barrett 2050 Transceiver.....	212
Land Based Systems	215
Mobile Installations.....	228
Marine Installations.....	243

Connectors	247
Overview of HF Operation	249
Limited 3 Year Warranty	253
Warranty registration and customer support	254

Barrett 2040, Barrett 2050 Compliance**Barrett 2000 series transceivers comply to the following communications standards:-**

Australian / New Zealand Standard
MF and HF radio communications
Equipment in the land mobile service utilising single sideband suppressed carrier emission
AS/NZS 4770:2000

FCC Part 90

Barrett 2000 series transceivers comply to the following EMC standard:-

EN301 489-1 V 1.4.1 (2002-08)

Barrett 2000 series transceivers comply to the following electrical safety standard:-

EN60950-1:2002

FCC RF Exposure Compliance Statement

The Barrett 2040 Manpack Transceiver and the Barrett 2050 HF Transceiver have been tested and comply with the Federal Communications Commission (FCC) RF exposure limits for the General Population/Uncontrolled exposure environment.

In addition, it complies with the following Standards and Guidelines:

FCC 96-326, Guidelines for Evaluating the Environmental Effects of Radio-Frequency Radiation

FCC OET Bulletin 65 Edition 01-01 (2001) Supplement C, Evaluating Compliance with FCC

Guidelines for Human Exposure to Radio Frequency Electromagnetic Fields

ANSI/IEEE C95.1-1992, IEEE Standard for Safety Levels with Respect to Human Exposure to Radio Frequency Electromagnetic Fields, 3 kHz to 300 GHz

ANSI/IEEE C95.3-1992, IEEE Recommended Practice for the Measurement of Potentially Hazardous Electromagnetic Fields - RF and Microwave

FCC RF Exposure Warning

To ensure optimal transceiver performance and to avoid exposure to excessive electromagnetic fields, the antenna system must be installed according to the instructions provided.

High voltages exist on the antenna during transmission and tuning. Do not touch the antenna during these activities. RF burns may result.

Install the grounding system or counterpoise as directed to prevent RF burns from any metal part of the transceiver.

Safe working distance is based on continuous exposure to CW type transmissions, as set out in the ICNIRP Exposure Guidelines (1998) for occupational exposure. Safe working distance can be reduced with normal voice communication.



For FCC compliance, when the 2050 transceiver is used at a power level of 100 watts PEP, the antenna(s) used with this transceiver should be located at least 3 metres from the operator and should not be co-located or operating in conjunction with any other antenna or transmitter.



For FCC compliance, when the 2040 transceiver is used at a power level of 30 watts PEP, the antenna(s) used with this transceiver should be located at least 1.5 metres from the operator and should not be co-located or operating in conjunction with any other antenna or transmitter.

FCC Modulation Modes

Please note that J3E Upper Sideband Mode is the only modulation mode available for operation in the United States of America.

Industry Canada Modulation Modes

Please note that J3E Upper Sideband Mode is the only modulation mode available for operation in Canada.

About this Operating and Installation Manual

This manual is comprehensive, describing all aspects of the transceivers functions and should be viewed as a reference manual.

A separate abbreviated Quick Reference Guide card with primary functions is also supplied with each transceiver and should be kept at the operating position of the transceiver.

Icons and Standards

Scroll keys

This manual refers to Scroll keys these keys are:-



to scroll Up



to scroll Left



to scroll Down



to scroll Right

Abbreviations and Acronyms

This term...	Means....
ALE	Automatic Link Establishment
Call history	A list containing details of the last thirty calls you have received
Station ID	The ID of the station being called (the receiving station's self ID)
GPS	Global Positioning System
HF	High Frequency
Identification Code	The unique reference identification (ID) of your transceiver (not serial number)
LCD	Liquid Crystal Display
LSB	Lower Sideband (Not available in FCC)

USB	Upper Sideband
PCB	Printed Circuit Board
PIN	Personal Identification Number
PSTN	Public Switched Telephone Network
PTT button	Press-to-talk button
RDD	Radio Direct Dial
Receive only channel	A channel that allows you to receive calls but not transmit calls
Revertive signal	An acknowledgement signal automatically transmitted from a station receiving a Selcall
RF	Radio Frequency
Rx	Receive
Scan Table incoming	A list of channels used when scanning for calls
Selcall	Selective calls
Telcall	Telephone calls via the selective call protocol
Self ID	The programmed address identification number of your station. (Used by other stations to call you).
SSB	Single Sideband (a transmission format)
Transmit channel	A channel that allows you to receive and transmit calls
Tx	Transmit
USB	Upper Sideband

Introduction

The Barrett 2050 transceiver is a DSP based, 500 channel HF SSB transceiver with a frequency range of 1.6 to 30 MHz. The Barrett 2050 is designed using the latest technology enabling a physically small package with a full feature complement.

Designed to operate in the most arduous environments, as encountered in off road vehicles, vessels and aircraft, the Barrett 2050 will provide many years of efficient and trouble free service.

The Barrett 2050 supports features such as selective call (Selcall), direct dial telephone connection to base stations fitted with telephone interconnect systems (Telcall), GPS location, ALE (Automatic Link Establishment), frequency hopping, data transmission and remote diagnostics. These features make the Barrett 2050 HF transceiver one of the most economical and versatile HF transceiver available today.

The Barrett 2050 transceiver, has catered for the increased use of HF data transmission for Internet email access and point to point data applications, by providing a comprehensive data modem interface port, high speed transmit to receive switching, a high stability frequency standard and an efficient cooling system option.

The Barrett 2050 transceiver can be operated in either a local (desktop) configuration for base station applications or, with the addition of an inexpensive mobile pack, in a remote control (trunk mount) configuration for mobile applications. When coupled with the 2040 manpack adaptor the 2050 becomes a full specification military/civilian manpack.

Operating from 12 volt (13.8 VDC) DC supplies, the transmitter is rated at 125 watt PEP in voice mode and is protected from over-voltage or reverse voltage application.

All 500 channels are available to be field or workshop programmable. Auxiliary features such as Selcall, Telcall, scanning, mute status, alarm system etc. can be individually enabled or disabled for every channel as required to suit your operation.

Teamed with other matching Barrett 2000 series products which include antennas, power supplies, vehicle tracking packages and HF modems, the Barrett 2050 HF transceiver becomes a powerful tool, providing solutions to many long distance communication requirements.

Operation

User Controls

2050 transceiver front panel description

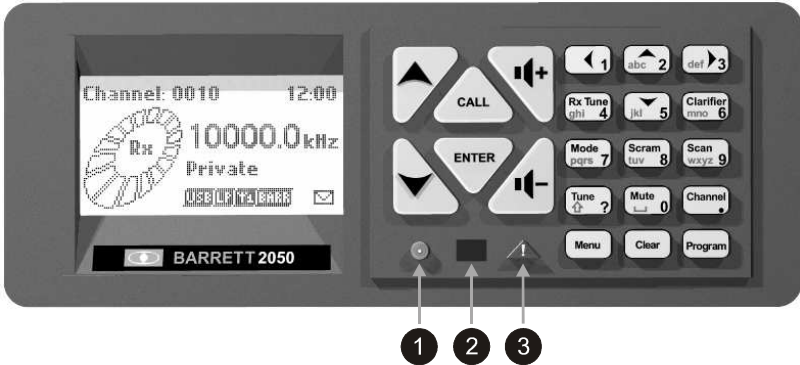

- 1 Power on/off button
- 2 IR port
- 3 Alert button

Power on/off button

The Barrett 2050 transceiver is turned on by pressing the green power button. The transceiver is turned off by again pressing the green power button.

IR port











The IR port is a serial communications port using the industry standard infra red communications protocol. This port can be used with various Barrett software products including the channel programming package.













Alert button

The Alert button is used to send Emergency Selcalls or tone calls.

Keypad

There are 23 keys on the keypad. A group of five keys in the centre access many major functions. Some keys have multiple functions assigned to them depending on when the key is pressed and for how long the key is pressed. Key functions are listed below followed by a detailed description of their functions.

Key	Key Primary function	Secondary function
	Power on/off	None
	Channel up	General scroll key
	Channel down	General scroll key
	Volume up	None
	Volume down	None
	Make a call	None
	Enter	Lock / Unlock Keypad
	Emergency call	None
	Enter menus	None
	Transmitter tune mode	Change case HELP
	Enter clarifier tune mode	Alpha "mno" Numeric key "6"

Key	Key Primary function	Secondary function
	Clear back one step	None
	Enter direct channel change mode	Decimal point
	Enter tuning receiver Mode	Alpha "ghi" Numeric key "4"
	Turn scrambler on / off	Alpha "tuv" Numeric key "8"
	Enter program mode	None
	Mute (squench) selection	Alpha "space" Numeric key "0"
	Mode select USB, LSB, AM, CW, AFSK	Alpha "pqrs" Numeric key "7"
	Start scan, hold for 2 seconds for scan table selection	Alpha "wxyz" Numeric key "9"
	Scroll left	Numeric key "1"
	Scroll up	Alpha "abc" Numeric key "2"
	Scroll right	Alpha "def" Numeric key "3"
	Scroll down	Alpha "jkl" Numeric key "5"

Locking and Unlocking the Keypad

The keypad can be locked by the user to stop accidental key press activity.

To lock the keypad press and hold down the  key. The display will show the following :



Once the  key has been held down long enough the "Keypad Locked" message will be displayed.



The "Keypad Locked" message will be shown whenever a key is pressed.

To unlock the keypad press and hold down the  key. The display will show the following :





Once the key has been held down long enough the “Keypad Unlocked” message will be displayed./



The keypad will automatically unlock when a Selcall or ALE call is received.

2050 transceiver control head rear view**Microphone socket**

The microphone supplied with the Barrett 2050 is inserted here.

Note:- When the transceiver is supplied it is assembled in the one piece base station configuration and the microphone is already fitted. If using the 2050 in the remote control (trunk mount) configuration refer to the section "Installing the Barrett 2050 transceiver".

Interconnect cable

When used in a base station configuration (one piece unit, as supplied) the small interconnect cable supplied in the kit is plugged in here with the other end into the front of the main transceiver module. When used in the remote control (trunk mount) configuration the longer interconnect cable supplied is used.

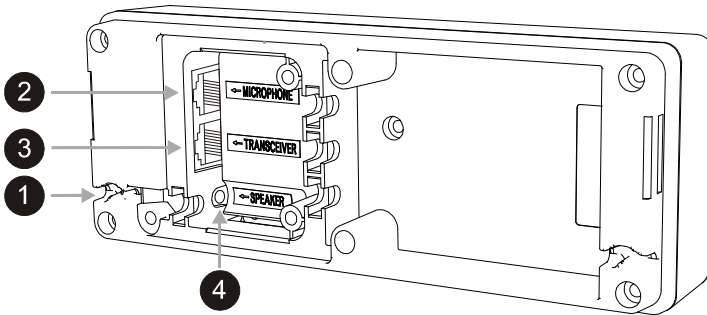

- 1 Cable restraints for mic cable
- 2 RJ-45 8 way microphone socket to suit Barrett hand microphone P/N BC200010
- 3 RJ-45 8 way for remote head interface cable
- 4 Speaker Jack

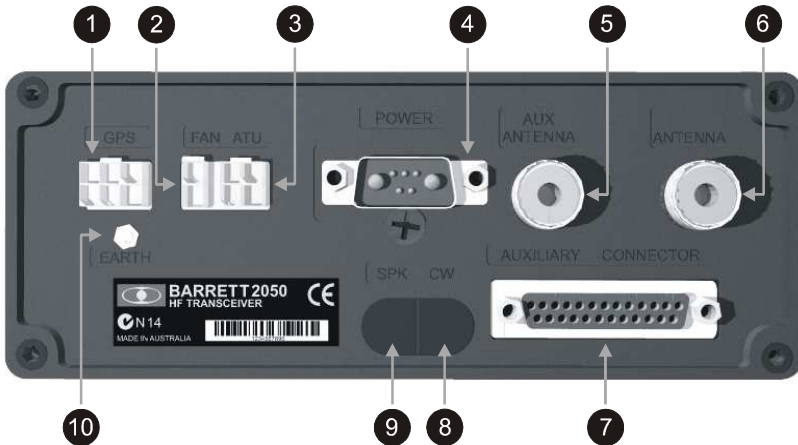
2050 transceiver rear panel description

- 1 Input for GPS receiver Barrett P/N BCA20009 for vehicle tracking/location applications.
- 2 Output for cooling fan unit Barrett P/N BCA20002 for high duty cycle applications such as data and email.
- 3 Interface for Barrett automatic tuning mobile antenna and marine automatic antenna tuners.
- 4 Power input and speaker output for use with 2022 power supply
- 5 Auxiliary antenna socket (channels can be programmed to use this socket or the main socket when using different antennas)
- 6 Main antenna socket
- 7 Auxiliary interface connector for use with external modems such as Barrett 2023 and Barrett 2024
- 8 Input for CW key Barrett P/N BCA20014
- 9 Output for loudspeaker Barrett P/N BCA20015
- 10 Chassis earth connection

Switching on the Transceiver

Switching on the transceiver – without a pin number

Press  for 1 second turns transceiver on.

Switching on the transceiver – with a pin number

Press  for 1 second turns transceiver on.

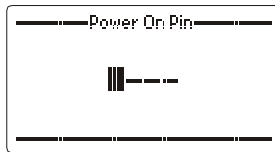

Enter the PIN number and press  key

The transceiver will now be switched on, if however the incorrect PIN number was entered the following is displayed:-

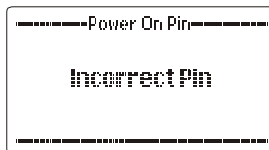

This display will time out and allow the re-entry of the PIN number. If however the PIN number is entered 10 times incorrectly the transceiver will not allow PIN number entry for a period of one hour displaying the following:-



Note:- The power on PIN number would have been loaded into the transceiver during programming if the function is in use. Refer to your network administrator.

Switching off the transceiver

Press  for 1 second turns transceiver off.

Display

Receive mode

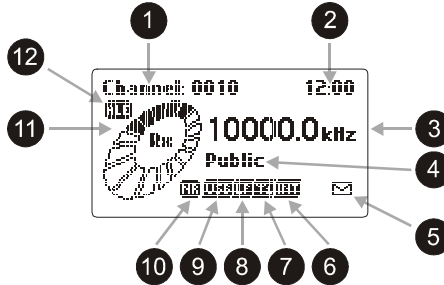

In receive mode the LCD display shows:-

- | | | | |
|---|--------------------------|----|---------------------------|
| 1 | Channel number | 7 | Antenna in use |
| 2 | Time | 8 | Power setting |
| 3 | Receive frequency. | 9 | Mode |
| 4 | Channel use | 10 | Noise reduction activated |
| 5 | Missed Selcalls received | 11 | Receive signal strength |
| 6 | Selective call mode. | 12 | ALE active. |

Transmit mode

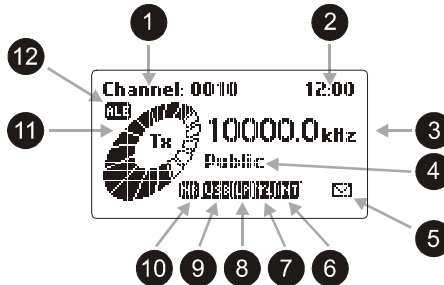

In transmit mode the LCD display shows:-

- | | | | |
|---|--------------------------|----|---------------------------|
| 1 | Channel number | 7 | Antenna in use |
| 2 | Time | 8 | Power setting |
| 3 | Transmit frequency. | 9 | Mode |
| 4 | Channel use | 10 | Noise reduction activated |
| 5 | Missed Selcalls received | 11 | Transmit power |
| 6 | Selective call mode. | 12 | ALE active |

Secure mode

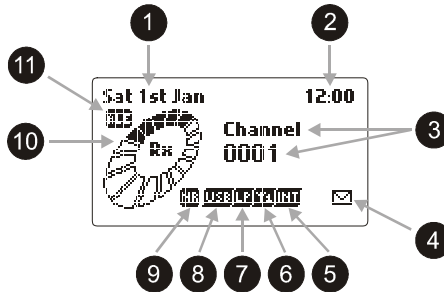

In secure mode the LCD display shows:-

- | | | | |
|---|--------------------------|----|---------------------------|
| 1 | Date | 7 | Power setting |
| 2 | Time | 8 | Mode |
| 3 | Channel number | 9 | Noise reduction activated |
| 4 | Missed Selcalls received | 10 | Receive signal strength |
| 5 | Selective call mode. | 11 | ALE active |
| 6 | Antenna in use | | |

Channel attributes

Pressing and holding down the  key for more than 2 seconds will reveal more details about the currently selected channel:-

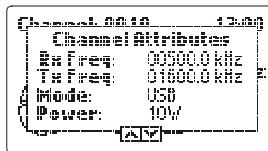

Using the **Scroll keys** to scroll down will reveal further details:-

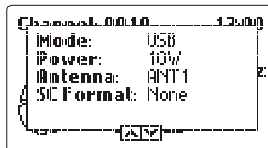

Note:- when in Secure mode the channel attributes do not show frequencies.

Adjusting the Audio Volume



To increase the audio volume in the loudspeaker



To decrease the audio volume in the loudspeaker

The display looks like this when adjusting the volume:-

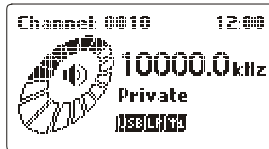

Selecting a Channel

Using channel Up/Down keys

Pressing the channel up or down key will select respectively the next higher or lower programmed channel. Holding down either of the keys will cause the rate of the channel change to increase.

The channel up/down keys on the microphone have the same function as the channel up/down keys on the keypad.



Channel up



Channel down

Note:- The microphone up/down buttons needs to be configured for channel change function either when programming the transceiver or in the “**General**” section of the protected menu.

Direct channel number entry

press the  key

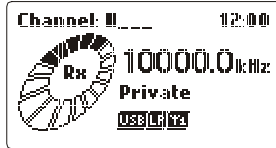

Enter the channel number required, using the numeric keys, channel range is from 1 to 9999 inclusive. Note:- **Channel zero cannot be selected.** (example selects channel 12)

press the   keys

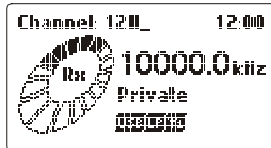

press the  key



If the channel selected had not been previously programmed then the following is displayed:-

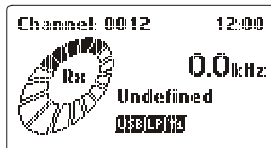

Note: Empty channels can only be accessed by direct channel selection and are not displayed when scrolling through channels.

Using the Microphone

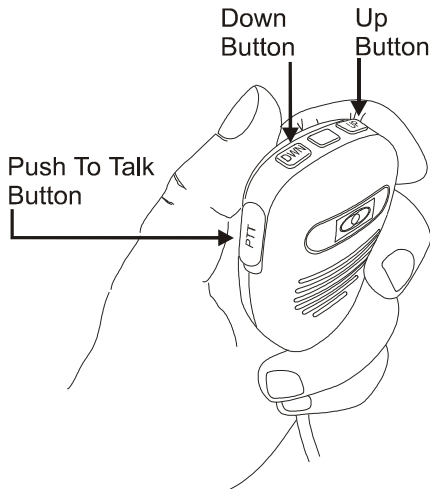

When using the microphone:-

Press and hold down the PTT (transmit) button only while talking

Hold the microphone close to your mouth

Speak clearly

Use the word 'over' to indicate you have finished speaking and release the PTT (transmit) button.

The up/down buttons can be configured in the software to control either the audio volume or channel up/down operations.

Note:- the Barrett 2050 has a transmit "time-out" facility. This facility (when programmed) allows the transmitter to be keyed in transmit mode with the PTT (transmit) switch for a set time period, after which the transceiver switches to receive until the PTT (transmit) button is released and re-keyed. This facility prevents the transmitter transmitting for long periods of time if, for instance, the microphone becomes jammed between seats in a vehicle causing the PTT (transmit) switch to be held down.

Note:- Enabling, disabling and changing the time of the transmit timeout facility can be set either when programming the transceiver or in the "**General**" section of the protected menu.

Note:- The microphone up/down buttons can be configured for channel change or volume control functions either when programming the transceiver or in the "General" section of the protected menu.

Contacting Another Station - Using Selective Call “Selcall” and Telcall

General

In addition to the use of the transceiver in simple voice mode to call other stations there are several different types of selective calling systems available.

The calling systems available for the Barrett 2050 transceiver are listed below:-

International

A four and six digit selective call system, fully interoperable with the UN format published in September 2004 and fully backwards compatible with all previous Barrett 4 digit Selcall protocols.

Includes Selcall, Beacon Call, Pagecall (SMS) call, transceiver lock call and RFDS tone calls.

Also if the options are fitted to the transceiver it includes:-

GPS calls, used to either transmit your position to another station or request the position of another station fitted with the GPS option and receiver.

Telcalls for direct dial telephone number calling using base stations with telephone interconnect facilities.

Person to person secure calls

OEM 1

A four and six digit selective call system compatible with other major HF manufacturers including those using encryption. Includes Selcall, Telcall, Beacon Call, Emergency call, Pagecall and GPS call.

CCIR

A four digit selective call system as specified by CCIR-493.

Includes Selcall, Beacon Call, Pagecall (SMS) call and tone calls.

Also, if the options are fitted to the transceiver, it includes:-

GPS calls, used to either transmit your position to another station or request the position of another station fitted with the GPS option and receiver

Telcalls for direct dial telephone number calling using base stations with telephone interconnect facilities.

ALE FED STD 188 / MIL STD 188-141B (option)

MIL-STD Automatic Link Establishment system, see section “Automatic Link Establishment”

Selective call –“Selcall”

Selcall is a digital signalling system based on standard CCIR-493 for use on HF networks. Each station in an HF network is assigned an individual four or six digit ID (identification) and can be called using this ID.

Selective call “Telcall”

Telcall uses this digital selective call system to transport a telephone number from a station on an HF network to a base station equipped with a telephone interconnect unit to initiate phone calls onto the international telephone network.

Note:- For Selcall and Telcall functions to operate the transceiver must be fitted with the Selcall or Telcall option and the channels enabled for Selcall operation.

If **Automatic Link establishment (ALE)** is in use refer to the ALE section for operation details.

Special notes when using OEM 1 selective call protocol

All 6 digit OEM 1 protocol calls will only be decoded by other Barrett transceivers fitted with OEM 1 Selcall protocol or other manufacturers' transceivers using encryption.

OEM 1 protocol 4 digit calls will be decoded by Barrett 950 transceivers, Barrett 2050 transceivers using International 4 and 6 digit Selcall and other manufactures transceivers with similar CCIR 493 based selective call systems.

4 & 6 digit GPS and Status data calls use the OEM privacy key to encrypt the data. If this 8 digit key has not been programmed by the programming software a default privacy key of "99999999" is automatically used for transmission.

6 digit Pagecalls also use the privacy key but unlike the other calls the user has the option to manually enable or disable the privacy key. When disabled the data is sent as plain text. See "OEM Pagecall Key" in the protected menu "Selcall settings" section, to switch the privacy key "On" or "Off" when sending Pagecalls.

Emergency GPS data calls, both 4 & 6 digit, are automatically sent as plain text.

Entering station ID's and using the address and telephone books

Selcall and Telcall functions described in this section require station ID's or telephone numbers to be entered when making a call. They make use of convenient address and telephone books to allow frequently used Station ID's, station names and telephone numbers to be easily entered. This section describes how to enter station Selcall IDs and telephone numbers both manually and by using use the address and telephone books.

Note:- also see section "Address and phone books – adding, editing and deleting entries"

When asked to enter a station ID:-

Either enter the station ID using the numeric keys (the number of the station you wish to call, see “Station ID ranges”)



or if you think that station is in the address book use the **Scroll keys** to find the station you want to call:- .



then press the  key

or if you know the name of the station press the  key and either enter the first letter of the name you want to call using the alpha keypad then use the **Scroll keys** or use the **Scroll keys** to find the name of the station you want to call (example “r” entered):-



then press the  key

or press the  key and the last station called will be called again.

Station ID ranges

4 and six digit networks are all accommodated in the 2050 standard Selcall system

Station ID range from 000000 to 999999 inclusive (the destination ID **must** be either 4 or 6 digits long)

Calling groups**In four digit format**

All call A station sending X000 will be received by stations X000 - X999 (up to 890 stations*)

Group call A station sending XX00 will be received by stations XX00 - XX99 (up to 89 stations*)

Sub-group call A station sending XXX0 will be received by stations XXX0 - XXX9 (up to 9 stations*)

In six digit format

All call A station sending XXX000 will be received by stations XXX000 - XXX999 (up to 890 stations*)

Group call A station sending XXXX00 will be received by stations XXXX00 - XXXX99 (up to 89 stations*)

Sub-group call A station sending XXXXX0 will be received by stations XXXXX0 - XXXXX9 (up to 9 stations*)

* If using the group call system, stations cannot be programmed to have self ID's with last digits 000,00,0 as if you tried to call them a group call would occur.

Note:- All call, group call or sub-group call must be enabled, during programming, on a destination station for group calling to operate.

When asked to enter a telephone number:-

Either enter the telephone number using the numeric keypad (a number up to 16 digits)

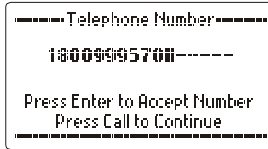

or if you think that telephone number is in the phone book use the **Scroll keys** to find the name and number you want to call:-



or if you know the name associated with the telephone number in the phone book press the  key and either enter the first letter of the name you want to call using the alpha keypad and use the **Scroll keys** or use the **Scroll keys** to find the name you want to call:-



or press the  key and the last phone number called will be called again.

Checking for the best channel to use between two stations - Beacon Call

Before using many of the Selcall and Telcall functions in this section it is useful to know how to use the "Beacon Call" function.

"Beacon Call" allows the operator to determine the signal quality between their station and a station they want to call on a particular channel, but without actually alerting the station they are doing so.

When a Beacon Call is sent to another station, if the channel being used is "open", the remote station sends back a distinctive 4 tone revertive signal. The operator can judge the quality of the channel for communications purposes by the strength and clarity of this distinctive tone. Using Beacon Calls on several available channels will determine which channel is best to use subsequent Selcalls or Telcalls

(Note:- both stations must be programmed for Selcall or Telcall operation)

Sending a Beacon Call

select the channel you think will be best to use (Refer to section Overview of HF operation)

listen for traffic on that channel, if no traffic is heard then continue.

then press the  key

select "Beacon Call" with the scroll keys



then press the  key

enter the station ID of the station you wish to Beacon Call (see "Entering station ID's and using the address and telephone books")

then press the  key

wait for the Beacon Call to be sent.

listen for the distinctive 4 tone revertive signal from the station you have called.

If no revertive call is heard or it was difficult to hear try another channel and repeat the process until the best channel is found.

Receiving a Beacon Call

When a transceiver receives a beacon request call, it responds by transmitting the Beacon Call reveritive tones. No indications occur on the transceiver. Beacon Calls are **not** saved in the Selcall history buffer.

Sending a Selcall

select the channel you want to send the Selcall on. ("Beacon Call" can be used to select the best channel)

listen for traffic on that channel, if no traffic is heard then continue

then press the  key

select "Selcall" with the scroll keys



then press the  key

enter the station ID of the station you wish to call (see **"Entering station ID's and using the address and telephone books"**)

then press the  key

wait for the selective call to be sent.

listen for reveritive tone from the called station that indicates the call was successful.

If no reveritive tone is heard or it was difficult to hear try another channel and repeat the process until a good channel is found.

If a reveritive tone is heard but you receive no verbal response from the station it may be because the operator is unavailable at the time.

Receiving a Selcall

To receive a Selcall your transceiver must be programmed for selective call (Selcall) and where multiple channels are in use the scan function should be activated.

Receiving a Selcall directed to your transceiver

When you receive a Selcall, your station sends a revertive call (to alert the calling station that its call was received), an audible alarm is sounded, the mute (squelch) (if selected) opens and the display shows the call as follows:-

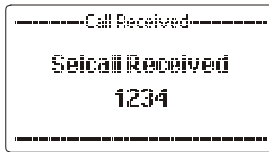

The audible alarm will sound for thirty seconds and then time out. To cancel the alarm before the time out period and to acknowledge the call, press PTT or any key. When the audible alarm times out the call received “Envelope” icon is displayed in the bottom right hand side of the display and a periodic audio reminder will be emitted:-



For details of previously received Selcalls enter “Call History” by holding the



key down for two seconds or more. Refer to the section “Call History”.

Receiving all calls, group calls and sub-group calls

Stations can send a selective call that will alert different groupings of mobiles as follows:-

In four digit format

All call A station sending X000 will be received by stations X000 - X999 (up to 890 stations*)

Group call A station sending XX00 will be received by stations XX00 - XX99 (up to 89 stations*)

Sub-group call A station sending XXX0 will be received by stations XXX0 - XXX9 (up to 9 stations*)

In six digit format

All call A station sending XXX000 will be received by stations XXX000 - XXX999 (up to 890 stations*)

Group call A station sending XXXX00 will be received by stations XXXX00 - XXXX99 (up to 89 stations*)

Sub-group call A station sending XXXXX0 will be received by stations XXXXX0 - XXXXX9 (up to 9 stations*)

* If using the group call system, stations cannot be programmed to have self ID's with last digits 000,00,0 as if you tried to call them a group call would occur.

Note:- All call, group call or sub-group call must be enabled, during programming, on a destination station for group calling to operate

Receiving an "All call", "Group Call", "Sub-Group Call"

When you receive any of the calls above an audible alarm is sounded, the mute (squelch) (if selected) opens and the display shows the call type as follows:-

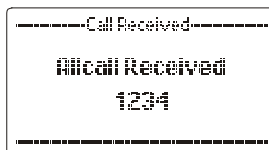
"All call"

“Group call”

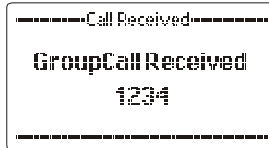

“Sub-group call”

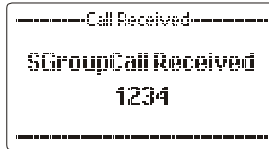

In all group calls the audible alarm will sound for thirty seconds and then time out. To cancel the alarm before the time out and to acknowledge the call press PTT or any key. When the audible alarm times out the call received “envelope” icon is displayed in the bottom right hand side of the display:-



For details of previously received Selcalls enter “Call History” by holding the



key down for two seconds or more. Refer to the section “Call History”.

Emergency calls

All Selcall emergency calls are transmitted by pressing the  button for more than two seconds and less than ten seconds and releasing, the alarm sequence starts upon button release.

The action of the emergency call button depends on transceiver programming:-

Selective call alarm that only transmits on the currently selected channel.

Transmits the emergency Selcall sequence once on each press of the  button.

If a GPS receiver is fitted and enabled the GPS position is also sent in the call.

Selective call alarm that transmits and automatically changes to a selection of channels

Transmits the emergency Selcall sequence twice on each channel programmed as an emergency channel, repeating this sequence until the transceiver is switched off

If a GPS receiver is fitted and enabled the GPS position is also sent in the call.

Note:-In all of the alarms above, after the alarm has been activated by using the  button, there is NO indication that an alarm is being sent for security purposes.

Royal Flying Doctor Service (RFDS) alarm

Two-tone alarm 880Hz + 1320Hz continuous (Australian use only) – alerts the Royal Flying Doctor Service on RFDS channels.

Press the  button for more than two seconds and less than ten seconds.



The RFDS alarm will continue transmitting for 10 seconds even if you have released the  button.

To cancel the RFDS alarm press the  key or the  button.

Note:- A momentary press of the  button initiates RFDS alarm test mode which emits the audio tones but does not transmit them. Another momentary press of the  button or the  key cancels the RFDS alarm test mode.

Note:- Emergency call settings are set during transceiver programming from the programming software only.

Receiving an emergency call

Barrett transceivers that receive the emergency Selcall emit a distinctive audio alarm and display the following:-

```
-----Call Received-----  
Emergency Call  
1234  
-----
```

If the transceiver sending the emergency Selcall is fitted with a GPS receiver the position will also be displayed as illustrated below :-

```
-----GPS Information-----  
Lat: 32°05.715S  
Long: 115°48.039E  
-----
```

If the transceiver sending the emergency Selcall was not fitted with GPS or no data is available the following is displayed:-

```
-----GPS Information-----  
No GPS Data  
at Remote Station  
-----
```

Direct dial telephone calls - Telcalls

Transceivers equipped with the Telcall option can direct dial telephone numbers and receive calls from telephone users through a Barrett telephone interconnect base stations.

Note:- If ALE is in use refer to the ALE section for details.

Making a direct dial telephone call - sending a Telcall

select the channel you want to send the Telcall on. ("Beacon Call" can be used to select the best channel)

listen for traffic on that channel, if no traffic is heard then continue.

press the  key

select "Telcall" with the scroll keys

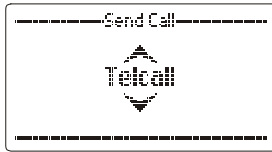

then press the  key

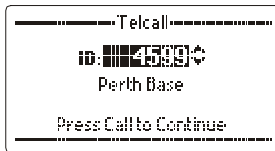

enter the station ID of the station you wish to make the phone call through (see "Entering station ID's and using the address and telephone books")

then press the  key

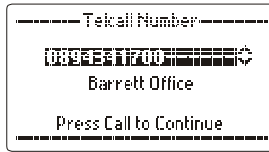

enter the telephone number you want to call (see “**Entering station ID’s and using the address and telephone books**”)

then press the  key

wait for the Telcall to be sent.

listen for reverive tone from the called station that indicates the call was successful.

If no reverive call is heard try another channel and repeat the process.

When the call is successful wait for telephone connection to be made and proceed with call..

When the call is complete or if the line is busy send a “Hang Up” call.

Last number redial

press the  key twice

the last telephone number sent will is displayed:-



then press the  key and the Telcall sequence will be re-sent.

Hang-up call

When a call to a telephone interconnect base station has been completed the caller should "hang up" by sending a "hang up" code:-

press the  key

select "Hang-up" with the scroll keys



then press the  key



select the ID of the telephone interconnect that you are connected through

then press the  key

When the hang-up Selcall has completed transmitting, listen for hang-up revertive signal, confirming the "hang up" was successful, if not heard repeat the above procedure.

Note:- If the hang up call is un-successful for any reason the telephone interconnect will time out and hang-up itself.

Making a preset (abbreviated number) telephone call

A base station equipped with telephone interconnect facilities is also capable of making preset (abbreviated number) telephone calls. Preset (abbreviated) telephone numbers are stored in the telephone interconnect unit and are accessed by sending a standard Selcall using a specific Selcall number.

select the channel you want to send the "hang up" call on.
("Beacon Call" can be used to select the best channel)

listen for traffic on that channel, if no traffic is heard then continue

press the  key

select "Selcall" with the scroll keys



enter the Selcall number representing the preset (abbreviated number as described below - Preset (abbreviated) Selcall numbering:-

then press the  key

wait for the selective call to be sent.

listen for revertive tone from the called station that indicates the call was successful.

If no revertive call is heard or it was difficult to hear try another channel and repeat the process until a good channel is found.

Preset (abbreviated) Selcall numbering

Enter xxxxAA or xxAA where xxxx or xx is the (four) six or (two) four digit Selcall ID of the base station equipped with telephone interconnect facilities and AA represents the preset telephone number (between 1 and 98)

Example:-

Entering 4523 will instruct a telephone interconnected base station with a four digit Selcall ID of 45XX to call preset (abbreviated) number stored as 23 in the telephone interconnect.

Entering 342547 will instruct a telephone interconnected base station with a six digit Selcall ID of 3425XX to call preset (abbreviated) number stored as 47 in the telephone interconnect.

Note:-

When using preset (abbreviated) number dialling, your network supervisor will issue you with a list of the preset numbers and the phone numbers they will dial when using a particular telephone interconnected base station.

Call History

Whenever a Selcall, Telcall, All call, Group call, Sub group call, Pagecall, Statcall GPS or Emergency call is received or transmitted its details are held in a first in first out call history buffer.

Received calls that have not been viewed before are held in a section called "New Calls", received calls that have been viewed are held for future viewing in the "Call Inbox" all transmitted calls are stored in the "Call Outbox". Each history buffer can store up to 30 entries.

Call history can be entered as follows:-

Either

Press and hold the  key for 2 seconds:-



Or

Select Call history in the Standard Menu section

Note:- A full description of navigating the call history section is described in the Standard Menu section of this manual.

Erasing Calls From History

Individual or all entries can be deleted from the Outbox, Inbox or New Calls section of the Selcall history. Below is an example of how to delete an individual call from the Inbox of Selcall history.

Enter Selcall history as described above.

Go to the Inbox menu.

Use the scroll keys to select the call to be deleted then press and hold the

Clear

key. The display will show the following:

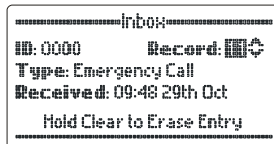

Hold the  key until the “Erase Entry” screen is shown.



press the  key and the entry will be deleted.

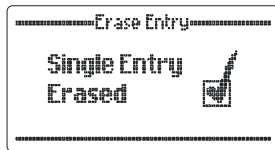

To delete all entries from a Selcall history section scroll to the “All Entries” screen then press the  key.



Scanning Channels

Scanning allows a HF transceiver to monitor several channels for incoming calls. It is particularly useful as the nature of HF signal propagation means that not all channels are available for communications at one time. For instance, a station calling a station that is in scanning can send a "Beacon Call" on any channel knowing the station it is calling is monitoring all its available channels. A response from the scanning station will only occur on channels that are "open" for communication.

Stations in scan can also monitor channels for voice activity or signals received that has a signal strength over a preset level.

Selcall scan

When a Selcall signal is detected, and the channel has Selcall enabled, no matter which mute type is selected the transceiver will stop scanning and decode the Selcall. The transceiver will only stop scanning when a Selcall is detected.

Signal strength scan (SSL scan)

If the signal strength mute (squelch) is active and a signal with a level greater than the pre-set threshold is received the scan will halt. Scan will remain halted while the signal level stays above the preset threshold. Once the signal decreases below the pre-set threshold level, for a period greater than the scan dwell period, scanning will resume.

Voice (syllabic) scan

If the audio mute (squelch) is active and is opened scanning will halt. Scanning will remain halted while the audio mute is open. Once the mute closes, for a period greater than the scan dwell period, scanning will resume.

The Barrett 2050 transceiver has up to eight scan tables available each table being able to be programmed with up to thirty channels. (See Menus and Programming for details on channel entry)

Selecting a scan table

press the  key for more than two seconds
use the scroll keys to select the scan table number



then press the  key

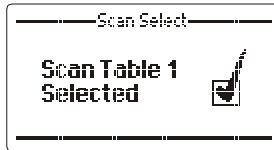

Note:- If no scan tables are programmed the following is displayed:-



Initiating scan

Momentarily press the  key.

Alternatively scan may be programmed as a default condition so when the transceiver is switched on, scan is automatically initiated, or after a period of inactivity, i.e. no key presses, the transceiver returns to scan.

Clarifier

The clarifier is used to finely tune the receiver on the selected channel to compensate for received signals from other stations that are off frequency.

The receiver can be tuned in the clarifier mode in steps of 1Hz to frequencies up to -1KHz and +1KHz of the assigned channel frequency, depending on programming. (see note below)



to enter clarifier tune mode.

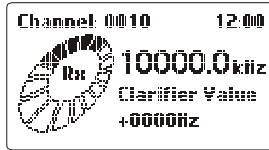

or



tune clarifier up



or



tune clarifier down

Note:- There are five clarifier ranges available, these ranges can be set either when programming the transceiver or in the “**RF Settings**” section of the protected menu.

Note:- The clarifier value is set to zero when the channel is changed or the transceiver is turned off.

Noise Reduction Selection

The DSP noise reduction system is enabled and disabled by momentary pressing the  key.

When the noise reduction system is selected the display shows a small square to the right of the mode indication notated NR as below:-



The DSP noise reduction system is disabled by momentary pressing the  key.



Note:- There are three levels of noise reduction available, these levels can be set either when programming the transceiver or in the **“Audio Settings”** section of the protected menu.

Mute (squelch) Selection

There are three mute (squelch) modes:-

Audio (syllabic) mute (squelch) – the receiver audio is enabled when speech is detected on the selected channel.

Note:- The syllabic mute sensitivity can be set to three levels, these levels can be set either when programming the transceiver or in the “**Mute Settings**” section of the protected menu.

Selective call mute (squelch) – the receiver audio is enabled after a Selcall sent to the unit has been received and decoded successfully

Signal Strength Level (SSL) mute (squelch) – the receiver audio is enabled when the received signal strength exceeds the nominated threshold level.

Note:- The signal strength mute level can be set to three levels, these levels can be set either when programming the transceiver or in the “**Mute Settings**” section of the protected menu.

The current mute (squelch) state is displayed the first time the mute key  is pressed.

To change the mute state, while the mute state is still displayed from the first press of the mute key, press the mute key again to scroll through to the required mute state.

Press the  key



Press the  key



Mode Selection

The mode key changes the mode of operation - LSB, USB, AM, CW or AFSK of the selected channel. The mode key will only temporarily set the mode for a selected channel, the mode reverting to that channel's programmed mode after the channel is changed, or the transceiver is turned off.

Press the  key repeatedly to select the required mode:-



Note:- If the IF filter option is physically fitted and enabled in software, it will automatically be selected when CW and AFSK mode is selected.

Tune

Press and hold down the  key to tune:-

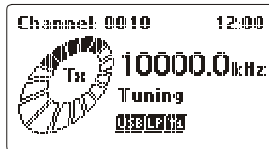

When tuning, the transceiver will transmit, at the power level selected, a carrier on the channel selected, at **1.6 kHz above the Suppressed Carrier Frequency (SCF)** (displayed frequency) of that channel.

When the tune key is released the display shows the antenna VSWR.



Advanced Selective Call Functions

Requesting another station's GPS position

select the channel you want to send the GPS request call on.
("Beacon Call" can be used to select the best channel)

listen for traffic on that channel, if no traffic is heard then press the



key

select "GPS Request" with the scroll keys



then press the  key

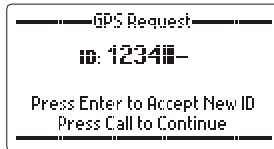

enter the identification of the station you want to request the GPS position from (see "Entering station ID's and using the address and telephone books")

then press the  key

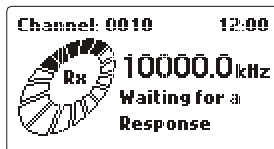

Wait for the station you called to send back its position data after which the following will be displayed:-

The station called GPS position:-

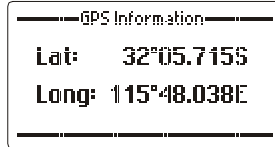

or – the following error messages:-

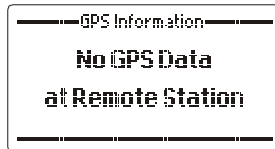

The GPS unit is not providing data to the remote transceiver



There is no GPS receiver fitted to the remote transceiver



There was no response from the remote station

Sending your GPS position to another station

select the channel you want to send the GPS call on. ("Beacon Call" can be used to select the best channel)

listen for traffic on that channel, if no traffic is heard then continue.

press the  key

select "GPS Send" with the scroll keys:-

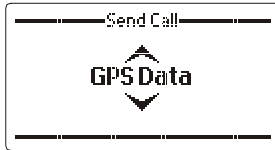

then press the  key

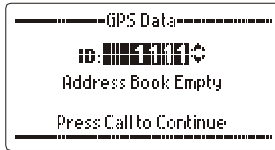

enter the identification of the station you want to send your GPS position to (see "Entering station ID's and using the address and telephone books")

then press the  key



Your GPS position will now be transmitted, wait for a revertive tone from the remote station to confirm the call was received, if no revertive tone is heard repeat the process or change to another channel and repeat the process.

Note:- The GPS interface option BCO205004 must be fitted and the GPS receiver P/N BCA20009 must be connected and receiving position information when using the GPS call option.

Note:- If the display indicates that the GPS is unavailable as shown below you cannot select the selective call function “GPS data.”

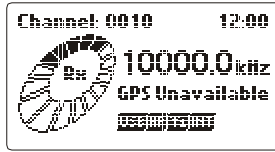

Text messaging – “Pagecall”, “SMS”

Pagecall allows messages of up to 32 characters to be sent or received to and from other transceivers with Pagecall facilities.

Sending a “Pagecall” “SMS”

select the channel you want to send the Pagecall on. (“Beacon Call” can be used to select the best channel)

listen for traffic on that channel, if no traffic is heard then continue.

press the  key

select “Pagecall” with the scroll keys



then press the  key

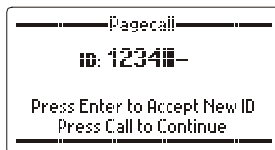

enter the identification of the station you want to send the Pagecall to (see “**Entering station ID’s and using the address and telephone books**”)

then press the  key



type in your messages using the alpha numeric keys



then press the  key



Receiving a “Pagecall” “SMS”

When a Pagecall is received an audible alarm is sounded, the mute (squellch) is opened and the display shows the following:-

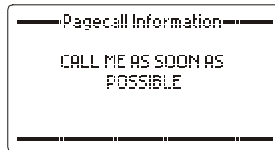

The audible alarm will sound for thirty seconds and then time out. To cancel the alarm before the time out period and to acknowledge the call, press PTT or any key.

When the audible alarm times out the call received “**Envelope**” icon is displayed in the bottom right hand side of the display.

For details of previously received Pagecalls enter “**Call History**” by holding the



key down for two seconds or more.

Remote station operational status – “Statcall”

“Statcall” allows the operational status parameters of any Barrett transceiver fitted with Selcall to be accessed. This status is sent from the remote transceiver as a Selcall with the status information embedded within the Selcall structure. Information retrieved for remote diagnosis of transceiver performance includes:-

- Selcall ID
- Software version
- Option level fitted and transceiver model
- Receive state battery voltage
- Last transmit state battery voltage
- Signal strength indication of received status request Selcall.
- Forward power output level
- VSWR of antenna

Requesting another stations status

select the channel you want to send the Status request call on. (“Beacon Call” can be used to select the best channel)

listen for traffic on that channel, if no traffic is heard then continue.

Then press the  key

select “Status Request” with the scroll keys

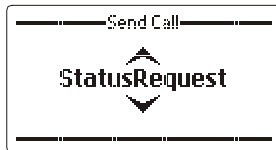

then press the  key

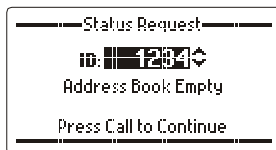

enter the identification of the station you want to request the operational status from (see “**Entering station ID’s and using the address and telephone books**”)

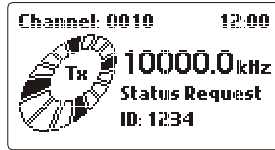

then press the  key



The status request is being transmitted



Your station is waiting for the station you called to send back its "Status data" (which sounds like the remote station sending a Selcall to you) after which the following will be displayed, use the

 or  keys to move through the pages:-

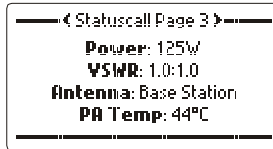
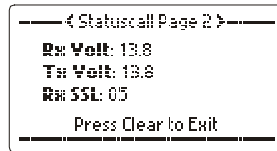

or – the following error messages:-



There was no response from the station you requested the status from, repeat the process or change the channel and repeat the process

Person to person(s) secure call

This facility allows a secure voice connection to be made between two or more stations.

Note:- In the protected menu "Audio Setting" section, scrambler must be enabled in the "Scrambler section" and in the "Scrambler code" section a 4 digit number entered. For security purposes this code must be the same as the code set in the station you wish to call.

select the channel you want to set up the secure link on. ("Beacon Call" can be used to select the best channel)

listen for traffic on that channel, if no traffic is heard then continue.

press the  key

select "Secure Selcall" with the scroll keys



press the  key



enter the station ID of the station you wish to call (see "**Entering station ID's and using the address and telephone books**")

Note:- to make a secure call to multiple stations use a group call ID encompassing the required stations.

press the  key

wait for the selective call to be sent.

listen for revertive tone from the called station that indicates the call was successful.

If no revertive tone is heard or it was difficult to hear try another channel and repeat the process until a good channel is found. Revertive tones will not be heard if using a group call code to call multiple stations.

Tuning the Receiver

The 2050 transceiver can be used as a tunable receiver. The receiver can be tuned from 500 KHz to 30 MHz. in steps ranging from 1 Hz up to 10 MHz.

Press the  key to enter the tuning receiver mode:-

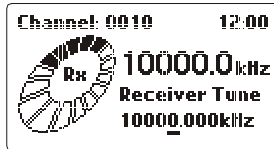

To tune the receiver move the cursor over the digit representing the frequency increment required in the receiver frequency display you wish

to tune using either the  or  keys, then use.



or



to tune up in frequency



or



to tune down in frequency

press the  key to return to the previous operating channel.

Scanning with the Tunable Receiver

The receiver can scan any range of frequencies from 500 KHz to 30 MHz with a frequency step down to 10 Hz.

Setting up scan frequencies

To set up the frequency scan parameters, enter the tuning receiver mode, then:-

Press the  key for two seconds until the following is displayed:-

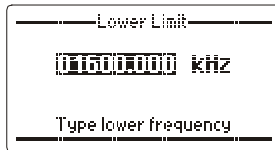

Enter a new frequency, using the numeric keys, to set the lower scan limit boundary - example below shows the lower limit set to 12 MHz:-

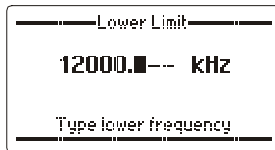

then press the  key

Enter a new frequency, using the numeric keys, to set the upper scan limit boundary - example below shows the upper limit set to 14 MHz:-

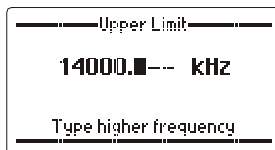

then press the  key



Using the Scroll keys select step increment required in Hz (Steps available 100Hz (0.1kHz), 250Hz (0.25kHz),1000Hz (1kHz), 2500Hz (2.5kHz) (example shown 2500Hz)

then press the  key



Using the Scroll keys select step speed in milliseconds. (steps available 100ms, 250ms, 500ms, 1000ms (example shown 250ms)

then press the  key

Start receiver scanning

To start receiver scanning, enter the tuning receiver mode, then:-

press the  key

The receiver will now be scanning using the last entered parameters.

The receiver will now be scanning using the entered parameters.

The transceiver will halt scanning for the following reasons:-

Signal Strength Level (SSL) mute is selected and a signal with a level greater than the pre-set threshold is received.

Audio (syllabic) mute is selected and a voice signal is detected

Menu Functions

Menus

The menu is divided into two sections, the “Standard Menu” and the “Protected Menu”. Both sections are used to set or display transceiver parameters. The “Standard Menu” is available directly to operators as no critical operation parameters can be changed in this section.

The “Protected Menu” has some critical parameters and needs the operator to press the menu key for two seconds to enter it.

Note:- Menu items in both menus can be barred from use, if operationally required, by using Barrett 2050 PC based programming software.

Navigating the Menus

All sections of the Menu are operated using the similar key press sequences. In this section when describing the functions available in the Menu system it is assumed the operator is familiar with the following:-

press the  key to enter the “Standard Menu” section

press the  key **for more than 2 seconds** to enter the “Protected Menu” section

use the **Scroll keys** to select the menu item you require.

then press  key

Once in the menu item, again use the **Scroll keys** to select a parameter or enter a value using the numeric or alpha key.

When you have the parameter or value required press the

 key

Note:- Due to network operation requirements access to items in the Standard Menu or Protected Menu may be barred by network administrators during programming.

Standard Menu

Identification



Use the **1** and **def 3** keys to scroll back and forth through the identification pages:-

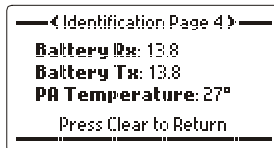
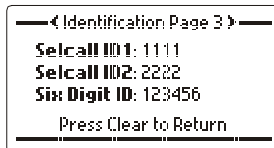
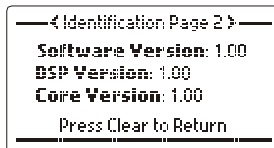
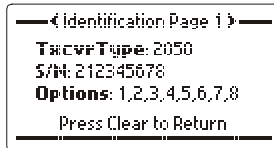

— < Identification Page 5 > —

GPS Coordinates

Lat: 32°05.727S

Long: 115°48.044E

Press Clear to Return

Displays the transceiver model number, transceiver serial number, options fitted, software version, DSP version, core version, the transceiver's Selcall ID's, the battery voltage in receive, the battery voltage during the last transmit cycle and the PA temperature. Transceiver GPS coordinates are also shown if a GPS is fitted and has acquired satellites.

Display Options

Backlight level



Allows the backlight level on the LCD display to be adjusted to one of three viewing levels:-High, Medium or Low.

Use the **Scroll keys** to select the level required (example Medium):-

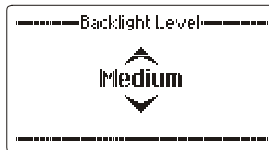

when the level required is displayed press the



key

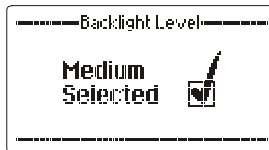

Backlight timeout

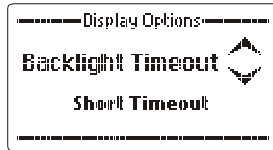
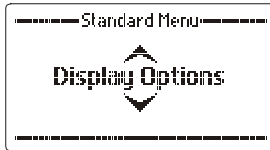

Allows the backlight timeout time to be set so the backlight stays on for a short time from the last key press, for a long time from the last key press or so that the backlight is permanently on or off.

Note:- Having the backlight off reduces the transceiver's power consumption.

Use the **Scroll keys** to select the required setting (example "Always on"):-



When the setting required is displayed press the  key



Call History

Whenever a Selcall, Telcall, All call, Group call, Sub group call, Pagecall, Statcall GPS or Emergency call is received or transmitted its details are held in a first in first out call history buffer.

Received calls that have not been viewed before are held in a section called "New Calls", received calls that have been viewed are held for future viewing in the "Inbox" all transmitted calls are stored in the "Outbox". Each history buffer can store up to 30 entries.

New Call

This section lists all types of Selcalls that have been received but not yet viewed:-



Inbox

This section lists all types of Selcalls that have been received and viewed and stored for future reference:-

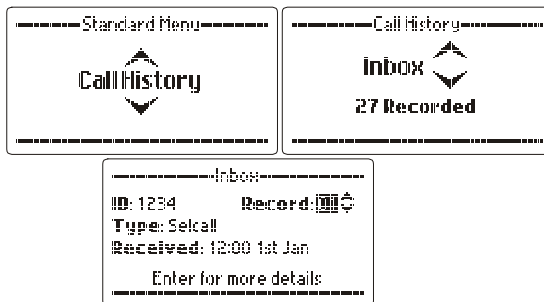

Outbox

This section lists all types of Selcalls that have been transmitted:-

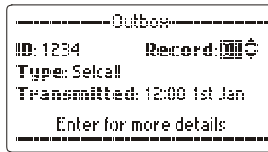
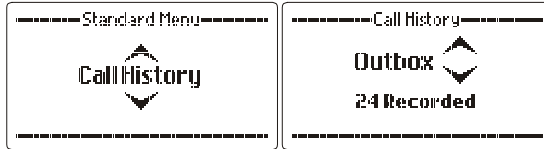

Navigation when in the “New calls”, “Inbox” and “Outbox” is always the same as shown in the “New Calls” example below:-

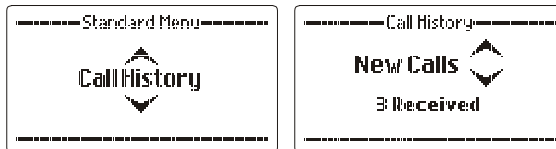

Either

Use the **Scroll keys** to select the required record:-

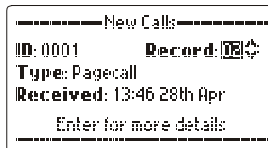
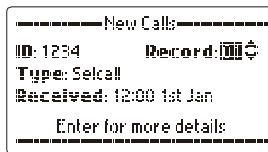

Or

enter a record number using the numeric keys and press



```

-----New Calls-----
ID: 1234      Record: 20
Type: Selcall
Received: 12:00 1st Jan
      Enter for more details
-----
    
```

```

-----New Calls-----
ID: 0001      Record: 004
Type: Pagecall
Received: 13:46 28th Apr
      Enter for more details
-----
    
```



In all cases, when a record has been selected, press the  key for more details of the call:-

```

-----Inbox-----
Name: DUBAI BASE
Channel: 0002
Frequency: 2000.0 kHz
-----
    
```

If the received Selcall ID is not listed in the transceiver Selcall ID book, associating it with a name, the following will be displayed:-

```

-----Inbox-----
Name: Unknown
Channel: 0002
Frequency: 2000.0 kHz
-----
    
```

If the channel the incoming Selcall was received on has been deleted since the Selcall was received the following is displayed:-

```

-----Inbox-----
Name: DUBAI BASE
Channel: 0002
Frequency: Unknown
-----
    
```

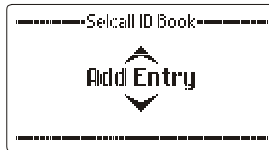

Address Books

Selcall ID Book – add a new entry

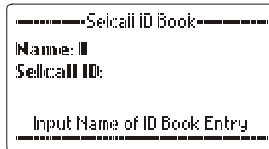

then press the  key



press  key if Uppercase required

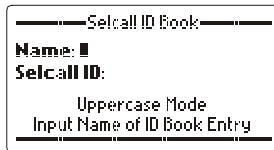

enter name to be associated with Selcall ID

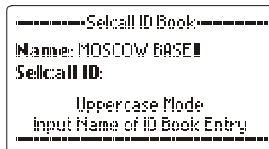

then press  key:-

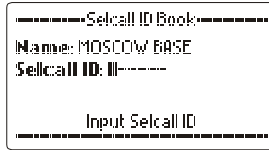

enter Selcall ID number, four or six digits

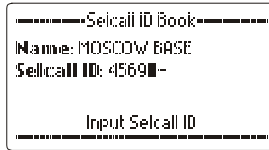

then press the  key

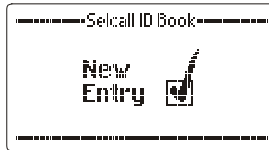

Selcall ID Book – edit an entry

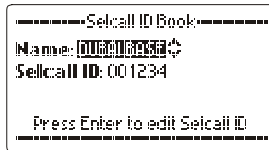
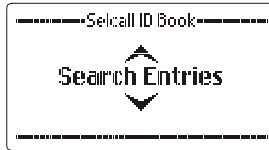

Use the **Scroll keys** to select entry and press



key to edit

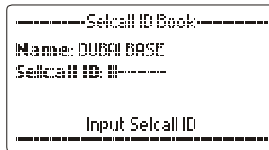

input new Selcall ID four or six digits

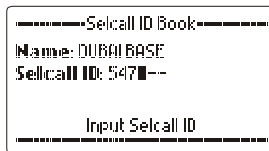

then press the



key

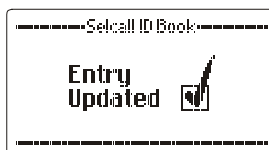

Selcall ID Book – erase an entry

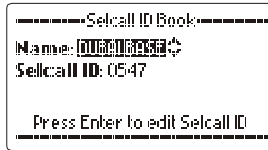
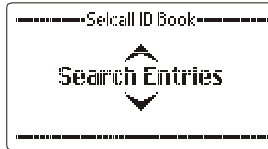

use the **Scroll keys** to select the entry you want to erase.

press the  key **for more than two seconds**

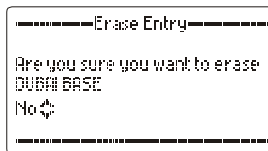

use the **Scroll keys** select "Yes"

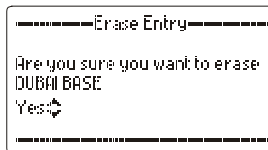

press the  key

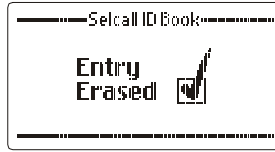

Phone book - add a new entry

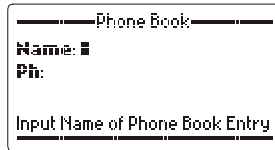
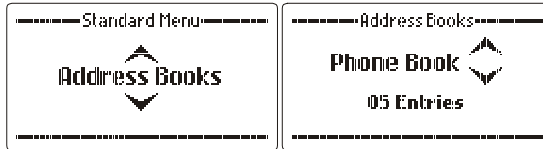

press the  key if uppercase required

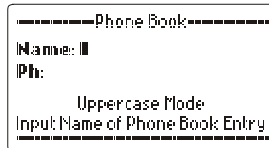

enter the name to be associated with telephone number

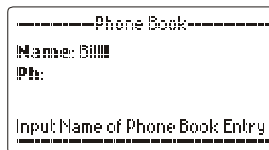

then press the  key

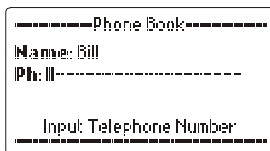

enter the telephone number using the numeric keys (up to 16 digits)

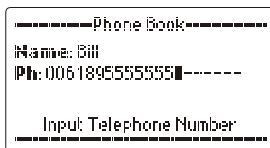

then press the  key



Phone book - edit an entry

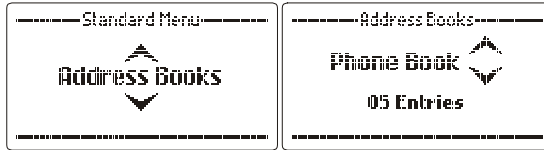

Either

use the **Scroll keys** to scroll through the phone book to find the entry you want to edit





Or

enter the first letter of the name you are looking for using the Alpha keys, for example, looking for the name Patrick:-

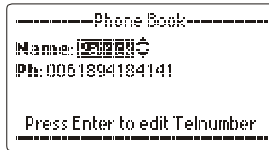
Key in 'p' using alpha keys, then use the **Scroll keys** to find the name:-



then press the  key

now to edit the telephone number press the  key

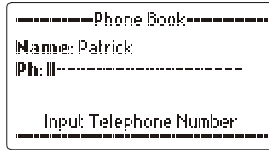

enter the new telephone number using the numeric keys (up to 16 digits):-

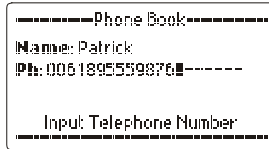

then press the key

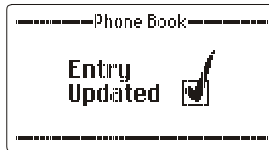

Phone book - erasing an entry

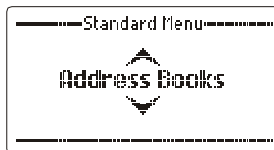



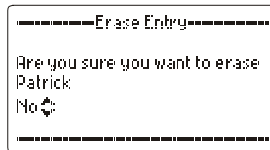

select the entry you want to erase using the **Scroll keys**.

press the  key for more than two seconds

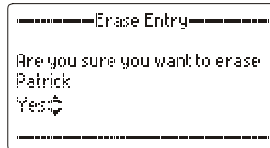

use the **Scroll keys** select "Yes"



then press the  key

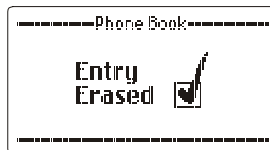

IR Enable

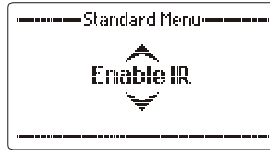

Press the  key to enable the IR facility:-

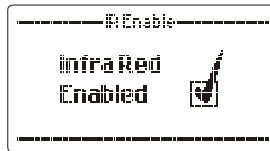

The IR facility will remain enabled ready to link to an IR equipped PC or laptop that is loaded with the Barrett 2000 series programming system for a period of 5 minutes. After this time, unless an IR link has been established, the IR is again disabled. See the "Programming section" of this manual for more details.

Audio Scrambler

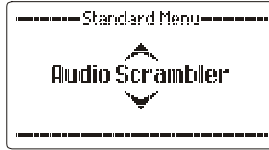

When using the internally fitted audio scrambler accessory PCB that provides backwards compatibility to the 900 series audio inversion scrambler (BCA20031) or the Transcript scrambler (BCA20054), the scramble code is set using this option. All stations using the scramblers require the same scrambler code to be entered:-

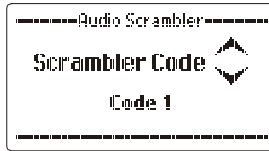

The code can be selected between 1 and 16 for the Transcript scrambler (BCA20054) or 1 and 32 for the audio inversion scrambler (BCA20031):-

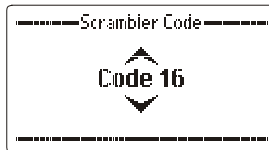

press the  key

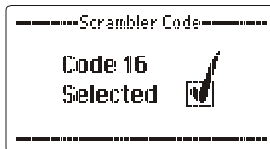

Note:- If using the internally fitted rolling code audio scrambler accessory PCB (BCA20054) the code is set on the unit before installation using an external programmer.

To enable scrambled mode

Press the  key for more than two seconds, the “Scrambler Enabled” screen will be shown.



While the transceiver is in scrambled mode the “Scrambler On” message will be displayed.

**To disable scrambled mode**

Press the  key for more than two seconds, the “Scrambler Disabled” screen will be shown.



2040 Antenna Select (available when 2050 deployed in 2040 manpack adaptor)



This section allows the selection of the antenna type to be used with the 2040 manpack. When an un-tuned antenna such as the whip or a long-wire is to be used "Whip/Long-wire" is selected. This enables the automatic antenna tuner. If a 50 Ohm broadband antenna or a tuned dipole is to be used select "50 Ohm". The automatic tuner is disabled and the BNC socket on the 2040 is used.

Use the **Scroll keys** to select the setting required (example "Whip L/Wire" :-



press the  key

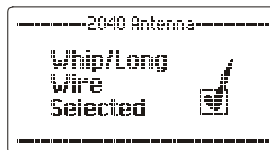

Protected Menu

Refer page 57 for details on how to access the protected menu.

General

Microphone Up/Down keys



The keys on the top of the microphone can be assigned for two different functions, either as channel up/down keys or as volume control keys or they can be disabled:-

Use the **Scroll keys** to select the setting required (example "Mic keys disabled"):-



press the  key

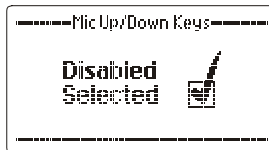

Transmit “over beep”

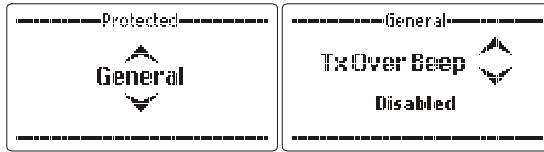

When selected the 2050 transceiver transmits a short tone when the PTT is released. It provides an audible indication to the operator at the remote station that the local station has stopped transmitting.

Use the **Scroll keys** to select the setting required (example “Tx Over Beep enabled”):-

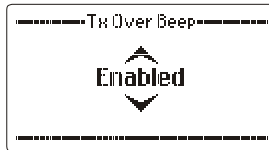

press the  key



Transmit timeout

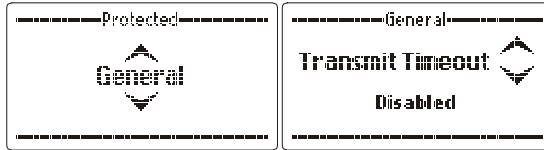

When this feature is enabled the 2050 transceiver will disable the transmitter if the PTT (push to talk button on the microphone) is held on for more than the time limit set below i.e. if the microphone is inadvertently jammed under a seat. Releasing the PTT will reset the transmitter. Settings available are "Disabled", 1 minute, 2 minutes, 3 minutes:-

Use the **Scroll keys** to select the setting required (example 2 minutes):-



When the setting required is selected press the **ENTER** key

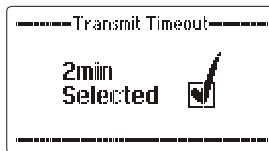

Channel labels

This section enables the adding, editing or erasing of channel use labels, these labels are used during channel programming to indicate what particular channels are used for i.e. UNHCR Geneva:-

Edit labels

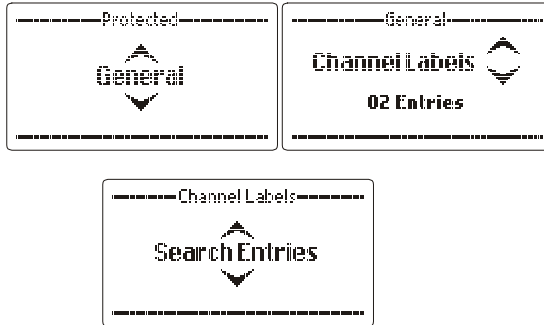

Either use the **scroll keys** to scroll through to the label you want to edit:-

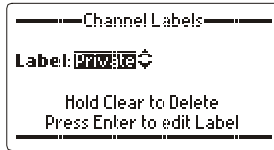

Or search for label you want to edit by entering the first letter of the label and using the **scroll keys** to select it:-

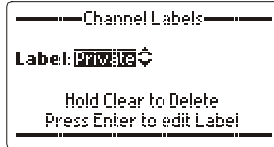

to edit the label press the  key



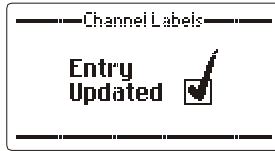

edit the entry when editing is complete press the  key

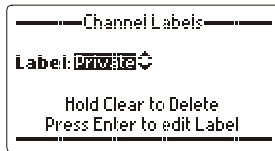

Delete a label

Enter edit mode as shown above and select the label you want to delete:-



press the  key until the display below appears:-

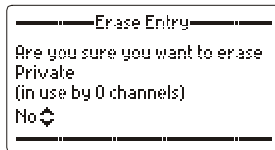

Use the **scroll keys** to select "Yes" you want to delete the entry:-

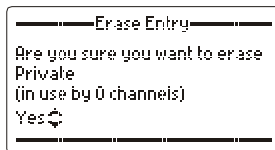

then press the  key.

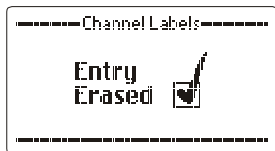

Add an entry

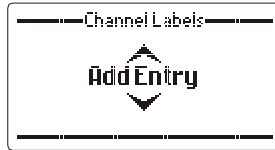
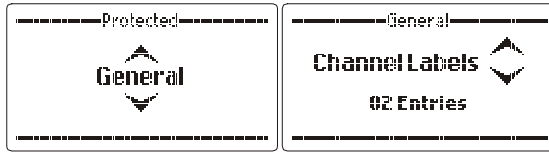

press the  key

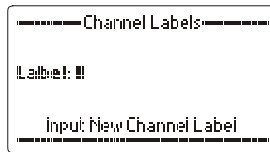

type in a new label using the Alpha keys:-

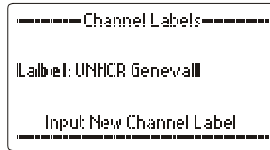

then press the  key.

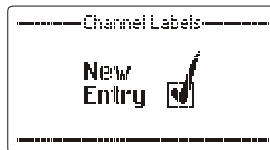

Setting the clock

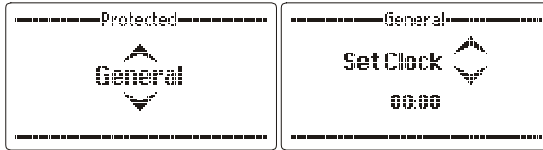

press the  key

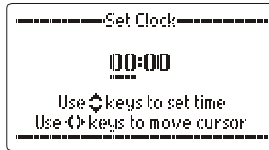

Use the Scroll keys and as shown on the screen to set the current time for example 13:15 (1:15 PM):-

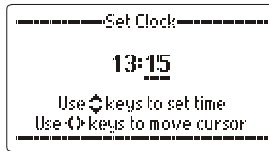

When time is set press the  key.

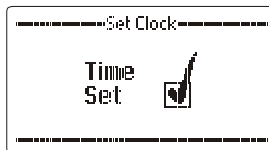

Setting the date

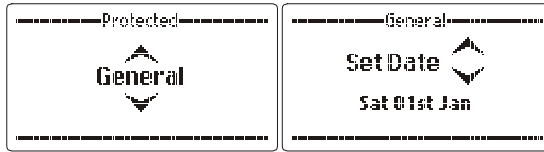

press the  key

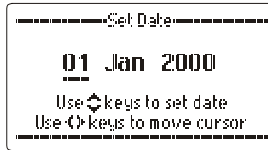

Use the Scroll keys and as shown on the screen to set the current date for example 04 June 2004:-

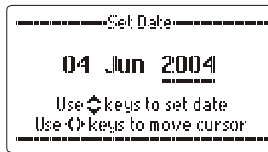

When date is entered press the  key

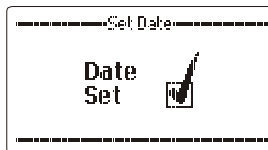

B.I.T.E. test

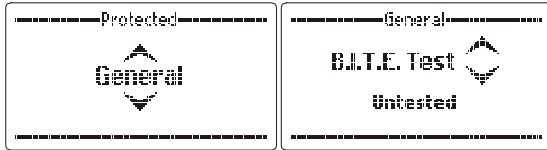

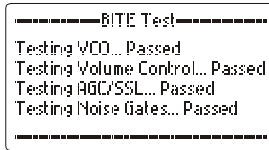

This section runs the transceiver's Built in Test Equipment (B.I.T.E.) tests. The transceiver checks vital transceiver functions and reports the results as shown below:-

press the  key

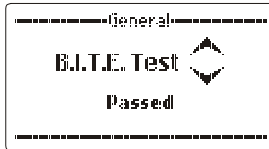

then press the  key to continue:-



press the  key to repeat the test or press the  key to finish.

Note:- The Audio and Signal strength mutes must not be selected when running the B.I.T.E. test or it may fail.

Option installation



Options are installed in the Barrett 2050 transceiver by entering a PIN number supplied by the manufacturer. This PIN number is related to the electronic serial number of the transceiver. A different PIN number is provided depending on the option or combination of options required to be fitted. Most options are fitted in the factory before dispatch.

press the  key



Enter the option PIN number supplied by the manufacturer using the numeric keypad by the manufacturer then press the

 key

For example if the PIN number supplied is for all eight options, after entering the PIN number the following is displayed:-



If an incorrect PIN number is entered the following is displayed:-

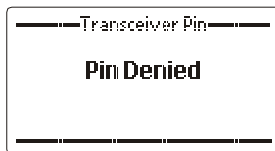

Hopping PIN number entry

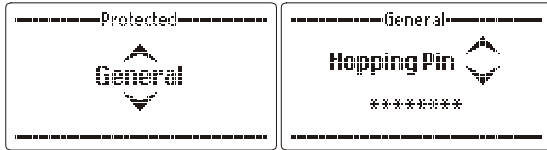

Using the numeric keypad enter an 8 digit hopping security code.



then press the  key



Note:- Refer to the "Frequency Hopping" section of this manual for details of PIN entry and Frequency Hopping in general

Secure call code

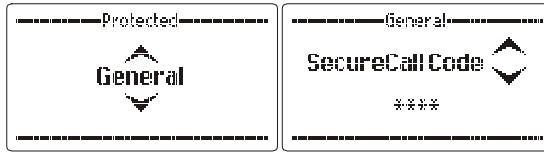

When using the person to person voice scrambler both stations require the same scrambler code to be entered:-



Using the numeric keypad enter a four digit number:-

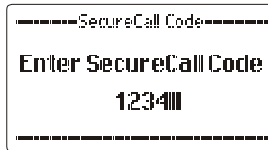

then press the  key

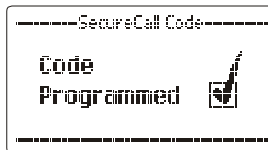

Security Level



This option allows the user to set the level of security used during secure voice communications. It changes the number of hops per second used by the encrypting algorithm. There are 2 choices:

High – 25 hops / second in Frequency Hopping mode
15 hops / second in Secure Call mode

Standard – 5 hops / second in Frequency Hopping mode
4 hops / second in Secure Call mode

Use the **Scroll keys** to select the required Security level:-



then press the  key



Upload pack

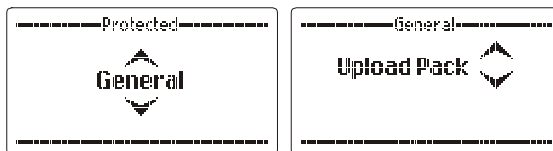

See section "Cloning (programming) from another transceiver"

Internal Modem



This menu option allows the user to enable or disable the internal HF data modem functionality of the transceiver.

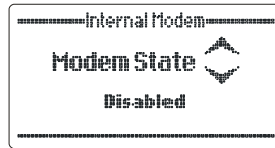

press the  key



use the scroll keys to select the required setting then press the  key

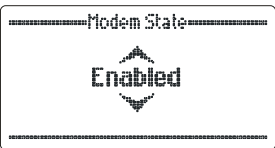

press the  key

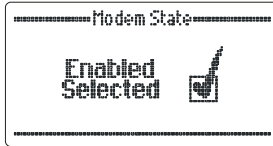

Note:- Once the “Internal Modem” option is enabled, transceivers cannot be controlled or programmed via RS232 communications. The “Internal Modem” must be disabled to allow re-programming or control of the transceiver through RS232 communications.

Scan Tables

Adding channels to a scan table

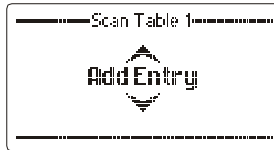
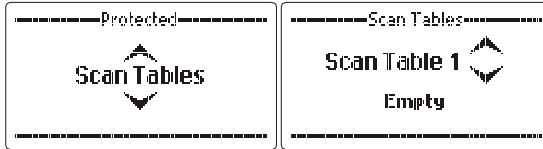

Use the **Scroll keys** to select the channel you wish to add:-



When the channel required is displayed press the



key

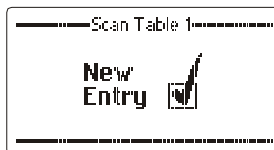

Editing channels in a scan table

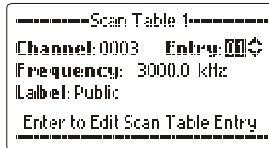
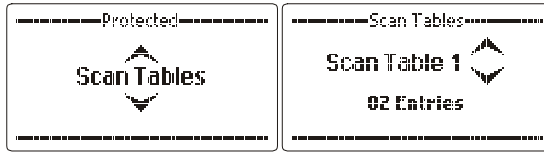

Either Use the **Scroll keys** to select the channel you wish to edit:-

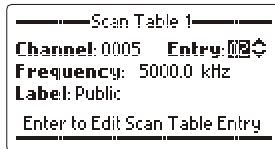

Or Select the channel you wish to edit by entering the channel number (example channel 1):-

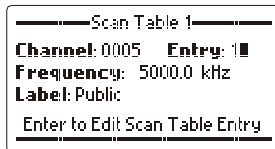

then press the  key

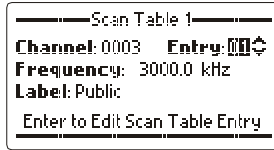

Then press the **ENTER** key to edit the channel number
 Use the **Scroll keys** to select the new channel for the scan table slot:-



press the **ENTER** key to enter the new setting:-

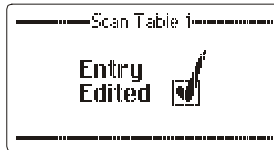

Erasing entries in a scan table

Select the scan table and channel slot you want to remove using the steps above:-

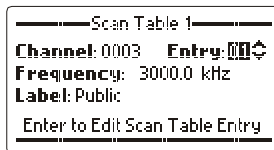

when the entry you wish to erase is selected press the **Clear** key until the following is displayed:-



Use the **Scroll keys** to select "Yes" when you are sure you want to erase the entry:-

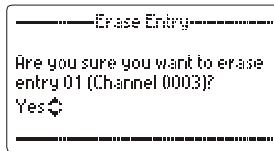

then press the  key

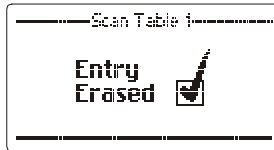

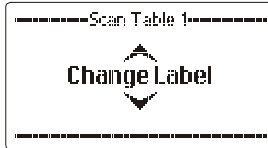

Note:- All channels are displayed in numerical order within the scan table with respect to the entry number, there are a maximum of 30 entries in each table.

Changing scan table labels

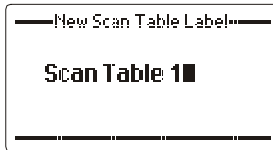

press the  key



Use the  key to clear the old label:-



using the alpha/numeric keypad enter the new label:-

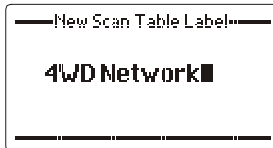

then press the  key

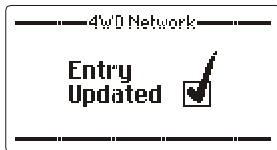

Scan Settings

Scan rate

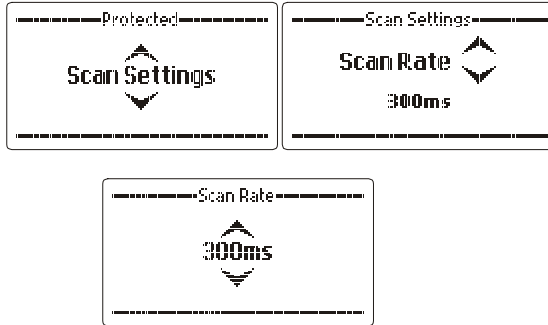

Selects the scan rate applicable to non-Selcall scan channels, selectable between 300mS and 5 seconds per channel.

Use the **Scroll keys** to select the scan resume time required (example 700mS):-

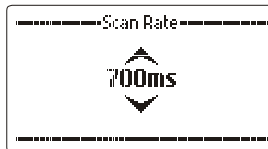

When the setting required is selected press the  key

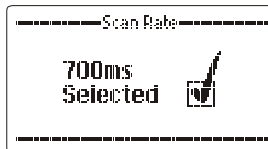

Scan dwell

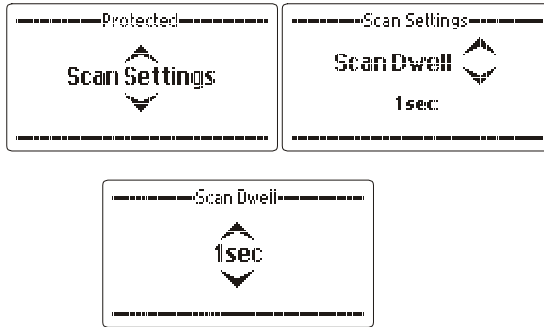

Selects the length of time the transceiver dwells(waits) on a channel after scan has been stopped by signal strength level (if signal strength level mute is set) or voice activity (if audio mute is set). The dwell time can be set from 1 to 10 seconds.

Use the **Scroll keys** to select the scan dwell time required (example 5 seconds):-

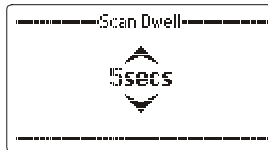

When the setting required is selected press the



key



Scan resume time

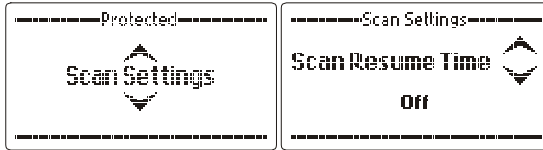

This section sets the time period after which the Barrett 2050 transceiver will automatically resume scanning from the last operation i.e. key press or PTT. The scan resume time period can be set between 1 and 30 minutes or it can be disabled.

Use the **Scroll keys** to select the scan resume time required (example 5 minutes):-



When the setting required is selected press the  key

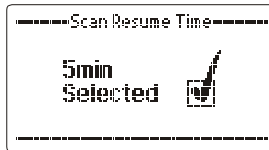

Scan table select

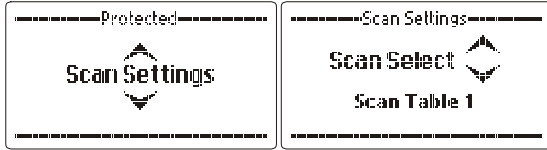

This section selects the Scan table to be used when the transceiver is put in scan, or if enabled, when scan resume occurs. There are 8 scan tables.

Note:- When scrolling through the scan tables, before selection, only those with channels entered will be displayed.

Note:- Channels can be added, removed and edited and scan tables named in the “Scan table” section.

Use the **Scroll keys** to select the scan table required (example scan table 1):-



When the scan table required is displayed press the  key



If none of the Scan tables have any channel entries the following is displayed:-

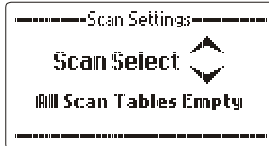

Note:- Direct entry into this section is available by pressing the  key for **more than two seconds**.

Mute Settings

Syllabic mute sensitivity

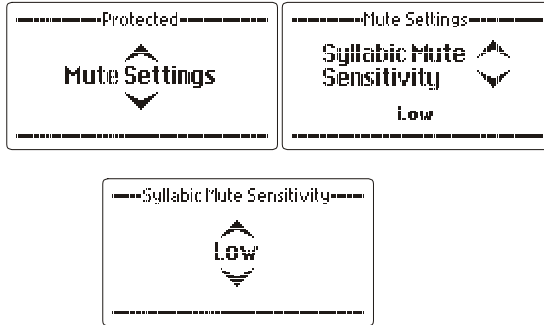

The sensitivity or “hardness of the syllabic mute (squelch) is set by this section. The mute can be set between low, medium and high sensitivity to voice activity on a channel.

Use the **Scroll keys** to select the setting required (example High):-



When the setting required is selected press the  key



Signal strength mute level

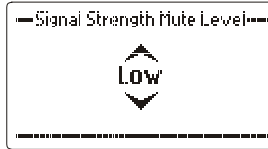

This section selects the level at which the Signal Strength Level (SSL) mute (squelch) opens. Levels available are low, medium and high. When set to low the mute will open on a relatively low level of received signal, when set to high the mute will open on a relatively high level of received signal.

Use the **Scroll keys** to select the setting required (example High):-



When the setting required is selected press the **ENTER** key



Selcall Settings

Three different selective call ID's can be set within the Barrett 2050 transceiver as follows:-

Selcall ID 1 – setting 4 digit Selcall self ID

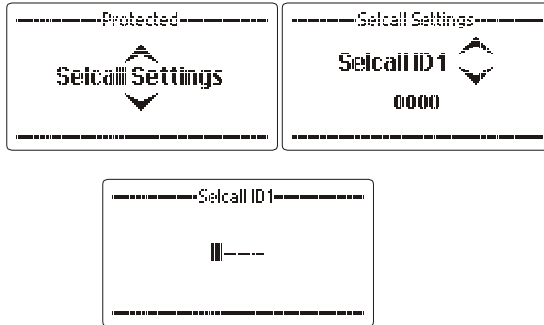

Selcall ID1 - a 4 digit ID that the transceiver will respond to on channels with **International** or **CCIR** (WA2 in Australia) format programmed.

Selcall ID 2 – setting 4 digit Selcall self ID

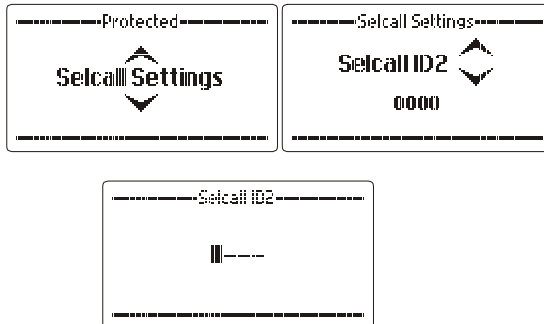

Selcall ID2 – a 4 digit ID that the transceiver will respond to on channels programmed for use with **OEM 1** (Codan compatible) Selcall format programmed.

Setting six digit ID – setting 6 digit Selcall self ID

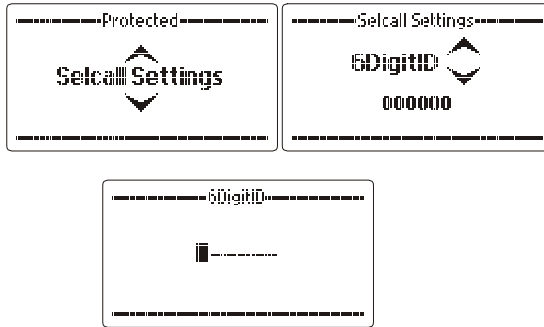

Six digit ID – a 6 digit ID that the transceiver responds to on channels programmed for the **International** or the **OEM 1** format.

Note:- We recommend that the self ID should not be set to X000, XX00 or XXX0 as these are reserved Selcall numbers for all call, group-call or sub-group-call use.

Setting Selcall MMSI – GMDSS Selcall self ID (for future use)

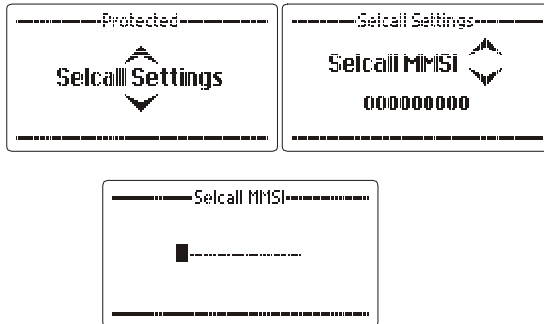

Selcall alarm

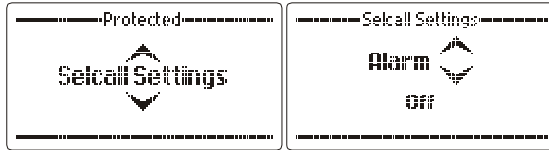

The Selcall received audio annunciation can be turned on or off using this function; this is useful when the transceiver is used in covert operations. Reception of the Selcall continues to be displayed visually on the display.

Use the **Scroll keys** to select the setting required (example shows selection of alarm "On");-

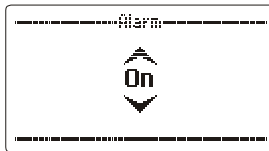

press the  key

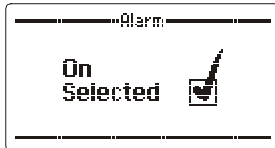

Selcall transmit tones audio level

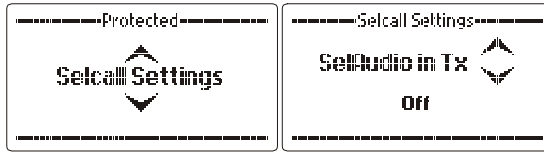

To confirm transmission of a Selcall the Selcall tones are normally output on the transceiver loudspeaker. In certain situations this is not required or the tone volume requires adjusted. This section allows the Selcall audio to be disabled or set to two volume settings, Low or High.

Use the **Scroll keys** to select the setting required (example Selcall volume "Low" :-

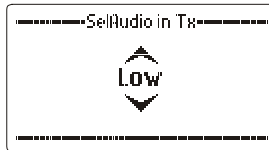

When the setting required is selected press the **ENTER** key

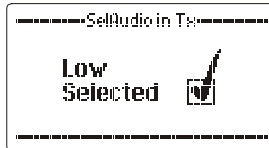

Selcall pre-amble length setting

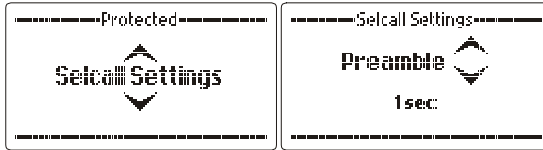

The Selcall pre-amble length can be set between 1 and 10 seconds depending on how many channels are used in the scan table being used. Allow 500mS for each Selcall channel to be scanned plus one second, E.g. to scan 8 Selcall channels:-
 $500\text{mS} \times 8 + 1 \text{ sec.} = 5 \text{ seconds.}$

Use the **Scroll keys** to select the Selcall pre-amble length required (example "5 seconds"):-

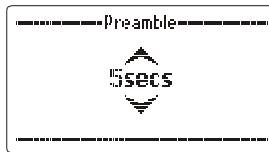

When the setting required is selected press the



key

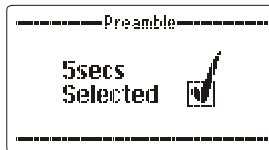

TXCVR lock

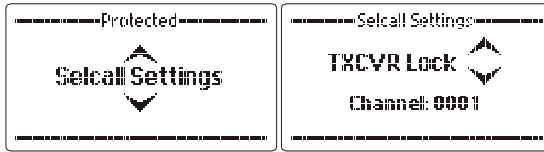

This section enables the network operator to send a special key (programmed into a transceiver during programming) by Selcall to disable that transceiver. The transceiver remains locked until an unlock code is entered.

This function can be used if the transceiver has been stolen and it is being used illegally.

The lock call will be made on the channel selected before entering this function. The channel number is shown on the TXCVR display.

Before proceeding if the channel presently selected is not a Selcall channel the following is displayed



Select a channel that you expect the transceiver you want to lock is on and that has Selcall programmed

press the  key



enter the Selcall number of the transceiver you wish to disable (see entering Selcall numbers in the Selcall section)

press the  key

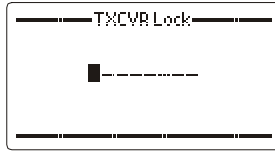

enter the 8 digit numeric lock code (this was loaded into the transceiver when initially programmed for the network)

press the  key

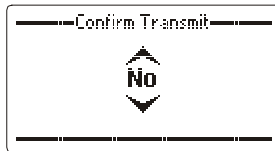

If you are **absolutely sure** you want to lock the transceiver with Selcall ID entered use the Scroll keys to select "Yes"

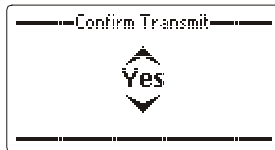

press the  key

The transceiver will now send the lock call. A revertive call from the transceiver being locked will confirm the action.

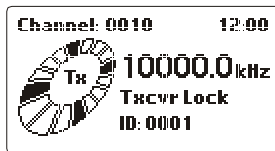

A transceiver that has been locked by this process can only be unlocked by using the Barrett programming software. See the programming software for details.

OEM pagecall key

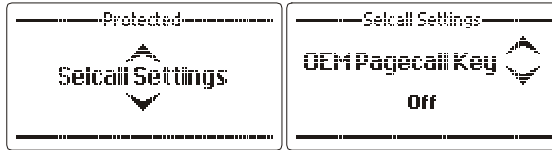

When using OEM 1 Selcall protocol, Pagecalls can either be sent plain text or encrypted by using either the privacy key programmed by the programming software or if no privacy key is programmed the default value of 9999999. Selecting "On" and Pagecall is encrypted, selecting "Off" Pagecall is sent in plain text.

Use the **Scroll keys** to select the setting required (example shows selection OEM Pagecall key "On"):-

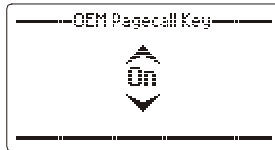

press the  key

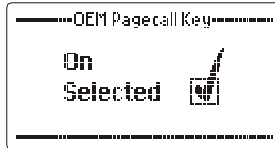

Audio Settings

Audio bandwidth



This section allows the audio bandwidth to be tailored to an operator's comfort requirements. Settings available are full bandwidth - 300Hz – 1.5kHz, 300Hz – 2.0kHz, 300Hz – 2.5kHz , 300Hz – 3.0kHz.

Use the **Scroll keys** to select the audio bandwidth required (example “300Hz to 2.5kHz”):-



When the audio bandwidth required is displayed press the



key



“Beep” volume level

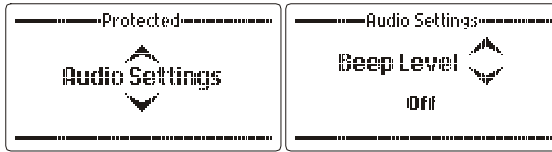

This section is used to set or disable the annunciation beep volume levels. These are the various tones associated with key presses. In covert operations these can be disabled, in other operations these are set for operator comfort. Settings are “Off”, “Low” or “High” (example shown “beep” tones High):-

Use the **Scroll keys** to select the “beep” volume level required (example shown “beep” tones level “High”):-



When the “beep” level required is displayed press the **ENTER** key



Receiver audio path configuration

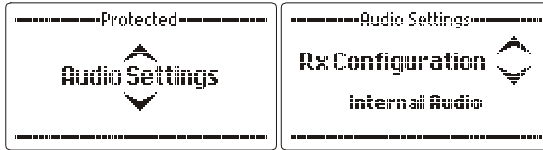

The section sets where the unprocessed receiver audio in the transceiver is sourced. Normally this is set to internal; in this case the transceiver's receiver provides the unprocessed audio.

When used with a remote receiver, in split site operations, it can be set to external, in this case unprocessed receive audio from the remote site can be input into the auxiliary sockets 600 ohm balanced audio port.

Use the **Scroll keys** to select setting required (example shows "External audio"):-



press the  key



Transmitter audio path configuration

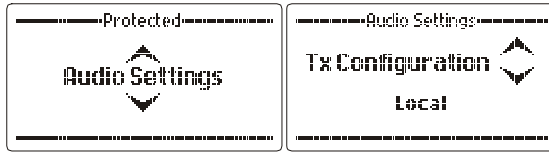

The section sets where the transmitter audio in the transceiver is sourced. Normally this is set to internal; in this case the transceiver's microphone provides the transmitter audio.

When used with a remote site operation, it can be set to "remote", in this case the transmit audio is input into the auxiliary sockets 600 ohm balanced audio port.

Use the **Scroll keys** to select setting required (example shows "Remote"):-

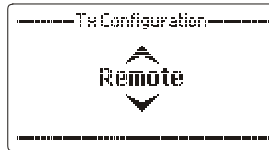

press the  key

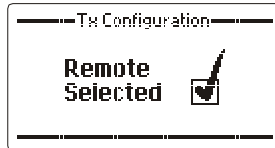

Line audio

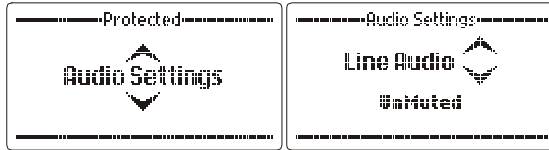

This section sets the muting condition of the 600 ohms balanced audio line output on the rear auxiliary connector. The line output can be set to “Un-Muted” or “Follows Mute”. When set to “Follows Mute” the line output is muted in the same manner as the speaker output and follows the mute condition currently in use. The line output is usually set to “Un-Muted” when using data modems.

Use the **Scroll keys** to select the noise reduction “depth” required (example “Follows Mute”):-



press the  key

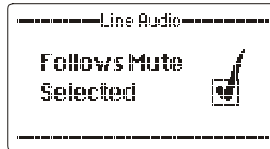

Noise reduction

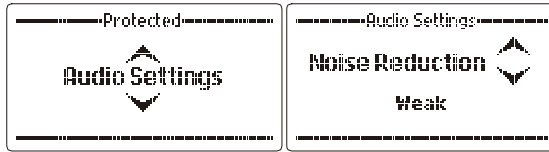

This section allows the DSP noise reduction “depth” to be adjusted to suit the operator’s comfort requirements. Settings available are Weak, Medium and Strong. It should be noted that as the “depth” is increased the processed human voice gets a more metallic quality.

press the  key

Use the **Scroll keys** to select the noise reduction “depth” required (example “Medium”):-

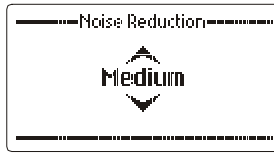

When the noise reduction required is displayed press the

 key

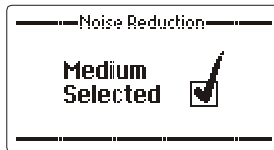

RF Settings

Optional IF filter enable

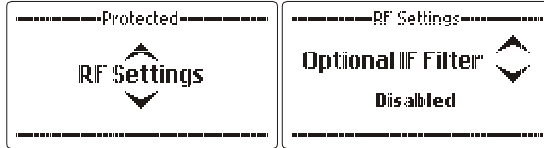

When enabled the optional IF filter (if physically fitted) is selected automatically when AFSK or CW mode is selected. This is useful when the transceiver is used in some data transmission applications.

Use the **Scroll keys** to select the setting required (example shown "Enabled"):-

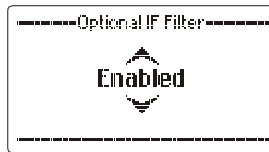

press the  key

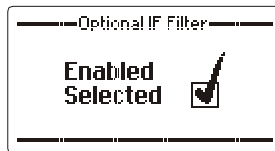

Note:- This setting is only available if the narrow filter setting is selected during programming from the programming software.

Receiver pre-amplifier

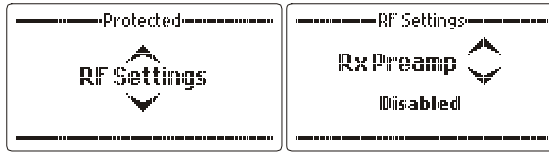

Enables or disables RF preamplifier, this preamplifier provides an additional receiver gain of 5dB. Generally the RF pre-amplifier is switched off when an automatic mobile antenna is in use as these antennas have an inbuilt RF pre-amp.

Use the **Scroll keys** to select the setting required (example shown "Enabled"):-

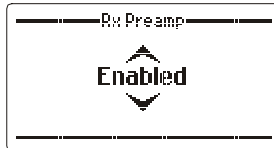

press the  key

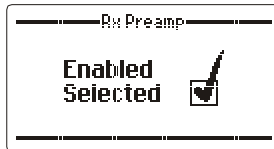

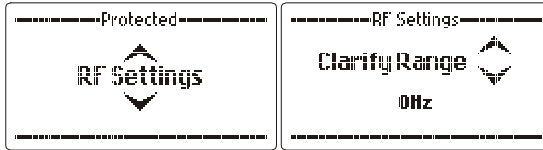

Clarifier range

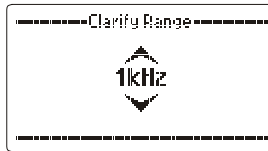

This menu item allows the user to set the clarifier range or disable the clarifier, the range can be set to +/-50Hz, +/-150Hz or +/-1kHz.

Use the **Scroll keys** to select the clarifier range required (example shown +/-1kHz):-



When the clarifier limit required is displayed press the  key

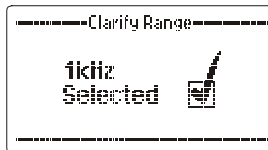

Noise blanker threshold



This menu item allows the predictive noise blanker to be switched on or off and allows the selection of three threshold levels. The noise blanker is useful to reduce the interference caused within vehicles with petrol engines.

Note:- The noise blanker will not be effective in situations where external power line noise etc is blanketing the receiver.

Use the **Scroll keys** to select the setting required (example shown "Threshold Low"):-



press the  key

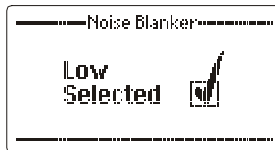

Note:- In certain situations noise blankers can cause Intermodulation in receivers, in these cases the noise blanker should be disabled.

RF power level

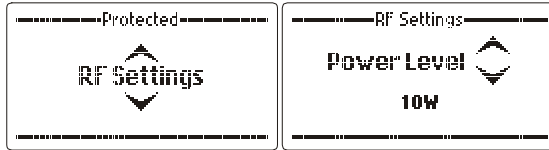

This section sets RF power output of the transceiver globally. RF power can be set to 10W, 30W, or 125W.

Use the **Scroll keys** to select the RF power level required (example shown 125W):-

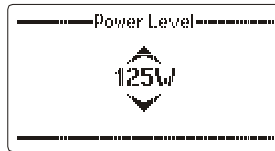

When the RF output power required is displayed press the



key

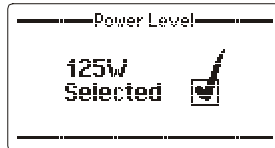

Note:- When the 2050 is deployed in the 2040 manpack adaptor the power is automatically reduced to 10W and 30W. These power settings corresponding to the channels programmed power setting - Low Power (LP) representing 10W and Medium Power (MP) and High Power (HP) representing 30W.

AGC Hang

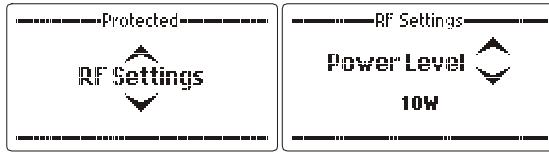

This section allows the AGC configuration of the receiver to be set to either “Hang ACG” or “Hang Off”. The selection depends on the receiver environment and should be set for optimum receiver performance. In the presence of high static and sporadic noise, the function of the hang AGC may result in gaps in the received signal due to the slow AGC recovery.

Use the **Scroll keys** to select the AGC Hang (example shown Hang Off):-

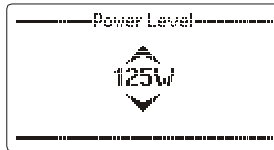

When the AGC Hang required is displayed press the **ENTER** key

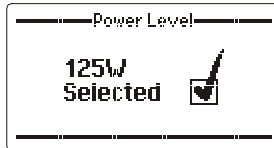

I/O Settings

RS-232 out

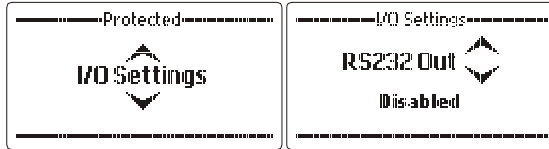

This section enables or disables RS-232 Selcall information output from the transceiver via the 25 pin auxiliary connector.

Use the **Scroll keys** to select the setting required (example shown "Enabled"):-



When the setting required is displayed press the  key

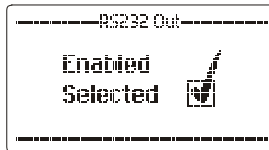

Note:- This command does not allow RS-232 control of the transceiver as enabled when the RS-232 option is fitted. It is used to control the output of Selcall information used by some external programs such as vehicle tracking.

External alarm



This section sets the action of the external alarm output, on pin 17 of the 25 pin D auxiliary connector, activated when a Selcall is received by the transceiver. It can be set to either a pulse output (for use with a horn) where the output is activated 15 seconds on, 15 seconds off; or a constant output (for use with a rotating beacon). Both are reset by pressing the clear key or action of the PTT button.

Use the **Scroll keys** to select the setting required (example shown "Pulsed"):-



press the  key

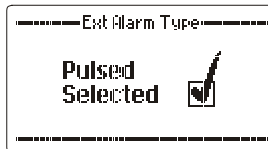

Antenna type

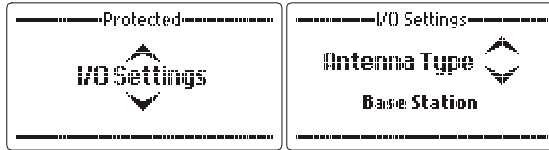

This section sets antenna type or if a linear amplifier is to be used with the 2050 transceiver.

Selections available:-

“Base Station”

Select when base station antennas such as the Barrett 2012 series are used. No tuning signals are emitted on channel change. This selection should also be used when operating with a Barrett 2014 manual tapped whip.

“910 Mobile antenna”

Select when using a Barrett 910 automatic tuning mobile antenna.

“911 Automatic Tuner”

Select when using a Barrett 911 automatic tuner.

“Linear amplifier”

Select when using the 2050 with a Barrett 975 series linear amplifier.

“2019 Mobile antenna”

Select when using a Barrett 2019 automatic tuning antenna.

Use the **Scroll keys** to select the type of antenna or a linear amplifier (example shown “2019 Mobile antenna):-



When the setting required is displayed press the



key

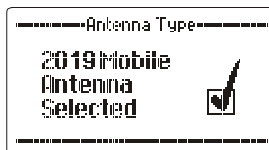

GPS receiver enable

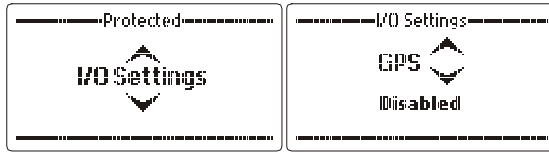

This section enables or disables the external GPS receiver input (example “disabled”):-

Use the **Scroll keys** to select the setting required (example shown –“Enabled”):-

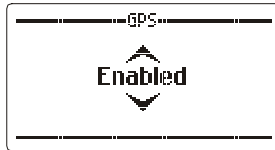

press the  key

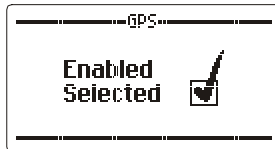

Note:- An external GPS receiver is required for GPS functions. If this option is enabled and a GPS is not connected to the 2050 a **warning message will appear on the display “GPS Unavailable”**

Line output level adjust

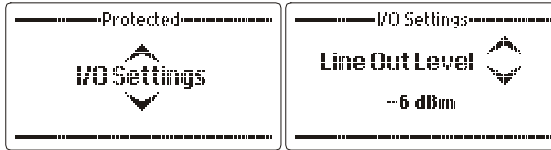

This section adjusts the output level of the auxiliary 600Ohm balanced audio output port. The level can be set to -6dBm,-3dBm, -0dBm, +3dBm, +6dbm and +9dBm.

Use the **Scroll keys** to select the level required (example shown - 3dBm):-

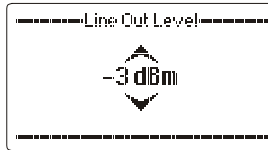

When the level required is displayed press the  key

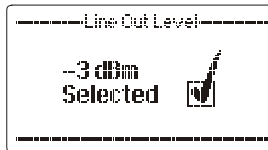

Line input level adjust

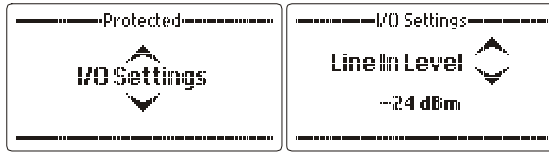

This section adjusts the input level sensitivity of the auxiliary 600Ohm balanced audio input. Sensitivity can be adjusted to -24dBm,-18dBm, -12dBm, -6dBm and 0dBm.

Use the **Scroll keys** to select the level required (example shown - 12dBm):-

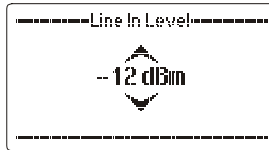

When the level required is displayed press the



key

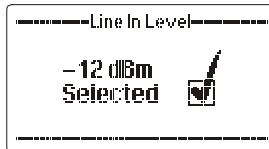

Frequency Hopping (Option - Export Permit Required)

The Barrett 2050 employs a unique frequency hopping system that uses an external ESU...Encryption Synchronisation Unit.

Note:- The external ESU must be connected and providing valid data for the frequency hopping system to operate

Selecting the hop band

Select the channel used for normal/clear transmissions based on the normal procedures used when using an HF system, this channel frequency and mode is used by the Barrett 2050 to determine the hop band. .

Note:- The reference frequency is NOT a centre frequency for the hop band. It simply determines which of the preset hop bands are selected.

Entering the security code

For hopping PIN code entry refer to the "General" section of the Protected Menu, in the subsection "Hopping PIN", select the security PIN code based on the information below.

Security codes and bandwidths

Security codes 00000000 to 19999999 are used for hopping +/- 2KHz
Security codes 20000000 to 49999999 are used for hopping +/- 16KHz
Security codes 50000000 to 99999999 are used for hopping +/- 128KHz

Note:- Hopping up to +/- 2 KHz is useful for narrow band antennas such as when using antenna tuners in manpack operation.

Note:- Hopping a +/- 128KHz can be used with wideband antennas such as base station broadband antennas.

Note:- Once entered the security code for security reasons can never be retrieved or viewed.

To enable hopping mode

Press the  key for more than two seconds



As soon as this display is shown you can start communicating with other stations using the same channel frequency and having the same hopping code entered.

To disable hopping mode

Press the  key for more than two seconds

Note:- The external ESU must be connected and providing valid data for the frequency hopping system to operate.

Security code management

Changing the hop code

It is advisable to change the 8-digit hop code (for the entire hop network) on a regular basis.

The frequency of code change with a network is entirely dependant on the situation that exists at the time.

Code distribution

Code distribution will be the same as for any other direct entry crypto devices - i.e. this is a logistics issue for the person/organisation administering the hop network.

Network planning and contingencies

As the Barrett 2000 series frequency hopping system has a GPS based synchronisation system that requires no master station allocation, operating the system requires the minimum of communications strategies.

The network users have only to be briefed on the channel and security codes to use the system.

Automatic Link Establishment (ALE) (Option)

ALE system overview

The Barrett Automatic Link Establishment (ALE) controller option simplifies the operation of HF networks, the ALE option automating many of the procedures necessary to establish and maintain an HF link.

The Barrett 2050 ALE controller option provides complete inter-operability as required by FED-STD-1045 and U.S. MIL-STD-188-141B standards.

HF network stations equipped with ALE controllers automatically scan a pre-selected set of channels, listening for ALE calls. If sounding is selected stations at periodic intervals send out "sounding calls" to other stations. These signals are analysed for link quality and stored in the "sounded" stations. All stations gradually build up a table of parameters which determines best channels to use to link between specific stations. These tables are used by the ALE controller to determine the best channel to connect on when commanded by its operator to communicate with another station.

The Barrett 2050 ALE controller's powerful memory stores up to 10,000 sets of LQA information, 100 channel configurations, 20 self-address configurations and 100 other address configurations.

Operation overview

The ALE network parameters are determined by a network supervisor, this person programs all the transceivers in the network with the required addressing and channel information using the ALE fill program. This is a PC based program used to transfer pre-determined network information into each transceiver. A separate manual is provided as a guide to ALE network setup and for the operation of ALE fill program. As ALE's prime purpose is to automate many of the procedures necessary to establish and maintain an HF link, it is only necessary for the operator to enter the station he wishes to call and activate ALE call sequence as described in the following section.

Within the protected menu ALE section various operational parameters can be changed as required by the operator. The section titled "ALE menus" describes these functions.

To commence scanning

Note:- You should have selected the required scan list before you commence scanning, refer to the section “ALE scan list select” in the ALE protected menu.

Press the  key

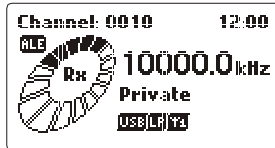

the 2050 transceiver will now be ALE scanning and ready to accept ALE calls, receive “Soundings” and transmit “Soundings” (If “Sounding” is enabled on your transceiver)

During ALE scanning the following messages may be displayed:-



This occurs when your station receives an ALE sounding from another station in the network.



This is displayed when your station transmits a “sounding”

Note:- Your station would have to have “Sounding” enabled.

Linking to another station in an ALE network

press the  key

select "ALE Call" with the scroll keys



then press the  key



select the station ID of the station you wish to call (the "To" ID) (see the section below "**Selecting ALE Station ID's**")



then press the  key



select the station ID you are calling from (your self ID can be varied, (the "From" ID)) (see the section below "**Selecting ALE station ID's**")



then press the  key

the ALE call sequence will now commence:-



linking in progress:-



the link is established, an audible alarm will sound after which you can start communication with the station you called:-

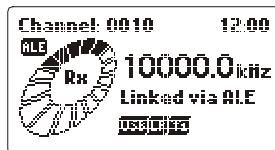

Or if you already had two links established:-



The following error messages may be displayed:-

For various reasons the link attempt failed i.e. no response from the called station or the link was rejected by the called station:-



You attempted to make a call but for various reasons the system cannot make the call i.e. incorrect self address, no presets available, no valid LQA's available:-



Making a Netcall

A maximum of 20 networks, programmed with the ALE fill software can be called using the Netcall facility. Each network can consist of up to 15 ALE stations.

press the  key

select "ALE Call" with the scroll keys



then press the  key



select the network you wish to call (the "To" ID)
(see the section below **"Selecting ALE Station ID's"**)



then press the  key



select the station ID you are calling from (your self ID can be varied, (the "From" ID)) (see the section below **"Selecting ALE station ID's"**)



then press the  key

the ALE call sequence will now commence:-



linking in progress:-



the link is established, an audible alarm will sound after which you can start communication with the station you called:-



Or if you already had two links established:-

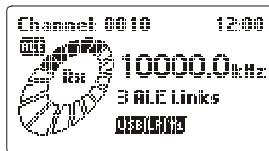

The following error messages may be displayed:-

For various reasons the link attempt failed i.e. no response from the called station or the link was rejected by the called station:-

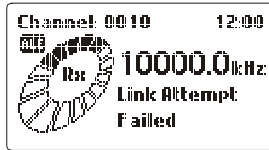

You attempted to make a call but for various reasons the system cannot make the call i.e. incorrect self address, no presets available, no valid LQA's available:-



Sending an ALE text message to another station in an ALE network

press the  key

select "ALE Message" with the scroll keys;-



then press the  key



select the station ID of the station you wish to call (the "To" ID)
(see the section below "**Selecting ALE Station ID's**")



then press the  key



select the station ID you are calling from (your self ID can be varied, (the "From" ID)) (see the section below "**Selecting ALE station ID's**")



then press the  key

use the **Scroll** keys to select **either**:-



Or



If you selected "**New Message**":-



then press the  key



Enter the message using the alpha/numeric keypad



If you selected "**Preset Message**":-



press the  key



Use the **Scroll** keys to view the rest of the message:-

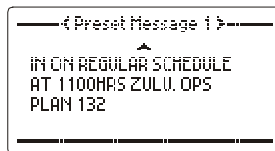

Or use the  or  keys to select other preset messages:-

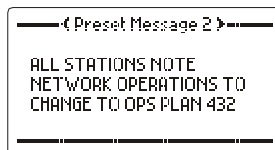

When the **"Preset Message"** is selected or the **"New Message"** is

entered, press the  key

the ALE call sequence will now commence:-



linking in progress:-



the link is established, an audible alarm will sound after which you can start communication with the station you called:-



or if you already had two links established:-



The following error messages may be displayed:-

For various reasons the link attempt failed i.e. no response from the called station or the link was rejected by the called station:-



You attempted to make a call but for various reasons the system cannot make the call i.e. incorrect self address, no presets available, no valid LQA's available:-



Making a telephone call via ALE stations with telephone interconnect facilities

press the  key

select "ALE Phone" with the scroll keys



then press the  key



select the station ID of the station you wish to call (the "To" ID)
(see the section below "**Selecting ALE Station ID's**")



then press the  key



select the station ID you are calling from (your self ID can be varied, (the "From" ID)) (see the section below "**Selecting ALE station ID's**")



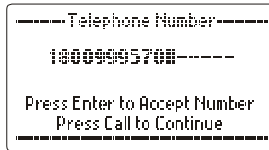

then press the  key

Either enter the telephone number using the numeric keypad (a number up to 16 digits)

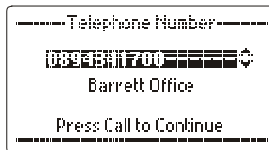

Or if you think that telephone number is in the phone book use the **Scroll keys** to find the name and number you want to call:-



Or if you know the name associated with the telephone number in the phone book press the  key and either enter the first letter of the name you want to call using the alpha keypad and use the **Scroll keys** or use the **Scroll keys** to find the name you want to call:-



Or press the  key and the phone number previously called will be called again.

the ALE call sequence will now commence:-



linking in progress:-



the link is established, an audible alarm will sound after which you can start communication with the station you called:-



Or

if you already had two links established:-



The following error messages may be displayed:-

For various reasons the link attempt failed i.e. no response from the called station or the link was rejected by the called station:-



You attempted to make a call but for various reasons the system cannot make the call i.e. incorrect self address, no presets available, no valid LQA's available:-



Selecting ALE station ID's

Unlike Selcall ID's which you can enter yourself into the transceivers Address books, ALE network station ID's are pre-programmed into your transceiver. This is usually performed by your network administrator prior to deployment using the Barrett ALE fill program via the RS-232 port on the Auxiliary socket or via the IR link from a PC or Laptop

Note:- the same method is used to select the "To" and "From" ID, the "To" ID is shown below:-

Either enter the station ID using the numeric keys (the number of the station you wish to call, see "Station ID ranges")

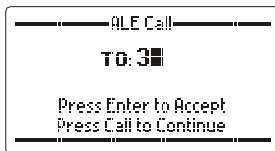

Or all the stations are in the address book, use the **scroll keys** to find the station you want to call, then

press the  key



Or if you know the name of the station press the  key and either enter the first letter of the name you want to call using the alpha keypad then use the **Scroll keys** or use the **Scroll keys** to find the name of the station you want to call (example "b" entered):-

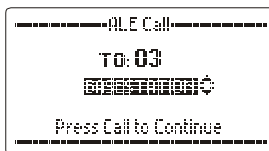

Receiving an ALE call

Various types of ALE call can be received as described below. When an ALE call to your station commences the following is displayed on your transceiver:-

A station in the ALE net is attempting to establish a link to your station:-



Your station is now linked, an audible alarm sounds:-



This is a normal call and conversation can now commence.

Or



An address has matched an incoming **Wildcard** address. **Wildcard** addresses have special characters (question marks) in them that do not require an exact match with the local address to link E.g. "FIELD?" will link with any station that has a self address starting with FIELD and ending in a single additional character (for example, FIELD1 or FIELDA). A station that linked using a Wildcard call may not be the only station in the link.

Stations respond to a **Wildcard** call in random slots.

Or



An address has matched an incoming **Anycall**. An **Anycall** is a special call type that may link with any station(s) listening.

Stations respond to **Anycalls** in random slots.

Or



An address has matched an incoming **Allcall**. An **Allcall** is a special call type that may link with any station listening.

Stations do not respond to **Allcalls**. Since the station which initiated the call does not receive any link acknowledgements it cannot determine which station(s) have accepted the link.

With all the above calls an alarm will sound for 60secs. After pressing a key, the following pages appear. If the 60sec alarm times out the system blips periodically (~5sec intervals).

Shows the address called i.e. one of your addresses:-



Pressing the or scrolls between the two pages of call data. The following page shows the address of the station that called you:-

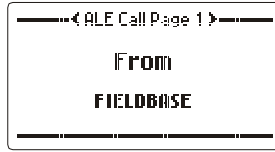

Pressing the  key displays the link status:-



Or if more than one link is in progress (example 3 links):-



Receiving an ALE message

When an ALE link to your station commences the following is displayed on your transceiver:-

A station in the ALE net is attempting to establish a link to your station:-

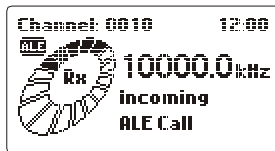

Your station is now linked and has received an ALE message, an audible alarm sounds:-



If after 60 seconds no key has been pressed the alarm will stop and regular 'blips' will be heard, indicating a call was received in your absence. Pressing any key will display the message received:-





Pressing the  key shows the address that the station called i.e. one of your addresses:-



Pressing the  again shows the address of the station that called you:-

```
-----< ALE Message Page 1 >-----  
FROM  
FIELDBASE  
-----
```

Pressing the  returns you to the previous screen etc.

Pressing the  key or using PTT will return you to the main screen.

Receiving an ALE telephone call

If the RS-232 output is disabled (see I/O section of the Protected Menu) ALE telephone call requests are displayed on the transceiver front panel as follows:-

When an ALE link to your station commences the following is displayed on your transceiver:-

A station in the ALE net is attempting to establish a link to your station:-



Your station is now linked and has received an ALE phone number, an audible alarm sounds:-



If after 60 seconds no key has been pressed the alarm will stop and regular 'blips' will be heard indicating a call was received in your absence. Pressing any key will display the received message:-





Pressing the  key shows the address that the station called i.e. one of your addresses:-



Pressing the  again shows the address of the station that called you:-

```
-----of ALE Phone Page 1 >-----  
FROM  
FIELDBASE  
-----
```

Pressing the  returns you to the previous screen etc.

Pressing the  key or using PTT will return you to the main screen.

Note:- Normally when using this ALE telephone number function the receiving transceiver is connected to a automatic telephone interconnect unit such as the Barrett 960 or Barrett 2060, in this case the RS-232 output is enabled the receipt of an ALE telephone call request is not displayed as above and the telephone interconnect takes control of the transceiver.

Receiving an ALE Netcall

When an ALE link to your station commences the following is displayed on your transceiver:-

A station in the ALE net is attempting to establish a link to your station:-



Your station is now linked, an audible alarm sounds:-



Your address has matched an incoming Netcall, a call to a number of stations in one call. Each station must respond to confirm the Netcall is established with the calling station. Each station responds in pre-determined slots.

If after 60 seconds if no key has been pressed the alarm will stop and regular 'blips' will be heard indicating a call was received in your absence. Pressing any key will display the call data:-



Pressing the  again shows the address of the station that called you:-



Pressing  returns you to the previous screen etc.

Pressing the  key or using PTT will return you to the main screen.

Closing individual ALE links

You must be linked to close an ALE link:-



Or if more than one ALE link is in progress (example 3 links):-



hold the  key until the screen showing status of the current links appears:-

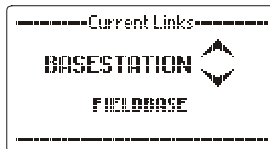

use the **Scroll keys** to select link you wish to close (example shown - a link with a station not in your ID book):-

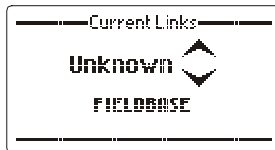

then press the  key



At this point you can either send a message, in which case go to the section "Sending an ALE text message to another station in an ALE network" or you can terminate the link:-

To terminate the link use the Scroll keys to select "Terminate Link":-

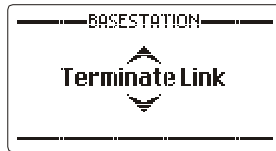

press the  key



The link is now terminated and unless you are linked to more than this station then your station will return to ALE scanning or manual mode:-



Closing an all ALE links

You must be linked to close an ALE link:-

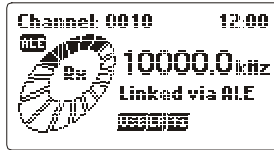

Or if more than one ALE link is in progress (example 3 links):-



press the  key

select "Terminate All Links" with the scroll keys



then press the  key

The ALE system now terminates all open links.

Remote station closes the ALE link

If the station you are linked to closes the link the following will be displayed:-



Your station will then return to ALE scanning (assuming your station was in ALE scan mode before the ALE link occurred):-

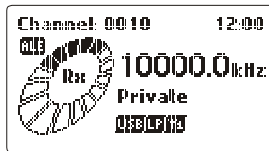

Combined ALE / Selective Call Capability

Overview

The combined ALE / Selective Call capability allows the user to receive and transmit ALE and Selcall type calls on channels which are programmed for ALE scan but also have Selcall enabled on them. This means that during ALE channel scanning the transceiver can accept incoming Selcall. **However, this feature can only be used if the ALE scan rate is set to 2 channels per second** (set in the "2000 Series Programming Software")

To commence scanning

Note:- You should have selected the required scan list before you commence scanning, refer to the section "ALE scan list select" in the ALE protected menu.

Press the  key



the 2050 transceiver will now be ALE scanning and ready to accept ALE calls, receive "Soundings" and transmit "Soundings" (If "Sounding" is enabled on your transceiver)

The 2050 transceiver will also be able to decode incoming Selcall as long as 2 channels per second is set as the ALE scan rate and Selcall is enabled on the scan channels. Selcall decoding is handled just like it is when the transceiver is in standard non-ALE scan mode.

During ALE scanning the following messages may be displayed:-



This occurs when your station receives an ALE sounding from another station in the network.

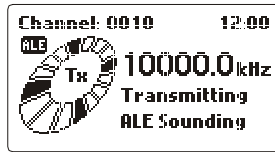

This is displayed when your station transmits a “sounding”
Note:- Your station would have to have “Sounding” enabled.

Transmitting an ALE call

Please refer to the “Linking to Another Station in an ALE Network” section.

Receiving an ALE call

Please refer to the “Receiving an ALE link request” section.

Receiving and transmitting a Selective call (Selcall)

Please refer to the “Contacting another station – using selective call “Selcall” and “Telcall”” section.

ALE Configuration Menus

ALE enable

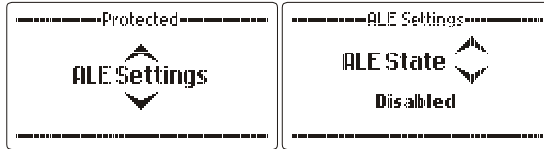

This feature enables or disables the ALE system

Use the **Scroll keys** to select the setting required (example "ALE Enabled"):-

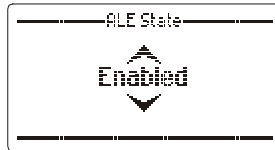

When the setting required is selected press the



key

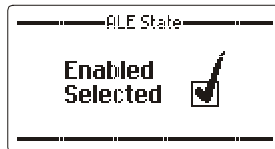

ALE scan list select

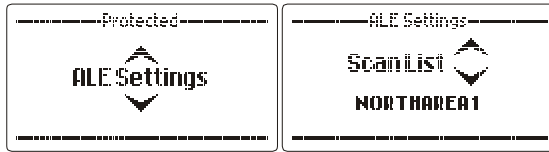

Note:- you can also enter this scan list select section by holding down the  key for more than two seconds

To select the ALE scan list required

press the  key



Use the **Scroll keys** or press the first letter of the scan list you want to use (example shown – “s”) to select the scan table required:-

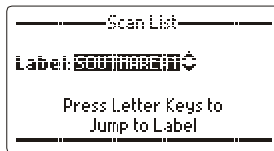

then press the  key

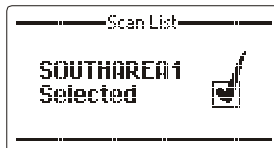

Auto transmit



When Auto Transmit is set to "Disable" the ALE system will not respond to any calls made to this station.

Use the **Scroll keys** to select the setting required (example "Enable"):-

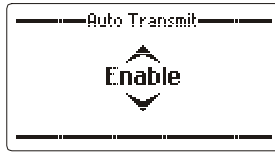

When the setting required is selected press the **ENTER** key

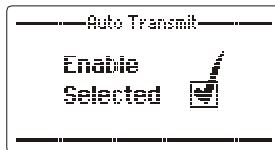

Transmit control



When Transmit Control is set to “Disabled” the ALE system will not be able to transmit any ALE calls, including automatic soundings and responses to incoming ALE calls.

Use the **Scroll keys** to select the setting required (example “Enabled”):-

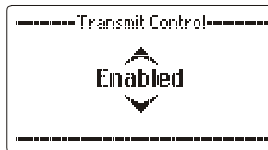

When the setting required is selected press the



key

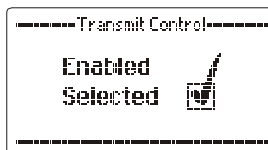

Sounding control

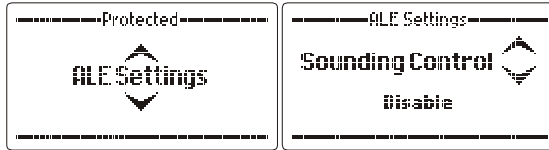

ALE operates normally both transmitting and receiving sounds when Sounding Control is set to "Enable". In some circumstances however it is desirable not to transmit soundings under any circumstances, in this case Sounding Control is set to "Disable". Sounding is limited to certain channels (pre-programmed by the ALE fill program). The ALE system will however, continue to make and respond to calls (depending on the Response Control settings).

Use the **Scroll keys** to select the setting required (example "Enable"):-

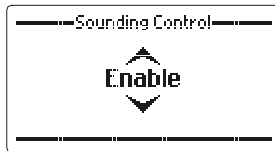

When the setting required is selected press the **ENTER** key



Sounding address



Configures the self address used during an automatic sounding (Sounding Control must be set to Global On). If sounding control = individual preset basis, the address used is dependant on the active channel.



Use the **Scroll keys** to select the setting required (example "FIELDBASE2"):-



When the setting required is selected press the **ENTER** key

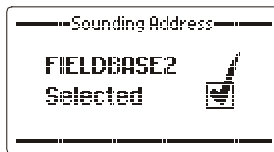

Link quality analysis (LQA) exchange



This option enables or disables the exchange of LQA information with other stations

Use the **Scroll keys** to select the setting required (example "Enabled"):-



When the setting required is selected press the  key

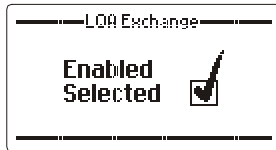

Link quality analysis (LQA) exchange mode



This option sets the source of the LQA reading sent to the other station, it can be set to "Current LQA" which is a reading taken during the ALE burst just received or it can be set to "Averaged LQA" which uses the long term averaged value taken from memory.

Use the **Scroll keys** to select the decay time or disable (example "Averaged LQA"):-

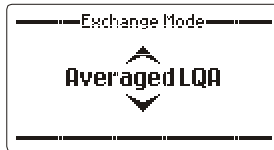

When the setting required is selected press the



key

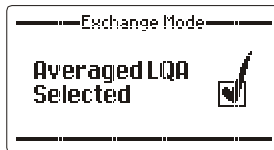

LQA averaging

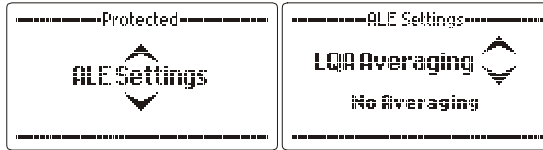

This option sets the method used to update an existing link quality value stored in ALE processor memory when the new link quality value is worse than the stored value.

The option can be set to either replace the old values with the new values or replace the old values with different weighted averages of the old values and new readings.

Averaging reduces the effect that one bad reading might otherwise have on a perfect channel. If a new reading is better than an old value, the old value is replaced by the reading. There are 4 different averaging formulas available:-

- No averaging, replace the old values with new values
- $(old+new)/2$
- $((3*old)+new)/4$
- $((7*old)+new)/8$

Use the **Scroll keys** to select the LQA averaging value required (example “ $((7*old)+new)/8$ ”:-



When the setting required is selected press the **ENTER** key

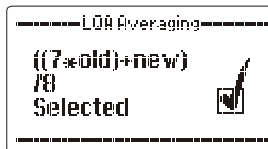

Link quality analysis (LQA) decay rate

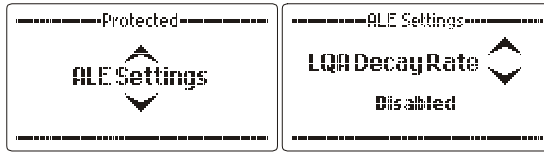

This option sets the artificial decay rate for the link quality information that is stored in the link quality table within the ALE processor.

Switching the sounding off and setting a decay rate of two hours would result in the recording of a perfect channel (100% channel quality) decaying to an unusable channel (0% channel quality) over a period of two hours.

The decay rate can be disabled, set to 1,2,4,8,24 and 48 hours.

Use the **Scroll keys** to select the decay time or disable (example "8 hours"):-

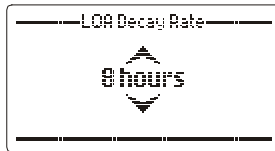

When the setting required is selected press the **ENTER** key



Threshold test

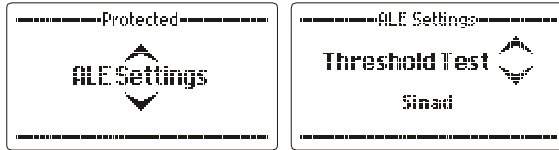

Used to select which type of threshold test is used to determine what quality ALE channel is acceptable for communication. Either “Sinad”, “BER”, “Both” or “None” can be selected.

Use the **Scroll keys** to select the test required (example “BER”):-

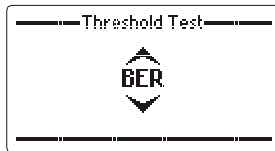

press the  key

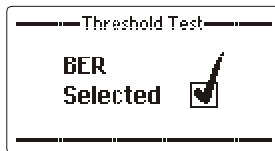

SINAD threshold

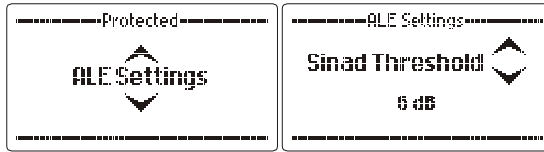

This option sets the SINAD threshold at which an ALE channel is considered usable.

This can be set to between 0 and 30dB.

press the  key

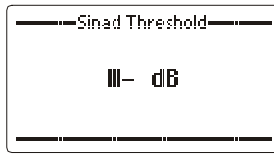

using the numeric keys enter the SINAD threshold required (example "12dB"):-



then press the  key



BER threshold



This option selects the BER threshold at which an ALE channel is considered usable. If the required BER is not reached in the reply from the remote station the link establishment process is rejected. Depending on the retry setting the link establishment would continue on another link.

It can be set between 0-30, selecting 30 effectively means that all links are allowed

press the  key



using the numeric keys enter the BER threshold required (example "7"):-



then press the  key



ALE fill mode

The ALE is configured with its entire network data using the Barrett PC based ALE fill program. Refer to the Barrett 2050 PC based programming software that contains the ALE fill program for details.

Programming Functions

The Barrett 2050 transceiver can be programmed in three ways:-

Using the 2050 programming software, loaded on a PC, and transferring information to the 2050 by either IR through the front panel or by RS-232 through the auxiliary connector.

By direct key entry through the front panel

Note:- This facility may not be available if the network administrator has barred the function during programming using a PC.

By cloning information from another transceiver, through the auxiliary connector using a cloning cable Barrett P/N BCA90024 (2050) or P/N BCA204020 (2050 in manpack adaptor)

Programming using the Barrett 2050 programming software

The Barrett 2050 programming software should be loaded onto PC using the instructions supplied with the package.

Transceiver configuration packs are uploaded and downloaded to the 2050 transceiver either via IR or via the serial port on the auxiliary socket on the 2050 transceiver.

Programming using the Barrett cable P/N BCA90023/BCA204020

To program the transceiver using the RS-232 port of your PC or Laptop plug one of the cables mentioned above (depending on whether you are programming a 2050 or a 2050 in the manpack adaptor) into the PC or laptops serial port. The other end should be plugged it the accessory socket of the transceiver or manpack adaptor. Your PC or laptop should have the Barrett 2000 series programming software running and the 2050 should be switched on. Programming functions can now commence.

Note:- When programming it is suggested you use a Barrett supplied programming cable. Other common serial cables have other pins connected. In some cases when connected to the programming computer these pins can have varying effects. The most common is that the 2050 transceiver remains in power on mode, even though the control head looks inactive the main unit remains powered up. This is due to the remote power up pin on auxiliary connector being held active.

Programming using the IrDA link

To program the transceiver using the IR link your PC or notebook should be fitted with an IrDA standard IR facility and have the Barrett 2000 series programming software running. Bring your PC or laptop's IR device in visual range of the IR window on the front panel of the 2050 transceiver then go to the "Standard Menu – IR Enable section" and enable the IR facility. The PC or Laptop should now connect to the 2050 transceiver and programming functions can commence. **Note:-** the IR facility will only remain active for 5 minutes after being enabled if no connection is made with a PC or laptop.

Programming a channel from the front panel

Note:- To program a channel from the front panel it is necessary to have this function enabled.

To enter the programming mode first select the channel you want to program then press the  key:-

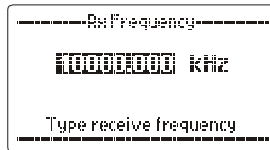
Transmit and receive frequencies

Use the numeric keypad to enter the receive frequency

then press the  or  key

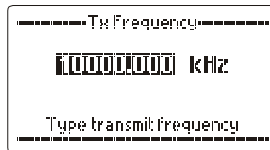

Use the numeric keypad to enter the transmit frequency

then press the  or  key

Channel use labels

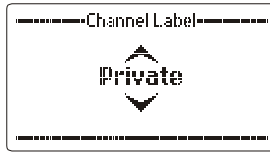

Use the Scroll keys to select the required channel label

Note:- channel labels can be entered in the “General” section of the protected menu.

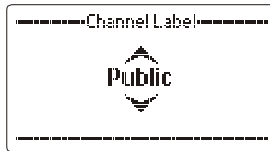

then press the  or  key

Operating mode

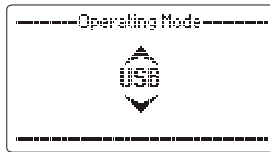

Use the Scroll keys to select the required operating mode, USB, LSB, AM, CW or AFSK

then press the  or  key

Note:- If the 500Hz or narrow filter hardware option is enabled this filter is automatically selected in CW mode and AFSK mode

Transmitter power setting

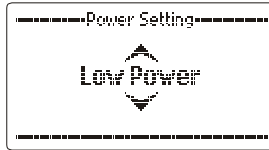

Use the Scroll keys to select the required output power – high, medium or low power.

then press the  or  key

Antenna socket selection

Each channel can be directed to use either the default antenna socket or the auxiliary antenna socket. This is useful if two antennas are used for different frequency ranges.

Note:- the default antenna socket is ANT 1, the Auxiliary antenna socket is ANT 2.

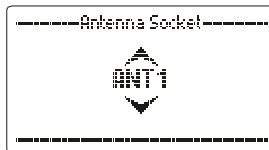

Use the Scroll keys to select the required antenna socket 1 or 2

then press the  or  key

Selcall format

Each channel can be programmed for one Selcall format, for a description of the formats available, refer to the beginning of this manual.



Use the Scroll keys to select the required Selcall format

then press the  or  key

This last key press displays the following screen indicating the channel programming is complete:-



The channel program sequence can be aborted at any stage in the programming sequence by pressing the  key after which the following is displayed:-

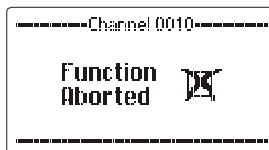

Cloning (programming) from another transceiver

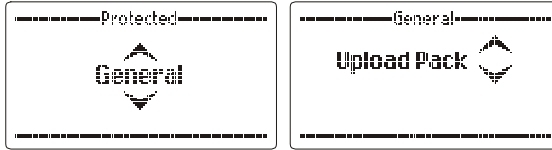



Note:- Use the transceiver you want to **send the configuration from** for the following steps

This feature is used to send a copy of the configuration of one 2050 transceiver or 2050 transceiver fitted in the manpack adaptor to another using a cable (Barrett P/N BCA90024 or BCA204020) connecting both transceivers together via their auxiliary connectors using the RS-232 connection.

Before uploading commences it is necessary to enter the Selcall ID's of the transceiver that will be loaded.

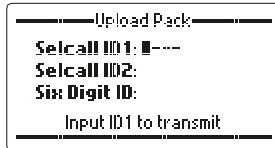
press the  key



Using the numeric keypad enter Self ID 1 and press the  key

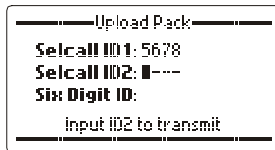

Using the numeric keypad enter Self ID 2 and press the  key

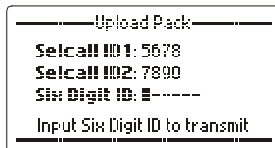

Using the numeric keypad enter Six digit ID and press the



key

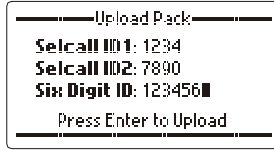

then press the  key to proceed with cloning.

2050 Transceiver in the 2040 Manpack Adaptor

The Barrett manpack uses a Barrett 2050 deployed in the Barrett 2040 manpack adaptor, therefore all the operations described in the manual above will operate when the 2050 transceiver is in this configuration. The only difference is the RF power output is automatically reduced so that there are only two power settings 10 Watts and 30Watts. These are set by the channel power setting, Low Power (LP) is 10Watts and Medium Power (MP) and High Power (HP) are both 30Watts

The Barrett 2040 manpack adaptor comprises:-

An automatic antenna tuner for operation with a collapsible whip or long-wire.

A removable 10Ah lithium ion battery cartridge

An inbuilt battery management system that charges and operates the manpack with DC input voltages between 22VDC and 26VDC, allowing operation from 24V vehicle sources, 24V solar panels and 24V hand crank generators. A separate Universal AC/DC input power adaptor Barrett P/N BCA204007 is available to charge and operate the manpack when mains voltages are available between 100-254 VAC or DC voltage between 11-18VDC are available from sources such as a 12V vehicles sources.

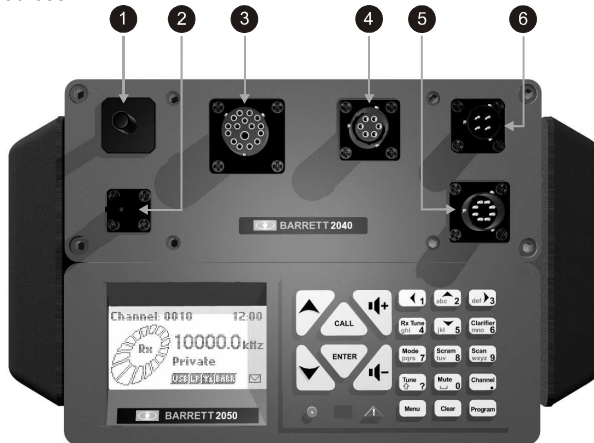

- 1 Whip antenna socket
- 2 Long wire antenna BNC socket
- 3 Auxiliary socket
- 4 ESU/CW socket
- 5 Handset socket
- 6 External power socket

Fitting the 2050 into the 2040 manpack adaptor

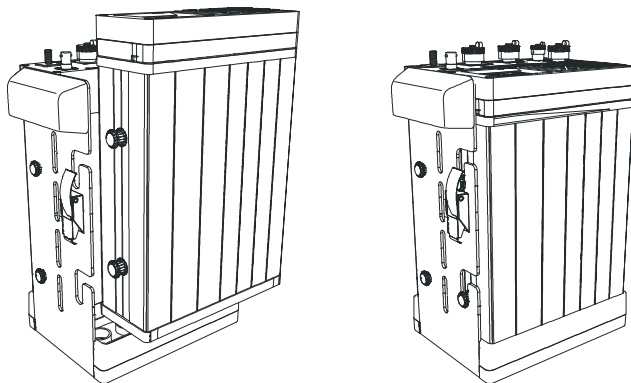

Removing the battery cartridge

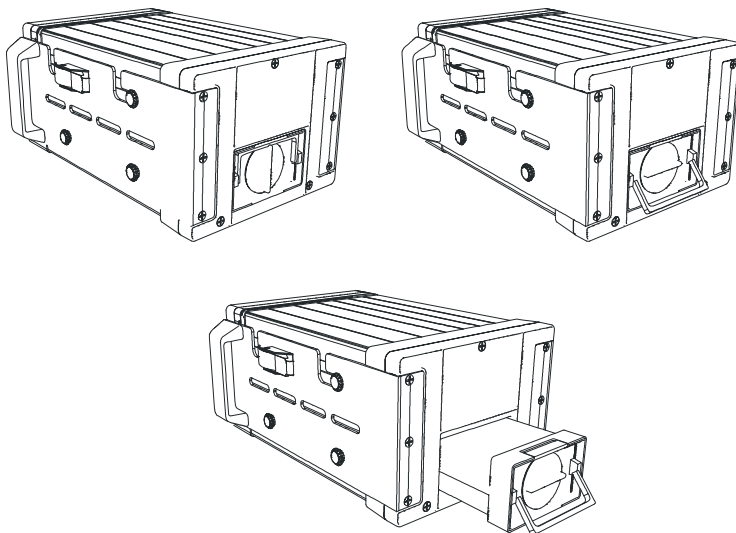

Powering and charging the Barrett manpack

The Barrett manpack transceiver uses a 10Ah Lithium Ion battery cartridge.

With the battery cartridge fitted in the manpack the transceiver can be operated and the battery cartridge charged when a DC input of between 22 VDC and 26 VDC is supplied to the unit.

This DC power supply can be generated in several ways:-

- 1 From a 24V vehicle power source using DC power cord Barrett P/N BCA204006
- 2 24 VDC Tactical solar panel Barrett P/N BCA204010
- 3 24 VDC Hand crank generator Barrett P/N BCA204011
- 4 From a mains AC supply between 100VAC and 254VAC or DC supply between 11 and 18 VDC using the Barrett universal AC/DC power adaptor Barrett P/N BCA204007

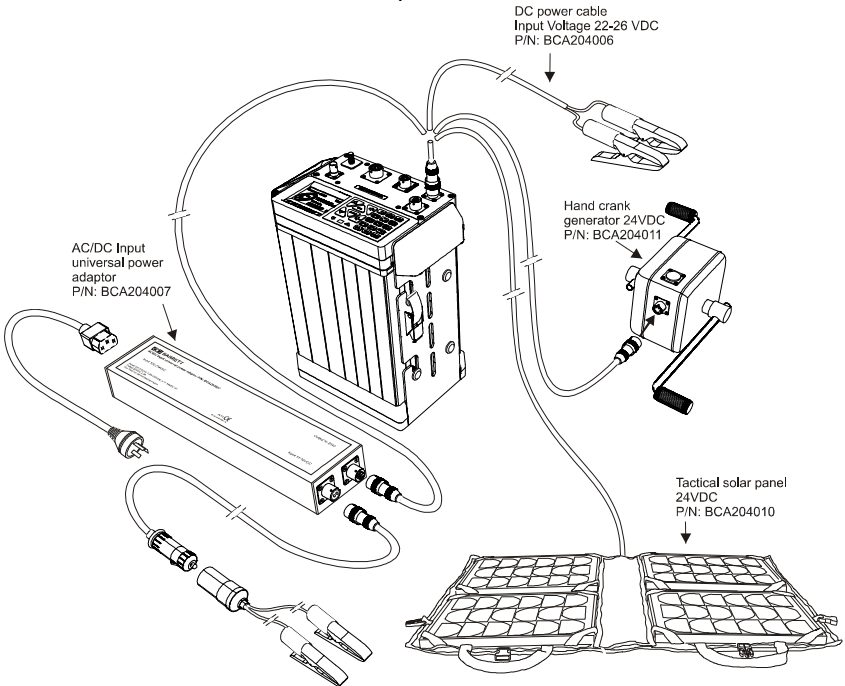

Charging a 10Ah lithium ion battery cartridge outside the manpack

The 2040 battery cartridge can be charged outside the manpack using the external battery management unit P/N BCA204013 and the AC/DC input universal power adaptor P/N BCA204007. Alternatively the external battery management unit can be powered without the use of the AC/DC input universal power adaptor by a 24V source such as the following:-

- 1 From a 24V vehicle power source using DC power cord Barrett P/N BCA204006
- 2 24 VDC Tactical solar panel Barrett P/N BCA204010
- 3 24 VDC Hand crank generator Barrett P/N BCA204011

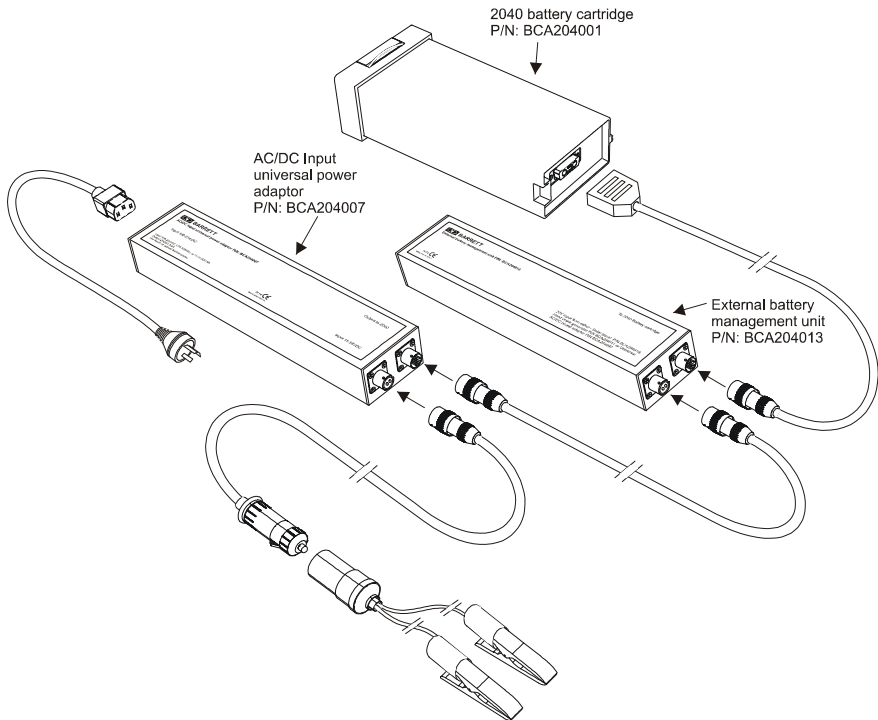

Battery charge indicator when charging the 2040

When the charging source is connected to the 2040 and the transceiver is switched on, the battery icon between the channel number and the time shows the progress of the charge process:-

If no battery charging icon is visible it indicates the charging device is not connected or connected but not providing charge, or is connected but switched off:-

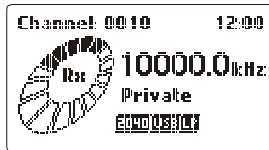

The battery icon with a moving line running from left to right indicates that the battery is charging:-



The battery icon stationary and filled "black" indicates that the battery is charged and the charger is now trickle charging:-

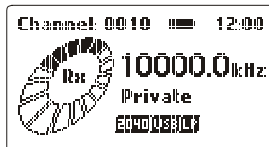

Operation in the Manpack Configuration

Manpack operation using the automatic antenna tuner

The Barrett manpack can be used with the 10 metre throw over long-wire provided or the optional 3 metre collapsible whip.

Note:- Either the whip or the long-wire can be used but not both together.

Using the whip

The gooseneck should be fitted to the whip antenna stud and the whip unfolded to its maximum height. If using the Barrett manpack while walking in the backpack configuration it is suggested that while in receive standby mode the collapsible antenna be only extended to half height and secured using the Velcro tab. **When a call is received extend the antenna to full height before transmission.**

Note:- When using an un-tuned antenna such as the whip or the long-wire the section **"2040 Antenna Select"** in the standard menu should be used to enable the automatic tuner i.e. select "Whip/Long-wire" operation. When this is selected the in-built tuner automatically tunes the whip or long-wire whenever the unit transmits after a channel change.

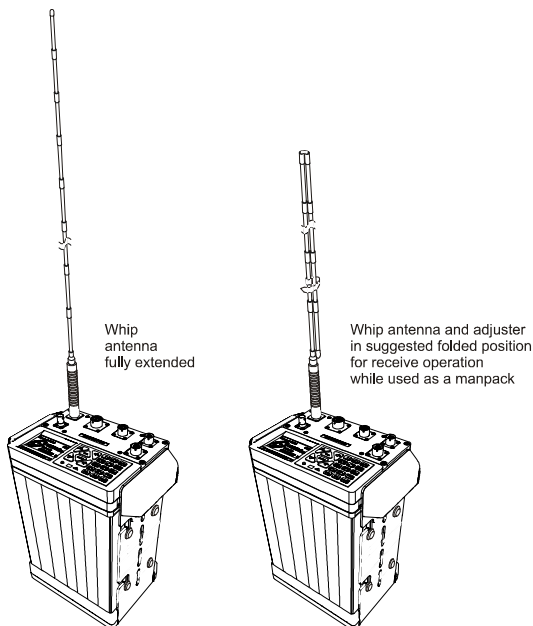

Using the throw over long-wire antenna

The long-wire antenna should be unfurled and the end away from the manpack transceiver should be attached to any structure available and as high as possible.

Note:- When using an un-tuned antenna such as the whip or the long-wire the section “**2040 Antenna Select**” in the standard menu should be used to enable the automatic tuner i.e. select “Whip/Long-wire” operation. When this is selected the in-built tuner automatically tunes the whip or long-wire whenever the unit transmits after a channel change.

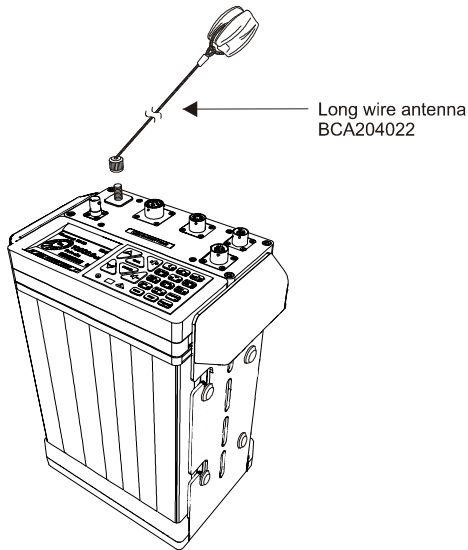

Using the counterpoise

When using either a whip or the long-wire antenna efficiency can be increased by the use of the counterpoise supplied. This is connected to the 2040 via the BNC connector connected to the counterpoise. The three radials should be spread out on the ground as indicated in the diagram below:-

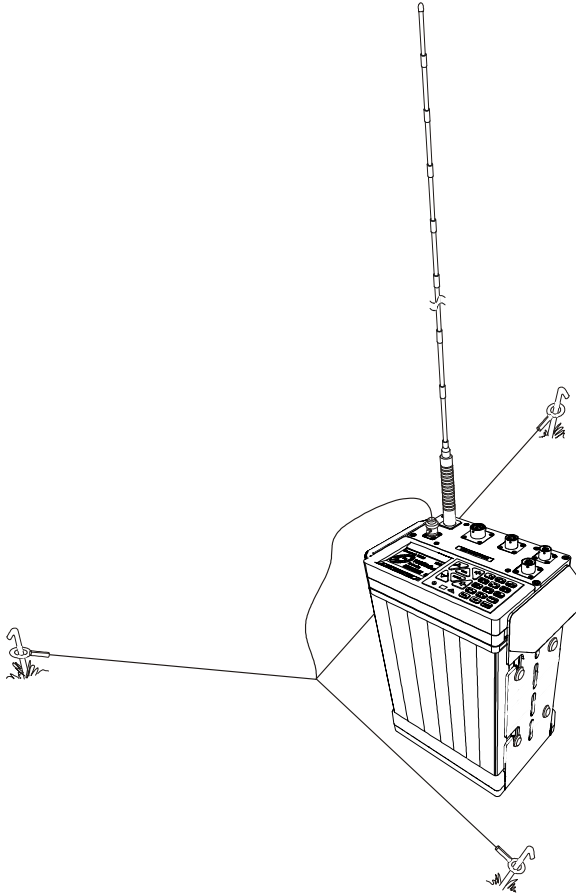

Operation of the Manpack in Frequency Hopping Mode

To operate in frequency hopping mode one of the two types of ESU's (Encryption Synchronisation Units) supplied with the frequency hopping option must be plugged into the ESU socket on the top of the 2040 manpack adaptor. Both ESU's acquire satellite timing information so must be in view of the sky i.e. cannot be operated inside buildings. This is why one version of the ESU has an extension lead to enable the ESU to be positioned outside if operating within a building. Both ESU's can be used to supply position information for position tracking operations.

To operate the manpack in frequency hopping mode refer to the Section "Frequency hopping" in this manual.

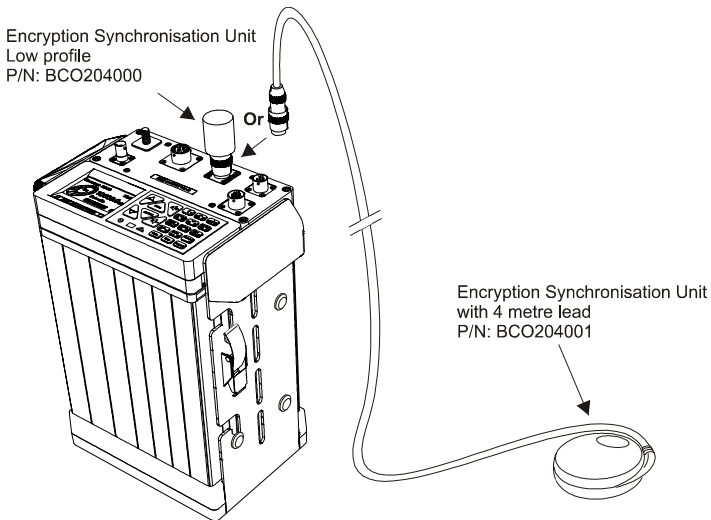

Operation of the Manpack in Temporary Base Stations

For temporary base station operation, Barrett manpack can be operated using either a single wire, end fed, portable broadband antenna **Barrett P/N BC91205** or a tactical rapid deploy end fed low power dipole, **Barrett P/N BC91503** as illustrated below:-

Deploying the end fed single wire low power broadband

Barrett P/N BC91205

Unfurl the broadband antenna from the winding bobbin supplied.

Push the earth stake into the ground. Clip the short wire from the balun box, with the coaxial connector on it, to the earth stake using the crocodile clip supplied.

Hang the wire section of the antenna in any configuration convenient as indicated in the diagrams below. Note the higher from the ground the more efficient the antenna will be.

Connect the coaxial cable from the coaxial socket on the blue balun box on the antenna to the manpack transceiver 50Ω BNC antenna socket.

The antenna is now ready for operation, no tuning or adjustments are required.

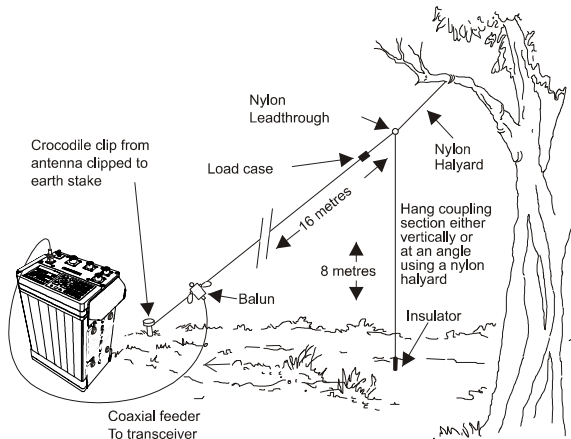

Deploying the tactical rapid deploy, tuned, end fed, low power dipole

Barrett P/N BC91503

Remove all components from the kit bag and check for damage/wear, ensure all components are present.

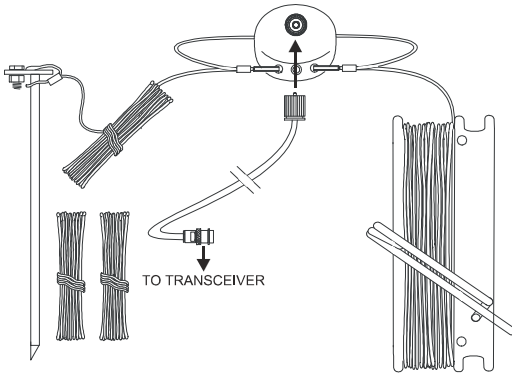

Choose a spot on the ground near to a tree or elevated anchor point. Fit the coaxial cable to the balun as indicated in the diagrams below. Unwind the cable and lay the assembly on the ground. From the bobbin unwind the insulated cable until the desired frequency marker is reached, secure the cable into the slots provided on the bobbin. The nylon halyard should then be

unwound and laid out (if required). Push the earth peg into the ground. The radiating end of the end fed dipole is now ready to be elevated into a working position either on a tree or some elevated natural object using the lead weight and nylon halyard. If you have a mast available, the antenna may be slung from this.

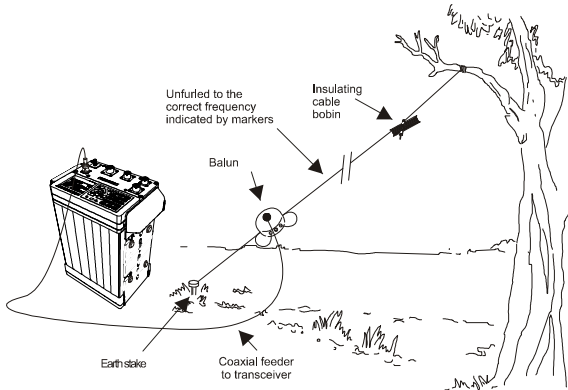

Connect the coaxial cable from the coaxial socket on the balun centre on the antenna to the manpack transceiver 50Ω BNC antenna socket.

The antenna is now ready for operation on the frequency you have set it to; select that frequency on the transceiver.

Connectors

Auxiliary socket

15 pin waterproof panel mounted socket

Pin	Name	Description of function	Level
A	+13V8 Fused	Fused 13.8VDC output	+13.8VDC
B	Bal Audio Out 1	Balanced audio out 1	600 Ω -6dBm to +9dBm
C	Bal Audio Out 2	Balanced audio out 2	600 Ω -6dBm to +9dBm
D	Bal Audio Out 1	Balanced audio in 1	600 Ω -24dBm to 0dBm
E	Bal Audio Out 2	Balanced audio in 2	600 Ω -24dBm to 0dBm
F	Aux PTT	PTT in	Active low 0V
G	RS-232 Tx	RS-232 Tx data	True RS-232 levels
H	RS-232 Rx	RS-232 Rx data	True RS-232 levels
J	Scan Stop	Scan stop input	Active low 0V
K	PTT Out	PTT output to external equipment	Active low 0V
L	Aux Dig Out 2	Auxiliary digital output (future use)	Active low 0V
M	Gnd	Ground	Ground 0V
N	Speaker	Loudspeaker output	0-10V
P	Gnd	Ground	Ground 0V
R	Gnd	Ground	Ground 0V

ESU/CW socket

6 pin waterproof panel mounted socket

Pin	Name	Description of function	Level
A	1PPS	1 PPS from External Synchronisation Unit (ESU)	TTL
B	NMEA +	NMEA data input	+5VDC
C	+5	+5V for ESU power	+5VDC
D	CW key	CW key input	Active low 0V
E	Gnd	Ground	Ground 0V
F	N/C	Not connected	

Handset Socket

6 pin waterproof panel mounted socket

Pin	Name	Description of function	Level
A	Handset PTT	PTT input from handset	Active low 0V
B	Handset audio in	Handset mic. audio	
C	Speaker mic PTT	PTT input	Active low 0V
D	Speaker audio out	Loudspeaker output	0-10V
E	Speaker mic audio in	Unbalanced audio in	
F	Gnd	Ground	Ground 0V

Power socket

4 pin waterproof panel mounted socket

Pin	Name	Description of function	Level
A	+VIn	External supply input – positive	+22 to 28 VDC
B	+VIn	External supply input – positive	+22 to 28 VDC
C	Gnd	External supply input – negative	0 VDC
D	Gnd	External supply input – negative	0 VDC

Installing the Barrett 2050 Transceiver

Changing the 2050 transceiver from a desktop unit to a remote control (trunk mount) unit using the Mobile Pack P/N BCA20501.

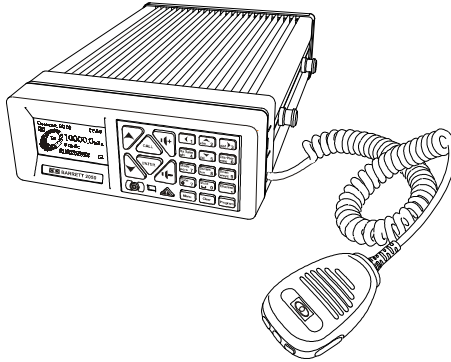

Use a flat bladed screwdriver to gently lever the side clip open and pull the remote head unit forward.

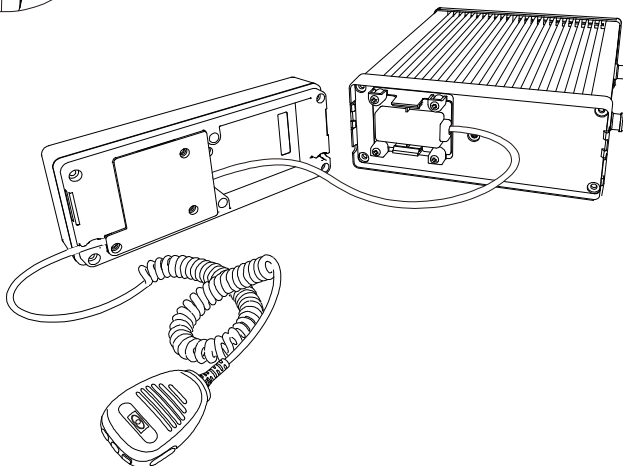
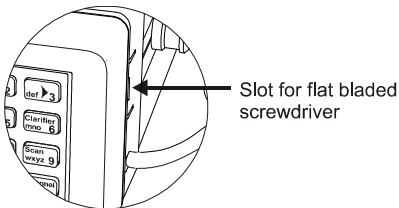

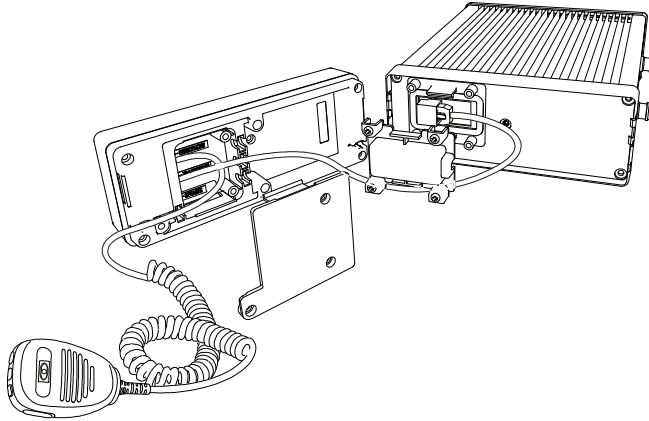

Gently lever the two plastic covers off to provide access to the connectors. Remove the short interface cable from the remote head and transceiver body and replace with the long interface cable. Insert the speaker cable into the correct socket on the remote head.

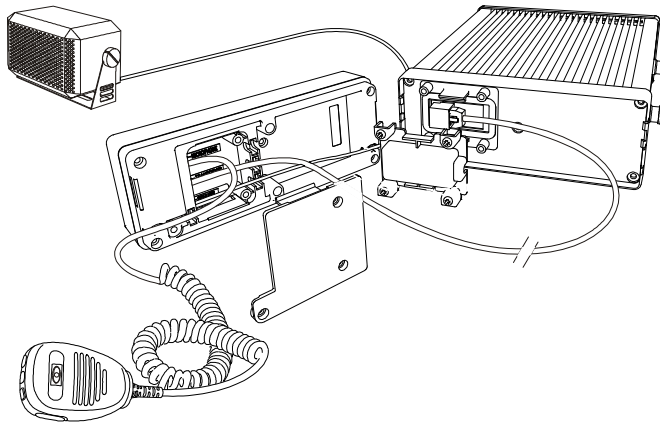

Replace the cover on the transceiver body taking care to place the cable grommet around the interface cable. If required, this cover, whilst having clips, can then be secured with M3 screws to provide a solid cable clamp.

Place the cable grommets around the cables on the remote head and push the cables into the grooves on the remote head. Place the blanking grommet into the unused slot. Replace the plastic cover on the remote head. If required, this cover, whilst having clips, can then be secured with M3 screws to provide a solid cable clamp.

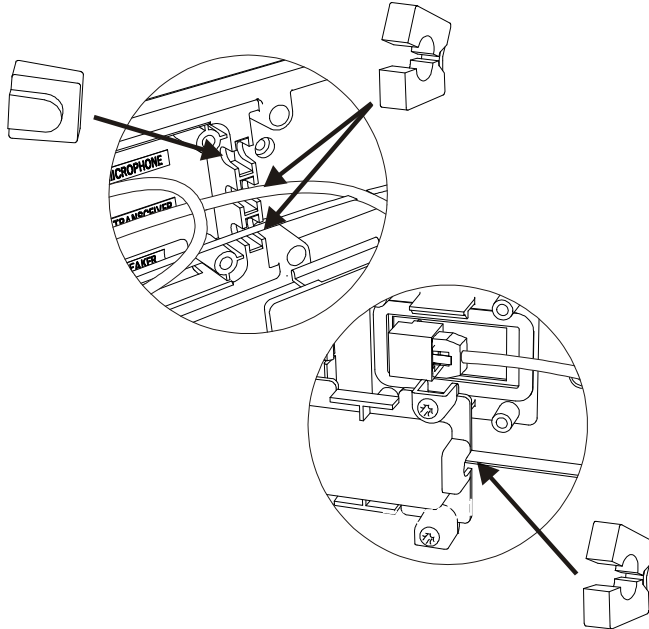

Attach the RAM mount using the 2 x M5 screws provided to the centre of the remote head.

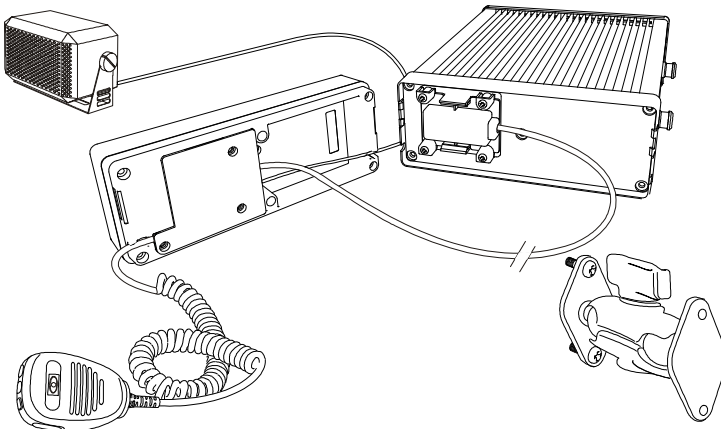

Land Based Systems

Introduction

This section provides instructions for the installation of land based HF communication equipment.

Most of the installation work can be performed by non-technical personnel if they carefully follow the instructions given in this handbook. It is however recommended that the completed installation be checked by a suitably qualified technician. In some equipment configurations, technical adjustment is required for the equipment to operate correctly.

Note:-Some equipment has specific instructions supplied with it. When this is the case those instructions over-ride the general guidance of this handbook, and must be followed in detail.

Unpacking and inspection

When unpacking the transceiver, check the contents against the packing note provided. Before discarding the carton, check that all accessories have been removed and are not mislaid in the packing material. Inspect the equipment for any transit damage. If damage has occurred notify your supplier immediately and gain their advice on further action. Failure to do this could affect the warranty covering the equipment.

Fixed station installations

Transceiver position

The following should be considered when choosing a position for the transceiver.

Operating convenience

The transceiver should be placed so that the operator is comfortable and any facilities he may require are easily accessible.

Air circulation

Most transceivers rely on air flow around cooling fins to dissipate heat generated by the transmitter. The mounting position must allow free air flow around these fins.

Proximity of transceiver to antenna

When using RG-58 coaxial cable from the transceiver to the antenna a cable length of no more than 30 metres is recommended. Should a run of more than 30 metres be required it is recommended that a low loss coax such as RG-213 or RG-8 be used.

It is recommended that the transceiver chassis is connected to ground using the bolt on the rear panel to stop pick-up of unwanted noise from local power supplies and electrical equipment.

Power supply

All Barrett transceivers require a supply voltage of 13.8 VDC. In most vehicles or vessels this is available from the battery, in the case of vehicles with a 24V system a 24V to 12V converter rated at 25 amps should be used (Barrett P/N BCA90014). In fixed station installations where mains power between 88VAC and 256VAC is available, a Barrett 2022 power supply should be used.

In base station installations where no mains supply is available a Barrett 2001 solar power supply is available.

Note:- Some installations use an AC battery charger to float charge the supply battery. Battery chargers can produce electrical noise from the rectifier diodes. This noise causes a static type of interference in the receiver. It may be necessary, therefore, to switch off the battery charger whilst the transceiver is in use. If float charging of batteries is required for installations with unreliable AC power supply, it is recommended that a Barrett 2022 be used as this provides a boost and float charge facility to maintain a battery without the noise problem described above.

Voltage drop

The average current consumption of the transceiver is low but during transmission of voice peaks, high current is needed for short intervals. This means that the power supply cable must be heavy enough to supply these short duration current peaks without excessive voltage drop. Preferably use only the power cable supplied with the transceiver. If extra cable is required use a cable with a conductor square area of no less than 8mm. Unwanted voltage drop will also occur if incorrect wiring techniques such as poor choice of connection points and incorrect use of terminal lugs are used.

Protection fuse

The transceiver is provided with adequate internal protection. However, the fitting of an external fuse is considered necessary, not for protection of the transceiver itself, but to ensure that in the event of damage to the cable, a fire risk does not exist. The fuse used must be installed in the active wire as close as possible to the battery, and must be of a type which has a low voltage drop at the peak currents expected.

Note:- in-line 3AG glass fuses are not suitable. An ATC automotive blade type fuse rated at 25A with a suitable high current ATC fuse holder rated at 30A or more should be used. These type of fuses and holders are contained in our standard installation kit (Barrett P/N BCA20004) or are available individually (Barrett P/N BCA20021)

Antenna

The antenna is a most critical part of the complete radio installation. It must accept the output power from the transmitter, radiate that power with minimum loss and in the receive mode, accept weak signals for input to the receiver.

Incorrect antenna installations will yield poor system performance and are often the cause of complaints of poor transceiver performance.

A range of antennas is available from Barrett to suit most small fixed stations. Detailed instructions are included with each antenna.

912 single wire broadband dipoles - Barrett P/N BC91201

Barrett 912 single wire broadband dipoles are ideal for base stations that require operation on multiple frequencies throughout the HF spectrum using a single antenna.

The 912 antenna can be mounted either in a horizontal or inverted 'V' configuration as illustrated in the following diagrams. In the horizontal configuration the major radiation direction is broadside to the antenna. When mounted in the inverted 'V' configuration the antenna becomes fairly omni directional. In the horizontal configuration the minimum distance between the masts is 49 metres and the recommended mast height is 15 metres. In the inverted 'V' configuration the recommended mast height is 15 metres and

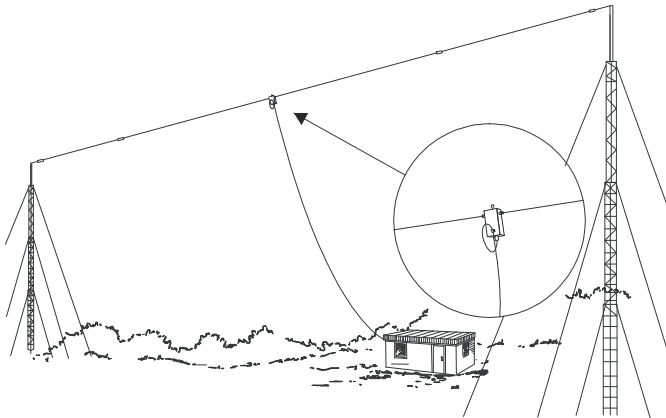

125 watt standard single wire broadband dipole

at this height the 2 metre stub masts are each installed at a minimum of 19 metres from the mast base. In locations with limited space the antenna can be mounted with the ends past the load resistors drooped down towards the ground. White nylon supports located just past the load resistors are provided to attach halyards for this configuration. In this configuration the minimum distance between masts is reduced to 33 metres. Support towers may be either lattice masts as illustrated, tubular telomasts or other support structures that may be available locally. It is

recommended that the halyards used to support the antenna be either UV stabilised Dacron cord or wire rope and that pulleys should be of stainless steel construction.

Install the antenna as illustrated in the diagrams, in the inverted 'V' configuration the eye on the top of the balun is used to attach the support halyard.

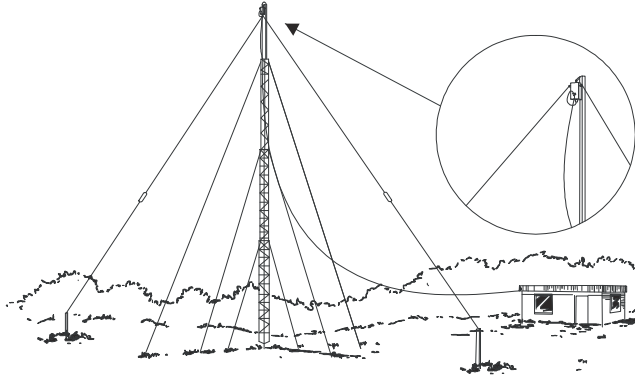

125 watt standard single wire broadband dipole in an inverted "V"

As with all antenna installations ensure the antenna is as far from sources of electrical interference as possible and in a position that makes it impossible for the antenna to come in contact with high voltage overhead mains wiring.

125 watt standard single wire broadband dipole in a limited space configuration

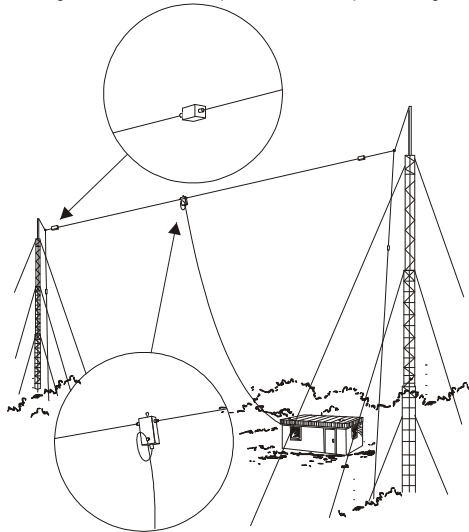

912 multiwire broadband dipoles - Barrett P/N's BC91200, BC91202 and BC91203

Barrett 912 broadband dipoles are ideal for base stations that require operation on multiple frequencies throughout the HF spectrum using a single antenna.

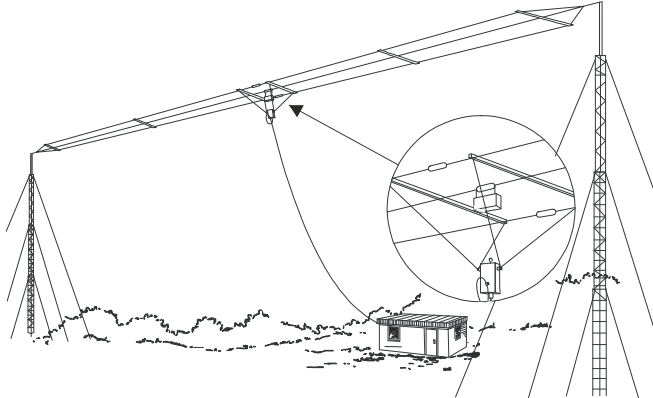

125/500 watt multi wire broadband dipole

The Barrett 912 antenna can be mounted either in a horizontal or inverted 'V' configuration as illustrated in the following diagrams. In the horizontal configuration the major radiation direction is broadside to the antenna. When mounted in the inverted 'V' configuration the antenna becomes fairly omni directional. In the horizontal configuration the minimum distance between the masts is 32 metres and the recommended mast height is 15 metres. In the inverted 'V' configuration the recommended mast height is 15 metres and at this height the 2 metre stub masts are each installed at a minimum of 19 metres from the mast base. In this configuration the mast must have an offset or out-rigger bracket, at least 0.8 metres long, to hold the antenna away from the mast. Support towers may be either lattice masts as illustrated, tubular telomasts or other support structures that may be available locally. It is recommended that the halyards used to support the antenna be either UV stabilised Dacron cord or wire rope and that pulleys should be of stainless steel construction.

Install the antenna as illustrated in the diagrams, in the inverted 'V' configuration the eye on the top of the balun is used to attach the support halyard. In the horizontal configuration the balun hangs below the antenna.

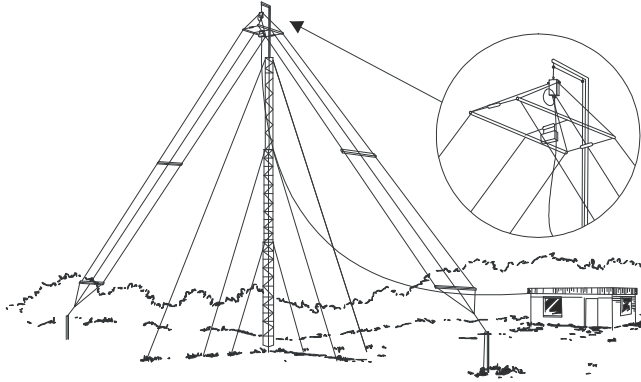

125/500 watt multi wire broadband dipole in an inverted "V" configuration

As with all antenna installations ensure the antenna is as far from sources of electrical interference as possible and in a position that makes it impossible for the antenna to come in contact with high voltage overhead mains wiring.

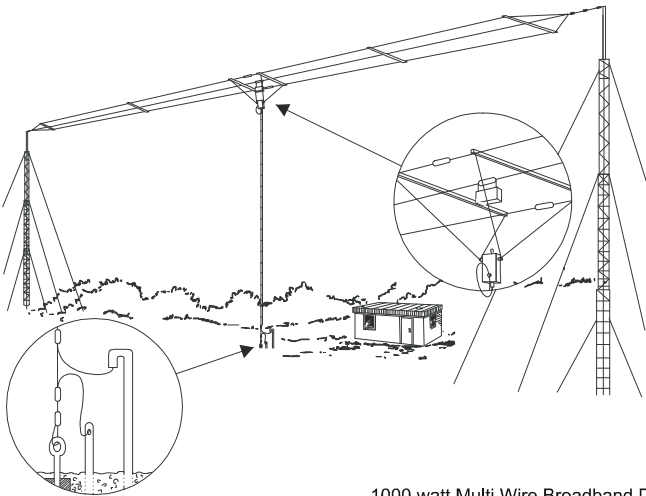

1000 watt Multi Wire Broadband Dipole

913 series helical dipoles - Barrett P/N's BC91301 to BC91305

913 series helical dipole antennas are compact and easily installed, having extremely narrow bandwidth characteristics and a performance approaching that of a wire dipole when used at frequencies over 4.5 MHz. The helical dipole antenna is fed by a single coaxial feeder and can accommodate up to 5 frequencies.

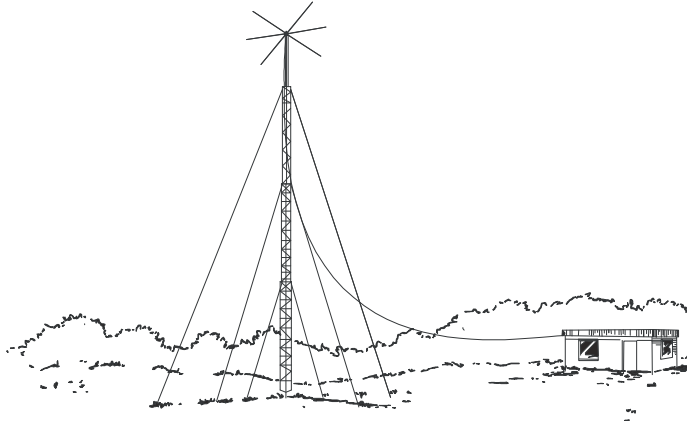

3 frequency helical dipole

The 913 helical dipole requires a 50mm diameter mounting pole. This pole should be long enough to place the helical dipole at least 5 metres above any obstruction. Alternatively the helical dipole can be mounted on top of a mast or tower. Make sure that the site selected for the antenna is as far from any source of electrical interference as possible and that under no circumstances it can come in contact with high tension power lines.

After mounting the helical dipole hub on the mounting pole, remove the front circular cover, pass the coaxial cable through the hole at the bottom of the hub. Screw the UHF connector into the balun. Now screw the helical dipole elements onto the hub. Each element has its frequency marked on the brass ferrule used to screw the element onto the hub. Assemble the helical dipole elements in the positions on the hub as indicated by the diagram enclosed in the hub. Failure to assemble the helical dipole as indicated in this diagram will cause tuning problems.

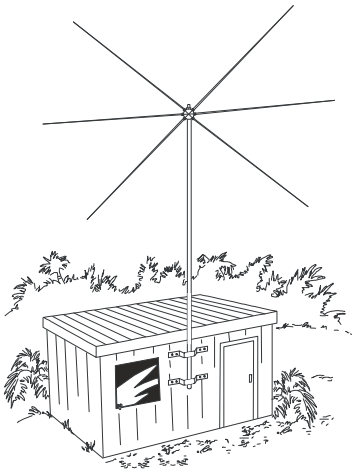

3 frequency helical dipole

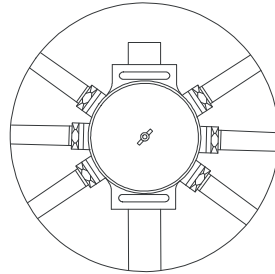

Hub detail

Helical dipoles are manufactured to specific frequencies, but may require fine tuning after installation. To enable this the dipole elements have an adjustable length tip to allow fine tuning for optimum VSWR during installation. Install the antenna in its final position and check the VSWR on each of the frequencies that the antenna was manufactured for. Should the VSWR be greater than 1.5:1 the antenna will require adjustment. If a tunable transmitter is available, determine on each frequency the helical dipole was manufactured for, at what frequency the best VSWR is obtained. If this occurs at a frequency below the required frequency then the tips will have to be shortened on the pair of elements corresponding to that frequency. If the best VSWR occurs on a frequency higher than the required frequency then the tips will have to be lengthened. Adjust both ends by an equal amount and repeat the above sequence until an optimum VSWR is obtained. If a tunable transmitter is not available use a method of trial and error to adjust the length of the tips, a little at a time, until an optimum VSWR is obtained. Remember always adjust each pair of elements by the same amount at each adjustment.

915 wire dipole - Barrett P/N BC91500

Single frequency wire dipole antennas, spot-tuned to the required operating frequency(s), are the most efficient antennas for use in HF base stations. They are simple to install and have a relatively narrow bandwidth.

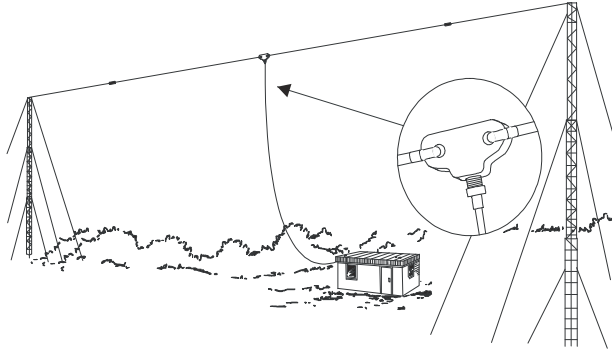

Single frequency wire dipole

Dipole antennas should be mounted at least 1/2 wavelength from the ground. Dipoles may be mounted either between two towers or in an inverted "V" configuration (requires only one mast). As a guide, when installing the masts, the length between insulators of a half wave wire dipole is $142 / (\text{frequency of dipole in MHz})$ metres. To this an allowance should be made for extra insulators and halyards.

i.e. a 3.7MHz dipole - length between the insulators = $142 / 3.7 = 38.38$ metres.

Wire dipoles supplied by Barrett are pre-cut to a specified frequency but have adjustable ends. These adjustable ends allow fine tuning for optimum VSWR during installation. To fine tune a dipole install the antenna in its final position and check the antenna VSWR. Should the VSWR be greater than 5:1 the antenna will require adjustment.

Single frequency wire dipole in an inverted "V" configuration

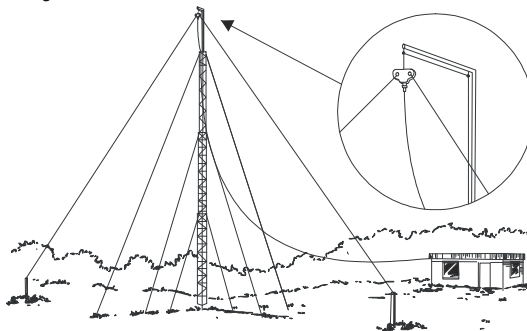

If a tunable transmitter is available, determine at what frequency the best VSWR is obtained. If this occurs at a frequency below the required frequency the dipole is too long, if it occurs on a frequency higher than the required frequency then the dipole is too short. Drop the dipole and adjust both ends by an equal amount and repeat the above sequence until an optimum VSWR is obtained. If a tunable transmitter is not available use a method of trial and error shortening or lengthening the dipole ends, a little at a time, until optimum VSWR is obtained. Remember to always adjust each end by the same amount as the other every time.

Several single frequency wire dipoles positioned between two towers.

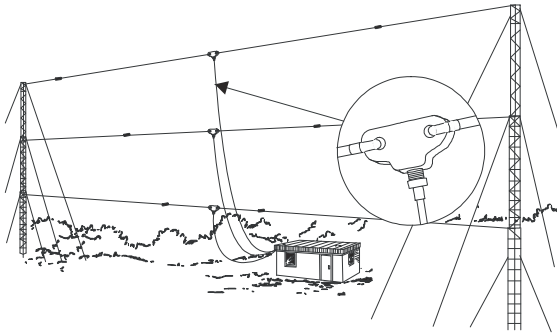

Barrett 911 automatic antenna tuner for base station installations

Antenna

Various antenna configurations, such as vertical whips, long-wires and loops, can be used for base station installations, using the Barrett 911 automatic antenna tuner. In general however the following points should be considered:-

The antenna should be mounted as far away as possible from buildings, trees, vegetation and sources of electrical interference. If metallic masts or supports are used, arrange insulators to ensure the antenna is spaced at least 2 metres from the mast. Remember the radiating part of the antenna starts at the tuner. The location of the bottom portion of the antenna is very important.

Horizontal wire antennas have maximum radiation broadside to the antenna when the frequency is less than 1/4 wavelength. Radiation is at a minimum at the end points of the antenna. Inverted "V" installation of horizontal antennas minimises the directivity and is recommended for omni-directional coverage.

High voltages are present on the antenna system. The antenna tuner and antenna should be located or protected so that there is no possibility of accidental contact.

Transceiver and tuner mounting

The transceiver should be mounted in a suitable position allowing easy operator access. The antenna tuner should be mounted, preferably out of the weather, and as close to the ground (earth) point as possible. The interconnect cable supplied with the antenna tuner should be routed, away from other cables, back to the transceiver and connected as indicated in the diagram. The maximum interconnect cable should be less than 25 metres.

Ground (earth) system

The ground (earth) system is a key part of the overall antenna system and consequently the system operation. An inadequate ground system is the primary cause of poor performance and tuning problems. There is little point in installing the antenna unless a good ground system can be provided. In areas of good ground conductivity (ie. ground always damp), an effective ground can be made through a grounding rod. This should be approx. 3 metres in length and should be installed as close to the tuner as possible. Several rods bonded together will improve the ground contact. In some cases metal water pipes may be used as a ground providing:-

- The water pipe is close to the tuner and the water pipe enters the ground close to the tuner.
- There are no joints or couplings in the pipe that will increase the resistance path to ground.
- The water pipe enters soil with good conductivity.

- A low resistance joint is made with the water pipe.

Frequently the ground conductivity will not be sufficient to provide a satisfactory ground for the Barrett 911 tuner. This will almost certainly be the case in well drained sandy soils or on rock. In these cases a counterpoise must be used as a ground system. This will also be the case in rooftop installations where no existing ground plate (such as metal roofing exists). A counterpoise can consist of radial wires or a mesh made of materials such as chicken wire. If radial wires are used the counterpoise should consist of at least 8 to 10 radial wires, each radial being at least 5 metres in length. When radials or mesh are used at ground level it is recommended that they be buried a few centimetres below the surface.

Electrical checkout

After mechanical installation is complete select the highest frequency to be used on the transceiver. A directional watt-meter such as a bird model 43 should be inserted in the coaxial transmission line between the transceiver and the tuner. The tune mode on the transceiver is then energised (refer to the transceiver user manual). Upon application of RF energy, the tuner should start to tune, indicated by the 'clattering' of the tuner relays. After a few seconds the relay noise will cease, the transceiver should indicate a successful tune and the watt-meter reflected power should indicate a low value consistent with a VSWR of better than 2:1. Now select the lowest desired frequency on the transceiver and repeat the above procedure. The result should be the same, except that the tune cycle may take somewhat longer. If the above procedure does not give the results as indicated check that the antenna length and connections are correct and re-check all ground (earth) connections.

Note:- When received, the Barrett 911 automatic antenna tuner memory system will usually not have any pre-stored tuning information appropriate to your installation. To allow the 911 to 'learn' it's tuning information simply proceed from one channel to the next allowing the normal tune cycle to take place. Each successful tune is 'memorised' so that when that channel is re-selected the tuner will almost instantaneously retune to that frequency.

Connection details - 2050 transceiver and 911 automatic antenna tuner in a base station configuration.

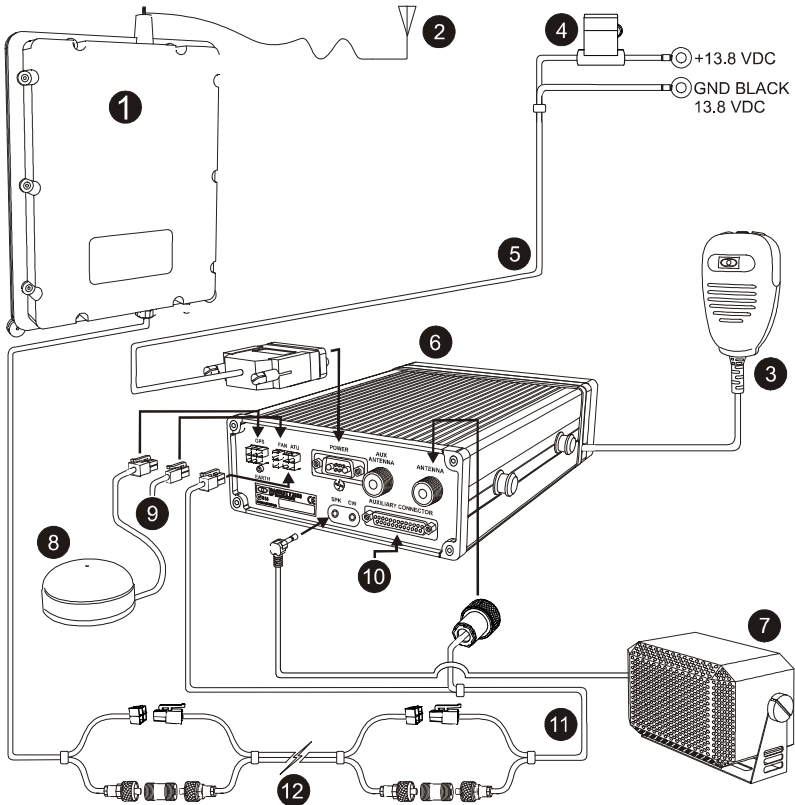

- | | | | |
|---|-----------------------------------------------|----|------------------------------------------------------------------------|
| 1 | 911 automatic antenna tuner | 7 | Extension speaker supplied standard with 2050 transceiver |
| 2 | Antenna | 8 | External GPS receiver option |
| 3 | Microphone | 9 | Connection for external fan unit option |
| 4 | Heavy duty fuse & holder P/N BCA20021 | 10 | Auxiliary connector |
| 5 | 6 metre power cable supplied with transceiver | 11 | Coaxial/control cable P/N BCA90032 |
| 6 | 2050 transceiver body | 12 | Optional 6 or 10 metre extension cable with connectors P/N BCA90032/40 |

Mobile Installations

Transceiver position

The following points must be considered when mounting the transceiver.

Safety

It is essential that the transceiver be mounted in a place where it cannot cause injury to the occupants of the vehicle in the event of a motor vehicle accident.

For this reason overhead mounting is not generally recommended and "under dash" mounting must take into account the possibility of injuring the legs of front seat occupants.

Convenience

The chosen position for the transceiver or control head, (if a remote controlled model is used) should be one which allows convenient operation.

Positions which are often used are:

- on the transmission hump
- in place of the glove box
- behind the seat
- under the dash board (if safe)

Where a remote controlled transceiver is used, only the control head need be mounted convenient to the operator. The transceiver may be mounted under a seat, in the luggage compartment or any other out of the way place within the vehicle (which allows for sufficient cooling).

All equipment should be positioned in such a way that convenient access for maintenance is provided.

Strength

It must be assumed that the vehicle will be used on rough roads and in many cases off road. Hence mounting of equipment must take into account the severe vibration and shock that can be expected.

Transceivers may only be mounted to structural components of the vehicle body and not on dress panels or plastic interior panels. In some cases, the area around the transceiver mounting may need reinforcement.

Precautions should be taken to ensure fixing screws etc. cannot vibrate loose.

Air circulation

Most transceivers rely on air flow around cooling fins to dissipate heat generated by the transmitter. The mounting position must allow free airflow around these fins.

Obstruction

The installation of a transceiver into a vehicle should not inhibit the normal use of the vehicle. Before finally selecting equipment positions, check that normal operation of steering, foot pedals, gear change, hand brake etc. are not impeded, and that heater or air-conditioning outlets, glove box and doors are not obstructed. Always check that the drilling of mounting screw holes will not damage electrical wiring, heater hoses or hydraulic lines.

Power wiring

Connect the red positive and black negative wires from the transceiver power cable to the positive and negative terminal of the battery. Do not connect to the ignition switch or internal fuse panels as vehicle wiring to these points is of insufficient current capacity, causing voltage drop and possible noise interference.

- fit a suitable 25A ATC fuse and holder (Barrett P/N BCA20021), as near as practicable to the battery connection in the positive (red) wire.
- route the power cable away from high tension ignition wiring.
- secure the power cable, either to other wiring or the vehicle body, with suitable cable ties.
- where wiring passes through bulkheads, provide appropriate protection to prevent insulation being damaged.

Connection details - 2050 transceiver with mobile pack and 914 manual tapped mobile antenna

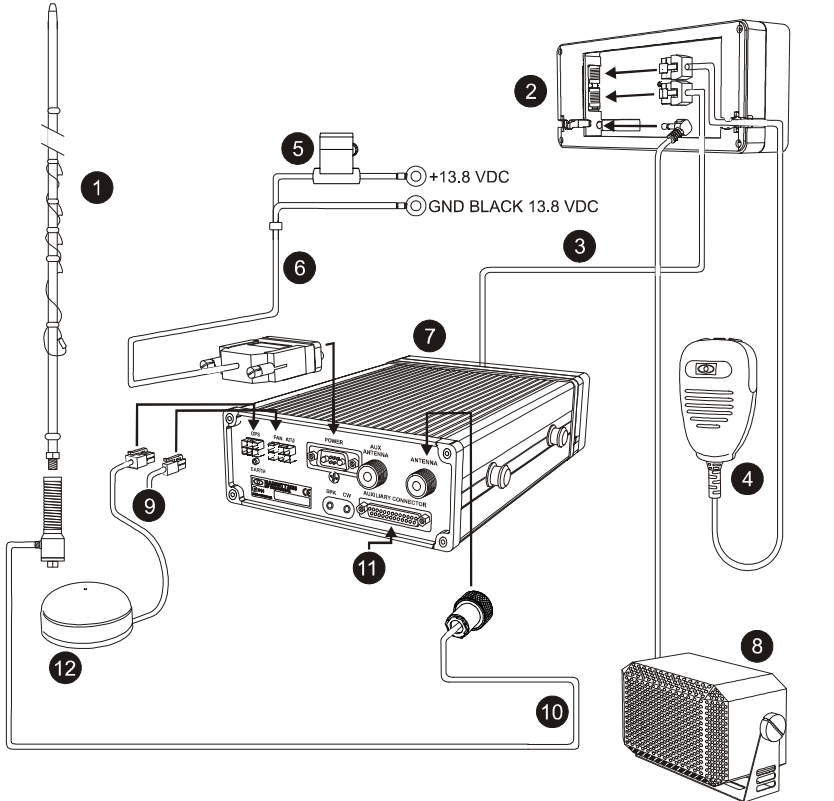

- | | | | |
|---|-----------------------------------------------|----|--------------------------------------------------|
| 1 | 914 Manual tapped whip antenna | 7 | 2050 Transceiver body |
| 2 | 2050 Control head supplied | 8 | Extension speaker supplied with 2050 transceiver |
| 3 | Cable with RJ45 connectors P/N BCA20005 | 9 | Connection for external fan unit option |
| 4 | Microphone | 10 | Coaxial cable and connectors P/N BCA90013 |
| 5 | Heavy duty fuse & holder P/N BCA20021 | 11 | Auxiliary connector |
| 6 | 6 metre power cable supplied with transceiver | 12 | External GPS receiver option |

Antenna

In any radio system an effective antenna installation is essential. Because of the need to reduce the size of HF antennas so that they can be fitted to a vehicle, mobile antenna bandwidth becomes quite narrow and hence tuning is critical. In most cases the only tuning adjustment that can be effected is adjustment to position. Particular attention must be given to the antenna position if satisfactory performance is to be obtained. Refer to the instructions supplied with the antenna you have selected.

Antenna mounting

The antenna mounting must provide a strong secure anchorage for the base of the antenna. To obtain maximum radiation, the antenna base **must** be well bonded electrically to the vehicle chassis. Paint, dirt, rust, etc. should be removed from the respective fixing points. The mounting point must provide a low resistance electrical path to the main vehicle metallic structure.

Antenna feed cables

Antenna feed cables should be run (as far as possible) away from other vehicle wiring and especially away from ignition high tension wiring. Where passing through body panels or internal bulkheads, grommets must be used to protect the cables. Water-proof connectors must be used when they are outside the vehicle.

Voltage standing wave ratio (VSWR)

After installation it is recommended that the VSWR of the antenna should be measured for each channel. The instructions supplied with the antenna selected will detail this operation.

Connection details - 2050 transceiver with mobile pack and 910 automatic tuning mobile antenna

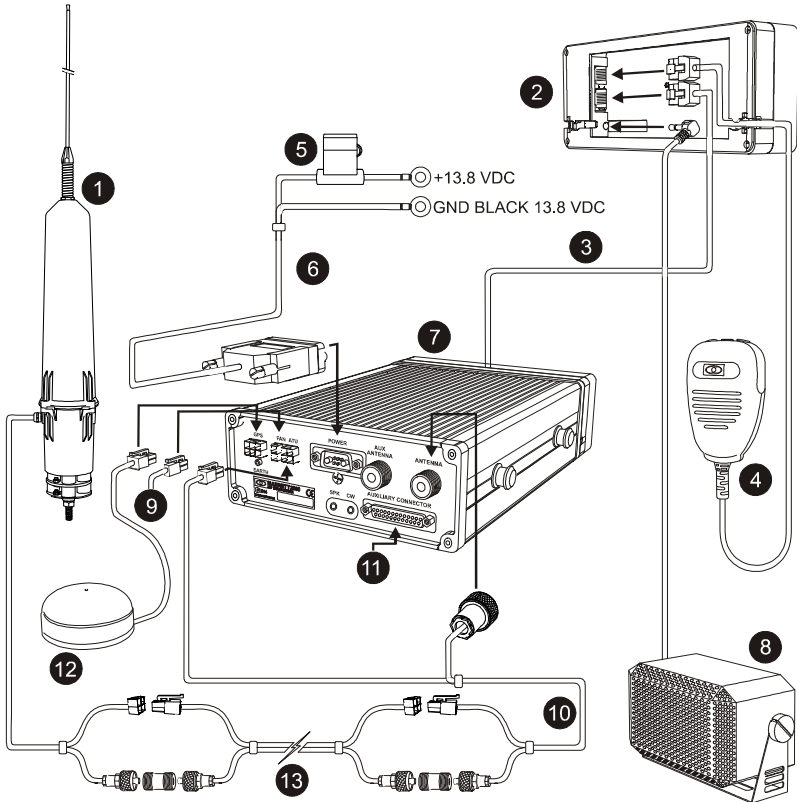

- | | | | |
|---|---------------------------------------------------------------|----|------------------------------------------------------------------------|
| 1 | 910 automatic tuning mobile antenna | 8 | Extension speaker supplied with 2050 transceiver |
| 2 | 2050 control head | 9 | Connection for external fan unit option |
| 3 | Cable with RJ45 connectors P/N BCA20005 | 10 | Coaxial/control cable P/N BCA90032 |
| 4 | Microphone | 11 | Auxiliary connector |
| 5 | Heavy duty fuse & holder P/N BCA20021 supplied in mobile pack | 12 | External GPS receiver option |
| 6 | 6 metre power cable supplied with transceiver | 13 | Optional 6 or 10 metre extension cable with connectors P/N BCA90032/40 |
| 7 | 2050 transceiver body | | |

Noise suppression

Noise generated by motor or electrical accessories on the vehicle may cause objectionable interference to the received signal. This noise enters the receiver either by means of the battery leads or the antenna system. Providing that the recommendations concerning battery wiring given earlier in this book are followed, noise injected via the battery lead is unlikely to be significant. Most noise problems result from pick-up by the antenna. Practical cures involve either preventing the noise from being generated or minimising it from being radiated by the wiring connected to the noise source.

Interference suppression kit (Barrett P/N BCA90017) is available to assist in noise suppression and contains filters, suppressing capacitors, earth straps and fitting instructions.

The techniques involved in noise suppression include re-routing of wiring, screening and the use of filters. It is also necessary to maintain all electrical equipment in good working order as worn brushes, loose connections and the like, will increase the amount of noise generated.

Before attempting to cure a noise problem, the source (or sources) of noise must be identified. Ideally, there should be no difference between background noise in the receiver with motor and accessories on and that with motor and accessories off.

If a detectable difference does exist, turn off all accessories one by one until a change in noise results. Continue, noting each contributing unit until there is no detectable difference from the "all off" noise level. (For accessories such as alternator, motors, instruments etc. a wire or drive belt may have to be temporarily removed for this assessment). After identifying each noise source, they can be worked on one at a time until an acceptable level of suppression is achieved.

Another approach to this problem is to remove or disconnect all possible sources of noise then replace and suppress them in turn.

Some suggestions for suppressing particular noise sources follow:-

Ignition systems

All high tension wiring from the ignition coil through to the spark plugs should be kept as short as practicable, clean, and as close to the engine block as possible. The cable should be an impregnated neoprene resistive type and the coil must be either mounted on, or immediately adjacent to, the engine block. The low tension wire from the coil to the distributor contact breaker points must be as short as possible, and not included with other wires in a harness or loom. This wire must be shielded if more than 300mm long. Twin flex or 'figure eight' cable provides a suitable shield when connected in lieu of the original wire. This method is useful for shielding other wires suspected of radiating noise. Do not ignore the wire to an electric tachometer if one is fitted.

Coil to battery wiring

A low pass filter such as that supplied in the interference suppression kit or similar should be fitted at the coil end of this wire. The earth connection of the filter should be short and well-bonded to the coil body.

Battery charging system

The charging system circuit, consisting of either generator or alternator and a regulator may also be split into three parts:-

Alternator / generator to battery wiring

A low pass filter such as that supplied in the interference suppression kit or similar should be fitted to the main battery lead at the alternator. The filter must be rated for the maximum current available from the charging system. The earth lug of the filter should be attached to the alternator body or the engine block.

Alternator to regulator control wire (generator field wire)

This wire carries switching pulses that often contribute noise to the receiver. Suppression using capacitors or filters must not be attempted since damage to the regulator may result. Separate the wire from all other wiring, keep it as short as possible and, if longer than about 300mm it should be shielded as described above.

Other regulator wires

These are normally adequately suppressed using good low-inductance bypass capacitors. To be effective, these capacitors must connect to the wires to be suppressed and to chassis with very short leads. For this reason, the 'pigtail' style of suppressor capacitor often used with MF broadcast receivers is generally ineffective at HF.

Other noise sources**Electric motors** (windscreen wipers, fans etc.)

Small electric motors can usually be suppressed with good low inductance bypass capacitors.

Engine instrumentation

Certain types of oil-pressure sensors and voltage regulators used in instrument systems contain a vibrating or thermal cycling contact. These devices can only be suppressed by isolating and screening or wiring in the same way as described for the alternator to regulator control wire. Disc ceramic capacitors with short leads (protected with insulating sleeving) are frequently useful but to prevent damage to instrument contacts, where the use of bypass capacitors is attempted, values larger than 1nF should not be used.

General noise suppression tips

When searching for sources of noise, some of their characteristics can be helpful in identification:-

Petrol engine ignition noise and contact breaker noise is a sharp staccato 'plop' varying with engine speed. It is only with this class of noise that the impulse noise limiter incorporated within some transceivers is effective

Noise from other sources generally has a more 'mushy' sound. That from the alternator/generator may only be troublesome over a limited range of engine speed and can also be influenced by the state of charge of the battery.

The noise from instrument regulators may depend on the battery voltage, the reading of the instrument and the length of time the system has been switched on. For this reason, the search for noise sources must be done thoroughly to prevent noise from apparently reappearing after the installation has been completed.

Electric motors generate a 'whining' sound. Do not forget to check windscreen wipers, electric fuel pumps, heater and air conditioning fans and other motors which operate only on an intermittent basis.

910 automatic tuning mobile antenna - Barrett P/N BC91000

The 910 antenna plugs directly into the rear of a 2050 transceiver using the cables supplied. **Important:-** 2050 transceivers must have the 910 antenna option set during programming.

The 910 antenna should be mounted in positions similar to those illustrated in the diagrams below. Select a position free from excessive vibration. A bracket, fabricated to withstand the forces and vibration that can be expected during off-road driving, should be used to mount the antenna to the vehicle. When locating the mounting position for the antenna ensure that the antenna body, when flexing on its vibration mount, cannot come into contact with other parts of the vehicle. The antenna should be mounted as far from surrounding objects on the vehicle as possible.

Preferred Mounting Positions

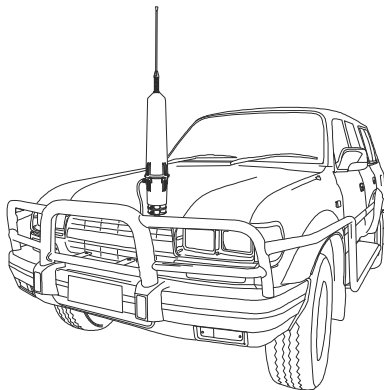
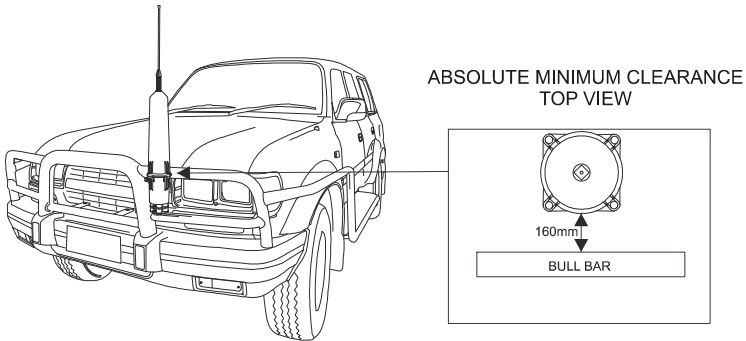

Important:
Please note that the mounting of a 910 Antenna on the front of a vehicle may be considered illegal in some areas/countries. Please check with your local transport/vehicle authority prior to installation on the front of your vehicle.

Acceptable Mounting Positions

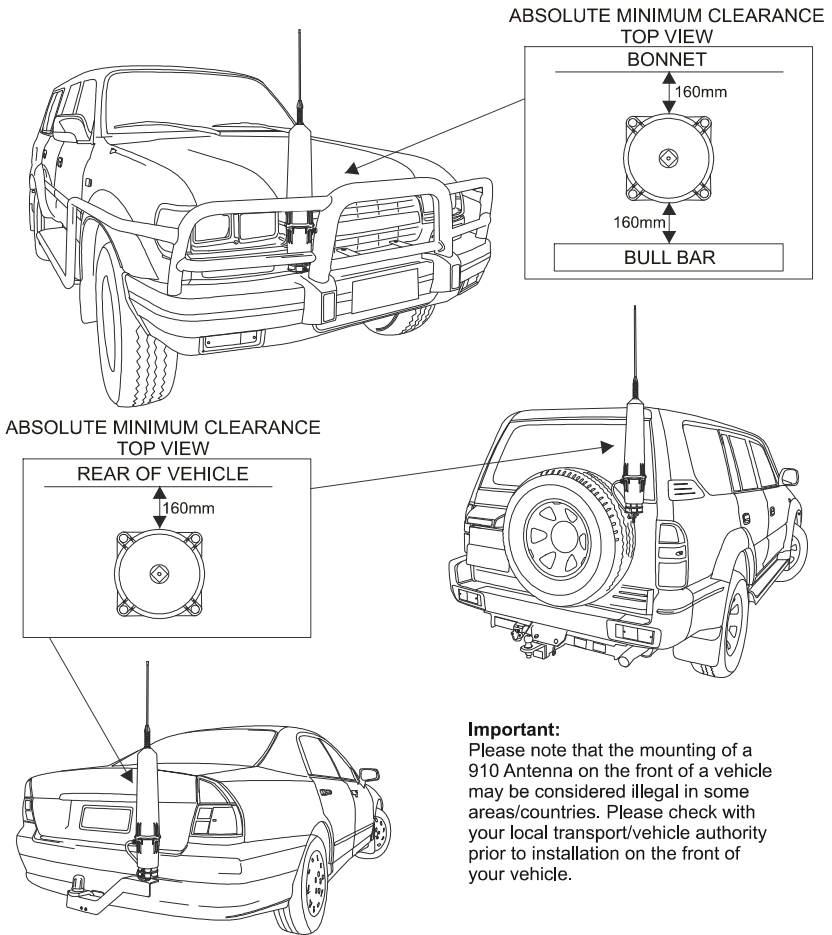

Caution:- Whilst the 910 automatic tuning mobile antenna is designed to withstand vibration to military specifications on tyred vehicles, some mounting positions on large prime-movers, particularly front mounted bull-bars, are subject to vibration that far exceeds this specification. Do not mount the 910 antenna in positions such as these as damage to the antenna may result.

A good earth (ground) to the main body of the vehicle is essential for efficient operation of the antenna. To achieve this clean all joints to bare metal and use copper braid earth straps if any non-metallic joints are encountered.

After mounting the main body of the antenna, screw the black coil onto the antenna body followed by the stainless steel whip.

Note:- Some models of the 910 antenna have a one piece spring and a stainless steel whip in place of the coil and whip.

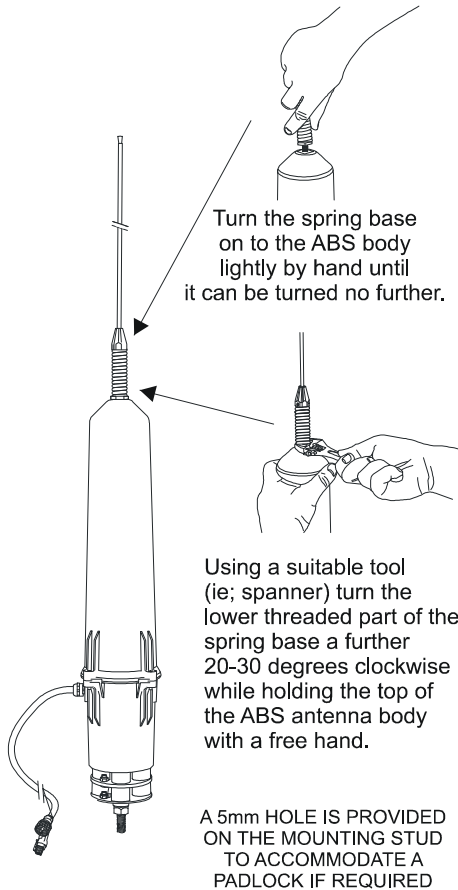

The antenna is supplied with a pre-terminated 1.5 metre cable tail. This should be routed into either the engine compartment or boot (trunk) of the vehicle. A 6 metre pre-terminated extension cable is supplied to connect the antenna to the transceiver (this cable may be extended to 12 metres by use of another extension cable). If the joint between the antenna stub cable and the extension cable is in an exposed position, a butyl rubber self amalgamating tape should be used to seal the joint. Do not wrap this joint if it cannot be made completely water tight as water will collect in the joint and cause it to corrode.

To test the antenna, attach a VSWR meter in line with the coaxial cable at the transceiver. Select any channel on the transceiver and activate PTT or use the tune function # on the transceiver. The antenna should tune (indicated by the sound of relays clattering), within 2 seconds. Use the tune function to check the VSWR of the antenna, it should be less than 2:1. If the tune sequence does not occur check all wiring thoroughly and check that the transceiver is programmed for use with a 510/910 antenna. If the VSWR is not within an acceptable limit check the earth (ground) bonding of the antenna base to the vehicle.

To secure the whip if driving under low objects or for use of the 910 in an NVIS mode (for short range communication) secure the whip as illustrated in the diagram below with the steel wire clip and lanyard supplied.

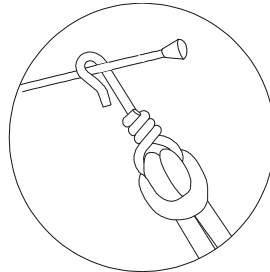
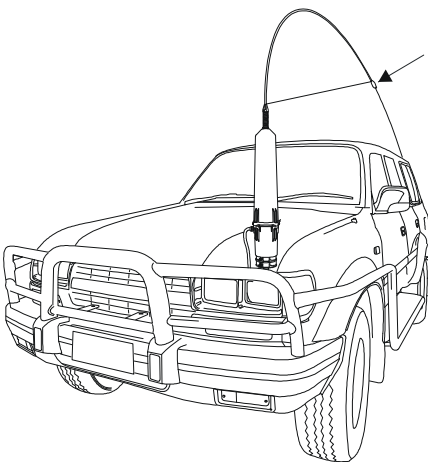

Important:

Please note that the mounting of a 910 Antenna on the front of a vehicle may be considered illegal in some areas/countries. Please check with your local transport / vehicle authority prior to installation on the front of your vehicle.

914 series manual tap whip antenna - Barrett P/N BC91401 to BC91424**Installation**

914 series manual tapped whip antennas are mounted on vehicles using a heavy duty base and spring (Barrett P/N BCA91400). The whip should be mounted on the vehicle in positions such as those illustrated in the diagrams below. A bracket, fabricated to withstand the forces and vibration that can be expected during off-road driving, should be used to mount the antenna base and spring to the vehicle. When locating the mounting position for the antenna, the ring located above the label at the bottom of the whip should be level with the surrounding ground plane, e.g. the bonnet of the vehicle or the roof of the vehicle. Ensure that the mounting bolt on the base and spring is electrically bonded to the chassis of the vehicle via a very low resistance path, i.e. clean all joints to bare metal and use braid earth straps if any non-metal joints are encountered. Use only good quality coaxial cable and water proof UHF connectors (such as those supplied by Barrett Communications). **Do not use PL-259 UHF connectors.**

When running the coaxial cable from the antenna to the transceiver avoid sharp corners and heat such as that generated by the manifold of the engine. After installing the antenna check the antenna VSWR on each channel. Generally if the antenna has been mounted in the positions as illustrated, the VSWR will be less than 1.6:1 and no adjustment is necessary. If the VSWR is not lower than 2:1 the antenna to ground capacitance in that installation is probably outside of the design range of the factory set tuning. Consideration may be given to retuning the whip if the VSWR is so high as to cause the transmitter ALC system to begin to reduce power (to protect the transmitter).

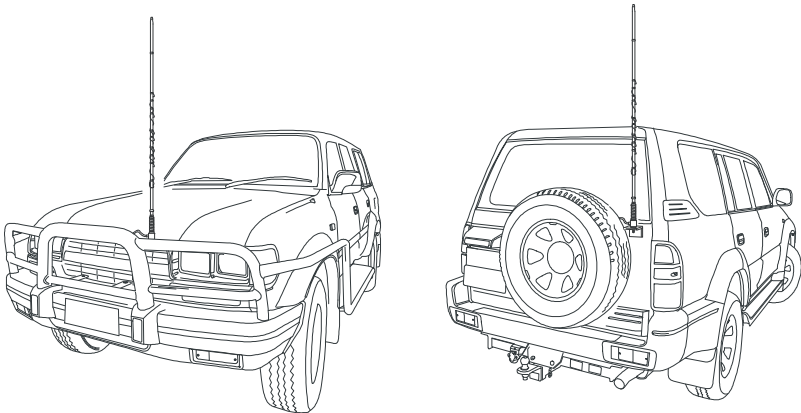

For each frequency which will not tune correctly you will need to determine whether the tuning is high or low in frequency. Generally any frequencies which will not tune will always be out the same way. When the antenna is made most frequencies are deliberately made on the low frequency side and adjusted upwards by the placement of "tuning rings". Tuning rings are single short circuit rings of 20 amp fuse wire placed on the windings of an individual part of the antenna. A tuning ring inductively raises the frequency of the section of antenna over which it is placed. It must be understood that the tuning of an antenna on a particular vehicle or installation may not hold for other vehicles or installations. To determine whether any particular frequency tap is high or low hold the tune key down on the relevant frequency and observe the VSWR on a suitable meter. Get an assistant to slowly move his outstretched arm closer to the antenna tap in use.

If the VSWR gets better then the antenna is too high in frequency. This indicates that there is insufficient antenna to ground capacity. Usually this happens when the antenna is mounted too far away from the body of a vehicle. Either re-site the antenna closer to the vehicle or remove any tuning rings which are already on the antenna.

If the VSWR gets worse when following the above procedure then too much capacity is already present, this is frequently encountered when mounting the antenna too low on a vehicle bumper bar or when mounting close to bodywork as in cab-over type vehicles. In this case either re-site the antenna further away or add extra tuning rings to the frequency sections affected until a suitable VSWR is obtained.

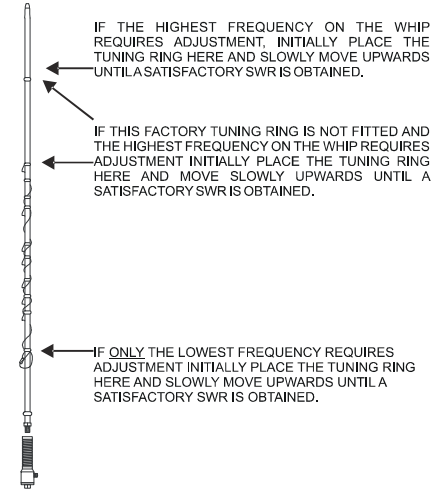

Note:-Truck cab-over installations usually produce distorted radiation patterns even when the VSWR looks good.

When tuning is complete any new rings added should be coated with epoxy resin to secure and protect the ring from damage. Five minute quick setting type epoxy is suitable. If rings need to be removed they may be cut off using a sharp pair of side cutters. Take care not to cut into the body of the antenna.

Note:- If the wander lead is damaged or lost and requires replacing, the number on the first tap indicates the length of the replacement wander lead required.

Example:- W1-60 indicates the length of the wander lead was 60cm. When making a replacement wander lead ensure it is made to this length to obtain optimum performance.

Operation Instructions

The 914 manual tapped whip antenna should now be screwed into the base and spring mounted on the front of the vehicle.

The **operation frequency being used on the transceiver should now be selected on the antenna**. This is done with the supplied jumper lead as indicated in the diagram below and the following example (Note:- this is an example only and your antenna will be manufactured with different frequency taps.)

The 914 manual tapped whip antenna used in the example has the following frequencies:-

Channel 1	4030 kHz	Channel 2	4760 kHz
Channel 3	5190 kHz	Channel 4	5254 kHz
Channel 5	7180 kHz	Channel 6	8199 kHz
Channel 7	9134 kHz	Channel 8	9145 kHz
Channel 9	10567 kHz	Channel10	14567kHz

Illustrated is a 10 frequency 914 manual tapped whip antenna with the highest frequency being selected.

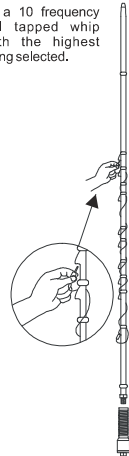

When using **Channel 1**, frequency **4030kHz**, the jumper lead should be removed from the bottom antenna socket and stored in the vehicle.

On all other channels the jumper lead is required:-

For **Channel 2**, frequency **4760kHz**, the jumper is plugged into the bottom socket then wound tightly around the antenna and the other end plugged into the socket marked **4760**.

For **Channel 3**, frequency **5190kHz**, the jumper is plugged into the bottom socket then wound tightly around the antenna and the other end plugged into the socket marked **5190**.

And so on to **Channel 10**.

Note:- It is important for correct operation of the whip antenna to have the right frequency tap selected as indicated above and that the jumper lead is wrapped tightly around the antenna between sockets.

Marine Installations

General

The Barrett 911 automatic antenna tuner is designed for use in land base station and maritime HF services. Primarily designed for operation with end-fed unbalanced antennas such as whips and long-wires, the tuner is built in a waterproof impact resistant, moulded ABS plastic enclosure.

Antenna selection

The 911 automatic antenna tuner will operate into almost any end-fed antenna with a length exceeding 2.5 metres, providing an effective ground (earth) is used. The antenna efficiency will be proportional to the length of the antenna and will be maximum when the length of the antenna approaches $1/4$ wavelength. It is advisable to limit the wire antenna to $1/4$ or $3/4$ wavelength at the highest frequency to be used.

Antenna

On sailing vessels the antenna can either be an insulated backstay or a whip antenna mounted vertically, usually on the stern. Best performance will be achieved by using an insulated backstay as the radiating length will be longer than that available when using a whip. The top insulator on the backstay should be approximately 300 mm from the mast and the bottom insulator should be at eye level above the deck. The distance between insulators should be greater than 10 metres and less than 35 metres. A whip antenna is generally used on small to medium sized power vessels. There are different length whips to suit the vessel length.

Transceiver and tuner mounting

Select a suitable position in the vessel to mount the transceiver. It should be a position that is out of the weather and easily accessible to the operator, whilst as close as practical to the 13.8V DC power source. Mount the transceiver to a solid fixing point using the mounting cradle. Make sure there is sufficient space at the rear of the transceiver to connect the power and antenna cables.

The antenna tuner should be mounted as close to the antenna feed point as possible. In metal vessels the length of the feeder from the antenna tuner to the feed-through insulator, inside the vessel, should be kept less than 1 metre.

The antenna feed cable should be a suitable high voltage cable. Care should be taken to avoid sharp points when terminating the cable to prevent corona discharges.

The interconnect cable supplied with the antenna tuner should be routed away from other cables back to the transceiver and connected as indicated in the diagram overleaf.

Ground (earth) system

The ground (earth) system is a key part of the overall antenna system and consequently the system operation. An inadequate ground system is the primary cause of poor performance and tuning problems. There is little point in installing the antenna unless a good ground system can be provided.

Metal hulled vessels provide an almost perfect ground. The tuner ground terminal should be connected directly to the hull using the shortest possible ground strap. The point of connection to the hull should be prepared so that it is free of paint and rust to ensure a good contact area with minimum electrical resistance.

Wooden or fibreglass vessels present more of a problem to ground. Ideally the vessel should be fitted with an external copper ground sheet, connected to the interior of the vessel by suitable stud or an earth plate ("E" plate Barrett P/N BCA91700)

If the vessel is yet to be constructed, then in the case of fibreglass vessels a thin copper sheet with an area of not less than 4 square metres should be moulded into the hull during lamination. A suitable heavy strap should be connected to the sheet and left free for earth connection.

Should neither of these methods be available it will be necessary to bond as many large metallic objects, such as the engine and propeller shaft, together to form a ground.

Whichever method is used the ground run from the ground system to the antenna tuner should be as short as possible and use copper strap at least 50mm wide (wider if available). Consideration must always be given to the problem of electrolysis. Severe structural damage may occur if electrolysis is present.

Corrosion

All connections in marine situations are subject to corrosion and oxidation. To minimise this all joints should be cleaned and have silicon grease applied before assembly. Under severe conditions joints should be protected with self vulcanising rubber tape.

Connection details - 2050 transceiver and 911 automatic antenna tuner in a marine installation.

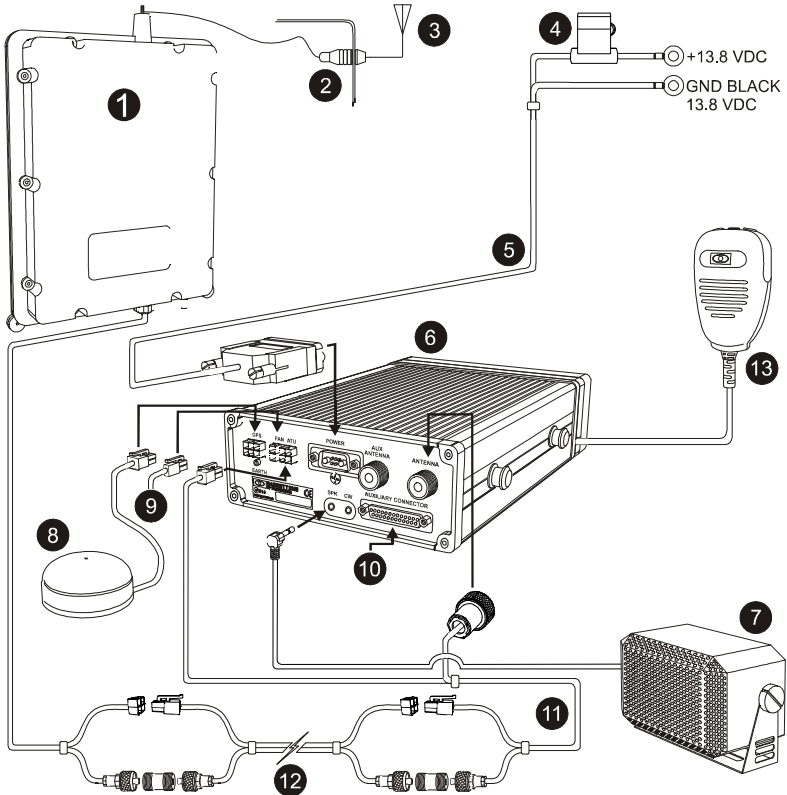

- | | | | |
|---|-----------------------------------------------------------|----|------------------------------------------------------------------------|
| 1 | 911 automatic antenna tuner | 8 | External GPS receiver option |
| 2 | Feedthru insulator P/N BCA91701 (If required) | 9 | Connection for external fan unit option |
| 3 | Antenna | 10 | Auxiliary connector |
| 4 | Heavy duty fuse & holder P/N BCA20021 | 11 | Coaxial/control cable P/N BCA90032 |
| 5 | 6 metre power cable supplied with transceiver | 12 | Optional 6 or 10 metre extension cable with connectors P/N BCA90032/40 |
| 6 | 2050 transceiver body | 13 | Microphone |
| 7 | Extension speaker supplied standard with 2050 transceiver | | |

Electrical checkout

After mechanical installation is complete select the highest frequency to be used on the transceiver. A directional watt-meter such as a Bird Model 43 should be inserted in the coaxial transmission line between the transceiver and the tuner. The tune mode on the transceiver is then energised (refer to the transceiver user manual). Upon application of RF energy, the tuner should start to tune, indicated by the 'clattering' of the tuner relays. After a few seconds the relay noise will cease. The transceiver should indicate a successful tune and the watt-meter reflected power should indicate a low value consistent with a VSWR of better than 2:1. If the cover of the tuner is removed the PCB mounted 'tuned' LED should be illuminated. Now select the lowest desired frequency on the transceiver and repeat the above procedure. The result should be the same, except that the tune cycle may take somewhat longer. If the above procedure does not give the results as indicated check that the antenna length and connections are correct and re-check all ground (earth) connections.

Note:- When received, the Barrett 911 automatic antenna tuner memory system will usually not have any pre-stored tuning information appropriate to your installation. To allow the 911 to 'learn' it's tuning information simply proceed from one channel to the next allowing the normal tune cycle to take place. Each successful tune is 'memorised' so that when that channel is re-selected the tuner will almost instantaneously retune to that frequency.

Connectors

Note:- All connectors below viewed looking at the rear of the transceiver

GPS connector

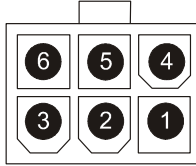

1	NMEA -	-12 VDC data input NMEA 0183 format
2	+5V	+5 VDC supply max 75mA
3	NMEA +	+12 VDC data input NMEA 0183 format
4	Ground	Ground 0V
5	1PPS	1PPS timing pulse TTL level from GPS
6	GPS RX	GPS TTL data input

Fan connector



1	+13.8VDC
2	Fan control - active low

Automatic antenna

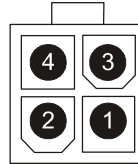

1	Tune initiates tune 911, preamp active low 910
2	+ 13.8VDC (interrupted for 910 tune initiate)
3	Tuned -tune successful low going pulse.
4	Ground 0V

Power connector

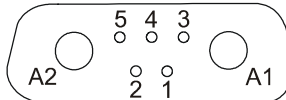

1	Fan control out	Active low 0V
2	Speaker out	External speaker 0-10V
3	N/C	
4	N/C	
5	N/C	
A1	+13.8 VDC input	+13.8 VDC
A2	-13.8 VDC/Ground	13.8VDC/Ground

Auxiliary connector (25 pin female "D" connector on rear panel)

Pin	Name	Description of function	Level
1	Ground	Ground	0V
2	Rx Data	RS-232 data input	True RS-232
3	Tx Data	RS-232 data output	True RS-232
4	External Power On	For use with ancillary equipment.	Low to activate
5	External Speaker	External speaker output	0-10V
6	Aux dig in 0	Future use	Active low 0V
7	RS-232 Gnd	RS-232 Ground	0V
8	ALC In	Ext. ALC from Linear Amp	0-10V
9	PTT In	Auxiliary PTT input	Active low 0V
10	Aux dig in 1	Scan stop input from external modem	Active low 0V
11	Bal. Tx Audio In	Balanced Tx audio input (with pin 24)	600 Ω -24dBm to 0dBm
12	Bal. Rx Audio Out	Balanced Rx audio output (with pin 25)	600 Ω -6dBm to +9dBm
13	Ground	Ground	0V
14	Aux dig out 0	Linear LPF select	Active low 0V
15	Aux dig out 1	Linear LPF select	Active low 0V
16	Aux dig out 2	Linear LPF select	Active low 0V
17	Aux dig out 3	Linear LPF select	Active low 0V
18	Aux dig out 4	Linear LPF select /Selcall alarm	Active low 0V
19	Aux dig out 5	Linear LPF select /Audio mute	Active low 0V
20	Aux dig in 2	Future use	Active low 0V
21	PTT / C-Mute	PTT Out / Receiver Cross Mute	Active low 0V
22	Not Used	Not Used	
23	+13.8 V Fused Out	+13.8V Output to power auxiliary equipment	13.8V @ 2 Amp.
24	Bal. Tx Audio In	Balanced Tx audio input (with pin 11)	600 Ω -24dBm to 0dBm
25	Bal. Rx Audio Out	Balanced Rx audio output (with pin 12)	600 Ω -6dBm to +9dBm

Note 1:- Pin 18 and Pin 19 – Function depends on programming:- If Linear Amplifier selected in I/O configuration these lines are programmed to control the linear LPF selection of 2075 linear amplifiers. Otherwise Pin 18 becomes the Selcall alarm output pin and pin 19 follows the audio mute condition.

Note 2:- Balanced Rx audio out on Pin 25 and Pin 12 can be un-muted or follow the audio mute depending on the configuration in the protected menu "I/O section"

Overview of HF Operation

HF (High Frequency) is the radio spectrum with frequencies between 1.6 and 30MHz. Within this radio spectrum an efficient form of transmitter modulation, SSB (Single Side Band), is used. This, combined with the use of the ionosphere - a layer of ionisation gases that resides between 100 and 700km above the earth's surface, provides efficient, cost effective communications over short, medium and long distances - without the need for expensive re-transmission devices, such as the VHF or UHF repeaters or satellites, all of which have on going operational costs and a reliance on a physical infrastructure.

In many remote areas, HF/SSB is the only form of communication possible.

HF propagation

When HF/SSB radio waves are generated by the transceiver there are usually two components:-

- The ground-wave, which travels directly from the transmitting antenna to the receiving antenna following the contours of the earth.
- The sky-wave, which travels upward and at an angle from the antenna, until it reaches the ionosphere (an ionised layer high above the earth's surface), is refracted back down to earth, to the receiving antenna.

Generally speaking, ground-wave is used to communicate over shorter distances usually less than 50km. Because ground-wave follows the contours of the earth, it is affected by the type of terrain it passes over. Ground wave is rapidly reduced in level when it passes over heavily forested areas or mountainous terrain.

Sky-wave is used to communicate reliably over medium to long distances up to 3,000km. Whilst the nature of sky-wave propagation means it is not affected by the type of terrain as in ground waves it is affected by factors involving the ionosphere as described below.

Radio wave propagation illustrated

The following illustrations show the characteristics of ground-wave and sky-wave propagation during day and night time. In each illustration the height of the ionosphere above the ground is shown.

In both illustrations Station A communicates with Stations B, C and D. Propagation from Station A to B is by ground-wave. The diagrams illustrate that the ground wave is not affected by the time of day and the height of the ionosphere above the ground.

Propagation from Station A to C and D, however, is by sky-wave and as the diagrams illustrate the sky wave is significantly affected by the time of day and the height of the ionosphere above the ground.

Under each diagram there are recommended working frequencies listed. Please note that these will vary according to time of year and other factors. They are intended only as a guide and are subject to change.

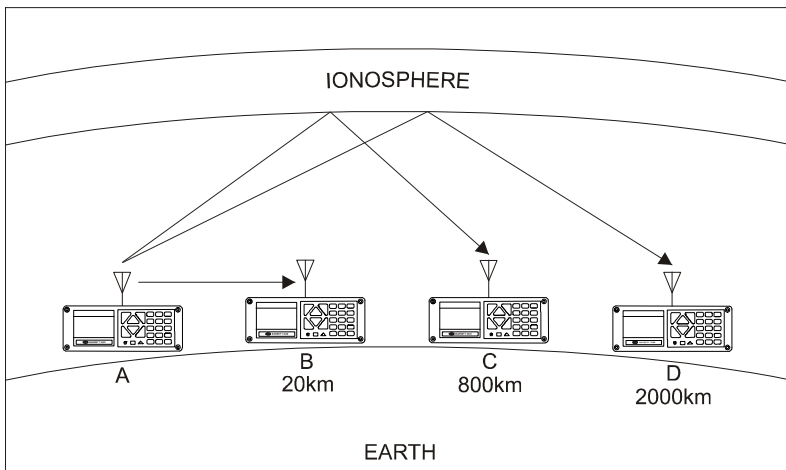
Day

The sun is higher, the ionosphere is higher, the best frequency to use is higher

- A to B - Possible optimum working frequency is 3 MHz
- A to C - Possible optimum working frequency is between 7 - 9 MHz
- A to D - Possible optimum working frequency is between 13-16 MHz

Night

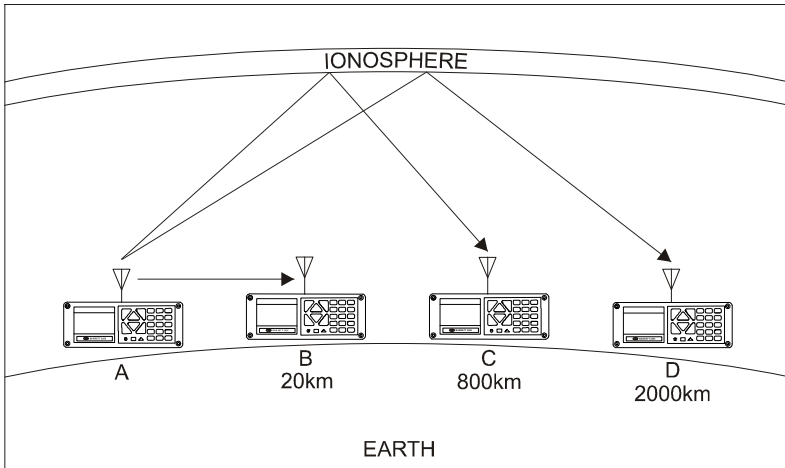

The sun is lower, ionosphere is lower, best frequency to use is lower

A to B - Possible optimum working frequency is 3 MHz

A to C - Possible optimum working frequency is between 5 - 7 MHz

A to D - Possible optimum working frequency is between 9 - 12 MHz

Factors which affect HF/SSB communications

There are a number of different factors which will affect the success of your communications via HF/SSB radio. These are outlined below:-

Frequency selection

Frequency selection is perhaps the most important factor that will determine the success of your HF/SSB communications.

Generally speaking the greater the distance over which you want to communicate, the higher the frequency you should use.

Beacon Call, a Selcall (selective call) function built into the Barrett 950 transceiver, makes finding the correct frequency to use easy. Beacon Call is based on the network transceivers all having a selection of frequencies that will accommodate most ionospheric conditions. When in standby the network transceivers scan these frequencies waiting for a call (Selcall or Beacon Call) from another transceiver. The transceiver wishing to check for the best frequency to operate on sends a Beacon Call to the station he wishes to contact. If his call to the other station is successful he will hear a revertive call from the station he is calling, indicating the channel he selected was suitable for the ionospheric conditions prevailing. If he does not hear this revertive call or it is very weak, he tries on another channel until a revertive call of satisfactory signal strength is heard.

(Refer to Selcall (selective call) section of this manual for full details on Beacon Call operation.)

Time of day

As a rule, the higher the sun, the higher the frequency that should be used. This means that you will generally use a low frequency to communicate early morning, late afternoon and evening, but you will use a higher frequency to cover the same distance during times when the sun is high in the sky (e.g. midday). You will need to observe the above rule carefully if your transceiver has a limited number of frequencies programmed into it, as you may only be able to communicate effectively at certain times of the day.

Weather conditions

Certain weather conditions will also affect HF/SSB communications. Stormy conditions will increase the background noise as a result of 'static' caused by lightning. This background noise could rise to a level that will blank out the signals you are trying to receive.

Man-made electrical interference

Interference of an electrical nature can be caused by overhanging power lines, high power generators, air-conditioners, thermostats, refrigerators and vehicle engines, when in close proximity to your antenna. The result of such interference may cause a continuous or intermittent increase in the level of background noise.

System configuration and installation

The method in which your system is configured and installed will also affect the success of your HF/SSB communications. Your choice of antenna system and power supply is critical. Correct installation is also extremely important. An HF/SSB transceiver is generally installed using different rules to those used to install VHF or UHF transceivers. Failure to correctly install an HF/SSB system will greatly affect the communications quality you will obtain. Refer to the installation section of this manual for details.

Your local Barrett representative will be able to assist with your system configuration and/or installation.

Special note - HF communications compared with VHF or UHF short distance communications

Communications on any HF/SSB transceiver will sound different to that on a VHF (Very High Frequency) radio or UHF (Ultra High Frequency) radio or telephone. This is because of the nature of HF propagation and the modulation methods used. On HF/SSB transceivers there will always be background noise evident behind the signal you are receiving and this will increase when there is electrical interference or thunderstorm activity in the area.

Limited 3 Year Warranty

Barrett Communications Pty Ltd provides a maximum three year warranty on all equipment it manufactures which is to be used expressly for high frequency, single sideband radio communications. This warranty covers faults arising from defects in design, workmanship or materials. Please note that this warranty does not cover batteries.

Should any fault due to bad design, workmanship or materials be proven at any time within the warranty period, the company will rectify such fault free of charge providing the equipment is returned freight paid to Barrett Communications Pty Ltd or to an authorised service centre. The warranty period for all products is twelve months after shipment from the factory or an authorised Barrett agent or dealer. In the event that the end user completes and lodges warranty registration documents within three months of receipt of the shipment from the factory or an authorised Barrett agent or dealer, the warranty period shall be extended by an extra twenty four months giving a total warranty period of three years.

This warranty shall not cover any abuse, accident, improper installation, connection, adjustment or use other than in accordance with the instructions issued by the company.

In addition, this warranty shall not cover the distance which transceiver products will operate over or quality of transmission or reception as a result of unfavourable environmental conditions. Nor shall this warranty cover the quality of transmission and reception of transceivers mounted in vehicles or vessels that have not been sufficiently electrically suppressed.

Subject to the matters set out in this warranty, no liability, expressed or implied is accepted for any consequential loss, damage or injury arising as a result of a fault in the equipment and, all expressed or implied warranties as to quality or fitness for any purpose are hereby excluded.

This warranty does not extend to products supplied by the company which are not designed or manufactured by it. Barrett Communications Pty Ltd will however make every endeavour to ensure that the purchaser receives full benefit on any warranty given by the manufacturer.

This warranty is restricted to the original purchaser. Where the original purchaser is a reseller who has purchased for the purpose of resale, warranty shall be extended to the reseller's customer.

Warranty registration and customer support

Thank you for purchasing Barrett HF communications products.

The standard and automatic warranty on Barrett products is one year. By completing the registration form on the next page and sending it to us by mail, fax or email, this warranty will be extended to a total of three years at no extra cost.

By registering for the extended warranty period Barrett Communications will also provide the following services:-

Your contact details will be registered against the serial numbers of the equipment.

Barrett Communications will keep you informed of any developments relating to this equipment.

Barrett Communications will provide you with direct access to a support telephone contact line manned from 0000hrs GMT to 1600 Hrs GMT, 7 days a week.

The registration forms can be returned by mail, (no postage stamp required in Australia) or by facsimile (08) 9418 6757 (International + (618) 9418 6757).

If you have access to the Internet you can use the warranty registration page in the support section of our website to register your warranty form. Please go to www.barrettcommunications.com.au

We will mail or email you if you have registered via the Internet details of your support package within 7 days of receiving your completed registration form.

Barrett Communications is proud of its reputation for support of its customers. This registration process has been introduced so that we may continue to improve our level of support to you.