



INSTRUCTION MANUAL

UHF TRUNKED RADIOS

IC-F43GT/GS
IC-F44GT/GS

Icom Inc.



IMPORTANT

READ ALL INSTRUCTIONS carefully and completely before using the transceiver.

SAVE THIS INSTRUCTION MANUAL — This instruction manual contains important operating instructions for the **IC-F43GT/GS, F44GT/GS UHF TRUNKED RADIOS**.

EXPLICIT DEFINITIONS

WORD	DEFINITION
⚠ DANGER	Personal death, serious injury or an explosion may occur.
⚠ WARNING	Personal injury, fire hazard or electric shock may occur.
CAUTION	Equipment damage may occur.
NOTE	If disregarded, inconvenience only. No risk of personal injury, fire or electric shock.

Icom, Icom Inc. and the Icom logo are registered trademarks of Icom Incorporated (Japan) in the United States, the United Kingdom, Germany, France, Spain, Russia and/or other countries.

PRECAUTIONS

⚠ **CAUTION! NEVER** hold the transceiver so that the antenna is very close to, or touching exposed parts of the body, especially the face or eyes, while transmitting. The transceiver will perform best if the microphone is 5 to 10 cm away from the lips and the transceiver is vertical.

⚠ **CAUTION! NEVER** operate the transceiver with a headset or other audio accessories at high volume levels.

⚠ **CAUTION! NEVER** short the terminals of the battery pack.

DO NOT push PTT when not actually desiring to transmit.

DO NOT use or place the transceiver in direct sunlight or in areas with temperatures below -25°C or above $+55^{\circ}\text{C}$.

The basic operations, transmission and reception of the transceiver are guaranteed within the specified operating temperature range. However, the LCD display may not be operate correctly, or show an indication in the case of long hours of operation, or after being placed in extremely cold areas.

DO NOT modify the transceiver for any reason.

KEEP the transceiver from the heavy rain, and **Never** immerse it in water. The transceiver construction is **water resistant**, not waterproof.

The use of non-Icom battery packs/chargers may impair transceiver performance and invalidate the warranty.

Icom optional equipment is designed for optimal performance when used with this transceiver. We are not responsible for the transceiver being damaged or any accident caused when using non-Icom optional equipment.

TABLE OF CONTENTS

IMPORTANT	i	■ Voice scrambler	25
EXPLICIT DEFINITIONS	i	■ DTMF operation	25
PRECAUTIONS	i	■ Compander function	25
TABLE OF CONTENTS	iii	6 USER SET MENU	26–27
1 ACCESSORIES	1–3	■ User set menu	26
■ Supplied accessories	1	7 TALK AROUND	28
■ Accessory attachments	1	8 PROGRAMMABLE FUNCTIONS	29–30
2 PANEL DESCRIPTION	4–6	■ Programmable function keys	29
■ Front panel	4	9 OPTIONAL UNIT INSTALLATION	31
■ Function display	6	■ UT-109 and UT-110 installation	31
3 BASIC OPERATION	7–20	10 BATTERY CHARGING	32–36
■ General	7	■ Caution	32
■ Calling	8	■ Optional battery chargers	34
■ Calling with the keypad (10-key version only)	12	11 OPTIONAL BATTERY CASE	37
■ Special call with the keypad	17	■ Battery case (BP-240)	37
■ Receiving a call	17	12 OPTIONAL SWIVEL BELT CLIP	38–39
4 DISPLAYING MESSAGES	21	■ MB-93 contents	38
5 OTHER FUNCTIONS	22–25	■ Attaching	38
■ PTT quick call	22	■ Detaching	39
■ Call back function	22	13 OPTIONS	40–41
■ Calling station ID indication for group call	23	14 DOC	42
■ System lock function	24		
■ Call code memory	24		
■ Automatic transmit output power selection	24		
■ Power ON security	24		

■ Supplied accessories

The following accessories are supplied:	Qty.
① Flexible antenna.....	1
② Battery pack.....	1
③ Belt clip	1
④ Unit cover (double-sided tape)*.....	1
⑤ Jack cover (with screws).....	1 set

*Use the unit cover as a spare. Ask your dealer for details.

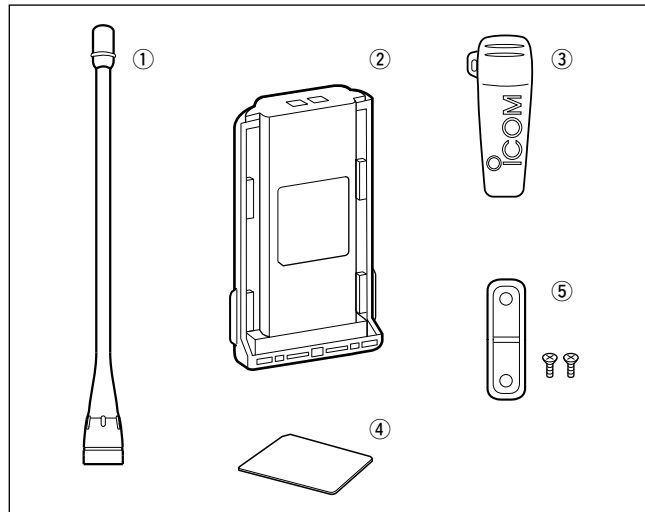

■ Accessory attachments

◇ **Flexible antenna**
Connect the supplied flexible antenna to the antenna connector.

CAUTION:

- **NEVER HOLD** the antenna when carrying the transceiver.
- Transmitting without an antenna may damage the transceiver.

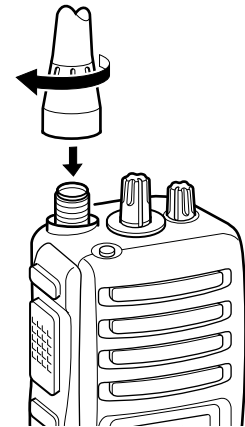

1 ACCESSORIES

◇ Battery pack

To attach the battery pack:

Slide the battery pack in the direction of the arrow (❶), then lock it with the battery release button.

- Slide the battery pack until the battery release button makes a 'click' sound.

To release the battery pack:

Push the battery release button in the direction of the arrow (❷) as shown below. The battery pack is then released.

NEVER release or attach the battery pack when the transceiver is wet or soiled. This may result water or dust getting into the transceiver/battery pack and may result in the transceiver being damaged.

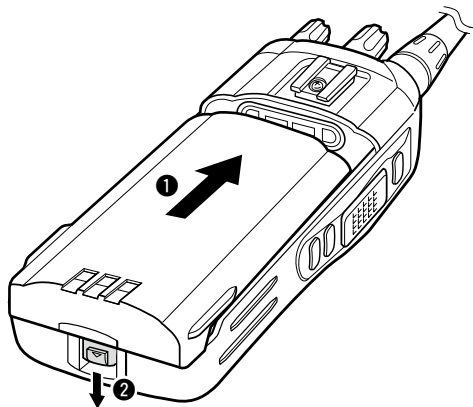

◇ Belt clip

To attach the belt clip:

- ❶ Release the battery pack if it is attached.
- ❷ Slide the belt clip in the direction of the arrow until the belt clip is locked and makes a 'click' sound.

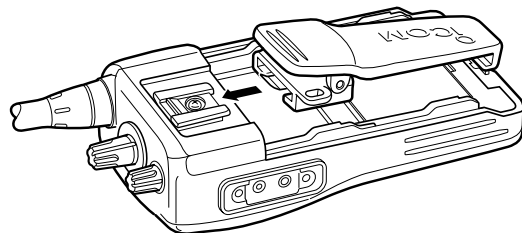

To detach the belt clip:

- ❶ Release the battery pack if it is attached.
- ❷ Pinch the clip (❶), and slide the belt clip in the direction of the arrow (❷).

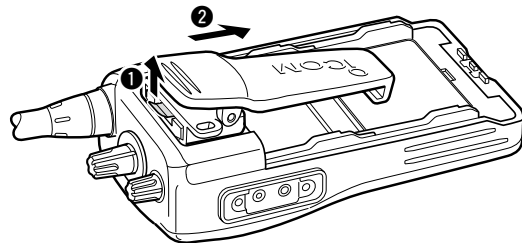

◇ Jack cover

Attach the jack cover when the optional speaker-microphone is not used.

To attach the jack cover:

- 1 Attach the jack cover on the [SP]/[MIC] jack.
- 2 Tighten the screws.

To detach the jack cover:

- 1 Unscrew the screws with a Phillips screwdriver.
- 2 Detach the jack cover for the speaker-microphone connection.

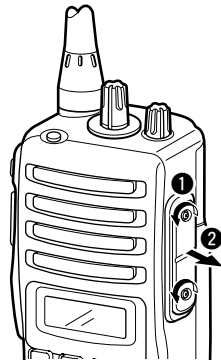
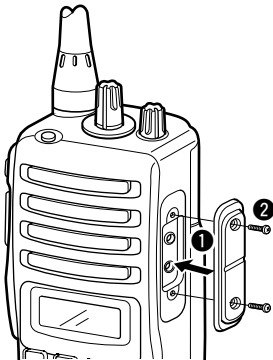

■ Front panel

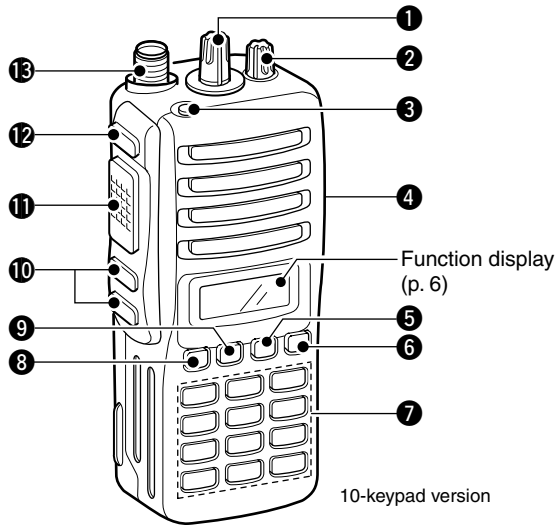

1 GROUP SELECTOR

Rotate to select the pre-programmed group code channel.

2 VOLUME CONTROL [VOL]

Rotate to turn the power ON/OFF and adjusts the audio level.

3 EMERGENCY KEY [RED]

- Push and hold for 2 sec. to start the emergency call to the specified number (Emergency call; p. 15).
- “EMERGENCY” is displayed while pushing and holding.

4 [SP]/[MIC] JACK

Connect the optional speaker-microphone.

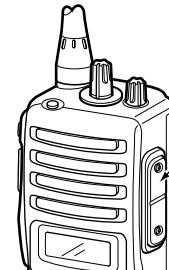

[SP]/[MIC] jack cover

NOTE: Attach the [SP]/[MIC] jack cover when the optional speaker-microphone is not used. (See p. 3 for details)

5 MODE KEY [P2] (p. 28)

Push to toggle between conventional and trunking operation modes.

6 HIGH/LOW KEY [P3]

Push to toggle the transmit output power.

- When automatic power selection is enabled for trunking mode operation, the transmit output power cannot be selected with this key.

7 10-KEYPAD (Depending on version)

The keypad allows you to enter digits to:

- Set TX codes
- Set DTMF codes (during transmit)
- Input text message for SDM operation
- Start up with the password

8 DESPATCHER KEY [P0] (p. 10)

- Push to display despatcher call conditions.
- Push again to display the status code, if permitted.
- Push again to return to stand-by condition.

9 CALL BACK KEY [P1] (p. 22)

- Push to display the received call record (call back memory) that had not replied.
- Push again to return to stand-by condition.
- Push and hold for 2.5 sec. to toggle the call back mode ON and OFF.
 - When the call back mode is set to ON, the received call is stored into record (log), and the call back message is send back to the calling station automatically.

10 UP/DOWN KEYS

- Push to select the call memory channel.
- Push to select the call back memory channel.
- Push to select the status channel.
- Push to select the operating channel. (Conventional mode operation only)
- Push to select the setting value or condition during user set mode.

- Push to erase the previously entered digit number (functions as back space key) during dialing number entering from the keypad. (10-key version only)

11 PTT SWITCH [PTT]

- Push to making a call with the displayed dialing number.
- When selecting a traffic channel for communication, or conventional mode, push to transmit.
- When an individual call is received, push to reply the call.

12 CLEAR (SET MODE) KEY (pgs. 8, 26)

- Push to finish the communication.
- Push and hold to enter to the user set menu.
- During some function operation, push to return to stand-by condition.

13 ANTENNA CONNECTOR

Connects the supplied antenna.

/// Desired functions can be programmed into the [P0] to [P3], [Red], [Clear], [Up] and [Down] keys independently by your dealer. (p. 29)

2 PANEL DESCRIPTION

■ Function display

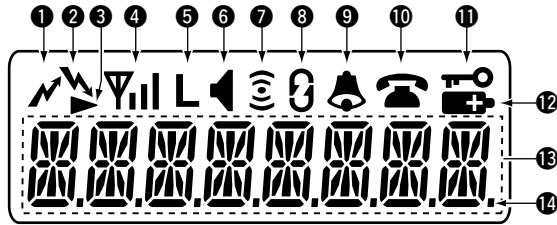

1 TRANSMIT INDICATOR

Appears while transmitting.

2 BUSY INDICATOR

Appears while the channel is busy.

3 OVER-FLOW INDICATOR

Appears when the received SDM including more than 9 characters is displayed.

4 SIGNAL STRENGTH INDICATOR

Appears when receiving a signal and shows the signal strength levels in 4-steps.

- No bars appear and “Ψ” blinks when the transceiver is in out-of-service area. For stable communications, the transceiver should be in the area that the S-meter indicator shows the full scales (3 bars) indication.

5 LOW POWER INDICATOR

Appears when low output power is selected.

- When the battery power decreases to a specified level, low power is selected automatically.

6 AUDIBLE INDICATOR

Appears when the voice communication can be performed.

7 COMPANDER INDICATOR

Appears when the compander function is activated.

- The compander function improves communicating audio quality.

8 SCRAMBLER INDICATOR

Appears when the voice scrambler function is activated.

9 CALL BACK INDICATOR

- Blinks when an individual call is received.
- Appears when individual calls that the call back operation has not been performed are available.
- Disappears when replies to all individual calls.

10 PRIMARY NETWORK INDICATOR

Appears when the transceiver is in the primary network service area.

11 KEY LOCK INDICATOR

Appears when the key lock function is turned ON.

12 BATTERY INDICATOR

Appears or blinks when the battery power decreases to a specified level.

13 ALPHANUMERIC DISPLAY

Shows dialing number and received message, etc.

14 SYSTEM LOCK INDICATOR

Appears when the system lock function is in use.

■ General

Rotate [VOL] to turn the transceiver power ON. Beeps sound, and the following contents will be displayed in sequence.

- **Opening text**

- **Prefix code** (3-digit)/**Fleet code** (4-digit)

- **Individual code** (2 or 3-digit)

- **Memory group code (or text name)**

- The selected memory group code (selected by [Group selector]) and “▼” are displayed when the transceiver is in the trunking service area, and the desired call can be made. (The text name is displayed if programmed instead of the group code.)
- “▼” blinks when the transceiver is in out-of-service area, or the system is fall down. The transceiver searching for an operatable system base in this case.
- “☎” appears when the control signal from the base station that the system ID (AAD number) is registered in primary network.

e.g.: When the Prefix code is ‘201,’ Fleet code is ‘2001,’ Individual code is ‘300’ and Group code is ‘90,’ “201/2001”, “300” and “90” are displayed in sequence after turning the transceiver ON.

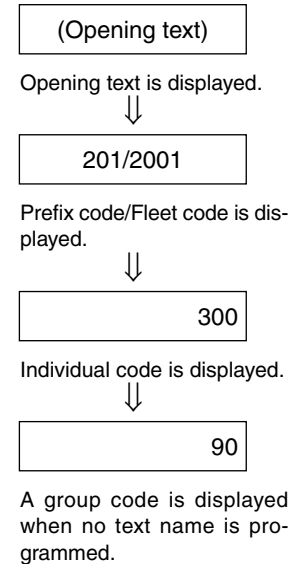

3 BASIC OPERATION

■ Calling

The following call operations can be performed using the pre-programmed dialing number.

◇ Group call

Select the desired group code that is stored in the memory using [Group selector] or [Up]/[Down].

Up to 16 group codes with [Group selector], up to 40 group codes with [Up]/[Down] can be selected.

- ① Rotate [Group selector] or [Up]/[Down] to select the desired group code.

GROUP 1

The pre-programmed text name is displayed.

90

When no text name is programmed, a group code is displayed.

- ② Push [PTT] or [Call Set Up] to make a group call.
 - “CALLING” is displayed and the calling beeps sound.

CALLING

- ③ When the call is succeeded, “CONNECT” and “◀” appear, and communication can be made.
 - The communication timer starts count down at the same time. (When no transmission time limit is set, the timer counts up.)

CONNECT

TIM 0 56

- ④ The warning beeps sound 10 sec. before the communication timer is activated.
 - The communication is disconnected automatically when the communication timer is activated.
- ⑤ Push [Clear] to disconnect the communication manually.
 - Pushing [*] and [#] in sequence also disconnect the communication. (10-key version only)

CLR DOWN

◇ Individual call

Select the desired individual code with [Up]/[Down].

- ① Push [Up]/[Down] to select the desired individual code.

PERSON 1

The pre-programmed text name is displayed.

20 302

When no text name is programmed, the dialing number is displayed.

- ② Push [PTT] or [Call Set Up] to make an individual call.

- “CALLING” is displayed and calling beeps sound.

CALLING

- ③ When the call is succeeded, “CONNECT” and “◀” appear, and communication can be made.

- The communication timer starts count down at the same time. (When no transmission time limit is set, the timer counts up.)

CONNECT

TIM 0 56

- ④ The warning beeps sound 10 sec. before the communication timer is activated.

- The communication is disconnected automatically when the communication timer is activated.

- ⑤ Push [Clear] to disconnect the communication manually.

- Pushing [*] and [#] in sequence also disconnect the communication. (10-key version only)

CLR DOWN

3 BASIC OPERATION

◇ **Dispatcher call**

A status is used for the dispatcher call normally, however, the direct dispatcher call can be made according to the setting.

- ① Push [Dispatcher] to select the dispatcher call condition.
 - “DESPATCH” is displayed.

DESPATCH

- ② Push [PTT] or [Call Set Up] to make the dispatcher call.
 - When the direct dispatcher call is inhibited, the status message “0 (call back request)” is transmitted, then returns to stand-by condition.
 - “CALLING” is displayed and the calling beeps sound.

CALLING

- ③ When the call is succeeded, “CONNECT” and “📞” appear, and communication can be made.
 - The communication timer starts count down at the same time. (When no transmission time limit is set, the timer counts up.)

CONNECT

TIM 0 56

- ④ The warning beeps sound 10 sec. before the communication timer is activated.
 - The communication is disconnected automatically when the communication timer is activated.
- ⑤ Push [Clear] to disconnect the communication manually.
 - Pushing [*] and [#] in sequence also disconnect the communication. (10-key version only)

CLR DOWN

◇ Status call

A status message can be sent to the individual or despatcher station.

The status message cannot be sent to a group stations.

• Individual status call

- ① Push [Up]/[Down] to select the desired individual code.

PERSON 1

- ② Push [Status] to enter the status message selection mode.

- ③ Push [Up]/[Down] to select the desired status message from total of 32 messages (code 0 to 31.)

- The status code 0 and 31 are common message in the system.

Code 0 : Call Back Request

Code 31 : Call Cancel

STATUS 1

- ④ Push [PTT] or [Call Set Up] to transmit the selected status message to the selected station.

- “CALLING” is displayed.

CALLING

- ⑤ When the status call is succeeded, “OK” is displayed.

OK

• Despatcher status call

- ① Push [Despatcher] to select the despatcher call condition.
- “DESPATCH” is displayed.

DESPATCH

- ② Push [Despatcher] again to enter a status message selection mode.

STATUS 1

- ③ Push [Up]/[Down] to select the desired status message.

- Available number of messages and code numbers are the same as the Individual status call as at left.

- ④ Push [PTT] or [Call Set Up] to transmit the selected status message to the despatcher.

- “CALLING” is displayed.

CALLING

- ⑤ When the status call is succeeded, “OK” is displayed.

OK

3 BASIC OPERATION

■ Calling with the keypad (10-key version only)

Several call operation can be performed with the following dialing number input (via the keypad) and [#].

⚡ **NOTE:** [PTT] or [Call Set Up] can also be used instead of [#].

◇ Individual call

To the station that has the same prefix and fleet

Enter the desired individual code via the keypad, then push [#] to make the individual call.

e.g.: When the station '201 2001 200' calls the station '201 2001 300';

➡ Push [3], [0], [0] and [#] in sequence.

To the station that has the same prefix, but different fleet

Enter the desired fleet and individual codes via the keypad, then push [#] to make the individual call.

e.g.: When the station '201 2001 200' calls the station '201 2010 300';

➡ Push [2], [0], [1], [0], [3], [0], [0] and [#] in sequence.

To the station that has different prefix

Enter the desired prefix, fleet and individual codes via the keypad, then push [#] to make the individual call.

e.g.: When the station '201 2001 200' calls the station '211 2010 300';

➡ Push [2], [1], [1], [2], [0], [1], [0], [3], [0], [0] and [#] in sequence.

◇ Group call

To the group that has the same prefix and fleet

Enter the desired group code via the keypad, then push [#] to make the group call.

e.g.: When the station in the group '201 2001 200' calls the station group '201 2001 900';

➡ Push [9], [0], [0] and [#] in sequence.

To the group that has the same prefix, but different fleet

Enter the desired fleet and group codes via the keypad, then push [#] to make the group call.

e.g.: When the station in the group '201 2001 200' calls the station group '201 2010 900';

➡ Push [2], [0], [1], [0], [9], [0], [0] and [#] in sequence.

To the group that has the different prefix

Enter the desired prefix, fleet and group codes via the keypad, then push [#] to make the group call.

e.g.: When the station in the group '201 2001 200' calls the station group '211 2010 900';

➡ Push [2], [1], [1], [2], [0], [1], [0], [9], [0], [0] and [#] in sequence.

◇ Status call

- Push [*], [0], [xx]*, [*], individual code and [#] in sequence to make a status call to the desired station.
- Push [*], [0], [xx]* and [#] in sequence to make a status call to the despatcher.
- Push [*], [0] and [#] in sequence to make a Call Back Request status call to the despatcher
- Push [#], [0] and [#] in sequence to make a cancellation of the above Call Back Request status call to the despatcher.
- Push [*], [0], [*], individual code and [#] in sequence to make the Call Back Request status call to the individual code station.
- Push [#], [0], [*], individual code and [#] in sequence to make the cancellation of the above Call Back Request status call to the individual code station.
* xx is a status code number from 00 to 31.

/// **NOTE:** The same manner as the individual call (p. 12) is used when making an individual status call to the different prefix and/or fleet code.

◇ PSTN call

Push [0], telephone number (1-digit or more) and [#] to make a phone call through the public telephone network.
The system must be compatible to the PSTN.

◇ Enhanced group call

• Conference call

Push [*], [1], [*], group code and [#] in sequence to make a conference call.
All stations in the called group can be communicated with the conference call.

• Broadcast call

Push [*], [1], [1], [*], and group code and [#] in sequence to make a broadcast call.
All stations in the called group can only listen to the announcement from the calling station.

/// **NOTE:** The same manner as the group call (p. 12) is used when making a conference or broadcast call to the different prefix and/or fleet code.

◇ SDM (Short Data Message) call

- Push [*], [2], [*], SDM memory number and [#] in sequence to make an SDM call (up to 24-digit; including *, 2 and *) to the previously selected station or group.
- Push [*], [2], [*], SDM memory number, individual code and [#] in sequence to make an SDM call (up to 24-digit; including *, 2, * and individual code) to the desired station.

/// **NOTE:** The same manner as the individual call (p. 12) is used when making an individual SDM call to the different prefix and/or fleet code.

3 BASIC OPERATION

◇ Data call

Push [*], [3], [1], [*], individual or group code and [#] in sequence to make a data call to the desired individual or group station(s).

A communication channel is automatically selected after the call, however, the microphone audio transmission and audio output are inhibited.

- “▶” blinks during the data call is performed.

NOTE:

- External modem is required for the data call, however, the transceiver does not support an external modem.
- The same manner as the individual or group call (p. 12) is used when making an individual or group data call to the different prefix and/or fleet code.

◇ Divert own call

- Push [*], [4], [1], [x]*, [*], individual code (to be transferred to) and [#] in sequence to transfer the call to the desired station.
- Push [#], [4], [1], [x]*, [*] and [#] in sequence to cancel the divert own call.

At the transferred station, push [#], [4], [5], [x]* and [#] in sequence to cancel the transferred setting.

*x: Enter “1” for voice, “0” for data and skip the digit input for both voice and data.

NOTE: The same manner as the individual call (p. 12) is used when setting the divert own call to the different prefix and/or fleet code.

◇ Divert 3rd party call

- Push [*], [4], [4], [x]*, individual code (B; transferring station), individual code (A; transferred station) and [#] in sequence to transfer the call from station B to A.
- Push [#], [4], [4], [x]*, [*], individual code (B; transferring station) and [#] in sequence to cancel the transferring.
*x: Enter “1” for voice, “2” for data and skip the digit input for both voice and data.

NOTE: The same manner as the individual call (p. 12) is used when setting the divert 3rd party call to the different prefix and/or fleet code.

◇ Cancellation of divert call

- Push [#], [4], [1], [x]* and [#] in sequence to cancel the divert own call.
- Push [#], [4], [4], [x]*, individual code (B; call transferring station) and [#] in sequence to cancel the divert 3rd party call.
- Push [#], [4], [5], [x]* and [#] in sequence to cancel the call transformation from the other station.
*x: Enter “1” for voice, “0” for data and skip the digit input for both voice and data.

NOTE: The same manner as the individual call (p. 12) is used when setting the cancellation of divert call to the different prefix and/or fleet code.

◇ PABX call

When making a PABX call, push [7] or [8] and phone number (5-digit or more when starting with '7,' 4-digit or more when starting with '8'), then push [#].

The system must be compatible to the PSTN.

◇ Priority call

Push [*], [8], [*], individual or group code and [#] in sequence to make a priority call.

The priority is given to the call by waiting for turn when the system is in busy.

NOTE: The same manner as the individual or group call (p. 12) is used when setting the priority call to the different prefix and/or fleet code.

◇ Emergency call

The emergency call can be made even the system is in busy by making a clear channel in force.

- Push [*], [9], [*], individual or group code and [#] in sequence to make an emergency call.
- When pushing [*], [9] and [#] in sequence to make an emergency call to the dispatcher.

NOTE: The same manner as the individual or group call (p. 12) call is used when setting the priority call to the different prefix and/or fleet code.

◇ System Wide call**• Priority Voice Call**

Push [*], [1], [9], [8], [1], and [#] in sequence to make a priority voice call.

• Emergency Voice Call

Push [*], [1], [9], [8], [2], and [#] in sequence to make an emergency voice call.

• Standard Voice Call

Push [*], [1], [9], [8], [7], and [#] in sequence to make a standard voice call.

These calls as above calling all stations they are in stand by condition in the system.

• Priority Data Call

Push [*], [1], [9], [8], [3], and [#] in sequence to make a priority data call.

• Emergency Data Call

Push [*], [1], [9], [8], [4], and [#] in sequence to make an emergency data call.

A communication channel is selected automatically after the data call, however, the microphone audio transmission and receive audio emission are inhibited.

- “▶” blinks during the data call is performed.

NOTE: An external modem is required for the data operation, however, the transceiver does not support an external modem.

3 BASIC OPERATION

◇ **Include call**

The include call allows to make an extra call for joining another station for the communication after move to a communication channel.

The include call is made when an individual or group code selection using a memory or keypad is performed on the communication channel.

◇ **5-digit routing code call**

The 5-digit routing code call provides a shortening a calling code input.

When calling a station that has a different prefix and/or fleet code, the 3-digit prefix and 4-digit fleet code are converted into 2 or 3-digit code, therefore, entering a total of 5-digit code including an individual or group code.

• **The conversion range**

Code within 200 to 299, 900 to 998, 20 to 29 and 90 to 99 can be converted, and set the desired prefix and fleet code must be registered in advance.

e.g.: When the station '200 2001 200' calls the station '211 2006 300';

- ➔ Register the both prefix '211' and fleet '2006' to "22" as the 5-digit routing code— Enter "22300" and pushing [#] to make a 5-digit routing code call.

◇ **Call cancel**

Push [*] and [#] to cancel the call.

The communication is disconnected, and the call is cancelled.

◇ **Cancelling the entered code**

During code entering from the keypad, pushing [Up]/[Down] or [Backspace] to clear the previously entered digit code.

The entered all digit code can be cancelled by pushing [Clear].

◇ **Manual call reply**

When the call with "ALERTING" indication is received, push [#] or [PTT] to reply the call manually (off-hook).

◇ **End of the communication**

Push [*] and [#], or push [Clear] to finish (disconnect) the communication (on-hook).

■ Special call with the keypad

◇ Re-dial

Push [#] twice to re-call the previously called individual or group station(s).

◇ Short dialing

Push one of [1] to [9] and [#], to make a call with the stored individual or group code in the memory 1 to 9.

■ Receiving a call

◇ Receiving an individual call

- When an individual call is received, calling ring sounds.
 - “ALERTING” and the calling station code (or text name if the calling code is memorized in the memory) are displayed alternately.



- When the call from a telephone, “TEL” (PSTN) or “PABX” is displayed.



- Push [PTT] or [#] to start the communication.
 - The communication timer is displayed and starts count down. (When no transmission time limit is set, the timer counts up.)
 - The channel number and the communication timer are displayed simultaneously (illustrated as at below right) when the communication channel number indication is set to ON. (p. 27)



- The warning beeps sound 10 sec. before the communication timer is activated.
 - The communication is disconnected automatically when the communication timer is activated.
- Push [Clear] to disconnect the communication manually.
 - Pushing [*] and [#] in sequence also disconnect the communication. (10-key version only)
 - The transceiver returns to stand-by condition.

3 BASIC OPERATION

• When not answering the call

When not answering call with [PTT], the calling station code is stored into call back memory. (max. 15 channels)

- “🔔” blinks when a call from the station that the station code does not stored in the call back memory, is received.
- “🔔” appears when the call back memory that call back operation has not been performed is/are stored.

➡ Push [Call Back] then [Up]/[Down] to select the desired call back memory, and then push [PTT] or [Call Set Up] to reply the call.

- The pre-programmed text name is displayed in case of the calling code is memorized in the memory.

Q01 302

◇ Receiving an group call

The transceiver waits for a group call with the selected group code (that is selected with [Group Selector] or [Up]/[Down]) or the pre-programmed group codes (stand-by group).

The transceiver waits for a group call with the pre-programmed stand-by group codes when an individual code is displayed. The pre-programmed stand-by group code is not displayed on the LCD.

- ① When a group call is received, beeps sound and the transceiver turns the communicating condition automatically.
- “GRP” and the calling station code are displayed.

GRP 302

Receiving a group call with the selected group code.

GRP 1 302

Receiving a group call with the stand-by group code 1.

② Push and hold [PTT] to communicate with the calling station.

- The communication timer is displayed and starts count down. (When no transmission time limit is set, the timer counts up.)
- The channel number and the communication timer are displayed simultaneously (illustrated as at below right) when the communication channel number indication is set to ON. (p. 27)



③ The warning beeps sound 10 sec. before the communication timer is activated.

- The communication is disconnected automatically when the communication timer is activated.

④ Push [Clear] to disconnect the communication manually.

- Pushing [*] and [#] in sequence also disconnect the communication. (10-key version only)
- The transceiver returns to stand-by condition.

◇ Receiving a status message

When a status call is received, the transceiver emits beeps, and the appropriate text message to the received status number and the individual code of calling station are displayed alternately.



- The display is cancelled and returns to the stand-by indication when [Clear] is pushed.
- When the status 0 (call back request) is received, the calling station code is stored into the call back memory and “▲” blinks. However, the status 31 (call back cancel) is received, the calling station code is erased from the call back memory.

◇ Receiving an SDM (Short Data Message)

When an SDM is received, beeps sound and the received message contents and the calling station code are displayed alternately.



- “▶” appears when the message that containing more than 9-digit message is received.
 - Push [Down] to scroll the indication to display the following message in this case.
 - Push [Up] to display the previous digit message.
 - Push [Clear] to return to stand-by indication.

3 BASIC OPERATION

◇ Receiving a data call

- ① When a data call is received, beeps sound.
- “ALERTING” and the calling station code (or text name if the calling code is memorized in the memory) are displayed alternately.

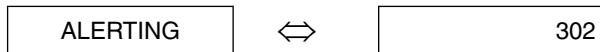

- When the call from a telephone, “TEL” (PSTN) or “PABX” is displayed.



- ② Push [PTT] or [#] to set the transceiver to the data receiving condition.
- “▶” blinks.
 - The communication timer is displayed and starts count down. (When no transmission time limit is set, the timer counts up.)
 - The channel number and the communication timer are displayed simultaneously (illustrated as at below right) when the communication channel number indication is set to ON. (p. 27)
 - Voice communication cannot be performed even [PTT] is pushed.

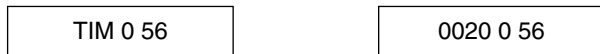

- ③ The warning beeps sound 10 sec. before the communication timer is activated.
- The communication is disconnected automatically when the communication timer is activated.
- ④ Push [Clear] to disconnect the communication manually.
- Pushing [*] and [#] in sequence also disconnect the communication. (10-key version only)
 - The transceiver returns to stand-by condition.

• When not answering the call

If no answering call is performed by pushing [PTT] or [#], the calling station code is stored into the call back memory. (Max. 15 calls)

- “🔔” blinks when a call from the station that the station code does not stored in the call back memory, is received.
- “🔔” appears when the call back memory that call back operation has not been performed is/are stored.

- ① Push [Call Back] then [Up]/[Down] to select the desired call back memory.
- “▶” appears when the call back memory that is stored in data communication is selected.
- ② Push [PTT] or [Call Set Up] to reply the call with the voice communication.
- The calling station code (or text name if the calling code is memorized in the memory) is displayed.

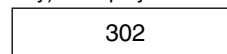

One of the following messages will be displayed according to the transceiver or system conditions.

Indication	Description
ABORTED	Aborted: The call has been aborted. Re-call later.
ALERTING	Alerting
AUTO	Auto (RF Power): The automatic transmit output power selection is set.
CALLBACK	Call Back: The call is recorded at the calling station. Wait for the reply.
CALLING	Calling the station.
CANCEL	Canceled: The call/input has been canceled.
Ch	Ch##: Channel number ## (Conventional mode)
CLR DOWN	Clear Down: The communication connection is disconnected.
CONNECT	Connected: The call is succeeded. Communication can be made.
DESPATCH	Despatcher: The despatcher number is selected.
DIVERTED	Diverted: The call is transferred to another station.
DYN GRP	Dynamic Group: A new group number is set.
EMRGNCY	Emergency: [Emergency] is pushed and held.
ENGAGED	Engaged: The calling station is in busy. Re-call later.
FAILED	Failed: The call is failed. Or, the system does not support the calling number.
GRP	Group##: Stand-by group code ##
INTER--FL	Inter Fleet: The call is received from the different fleet.

The displaying message can be edit with the PC programming.

Indication	Description
INVALID	Invalid: The calling number is wrong.
LOW	Low#: The low transmit output power # is set.
LOW BATT	Low Battery: The battery is exhausted and the transceiver power is turned OFF automatically.
NO REPLY	No Reply: No reply is received with the call.
OK	OK: The call is succeeded.
OVERVOLT	Over Voltage: The supplied voltage exceeds the specified input voltage range.
PABX	PABX: Receiving a call from PABX.
PASSWORD	Password: Enter the password.
Q	Queue##: Call back memory number ##.
QUEUED	Queued: The call is waiting for turn. Wait for a while.
RINGING	Ringling: Ringling the calling bell sound at the calling station.
SYS BUSY	System Busy: The system unable to receive a call because of the system in busy. Re-call later.
SYS WIDE	System Wide: Receiving a system wide call.
TEL	Telephone: Receiving a call from PSTN.
TIMEOUT	Timeout: The communication timer has been over.
TIM	Timer ##:##: The communicating timer indication.

■ PTT quick call

The PTT quick call provides simple calling. Pushing [PTT] only makes a call with the displayed ID, even individual, group, despatcher, status or call back.

NOTE: The PTT quick call will not function when [Call Set Up] is assigned to some function key. Do not assign [Call Set Up] when PTT quick function is used.

■ Call back function

Use this function when the called station cannot be reply the call immediately.

Push and hold [Call Back] to toggle the call back function ON and OFF.

When the call back function is turned ON:

The called station sending backs the “Call Back” message to the calling station.

- “” appears and the calling station code is stored into the call back memory.
- “CALLBACK” is displayed on the calling station display.
- While in call back mode, two dot indications blink at the left edge and 2nd of the LCD.

When the call back function is turned OFF:

The calling station code is stored into the call back memory only when no reply call is performed, or the clear down operation is performed at the calling station before reply the call.

- Up to 15 calls can be stored into the call back memory.
- “” blinks to let operator knows the un-replied calls are available.
- When [Call Back] is pushed to confirm the stored contents, the call back indicator blinking stops and displayed continuously.
- The call back memory is cleared after turning the transceiver OFF.

• The regular calling operation can be performed even the call back function is turned ON.

- ① During “” appears or blinks, push [Call Back] to display the stored station code or text name.
- ② Push [Up]/[Down] to select the desired memory.
- ③ Push [PTT], [Call Set Up] or [#] to reply to the call that from the selected station code.
 - The station code will be erased from the call back memory when the reply call is performed.
 - The call back operation cannot be performed to PSTN, PABX, Inter-prefix and Inter-fleet calls.

• Erasing the call back memory

- ① Push [Call Back] then select the desired call back memory to be erased with [Up]/[Down].
- ② Push and hold [Call Back] for 2.5 sec. to erase the selected call back memory.
 - All the stored call back memory can be erased with the same operation as above depending on the setting.
 - When all of the 15 call back memories are stored and 16th call is received, the called station sent the message, “Don’t Disturb” to the system repeater. In this case, the message that the call has failed is displayed on the calling station display.

■ Calling station ID indication for group call

The communicating station code can be displayed at any time.

This function can be turned ON or OFF in advance.

The “Pressel signal” from the calling transceiver is used for the indication, however, the “Pressel signal” is not through out with some trunking system repeater. No station code indication is provided in this case.

 **NOTE:** This function may function differently or not function depending on the trunking system controller in place.

5 OTHER FUNCTIONS

■ System lock function

The system lock function disables the roaming function manually.

- ① Push [*], [5], [1] and [#] in sequence to turn the system lock function ON.
 - The dot indication appears at right edge of the LCD.
- ② Push [#], [5], [1] and [#] in sequence to turn the system lock function OFF.
 - The dot indication disappears.

■ Call code memory

Up to 4 codes, individual, group or status, can be programmed from the keypad.

The programmed codes can be selected with [Up]/[Down].

- ➔ Push [*], [6], [0], [*], [x]*, [*], [code number] and [#] in sequence to program the desired code into the memory.
- No erasing capability is available, over-write the new code in such a case.
- *x=1 to 4

■ Automatic transmit output power selection

(Except for the conventional operation)

During trunking operation, the transmit output power is automatically selected from High, Low2 and Low1 according to the received signal strength from the system base.

■ Power ON security

The transceiver has a power ON security that requires the 4-digit password entry at turning the power ON.

The transceiver cannot be used until the correct password is entered.

■ Voice scrambler

The optional voice scrambler, UT-109 and UT-110, are available.

The scrambler will be turned ON when the desired scrambler code is selected in user set menu. (p. 26)

- Use the UT-109 with the trunking operation is recommended.
- The transceiver has built-in voice scrambler (inversion type).

NOTE:

- The UT-110 (with rolling setting) **CANNOT** be used with the trunking operation, because of the rolling synchronization will be shifted by the interval transmission for the system.
- Both the UT-109 and UT-110 are usable for conventional operation.
- The built-in voice scrambler does not have a compatibility with the UT-109 and UT-110.

■ DTMF operation

While pushing and holding [PTT], push a key ([0] to [9], [P0] to [P3]*, [*] and [#]) to output the appropriate DTMF tone.

The transceiver should be in the condition that the communication is enabled with [PTT] on a traffic channel.

*[P0] to [P3] correspond to the DTMF tone A to D, respectively.

■ Comander function

When the comander function is set to ON, the communicating audio quality will be increased.

The comander function can be turned ON or OFF in user set menu. (p. 26)

■ User set menu

During stand-by condition (not in communicating, dialing, accessing to some function), push and hold [Clear] for 2.5 sec. to access to user set menu.

In user set menu, backlight, ringer, beep level, squelch level, compander, microphone gain, voice scrambler, battery voltage indication, etc., can be set.

Unnecessary items can be hidden from indication of user set menu.

- ① Push and hold [Clear] for 2.5 sec. to enter user set menu.
- ② Push [Clear] momentarily to select the desired set item.
- ③ Push [Up]/[Down] to set the desired condition or value.
- ④ Push and hold [Clear] for 2.5 sec. again to exit from user set menu and return to the stand-by condition.

◇ Selectable items and setting value

SELECTABLE ITEMS	SETTING VALUES (DOWN ↔ UP)
• Backlight	OFF, Auto, Auto2 or ON
• Ringer	OFF or ON
• Beep level	OFF or ON
• Squelch level	0 to 255
• Compander	OFF or ON
• Microphone Gain	1 to 5
• Voice scrambler*	OFF, 1 to 5
• Battery voltage indication	OFF or ON

*For optional voice scrambler setting. This item does not appear when the optional voice scrambler unit is not installed.

 **NOTE: NEVER** decrease the squelch value from the initial setting. Searching speed will be decreased for trunking system operation.

• Channel number indication

When the system information indication is enabled, the operating channel number is displayed with the communication timer.

0014 0 59

“Enable”

Channel number and timer indication

TIM 0 59

“Disable”

Timer indication

◇ CPU revision indication

While pushing and holding [P3] and [Up], turn the transceiver power ON to indicate the following information.

- CPU revision number and check some
- ESN number
- Clone comment (1) and (2)
- Installed optional unit name (if installed)

The transceiver has a conventional operation capability also for when the transceiver is in out-of service area.

The tone squelch operation with CTCSS is available for the conventional operation, as well as the ANI (Automatic Numbering Identification) transmission at PTT ON and/or OFF.

 **NOTE:** The pressel signal of trunking is used for the ANI operation.

➔ By pushing [Monitor], both the tone and noise squelch is released to monitor the selected channel conditions.

➔ Total of 32 conventional channels are available and are selectable with [Up]/[Down].

The conventional channels must be programmed in advance.

• Switching with the automatic talk around

The conventional mode will be selected automatically when the trunking control channel is fall down or the transceiver move into the out-of service area.

Even the conventional mode is selected, the transceiver automatically searching for a usable control channel by returning into trunking mode in interval. Then the transceiver is switched to trunking mode when a usable control channel is found, or return to conventional mode when no usable control channel is found.

The automatic talk around is disabled by setting “OFF” in automatic talk around timer with the programming.

• Switching with [Mode], or [P1] and [Up] operation at power ON.

Push [Mode] to toggle the operation mode between trunking and conventional mode.

Or, while pushing and holding both [P1] and [Up], turn the transceiver power ON to toggle the operation mode between trunking and conventional mode.

Once the operation mode is selected with either operation, the operation mode won't be changed until [Mode] is pushed.

Even the transceiver is turned OFF, the transceiver remains the operation mode.

 **NOTE:** [Mode] must be assigned in key assignment for both trunking and conventional if manual operation mode selection is required.

■ Programmable function keys

The following functions can be assigned to [Red], [Clear], [P0], [P1], [P2] and [P3] programmable function keys.

2 keys located below [PTT] are fixed for [Up] and [Down].

A different functions can be assigned for the customize keys between trunking and conventional mode.

◇ Trunking mode only

DESPATCHER KEY

Push to make the despatcher call.

- The pre-programmed despatcher ID is simply recalled.

CALL1 AND CALL2 KEYS

Push to make a call to the pre-programmed station/group.

- [Call 1] calls the station programmed in channel 1 in call memory.
- [Call 2] calls the station programmed in channel 2 in call memory.

EMERGENCY KEY

Push to make an emergency call.

The emergency call calls the pre-programmed station.

- This function is assigned to [Red] in default setting.

BACKSPACE KEY

Push to erase the previously entered digit input.

STATUS KEY

Push to enter a status message selection mode.

CALL BACK KEY

Push to toggle the call back mode ON and OFF.

CALL SET UP KEY

Push to make a call.

Assign this function when the PTT quick call is not used.

◇ Either trunking or conventional mode

MODE KEY

Push to switch the operation mode between trunking and conventional.

NULL KEY

No function.

Assign to the key that is not used to the transceiver operation.

HIGH/LOW KEY

Push to toggle the transmit output power.

- When automatic power selection is enabled for trunking mode operation, the transmit output power cannot be selected with this key.

8 PROGRAMMABLE FUNCTIONS

UP AND DOWN KEYS

- Push to select the call memory channel.
- Push to select the call back memory channel.
- Push to select the status channel.
- Push to select the operating channel. (Conventional mode operation only)
- Push to select the setting value or condition during user set mode.
- Push to erase the previously entered digit number (functions as back space key) during dialing number entering from the keypad. (10-key version only)

LOCK KEY

Push to inhibit the function key operations, except [PTT] and [Lock].

CLEAR (SET MODE) KEY

- Push to disconnect the communication (clear down).
- Push and hold for 2.5 sec. to enter user set menu.

◇ Conventional mode only

MONITOR KEY

Push to release both the tone and noise squelch mute at the same time to monitor the signal on the selected operating channel.

SIMPLEX KEY

The both receive frequency and receive CTCSS frequency are used as the transmit frequency and transmit CTCSS frequency, respectively.

Direct communication without a repeater can be made.

■ UT-109 and UT-110 installation

Install the optional unit as follows:

- ① Rotate [VOL] to turn the power OFF, and remove the battery pack. (p. 2)
- ② Remove the unit cover.

NOTE: Insert a standard screw driver into the hollow of the chassis, then lift and take away the unit cover illustrated as below.

Use the supplied spare unit cover! Do not use the cover that has been removed once. Water or dust may get into the transceiver because the cover may be bent or has lost its adhesion. This may result in the transceiver being damaged.

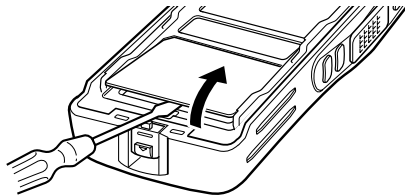

- ③ Cut the pattern on the PCB at the TX mic circuit (MIC) and RX AF circuit (DISC) as shown below.

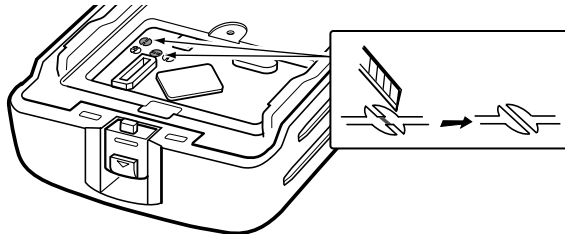

- ④ Install the unit as shown below.

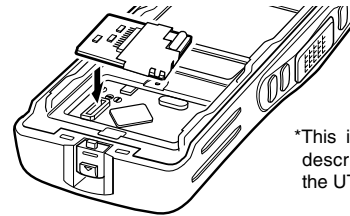

*This illustration is described with the UT-109.

- ⑤ Replace the unit cover and the battery pack, then rotate [VOL] to turn the power ON.

NOTE: When uninstalling the scrambler unit

Be sure to re-solder the disconnected points at left, otherwise no TX modulation or AF output is available.

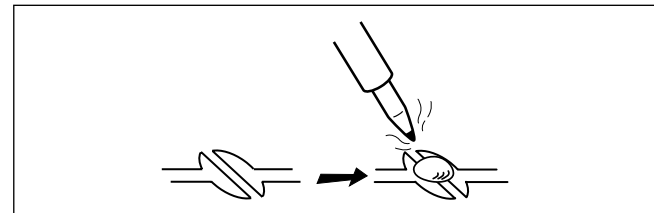

10 BATTERY CHARGING

■ Caution

Misuse of Lithium-Ion batteries may result in the following hazards: smoke, fire, or the battery may rupture. Misuse can also cause damage to the battery or degradation of battery performance.

⚠ **DANGER!** Use and charge only specified Icom battery packs with Icom radios or Icom chargers. Only Icom battery packs are tested and approved for use and charge with Icom radios or Icom chargers. Using third-party or counterfeit battery packs or chargers may cause smoke, fire, or cause the battery to burst.

◇ Battery caution

⚠ **DANGER! DO NOT** hammer or otherwise impact the battery. Do not use the battery if it has been severely impacted or dropped, or if the battery has been subjected to heavy pressure. Battery damage may not be visible on the outside of the case. Even if the surface of the battery does not show cracks or any other damage, the cells inside the battery may rupture or catch fire.

⚠ **DANGER! NEVER** use or leave battery packs in areas with temperatures above +60°C. High temperature buildup in the battery, such as could occur near fires or stoves, inside a sun heated car, or in direct sunlight may cause the battery to rupture or catch fire. Excessive temperatures may also degrade battery performance or shorten battery life.

⚠ **DANGER! DO NOT** expose the battery to rain, snow, seawater, or any other liquids. Do not charge or use a wet battery. If the battery gets wet, be sure to wipe it dry before using. The battery is not waterproof.

⚠ **DANGER! NEVER** incinerate used battery packs since internal battery gas may cause them to rupture, or may cause an explosion.

⚠ **DANGER! NEVER** solder the battery terminals or NEVER modify the battery pack. This may cause heat generation, and the battery may rupture, emit smoke or catch fire.

⚠ **DANGER!** Use the battery only with the transceiver for which it is specified. Never use a battery with any other equipment, or for any purpose that is not specified in this instruction manual.

⚠ **DANGER!** If fluid from inside the battery gets in your eyes, blindness can result. Rinse your eyes with clean water, without rubbing them, and see a doctor immediately.

WARNING! Immediately stop using the battery if it emits an abnormal odor, heats up, or is discolored or deformed. If any of these conditions occur, contact your Icom dealer or distributor.

WARNING! Immediately wash, using clean water, any part of the body that comes into contact with fluid from inside the battery.

WARNING! NEVER put the battery in a microwave oven, high-pressure container, or in an induction heating cooker. This could cause a fire, overheating, or cause the battery to rupture.

CAUTION! Always use the battery within the specified temperature range for the transceiver (-25°C to $+55^{\circ}\text{C}$) and the battery itself (-20°C to $+60^{\circ}\text{C}$). Using the battery out of its specified temperature range will reduce the battery's performance and battery life. Please note that the specified temperature range of the battery may exceed that of the transceiver. In such cases, the transceiver may not work properly because it is out of its operating temperature range.

CAUTION! Shorter battery life could occur if the battery is left fully charged, completely discharged, or in an excessive temperature environment (above $+45^{\circ}\text{C}$) for an extended period of time. If the battery must be left unused for a long time, it must be detached from the radio after discharging. You may use the battery until the battery indicator shows half-capacity, then keep it safely in a cool dry place with the temperature between -20°C to $+25^{\circ}\text{C}$.

◇ Charging caution

⚠ **DANGER! NEVER** charge the battery pack in areas with extremely high temperatures, such as near fires or stoves, inside a sun heated car, or in direct sunlight. In such environments, the safety/protection circuit in the battery will activate, causing the battery to stop charging.

WARNING! DO NOT charge or leave the battery in the battery charger beyond the specified time for charging. If the battery is not completely charged by the specified time, stop charging and remove the battery from the battery charger. Continuing to charge the battery beyond the specified time limit may cause a fire, overheating, or the battery may rupture.

WARNING! NEVER insert the transceiver (battery attached to the transceiver) into the charger if it is wet or soiled. This could corrode the battery charger terminals or damage the charger. The charger is not waterproof.

CAUTION! DO NOT charge the battery outside of the specified temperature range: BC-160 (0°C to $+45^{\circ}\text{C}$). Icom recommends charging the battery at $+20^{\circ}\text{C}$. The battery may heat up or rupture if charged out of the specified temperature range. Additionally, battery performance or battery life may be reduced.

10 BATTERY CHARGING

■ Optional battery chargers

◇ Rapid charging with the BC-160

The optional BC-160 provides rapid charging of optional Li-Ion battery packs.

- An AC adapter (may be supplied with BC-160 depending on version) or the DC power cable (OPC-515L/CP-17L) is additionally required.

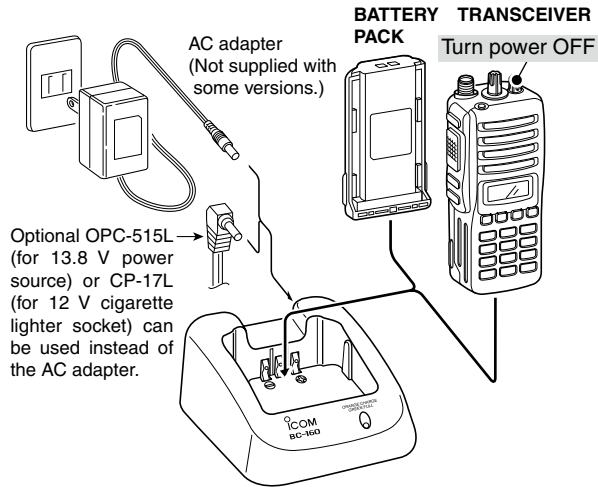

◇ AD-106 installation

The AD-106 CHARGER ADAPTER must be installed into the BC-119N or BC-121N before battery charging.

- Connect the AD-106 CHARGER ADAPTER and the BC-119N/BC-121N as below, then install the AD-106 into the holder space of the BC-119N or BC-121N with the supplied screws.

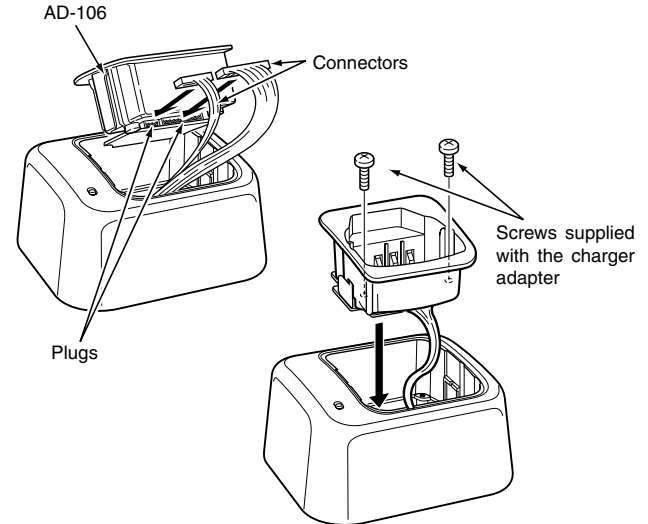

◇ Rapid charging with the BC-119N+AD-106

The optional BC-119N provides rapid charging of battery packs. The following items are additionally required.

- AD-106 charger adapter
- An AC adapter (may be supplied with BC-119N depending on version) or the DC power cable (OPC-515L/CP-17L).

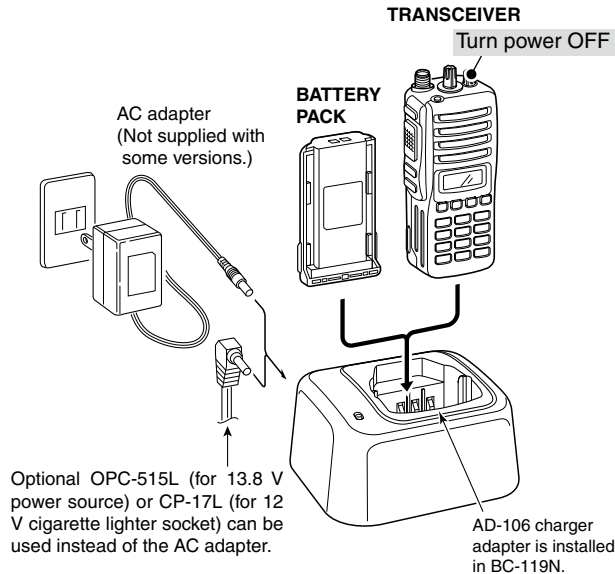

◇ Rapid charging with the BC-121N+AD-106

The optional BC-121N allows up to 6 battery packs to be charged simultaneously. The following items are additionally required.

- Six AD-106 charger adapters
- An AC adapter (BC-157) or the DC power cable (OPC-656)

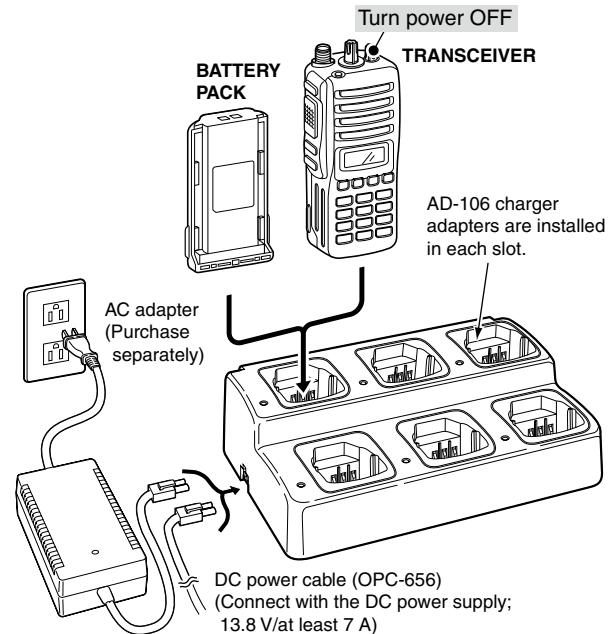

10 BATTERY CHARGING

/// **IMPORTANT!: Battery charging**

Ensure the guide lobes on the battery pack are correctly aligned with the guide rails inside the charger adapter.
(This illustration is described with the BC-160.)

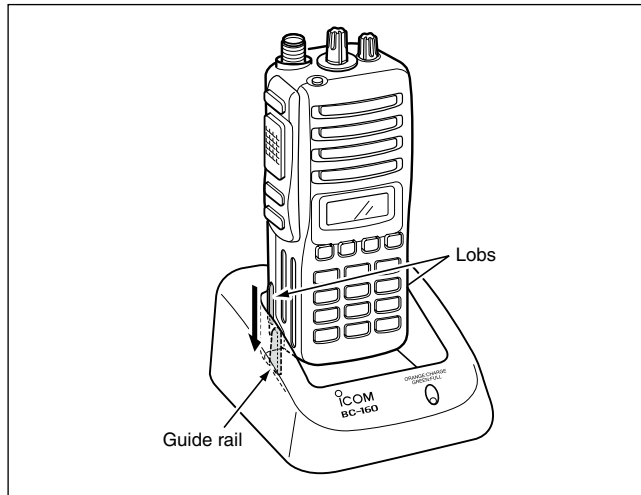

■ Battery case (BP-240)

When using the optional battery case, install 6 × AAA (LR03) size alkaline batteries as illustrated at right.

- ① Unhook the battery cover release hook (1), and open the cover in the direction of the arrow (2). (Fig.1)
- ② Then, install 6 × AAA (LR03) size alkaline batteries. (Fig.2)
 - Install the alkaline batteries only.
 - Be sure to observe the correct polarity.
 - Do not place the ribbon over the batteries.
- ③ Fit the cover in the direction of the arrow (3), then close (4). And hook the battery cover release hook until it makes a 'click' sound (5). (Fig.3)

Fig.1

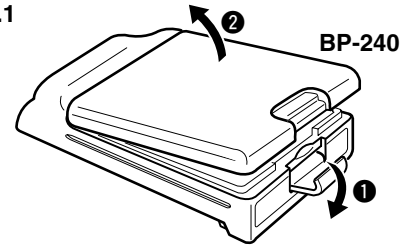

Fig.2

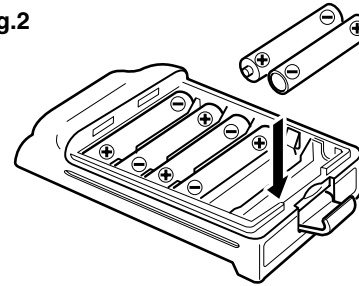
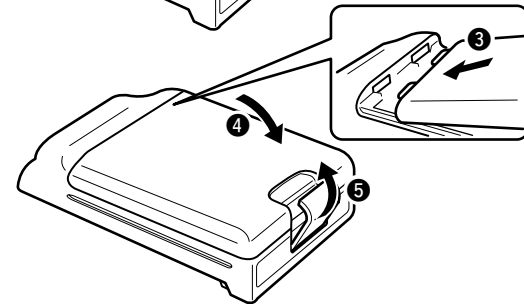

Fig.3



CAUTION:

- When installing batteries, make sure they are all the same brand, type and capacity. Also, do not mix new and old batteries together.
- Keep battery contacts clean. It's a good idea to clean battery terminals once a week.
- Never incinerate used battery cells since internal battery gas may cause them to rupture.
- Never expose a detached battery case to water. If the battery case gets wet, be sure to wipe it dry before using it.

12 OPTIONAL SWIVEL BELT CLIP

■ MB-93 contents

	Qty.
① Belt clip	1
② Base clip	1

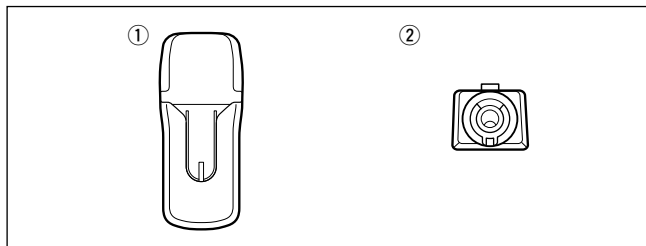

■ Attaching

- ① Release the battery pack if it is attached. (p. 2)
- ② Slide the base clip in the direction of the arrow until the base clip is locked and makes a 'click' sound.

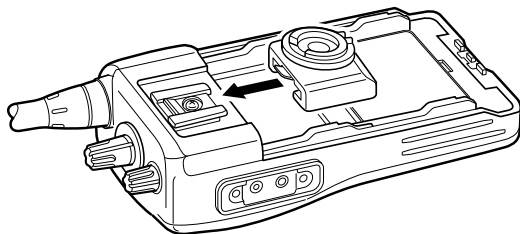

- ③ Clip the belt clip to a part of your belt. And insert the transceiver into the belt clip until the base clip inserted fully into the groove.

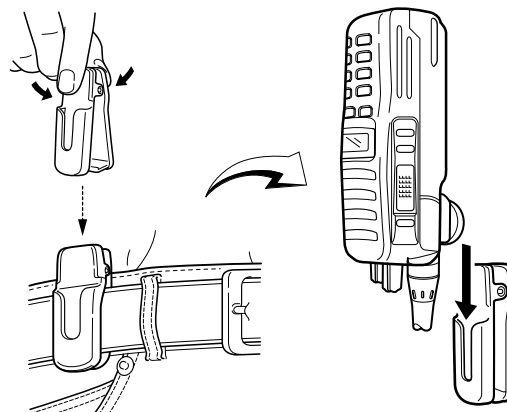

- ④ Once the transceiver is locked in place, it swivels as illustrated below.

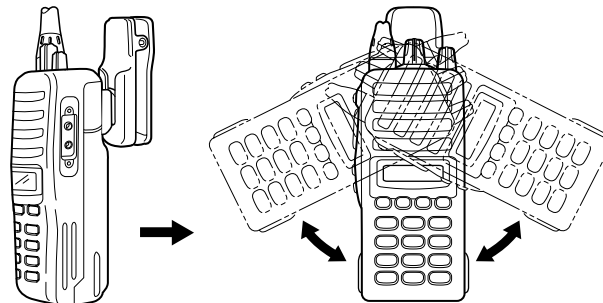

■ Detaching

- ① Turn the transceiver upside down in the direction of the arrow and pull out from the belt clip.

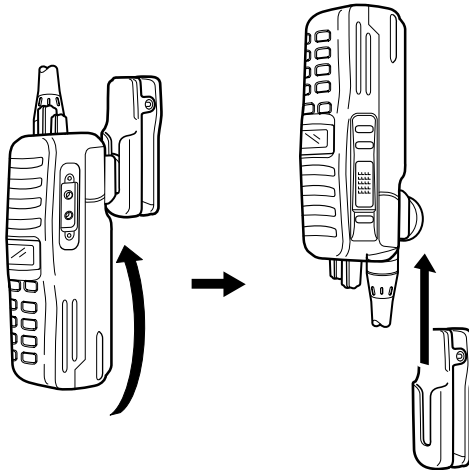

- ② Release the battery pack if it is attached. (p. 2)
- ③ Pinch the clip (①), and slide the base clip in the direction of the arrow (②).

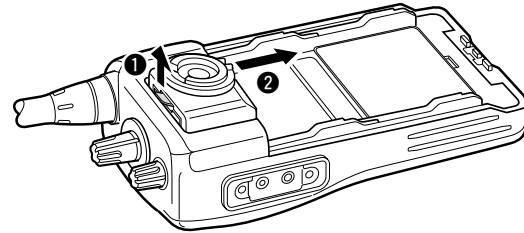

CAUTION:
HOLD THE TRANSCEIVER TIGHTLY, WHEN HANGING OR DETACHING THE TRANSCEIVER FROM THE BELT CLIP.
 Otherwise the transceiver may not be attached to the holder or swivel properly if the transceiver is accidentally dropped and the base clip is scratched or damaged.

13 OPTIONS

◇ BATTERY PACKS

Battery pack	Voltage	Capacity	Battery life*1
BP-230N	7.4 V	950 mAh (min.) 980 mAh (typ.)	6.50 hrs.
BP-232N	7.4 V	1900 mAh (min.) 2000 mAh (typ.)	13.25 hrs.
BP-240	Battery case for AAA (LR03) × 6 alkaline		—*2

*1 When the power save function is turned ON, and the operating periods are calculated under the following conditions;

TX : RX : standby = 5 : 5 : 90

*2 Operating period depends on the alkaline cells used.

◇ CHARGERS

- **BC-119N** DESKTOP CHARGER + **AD-106** CHARGER ADAPTER
+ **BC-145** AC ADAPTER

For rapid charging of battery packs. An AC adapter is supplied with the charger depending on versions. Charging time: approx. 3 hours when BP-232N is attached.

- **BC-121N** MULTI-CHARGER + **AD-106** CHARGER ADAPTER (6 pcs.)
+ **BC-157** AC ADAPTER

For rapid charging of up to 6 battery packs (six AD-106's are required) simultaneously. An AC adapter should be purchased separately. Charging time: approx. 3 hours when BP-232N is attached.

- **BC-160** DESKTOP CHARGER + **BC-145** AC ADAPTER

For rapid charging of battery packs. An AC adapter is supplied with the charger depending on versions. Charging time: approx. 3 hours when BP-232N is attached.

◇ BELT CLIPS

- **MB-93** SWIVEL BELT CLIP

- **MB-94** BELT CLIP

Exclusive alligator-type belt clip. The same as supplied with the transceiver.

- **MB-96N/96F** LEATHER BELT HANGER

◇ OPTIONAL UNITS

- **UT-109 (#02)/UT-110 (#02)** SCRAMBLER UNITS

Non-rolling type (UT-109)/Rolling type (UT-110) voice scrambler unit provides higher communication security.

◇ DC CABLES

- **CP-17L** CIGARETTE LIGHTER CABLE

Allows charging of the battery pack through a 12 V cigarette lighter socket. (For BC-119N)

- **OPC-515L/OPC-656** DC POWER CABLES

Allows charging of the battery pack using a 13.8 V power source instead of the AC adapter.

OPC-515L: For BC-119N

OPC-656 : For BC-121N

◇ **OTHER OPTIONS**

- **SP-13** EARPHONE
Provides clear receive audio in noisy environment.
- **HM-131L/HM-158L** SPEAKER-MICROPHONE
Combination speaker-microphone that provides convenient operation while hanging the transceiver from your belt.
- **HS-94/HS-95/HS-97** HEADSET + **VS-1L** VOX/PTT CASE
HS-94: Ear-hook type
HS-95: Neck-arm type
HS-97: Throat microphone
VS-1L: VOX/PTT switch box for hands-free operation, etc.
- **FA-SC73US** STUBBY ANTENNA
Shorter UHF antenna. Frequency range: 450–490 MHz
- **FA-SC25U** FLEXIBLE ANTENNA
UHF antenna. Frequency range: 400–430 MHz
- **FA-SC57U** FLEXIBLE ANTENNA
UHF antenna. Frequency range: 430–470 MHz

Some options may not be available in some countries. Please ask your dealer for details.



We Icom Inc. Japan
 1-1-32, Kamiminami, Hirano-ku
 Osaka 547-0003, Japan

Declare on our sole responsibility that this equipment complies with the essential requirements of the Radio and Telecommunications Terminal Equipment Directive, 1999/5/EC, and that any applicable Essential Test Suite measurements have been performed.

Kind of equipment: UHF TRANSCEIVER

Type-designation: IC-F44GT/GS

400-470 MHz 12.5 kHz/20 kHz/25 kHz

Version (where applicable):

This compliance is based on conformity with the following harmonised standards, specifications or documents:

- i) EN 301 489-1 v1.3.1 (Sept 2001)
- ii) EN 301 489-5 (August 2000)
- iii) EN 60950 (August 1992+A11)
- iv) EN 300 086-2 (March 2001)
- v) EN 300 219-2 (March 2001)
- vi) EN 300 113-2 (March 2001)

DECLARATION OF CONFORMITY

CE0168 ⚠

Düsseldorf 30th Apr. 2004
 Place and date of issue

Icom (Europe) GmbH
 Himmelgeister straÙe 100
 D-40225 Düsseldorf
 Authorized representative name

H. Ikegami
 General Manager

Signature

Icom Inc.



CE versions of the IC-F44GT/GS which display the “CE” symbol on the serial number seal, comply with the essential requirements of the European Radio and Telecommunication Terminal Directive 1999/5/EC.



This warning symbol indicates that this equipment operates in non-harmonised frequency bands and/or may be subject to licensing conditions in the country of use. Be sure to check that you have the correct version of this radio or the correct programming of this radio, to comply with national licensing requirement.

Count on us!

< Intended Country of Use >

- GER FRA ESP SWE
 AUT NED POR DEN
 GBR BEL ITA FIN
 IRL LUX GRE SUI
 NOR

A-6580H-1EU-②
Printed in Japan
© 2007–2009 Icom Inc.

Printed on recycled paper with soy ink.

Icom Inc.

1-1-32 Kamiminami, Hirano-ku, Osaka 547-0003, Japan