

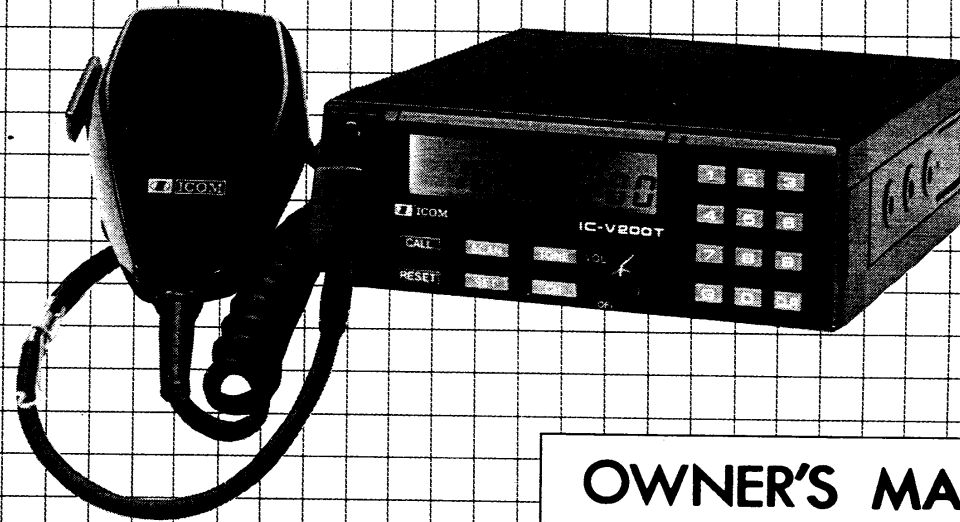

VHF FM TRANSCEIVER

# IC-V200T



**OWNER'S MANUAL**

## FOREWORD

Thank you for choosing the ICOM IC-V200T, one of the most advanced VHF mobiles equipped with a 5-Tone function on the Land Mobile market today.

Utilizing sophisticated computer based technology and ICOM's precision VHF engineering, the IC-V200T incorporates state-of-the-art design concepts and covers 146 ~ 174MHz frequency range to meet the demanding needs and requirements of the Land Mobile user.

## UNPACKING

ACCESSORIES	QTY.
① Micropone (HM-45) . . . . .	1
② DC power cable (OPC-044A) . . . . .	1
③ Mounting bracket . . . . .	1
④ Mounting support plate . . . . .	1
⑤ Mounting bracket screws . . . . .	4
⑥ Mounting screws (M5 x 20) . . . . .	4
⑦ Mounting self-tapping screws (5 x 16 AO) . . . . .	4
⑧ Mounting nuts (M5) . . . . .	4
⑨ Flat washers (M5) . . . . .	8
⑩ Flat washers (M4) . . . . .	4
⑪ Star washers (M5) . . . . .	4
⑫ Spare fuses (10A) . . . . .	2
⑬ External speaker plug . . . . .	1
⑭ Allen key wrench . . . . .	1
⑮ Microphone hanger . . . . .	1
⑯ Self-tapping screws (M4 x 10) . . . . .	2
⑰ Flat washers (M4) . . . . .	2

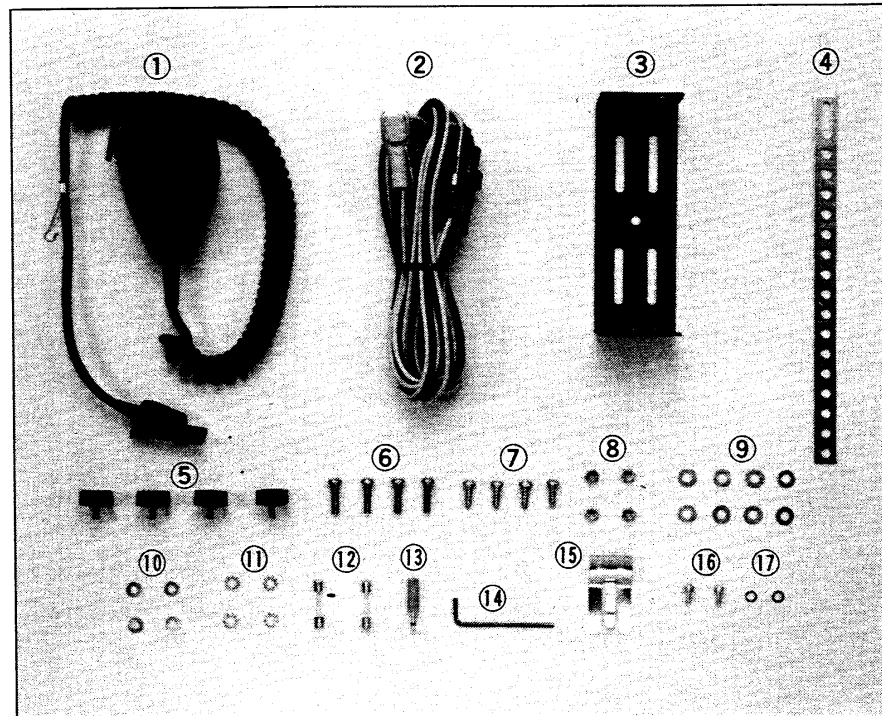

## TABLE OF CONTENTS

<b>SECTION 1</b>	<b>GENERAL OPERATIONS</b> .....	<b>1</b>
1-1	RECEIVING .....	1
1-2	TRANSMITTING .....	3
1-3	CHANNEL SELECTING .....	4
<b>SECTION 2</b>	<b>FUNCTION OPERATIONS</b> .....	<b>5</b>
2-1	GROUP CALL .....	5
2-2	5-TONE CODE SELECTION .....	5
2-3	SCANNING .....	6
2-4	CHANNEL LOCKOUT .....	7
<b>SECTION 3</b>	<b>CONTROL FUNCTIONS</b> .....	<b>8</b>
<b>SECTION 4</b>	<b>INSTALLATION</b> .....	<b>11</b>

## SECTION 1 GENERAL OPERATION

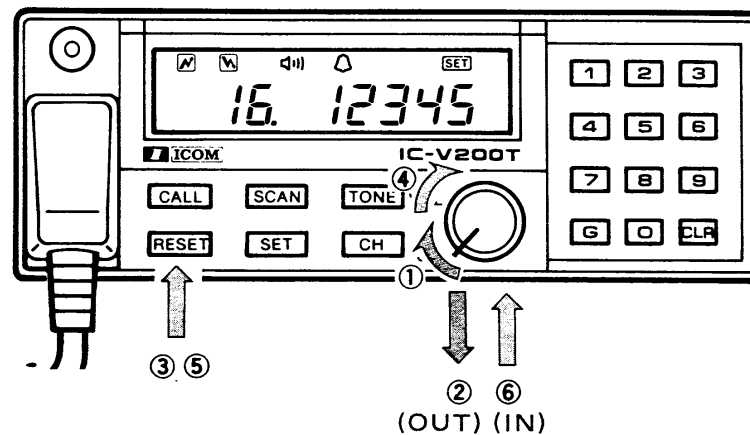

### 1 - 1 RECEIVING

- 1) Turn power ON.
  - 2) Pull [VOL] CONTROL OUT.
  - 3) Push [RESET] SWITCH.
  - 4) Adjust [VOL] CONTROL.
  - 5) Push [RESET] SWITCH.
  - 6) Push [VOL] CONTROL IN.
- 1) Rotate the [VOL] CONTROL clockwise, to turn power ON.
  - 2) Pull the [VOL] CONTROL OUT to open the squelch function.
  - 3) Push the [RESET] SWITCH to turn ON the monitor function.
  - 4) Adjust the [VOL] CONTROL clockwise to a comfortable listening level.
  - 5) Push the [RESET] SWITCH to turn OFF the monitor function.
  - 6) Push the [VOL] CONTROL to close the squelch function.





7) When an individual code is received.

7) When the IC-V200T receives an **individual code**, the transceiver may be activated as follows depending on the pre-programming:

- “” appears on the FUNCTION DISPLAY.
- An ALARM sound (one beep tone or a repetition of beep tones) is emitted.
- An answer back code is transmitted automatically.
- The last digit of the calling station’s 5-Tone code is displayed.
- The monitor function is ON, and “” appears.

8) When a group call code is received.



8) When the IC-V200T receives a **group call code**, the transceiver may be activated as follows:

- “” appears on the FUNCTION DISPLAY.
- ALARM sounds (a repetition of beep tones) are emitted.
- The monitor function is ON, and “” appears.

9) Push [RESET] SWITCH.

9) After finishing your communication, push the [RESET] SWITCH again and wait for the next call.

## 1 - 2 TRANSMITTING

- 1) Select a 5-Tone code.
  - 2) Push [CALL] SWITCH.
  - 3) Push [PTT] SWITCH.
  - 4) Release [PTT] SWITCH.
  - 5) Push [RESET] SWITCH.
- 1) Select the pre-programmed individual code by using the 10-KEY BOARD.
  - 2) Push the [CALL] SWITCH to transmit an individual code.
  - 3) Push the [PTT] SWITCH on the microphone to begin transmitting. Speak into the microphone using your normal voice level.
    - “” appears on the FUNCTION DISPLAY during transmission.
  - 4) Release the [PTT] SWITCH to return to receiving.
    - The monitor function turns ON automatically and “” appears on the FUNCTION DISPLAY.
  - 5) Push the [RESET] SWITCH and wait for the next call after finishing your communication.

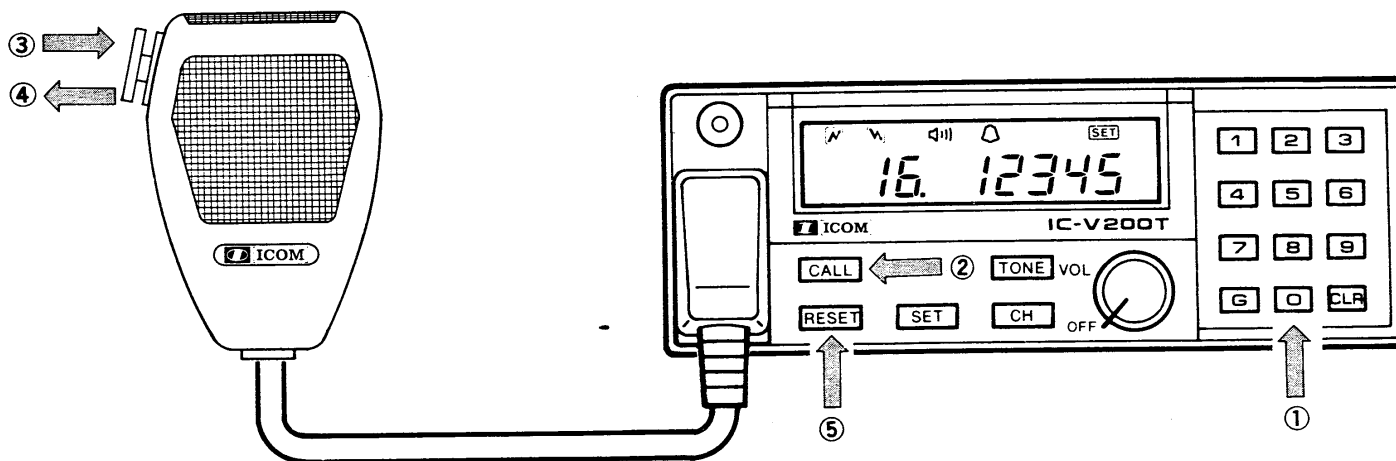

6) Special functions.

6) The functions below can be programmed by your dealer or ICOM Service Center.

• **TIME-OUT TIMER:**

Automatically turns OFF the transmitter 60 seconds after transmitting has started.

• **TRANSMIT INHIBIT:**

Inhibits transmitting by selecting receive only channels.

**CAUTION:** DO NOT transmit while "W" appears as your transmission may interfere with other radio communications.

### 1 - 3 CHANNEL SELECTING

1) Push [CH] SWITCH.

1) Push the [CH] SWITCH to clear the channel number.

2) Enter channel number.

2) Enter the desired channel number with two digits using the 10-KEY BOARD.

If a channel number is not entered, the FUNCTION DISPLAY returns to the previous channel after 5 seconds.

• If a non-programmed channel is keyed in, this entry is rejected and the FUNCTION DISPLAY automatically reverts back to the previous channel.

#### CH SET EXAMPLE:

Selecting channel 2.

Push keys

CH

0

2

Display

01.54210

-- 54210

0- 54210

02.54210

## SECTION 2 FUNCTION OPERATIONS

### 2 - 1 GROUP CALL

Group call selecting allows you to call several stations at the same time which have the same operating channels and same first digits (1 ~ 4) in a receive 5-Tone code pre-programmed by your ICOM Service Center (not the same as the displayed 5-Tone number).

- 1) Push the [CLR] KEY one or two times depending on your required group call.
- 2) Push the [G] KEY the same number of times as the [CLR] KEY.
- 3) Transmit the group call code by pushing the [CALL] SWITCH.

**GROUP EXAMPLE:** Calling 2613X group.

Push keys and switch

Display

02. 26 13 1

02. 26 13 -

02. 26 13 0

02. 26 13 0

26 130

26 139

### 2 - 2 5-TONE CODE SELECTION

If a 5-Tone code is not entered, the FUNCTION DISPLAY returns to the previous channel after 5 seconds.

- 1) Push the [TONE] SWITCH. A 5-Tone code disappears.
- 2) Enter the desired 5-Tone code with 5 digits using the 10-KEY BOARD.
- 3) When changing the last few digits, push the [CLR] KEY a few times and enter the new number.



**STONE EXAMPLE 1:**

Entering 5-Tone code 23456.

Push keys and switch

Display

02. 26131

TONE

02. -----

2

02. 2-----

3

4

02. 234--

5

6

02. 23456

**STONE EXAMPLE 2:**

Changing a 5-Tone code from 23456 to 23460.

Push keys

Display

02. 23456

CLR

02. 2345-

CLR

02. 234--

6

02. 2346-

0

02. 23460

**2 - 3 SCANNING**

The IC-V200T is equipped with a scan function for sampling each of the pre-programmed channels. When the transceiver receives an individual code, the scan will stop to monitor the received channel.

1) Push the [RESET] SWITCH if "𐀀" is displayed on the FUNCTION DISPLAY.

- "𐀀" disappears.

2) Push the [SCAN] SWITCH. Scanning begins from the displayed channel.

- The scan stops on a channel when it receives an individual code.



# SECTION 3 CONTROL FUNCTIONS

## FRONT PANEL

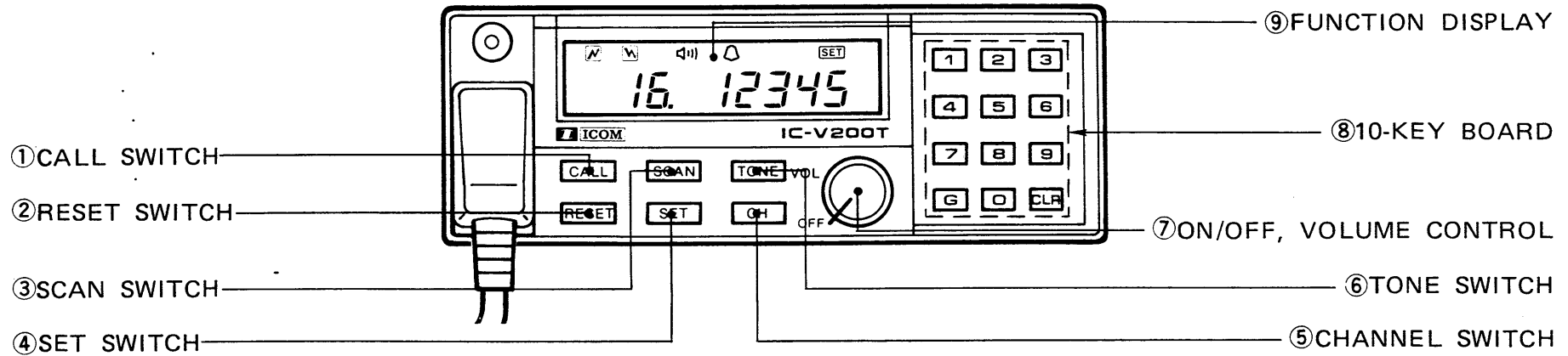

## REAR PANEL

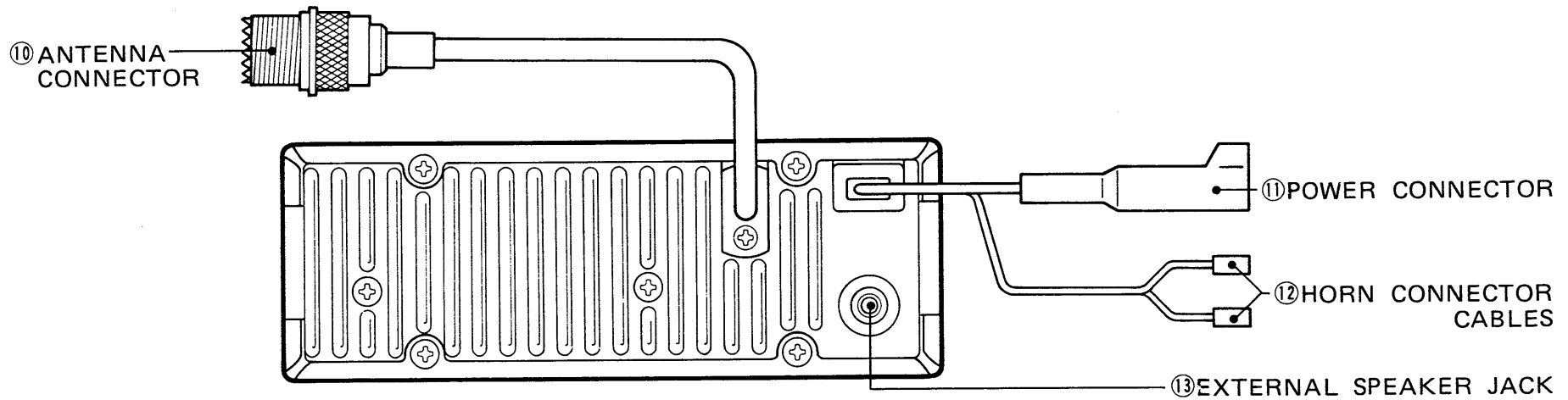

① CALL SWITCH [CALL]

Push this switch to transmit a 5-Tone code.

② RESET SWITCH [RESET]

Push this switch to turn ON and OFF the MONITOR function and to return to normal operations.

③ SCAN SWITCH [SCAN]

Push this switch to start and stop scanning when “” does not appear on the FUNCTION DISPLAY.

④ SET SWITCH [SET]

This switch is used when selecting the lockout scan channel.

⑤ CHANNEL SWITCH [CH]

Push this switch to clear channel number.

⑥ TONE SWITCH [TONE]

Push this switch to clear the 5-Tone code.

⑦ ON/OFF, VOLUME CONTROL [VOL]

Rotate this control clockwise to turn the transceiver ON and increase the audio level.

This is also the squelch switch. Pull the control toward you to open the squelch and push IN to close the squelch.

⑧ 10-KEY BOARD

Channel numbers, 5-Tone codes, and group call codes are entered by the 10-key board.

⑨ FUNCTION DISPLAY

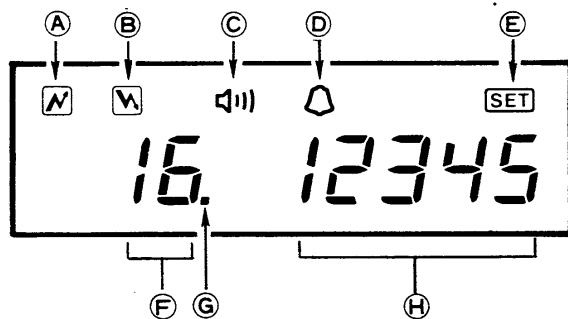

Ⓐ TRANSMIT INDICATOR

“” appears when transmitting.

Ⓑ BUSY INDICATOR

“” appears when a signal is received.

Ⓒ MONITOR INDICATOR

“” appears when the monitor function is ON.

④ **CALL INDICATOR**

"🔔" appears when an individual code is received.

⑤ **SET MODE INDICATOR**

"SET" appears when the transceiver is in SET mode (used to program the lockout channel).

⑥ **CHANNEL INDICATOR**

Displays the operating channel number.

⑦ **SCAN CHANNEL INDICATOR**

"■" appears when a channel is NOT locked out.

⑧ **5-TONE CODE INDICATOR**

Displays the transmit 5-Tone code (an individual code).

⑩ **ANTENNA CONNECTOR**

This connector connects an antenna cable with a PL-259 type connector.

⑪ **POWER CONNECTOR**

This connector connects the supplied power cable to a 13.8V DC power source.

⑫ **HORN CONNECTOR CABLES**

These cables connect the transceiver to an external horn which acts as an alarm when two of the four individual codes are received. The Horn-Honk function can be pre-programmed by an authorized service center.

⑬ **EXTERNAL SPEAKER JACK**

This jack is used for connecting an external speaker and accepts 2 ~ 8Ω speakers.

## SECTION 4 INSTALLATION

### ■ VEHICLE INSTALLATION

1. Select a location that can support the weight of the transceiver, and does not interfere with driving in any way.
2. Place the mounting bracket in a suitable mounting location and mark the screw holes on the bracket. Make sure the controls and switches can be handled easily, and the display can be clearly seen at the selected location.
3. Drill the holes and mount the bracket as shown in the diagram. Tighten the screws.

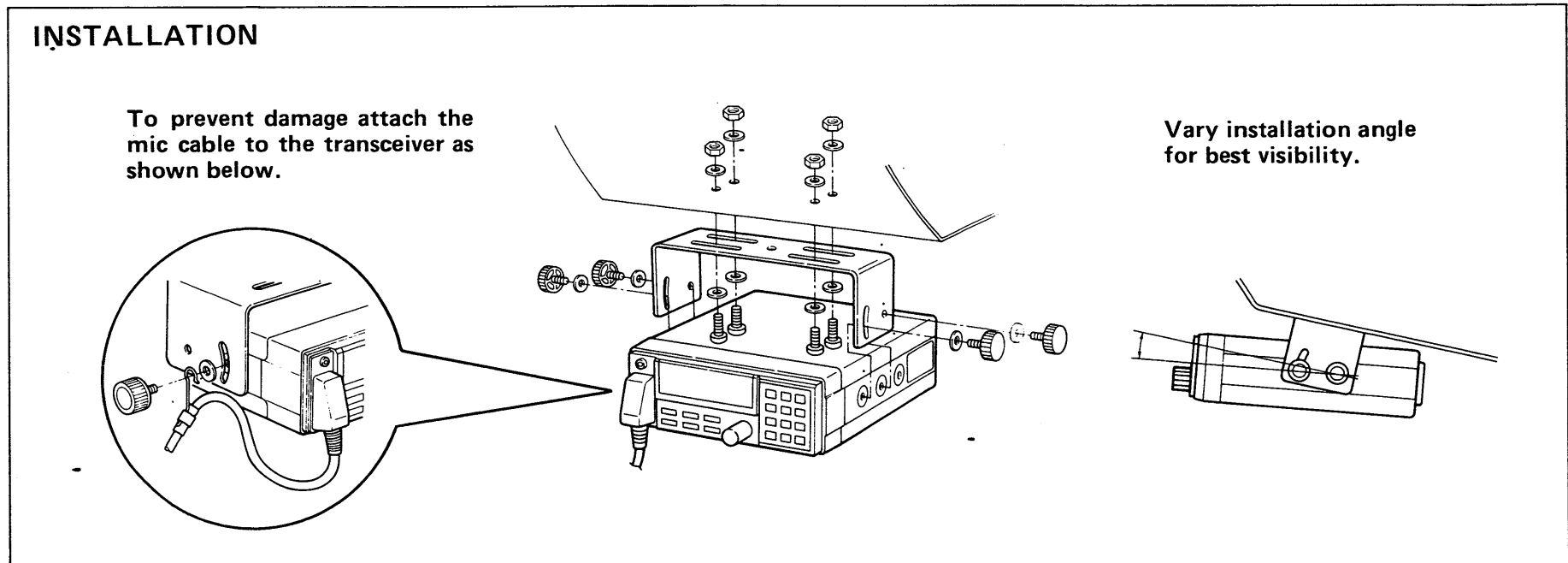

## ■ POWER REQUIREMENTS

The transceiver is supplied ready to operate from any regulated 13.8V DC, 7A negative ground source. A 12V, negative ground system works well as a power source.

**CAUTION:** Voltages greater than 15V DC will damage your transceiver. Check the source voltage before connecting the power cable.

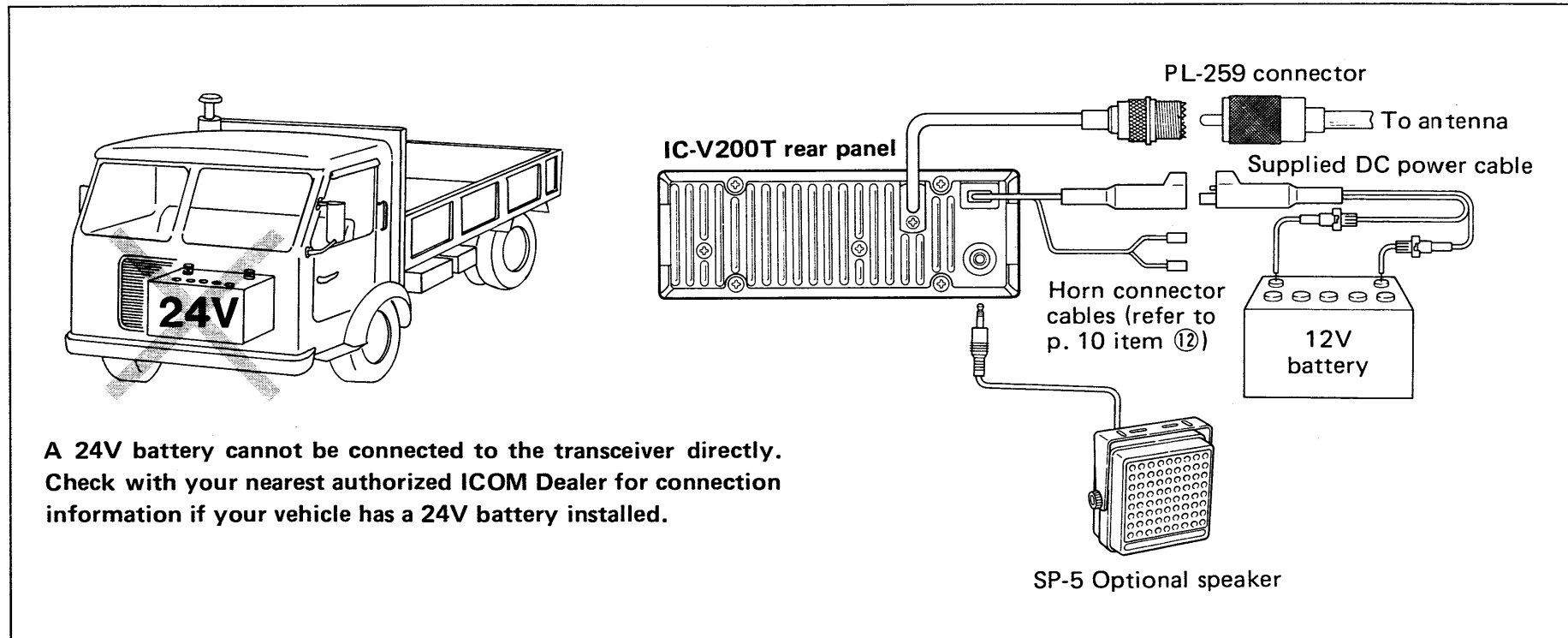



**ICOM**

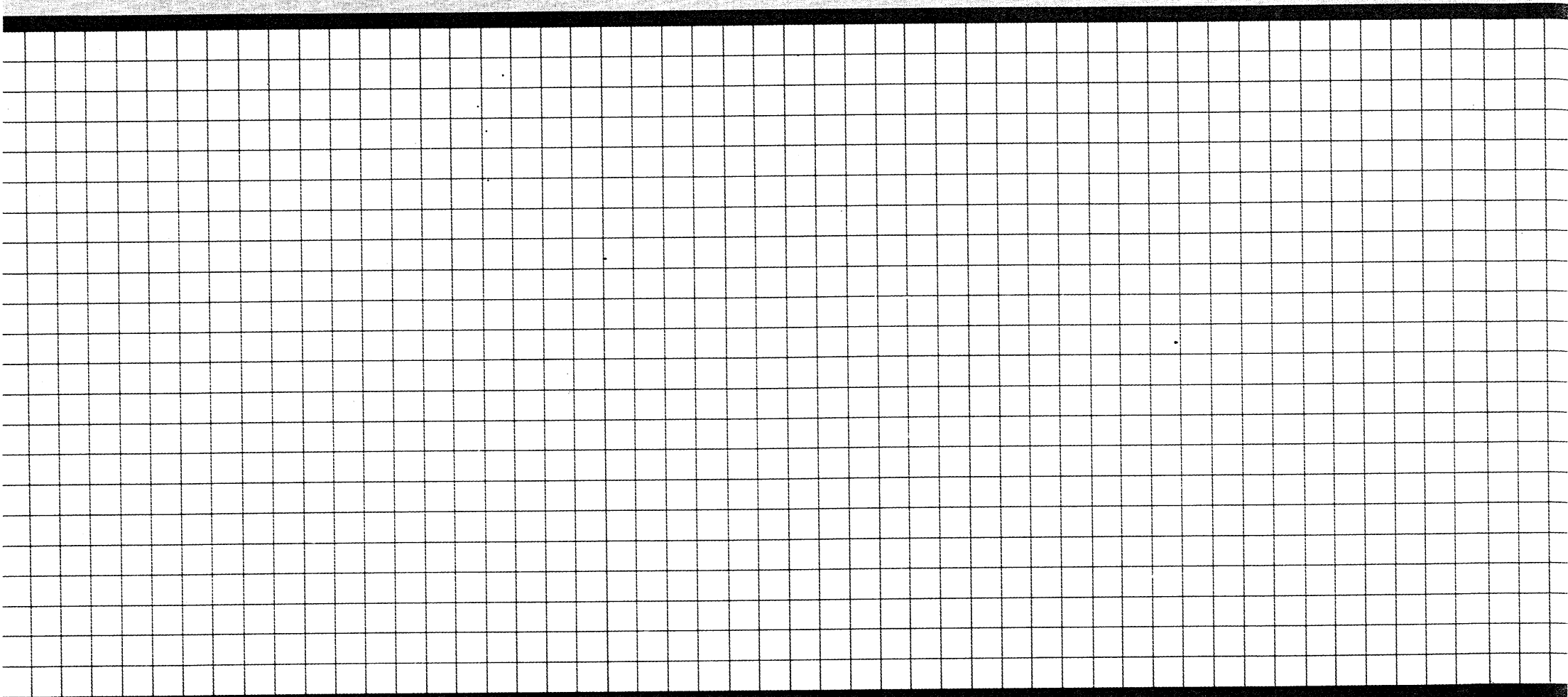

**ICOM INCORPORATED**

1-6-19, KAMIKURATSUKURI, HIRANO-KU  
OSAKA 547, JAPAN

A-0889  
Printed in Japan