

ICOM

INSTRUCTION MANUAL

VHF FM TRANSCEIVER
IC-V200

UHF FM TRANSCEIVER
IC-U200

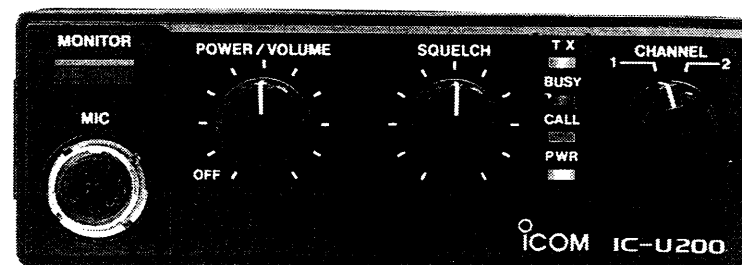

Icom Inc.

UNPACKING

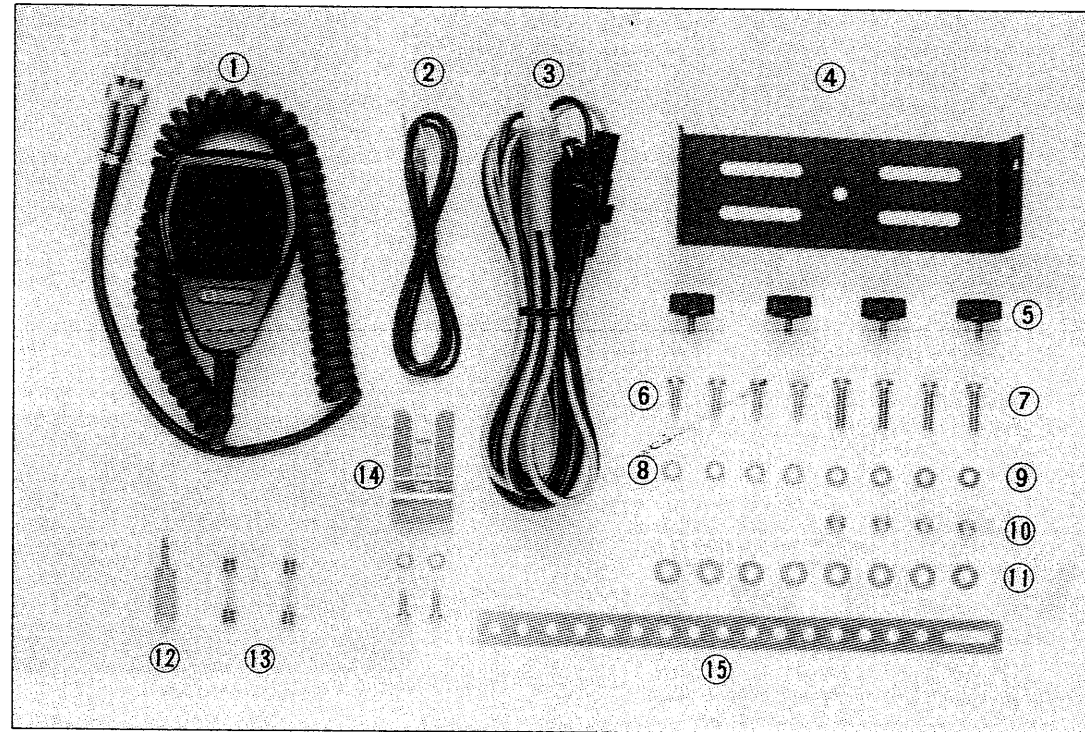

Accessories included with the IC-V200/IC-U200 Qty.

① Microphone (HM-42)	1
② Microphone hanger cable (OPC-049)	1
③ DC cable (OPC-044A)	1
④ Mounting bracket (B)	1
⑤ Mounting bracket knobs	4
⑥ Mounting self-tapping screws (5 x 16 A0)	4
⑦ Mounting screws (M5 x 20)	4
⑧ Star washers (M5)	4

Qty.

⑨ Flat washers (M4)	4
⑩ Mounting nuts (M5)	4
⑪ Flat washers (M5)	8
⑫ External speaker plug	1
⑬ Spare fuses (10A)	2
⑭ Microphone hanger	1
⑮ Mounting support plate	1

FOREWORD

Thank you for selecting the ICOM IC-V200/IC-U200, one of the most technologically advanced mobiles on the Land Mobile market today.

Utilizing sophisticated computer-based technology and ICOM's precision VHF/UHF engineering, the IC-V200/IC-U200 incorporates state-of-the-art design concepts to meet the demanding needs of the Land Mobile user.

TABLE OF CONTENTS

1. INSTALLATION	1
VEHICLE INSTALLATION.....	1
POWER REQUIREMENTS	2
ANTENNA	2
2. CONTROL FUNCTIONS	3
FRONT PANEL.....	3
REAR PANEL.....	4
3. OPERATION	5
RECEIVING	5
TRANSMITTING	7
HORN-HONK FUNCTION.....	8
4. SPECIFICATIONS	9
5. OPTIONS AND PRODUCTS	10

1. INSTALLATION

VEHICLE INSTALLATION

1. Select a location that can support the weight of the transceiver, and does not interfere with your driving in any way.
2. Place the mounting bracket in a suitable mounting location and mark the screw holes on the bracket. Make sure the controls and switches can be handled easily, and the display can be clearly seen at the selected location.
3. Drill the holes and mount the bracket as shown in the diagram. Tighten the screws.

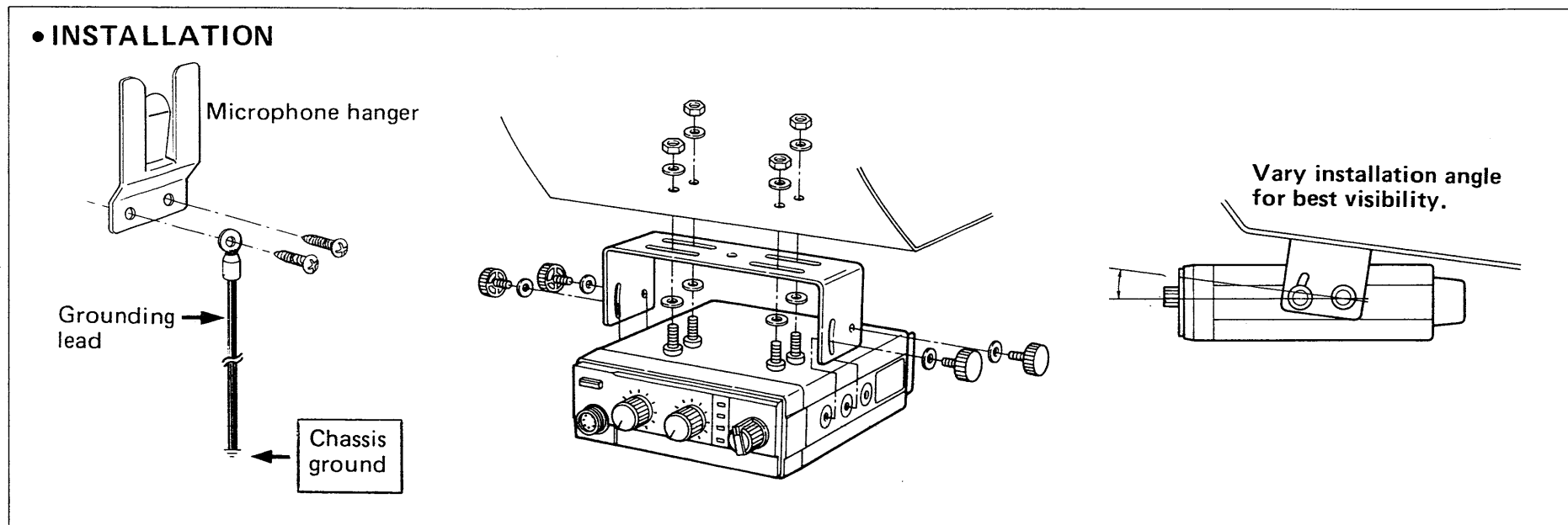

POWER REQUIREMENTS

The transceiver is ready to operate from any regulated 13.8V DC, 7A negative ground source. A 12V, negative ground system works well as a power source.

CAUTION: Voltages greater than 16V DC will damage your transceiver. Check the source voltage before connecting the power cable.

• CONNECTIONS

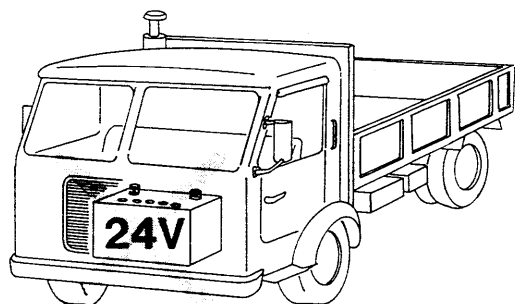

A 24V battery cannot be connected to the transceiver directly. Ask your ICOM Dealer or Service Center for installation information if your vehicle has a 24V battery installed.

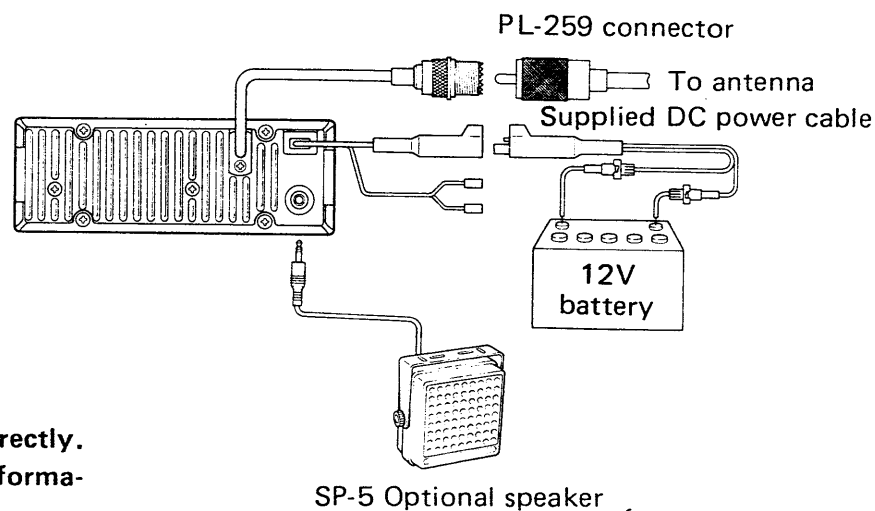

ANTENNA

The single, most important item that influences the performance of any communication system is the antenna. A high-quality, 50Ω 5/8 wavelength antenna is recommended for mobile applications.

2. CONTROL FUNCTIONS

FRONT PANEL

POWER/VOLUME CONTROL

Turns ON and OFF the transceiver and varies the audio output level.

MONITOR SWITCH

Turns the monitor function ON and OFF. (p. 6)

MIC CONNECTOR

SQUELCH CONTROL

Sets the squelch threshold level, muting incoming weak signals. (p. 5)

POWER INDICATOR

Lights up when the [POWER/VOLUME] CONTROL is turned ON.

TRANSMIT INDICATOR

Lights up when the transceiver is transmitting. (p. 7)

CHANNEL SELECT SWITCH

Selects an operating channel.

BUSY INDICATOR

Lights up when the transceiver is receiving signals or the squelch is open. (p. 5)

CALL INDICATOR

Lights up when a signal is received with the same programmed tone in the transceiver. (p. 6)

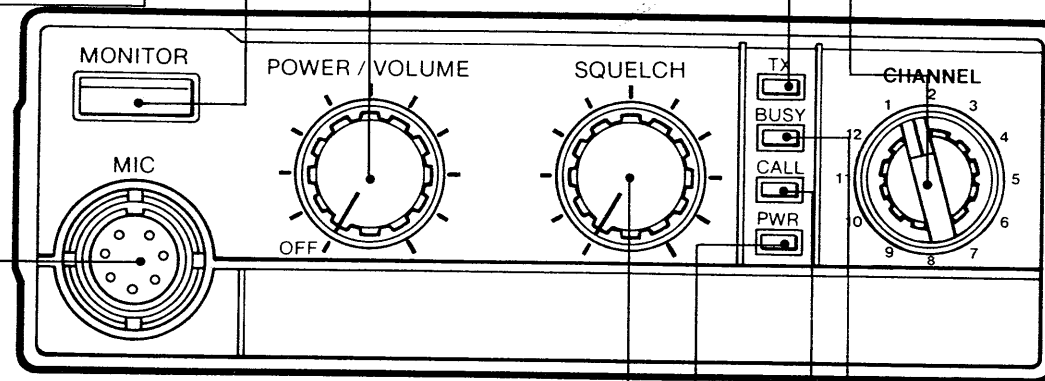

REAR PANEL

ANTENNA CONNECTOR

Connect an antenna here using a PL-259 type connector. (p. 2)

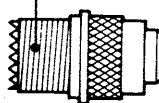

POWER CONNECTOR

Connects the supplied power cable to a 13.8V DC power source. (p. 2)

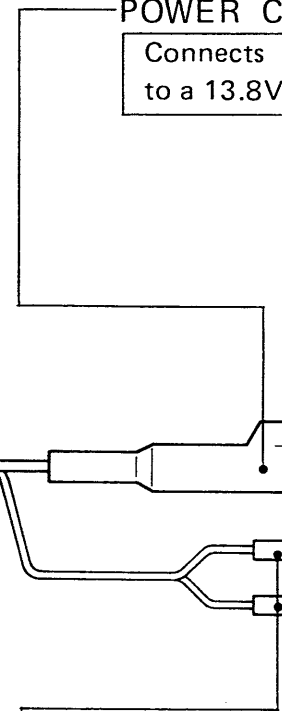

EXTERNAL SPEAKER JACK

Accepts a 2 ~ 8Ω external speaker. (p. 2)

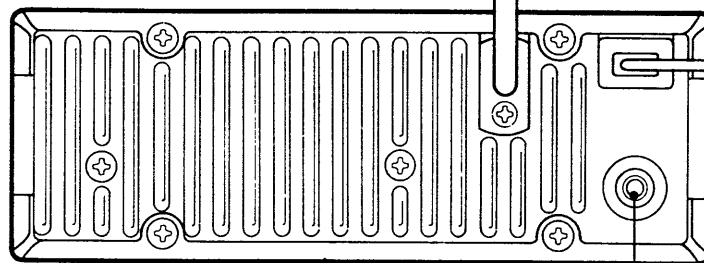

HORN CONNECTOR CABLES

Connects to an external horn which acts as an alarm when optional UT-32 or UT-33 is installed. (p. 8)

3. OPERATION

RECEIVING

(1) RECEIVER PRESETTINGS

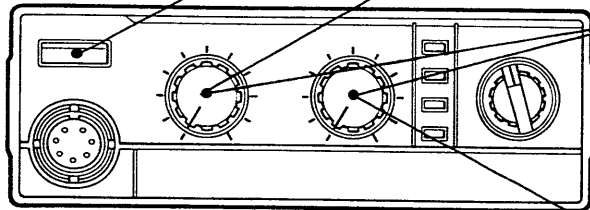

① Push the [MONITOR] SWITCH ON (IN position).

② Rotate the [POWER/VOLUME] CONTROL clockwise.

- [PWR] INDICATOR lights up.

③ ROTATE THE [SQUELCH] CONTROL fully counterclockwise.

- [BUSY] INDICATOR lights up. Rotate the [POWER/VOLUME] CONTROL clockwise to a comfortable listening level.

④ Rotate the [SQUELCH] CONTROL clockwise until the noise is quieted. This is the threshold point where signals can be received.

- The transceiver remains silent after this adjustment until a signal is received which opens the receiver's squelch circuit.

- If very weak and unwanted signals are received, rotate the [SQUELCH] CONTROL slightly more clockwise until the squelch operates correctly.

(2) RECEIVING

The following procedures should be started after finishing (1) RECEIVER PRESETTINGS on p. 5.

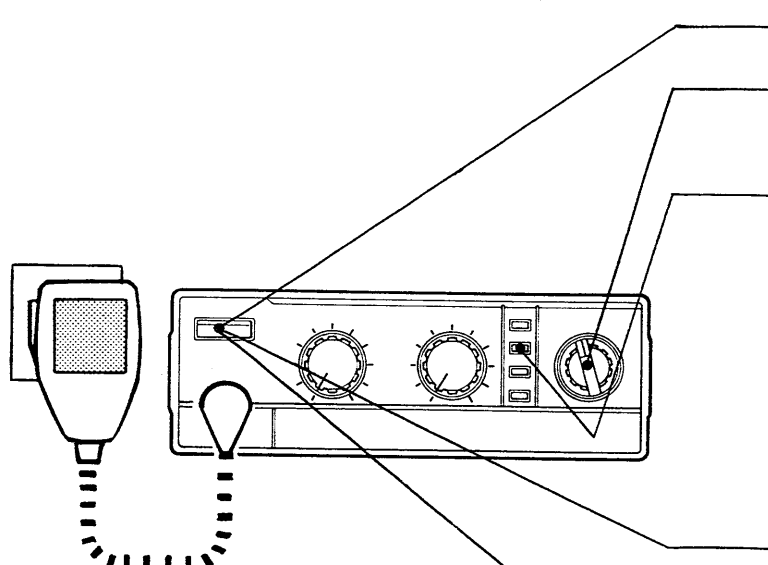
- 
- ① Push the [MONITOR] SWITCH OFF (OUT position).
- ② Choose a desired channel by using the [CHANNEL] SELECT SWITCH.
- ③ When a signal is received, the [BUSY] INDICATOR lights up and sound is emitted from the speaker.
- MONITOR FUNCTION:**
This function allows you to listen to a busy channel even if the microphone is placed in the microphone hanger or whether a tone is programmed for it or not on the channel.
- ④ Push the [MONITOR] SWITCH ON (IN position) to activate the monitor function. You can listen to a busy channel even if a tone is not programmed for it.
- ⑤ Push the [MONITOR] SWITCH OFF (OUT position) again to listen to a station with the same tone programmed as in your transceiver for normal operation.
- If the microphone is out of the hanger, the MONITOR FUNCTION remains ON whether the [MONITOR] SWITCH is ON or OFF.
 - The [CALL] INDICATOR lights up when a signal with a same tone programmed is received.

TRANSMITTING

The following transmitting procedures should be started after finishing the steps described in RECEIVING on p. 5.

CAUTION: DO NOT transmit when the [BUSY] INDICATOR is ON as your transmission may interfere with other radio communications.

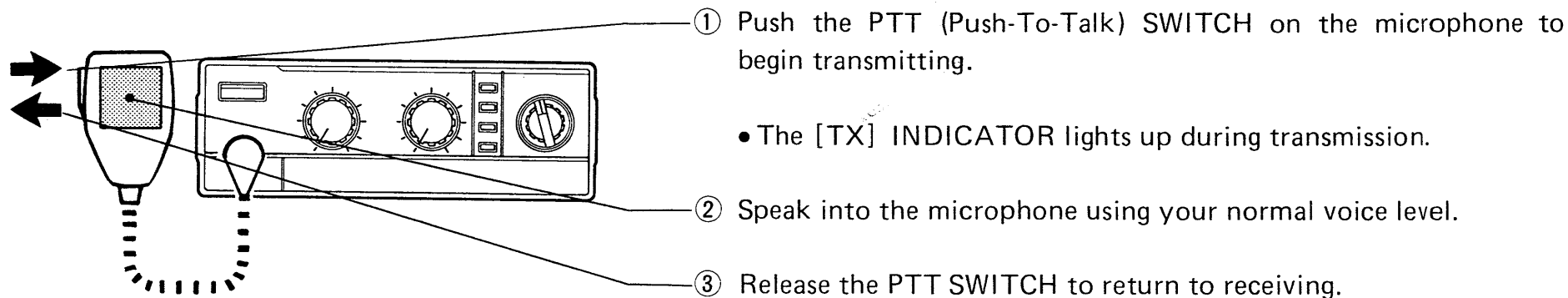

HORN-HONK FUNCTION

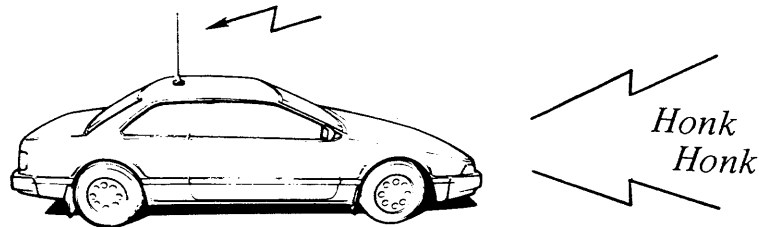

When a signal with a correct code number is decoded, the transceiver alerts the operator through a signalling device such as an automobile horn. This is useful when the operator is away from the operating position.

The optional UT-32 2-TONE DECODER UNIT or UT-33 2805Hz TONE DECODER UNIT must be installed to activate the HORN-HONK FUNCTION.

- The optional UX-11 HORN-HONK DRIVER UNIT is recommended for connecting the transceiver to the signalling device.

Consult your nearest ICOM Dealer or Service Center for installation details for the HORN-HONK FUNCTION.

4. SPECIFICATIONS

	IC-V200	IC-U200
GENERAL		
• Frequency coverage	148 ~ 160MHz } 156 ~ 168MHz } 25W Type 164 ~ 174MHz } 146 ~ 174MHz } 10W Type	470 ~ 490MHz 450 ~ 470MHz
• Emission type	16K0F3E 8K50F3E	16K0F3E
• Number of channels	12	2 or 12 (Two types available)
• Power supply requirement	13.8V DC \pm 15% (negative ground)	
• Usable temperature range	-30°C ~ +60°C	
• Dimensions	140mm(W) x 50mm(H) x 163mm(D)	140mm(W) x 50mm(H) x 179mm(D)
• Weight	1.3kg	
TRANSMITTER		
• RF output power	10W 25W	25W
• Frequency stability	0.0005%	
RECEIVER		
• Sensitivity	0.35 μ V for 12dB SINAD	
• Audio output power	3W at 10% distortion with a 4 Ω load	
• Audio output impedance	4 Ω	

5. OPTIONS AND PRODUCTS

- **UT-32**
2-TONE DECODER UNIT

The UT-32 is a 2-TONE decoder unit designed for interference-free communication with other stations equipped with a 2-TONE system and has 100 different, selectable tones available for your operating convenience.

Another convenient feature of the UT-32 is the vehicle horn honk function which is activated when the unit is connected to the horn honk output on the IC-V200/IC-U200 rear panel.

- **UT-33**
2805Hz TONE DECODER UNIT

The UT-33 is a sophisticated, high-tech 2805Hz TONE decoder unit that operates with the same functions as the UT-32.

- **HM-40**
DYNAMIC MICROPHONE

Equipped with a heavy-duty, durable body, this microphone also comes with a high-quality dynamic mic element installed.

- **HM-41**
DTMF MICROPHONE

This microphone is equipped with a DTMF pad which is used for accessing a telephone line.

- **SP-5**
EXTERNAL MOBILE SPEAKER

The SP-5 is a high-power output external mobile speaker that provides excellent audio clarity for more reliable communications.

- **UX-11**
HORN-HONK DRIVER UNIT

The UX-11 is a HORN-HONK DRIVER UNIT that connects the transceiver to a signalling device in a vehicle such as an automobile horn.

● **IC-U400**
UHF FM TRANSCEIVER

The IC-U400 is a 16-channel UHF transceiver that is suitable for use with the IC-U200. All 16 channels can be easily programmed by using an external plug-in keyboard programmer. Additional flexibility is possible with these transceivers by using the CK-12 remoting kit. This kit allows you to remove the front control panels from the transceivers for mounting in convenient locations.

● **IC-V100**
VHF FM TRANSCEIVER

The IC-V100 is a 16-channel VHF mobile transceiver that is ideal for communications with the IC-V200. Most features are identical to those offered with the IC-U400.

● **IC-H16**
VHF FM TRANSCEIVER

The IC-H16 is a 16-channel, fully synthesized VHF handheld transceiver that is ideal for use with the IC-V200. It features an advanced keyboard entry system plus cloning capability for rapid programming of your entire collection of transceivers. The IC-H16 is supported with a full line of interchangeable accessories.

● **IC-U16**
UHF FM TRANSCEIVER

Similar in design to the IC-H16, the IC-U16 operates in the UHF frequency range and can be used with an IC-U200 UHF transceiver. Most features are identical to those offered with the IC-H16, and all accessories are compatible with either transceiver.

● **IC-U2**
UHF FM TRANSCEIVER

The IC-U2 is an easy-to-operate handheld suitable for use with the IC-U200. The transceiver has 2 channels, a molded frame, is weatherproof, and operates in the UHF frequency range.

- **SM-12**
DESK MICROPHONE

- **PS-200**
EXTERNAL POWER SUPPLY

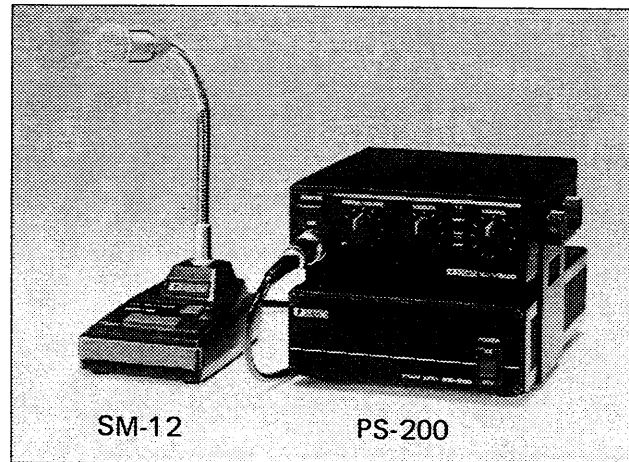

These options are available for base station use.

The SM-12 DESK MICROPHONE has a monitor switch for increased operating convenience.

The PS-200 EXTERNAL POWER SUPPLY utilizes a newly developed, innovative switching regulator system which results in consistently high quality power performances. The PS-200 is designed perfectly for use with the IC-V200/IC-U200.

Count on us!

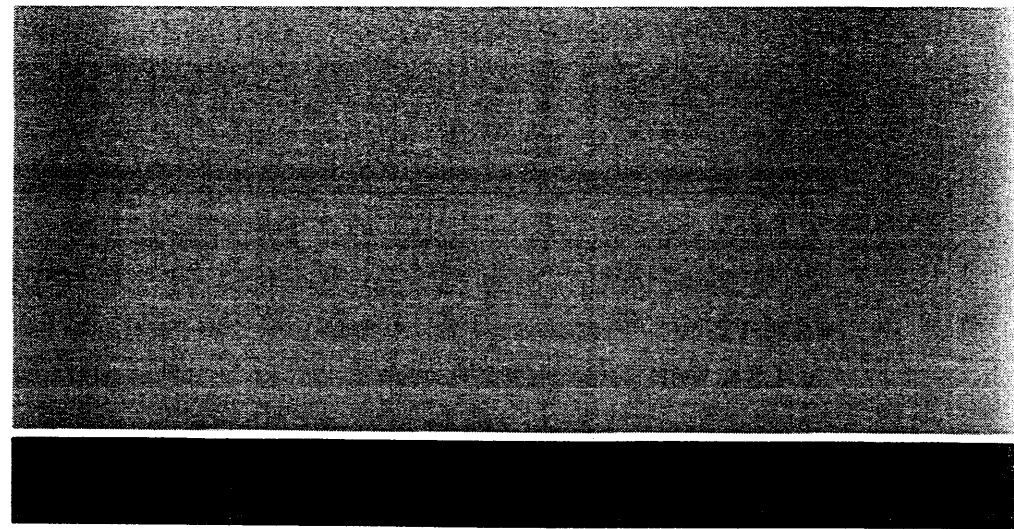

A-1012S-N-①
Printed in Japan
Copyright © 1988 by Icom Inc.

Icom Inc.
6-9-16, Kamihigashi, Hirano-ku, Osaka 547, Japan
