

SSB RADIOTELEPHONE

TKM-707

INSTRUCTION MANUAL

KENWOOD CORPORATION

KENWOOD

CAUTION

Long transmission or extended operation in the HI power mode might cause the rear of this SSB radiotelephone to get warm. Do not place the SSB radiotelephone where the heat sink (rear panel) might come in contact with plastic or vinyl surfaces.

The following explicit definitions apply in this manual;

NOTE If disregarded, inconvenience only, no risk of equipment damage or personal injury.

CAUTION Equipment damage may occur, but not personal injury.

Thank you for purchasing this new SSB radiotelephone.

IMPORTANT

Please read this instruction manual carefully before placing your SSB radiotelephone in service.

SAVE THIS INSTRUCTION MANUAL

CONTENTS

1. BEFORE OPERATION	3
2. SPECIFICATIONS and ACCESSORIES	4
2-1. SPECIFICATIONS	4
2-2. ACCESSORIES	4
3. INSTALLATION AND CONNECTION	5
3-1. INSTALLATION	5
3-2. CONNECTION	6
3-3. WITHOUT ANTENNA COUPLER	6
3-4. WITH ANTENNA COUPLER	6
4. OPERATION	7
4-1. OPERATING CONTROLS	7
4-2. RECEIVER OPERATION	10
4-3. TRANSMITTER OPERATION	12
4-4. MEMORY	14
4-5. SCAN	17
5. CIRCUIT DESCRIPTION	18
5-1. GENERAL	18
5-2. TRANSMIT CIRCUITS	18
5-3. RECEIVE CIRCUIT	19
5-4. LOCAL OSCILLATOR CIRCUITS	20
SCHEMATIC DIAGRAM	another sheet
6. MAINTENANCE and ADJUSTMENT	22
6-1. SERVICE	22
6-2. IN CASE OF DIFFICULTY	23
6-3. ADJUSTMENT	24
7. MARINE CHANNEL CHART	26
7-1. MEMORY CHANNEL GROUP	
A PRESET DATA	26
7-2. MEMORY CHANNEL GROUP	
B PRESET DATA	30
7-3. ITU CHANNEL DATA	34
8. EMERGENCIES	
(DISTRESS)	36

1. BEFORE OPERATION

TO PREVENT ELECTRIC SHOCK, FIRE AND OTHER INJURY. PLEASE NOTE THE FOLLOWING:

To avoid risk of electric shock, under no circumstances should the unit be opened.

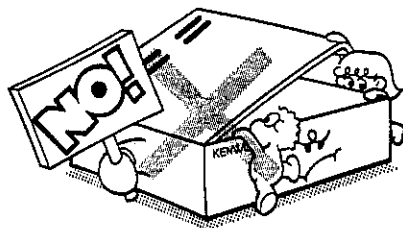

Do not place this unit, where it will be exposed to direct sunlight or close to heating appliances.

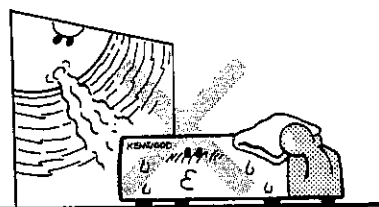

To ensure good ventilation, do not put anything on top of the cabinet and allow at least 15 cm (6 inches) of space behind the unit.

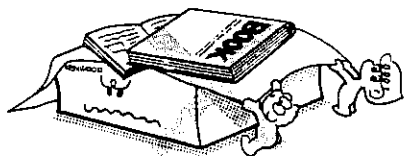

THE POWER REQUIREMENT IS 13.6 VDC.
Never attempt connection to a 24 VDC source.

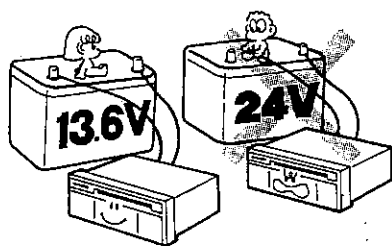

Do not place the unit in areas of excessive dust, high humidity or on unstable surfaces.

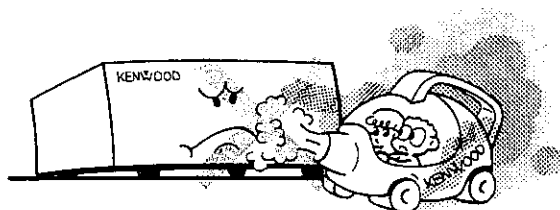

Do not drop pieces of metal, needles, coins and other electrically conductive materials into the unit.

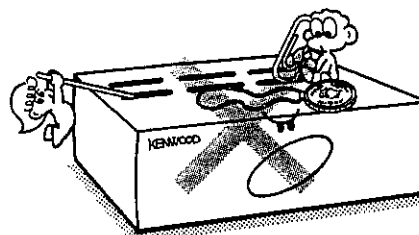

CLEANING

1. Turn the power off before cleaning the unit.
2. Do not use any type of abrasive pad, thinner, benzene or any substances which may damage the unit.
3. Wipe the front panel and other exterior surfaces of the unit with a soft dry cloth or soft cloth lightly moistened with water.



2. SPECIFICATIONS and ACCESSORIES

2-1. SPECIFICATIONS

Receiver Frequency range	500 kHz to 29.9999 MHz
Transmitter Frequency range	2.0 to 2.9999 MHz 4.0 to 4.9999 MHz 6.0 to 6.9999 MHz 8.0 to 8.9999 MHz 12.0 to 12.9999 MHz 16.0 to 16.9999 MHz 22.0 to 22.9999 MHz
Mode	J3E, H3E, CW
Antenna impedance	50 Ω
Power requirement	13.6 VDC ± 15%
Operating temperature	-30 °C to +60 °C (-22 °F to +140 °F)
Grounding	Negative
Current drain	RX max. less than 2 A TX max. less than 30 A
Frequency stability	± 20 Hz (After 10 minutes warm up)
Dimensions (mm)	W270 × H96 × D270
Weight	5.1 kg
Output power	HI ; 150 W PEP MEDIUM ; 50 W PEP LOW ; 25 W PEP
Spurious radiation	less than 65 dB
Microphone impedance	600 Ω
Circuitry	Double conversion superheterodyne
Intermediate frequency	1st ; 71.295 MHz 2nd ; 10.695 MHz
Sensitivity (12 dB SINAD)	500 kHz~1.9999 MHz J3E ; less than 1.0 μV H3E ; less than 5.6 μV 2 MHz~29.9999 MHz J3E ; less than 0.5 μV H3E ; less than 2.8 μV
Selectivity	-6 dB J3E ; more than 2.3 kHz H3E ; more than 6 kHz -60 dB J3E ; less than 4.6 kHz H3E ; less than 20 kHz
Spurious response	better than -70 dB
Output (10 % distortion)	more than 4 W
External speaker impedance	4 Ω

2-2. ACCESSORIES

Unpack your new SSB radiotelephone carefully and examine it for visible damage. If the equipment has been damaged in shipment, notify the transportation company immediately. Save the boxes and packing materials for future shipping.

The following accessories should have been included in the box with the SSB radiotelephone.

Microphone	T91-0388-05	1 ea.
Microphone hanger..	J19-1376-15	1 ea.
Tapping screw ...	N09-2106-05	3 ea.
Mounting bracket ...	J29-0446-02	1 ea.
Metal fittings ...	J30-0557-04	2 ea.
Flat head screw ..	N32-3006-41	4 ea.
Shoulder bolt	N08-0521-05	4 ea.
Rubber cushion ..	J02-0451-05	4 ea.
Screw kit	N99-0341-05	1 ea.
Flat washer			4 ea.
Self tapping screw			4 ea.
Spring washer.....			4 ea.
Bolt			4 ea.
Nut			4 ea.
DC cable.....	E30-2194-05	1 ea.
Fuse (30A).....	F05-3034-05	1 ea.
Wing bolt (Ground terminal)			
.....	N09-2080-05	1 ea.
Flat washer	N15-1040-60	2 ea.
External speaker plug			
.....	E12-0001-15	1 ea.
Fuse (4A).....	F06-4027-05	1 ea.
Instruction manual ..	B62-0139-XX	1 copy
Operating manual ..	B59-0435-XX	1 copy

3. INSTALLATION AND CONNECTION

3-1. INSTALLATION

■ MOUNTING BRACKET

When installing the SSB radiotelephone in a vessel consider ease of operation and safety when selecting the location for the mounting bracket.

1. Install the bracket using the supplied flat washers and self tapping screws, or spring washers and bolts (4 each).

You may attach the supplied rubber cushion to the bracket.

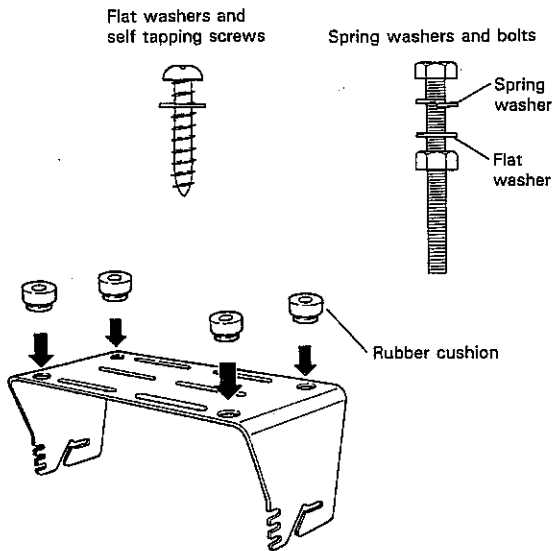

2. Attach the supplied metal fittings with the 4 flat head screws to the side of the radiotelephone.

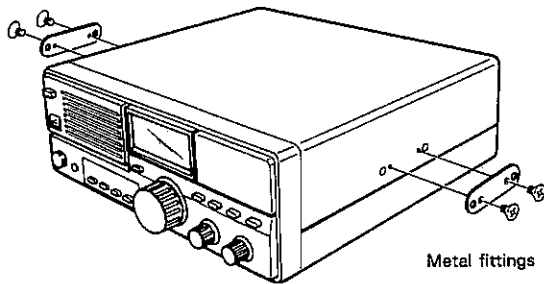

3. Attach the supplied shoulder bolts loosely 3, 4 mm away to the side of the radiotelephone.

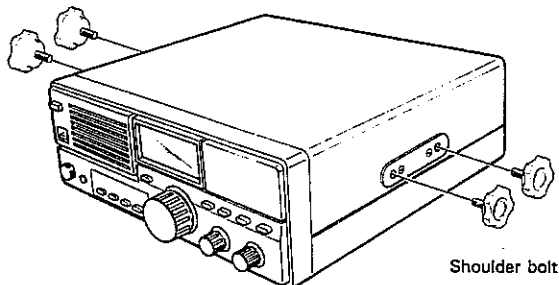

4. Align the grooves in the bracket with the rear shoulder bolts and slide the radiotelephone to the rear.

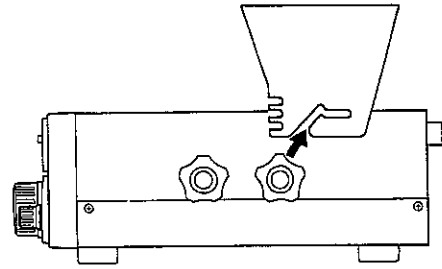

5. The angle of the bracket may be adjusted to three of possible viewing angles. Select the desired angle.

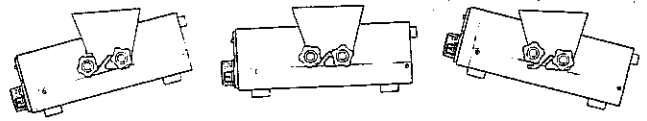

6. Hold the radiotelephone in place and tighten the shoulder bolt with knob.

■ MICROPHONE HANGER

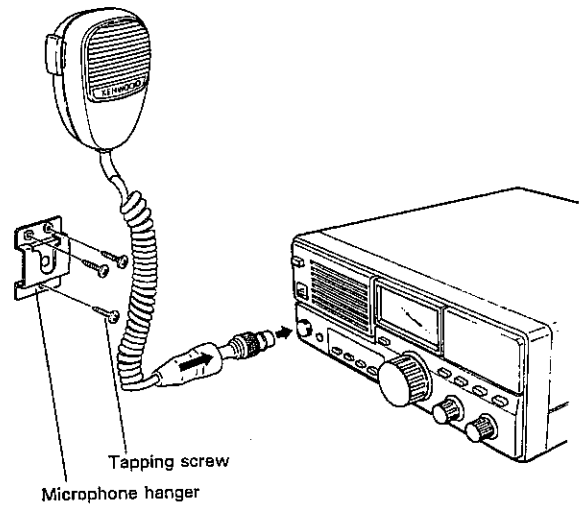

3-2. CONNECTION

This radiotelephone requires a maximum of 30 A at 13.6 VDC $\pm 15\%$ when transmitting at full power. Do not exceed the length of the supplied power cable.

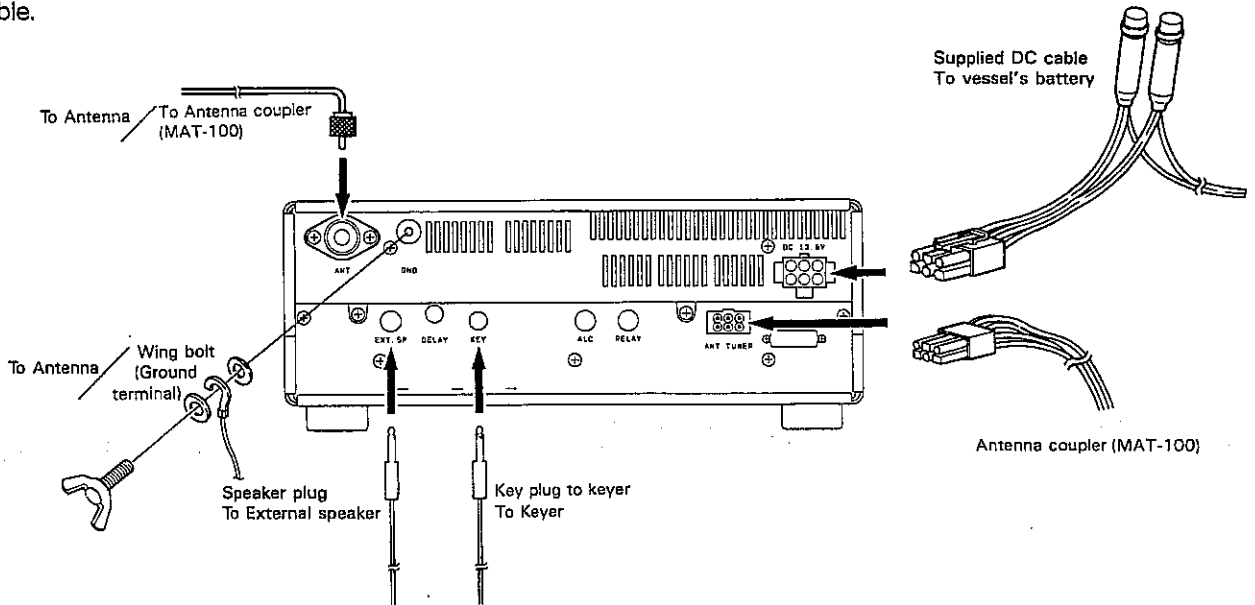

3-3. WITHOUT ANTENNA COUPLER

The type of antenna that is used will greatly affect the performance of the equipment. Use a properly adjusted antenna, of good quality, to enable your equipment to perform at its best. The antenna input impedance is 50 ohms. Use 50 ohm coaxial cable such as RG-8U or 8D-2V for this connection. If the antenna is far from the radiotelephone the use of low loss coaxial cable, such as RG-8U is recommended. Match the impedance of the coaxial cable and that of the antenna so that the SWR is less than 1.5. The protection circuit in the radiotelephone will activate if the SWR is particularly poor (greater than 3). High SWR values will cause the transmitter output to drop.

3-4. WITH ANTENNA COUPLER

A wire antenna must be in the range from 2 to 24 MHz and having a total length of 12 to 23 meters. When the radiotelephone is operated only on low frequencies, a longer antenna is preferable. The antenna should be erected as high as possible. The insulator should be able to withstand high transmitter power levels without leakage.

■ Typical Installation and Connection

Connect the Antenna connector of the radiotelephone to the RF IN jack with the coaxial cable such as, RG-8U are recommended. Connect the 6P connector of the supplied control cable to the radiotelephone. Please refer to the MAT-100 Instruction Manual to connect with the cable to the MAT-100.

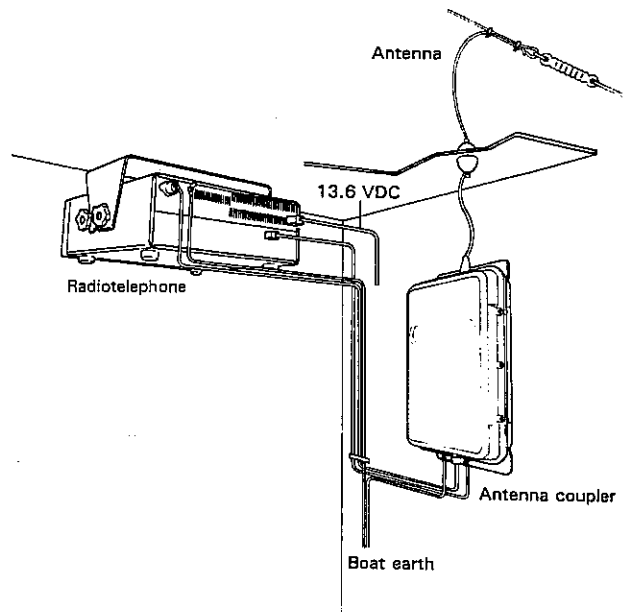

4. OPERATION

4-1. OPERATING CONTROLS

FRONT PANEL

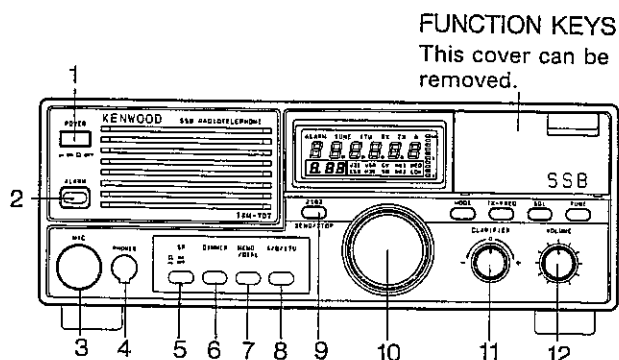

1. POWER switch

This key is used to turn ON the SSB radiotelephone.

2. ALARM key

Pressing this key will monitor the alarm tone. Pressing this key and the 2182 key simultaneously causes the SSB radiotelephone to be tuned to 2182 kHz (INTERNATIONAL DISTRESS FREQUENCY) and an alarm tone to be transmitted automatically.

3. MIC (MICROPHONE) connector

Attach the supplied microphone to this connector.

4. PHONES jack

Output terminal for headphones.

5. SP (SPEAKER) switch

This switch is used to turn the internal speaker off.

NOTE

If the switch is in the off position, the internal speaker is disabled completely and no signal will be heard through the internal speaker.

Check the position of the switch if no audio output is obtained from the internal speaker.

The external speaker is not affected by this switch.

6. DIMMER key

This key is used to select the desired display intensity (high, medium, low, or off).

7. MEMO/DIAL key

This key is used to switch between MEMORY channel or DIAL mode.

8. A/B/ITU key

This key is used to select Memory group A, B, or ITU memory.

9. 2182/SEND/STOP key

This key is used in conjunction with the ALARM key and is used to transmit or stop the 2182 kHz alarm tone on, the international distress and calling frequency.

10. CHANNEL selector

This control is used to select a MEMORY channel or DIAL channel.

11. CLARIFIER control

This control is used to clarify the receiving frequency when the incoming signal is slightly off frequency.

Rotating the control shifts the receive frequency to either side of the displayed frequency in 10 Hz steps up to a maximum of ± 250 Hz.

12. VOLUME control

Rotating the control clockwise will increase the volume.

FUNCTION KEYS

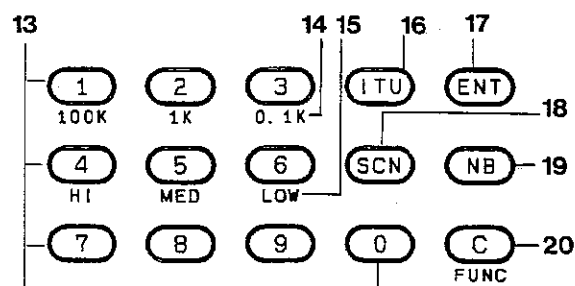

13. Numeric keys

These keys are used for directly entering a frequency, or for recalling a Memory channel.

14. 100k,1k, 0.1k keys

After pressing the C/FUNC key in the DIAL operating mode, these keys select 100 kHz, 1 kHz, or 0.1 kHz tuning increments.

15. HI, MED, LOW keys

Pressing the C/FUNC key and one of these keys in sequence selects the desired output power level.

16. ITU key

During memory channel operation this key is used to select either the memory channel display, or the frequency display.

17. ENT key
This key is used to begin direct keyboard entry of frequency, Memory Group A, B, or the ITU channel number into a memory channel .

18. SCN key
This key is used to initiate scan.

19. NB key
This key selects the desired Noise blanker mode; 1, 2, or off .

Noise blanker 1 For short duration pulse type noise, place the NB 1 switch ON.

Noise blanker 2 For long duration pulse type noise, like the woodpecker, place the NB 2 switch ON.

NOTE

If you use NB 2 for short duration pulse noise, the receive audio may become distorted, making it difficult to understand.

20. C/FUNC key
This key is used to release SCAN, memory entry, and to clear a frequency selection or memory channel selection when using the numeric keys.
This key is also used to activate control of the functions printed below the 1 thru 6 numeric keys.

After pressing the C/FUNC key press the any of the following numeric keys and then ENT key to select the appropriate function.

- 80 Beep ON
- 81 Beep OFF
- 82 When automatic antenna coupler is equipped, pressing the PTT switch activate the antenna coupler automatically.
- 83 Antenna coupler is not activated by pressing the PTT switch.

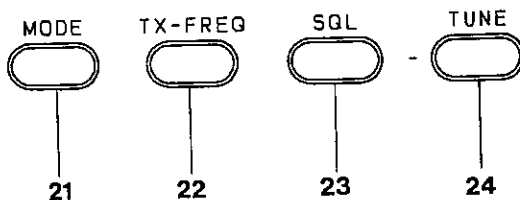

21. MODE key
This key is used to select USB (J3E), LSB (J3E receive only), H3E (receive only except 2182 kHz) or CW mode.

22. TX-FREQ key
This key is used to check transmit frequency for a clear frequency.

23. SQL key
This key is used to control the squelch circuit. When the squelch is turned on, the SQ indicator will light and the radiotelephone remains silent until a signal is received.

24. TUNE key
This key is used to engage the automatic antenna coupler.

DISPLAY PANEL

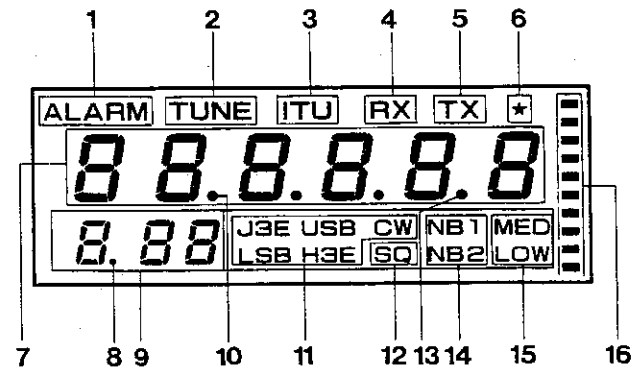

- 1. ALARM On during transmission of the 2182 kHz alarm tone.
- 2. TUNE Flashes during tuning. On continuously when a good match is obtained.
- 3. ITU On when the ITU channel mode has been selected. Flashes during ITU frequency entry .
- 4. RX On during receive. Flashes during receive frequency entry mode and MEMORY entry mode .
- 5. TX On during transmit. Flashes during transmit frequency entry mode.
- 6. ★ On when the clarifier is activate.
- 7. 8.8.8.8.8 Displays the operating channel number or frequency.
- 8. Receive only indicator Displays the receive only memory channel.

- | | | |
|---|--|--|
| <p>9. <i>ABB</i>
<i>bBB</i>
<i>ECH</i>
<i>F - -</i></p> | <p>Indicates the selected memory channel group and number.
On when the EMERGENCY channel is selected.
On during Function mode.</p> | <p>6. KEY jack
Using shielded line, connect a 1/4" phone plug to this jack for CW operation. Open-terminal voltage is approximately 5.5 VDC.
When using an electronic keyer, make sure that polarity is set for positive. Always use shielded line from the key to transceiver.</p> |
| <p>10. MHz dot</p> | <p>Flashes during scanning and memory entry mode.</p> | <p>7. ALC input
Provides connection for a linear amplifier control.</p> |
| <p>11. J3E/USB/LSB/H3E/CW</p> | <p>Indicates the selected mode.</p> | <p>8. RELAY terminal
This terminal provides a ground on transmit. Relay contact capacity is 30 VDC/0.5 A.</p> |
| <p>12. SQ</p> | <p>On when the squelch mode is on.</p> | <p>9. ANT TUNER (Antenna coupler) connector
Connect the Antenna coupler cable to this connector.</p> |
| <p>13. kHz dot</p> | <p>Flashes during scanning and memory entry mode.</p> | <p>10. FUSE 4A holder
Contains a 4 A fuse.</p> |
| <p>14. NB1/NB2</p> | <p>Indicates the selected noise blanker mode.</p> | |
| <p>15. MED/LOW</p> | <p>Indicates the selected output power level.</p> | |
| <p>16. level meter</p> | <p>Indicates the relative receive signal strength, or antenna current.</p> | |

REAR PANEL

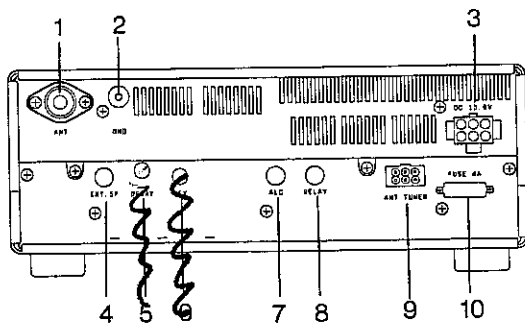

1. ANT (Antenna) connector
Attach an antenna with a low SWR and impedance of 50 Ohms.
2. GND terminal
3. 13.6 VDC power input connector
Connect the DC power cable to this connector.
4. EXT SP (External speaker) jack
Connect an external speaker to this connector. The speaker should have an impedance of 4 - 8 Ohms.
5. DELAY control
~~This control adjusts the "hang-time" that the radiotelephone will remain keyed after the key has been released.~~

4-2. RECEIVER OPERATION

This SSB radiotelephone will supply audio confirmation whenever a function is activated.
1 short beep ; Key operation accepted.

4-2-1. Mode and Channel Selection

- The desired MEMORY (group A and B) mode, the ITU channel mode, and the DIAL mode can be selected by using the following procedures.

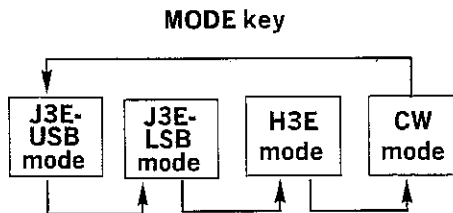
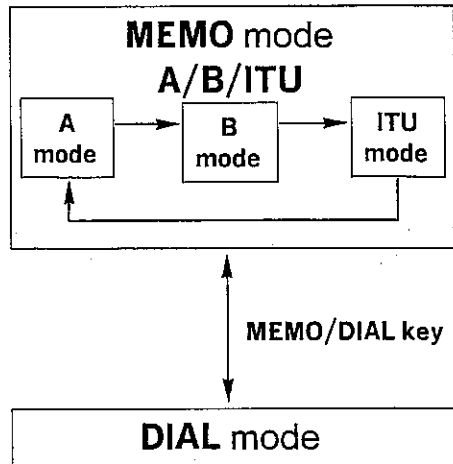

■ Emission mode

Mode designator	Description	General usage
J3E, USB	SSB Upper Side Band	Marine Mobile
J3E, LSB	SSB Lower Side Band	For example; Amateur
H3E	SSB with full carrier	Transmit (only 2182 kHz) Broadcast
CW	Morse Code Wave	Telegraph

The Channel selector may now be rotated to selecting the desired channel.
Channels selected in the DIAL mode can be stored in memory. (See 4-4-4. Memory Entry)

■ MEMO (ITU channel) mode

- Press the MEMO/DIAL key to select the MEMO mode.
- Press the A/B/ITU key to select the ITU Channel mode.
- Rotate the Channel selector to recall the desired ITU channel.

or for DIRECT KEYBOARD ENTRY

Enter the ITU Channel number and then press the ENT key within 10 seconds.

For example CH 1201

press ①, ②, ①, ①, and then within 10 seconds press the ENT key.

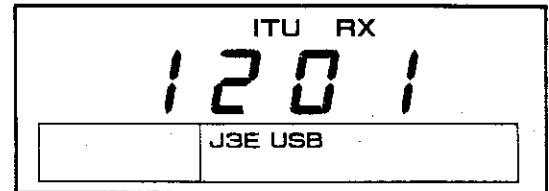

■ MEMO (A or B group) mode

- Press the MEMO/DIAL key to select the MEMO mode.
- Press the A/B/ITU key to select the desired Memory Channel group A or B.
- Rotate the Channel selector to recall the desired Memory channel.

or for DIRECT KEYBOARD ENTRY

Enter the desired memory channel number. Within 10 seconds of pressing the last channel number press the ENT key.

For example CH 1

Press ①, and then within 10 seconds press the ENT key.

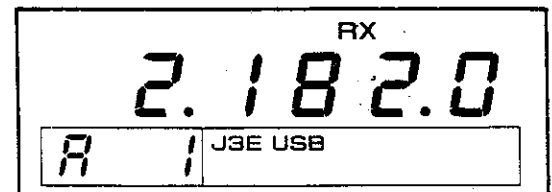

■ DIAL mode

- Press the MEMO/DIAL key to select the DIAL mode.
- Rotate the Channel selector to select the desired frequency.

or for DIRECT KEYBOARD ENTRY

Enter the desired frequency and then press the ENT key within 10 seconds.

For example 5000 kHz H3E

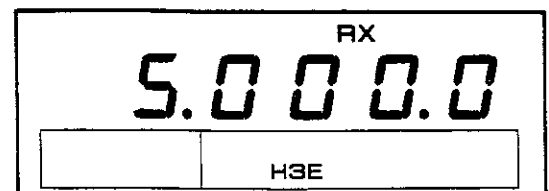

4-2-2. Frequency Selection

You can change the frequency while in the DIAL mode.

■ Direct keyboard frequency entry

1. Enter the frequency beginning with the most significant digit down to the nearest kHz.
For example 12.3331 MHz

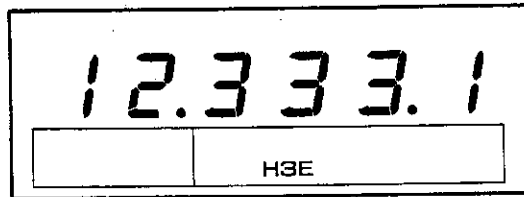
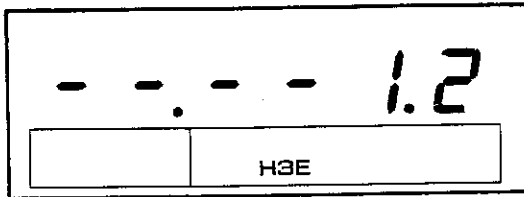
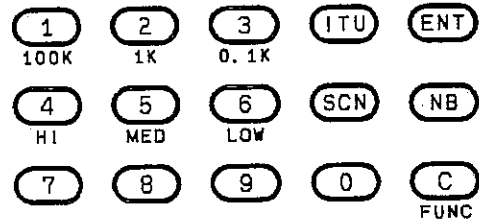

If you make an error before entering all digits, press the C/FUNC key, and then reenter all digits.

2. Press the ENT key. The RX indicator will light to signal successful frequency entry.

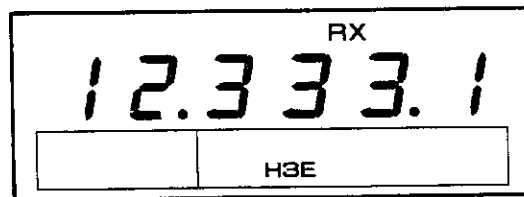

NOTE

Direct keyboard entry mode is released if you do not press the next key within 10 seconds of pressing the before key.

■ Channelized frequency selection

Rotate the Channel selector in the DIAL mode to select the desired frequency.

■ Frequency step selection

To select the desired tuning step size use the following procedures:

1. Press the C/FUNC key. The RX indicator will turn off and the 'F --' indicator will light in the display.

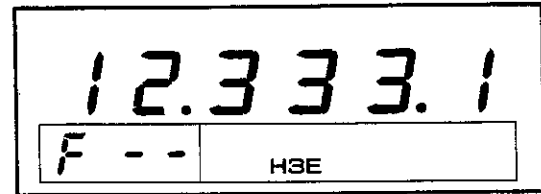

2. Press the desired STEP (100k, 1k, 0.1k) key within 10 seconds of pressing the C/FUNC key.
3. Rotate the Channel selector to confirm the step.

4-2-3. Receiver Operation with Optional Antenna Coupler

We recommend that both the transmit and receive signal pass through the optional automatic antenna coupler in order to obtain at the maximum performance.

1. Select the desired operating channel.
2. Press the microphone PTT switch to initiate tuning.
TUNE indicator will flash during tuning and a continuous beep will sound from the radiotelephone.

NOTE

The frequency in the dial mode, or the receive only memory channel frequency can not be tuned.

In these frequencies we recommend to tune nearby frequencies, or to turn the tuning function off by pressing the C/FUNC key and then the TUNE key.

3. When tuning is completed, TUNE indicator will light.
4. Receive the channel.

The same frequency as once good matched need not to tune. To avoid interfering with other station do not tune unnecessarily.

4-3. TRANSMITTER OPERATION

CAUTION ; REDUCTION OF TRANSMISSION POWER

When using the radiotelephone in a harbor or near the shore the use of LOW power is recommended, whenever possible, to avoid interfering with other stations.

The cooling fan operates automatically during long transmissions or extended operation in HI power mode. The protection circuit in the unit will activate if the temperature rises over the safe limit, and causes the output power to be automatically reduced to the LOW power position.

In this case the LOW indicator will not light, but the deflection of the ANTENNA current meter will decrease.

NOTE

PLEASE ALLOW A 1 MINUTE WARMUP PERIOD BEFORE TRANSMITTING TO ALLOW THE SSB RADIOTELEPHONE TO REACH MAXIMUM STABILITY WHEN FIRST TURNING ON THE SET.

4-3-1. Without optional Antenna Coupler

NOTE

As delivered from the factory the antenna coupler is activated by pressing the PTT switch. If you do not want the coupler to function at the beginning of each transmission press F, 8, 3, and then ENT. The automatic TUNE function will be disabled.

1. Select the desired operating channel.
For example A CH 48 : 6.2155MHz
2. Press the microphone PTT switch. The TX indicator will light.

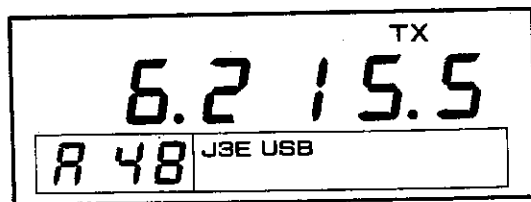

3. Speak into the microphone.
The recommended distance to the microphone is 5 cm (2 inches).
4. Release the PTT switch to return to the receive mode. The TX indicator should go out.

4-3-2. Equipped with Optional Antenna Coupler

CAUTION

THERE IS A POSSIBILITY OF DAMAGING THE EQUIPMENT IF YOU TRANSMIT BEFORE TUNE INDICATOR LIGHT CONTINUOUSLY. ALWAYS CHECK TO ENSURE THE FREQUENCY IS CLEAR BEFORE TRANSMITTING. FOR MARINE MOBILE TRANSMISSIONS YOU MUST SELECT USB.

■ Automatic Antenna Tuning

1. Select the desired operating channel.
For example A CH 48 : 6.2155 MHz

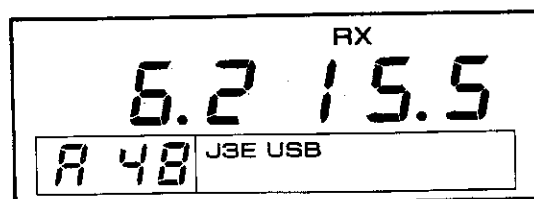

2. Press the microphone PTT switch.
TUNE indicator will flash during while it tunes and a continuous beep will be heard from the radiotelephone.

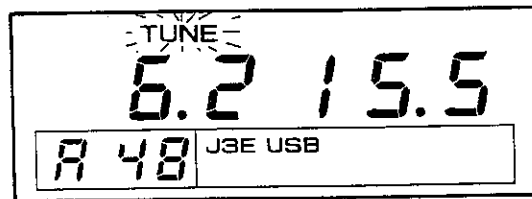

3. When tuning is completed, TUNE indicator will light continuously. The beep will stop.
Press the microphone PTT switch. The TX indicator will light.

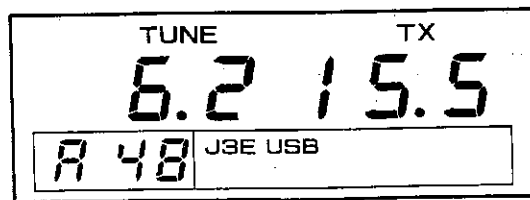

4. Speak into the microphone.
The recommended distance to the microphone is 5 cm (2 inches).

CAUTION

Rotating the channel selector will cause the TUNE indicator to turn off, you must retune before transmitting.

5. Release the PTT switch to return to the receive mode. The TX indicator should go out.

Manual Antenna Tuning

1. Select the desired operating channel.
For example A CH 48 : 6.2155 MHz

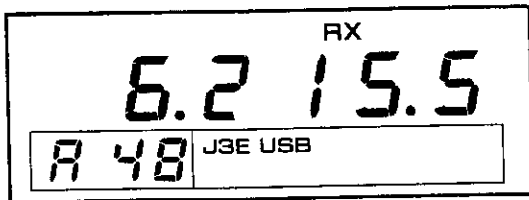

2. Press the TUNE key to activate the antenna coupler. The TUNE indicator will flash during tuning and a continuous beep will sound.

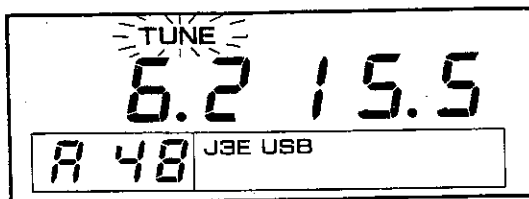

3. When tuning is completed, the TUNE indicator will light continuously.
Press the microphone PTT switch. The TX indicator will light.

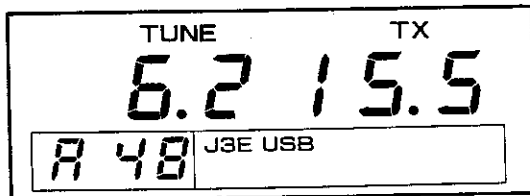

4. Speak into the microphone.
The recommended distance to the microphone is 5 cm (2 inches).

Automatic Antenna Coupler Function Control

Press F, 8, 3, and then ENT. to disable the automatic TUNE function.
Press F, 8, 2, and then ENT to enable the automatic TUNE function.

Automatic Antenna Coupler Operation

1. During tuning operation the TUNE indicator will flash and a continuous beep will sound.
2. When tuning is completed, TUNE indicator will light continuously.
3. When a good match has not been found within 15 seconds of the beginning of the tuner search, TUNE indicator will turn off.
To stop tuning before a match is found press the TUNE key. This will disconnect the coupler.

Antenna Coupler Memory Back-up Function

A back-up circuit is contained in the optional antenna coupler to retain a maximum of 10 memories for a few days. The last 10 optimum tuning points will be stored and maintained by the circuit.
The tuning time on the same frequency with the memorized data is less than 0.5 sec..

4-3-3. H3E mode

In the H3E mode you can only transmit EMERGENCY CHANNEL.

1. Select the 2.182 MHz H3E mode channel.
2. Press the microphone PTT switch. The TX indicator will light.

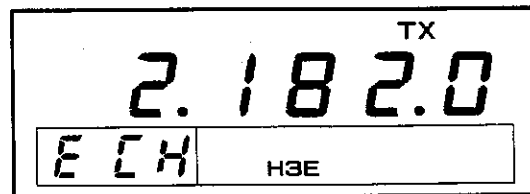

4-4. MEMORY

4-4-1. Microprocessor Memory Back-up

An EEPROM is contained in this radiotelephone to retain memory. Turning off the POWER switch, or a power failure will not erase the memory.

A lithium battery is installed to back up the display before turning off the POWER switch. The lithium battery should last for approximately five years. When the battery discharges, erratic information may appear in the display.

Lithium battery replacement should be performed by an authorized KENWOOD service facility; either your KENWOOD dealer.

4-4-2. Microprocessor Initialization

When you want to erase previously programed data, you should initialize (reset) the microprocessor using the following procedure.

There are two methods for resetting the microprocessor.

To reset all user programed data.

1. Turn the power switch off.
2. Press and hold the C/FUNC key and turn on the power switch.
3. Release the C/FUNC key.

To reset user programed data except the contents of the Memory channels.

1. Turn the power switch off.
2. Press and hold the ENT key and turn on the power switch.
3. Release the ENT key.

4-4-3. Memory Channel

This radiotelephone provides 198 (99 × 2) memory channels divided into 2 groups A, and B. Each memory channel is capable of storing the following information.

RX frequency or ITU channel
Emission Mode

4-4-4. Memory Entry

■ Receiver Frequency Entry

NOTE

There are two different display mode, one is the frequency display mode, the other is the ITU channel display mode.

1. Press the [A/B/ITU] key to select the desired memory channel mode/group.

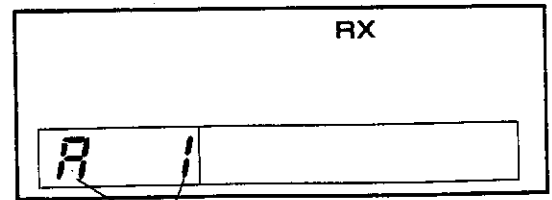

Memory channel group indicator and memory channel number will light.

2. Press the ENT key to prepare for the memory entry. Within 10 seconds of pressing the ENT key you should enter the data using the following procedure (3.~6.).

If the desired frequency is not one of the ITU channels, switch to the frequency display by pressing the ITU key. A frequency will appear in the display.

ITU CHANNEL DISPLAY MODE

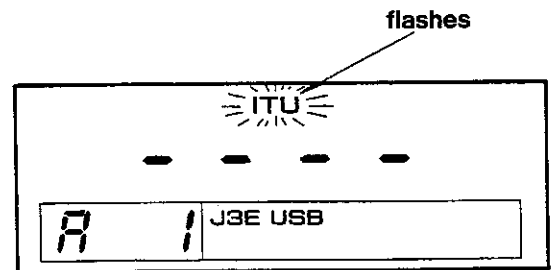

FREQUENCY DISPLAY MODE

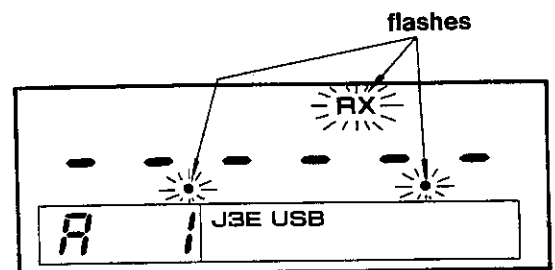

3. Rotate the Channel selector to select the desired memory channel.

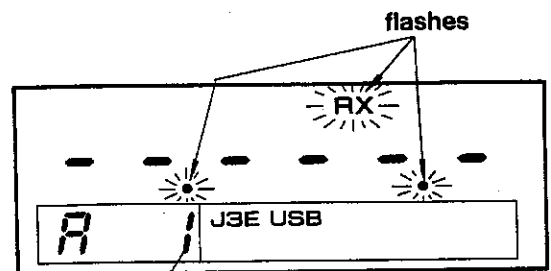

Rotate the Channel selector until the desired memory channel appears.

- Press the numeric keys corresponding the RX frequency or ITU channel you wish to enter.
For example 2182 kHz

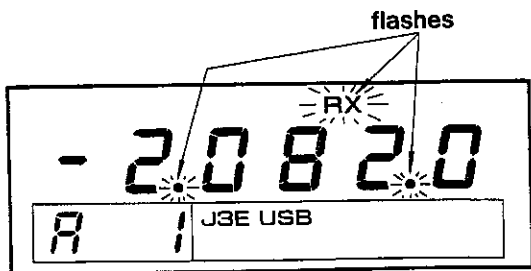

- Press the MODE key to select the desired mode.
- Press the ENT key to store the RX data into memory.

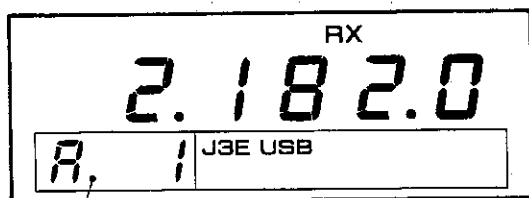

Displays the receive channel.
The ITU channel usually has both a receiver frequency and transmitter frequency.

4-4-5. Memory Recall

Please refer to 4-2-1 Mode and Channel Selection.

4-4-6. Erasing a Memory Channel

NOTE

You should practice erasing a memory channel in the frequency display mode.

- Press the ENT key to select the MEMORY ENTRY mode.
- Press the 0 key.
- Press the ENT key.
The memory channel now has no data stored in it.

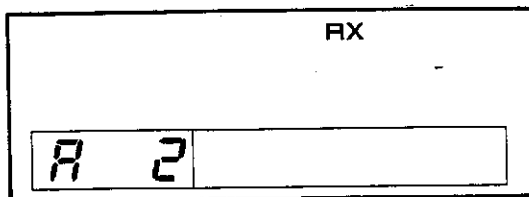

NOTE

You cannot delete the preset memory data stored by your dealer.

■ A/B Memory shift

You can replace the contents of a memory channel data of one group with another for more convenient memory channel selection or scanning.

For example

b CH 10 : 4407.0 kHz shifts to A CH 99

- Group A frequency data display.

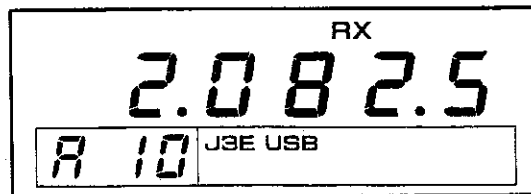

- Press the ENT key to select the MEMORY ENTRY mode.

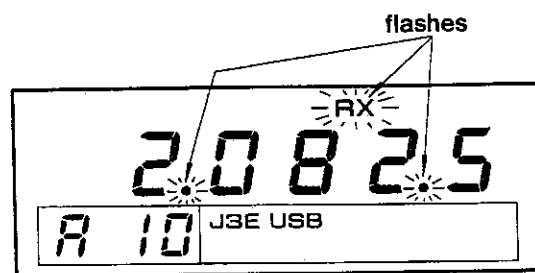

- Rotate the Channel selector to select the desired memory channel 99 (For this example).

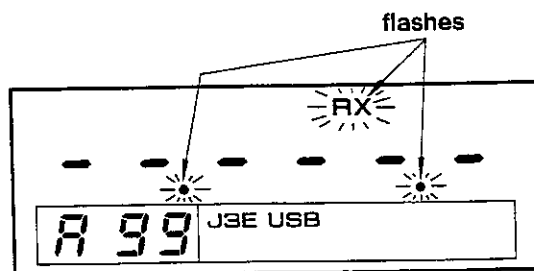

NOTE

If the display is in the ITU channel mode, press the ITU key to select the frequency mode.

- Press the 1 key and then the 0 key.

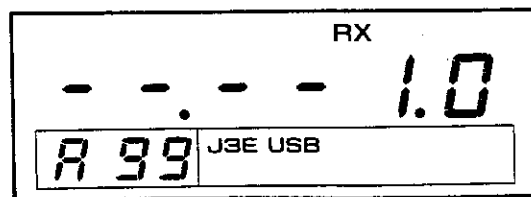

5. Press the ENT key.

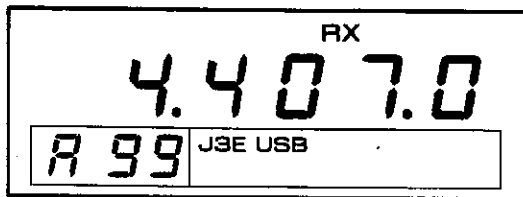

4-4-7. MEMO/DIAL Shift

You can copy the contents of the current memory channel group to the DIAL mode without changing the data in memory.

For example copy the contents of "A CH 6" to the DIAL mode

1. Select the memory channel group that contains the desired data.

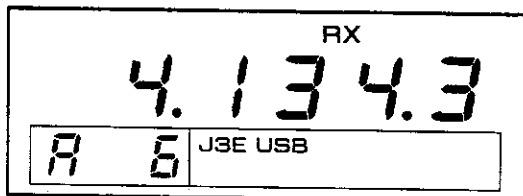

2. Press the MEMO/DIAL key to select the DIAL mode.

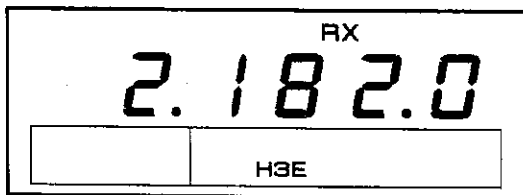

3. Press the numeric key corresponding to the desired memory channel number.
For this example 6

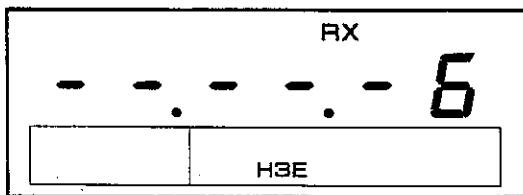

4. Press the ENT key. A short beep will sound to signal the data has been successfully transferred to the DIAL mode.

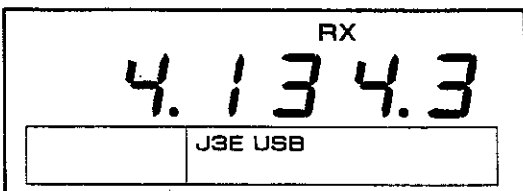

4-5. SCAN

Scan is used to sample the band activity automatically.

4-5-1. Scan Options

The following scan options are available:

■ Memory Channel Scan

A or B group

Scan proceeds thru 10 memory channels of the same group A, or B that have data stored.

ITU

Scan proceeds thru all ITU memory channels.

■ Dial Scan

Scan proceeds over the entire band. The Scan step size depends upon the current step programming.

4-5-2. Hold/Resume Programming

Either the following scan hold/resume methods may be selected for MEMORY CHANNEL SCAN.

■ Time Operated Scan

When squelch turns off, the radiotelephone stops on a channel and remains there approximately 5 seconds, and then continues to scan even if the signal is still present.

■ Voice Operated Scan

When squelch turns on, the radiotelephone will stop scanning on a busy channel and remain there until the signal drops out. The radiotelephone allows a 5 seconds delay before it resumes scanning so that you don't lose the station when operators change.

4-5-3. Memory Channel Scan

1. Press the MEMO/DIAL key to select the memory channel mode.
2. Press the A/B/ITU key to select the desired memory channel group/mode.
3. Rotate the channel selector to select the scan starting channel.
4. Press the SCN key to initiate scan. The MHz and/or kHz indicator will flash as a visual reminder that the SSB radiotelephone is scanning.

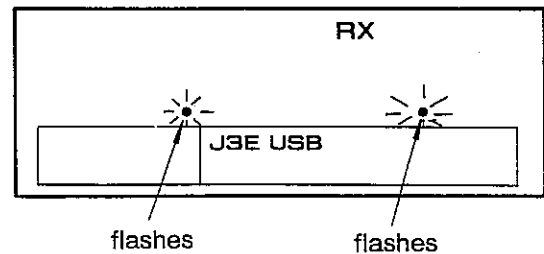
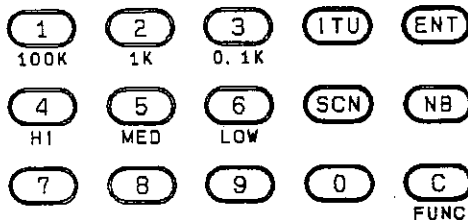

NOTE

No scanning will be performed if less than 2 memory channels have data.

5. Scan will begin in an upwards direction. You can reverse the direction of scan by turning the Channel selector counterclockwise.
6. Scan will stop whenever a signal is received that will open the squelch of the radiotelephone.
7. Press the C/FUNC key or the PTT switch (no transmit will occur) to clear scanning.

4-5-4. DIAL SCAN

1. Press the MEMO/DIAL key to select the DIAL mode.
2. Press the SCN key to initiate scan. The MHz and/or kHz indicator will flash as a visual reminder that the unit is scanning.

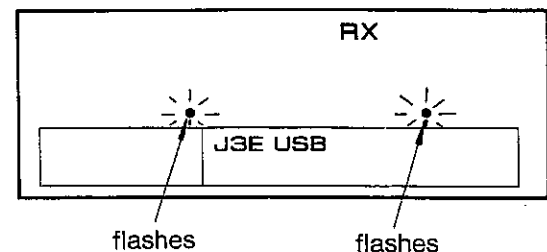

3. Scan will begin in an upwards direction. You can reverse the direction of scan by turning the Channel selector counterclockwise.
4. Press the C/FUNC key or the PTT switch (no transmit will occur) to clear scanning.

5. CIRCUIT DESCRIPTION

5-1. GENERAL

The TKM-707 consists of three units: TX-RX Unit, Final Unit and Control Unit.

Except for the PA section of the TX-RX Unit, the transmit and receive circuits are incorporated on one printed circuit board.

In the transmit circuit, the 10.695 MHz BFO signal provides balanced modulation for the audio signal from the microphone, which is then converted into a 71.295 MHz signal by the first transmit mixer. This signal is further converted into the desired frequency by the second transmit mixer and then sent to the PA section of the Final Unit. In addition, the BFO signal is added by the first transmit mixer in the H3E mode.

The receive circuit uses a double conversion system. The 1st IF is 71.295 MHz and the 2nd IF is 10.695 MHz. The 8-way BPF selects the desired frequency band from the signal received at the antenna. The signal which has been converted to the 1st IF by the 1st receive mixer goes through a narrow-band monolithic crystal filter where the desired frequency is selected and is converted into the 2nd IF by the 2nd receive mixer. This signal passes through a filter, which is determined by the selected mode, and becomes the receive signal at audio frequency after going through heterodyne detection in the J3E mode and diode detection in the H3E mode.

The Final Unit is made up of a dicast radiator with two printed circuit boards installed on it, and divided into the PA section and LPF section. In the PA section, the transmit signal from the TX-RX Unit is amplified to 150 W PEP. In the LPF section, the signal goes through a 7-way LPF where the higher harmonic component is eliminated, and is then fed to the antenna terminal.

The Control Unit consists of two printed circuit boards and is divided into the CPU and Synthesizer Unit assembly and the switch unit of the panel section. The 8-bit CPU controls the overall set by operating keys in the switch unit and displays frequency and operating modes on the LCD display unit.

The Synthesizer Unit consists of three PLLs. All the reference frequencies are determined by a 30.3 MHz frequency signal from the TX-RX Unit. The first local is set between 71.395 - 101.2949 MHz by a double-loop PLL. The BFO signal is set between 10.6935 - 10.6965 MHz and then sent to the TX-RX unit.

5-2. TRANSMIT CIRCUITS

5-2-1. Modulation Circuit

The audio signal from the microphone is amplified by the mic amp (Q37 and Q38) in the TX-RX Unit and then goes through a double-balanced mixer (IC6) for balanced modulation. The ALARM signal from the control goes through an active low-pass filter (Q33) where the high-frequency component is removed, passes through a buffer amplifier (Q34) and then goes to IC6. The balanced modulation output goes through a crystal filter (XF2) where its lower side-band is removed to form a 10.695 MHz single side-band signal.

5-2-2. BFO Circuit

In the J3E mode, diode switches (D53 and D54) are turned on and the BFO signal from the Control Unit goes to IC6. In the H3E mode, diode switches (D59 and D60) are turned on and the BFO signal from the Control Unit is amplified by a BFO amplifier (Q49). This output passes through diode switches (D64, D65 and D66) and goes to the first transmit mixer.

5-2-3. 10.695 MHz Transmit IF Circuit

The output from the crystal filter (XF2) is amplified as the 10.695 MHz transmit IF signal by the IF amplifier (Q45). This output is sent to the first transmit mixer (IC7) and converted to a 71.295 MHz IF signal. ALC voltage is applied to the second gate of Q45 to control the transmit gain.

5-2-4. 71.295 MHz Transmit IF Circuit

The output from the first transmit mixer goes through a monolithic crystal filter (XF1) where spurious signals are removed and then is amplified in the 71.295 MHz IF amplifier (Q50). This output is sent to the second transmit mixer (Q51 and Q52) and then converted to the desired transmit frequency. A protection voltage is applied to the second gate of Q50 to protect the final transistor under abnormal load by reducing the gain of the IF amplifier and the transmitter output power.

5-2-5. Drive Circuit

The output from the second transmit mixer goes through a low-pass filter where the higher harmonic component is removed. The selected frequency is amplified in drive amplifier (Q53) and is sent to the Final Unit.

5-2-6. PA Circuit

The transmit signal brought out from the TX-RX Unit goes to the PA section of the Final Unit and is amplified to 150 W PEP. The PA section is made up of three stages. The first amplifier (Q1) operates as a Class A amplifier while the second (Q2 and Q3) and the third (Q4 and Q5) amplifiers operate as Class AB push-pull amplifiers.

5-2-7. Bias Circuit

In the bias circuit of the PA section, the first amplifier has a fixed bias, the second amplifier is controlled by VR1 and the third amplifier by VR2. The third amplifier is powered by a bias circuit (Q6). The diodes D1 - D4 are thermally coupled with Q1, Q2, Q4 and Q6: D1 with Q1, D2 with Q2, D3 with Q4 and D4 with Q6. Q1 - Q6 work to prevent thermal runaway.

5-2-8. LPF Circuit

The transmit signal from the PA section goes through a LPF Circuit where its higher harmonic is attenuated. The LPF splits the signal into seven frequencies as shown below.

1.6050	-	2.9999 MHz	LPF1
3.0000	-	4.9999 MHz	LPF2
5.0000	-	6.9999 MHz	LPF3
7.0000	-	8.9999 MHz	LPF4
9.0000	-	13.9999 MHz	LPF5
14.0000	-	17.9999 MHz	LPF6
18.0000	-	27.9999 MHz	LPF7

Switching information for the LPF is converted to 3-bit information by a serial-parallel conversion IC (IC10) between the Control Unit CPU and the TX-RX Unit. This information is converted to 7-bit information by a decoder IC (IC101) in the Final Unit, which in turn drives the relay and switches the LPF.

5-2-9. ALC Circuit

The ALC circuit in the TX-RX Unit is implemented by controlling the gain of the 10.695 MHz IF amplifier (Q45) by means of the traveling wave voltage and reflected wave voltage of the Final Unit. The traveling wave voltage is adjusted by VR15 and then enters the negative side of the operational amplifier (IC8/2). The ALC reference voltage is applied to the positive side of the operational amplifier and drives the ALC voltage. The ALC reference voltage is adjusted by VR17 during MED Power, by VR18 during LOW Power and by VR19 during TUNE Power and controls the transmitting power.

In addition, the reflected wave voltage is adjusted by VR14, amplified by an amplifier(Q59) and drives the ALC voltage.

5-2-10. Temperature Protection

When the temperature of the heat sink in the Final Unit increases and the temperature of the thermistor (TH1) used to detect the temperature rises above 55°, the fan motor starts to cool the heat sink. When the temperature still increases and rises above 90°, the temperature protection circuit starts to operate and turns the ALC circuit in the TX-RX Unit turn to LOW Power.

5-3. RECEIVE CIRCUITS

5-3-1. BPF Circuit

The signal received at the antenna passes through one of the eight BPFs (partly LPF) where the desired frequency band is filtered out. The BPFs and their related frequencies are shown below.

0.50000	-	1.59999 MHz	B1
1.60000	-	2.99999 MHz	B2
3.00000	-	4.99999 MHz	B3
5.00000	-	6.99999 MHz	B4
7.00000	-	8.99999 MHz	B5
9.00000	-	13.99999 MHz	B6
14.00000	-	17.99999 MHz	B7
18.00000	-	29.99999 MHz	B8

The serial data from the Control Unit's CPU is converted to 8-bit data by a serial-parallel conversion IC (IC9) in the TX-RX Unit. This BPF switching data is used to switch between BPF's.

5-3-2. 71.295 MHz Receive IF Circuits

The receive signal from the BPF is sent to the first receive mixer (Q9 and Q10) and then converted into a 71.295 MHz IF signal. The IF signal is passed through a narrow-band monolithic crystal filter (XF1) to filter out interference from local signals, and then goes to a 71.295 MHz IF amplifier (Q12) for amplification.

5-3-3. 10.695 MHz Receive IF Circuit

The 71.295 MHz IF signal is converted into a 10.695 MHz signal in the second receive mixer (Q13 and Q14). This signal is amplified by the 10.695 MHz IF amplifier (Q15) and then goes to the 2.35 kHz crystal filter (XF2) with a 6 dB band-width when in the J3E mode or to the 6 kHz crystal filter (XF3) when in the H3E mode where selectivity is markedly improved. The output signal from the filter is fed to the IF hybrid IC (IC2), and is then further amplified by the two-stage 10.695 MHz IF FET amplifiers.

5-3-4. Detection Circuit

The 10.695 MHz IF signal is detected by the IF hybrid IC (IC2), converted into a voice signal and then fed out. In the J3E mode, BFO is injected using a ring detector. In the H3E mode, a diode is used for detection.

5-3-5. AF Amplification Circuit

The voice output from the IF hybrid IC (IC2) is amplified by a pre-amplifier (Q29) and its volume can be adjusted by the volume control on the panel. It is further amplified by a power amplifier (IC5) and then drives the speaker. The pre-amplifier can be muted by the SQS signal from the Control Unit. The output can also be muted by a switching transistor (Q30) and SQS and MU signals of the Control Unit. In

addition to the receive signals, beep and alarm tones are added in the power amplifier (IC5).

5-3-6. AGC Circuit

The AGC detection circuit is in the IF hybrid, IC (IC2) where it generates the AGC voltage. The AGC voltage after detection is amplified and rectified with voltage multiplication and becomes the 10.695 MHz output from the final IF-stage. The AGC voltage is applied to the second-stage IF amplifier in the IC and FET G2 in the IF amplifier (Q15 and Q12) to control the gain.

5-3-7. SQL Circuit

This is an audio control squelch circuit and all circuitry is included in the SQL hybrid IC (IC3). The detection output from the IF hybrid IC (IC2) enters IC3 and pre-amplifier (Q29). The output processed in IC3 comes out as a High/Low digital signal and as the VSQ signal from pin 8. The High/Low digital signal enters the Control Unit while the VSQ signal goes to the CPU. The CPU functions as an output and sends the SQS signal out to the TX-RX Unit. The SQS signal is then muted in the pre-amplification stage and then squelch-controlled. The squelch sensitivity is determined by VR5.

5-3-8. Noise Blanker Circuit

The noise blanker is an NB hybrid IC (IC1). The output of the second receive mixer enters the NB hybrid IC (IC1) and the 10.695 MHz IF amplifier. This signal is amplified and detected by the NB amplifier in the IC and then brought out as the noise blanking signal. The noise component is removed by allowing the switching transistor (Q16) to switch off the IF amplifier (Q15).

5-4. LOCAL OSCILLATOR CIRCUITS

5-4-1. Reference Oscillator Circuit

The oscillating frequency of the oven controlled crystal oscillator (X1) in the TX-RX Unit is 30.3 MHz which determines the frequencies of the entire set. The OCXO output is sent to the Control Unit via the buffer amplifier (Q55) and becomes a reference for the PLL synthesizer. In the TX-RX Unit, the output is also converted into a 60.6 MHz signal by the double step-up circuit (Q56), amplified by an amplifier (Q57) and then used as the second local for receive and transmit.

5-4-2. The 1st Local Oscillator Circuit

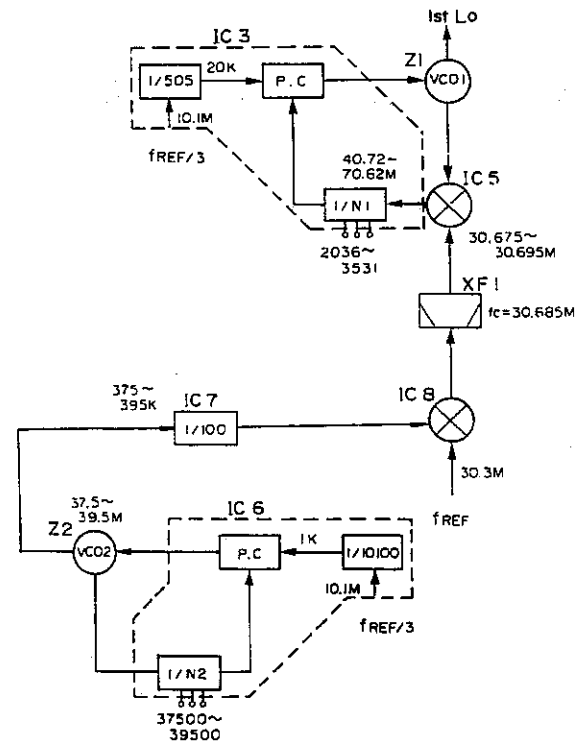

The first local oscillator is a digital 10 Hz-step VFO and provides the local frequency in the range of 71.395 - 101.2949 MHz. It uses a double-loop PLL synthesizer configuration. The 30.3 MHz reference frequency sent from the TX-RX Unit is divided into three 10.1 MHz frequencies by an IC2 in the PLL section. Then the 10.1 MHz frequencies enter IC3, IC6 and IC9 as reference frequencies for the PLL IC. First, the 1 kHz reference for the PLL is formed in the PLL IC (IC6). The output of VCO2 (Z2) which ranges from 37.5 to 39.5 MHz is divided into a hundred parts in steps of 10 Hz by the divider IC (IC7). This output is mixed in the mixer (IC8) and the summed component 30.675 - 30.695 MHz is extracted by the monolithic crystal filter (XF1). This will become the local oscillator for the final loop and is mixed with the VCO1 (Z1) output in the MIX IC (IC5). The output then goes to the BPF where spurious components are removed, is amplified in the amplifier (Q10 and Q11) and enters the PLL IC (IC3).

VCO1 switches the four oscillator circuits to cover the desired frequencies. The switching data is sent from the CPU as V1 and V2 signals, which are converted into 4-bit signals by the decoder IC (IC4). The VCO1 output is amplified by the amplifier (Q8) and then sent to the TX-RX Unit.

5-4-3. BFO Circuit

The BFO circuit is a digital 20 Hz-step VFO, sending out 10.6935 - 10.6965 MHz BFO, and consists of a PLL synthesizer with a 2 kHz reference frequency.

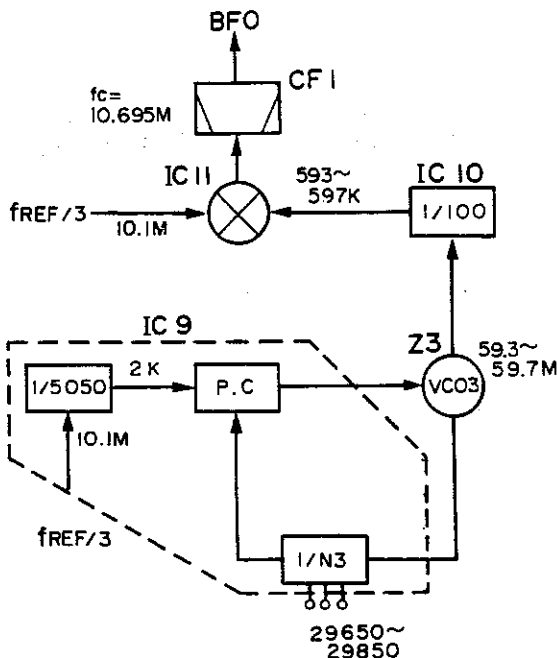

The VCO3 output enters the PLL IC (IC9) and forms a PLL along with the active LPF (Q22, Q23 and Q24). The VCO3 output is divided into a hundred parts in steps of 20 Hz by the divider IC (IC10). This output is mixed with a 1/3 reference of 10.1 MHz in the MIX IC (IC11) and the summed component is extracted by the ceramic filter (CF1). This is amplified by the amplifier (Q27) and then sent to the TX-RX Unit as the BFO.

5-4-4. Lock Detection Circuit

A protection circuit is provided so that abnormal transmit signals will not go out when the PLL loop is not locked on under abnormal circumstances. When the PLL loop is not locked on, pin 8 of the PLL ICs (IC3, 6 and 9) goes High. Because pin 8 of each IC is connected to each other by a wired-OR configuration, when any of the pins is not locked, the 8 V line is shut off by the switching circuit (Q19, 20 and 21). This will cause the power supply for the output amplifier (Q8 and Q27) to supply 0 volts and therefore no local signal will be sent to the TX-RX Unit. Thus no signal can be transmitted.

5-4-5. CPU Section

The CPU section consists of an 8-bit CPU (IC302), a 16 KB ROM (IC310), a 2 KB EEPROM (IC131) and an I/O expander (IC300). The CPU section controls data sent to each unit and frequencies, and provides LCD displays for the panel. In the CPU section, the 1300 Hz and 2200 Hz digital alarm signals that are sent out from IC300 is D-A converted by the resistance ladder (CP300) and then sent to the TX-RX Unit.

A lithium battery provides back-up for the CPU's RAM (IC302) to retain data. Back-up is implemented by pin 62 of IC302 when it goes Low. Because memory frequencies are stored in the EEPROM, they are retained regardless of the state of the lithium battery.

6. MAINTENANCE and ADJUSTMENT

6-1. SERVICE

Your SSB radiotelephone has been factory aligned and tested to specification before shipment. Under normal circumstances the SSB radiotelephone will operate in accordance with these instructions. All adjustable trimmers and coils in your SSB radiotelephone have been adjusted at the factory and should only be readjusted by a qualified technician with proper test equipment. Attempting service or alignment without factory authorization can void the SSB radiotelephone's warranty.

When operated properly, the SSB radiotelephone will provide many years of service without requiring realignment. The information in this section gives some general service procedures which can be accomplished without sophisticated test equipment.

Should it ever become necessary to return the equipment to your dealer or service center for repair, pack it in its original box and packing, and include a full description of the problems involved. Also include your telephone number. You need not return accessory items unless directly related to the service problem.

Service note :

If you desire to correspond on a technical or operational problem, please make your note short, complete, and to the point, and PLEASE make it readable.

Please list: Model and Serial Number

The problem you are having.

Please give sufficient detail to diagnose. Information such as other equipment in the station, meter readings and anything else you feel might be useful in attempting diagnosis .

CAUTION

Do not pack the equipment in crushed newspapers for shipment. Extensive damage may result during shipment.

NOTES

1. Record the Date of Purchase, Serial Number and Dealer from whom purchased.
2. For your own information, retain a written record of any maintenance performed on the unit.
3. When claiming warranty service, a photocopy of the bill of sale, or other proof of purchase showing the date of sale must accompany the radiotelephone.

6-2. IN CASE OF DIFFICULTY

The problems described in this table are failures caused, in general, by improper operation or connection of the SSB radiotelephone, not by defective components. Examine and check according to the following table.

Symptom	Probable cause	Corrective action
Indicators do not light and no receiver noise is heard when the POWER switch is turned on.	<ol style="list-style-type: none"> 1. Bad power cable or connection. 2. Blown power supply fuse. 	<ol style="list-style-type: none"> 1. Check cables and connections. 2. Check for the cause of the blown fuse and replace the fuse.
No sound from the speaker. No signal can be received.	<ol style="list-style-type: none"> 1. The SP switch is OFF. 2. Volume control fully counterclockwise. 3. Squelch is ON. 4. Microphone PTT switch is in the transmit position. 	<ol style="list-style-type: none"> 1. Set the SP switch ON . 2. Turn the Volume control clockwise. 3. Set the Squelch switch OFF. 4. Set the PTT switch to the receive position.
Display is dark.	<ol style="list-style-type: none"> 1. Power voltage is low. 2. The DIMMER key had been pressed. 	<ol style="list-style-type: none"> 1. Check voltage for 13.6 VDC \pm15 %. 2. Press the DIMMER key.
SSB received signal is not clear. SSB weak signal cannot be received.	<ol style="list-style-type: none"> 1. Wrong emission mode. 2. Receive frequency is detuned. 	<ol style="list-style-type: none"> 1. Change the MODE key to the current emission mode . 2. In Memory channel mode, adjust frequency by CLARIFIER. In the dial mode, adjust frequency by CHANNEL selector and CLARIFIER control.
MHz and kHz dot is flashing and frequency is automatically changed.	<ol style="list-style-type: none"> 1. Scanning is ON. 	<ol style="list-style-type: none"> 1. Press the C / FUNC key to release scan.
No transmitter output	<ol style="list-style-type: none"> 1. Microphone jack is not plugged in. 2. Poor antenna connection. 3. Dial mode is selected. 4. Transmitter frequency is not memoried. 	<ol style="list-style-type: none"> 1. Plug jack in. 2. Connect antenna securely. 3. Select the Memory channel mode. 4. The memory channel is receive only channel.
Antenna coupler is not tuned.	<ol style="list-style-type: none"> 1. Poor antenna connection. 2. Antenna length is not within the tuneable range of the coupler. 3. The antenna coupler is not grounded properly. 4. MANUAL position is selected in the antenna coupler. 5. Antenna coupler has a poor contact. 	<ol style="list-style-type: none"> 1. Connect antenna securely. 2. Use the proper length antenna . 3. Ground properly. 4. Select the AUTO position. 5. Correct wiring.
ALARM TONE is not transmitted.	<ol style="list-style-type: none"> 1. Press only ALARM key . 	<ol style="list-style-type: none"> 1. Press both ALARM key and 2182 key.

6-3. ADJUSTMENT

■ Cover Removal

CAUTION

Before removing the cover, turn the DC power supply's power switch OFF and disconnect the power cable.
Do not pinch wiring when opening or closing cases.

Remove the top cover (8 screws), and the bottom cover (4 screws) from radiotelephone.

Top cover

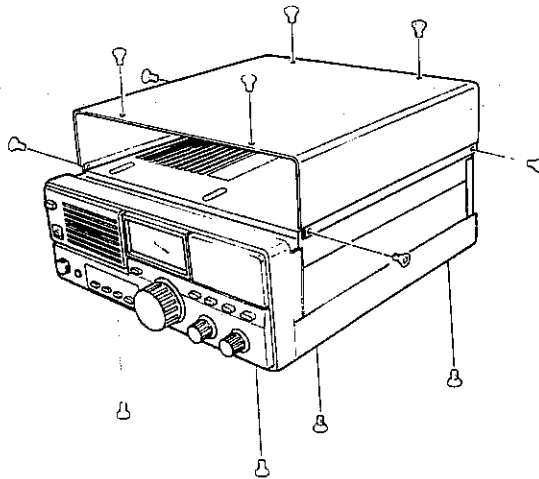

■ Subchassis Removal

Remove the 4 screws as shown in the diagram.
Open in a counterclockwise direction.

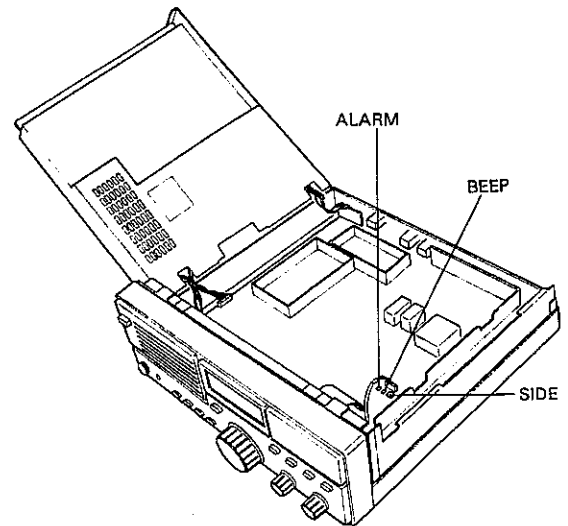
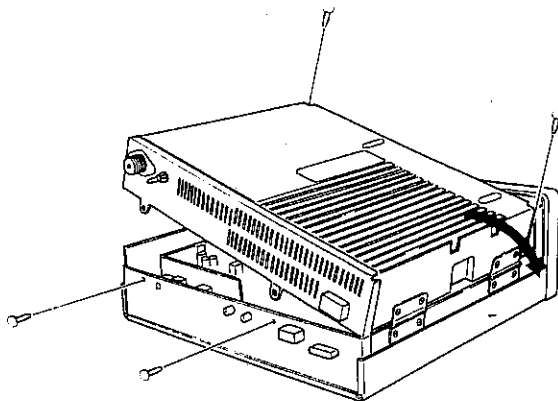

6-3-1. Beep Tone Level

Turn VR7 to the desired BEEP tone level.

6-3-2. Alarm Tone Level

1. Press the ALARM key to select the ALARM TEST mode.
2. Turn VR6 to the desired ALARM tone level.

6-3-3. Side Tone Level

Turn VR21 to the desired SIDE tone level.

6-3-4. Microphone Connector

Front view

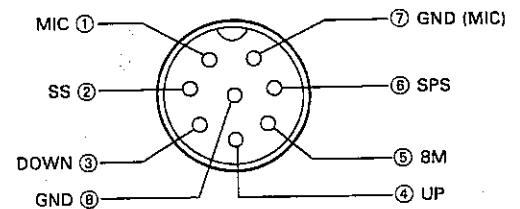

- | | |
|-----------|---|
| ①MIC | Impedance approx. 600 Ω. |
| ②SS | Stand-by switch |
| ③DOWN | Frequency or Memory channel number decrease |
| ④UP | Frequency or Memory channel number increase |
| ⑤8M | 8 V (Max. 100 mA) |
| ⑥SPS | Receive audio output |
| ⑦GND(MIC) | Mic ground |
| ⑧GND | Ground |

6-3-5. 13.6 VDC Power Input Connector

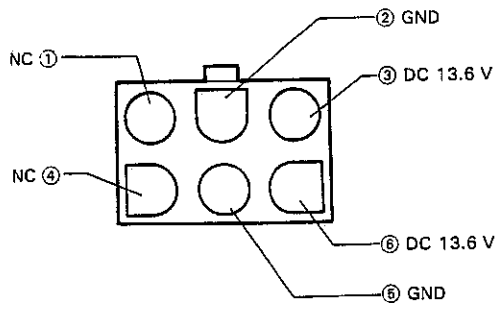

6-3-6. Antenna Coupler Connector

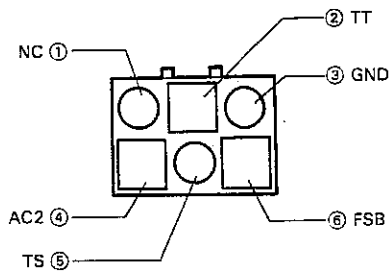

- | | |
|-------|----------------------------------|
| ① NC | Not used |
| ② TT | Control signal input/output |
| ③ GND | Ground |
| ④ AC2 | Antenna current input |
| ⑤ TS | Control signal input/output |
| ⑥ FSB | Power output for antenna coupler |

7-3. ITU CHANNEL DATA

KHz

ITU No.	RX freq.	TX freq.	ITU No.	RX freq.	TX freq.	ITU No.	RX freq.	TX freq.
401	4357	4065	801	8719	8195	1201	13077	12230
402	4360	4068	802	8722	8198	1202	13080	12233
403	4363	4071	803	8725	8201	1203	13083	12236
404	4366	4074	804	8728	8204	1204	13086	12239
405	4369	4077	805	8731	8207	1205	13089	12242
406	4372	4080	806	8734	8210	1206	13092	12245
407	4375	4083	807	8737	8213	1207	13095	12248
408	4378	4086	808	8740	8216	1208	13098	12251
409	4381	4089	809	8743	8219	1209	13101	12254
410	4384	4092	810	8746	8222	1210	13104	12257
411	4387	4095	811	8749	8225	1211	13107	12260
412	4390	4098	812	8752	8228	1212	13110	12263
413	4393	4101	813	8755	8231	1213	13113	12266
414	4396	4104	814	8758	8234	1214	13116	12269
415	4399	4107	815	8761	8237	1215	13119	12272
416	4402	4110	816	8764	8240	1216	13122	12275
417	4405	4113	817	8767	8243	1217	13125	12278
418	4408	4116	818	8770	8246	1218	13128	12281
419	4411	4119	819	8773	8249	1219	13131	12284
420	4414	4122	820	8776	8252	1220	13134	12287
421	4417	4125	821	8779	8255	1221	13137	12290
422	4420	4128	822	8782	8258	1222	13140	12293
423	4423	4131	823	8785	8261	1223	13143	12296
424	4426	4134	824	8788	8264	1224	13146	12299
425	4429	4137	825	8791	8267	1225	13149	12302
426	4432	4140	826	8794	8270	1226	13152	12305
427	4435	4143	827	8797	8273	1227	13155	12308
428	4351	-	828	8800	8276	1228	13158	12311
429	4354	-	829	8803	8279	1229	13161	12314
			830	8806	8282	1230	13164	12317
601	6501	6200	831	8809	8285	1231	13167	12320
602	6504	6203	832	8812	8288	1232	13170	12323
603	6507	6206	833	8291	-	1233	13173	12326
604	6510	6209	834	8707	-	1234	13176	12329
605	6513	6212	835	8710	-	1235	13179	12332
606	6516	6215	836	8713	-	1236	13182	12335
607	6519	6218	837	8716	-	1237	13185	12338
608	6522	6221				1238	13188	12341
						1239	13191	12344
						1240	13194	12347
						1241	13197	12350

7-3. ITU CHANNEL DATA

KHz

ITU No.	RX freq.	TX freq.	ITU No.	RX freq.	TX freq.	ITU No.	RX freq.	TX freq.
1601	17242	16360	2201	22696	22000	451	4125	4125
1602	17245	16363	2202	22699	22003	452	4146	4146
1603	17248	16366	2203	22702	22006	453	4149	4149
1604	17251	16369	2204	22705	22009	454	4417	4417
1605	17254	16372	2205	22708	22012	651	6224	6224
1606	17257	16375	2206	22711	22015	652	6227	6227
1607	17260	16378	2207	22714	22018	653	6230	6230
1608	17263	16381	2208	22717	22021	654	6516	6516
1609	17266	16384	2209	22720	22024	851	8294	8294
1610	17269	16387	2210	22723	22027	852	8297	8297
1611	17272	16390	2211	22726	22030			
1612	17275	16393	2212	22729	22033	1251	12353	12353
1613	17278	16396	2213	22732	22036	1252	12356	12356
1614	17281	16399	2214	22735	22039	1253	12359	12359
1615	17284	16402	2215	22738	22042			
1616	17287	16405	2216	22741	22045	1657	16528	16528
1617	17290	16408	2217	22744	22048	1658	16531	16531
1618	17293	16411	2218	22747	22051	1659	16534	16534
1619	17296	16414	2219	22750	22054			
1620	17299	16417	2220	22753	22057	2254	22159	22159
1621	17302	16420	2221	22756	22060	2255	22162	22162
1622	17305	16423	2222	22759	22063	2256	22165	22165
1623	17308	16426	2223	22762	22066	2257	22168	22168
1624	17311	16429	2224	22765	22069	2258	22171	22171
1625	17314	16432	2225	22768	22072			
1626	17317	16435	2226	22771	22075			
1627	17320	16438	2227	22774	22078			
1628	17323	16441	2228	22777	22081			
1629	17326	16444	2229	22780	22084			
1630	17329	16447	2230	22783	22087			
1631	17332	16450	2231	22786	22090			
1632	17335	16453	2232	22789	22093			
1633	17338	16456	2233	22792	22096			
1634	17341	16459	2234	22795	22099			
1635	17344	16462	2235	22798	22102			
1636	17347	16465	2236	22801	22105			
1637	17350	16468	2237	22804	22108			
1638	17353	16471	2238	22807	22111			
1639	17356	16474	2239	22810	22114			
1640	17359	16477	2240	22813	22117			
1641	17362	16480	2241	22816	22120			
1642	17365	16483	2242	22819	22123			
1643	17368	16486	2243	22822	22126			
1644	17371	16489	2244	22825	22129			
1645	17374	16492	2245	22828	22132			
1646	17377	16495	2246	22831	22135			
1647	17380	16498	2247	22834	22138			
1648	17383	16501	2248	22837	22141			
1649	17386	16504	2249	22840	22144			
1650	17389	16507	2250	22843	22147			
1651	17392	16510	2251	22846	22150			
1652	17395	16513	2252	22849	22153			
1653	17398	16516	2253	22852	22156			
1654	17401	16519						
1655	17404	16522						
1656	17407	16525						

8. EMERGENCIES (DISTRESS)

CAUTION
NEVER TRANSMIT THE ALARM TONE EXCEPT
IN AN EMERGENCY.

1. Press the 2182 key to select the EMERGENCY channel in the USB/J3E mode.

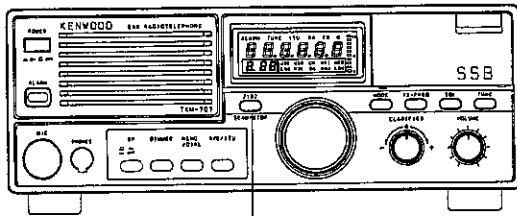

2182
SEND / STOP key

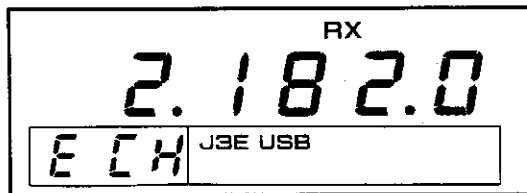

To select H3E mode press the MODE key.
To change OUTPUT POWER LEVEL press the C/FUNC key and then the corresponding key.

2. Press the ALARM key and the 2182/(SEND) key simultaneously.

The TUNE indicator will flash during the tuning and a continuous beep will sound. When tuning is completed TUNE indicator will light, the beep will stop (if equipped with the optional automatic antenna coupler).

The radiotelephone will transmit the alarm tone for approximately 45 seconds after the antenna coupler stops.

Pressing the 2182/(STOP) key will stop the alarm tone and transmission.

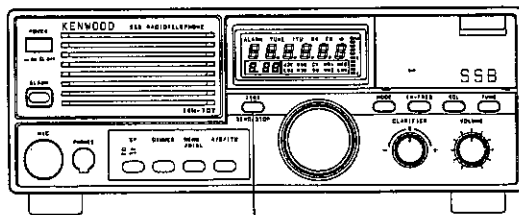

2182
SEND / STOP key

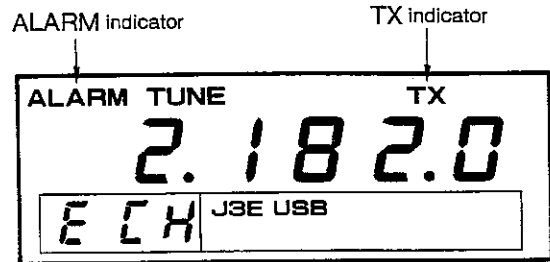

3. Press the PTT switch and speak slowly and clearly into the microphone.

TESTING

1. The alarm tone can be monitored by pressing the ALARM key (No transmit).
2. Pressing the ALARM key or the 2182/(STOP) key will stop the alarm tone.

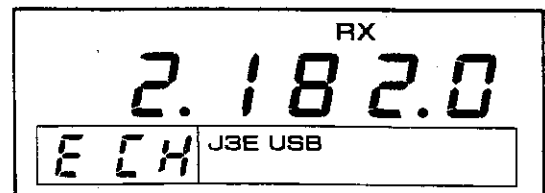

HOW TO SEND AN EMERGENCY (DISTRESS) CALLS

1. The distress signal MAYDAY spoken three times.
2. The word THIS IS;
3. The CALL SIGN (or name, if no call sign assigned) of the mobile station in distress, spoken three times.
For example;
MAYDAY, MAYDAY, MAYDAY,
This is "your vessels name", "your vessel", "your vessel" (over).

CONTENTS OF AN EMERGENCY (DISTRESS) MESSAGE

1. The distress signal MAYDAY ;
2. The name of the mobile station in distress;
3. Particulars of its position;
4. The nature of the distress;
5. The kind of assistance desired;
6. Any other information which might facilitate rescue, for example, the length, color, and type of vessel, number of persons, on board, etc..