

Circuit Diagram Lot. 70~

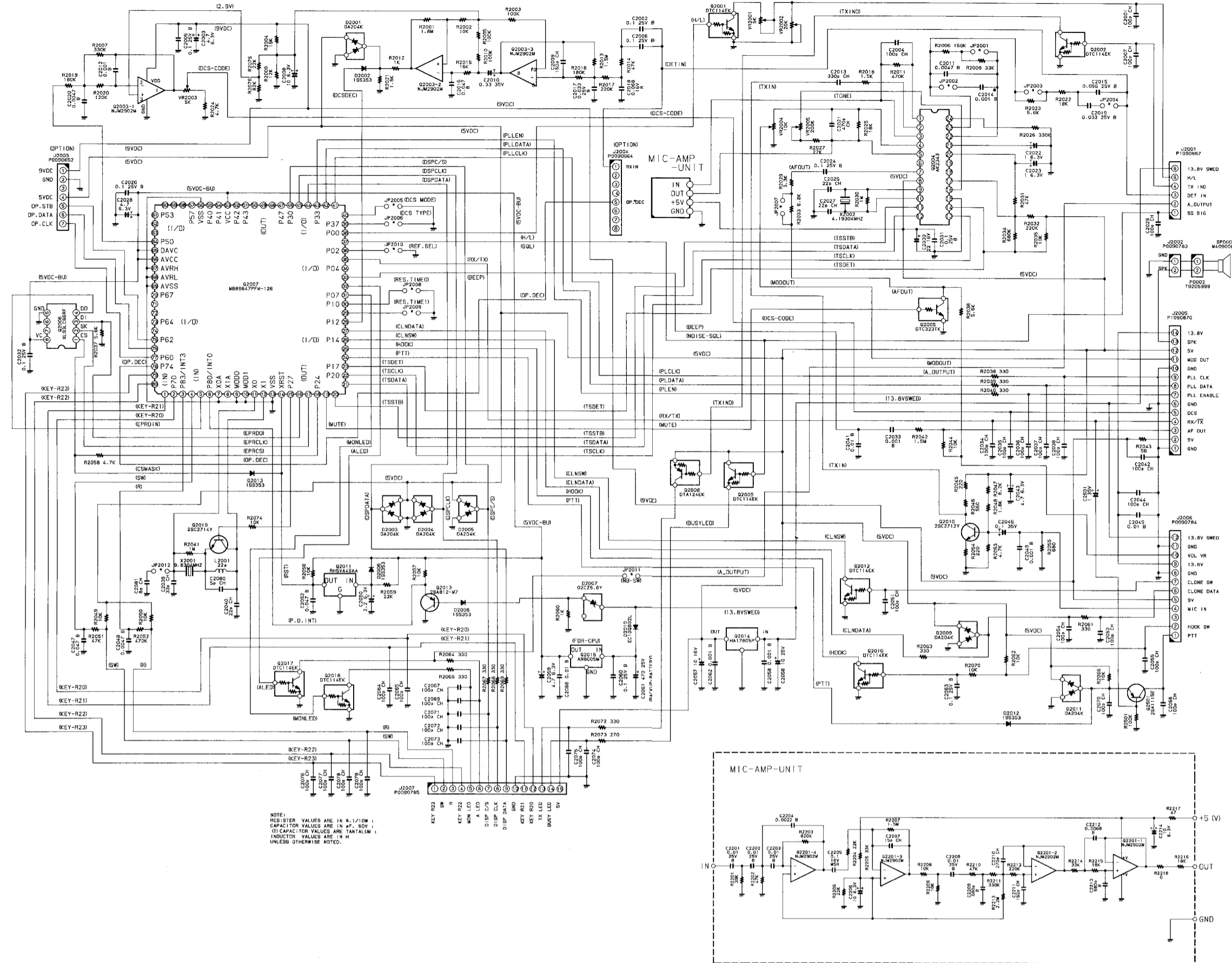

VCO Unit

Circuit Diagram

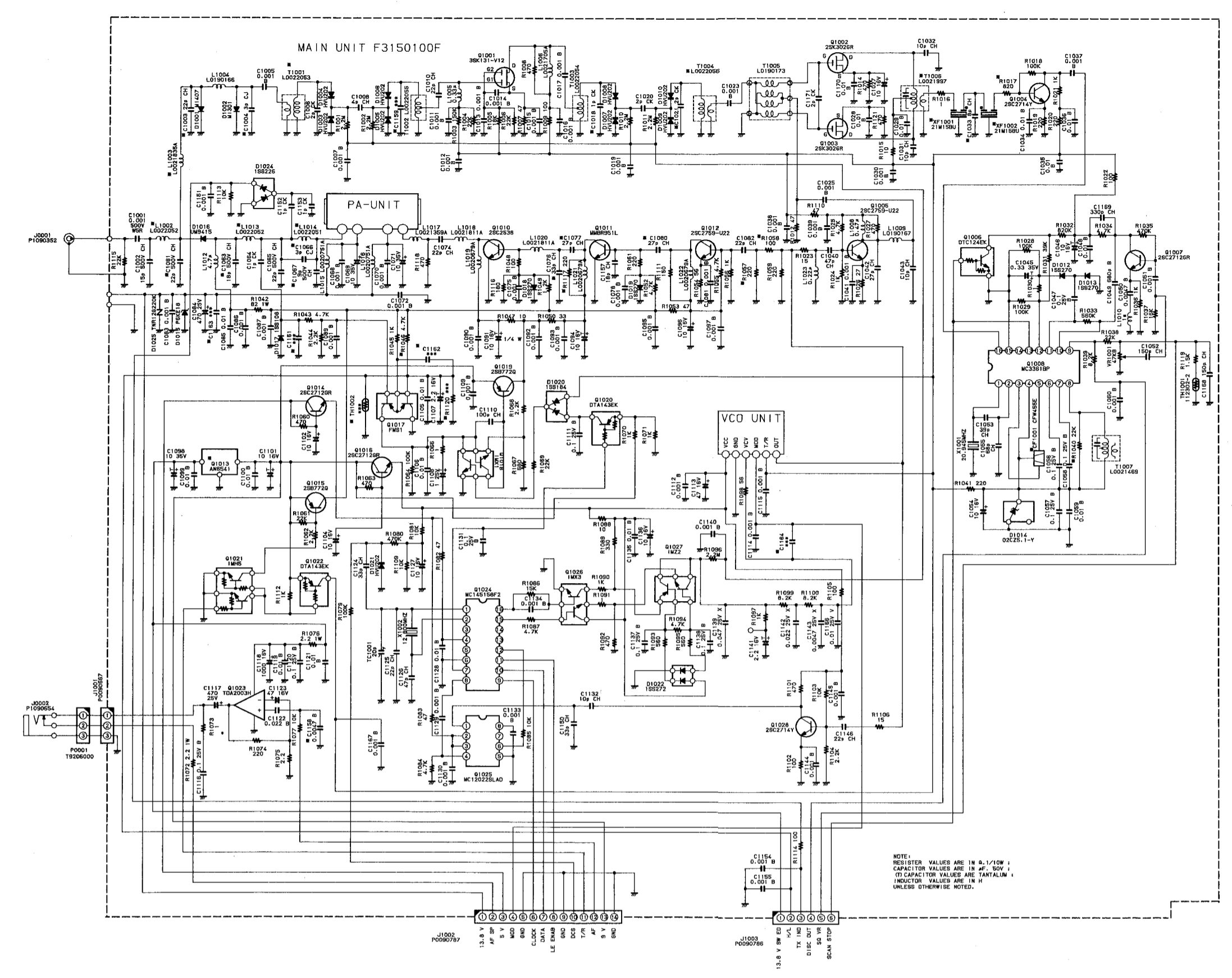

DISP Unit B

Parts Layout & Circuit Diagram

PA Unit (Nos. 9xx)

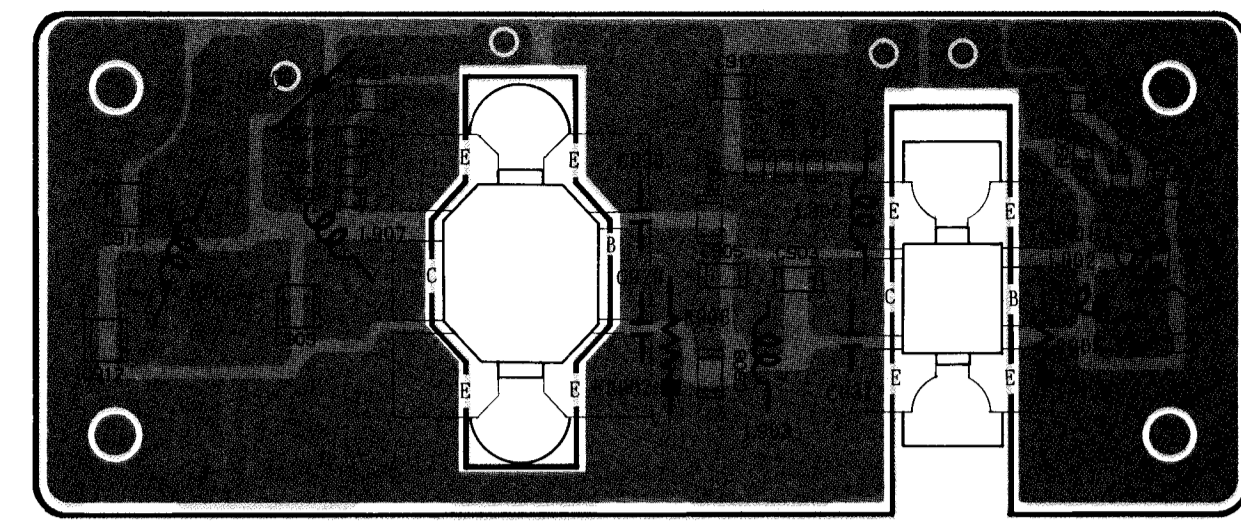

Obverse View of "Mixed Component" Side

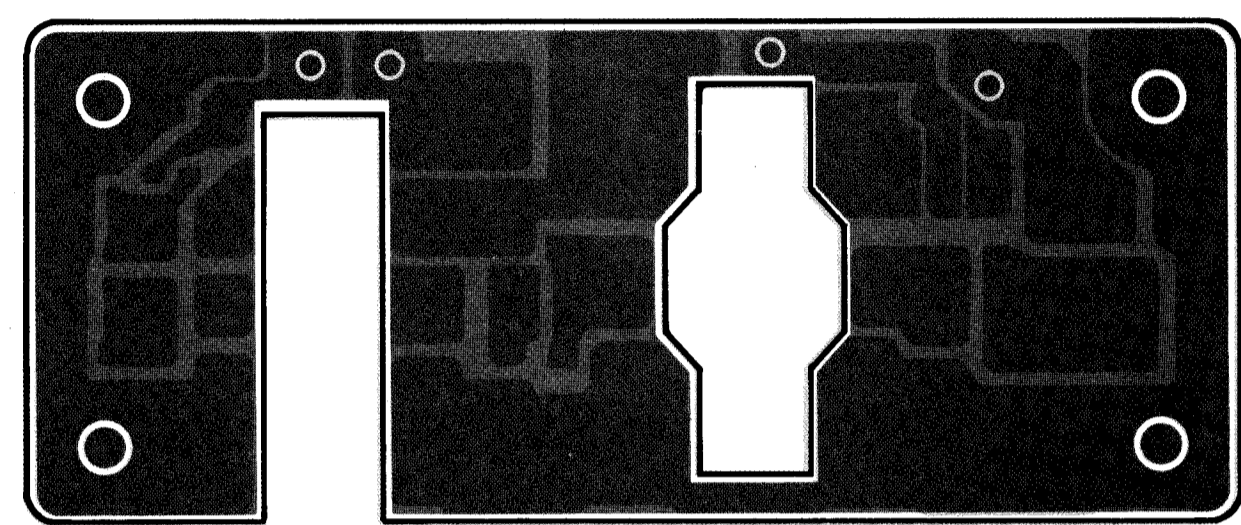

Obverse View of Solder Side

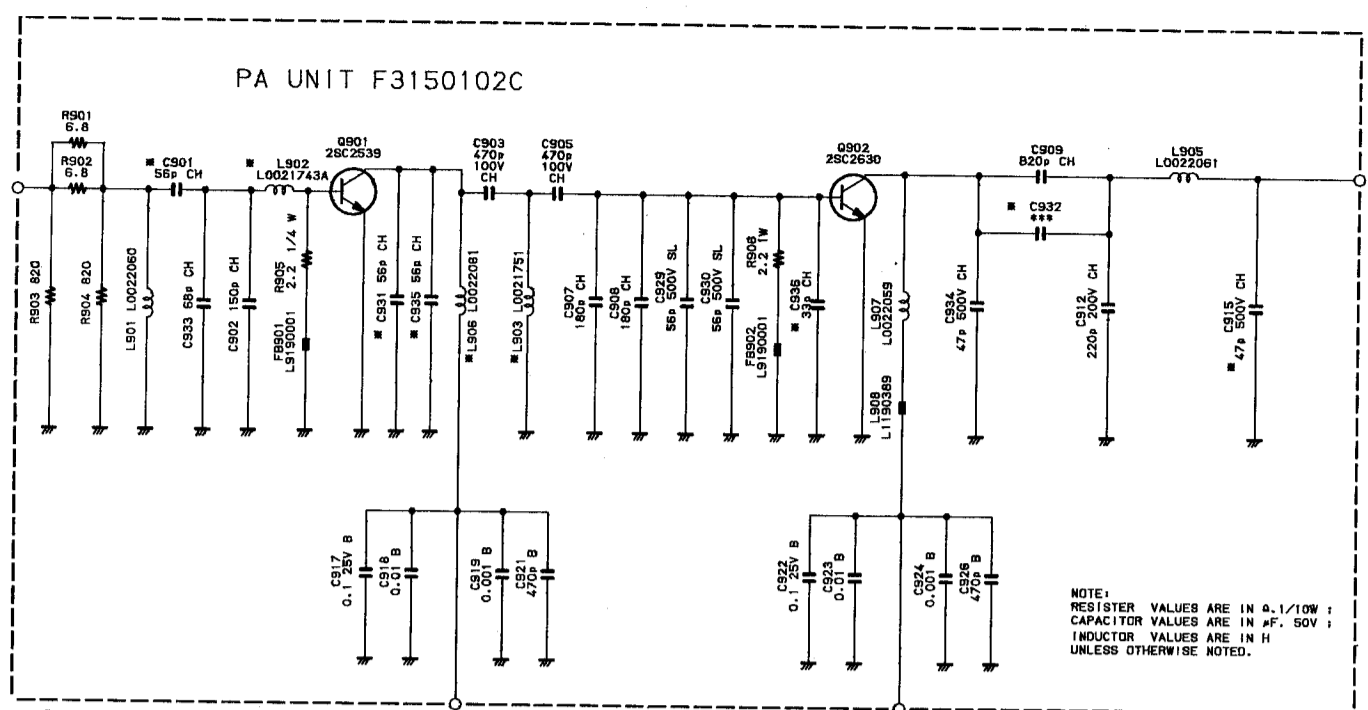

C901	100P	50P
C916	50P	47P
C931	50P	50P
C932	50P	50P
C935	50P	50P
C936	20P	20P
L902	L0022115	L0021743A
L903	L0022116	L0021751
L904	L0022121A	L0022061

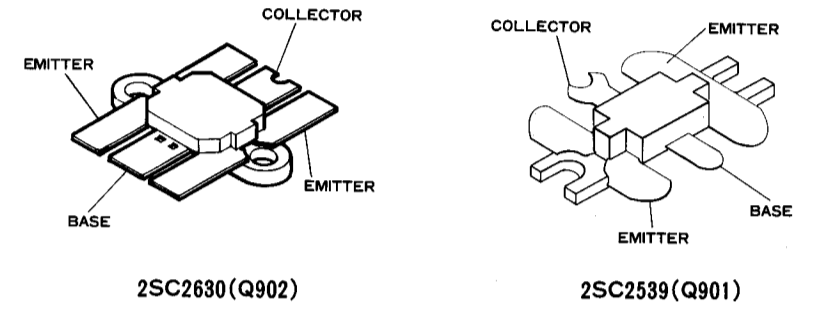

Parts Layout & Circuit Diagram

VCO Unit (Nos. 3xx)

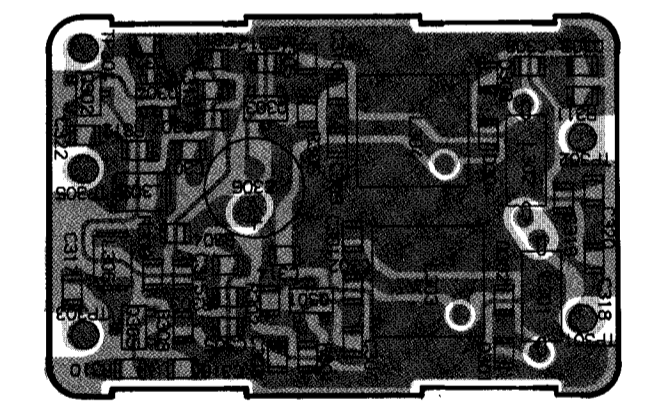

Obverse View of "Mixed Component" Side

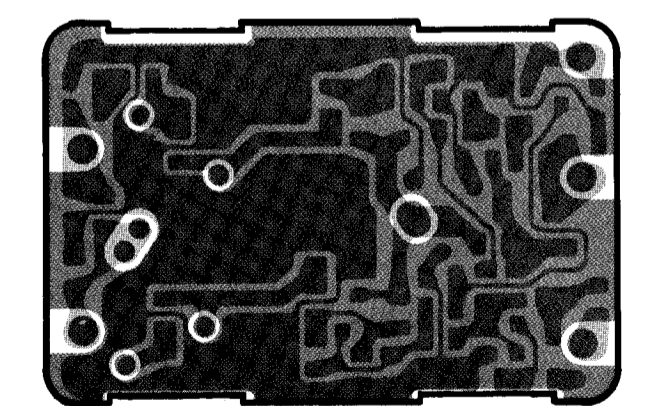

Obverse View of Solder Side

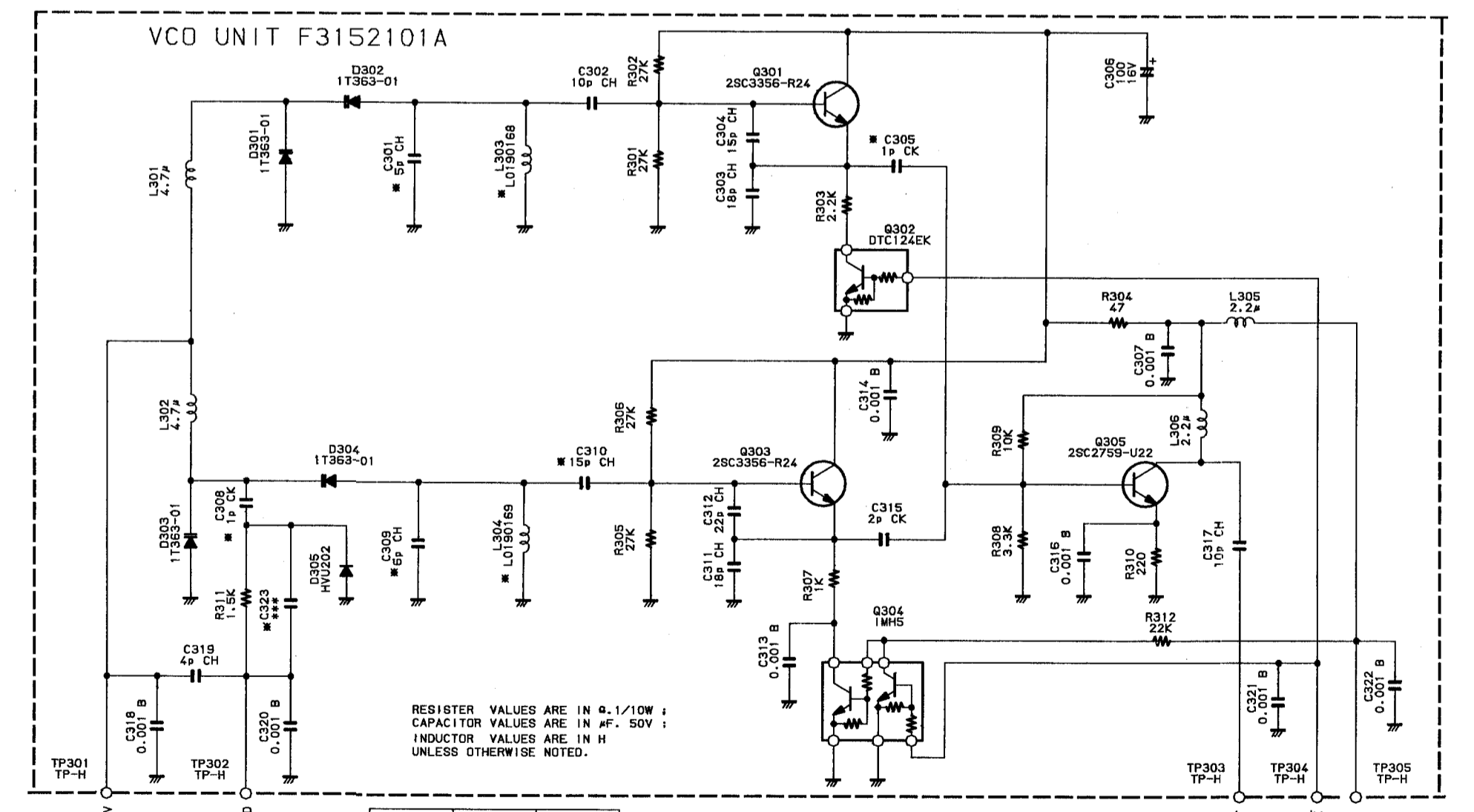

A	C	
L303	L0190174	L0190169
L304	L0190175	L0190168
C301	2P	5P
C305	2P	1P
C308	2P	1P
C309	2P	5P
C310	10P	15P
C323	5P	

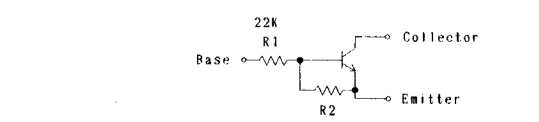
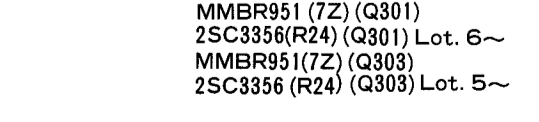
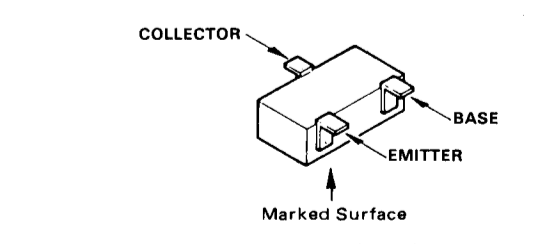

Parts Layout & Circuit Diagram

DISP Unit B (Nos. 2xx)

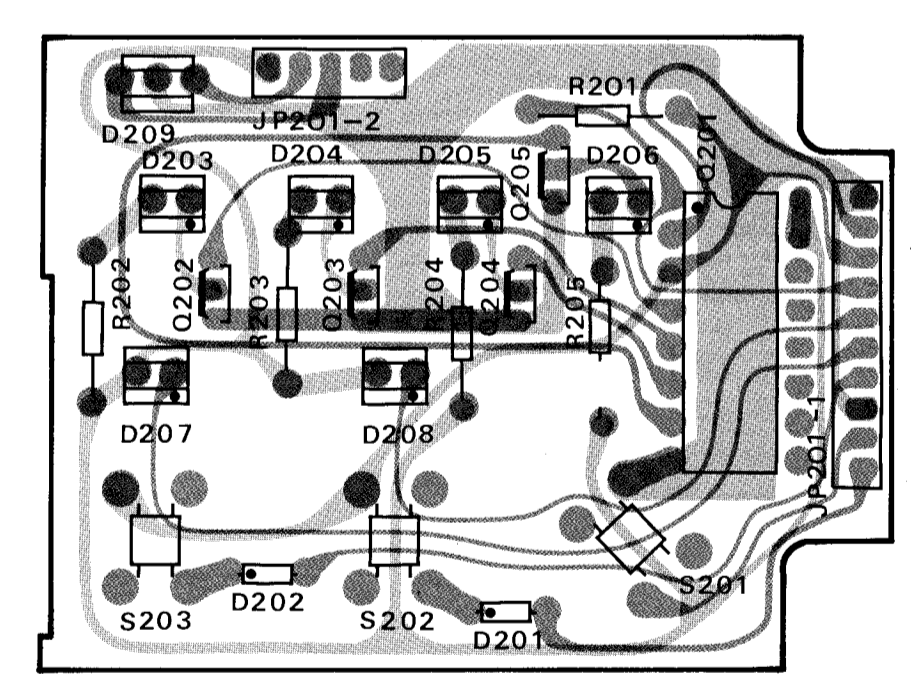

Obverse View of Component Side

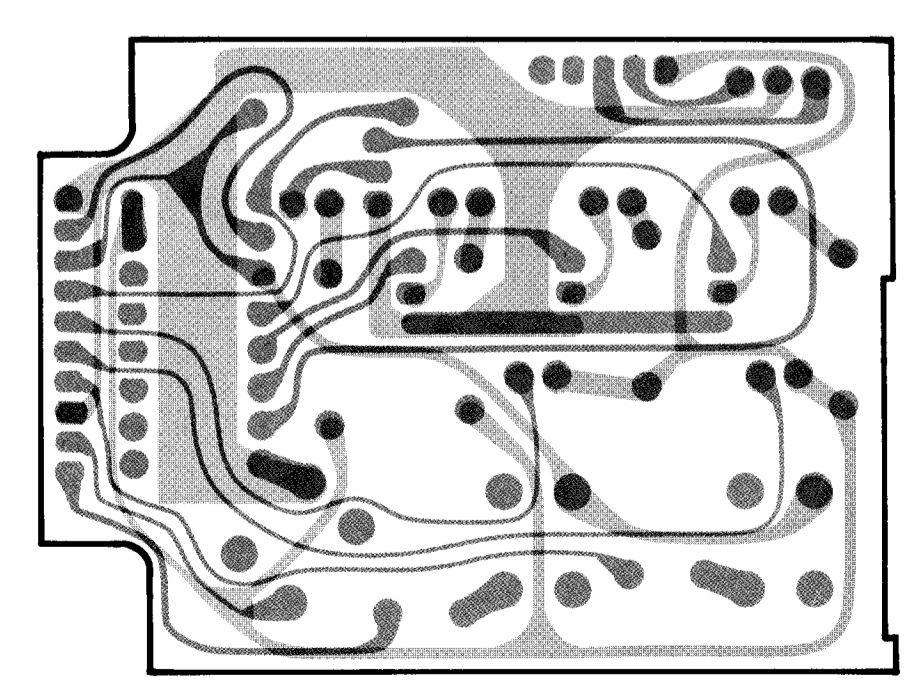

Obverse View of Solder Side

