



VX-1700 Series

HF Multi Mode Mobile Radio Service Manual

For USA Version

©2005 VERTEX STANDARD CO., LTD.

EC051H95A

VERTEX STANDARD CO., LTD.
4-8-8 Nakameguro, Meguro-Ku, Tokyo 153-8644, Japan

VERTEX STANDARD
US Headquarters
10900 Walker Street, Cypress, CA 90630, U.S.A.

YAESU EUROPE B.V.
P.O. Box 75525, 1118 ZN Schiphol, The Netherlands

YAESU UK LTD.
Unit 12, Sun Valley Business Park, Winnall Close
Winchester, Hampshire, SO23 0LB, U.K.

VERTEX STANDARD HK LTD.
Unit 5, 20/F., Seaview Centre, 139-141 Hoi Bun Road,
Kwun Tong, Kowloon, Hong Kong

Introduction

This manual provides the technical information necessary for servicing the VX-1700 HF Transceiver.

Servicing this equipment requires expertise in handling surface-mount chip components. Attempts by non-qualified persons to service this equipment may result in permanent damage not covered by the warranty, and may be illegal in some countries.

Two PCB layout diagrams are provided for each double-sided board in this transceiver. Each side of the board is referred to by the type of the majority of components installed on that side ("Side A" or "Side B"). In most cases one side has only chip components (surface-mount devices), and the other has either a mixture of both chip and leaded components (trimmers, coils, electrolytic capacitors, ICs, etc.), or leaded components only.

As described in the pages to follow, the advanced microprocessor design of the VX-1700 Transceiver allows a complete alignment of this transceiver to be performed without opening the case of the radio; all adjustments can be performed from the front panel, using the "Alignment Mode" menu.

While we believe the information in this manual to be correct, VERTEX STANDARD assumes no liability for damage that may occur as a result of typographical or other errors that may be present. Your cooperation in pointing out any inconsistencies in the technical information would be appreciated.

Contents

Specifications	2
Exploded View & Miscellaneous Parts	3
Block Diagram	5
Connection Diagram	6
Circuit Description	7
Connector Pinout Diagrams	10
Alignment	11
ALE-1 Automatic Link Establishment Unit Installation	19
CE77 PC Programming Software	21
Board Units (Schematics, Layouts & Parts)	
MAIN Unit	49
PA Unit	71
PANEL Unit	81
GPS-INTERFACE Unit	87
MIC Unit	91
ENC Unit	92
ALE Unit (Option)	93

Specifications

General

Receiver Frequency Range:	30 kHz ~ 30.0000 MHz
Transmitter Frequency:	1.600 ~ 30.0000 MHz
Emission Modes:	A1A (CW), J3E (LSB/USB), A3E (AM), J2B (USB/LSB),
Frequency Synthesizer Step:	10 Hz, 100 Hz, 1 kHz
Frequency Stability:	±1 ppm (Typical)
Operating Temperature Range:	14° F ~ 131° F (-10° ~ +55° C) @Duty Cycle TX:RX = 1 min.: 4 min.
Antenna Impedance:	50 Ohms
Supply Voltage:	13.8 Volts DC ±15%, negative ground
Power Consumption:	25 mA (Standby) 1.0 A (Receive, no signal) 1.5 A (Receive) 22 A (Transmit, 125 Watts output)
Dimensions (WxHxD):	9.5" x 3.9" x 11.2" (241 x 99 x 285 mm)
Weight (approx.):	9.5 lbs (4.3 kg)

Transmitter

Power Output:	125 Watts (A1A, J2B, J3E @1.6000 ~ 3.9999 MHz) 100 Watts (A1A, J2B, J3E @4.0000 ~ 30.0000 MHz) 31 Watts AM Carrier (A3E @1.6000 ~ 3.9999 MHz) 25 Watts AM Carrier (A3E @4.0000 ~ 30.0000 MHz)
Modulation Types:	J3E: PSN type modulator, A3E: Low-level (early stage)
Spurious Radiation:	Better than -56 dB
J3E Carrier Suppression:	Better than 50 dB below peak output
Undesired Sideband Suppression:	Better than 60 dB below peak output
J3E Audio Response:	Not more than -6 dB from 400 Hz ~ 2500 Hz
Occupied Bandwidth:	A1A: less than 0.5 kHz J3E: less than 3.0 kHz A3E: less than 6.0 kHz
Microphone Impedance:	200 ~ 10 k Ohms (600 Ohms Nominal)

Receiver

Circuit Type:	Double-conversion Superheterodyne		
Intermediate Frequencies:	1st: 45.274 MHz, 2nd: 24 kHz		
Sensitivity:	A1A/J2B/J3E	A3E	
	0.1 ~ 0.5 MHz	—	—
	0.5 ~ 1.6 MHz:	1.41 µV	8 µV
	1.6 ~ 30 MHz:	0.16 µV	1 µV
	(A1A/J2B/J3E/A3E: S/N 10 dB)		
Squelch Sensitivity (A1A/J2B/J3E):	0.1 ~ 0.5 MHz	—	
	0.5 ~ 1.6 MHz:	2.5 µV	
	1.6 ~ 30 MHz:	2 µV	
IF Rejection:	Better than 80 dB		
Image Rejection:	Better than 80 dB		
Selectivity:		-6 dB	-60 dB
	A1A(W), J2B(W), J3E	> 2.2 kHz	< 4.5 kHz
	A1A(N), J2B(N)	> 500 Hz	< 2.0 kHz
	A3E	> 6 kHz	< 20 kHz
Audio Output:	At least 2.2 Watts into 8 Ohms @ 10% THD		
Audio Output Impedance:	4 ~ 16 Ohms (8 Ohms Nominal)		
Conducted Radiation:	Less than 4000 µµW		

Specifications are subject to change without notice or obligation.

Exploded View & Miscellaneous Parts

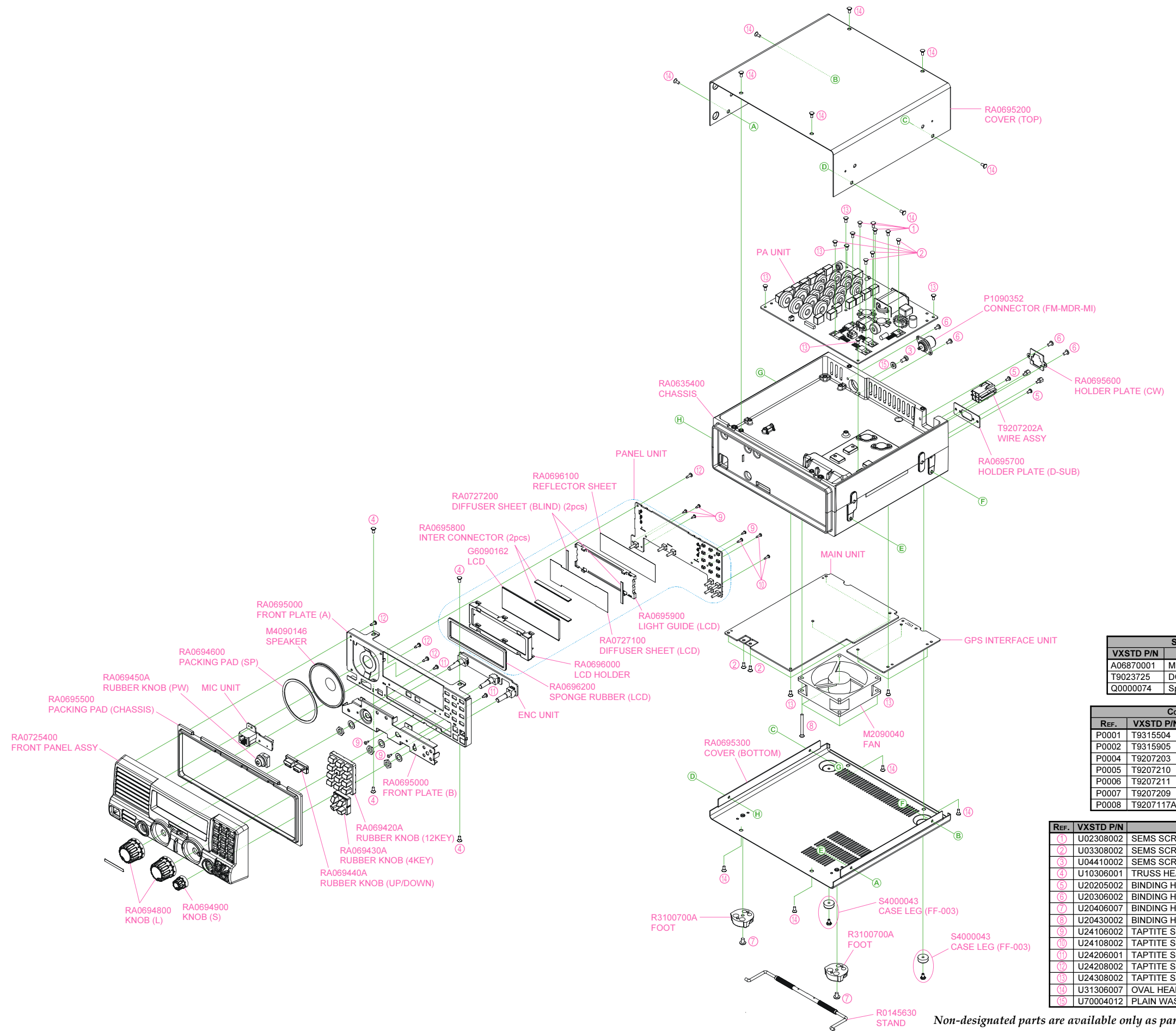

SUPPLIED ACCESSORIES		
VXSTD P/N	DESCRIPTION	QTY.
A06870001	MH-31A&J Hand Microphone	1
T9023725	DC Power Cord	1
Q0000074	Spare Fuse (25 A Blade Type)	1

CONNECTION CABLES		
REF.	VXSTD P/N	DESCRIPTION
P0001	T9315504	Coaxial Cable (J1001+J2006)
P0002	T9315905	Coaxial Cable (J1002+J2001)
P0004	T9207203	30-pin Flat Cable (J1003+J2002)
P0005	T9207210	13-pin Molex (J1008+J4001)
P0006	T9207211	8-pin Molex (J1005+J6002)
P0007	T9207209	8-pin Molex (J3004+J6101)
P0008	T9207117A	30-pin Flat Cable (J1004+J3001)

REF.	VXSTD P/N	DESCRIPTION	QTY.
①	U02308002	SEMS SCREW SM3X8NI	4
②	U03308002	SEMS SCREW ASM3X8NI	7
③	U04410002	SEMS SCREW HSM4X10NI	1
④	U10306001	TRUSS HEAD SCREW M3X6	4
⑤	U20205002	BINDING HEAD SCREW M2.6X5NI	2
⑥	U20306002	BINDING HEAD SCREW M3X6NI	4
⑦	U20406007	BINDING HEAD SCREW M4X6B	2
⑧	U20430002	BINDING HEAD SCREW M4X30(Ni)	4
⑨	U24106002	TAPTITE SCREW M2X6NI	6
⑩	U24108002	TAPTITE SCREW M2X8NI	3
⑪	U24206001	TAPTITE SCREW M2.6X6	2
⑫	U24208002	TAPTITE SCREW M2.6X8NI	4
⑬	U24308002	TAPTITE SCREW M3X8NI	14
⑭	U31306007	OVAL HEAD SCREW M3X6B	12
⑮	U70004012	PLAIN WASHER FW4BSNI	1

Non-designated parts are available only as part of a designated assembly.

Exploded View & Miscellaneous Parts

Note

Block Diagram

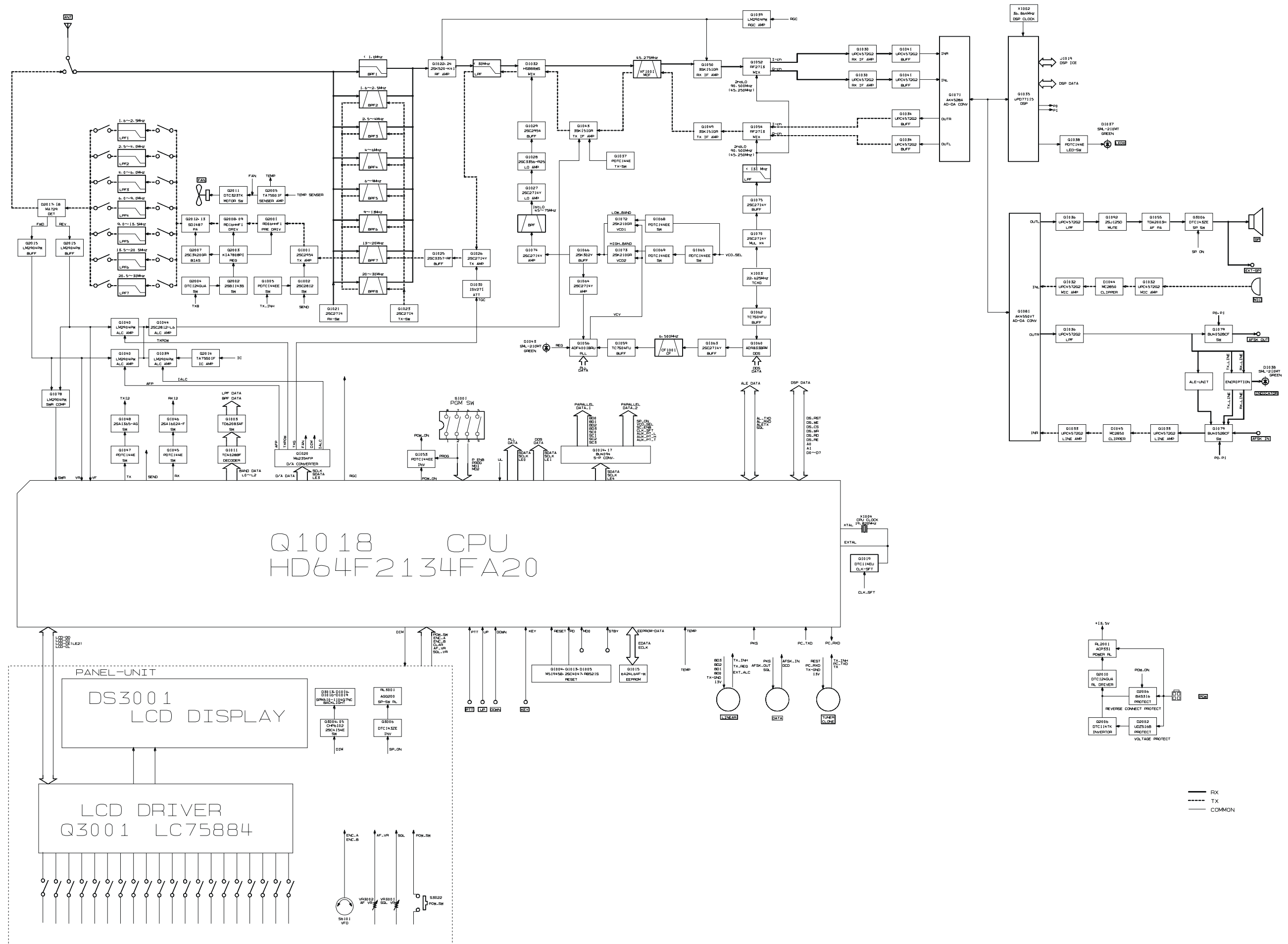

Receive Signal Path

Incoming RF signal from the ANT jack is delivered to the PA Unit, and passes through the TX/RX relay RL2009 to J2006.

The RF signal is then applied to J1001 on the MAIN Unit, and passed through the limiter circuit consisting of **D1006**, **D1007**, **D1008**, and **D1009** (all **RLS245**) to prevent distortion from high RF signal input, and is fed to one of eight band-pass filters which strip away unwanted signals prior to delivery of the incoming signal to the RF amplifiers, **Q1022** and **Q1024** (both **2SK520-K41**).

The amplified RF signal passes through a low-pass filter to the doubly-balanced mixer **D1032** (**HSB88WS**), where the RF signal is mixed with the 1st local signal delivered from buffer amplifier **Q1029** (**2SC2954**), resulting in a 45.274 MHz 1st IF signal.

The 45.274 MHz 1st IF signal is fed through monolithic crystal filter **XF1001**, which strips away unwanted mixer products, and is amplified by 1st IF amplifier **Q1050** (**3SK151GR**); the 1st IF signal is then applied to the 2nd mixer **Q1052** (**RF2713**), where it is mixed with the 45.25 MHz 2nd local signal which is divided from 90.5 MHz reference signal delivered from buffer amplifier **Q1075** (**2SC2714Y**), resulting in a 24 kHz 2nd IF signal.

The 24 kHz 2nd IF signal is fed through buffer amplifiers **Q1030** and **Q1041** (both **UPC4572G2**) to the A/D converter **Q1071** (**AK4528A**), then delivered to the DSP IC **Q1035** (**UPD77115**), where the 24 kHz 2nd IF signal is demodulated in accordance with the mode selection data from the main CPU **Q1018** (**HD64F2134**). The demodulated signal is delivered to the D/A converter **Q1081** (**AK4550VT**) which converts the demodulated signal to audio.

The audio signal from the D/A converter **Q1081** (**AK4550VT**) is fed through a low-pass filter at **Q1036** (**UPC4572G**), which eliminates high-pitched noise on the audio signal, and is fed to the AF mute gate **Q1092** (**2SJ125D**), then applied to the audio amplifier **Q1055** (**TDA2003H**). The amplified audio signal is delivered to J3001 on the PANEL Unit, then passes through the speaker switch RL3001/**Q3006** (**DTC143ZE**) to the internal or external speaker.

The DSP IC **Q1035** (**UPD77115**) outputs AGC data which is proportionate to the received signal strength to the main CPU **Q1018** (**HD64F2134**). The main CPU **Q1018** (**HD64F2134**), in turn, outputs a DC voltage in accordance with the received signal strength. This DC voltage is fed through buffer amplifier **Q1039** (**LM2904PW**) to RF amplifiers **Q1022** & **Q1024** (both **2SK520**) and gate 2 of IF amplifier **Q1050** (**3SK151GR**), to reduce their gains when strong signals are present in the receiver passband.

Transmit Signal Path

The speech audio from the microphone is delivered to J6001 on the MIC Unit, then applied to J1005 on the MAIN Unit.

The speech audio is amplified by **Q1032-1** (**UPC4572G2**), then passed through the clipper, **D1044** (**MC2850**), and further amplified by **Q1032-2** (**UPC4572G2**).

The amplified speech audio is fed through the A/D converter **Q1081** (**AK4550VT**), then delivered to the DSP IC **Q1035** (**UPD77115**), where the speech audio is modulated in the 24 kHz TX 1st IF signal in accordance with the mode selection data from the main CPU, **Q1018** (**HD64F2134**).

The modulated signal is fed through the D/A converter **Q1071** (**AK4528A**) and buffer amplifier **Q1034** (**UPC4572G2**) to the mixer **Q1054** (**RF2713**) where the 24 kHz TX 1st IF signal is mixed with 1st local signal delivered from buffer amplifier **Q1075** (**2SC2714Y**), resulting in a 45.274 MHz IF signal.

The resulting 45.274 MHz IF signal is buffered by **Q1049** (**3SK151GR**), then delivered to the monolithic crystal filter **XF1001**, which strips away unwanted mixer products, and then is amplified by **Q1043** (**3SK151GR**). The amplified IF signal is delivered to doubly-balanced mixer **D1032** (**HSB88WS**), where it is mixed with the PLL local signal from the buffer amplifier, **Q1029** (**2SC2954**).

The resulting the RF signal at the transmit frequency is fed through a low-pass filter circuit, and then is amplified by **Q1026** (**2SC2714Y**) and buffer amplifier **Q1025** (**2SC3357**), and then filtered by one of eight band-pass filters to suppress out-of-band responses. The RF signal is then amplified by **Q1001** (**2SC2954**) and delivered to the PA Unit.

Circuit Description

On the PA Unit, the low-level RF signal from the MAIN Unit is amplified by pre-driver **Q2001 (RD06HHF1)**, push-pull driver **Q2008/Q2009 (both RD16HHF1)**, and push-pull final amplifier **Q2012/Q2013 (both SD1405)**, which provides up to 120 watts of RF output power.

The RF output from the final amplifier is fed through the one of seven low-pass filters, sampling directional coupler T2005, and TX/RX relay RL2009 before delivery to the antenna jack.

The sampling directional coupler senses forward and reverse power output, which is rectified by **D2017** and **D2018 (both MA729)**, respectively, and the DC voltage is then amplified by **Q2015 (LM2904PW)** on the PA Unit.

The DC voltages derived from forward and reverse power are applied to J1003 on the MAIN Unit, and then amplified by **Q1040 (LM2904PW)** and **Q1044 (2SC2812)**. The amplified DC voltage is fed back to the 2nd gate of the 45.275 MHz IF amplifier **Q1043 (3SK151GR)**, so that the transmitter's IF gain can be regulated by this sensing of the power output, preventing overdrive or damage caused by transmission into an excessive impedance mismatch at the antenna.

PLL Circuit

The PLL local signal for the receiver 1st local and the transmitter final local is generated by one of two VCOs: **Q1072** or **Q1073 (both 2SK210GR)** in conjunction with varactor diodes **D1047, D1048, D1049, D1050, D1051, D1052, D1053, and D1054 (all HVU359)** on the MAIN Unit. The oscillating frequency is determined primarily by the level of DC voltage applied to the varactor diodes. The VCO output is buffered by **Q1066 (2SK302Y)**, amplified by **Q1074 (2SC2714Y)**, and band-pass filtered by capacitors C1389, C1391, C1397, C1400, C1409, and C1420 and coils L1070, L1071, L1074, and L1076. The filtered PLL local signal is fed through buffer amplifiers **Q1027 (2SC2714Y)**, **Q1028 (2SC3356)**, and **Q1029 (2SC2954)** to the TX final mixer or RX 1st mixer **D1032 (HSB88WS)**.

A portion of the output of buffer amplifier **Q1066 (2SK302Y)** is further amplified by **Q1064 (2SC2714Y)**, then delivered to the PLL subsystem

IC **Q1056 (ADF4001BRU)**, which contains a reference divider, serial-to-parallel data latch, programmable divider, phase comparator and a swallow counter. The sample VCO signal is divided by the programmable divider section of the **Q1056 (ADF4001BRU)**. Meanwhile, the output from the 22.625 MHz TCXO reference oscillator, **X1003**, is amplified by **Q1062 (TC7S04FU)** and divided by the DDS IC **Q1060 (AD9833BRM)** in accordance with the PLL dividing data from the main CPU, **Q1018 (HD64F2134)**, then fed through the buffer amplifiers **Q1063 (2SC2714Y)** to ceramic filter **CF1001**. The divided and filtered reference signal is applied to the reference divider section of the PLL subsystem IC **Q1056 (ADF4001BRU)**, where it is divided by 25/26 to produce the loop reference.

The divided signal from the programmable divider (derived from the VCO), and that derived from the reference oscillator, are applied to the phase detector section of the PLL subsystem IC **Q1056 (ADF4001BRU)**, which produces a pulsed output with pulse duration depending on the phase difference between the input signals. This pulse train is fed through the loop filter, consisting of resistors R1222, R1233, & R1247 and capacitors C1278, C1284, C1298, C1308, & C1418, then fed back to the VCO varactor diodes **D1047, D1048, D1049, D1050, D1051, D1052, D1053, and D1054 (all HVU359)**.

Changes in the DC voltage applied to these varactor diodes affect the reactance in the tank circuit of VCOs **Q1072** and **Q1073 (both 2SK210GR)**, changing the oscillating frequency according to the phase difference between the signals derived from the VCO and the TCXO reference oscillator. The VCO is thus phase-locked to the reference frequency standard.

A portion of the output of reference signal from TCXO **X1003** is multiplied by four at **Q1070 (2SC2714Y)**. The resulting 90.5 MHz signal is buffered by **Q1075 (2SC2714Y)**, then applied to a low-pass filter, consisting of capacitors C1401, C1405, C1410, C1411, and C1421 and coils L1075 and L1077. The filtered reference signal is applied to the TX 1st mixer **Q1054** and RX 2nd mixer **Q1052 (both RF2713)**.

Control Circuit

Major frequency control functions such as channel selection, display, and PLL divider control are performed by main CPU **Q1018 (HD64F2134)** on the MAIN Unit, at the command of the user via the tuning knob and function switches on the front panel.

The programmable divider data for the PLL from the main CPU is applied directly to DDS IC **Q1016 (AD9833BRM)** and PLL subsystem IC **Q1056 (ADF4001BRU)**.

The Mode selection data from the main CPU is also delivered to DSP IC **Q1035 (UPD77115)** to control the various circuits required for the selected mode.

The Band selection binary data from the main CPU is decoded (BCD to Decimal) by **Q1011 (TC4028BF)**. The resulting decimal outputs are level-shifted by **Q1003 (TD62783AF)** to select the active band-pass filter on the MAIN Unit required for the operating frequency. Also, the decimal outputs from **Q1003 (TD62783AF)** are delivered to PA Unit, where they are used to select the active low-pass filter required for the operating frequency.

TX/RX Control

When the PTT switch is pressed, pin 21 of the main CPU **Q1018 (HD64F2134)** goes low, which causes pin 60 of the main CPU **Q1018 (HD64F2134)** to go low. This signal disables the receiver 12 V bus at **Q1046 (2SA1602A)**. At the same time, pin 59 of the main CPU **Q1018 (HD64F2134)** goes low to activate the transmit 12 V bus at **Q1048 (2SA1365)**.

Power Supply & Regulation

The +5 V bus for the main CPU **Q1018 (HD64F2134)** is derived from the 13.5 V bus via regulator **Q1012 (BA05FP)** on the MAIN Unit. The +8 V bus is derived from the 13.5 V bus via regulator **Q1007 (KIA7808API)** on the MAIN Unit.

A portion of the +8 V bus is regulated by **Q1008 (L78M05T)** for the +5 V bus, and is regulated by **Q1006 (UPC2926)** for the +2.6 V bus required by the DSP IC **Q1035 (UPD77115GK)**.

Connector Pinout Diagrams

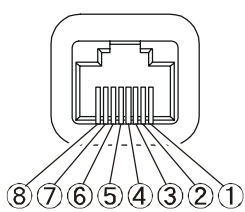
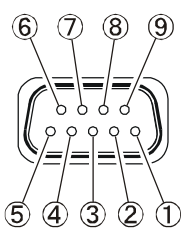
MIC Jack	GPS Jack			
<p style="text-align: center;">(As Viewed From Front Panel)</p>  <ul style="list-style-type: none"> ① P ENB ② CNTL GND ③ PTT ④ MIC ⑤ MIC GND ⑥ + 5V ⑦ UP ⑧ DOWN 	<p style="text-align: center;">(As Viewed From Rear Panel)</p>  <ul style="list-style-type: none"> ① Connected with ④, ⑥, ⑦, and ⑧. ② GPS Data Input (+) ③ N/C ④ Connected with ①, ⑥, ⑦, and ⑧. ⑤ GPS Data Input (-) ⑥ Connected with ①, ④, ⑦, and ⑧. ⑦ Connected with ①, ④, ⑥, and ⑧. ⑧ Connected with ①, ④, ⑥, and ⑦. ⑨ NC 			
<table border="1" style="width: 100%; border-collapse: collapse;"> <tr> <td style="width: 50px;">Pin 3</td> <td>PTT</td> <td>Open Circuit Voltage: 5 V, Closed Circuit Current: 1 mA</td> </tr> </table>		Pin 3	PTT	Open Circuit Voltage: 5 V, Closed Circuit Current: 1 mA
Pin 3	PTT	Open Circuit Voltage: 5 V, Closed Circuit Current: 1 mA		

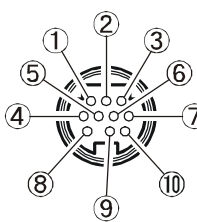
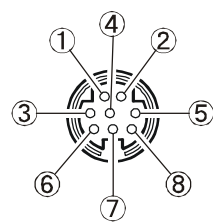
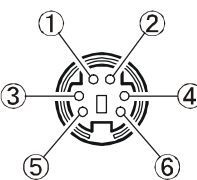
ACC Jack	TUNE Jack	DATA Jack																					
<p style="text-align: center;">(As Viewed From Rear Panel)</p>  <ul style="list-style-type: none"> ① +13.8 V OUT ② TX GND ③ GND ④ BAND DATA A ⑤ BAND DATA B ⑥ BAND DATA C ⑦ BAND DATA D ⑧ TX-INH ⑨ EXT ALC Input ⑩ TX REQ 	<p style="text-align: center;">(As Viewed From Rear Panel)</p>  <ul style="list-style-type: none"> ① +13.8 V OUT ② TX GND ③ GND ④ RX D ⑤ TX D ⑥ TUNER SENSE ⑦ RESET ⑧ TX-INH 	<p style="text-align: center;">(As Viewed From Rear Panel)</p>  <ul style="list-style-type: none"> ① DATA IN ② GND ③ DATA PTT ④ DCD ⑤ DATA OUT ⑥ SQL OUT 																					
<table border="1" style="width: 100%; border-collapse: collapse;"> <tr> <td style="width: 50px;">Pin 1</td> <td>+13.8 V</td> <td>Max. 1 A This terminal is connected in parallel with the pin 1 of TUNE Jack.</td> </tr> <tr> <td>Pin 2</td> <td>TX GND</td> <td>Open Collector (Max. 60 V, 1A) This terminal is connected in parallel with the pin 2 of TUNE Jack.</td> </tr> </table>	Pin 1	+13.8 V	Max. 1 A This terminal is connected in parallel with the pin 1 of TUNE Jack.	Pin 2	TX GND	Open Collector (Max. 60 V, 1A) This terminal is connected in parallel with the pin 2 of TUNE Jack.	<table border="1" style="width: 100%; border-collapse: collapse;"> <tr> <td style="width: 50px;">Pin 1</td> <td>+13.8 V</td> <td>Max. 1 A This terminal is connected in parallel with the pin 1 of ACC Jack.</td> </tr> <tr> <td>Pin 2</td> <td>TX GND</td> <td>Open Collector (Max. 60 V, 1A) This terminal is connected in parallel with the pin 2 of ACC Jack.</td> </tr> </table>	Pin 1	+13.8 V	Max. 1 A This terminal is connected in parallel with the pin 1 of ACC Jack.	Pin 2	TX GND	Open Collector (Max. 60 V, 1A) This terminal is connected in parallel with the pin 2 of ACC Jack.	<table border="1" style="width: 100%; border-collapse: collapse;"> <tr> <td style="width: 50px;">Pin 1</td> <td>DATA IN</td> <td>60 mVp-p @1 kΩ.</td> </tr> <tr> <td>Pin 5</td> <td>DATA OUT</td> <td>500 mVp-p @1 kΩ</td> </tr> <tr> <td>Pin 6</td> <td>SQL OUT</td> <td>SQL OPEN: 5 V SQL CLOSE: 0 V</td> </tr> </table>	Pin 1	DATA IN	60 mVp-p @1 kΩ.	Pin 5	DATA OUT	500 mVp-p @1 kΩ	Pin 6	SQL OUT	SQL OPEN: 5 V SQL CLOSE: 0 V
Pin 1	+13.8 V	Max. 1 A This terminal is connected in parallel with the pin 1 of TUNE Jack.																					
Pin 2	TX GND	Open Collector (Max. 60 V, 1A) This terminal is connected in parallel with the pin 2 of TUNE Jack.																					
Pin 1	+13.8 V	Max. 1 A This terminal is connected in parallel with the pin 1 of ACC Jack.																					
Pin 2	TX GND	Open Collector (Max. 60 V, 1A) This terminal is connected in parallel with the pin 2 of ACC Jack.																					
Pin 1	DATA IN	60 mVp-p @1 kΩ.																					
Pin 5	DATA OUT	500 mVp-p @1 kΩ																					
Pin 6	SQL OUT	SQL OPEN: 5 V SQL CLOSE: 0 V																					

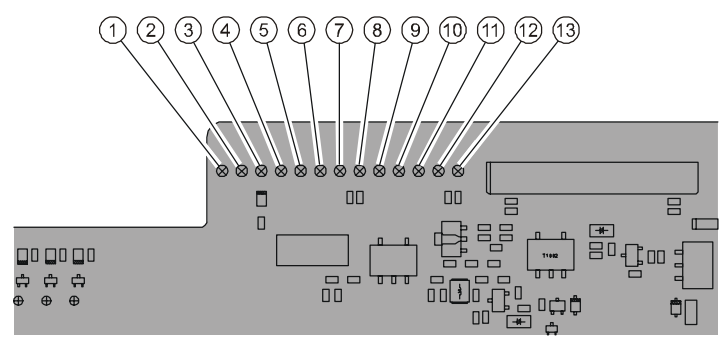
Accessory Port (Located on the MAIN Unit)	
	<ul style="list-style-type: none"> ① ENCR_TXIN ② ENCR_RXIN ③ INDICATOR ④ CODE (8) ⑤ CODE (4) ⑥ CODE (2) ⑦ CODE (1) ⑧ ENCR_RXOUT ⑨ CLEAR/SCRAMBLE ⑩ PTT ⑪ VCC ⑫ GND ⑬ ENCR_TXOUT

The VX-1700 is carefully aligned at the factory for the specified performance across the entire operating frequency range. Realignment should therefore not be necessary except in the event of a component failure. All component replacement and service should be performed only by an authorized Vertex Standard representative, or the warranty policy may be void.

The following procedures cover the sometimes critical and tedious adjustments that are not normally required once the product has left the factory. However, if damage occurs and some parts subsequently are replaced, realignment may be required. If a sudden problem occurs during normal operation, it is likely due to component failure; realignment should not be done until after the faulty component has been replaced.

We recommend that servicing be performed only by authorized Vertex Standard service technicians who are experienced with the circuitry and fully equipped for repair and alignment. Therefore, if a fault is suspected, contact the dealer from whom the product was purchased for instructions regarding repair. Authorized Vertex Standard service technicians realign all circuits and make complete performance checks to ensure compliance with factory specifications after replacing any faulty components.

Those who do undertake any of the following alignments are cautioned to proceed at their own risk. Problems caused by unauthorized attempts at realignment are not covered by the warranty policy. Also, Vertex Standard reserves the right to change circuits and alignment procedures in the interest of improved performance, without notifying owners.

Under no circumstances should any alignment be attempted unless the normal function and operation of the product are clearly understood, the cause of the malfunction has been clearly pinpointed and any faulty components replaced, and realignment determined to be absolutely necessary.

The following test equipment (and thorough familiarity with its correct use) is necessary for complete realignment. Correction of problems caused by misalignment resulting from use of improper test equipment is not covered under the warranty policy. While most steps do not require all of the equip-

ment listed, the interactions of some adjustments may require that more complex adjustments be performed afterwards. Do not attempt to perform only a single step unless it is clearly isolated electrically from all other steps. Have all test equipment ready before beginning, and follow all of the steps in a section in the order presented.

Required Test Equipment

- RF Signal Generator with calibrated output level at 30 MHz
- In-line Wattmeter with 5% accuracy at 30 MHz
- 50 Ohm RF Dummy Load with power rating of 200 W at 30 MHz
- 150 Ohm RF Dummy Load with power rating of 200 W at 30 MHz
- Frequency Counter with 0.02 ppm accuracy at 100 MHz
- AF Signal Generator
- AC Voltmeter
- DC Voltmeter: High input impedance
- DC Ammeter
- HF Sampling Coupler
- IBM® PC / compatible Computer with Windows® 95/98/ME/XP/2000. Internet Explorer 4.0 or higher
- Vertex Standard CT-62 Programming Cable & CE77 Programming/Alignment Software

Alignment Preparation & Precautions

A 50-Ohm RF Dummy Load and in-line wattmeter must be connected to the ANT jack in all procedures that call for transmission, except where specified otherwise. Correct alignment is not possible with an antenna.

After completing one step, read the following step to determine whether the same test equipment will be required. If not, remove the test equipment (except dummy load and wattmeter, if connected) before proceeding.

Correct alignment requires that the ambient temperature be the same as that of the radio and test equipment, and that this temperature be held constant between 20° C and 30° C (68° F ~ 86° F). When the radio is brought into the shop from hot or cold air, it should be allowed time to come to room temperature before alignment.

Alignment

Whenever possible, alignments should be made with oscillator shields and circuit boards firmly affixed in place. Also, the test equipment must be thoroughly warmed up before beginning.

Note: Signal levels in dB referred to in the alignment procedure are based on $0\text{dB}\mu = 0.5\mu\text{V}$.

Set up the test equipment as shown below, and apply 13.8V DC power to the transceiver.

The VX-1700 must be programmed for use in the intended system before alignment is attempted. The frequency and other parameters are loaded from the file during the alignment process.

In order to facilitate alignment over the complete operating range of the equipment, it is recommended that the channel data first be uploaded and then stored to disk. Alignment Channel data should then be downloaded. The original data can be replaced at the end of the alignment process.

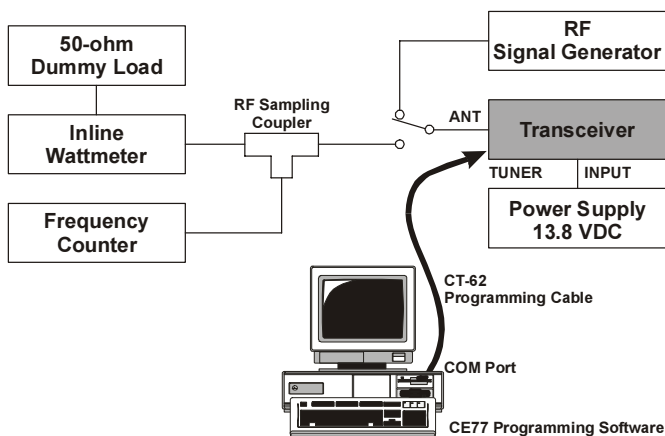

Reference & Local Alignment

PLL REFERENCE FREQUENCY ALIGNMENT

- Connect the Frequency Counter to pin 4 of Q1062 on the MAIN Unit.
- Adjust X1003 on the MAIN Unit for 22.625 MHz ± 10 Hz on the frequency Counter.

2ND LOCAL OUTPUT LEVEL

- Connect the RF millivoltmeter to TP1043 on the MAIN Unit.
- Adjust T1013 on the MAIN Unit for 160 mVrms (± 50 mVrms) on the RF millivoltmeter.

PLL Alignment

VCO VCV ALIGNMENT

Connect the DC voltmeter to TP1048 on the MAIN Unit, and referring to the Table below, switch the transceiver to each channel listed. Then adjust the listed component for the required voltage or confirm that the correct voltage is present.

Tune to	Adjust or Confirm	For
13.499 MHz	Adjust T1066	5.2 V \pm 0.1 V
0.100 MHz	Confirm	More than 0.6 V
29.999 MHz	Adjust T1067	5.3 V \pm 0.1 V
13.5000 MHz	Confirm	More than 0.5 V

PLL OUTPUT LEVEL

- Connect the RF millivoltmeter to TP1039 on the MAIN Unit, then tune the radio to 7.500 MHz.
- Confirm that the output level is more than 10 dBm.

Transmitter Alignment

TX IF COILS ALIGNMENT

- ❑ Connect the 50 Ohm Dummy Load to the ANT jack.
- ❑ Remove the coaxial plug from J1002 on the MAIN Unit, then connect the RF millivoltmeter and 50 Ohm resistor to J1002.
- ❑ Connect the AF Generator to pin 4 of the MIC jack.
- ❑ Tune the radio to 7.500 MHz, USB mode.
- ❑ Inject a 0.5 mVrms @1000 Hz audio signal from the AF Generator.
- ❑ Key the transmitter (connect pin 3 of the MIC jack to GND), then adjust T1008, T1009, T1010, and T1011 on the MAIN Unit in succession several times for maximum indication on the RF millivoltmeter while transmitting.

Receiver Alignment

RX IF COILS ALIGNMENT

- ❑ Connect the RF Signal Generator to the ANT jack, and connect the AF millivoltmeter to the EXT SP jack.
- ❑ Tune the radio to 19.900 MHz, CW mode.
- ❑ Inject a 19.900 MHz signal from the RF Signal Generator, then adjust the RF Signal Generator output level to 0 dB.
- ❑ Adjust T1012 on the MAIN Unit for maximum indication on the AF millivoltmeter.

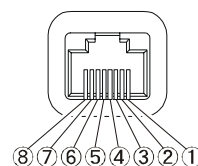

MIC JACK PINOUT

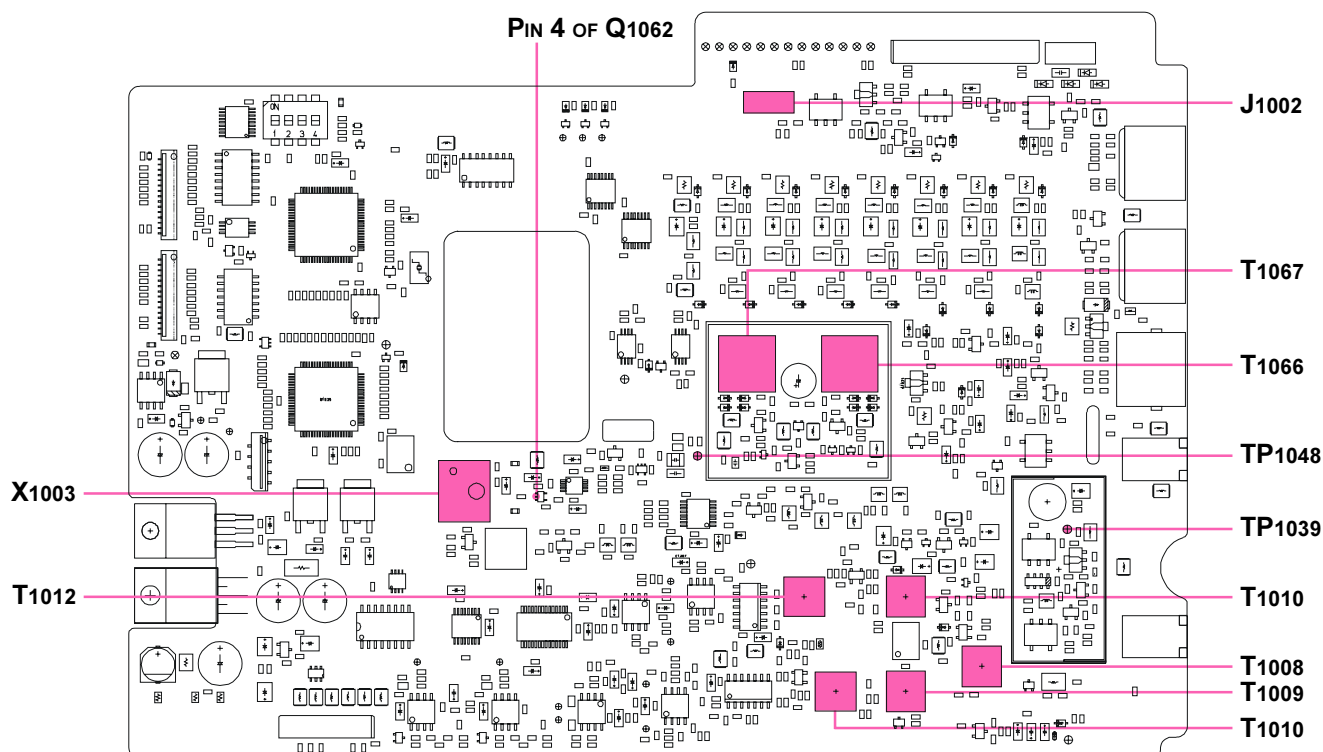

MAIN UNIT ALIGNMENT POINTS

Alignment

PA Unit Alignment

PRE-DRIVER SECTION IDLING CURRENT ALIGNMENT

- ❑ Connect the 50 Ohm Dummy Load to the ANT jack.
- ❑ Remove the shorting-plug from J2003 on the PA Unit, then connect the DC Ammeter to J2003 (pin 1: “-” lead, pin 2: “+” lead).
- ❑ Set VR2001 on the PA Unit fully counter-clockwise.
- ❑ Tune the radio to 7.500 MHz, USB mode.
- ❑ Key the transmitter (connect pin 3 of the MIC jack to GND) with no microphone input, and adjust VR2001 for 300 mA (± 30 mA) on the DC Ammeter.
- ❑ Disconnect the DC Ammeter, and replace the shorting-plug into J2003.

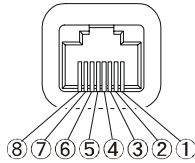

MIC JACK PINOUT

DRIVER SECTION IDLING CURRENT ALIGNMENT

- ❑ Connect the 50 Ohm Dummy Load to the ANT jack.
- ❑ Remove the shorting-plug from J2004 on the PA Unit, then connect the DC Ammeter to J2004 (pin 1: “-” lead, pin 2: “+” lead).
- ❑ Set VR2002 on the PA Unit fully counter-clockwise.
- ❑ Tune the radio to 7.500 MHz, USB mode.
- ❑ Key the transmitter (connect pin 3 of the MIC jack to GND) with no microphone input, and adjust VR2002 for 300 mA (± 30 mA) on the DC Ammeter.
- ❑ Disconnect the DC Ammeter, and replace the shorting-plug into J2004.

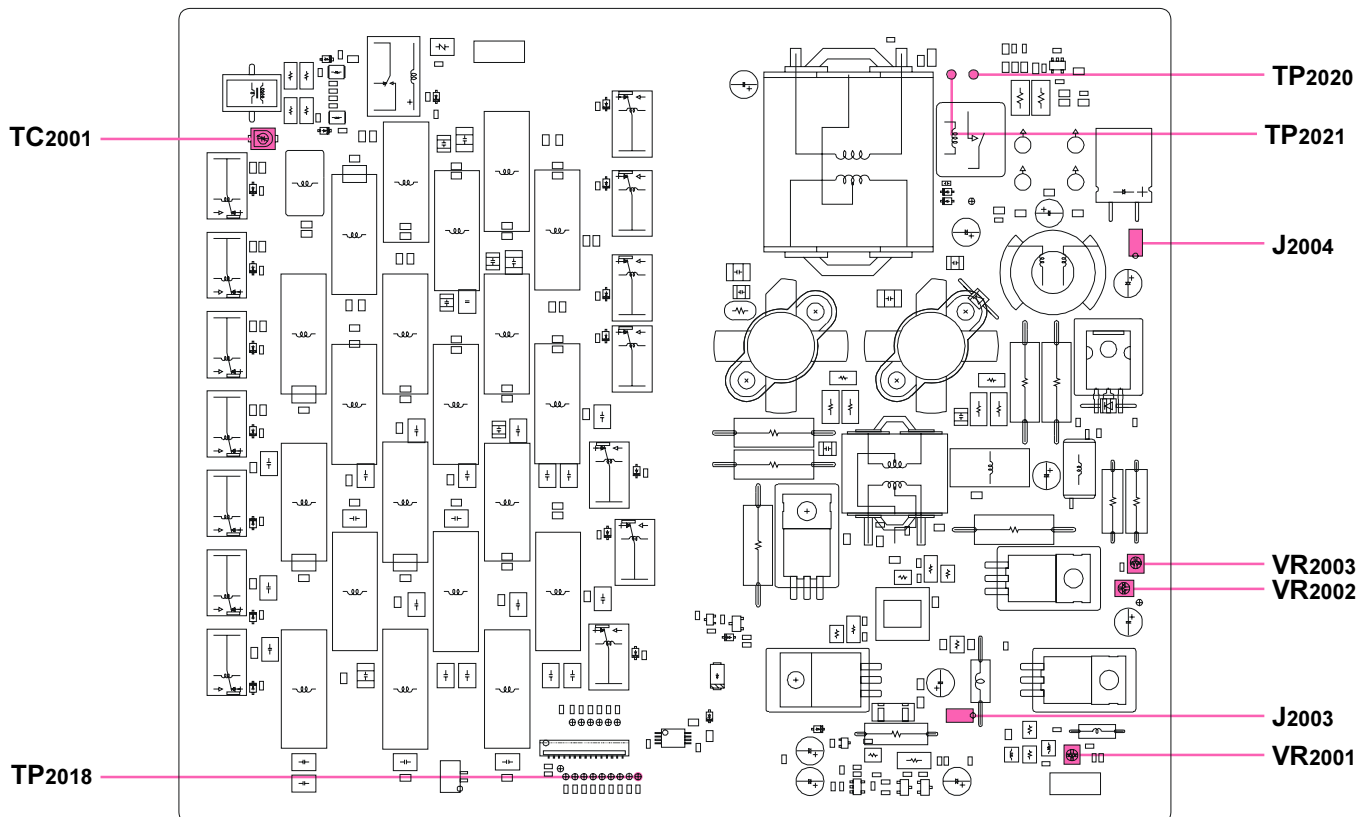

PA UNIT ALIGNMENT POINTS

FINAL SECTION IDLING CURRENT ALIGNMENT

- ❑ Connect the 50 Ohm Dummy Load to the ANT jack.
- ❑ Remove the solder jumper which is connected between TP2020 and TP2021 on the PA Unit, then connect the “+” lead of the DC Ammeter to TP2020 and the “-” lead to TP2021.
- ❑ Set VR2003 on the PA Unit fully counter-clockwise.
- ❑ Tune the radio to 7.500 MHz, USB mode.
- ❑ Key the transmitter (connect pin 3 of the MIC jack to GND) with no microphone input, and adjust VR2003 for 300 mA (± 30 mA) on the DC Ammeter.
- ❑ Disconnect the DC Ammeter, and re-connect the solder jumper between TP2020 and TP2021.

CM COUPLER BALANCE

- ❑ Connect the 50 Ohm Dummy Load and Inline Wattmeter to the ANT jack, and connect the CW keyer to the KEY jack.
- ❑ Connect the DC voltmeter to TP2018 (“+” lead, “-” lead: GND) on the PA Unit.
- ❑ Tune the radio to 29.000 MHz, A1A mode.
- ❑ Key the transmitter (close the CW key).
- ❑ Now adjust TC2001 on the PA Unit for minimum indication on the DC voltmeter.

Alignment

Software Menu Alignment

The ANT jack should be connected to a Dummy Load (in the case of transmission) or RF Signal Generator (in the case of reception). General alignment conditions are as follows, unless otherwise noted.

VOL Knob: Center (12 o'clock position).

SQL Knob: Fully counter-clockwise.

TX Output Power: HIGH

VOX:Off

The channel data in the radio is preset per the chart below.

Channel	Frequency
1-001	1.7000 MHz
1-002	3.5000 MHz
1-003	5.5000 MHz
1-004	7.5000 MHz
1-005	12.0000 MHz
1-006	19.8000 MHz
1-007	29.0000 MHz

Press and hold in the keypad's [**1(MODE)**], [**4(STEP)**], [**7(V/M)**], and [**F**] keys simultaneously, and turn on the radio while holding them in; the alignment menu will then be activated.

In the alignment procedures, each alignment parameter is selected by pressing the [**▼**]/[**▲**] key. Each alignment item is selected by rotating the CH Knob. To *store* the alignment parameters when you are satisfied with the adjustment, press the [**F**] key for *longer* than a half second.

Note that a few alignment parameters are not adjustable, and are to be left as set at the factory.

TX OUTPUT POWER ALIGNMENT

- ❑ Connect the 50 Ohm Dummy Load and Inline Wattmeter to the ANT jack.
- ❑ Referring to the Table below, press the [**▼**]/[**▲**] key to recall each parameter listed, then key the transmitter (connect pin 3 of the MIC jack to GND) and rotate the **CH** knob for the required output.

Parameter	Output Power	Parameter	Output Power
1PO-VH	125 W (± 5 W)	5PO-H	100 W (± 5 W)
1PO-H	100 W (± 5 W)	5PO-MH	50 W (± 5 W)
1PO-MH	50 W (± 5 W)	5PO-ML	25 W (± 1 W)
1PO-ML	25 W (± 1 W)	5PO-L	10 W (± 1 W)
1PO-L	10 W (± 1 W)	6PO-H	100 W (± 5 W)
2PO-VH	125 W (± 5 W)	6PO-MH	50 W (± 5 W)
2PO-H	100 W (± 5 W)	6PO-ML	25 W (± 1 W)
2PO-MH	50 W (± 5 W)	6PO-L	10 W (± 1 W)
2PO-ML	25 W (± 1 W)	7PO-H	100 W (± 5 W)
2PO-L	10 W (± 1 W)	7PO-MH	50 W (± 5 W)
3PO-H	100 W (± 5 W)	7PO-ML	25 W (± 1 W)
3PO-MH	50 W (± 5 W)	7PO-L	10 W (± 1 W)
3PO-ML	25 W (± 1 W)		
3PO-L	10 W (± 1 W)		
4PO-H	100 W (± 5 W)		
4PO-MH	50 W (± 5 W)		
4PO-ML	25 W (± 1 W)		
4PO-L	10 W (± 1 W)		

TX GAIN ALIGNMENT

- ❑ Connect the 50 Ohm Dummy Load and Inline Wattmeter to the ANT jack.
- ❑ Connect the AF Generator to pin 4 of the MIC jack, and adjust the AF Generator output level to 0.5 mV @1 kHz.
- ❑ Referring to the Table below, press the [▼]/[▲] key to recall each parameter listed, then key the transmitter (connect pin 3 of the MIC jack to GND) and rotate the **CH** knob for the required output.

Parameter	Output Power	Parameter	Output Power
1TX-G-H	50 W (± 10 W)	1TX-G-L	5 W (± 1 W)
2TX-G-H	63 W (± 10 W)	2TX-G-L	5 W (± 1 W)
3TX-G-H	50 W (± 10 W)	3TX-G-L	5 W (± 1 W)
4TX-G-H	50 W (± 10 W)	4TX-G-L	5 W (± 1 W)
5TX-G-H	50 W (± 10 W)	5TX-G-L	5 W (± 1 W)
6TX-G-H	50 W (± 10 W)	6TX-G-L	5 W (± 1 W)
7TX-G-H	50 W (± 10 W)	7TX-G-L	5 W (± 1 W)

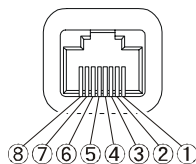

MIC JACK PINOUT

REV ALC ALIGNMENT

- ❑ Connect the 150 Ohm Dummy Load (or three 50 Ohm Dummy Loads in parallel) to the ANT jack.
- ❑ Referring to the Table below, press the [▼]/[▲] key to recall each parameter listed, then key the transmitter (connect pin 3 of the MIC jack to GND) and rotate the **CH** knob just to the point when the S-meter reading is changed from S-7 to S-8.

Parameter	S-meter reading
1R-ALC	S-7 to S-8 threshold.
2R-ALC	S-7 to S-8 threshold.
3R-ALC	S-7 to S-8 threshold.

SWR ALIGNMENT

- ❑ Connect the 150 Ohm Dummy Load (or three 50 Ohm Dummy Loads in parallel) to the ANT jack.
- ❑ Press the [▼]/[▲] key to recall the parameter "1_SWR3."
- ❑ Key the transmitter (connect pin 3 of the MIC jack to GND), then press the [ENT] key.
- ❑ Press the [▲] key momentarily to recall the parameter "2_SWR3."
- ❑ Key the transmitter (connect pin 3 of the MIC jack to GND), then press the [ENT] key.
- ❑ Press the [▲] key momentarily to recall the parameter "3_SWR3."
- ❑ Key the transmitter (connect pin 3 of the MIC jack to GND), then press the [ENT] key.

This completes the internal alignment routine.

To save all settings and exit, press and hold in the [ENT] key for at least one second.

To exit without saving, press the **POWER** key.

Alignment

Note

ALE-1 Automatic Link Establishment Unit Installation

Installation

- ❑ Make sure that the transceiver is off. Remove the DC Power Cable, Microphone, and Antenna from the transceiver.
- ❑ Referring to Figure 1, remove the four screws from the side of the transceiver (two screws for each side), along with four screws affixing the bottom case; remove the bottom case.
- ❑ Referring to Figure 2, disconnect the 13-pin connector from J4001 on the GPS-INTERFACE Unit, remove the two HEX bolts which and four screws affixing the GPS-INTERFACE Unit.
- ❑ Remove the GPS-INTERFACE Unit from the transceiver.
- ❑ Install the ALE-1 Unit to the place where it has the GPS-INTERFACE Unit.
- ❑ Fix the ALE-1 Unit with two HEX bolts and four screws.
- ❑ Connect the 13-pin connector to J4001 on the ALE-1 Unit.
- ❑ Replace the bottom case with its eight screws.
- ❑ Connect the DC Power Cable, Microphone, and Antenna to the transceiver.

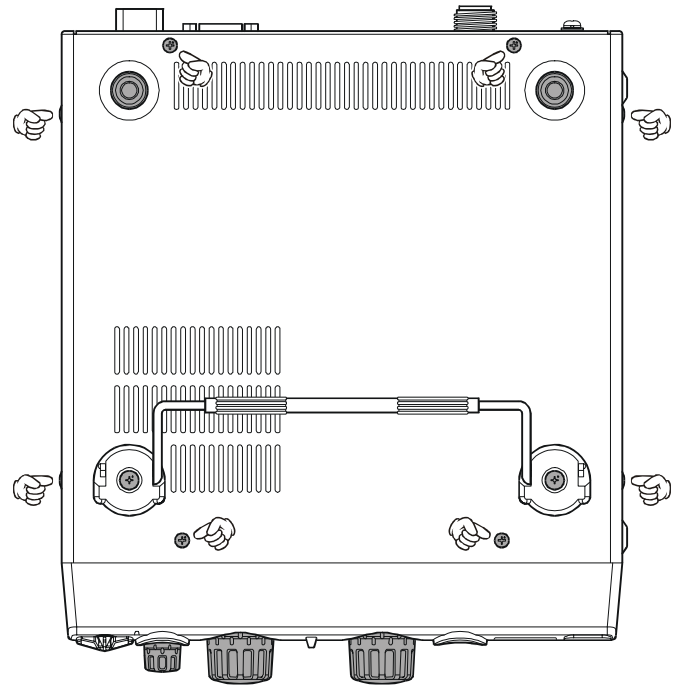

FIGURE 1

Programming

- ❑ Connect the CT-62 Programming Cable between computer's 9-pin COM port and the transceiver's TUNER jack.
- ❑ Press and hold in the [F] and [9(M/W)] keys while turning the power on to enter the clone mode.
- ❑ Execute the CE77 Programming Soft, then upload the current programming data from the transceiver via the "Upload" menu in the "Radio" parameter.
- ❑ Click the left mouse button on the "Common" parameter, then click the left mouse button on the "Option" parameter to involve a pop-up window, select the "Option Board" item, and change its setting to "ALE Unit."
- ❑ Click the left mouse button on the [OK] button to close the pop-up window.
- ❑ Program the ALE features.
- ❑ Download the revised programming data to the transceiver from the computer via the "Download" menu in the "Radio" parameter.
- ❑ Installation and programming are now complete.
- ❑ Disconnect the CT-62 Programming Cable from the transceiver's TUNER jack.

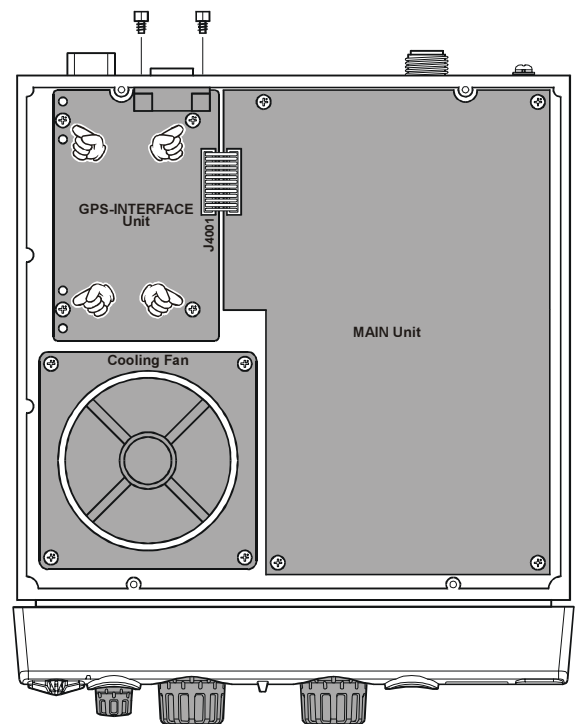

FIGURE 2

ALE-1 Automatic Link Establishment Unit Installation

Note

CE77 PC Programming Software

The CE77 PC Programming Software is used to program the VX-1700 HF Communications Transceiver. With the CE77 PC Programming Software, you can quickly and easily program the Vertex Standard VX-1700 operating channels and configuration from your personal computer. In the event of an accidental memory failure, channel memory and configuration data may be re-loaded in a matter of minutes.

Main Programming Screen (VFO Screen)

VFO/MEMORY

This parameter switches the Main Programming Screen between the "VFO Screen" and the "Memory Channel Screen."

STEP

This column selects the VFO step size. To select the step size, double click the left mouse button on this column to select the desired step size from among "10 Hz," "100 Hz," and "1 kHz."

RECEIVE FREQUENCY

This field sets the Default Receive Frequency of the VFO.

To enter the Receive Frequency, double click the left mouse button on this column, then enter the desired Receive Frequency from the keyboard, then press the [ENTER] key to lock in the new frequency.

The available values are "0.0300 (MHz)" to "30.0000 (MHz)."

TRANSMIT FREQUENCY

This field sets the Default Transmit frequency of the VFO.

When you enter a Receive frequency, the Transmit frequency will automatically be set to the same frequency.

To change the transmit frequency (only), double click the left mouse button on this column, enter the desired Transmit Frequency from the keyboard, then press the [ENTER] key to lock in the new frequency.

The available data entry values are "0.0300 (MHz)" to "30.0000 (MHz)."

However, the range over which transmission may actually occur is from "1.6000 (MHz)" to "30.0000 (MHz)."

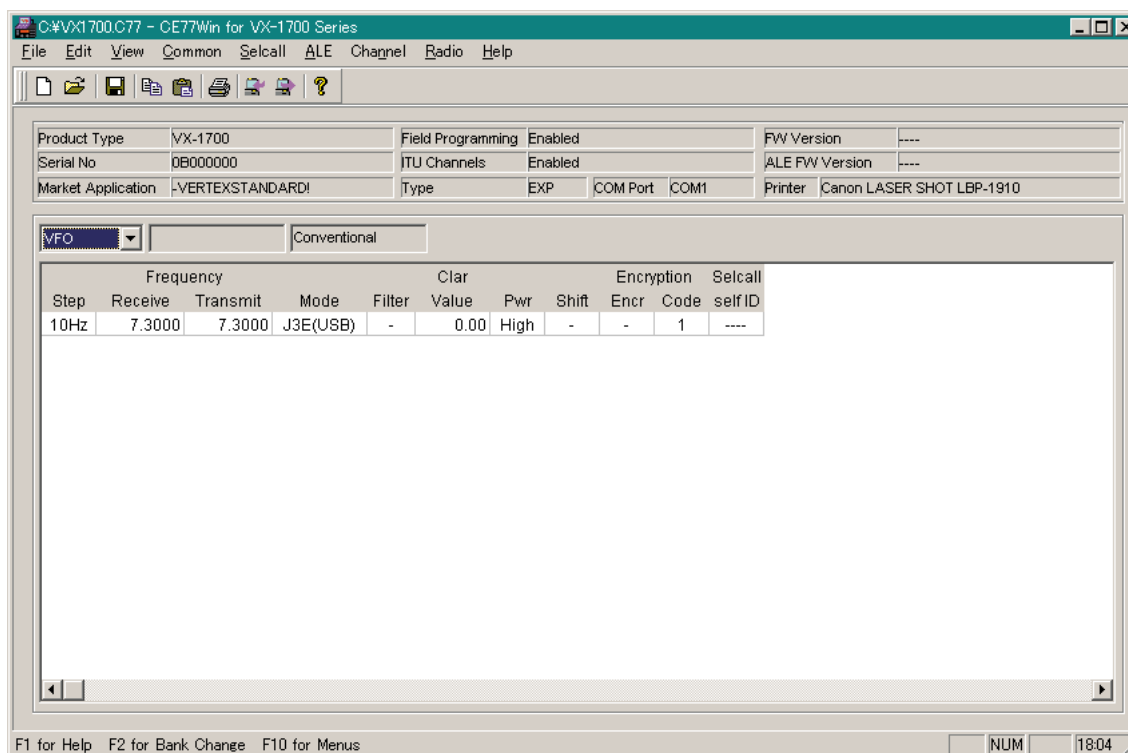

MAIN PROGRAMMING SCREEN (VFO SCREEN)

CE77 PC Programming Software

MODE

This column selects the Operating Mode.

To select the Operating Mode, double click the left mouse button on this column to invoke a pop-up window, select the desired Operating Mode, then click the [OK] button to accept the new Operating Mode.

The available selections are "J3E (USB)," "J3E (LSB)," "J2B," "A1A," and "A3E."

FILTER

This column selects the bandwidth of the IF filter.

To select the bandwidth, double click the left mouse button on this column to toggle the desired bandwidth between "Wide (W): 2.2 kHz." and "Narrow (N): 600 Hz."

This column does not function when the "VFO MODE" parameter has been set to "J3E" or "A3E."

CLAR VALUE

This column allows entry of the Clarifier Offset Frequency.

To enter the Offset Frequency, double click the left mouse button on this column, enter the desired Offset Frequency from the keyboard, then press the [ENTER] key to accept the new frequency.

If an incorrect entry is made, the software will round off the entry to the nearest valid frequency automatically. Available values are "-1.00" to "+1.00" (kHz).

PWR

This column selects the Transmit Output Power.

To select the TX power, double click the left mouse button on this column, then select the desired TX power from among "Low," "Mid," and "High."

SHIFT

This column may be used to move a spurious response "Birdie" from the CPU clock away from the operating frequency, should it cause interference.

To program this column, double click the left mouse button on this column, then select the desired shift value from among "1," "2," "3," and "Off (-)."

ENCRYPTION ENCR

This column turns the Voice Encryption feature "on (v)" or "off (-)."

To select this feature, double click the left mouse button on this column, then set the Voice Encryption feature "on (v)" or "off (-)."

This column will not function in the software when the Encryption Unit has been activated (determined from the "Encryption Unit" parameter on the "Option" tab in the "Common" Menu), or if the optional Encryption Unit is not installed.

ENCRYPTION CODE

This column selects the desired Encryption code.

To program this column, double click the left mouse button on this column to invoke a pop-up window, select the desired Encryption code, then click the [OK] button to lock in the new Encryption code.

SELCALL SELF ID

This column programs the 4-digit ID for your transceiver, utilized when using the SELCALL feature.

To enter the 4-digit ID, double click the left mouse button on this column, enter the desired 4-digit ID code (numeric only) from the keyboard, then press the [ENTER] key to accept the new ID code.

Main Programming Screen (Memory Screen)

CHN (CHANNEL)

This number is used to identify the memory channel.

They do not have to occur in order, and you can duplicate numbers from other groups (do not duplicate within a group). For example, each group may have a channel 1, but a particular group may not have two channel 4s.

Double click the left mouse button to toggle lock the channel lock between "Enable" and "Disable." The Channel lines displayed in Thin Black are unlocked and enabled, channel lines displayed in Gray are locked and disabled.

PRI

This column set the Priority Channel.

Double click the left mouse button on this column to toggle this selection "On (P)" or "Off (-)."

When this column is set to "On (P)," the current channel will be designated as the Priority Channel.

TAG

This column is used for entry of the six character Alpha/Numeric "Tag" used to identify the channel. To enter the Alpha/Numeric "Tag," double click the left mouse button on this column, type the characters of the desired Alpha/Numeric Tag (up to 6 characters), then press the [ENTER] key to save the programmed "Tag."

TAG TYPE

This column selects the display indication of the channel.

To select the display indication, double click the left mouse button on this column to select the desired display indication from among "Freq," "TAG," and "ALT."

Freq: Indicates the memory channel by showing the actual channel frequency

TAG: Indicates the memory channel by showing the channel's Alpha/numeric Tag

ALT: Indicates the memory channel by showing the channel frequency and the channel's Alpha/numeric Tag alternately.

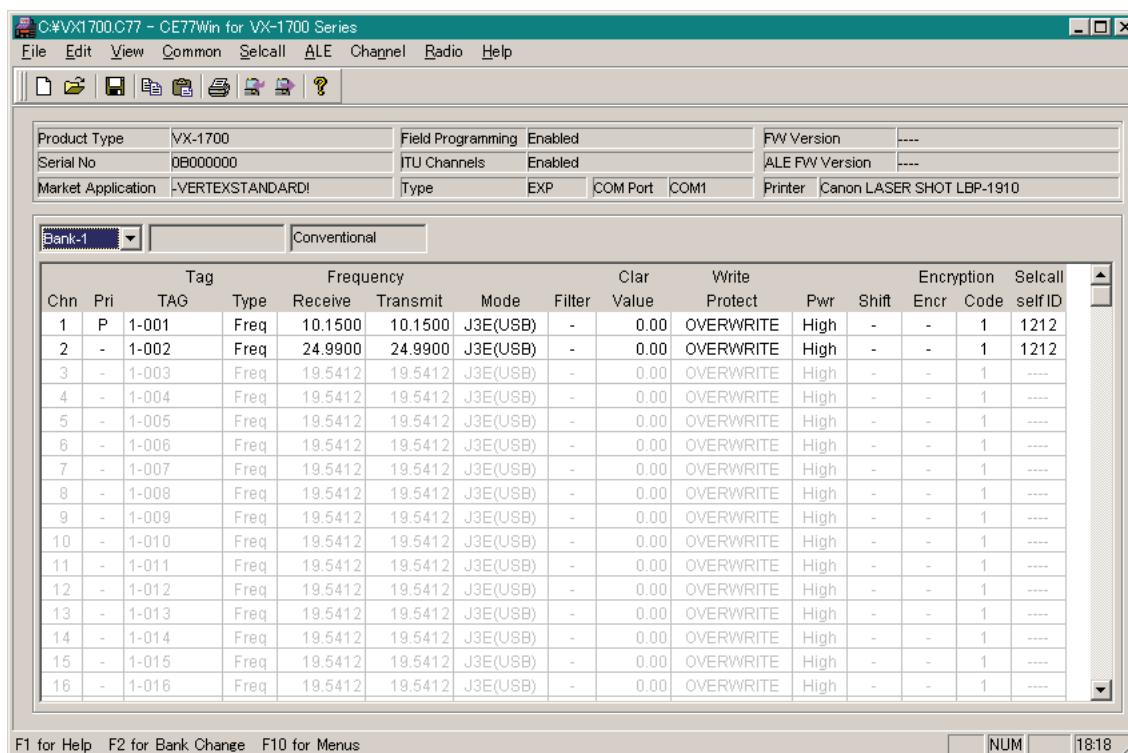

MAIN PROGRAMMING SCREEN (MEMORY SCREEN)

CE77 PC Programming Software

RECEIVE FREQUENCY

This column is used for entry of the Receive Frequency.

To enter the Receive Frequency, double click the left mouse button on this column, enter the desired Receive Frequency from the keyboard, then press the [ENTER] key to lock in the new frequency.

The available values are "0.0300 (MHz)" to "30.0000 (MHz)."

TRANSMIT FREQUENCY

This column is used for entry of the Transmit frequency.

When you enter a Receive frequency, the Transmit frequency will automatically be set to the same frequency.

To change the transmit frequency (only), double click the left mouse button on this column, enter desired Transmit Frequency from the keyboard, then press the [ENTER] key to accept the new frequency.

The available data entry values are "0.0300 (MHz)" to "30.0000 (MHz)."

However, the range over which transmission may actually occur is from "1.6000 (MHz)" to "30.0000 (MHz)."

MODE

This column selects the Operating Mode.

To select the Operating Mode, double click the left mouse button on this column to invoke a pop-up window, select the desired Operating Mode, then click the [OK] button to accept the new Operating Mode. The available selections are "J3E (USB)," "J3E (LSB)," "J2B," "A1A," and "A3E."

FILTER

This column selects the bandwidth of the IF filter.

To select the bandwidth, double click the left mouse button on this column to toggle the desired bandwidth between "Wide (W): 2.2 kHz" and "Narrow (N): 600 Hz."

This column does not function when the "OPERATING MODE" parameter has been set to "J3E" or "A3E."

CLAR VALUE

This column allows entry of a Clarifier Offset Frequency, if desired.

To enter the Offset Frequency, double click the left mouse button on this column, enter the desired Off-

set Frequency from the keyboard, then press the [ENTER] key to accept the new frequency.

If an incorrect entry is made, the entry will be rounded off to the nearest valid frequency automatically. Available values are "-1.00" to "+1.00" (kHz).

WRITE PROTECT

This column defines whether the Filed Programming feature will be "Enabled (OVERWRITE)" or "Disabled (PROTECT)."

PWR

This column selects the Transmit Output Power.

To select the TX power, double click the left mouse button on this column to select the desired TX power from among "Low," "Mid," and "High."

SHIFT

This column may be used to move a spurious response "Birdie" from the CPU clock away from the operating frequency, should it cause interference.

To program this column, double click the left mouse button on this column, then select the desired shift value from among "1," "2," "3," and "Off (-)."

ENCRYPTION ENCR

This column turns the Voice Encryption feature "on (v)" or "off (-)."

To select this feature, double click the left mouse button on this column, then set the Voice Encryption feature "on (v)" or "off (-)."

This column will not function in the software when the Encryption Unit has been activated using the "Encryption Unit" parameter on the "Option" tab in the "Common" Menu, or if the optional Encryption Unit is not installed.

ENCRYPTION CODE

This column selects the desired Encryption code.

To program this column, double click the left mouse button on this column to invoke a pop-up window, select the desired Encryption code, then click the [OK] button to lock in the new Encryption code.

SELCALL SELF ID

This column programs the 4-digit ID for your transceiver, utilized when using the SELCALL feature.

To enter the 4-digit ID, double click the left mouse button on this column, enter the desired 4-digit ID code (numeric only) from the keyboard, then press the [ENTER] key to accept the new ID code.

File Menu

NEW

Opens a new file.

Click the left mouse button on the “New” parameter in the File menu; this will open the default configuration of the CE77 software.

Shortcuts

Toolbar: 

Keys: CTRL+N

OPEN

Opens a previously-saved configuration from the disk.

Click the left mouse button on the “Open” parameter in the File menu; a pop-up window will appear which shows you all the current files saved in the specified path. The current folder that is saved the current file is in the top box, and the name of the current file is in the bottom box.

Double click the left mouse button on the desired file to open its file.

Shortcuts

Toolbar: 

Keys: CTRL+O

SAVE

Saves the programming session to the disk with the same name and directory.

Click the left mouse button on the “Save” parameter in the File menu to save the current file.

Shortcuts

Toolbar: 

Keys: CTRL+S

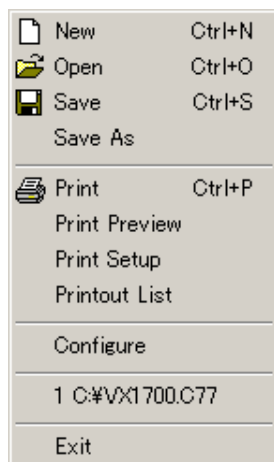

FILE MENU

SAVE AS

Save the programming session to the disk *with the new name*.

Click the left mouse button on the “Save As” parameter in the File menu, a pop-up window appears which shows you all the current files saved to the specified path.

To save the programming session with the new name, type a file name in the bottom box, then click the left mouse button on the [SAVE] box.

PRINT

Prints a configuration to hard copy.

Click the left mouse button on the “Print” parameter in the File menu; the “Printer” window will open to enable printing.

Shortcuts

Toolbar: 

Keys: CTRL+P

PRINT PREVIEW

Previews a print configuration for subsequent printing of a hard copy.

Click the left mouse button on the “Print Preview” parameter in the File menu; the “Printer” window will appear.

PRINT SETUP

Sets the configuration of the printer.

Click the left mouse button on the “Print Setup” parameter in the File menu; the “Printer” window will open to enable setting of the configuration of the printer.

PRINTOUT LIST

Selects the printout list for printing of a hard copy. Click the left mouse button on the “Printout” parameter in the File menu, the “Printout List” window open to enable selecting the printout list to be printed.

CONFIGURE

Selects the communication port which is connected to the CT-62 PC Programming Cable (which is connected to the radio).

EXIT

Quits the program and closes the window.

If the present configuration has not been saved to disk, you will be asked to confirm whether you wish to save it.

CE77 PC Programming Software

Edit Menu

COPY

Use this command to copy selected data onto the clipboard. This command is unavailable if there is no data currently selected.

Copying data to the clipboard replaces the contents previously stored there.

Shortcuts

Toolbar: 

Keys: CTRL+C

PASTE

Use this command to insert a copy of the clipboard contents at the insertion point. This command is unavailable if the clipboard is empty.

Shortcuts

Toolbar: 

Keys: CTRL+V

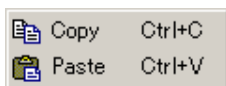

EDIT MENU

View Menu

TOOL BAR

The toolbar is displayed across the top of the application window, below the menu bar. The toolbar provides quick mouse access to many tools used in CE77.

To hide or display the Toolbar, click the left mouse button on the "Toolbar" parameter in the "View" menu.

STATUS BAR

The Status Bar is displayed at the bottom of the CE77 window.

The left area of the Status Bar describes actions of menu items as you use the arrow keys to navigate through menus.

This area similarly shows messages that describe the actions of Toolbar buttons as you depress them, before releasing them.

If after viewing the description of the Toolbar button command you wish not to execute the command, then release the mouse button while the pointer is off the Toolbar button.

To display or hide the Status Bar, click the left mouse button on the "Status Bar" parameter in the "View" menu.

The right areas of the Status Bar indicate which of the following keys are latched down:

Indicator Description

CAP The "Caps Lock" key is latched down.

NUM The "Num Lock" key is latched down.

SCRL The "Scroll Lock" key is latched down.

ITEM

This parameter commands the channel data item to appear or disappear on the main screen.

Put a check mark on the item to display it on the main screen.

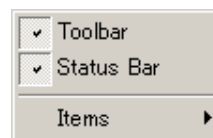

VIEW MENU

Common Menu

A1A (CW) FUNCTION PARAMETERS

This parameter programs the various configuration items of the A1A (CW) mode.

Put a check mark into the check box to enable adjustment of its parameter from the transceiver's set ("menu") mode.

The available parameters are: CW Delay, CW QSK, Side Tone SET, and Side Tone Level.

CW DELAY

This parameter sets the CW delay time.

To program the delay time, double click the left mouse button on this column, then enter the desired delay time from the keyboard, then press the [ENTER] key to accept the new delay time.

The available values are "30mSec" to "3000mSec," (10 mSec multiples) and "FULL."

To enter the "FULL" option, double click the left mouse button on this column, enter "0" from the keyboard, then press the [ENTER] key to accept the new delay time.

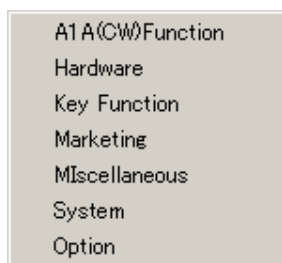

COMMON MENU

CW QSK

This parameter sets the delay time between the instant when the telegraph key is closed (key down) and the moment the actual carrier envelope is transmitted.

The available values are "10mSec" to "30mSec" (5 mSec multiples).

SIDE TONE SET

This parameter defines whether the CW side tone level is linked to the front panel's VOL knob ("LINK"), or not linked ("FIX").

SIDE TONE LEVEL

This parameter sets the CW side-tone (monitor) level.

To program the CW side-tone level, double click the left mouse button on this column, enter desired side-tone volume level from the keyboard, then press the [ENTER] key to accept the CW side tone level.

When the "SIDE TONE SET" parameter is set to "FIX," the available selections are "0" to "100."

When the "SIDE TONE SET" parameter is set to "LINK," the available selections are "-100" to "100."

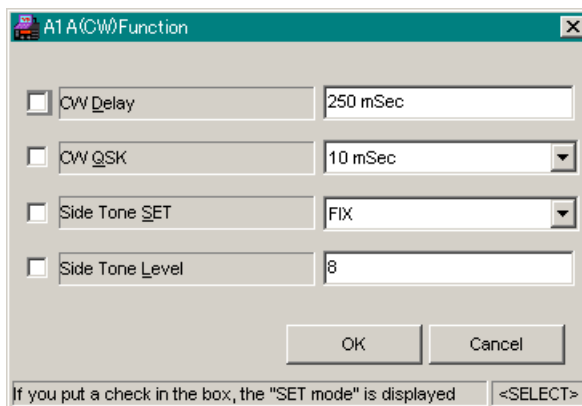

"A1A (CW) FUNCTION" PARAMETERS

CE77 PC Programming Software

HARDWARE PARAMETERS

Put a check mark into the check box to enable adjustment of its parameter from the transceiver's set ("menu") mode.

The available parameters are: 1.6 - 4 MHz RF Power, 4 - 30 MHz RF Power, Dimmer Level-1, and Dimmer Level-2.

1.6 - 4 MHz RF POWER

This parameter programs the TX output power on the 1.6 - 4 MHz band for each power setting level.

To program the TX output power, double click the left mouse button on this column; enter desired TX output power from the keyboard, then press the [ENTER] key to accept the new TX output power.

The available values are "10 (W)" to "125 (W)" for "High" power setting on the 1.6 - 4 MHz band, and "10 (W)" to "125 (W)" for "High" power setting on the 4 - 30 MHz band, "Medium" power setting, and "Low" power setting.

4 - 30 MHz RF POWER

This parameter programs the TX output power on the 4 - 30 MHz band for each power setting level.

To program the TX output power, double click the left mouse button on this column, enter desired TX output power from the keyboard, then press the [ENTER] key to accept the new TX output power.

The available values are "10 (W)" to "100 (W)."

DIMMER LEVEL - 1

This parameter programs the Display Back-light Level and Back-light Options when "DIM" is not selected.

The available Back-light Levels are "1" to "10," and "OFF."

The available Back-light Options are "ON" (always on) and "Key On 10S" (Back-light on for ten seconds after any key stroke).

DIMMER LEVEL - 2

This parameter programs the Display Back-light Level and Back-light Options when "DIM" is selected.

The available Back-light Levels are "1" to "10," and "OFF."

The available Back-light Options are "ON" (always on) and "Key On 10S" (Back-light on for ten seconds after any key stroke).

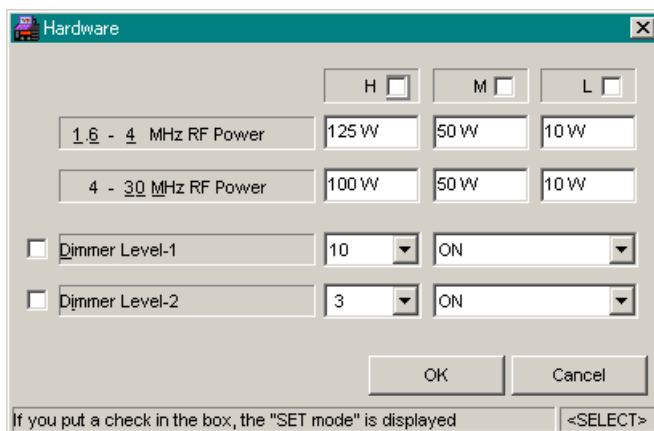

"HARDWARE" PARAMETERS

KEY FUNCTION PARAMETERS

This parameter sets the configurations for the keypad and button functions of the radio.

Put a check mark into the check box to enable adjustment of its parameter from the transceiver's set ("menu") mode.

The available parameters are: P1 SET, P2 SET, P3 SET, P4 SET, and PU/D SET.

P1 SET - P4 SET

This parameter programs the Programmable Function Button feature.

The available selections are: 1CH, 2CH, 3CH, 4CH, 1 MHz UP, 1 MHz Down, CLAR (+), CLAR (-), DW, ENCRYPTION, LOCK, PRI, SCAN, SPK OFF, RF PWR SEL, VOX, ALE, CALL, MONI, RCV MSG, SELCALL, TELCALL, AUX TOGGLE, AUX PRS TO H, AUX PRS TO L, and N/A.

PU/D SET

This parameter programs the Programmable Function Button feature which is located between the CH and VOL knobs.

The available selections are:

2182-ALARM: Pressing the left button activates the alarm generator.

Pressing the right button places the radio in the "Emergency Channel" mode.

Press *both* buttons to *transmit* the alarm tone.

UP-DWN:

Press the buttons to select the frequency control method among the "VFO mode," "ITU mode," and "Memory mode."

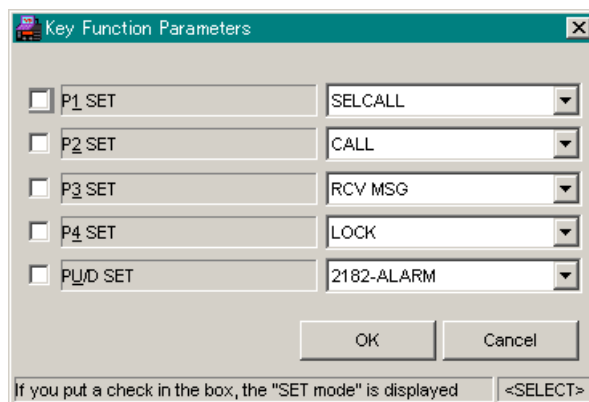

"KEY FUNCTION" PARAMETERS

Selection	Key Function
1CH	Recalls the Dealer pre-programmed channel "1" directly while operating in the Memory Channel mode.
2CH	Recalls the Dealer pre-programmed channel "2" directly while operating in the Memory Channel mode.
3CH	Recalls the Dealer pre-programmed channel "3" directly while operating in the Memory Channel mode.
4CH	Recalls the Dealer pre-programmed channel "4" directly while operating in the Memory Channel mode.
1 MHz UP	Tunes the VFO frequency upward in 1 MHz steps while operating in the VFO mode.
1 MHz Down	Tunes the VFO frequency downward in 1 MHz steps while operating in the VFO mode.
CLAR (+)	Tunes the receiver frequency upward without changing the transmit frequency (Clarifier function).
CLAR (-)	Tunes the receiver frequency downward without changing the transmit frequency (Clarifier function).
DW	Activates the Dual Watch feature.
ENCRYPTION	Toggles the Encryption feature "on" and "off."
LOCK	Toggles the Key Lockout feature "on" and "off."
PRI	Activates the Priority Scan.
SCAN	Activates Scanning.
SPK OFF	Toggles the internal speaker (or external speaker, if used) "on" and "off."
RF PWR SEL	Selects the transmit power output level ("Low," "Medium," and "High").
VOX	Toggles the VOX feature "on" and "off."
ALE	Toggles the ALE (Automatic Link Establishment) feature "on" and "off."
CALL	Transmits a Selcall (or ALE) while operating in the Selcall (or ALE) mode.
MONI	Disables the noise squelch action (to hear background noise). Press again this key to activate the noise squelch (quiet the noise).
RCV MSG	Recalls the last-received Selcall or ALE Message.
SELCALL	Toggles the SELCALL feature "on" and "off."
TELCALL	Transmits a Telcall while operating in the Selcall mode.
AUX TOGGLE	Toggles the optional accessory port "3" "on" and "off."
AUX PRS TO H	Turns the optional accessory port "2" to "High."
AUX PRS TO L	Turns the optional accessory port "1" to "Low."

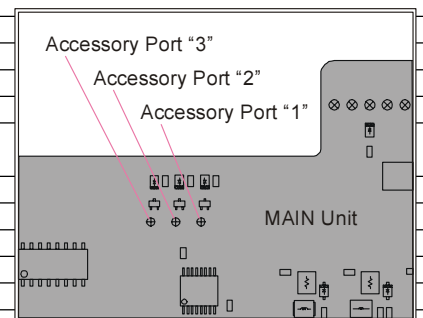

CE77 PC Programming Software

MARKETING PARAMETERS

This parameter indicates the Market Application Number and Serial Number of the radio.

The available parameters are Market Applications and Serial Number.

MARKET APPLICATIONS

This parameter indicates the Alpha/numeric "Tag" (up to 16 digits) used for identifying the owner or application of the radio.

SERIAL NUMBER

This parameter presently is not supported. It will be used in the future.

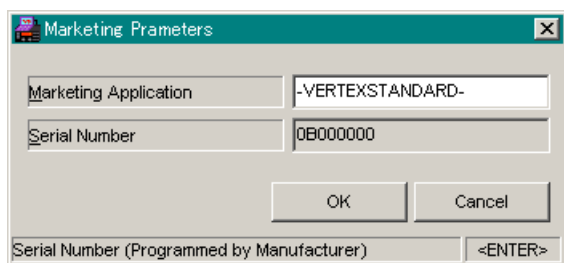

"MARKETING" PARAMETERS

MISCELLANEOUS PARAMETERS

This parameter programs the miscellaneous configuration options of the radio.

Put a check mark into the check box to enable adjustment of its parameter from the transceiver's set ("menu") mode.

The available parameters are: Alarm AF SET, Alarm Vol SET, Beep Tone, Beep AF SET, Beep VOL, Dual Watch Mode, Lock Mode, Scan Resume, Standby Beep, VOX Gain, and VOX Delay.

ALARM AF SET

This parameter defines whether the Alarm tone level is linked to the front panel's VOL knob ("LINK") or not linked ("FIX").

ALARM VOL SET

This parameter sets the Alarm level of the Emergency, Selcall, and ALE features.

To program the Alarm level, double click the left mouse button on this column, enter the desired Alarm level from the keyboard, then press the [ENTER] key to accept the programmed alarm level.

When the "ALARM AF SET" parameter is set to "FIX," the available selections are "0" to "100."

When the "ALARM AF SET" parameter is set to "LINK," the available selections are "-100" to "100."

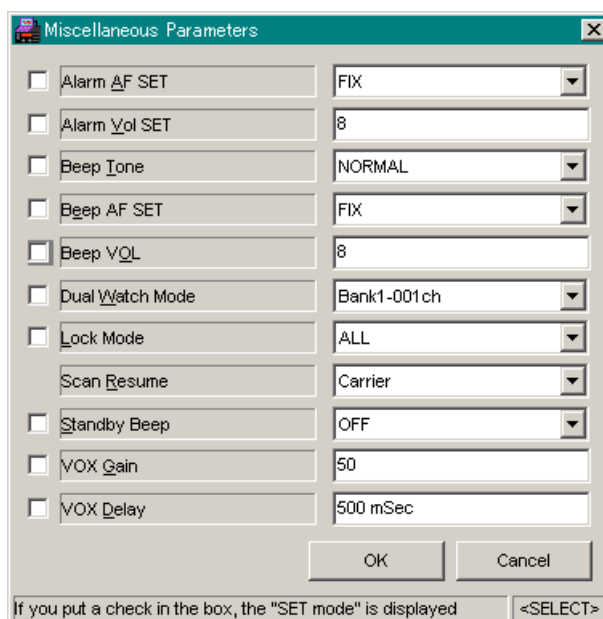

"MISCELLANEOUS" PARAMETERS

BEEP TONE

This parameter sets the Beep Tone (frequency). The available selections are "LOW," "NORMAL," and "HIGH."

BEEP AF SET

This parameter defines whether the Beep volume is linked to the front panel's VOL knob ("LINK") or not linked ("FIX").

BEEP VOL

This parameter sets the Beep volume level. To program the Beep volume level, double click the left mouse button on this column, enter desired Beep volume level from the keyboard, then press the [ENTER] key to accept the Beep volume level. When the "BEEP AF SET" parameter is set to "FIX," the available selections are "0" to "100." When the "BEEP AF SET" parameter is set to "LINK," the available selections are "-100" to "100."

DUAL WATCH MODE

This parameter defines the priority channel for the dual watch feature. The channels currently programmed into the radio will appear in the drop-down list.

LOCK MODE

This parameter selects from among the available function locking schemes. The available selections are "CH," "KEYPAD," and "ALL."

SCAN RESUME

This parameter selects the Scan Resume Mode. The available selections are "Carrier" and "Timer."

STANDBY BEEP

This parameter toggles the Standby Beep feature "ON" or "OFF." When this parameter is set to "ON," an "Alarm" beep will be heard and transmitted when the PTT switch is released.

VOX GAIN

This parameter sets the gain of the VOX circuit. To program the VOX gain, double click the left mouse button on this column, enter desired VOX gain from the keyboard, then press the [ENTER] key to accept the VOX gain. The available values are "0" to "100."

VOX DELAY

This parameter sets the VOX delay time. To program the VOX delay time, double click the left mouse button on this column, enter desired VOX delay time from the keyboard, then press the [ENTER] key to accept the VOX delay time. The available values are "100 mSec" to "3000 mSec" (100 mSec multiples).

CE77 PC Programming Software

SYSTEM PARAMETERS

This parameter programs the various system configurations of the radio.

Put a check mark into the check box to enable adjustment of its parameter from the transceiver's set ("menu") mode.

The available parameters are: APO, Clarifier Backup Type, Carrier Offset, Display Offset, J2B MODE, MIC Gain, Password Set, SP Mute Act, SP Mute Level, TOT, Tuning, VFO, VOL Limit, DEALER MODE, RETURN, CLOCK SHIFT, DW CH SEL, ENCRPT CODE, and MEMORY WRITE.

APO

This parameter determines the power-off time for the Automatic Power Off feature.

The available values are "1/2/4/6/8/10/12" hours or "off."

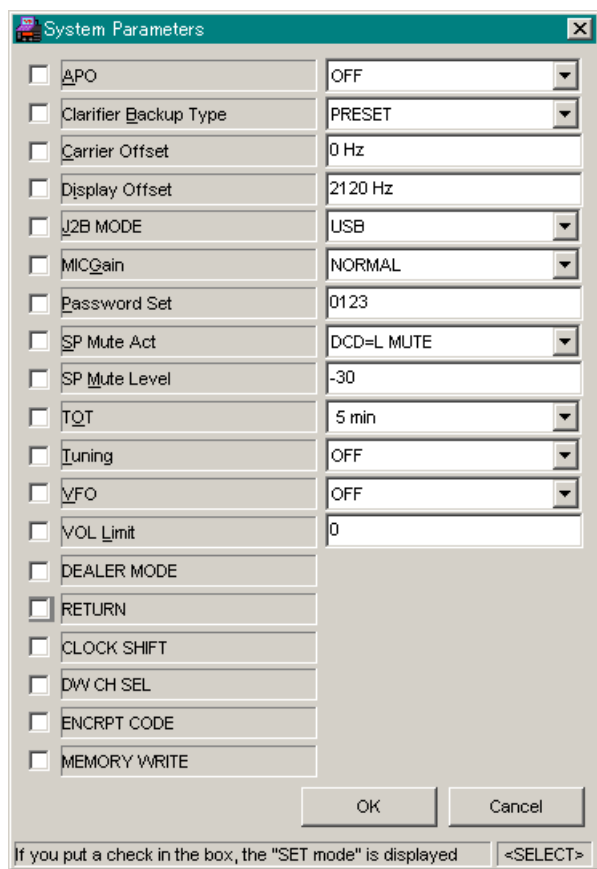

"SYSTEM" PARAMETERS

CLARIFIER BACKUP TYPE

This parameter determines the Clarifier offset frequency when the memory channel is recalled.

The available selections are "PRESET," "MOMENTARILY," and "LAST MEMORY."

PRESET: Sets the Clarifier offset frequency to the memorized offset frequency of the memory channel, and disables the Clarifier for offset frequency tuning.

MOMENTARILY: Sets the Clarifier offset frequency to the memorized offset frequency of the memory channel, and enables the Clarifier for offset frequency tuning.

LAST MEMORY: Sets the Clarifier offset frequency to the last tuned offset frequency, and enables the Clarifier for offset frequency tuning.

CARRIER OFFSET

This parameter sets the carrier point during the J2B mode.

To program the carrier point, double click the left mouse button on this column, enter desired frequency from the keyboard, then press the [ENTER] key to accept the carrier point.

The available selections are "0Hz" to "3000Hz." (10 Hz multiples)

DISPLAY OFFSET

This parameter sets the frequency display offset for the J2B mode.

To program the frequency display offset, double click the left mouse button on this column, enter desired offset from the keyboard, then press the [ENTER] key to accept the frequency display offset.

The available selections are "-3000 Hz" to "3000 Hz." (10 Hz multiples)

J2B MODE

This column selects the Operating Mode (injection sideband) for the J2B mode.

The available selections are "USB" and "LSB."

MIC GAIN

This parameter programs the Microphone Input Sensitivity.

The available values for the Microphone Gain are "LOW," "NORMAL," or "HIGH."

PASSWORD SET

This parameter programs the password for the entering to the Dealer mode of the transceiver.

To enter the password, double click the left mouse button on this column, enter the desired password (four digits; numeric only) from the keyboard, then press the [ENTER] key to accept the new password.

SP MUTE ACT

This parameter selects the Speaker Mute function. The available selections are "DCD-L MUTE" and "DCD-H MUTE."

DCD-L MUTE: Reduces the speaker audio output while the DCD terminal (pin 4 of the DATA Jack) is set to "LOW."

DCD-H MUTE: Reduces the speaker audio output while the DCD terminal (pin 4 of the DATA Jack) is set to "High."

SP MUTE LEVEL

This parameter sets the Audio mute level.

To program the Audio mute level, double click the left mouse button on this column, enter desired mute level from the keyboard, then press the [ENTER] key to accept the new mute level.

The available selections are "-100" to "0."

TOT

This parameter determines the Time-Out Timer countdown Time.

The available values are "1/2/3/5/10/15/20" minutes or "off."

TUNING

This parameter programs the Automatic Antenna Tuner function.

The available selections are:

OFF: Disables the automatic tuning function of the Automatic Antenna Tuner.

To initiate antenna tuning on a particular, with this selection set to "Off," you must press the keypad's [3(TUNER)] key on the front panel.

CH CHANGE: Activates the Automatic Antenna Tuning function when the memory channel is changed.

POWER ON: Activates the Automatic Antenna Tuning function on all channels of the current Memory Bank when the radio is turned on.

VFO

This parameter defines whether the "VFO" mode shall be "Enabled" or "Disabled" from the front panel's [V/M] key.

VOL LIMIT

This parameter determines the audio volume level when the VOL knob is fully counter-clockwise (but not into the click) position.

To program this parameter, double click the left mouse button on this column, enter the desired audio volume level (0 - 100), then press the [ENTER] key to save and exit.

DEALER MODE

This parameter defines whether the "DEALER MODE" selection shall be "Enabled" or "Disabled" from the transceiver's set ("menu") mode.

RETURN

This parameter defines whether the "RETURN" selection shall be "Enabled" or "Disabled" from the transceiver's set ("menu") mode.

CLOCK SHIFT

This parameter defines whether the "CLOCK SHIFT" selection shall be "Enabled" or "Disabled" from the transceiver's set ("menu") mode.

CE77 PC Programming Software

DW CH SEL

This parameter defines whether the “DW CH SEL” selection shall be “Enabled” or “Disabled” from the transceiver’s set (“menu”) mode.

ENCRPT CODE

This parameter defines whether the “ENCRPT CODE” selection shall be “Enabled” or “Disabled” from the User Set Mode.

MEMORY WRITE

This parameter defines whether the “MEMORY WRITE” selection shall be “Enabled” or “Disabled” from the User Set Mode.

OPTION PARAMETERS

This parameter programs the configurations of optional modules for the radio.

These include the Encryption Unit and the Option Board.

ENCRYPTION UNIT

This parameter selects whether the Encryption Unit shall be “Enabled” (ON) or “Disabled” (OFF).

OPTION BOARD

This parameter selects the Optional Unit to be used.

The available selections are “GPS Interface” and “ALE Unit.”

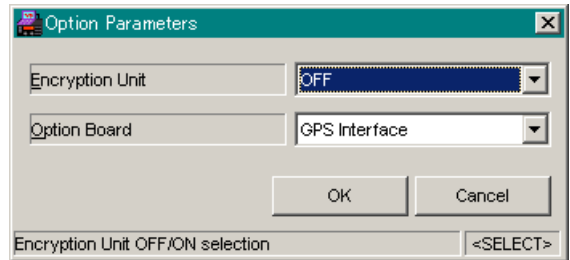

"OPTION" PARAMETERS

Selcall Menu

SELCALL PARAMETERS

This parameter programs the various Selcall configurations of the radio.

Put a check mark into the check box to enable adjustment of its parameter from the transceiver's set ("menu") mode.

Note: The Selcall is only activated on the J3E mode.

The available parameters are Selcall, Kill System, Stun System, Beacon Request, GPS Position Request, GPS Position Send, Preamble, Offset Time, Radio ID, Message, All Call, Answer Back, Group Call, Sub Group Call, Tel Call, TX ID, and Selcall Self ID.

SELCALL

This parameter determines whether the radio is able to receive or transmit a Selcall.

The available selections are "RX," "TX," "TX+RX," and "OFF."

- RX: Enables the receiving of a Selcall and disables the sending of a Selcall.
- TX: Enables the sending of a Selcall and disables the receiving of a Selcall.
- TX+RX: Enables both the receiving and sending of a Selcall.
- OFF: Disables both the receiving and sending of a Selcall.

KILL SYSTEM

This parameter determines whether the radio is able to receive a Kill System command or transmit a Kill System acknowledge command.

The available selections are "RX," "TX+RX," "POS TX+RX," and "OFF."

- RX: Enables the receiving of a Kill System command and disables the sending of a Kill System acknowledge command.
- TX+RX: Enables the receiving of a Kill System command and sending of a Kill System acknowledge command.
- POS TX+RX: Enables the receiving of a Kill System command, and the sending of a Kill System acknowledge command along with the radio's current position*.
- OFF: Disables both the receiving of a Kill System command and sending of a Kill System acknowledge command.

*: Requires the after-market GPS receiver.

Note: The KILL System is ignored while activating the ALE feature.

STUN SYSTEM

This parameter determines whether the radio is able to receive a Stun System command or transmit a Stun System acknowledge command.

The available selections are "RX," "TX+RX," "POS TX+RX," and "OFF."

- RX: Enables the receiving of a Stun System and disables the sending of a Stun System acknowledge command.
- TX+RX: Enables the receiving a Stun System command and sending of a Stun System acknowledge command.
- POS TX+RX: Enables the receiving of a Stun System command, and the sending of a Stun System acknowledge command along with the radio's current position*.
- OFF: Disables both the receiving a Stun System command and sending of a Stun System acknowledge command.

*: Requires the after-market GPS receiver.

Note: The STUN System is ignored while activating the ALE feature.

BEACON REQUEST

This parameter determines whether the radio is able to receive or transmit a Beacon request feature.

The available selections are "RX," "TX," "TX+RX," and "OFF."

- RX: Enables the receiving of a Beacon request and disables the sending of that request.
- TX: Enables the sending of a Beacon request and disables the receiving of a Beacon request.
- TX+RX: Enables both the receiving and sending of a Beacon request.
- OFF: Disables both the receiving and sending of a Beacon request.

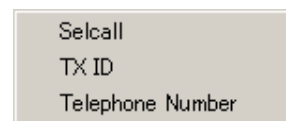

SELCALL MENU

CE77 PC Programming Software

GPS POSITION REQUEST

This parameter determines whether the radio is able to receive or transmit a GPS position request. The available selections are "RX," "TX," "TX+RX," and "OFF."

- RX: Enables the receiving of a GPS position request and disable the sending of a GPS position request.
- TX: Enables the sending of a GPS position request and disables the receiving of a GPS position request.
- TX+RX: Enables both the receiving and sending of a GPS position request.
- OFF: Disables both the receiving and sending of a GPS position request.
- ※: Requires the after-market GPS receiver for transmitting your GPS position.

GPS POSITION SEND

This parameter determines whether the radio is able to receive or transmit your GPS position. The available selections are "RX," "TX," "TX+RX," and "OFF."

- RX: Enables the receiving a GPS position send command and disables the sending of your GPS position.
- TX: Enables the sending of your GPS position and disables the receiving of a GPS position send command.
- TX+RX: Enables the receiving and sending of a GPS position.
- OFF: Disables both the receiving and sending of a GPS position.
- ※: Requires the after-market GPS receiver for transmitting your GPS position.

PREAMBLE

This parameter sets the preamble time for a Sel-call.

The radio will transmit just a carrier signal (without the data) for this "Preamble" period.

The available selections are "1 sec" to "16 sec."

OFFSET TIME

This parameter sets the offset time between the Local time and UTC time.

RADIO ID

This parameter programs the transceiver's Alpha/Numeric self-identification for the KILL and STUN systems.

To enter the Alpha/Numeric self-identification, double click the left mouse button on the desired column, type the characters of the desired Alpha/Numeric self-identification (up to 58 characters), then press the [ENTER] key to save the programmed self identification.

MESSAGE

This parameter programs the Alpha/Numeric messages for the Selcall feature.

To enter the Alpha/Numeric message, double click the left mouse button on the desired column, type in the characters of the desired Alpha/Numeric message (up to 64 characters), then press the [ENTER] key to save the programmed messages.

This parameter is also used to remote control the VX-1700 using the "KILL," "STUN," and "REVIVE" feature.

If the "CILLIK" command with the "Radio ID (example: TEST6111)" is entered in this parameter (total message is "CILLIKTEST6111"), the VX-1700 which has the "TEST6111" radio ID will be "killed" when this message is received.

Similarly, if the "ECNUTS" command with the "Radio ID (example: TEST6111)" is entered in this parameter (total message is "ECNUTSTEST6111"), the VX-1700 which has the "TEST6111" radio ID will be "stunned" (disabled, but capable of field revival) when this message is received.

To revive the stunned VX-1700, send the "SVIVER" command with the "Radio ID" (in this example, TEST6111) (total message is "SVIVERTEST6111").

Note: A "killed" VX-1700 cannot be revived by a remote control command. To revive a killed VX-1700, the channel setup cloning process must be performed again.

Kill Command: CILLIK

Stun Command: ECNUTS

Revive Command: SVIVER

ALL CALL

This parameter determines whether the "All Call" function of the Selcall feature shall be "Enabled" or "Disabled".

ANSWER BACK

This parameter determines whether the "Answer Back" function shall be "Enabled" or "Disabled" when receiving a Selcall.

GROUP CALL

This parameter determines whether the "Group Call" function of the Selcall feature shall be "Enabled" or "Disabled."

SUB GROUP CALL

This parameter determines whether the "Sub Group Call" function of the Selcall feature shall be "Enabled" or "Disabled."

TEL CALL

This parameter determines whether the radio is able to receive or transmit a Tel Call.

The available selections are "RX," "TX," "TX+RX," and "OFF."

- RX: Enables the receiving of a Tel Call and disables the sending of a Tel Call.
- TX: Enables the sending of a Tel Call and disables the receiving of a Tel Call.
- TX+RX: Enables both the receiving and sending of a Tel Call.
- OFF: Disables both the receiving and sending of a Tel Call.

TX ID

Put a check mark into the check box to enable programming of the TX ID from the transceiver's set ("menu") mode.

SELCALL SELF ID

Put a check mark into the check box to enable programming of the Selcall Self ID from the transceiver's set ("menu") mode.

Selcall

<input checked="" type="checkbox"/> Selcall	TX+RX	<input type="checkbox"/> All Call	ENABLE
<input type="checkbox"/> Kill System	OFF	<input type="checkbox"/> Answer Back	ANSWER BACK
<input type="checkbox"/> Stun System	TX+RX	<input type="checkbox"/> Group Call	ENABLE
<input type="checkbox"/> Beacon Request	TX+RX	<input type="checkbox"/> Sub Group Call	ENABLE
<input type="checkbox"/> GPS Position Request	TX+RX	<input type="checkbox"/> Tel Call	OFF
<input type="checkbox"/> GPS Position Send	TX+RX	<input type="checkbox"/> TX ID	
<input type="checkbox"/> Preamble	5 Sec	<input type="checkbox"/> Selcall Self ID	
<input type="checkbox"/> Offset Time	+ 0 : 00		
<input type="checkbox"/> Radio ID	TEST5725		
<input type="checkbox"/> Message	MSG TEST FROM NO1212		

OK Cancel

If you put a check in the box, the "SET mode" is displayed <SELECT>

CE77 PC Programming Software

TX ID PARAMETER

This parameter programs the Selcall TX ID to be called.

To program this parameter, enter the TX ID (4 digits) into the "TX ID" column, then set the desired effective channel range (i.e. 1-001, 1-050, 2-051, etc.) for the TX ID into the "FROM" and "TO" columns. Enter the Alpha/Numeric Tag (8 digits) of the TX ID into the "TAG" column, if desired.

	TX ID	TAG	Range 1		Range 2		Range 3	
			From	To	From	To	From	To
1	1954	TEST	1-001	1-200	----	----	----	----
2	----		----	----	----	----	----	----
3	----		----	----	----	----	----	----
4	----		----	----	----	----	----	----
5	----		----	----	----	----	----	----
6	----		----	----	----	----	----	----
7	----		----	----	----	----	----	----
8	----		----	----	----	----	----	----
9	----		----	----	----	----	----	----
10	----		----	----	----	----	----	----
AUX	9999	AUX	1-001	1-200	----	----	----	----

"TX ID" PARAMETERS

TELEPHONE NUMBER PARAMETERS

This parameter programs the telephone number for the Telcall feature.

To enter the telephone number, double click the left mouse button on the desired column, type in the telephone number (up to 16 digits), then press the [ENTER] key to save the programmed number.

Select the Telcall type from the "Tel Call Type" Drop Down list.

The available selections are B16 (BARRETT®16), C12 (CODAN®12), and C16 (CODAN®16).

Put a check mark into the check box to enable programming of the Selcall Self ID from the transceiver's set ("menu") mode.

1
2
3
4
5
6
7
8
9
10
AUX

"TELEPHONE NUMBER" PARAMETERS

ALE Menu

ALE COMMON PARAMETERS

This parameter programs the various configurations for the ALE (Automatic Link Establishment) system of the radio. The ALE system allows the radio to select the channel with the best LQA (Link Quality Analysis) score from the programmed channels.

Put a check mark into the check box to enable adjustment of its parameters from the transceiver's set ("menu") mode.

The available parameters are ALE, Alert Tone, Auto Address, External Alert, Link TOT, Minimum LQA Score, PTT Time Out, and Net Number.

ALE

This parameter selects whether the ALE System shall be "Enabled (ON)" or "Disabled (OFF)".

ALERT TONE

This parameter selects the Alert Tone ringing period once the ALE link is established.

The available selections are "2 Sec," "5 Sec," "20 Sec," "CONTINUOUS," and "OFF."

AUTO ADDRESS

This parameter toggles the Auto Address feature "ON" and "OFF."

When this parameter is set "ON," the radio will add an unknown incoming call address to the "Other Station Address" directory automatically.

EXTERNAL ALERT

This parameter defines whether the External Alert port (Open Collector: Max. 60 V, 1A) shall be "Enabled (ON)" or "Disabled (OFF)."

When this parameter is set to "Enabled (ON)," the External Alert port turns to "ON," when a call is received.

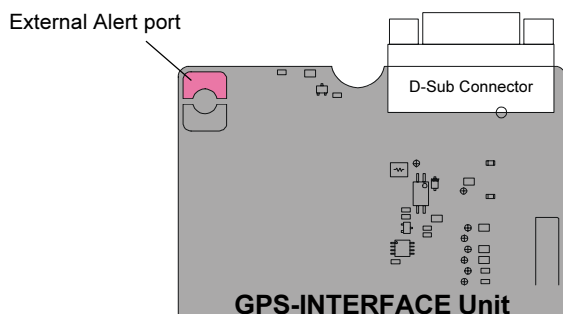

LINK TOT

This parameter define whether the Link TOT feature shall be "Enabled (ON)" or "Disabled (OFF)." When this parameter is set to "ON," the link to the other radio will be automatically disconnected unless you press the PTT within 30 seconds after receiving an ALE call.

MINIMUM LQA SCORE

This parameter determine the minimum LQA (Link Quality Analysis) score required to establish a link.

To program this parameter, double click the left mouse button on this column, enter the desired minimum LQA value, then press the [ENTER] key to save and exit.

Available selections are "0" to "100."

PTT TIME OUT

This parameter selects the delay time between the releasing of the PTT switch and the disconnecting of the ALE link.

The available selections are "1 minute" to "10 minutes" and "OFF."

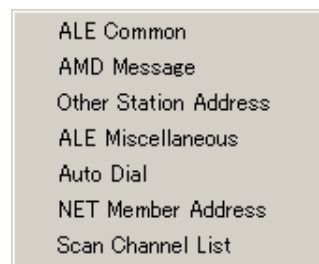

ALE MENU

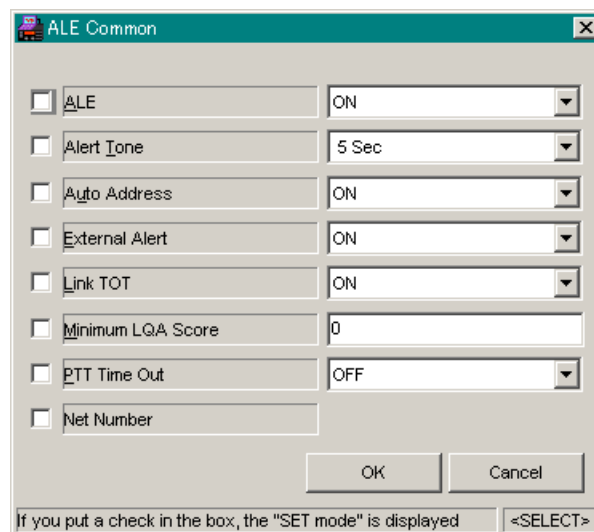

"ALE COMMON" PARAMETERS

CE77 PC Programming Software

NET NUMBER

Put a check mark into the check box to enable adjustment of its parameter from the transceiver's set ("menu") mode.

AMD MESSAGE PARAMETERS

This parameter programs the Alpha/Numeric messages in accordance with the AMD definition.

To enter the Alpha/Numeric message, double click the left mouse button on the desired column, type the characters of the desired Alpha/Numeric message (up to 90 characters), then press the [ENTER] key to save the programmed "message."

Put a check mark into the check box to enable adjustment of its parameter from the transceiver's set ("menu") mode.

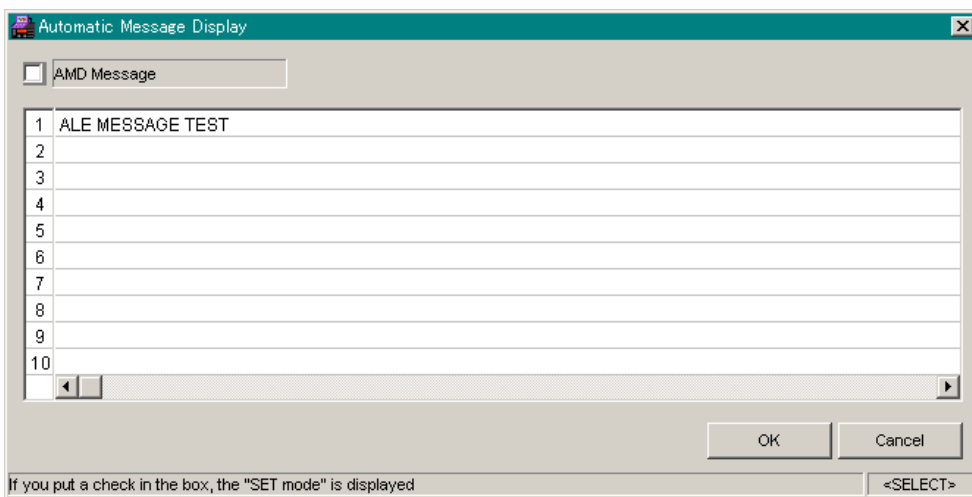

"AMD MESSAGE" PARAMETERS

OTHER STATION ADDRESS PARAMETERS

This parameter programs the Net Member's Alpha/Numeric identification for the ALE feature.

To enter the Net Member's Alpha/Numeric identification, double click the left mouse button on the desired column, type in the characters of the Alpha/Numeric identification (up to 15 characters), then press the [ENTER] key to save the programmed identification.

Put a check mark into the check box to enable adjustment of its parameter from the transceiver's set ("menu") mode.

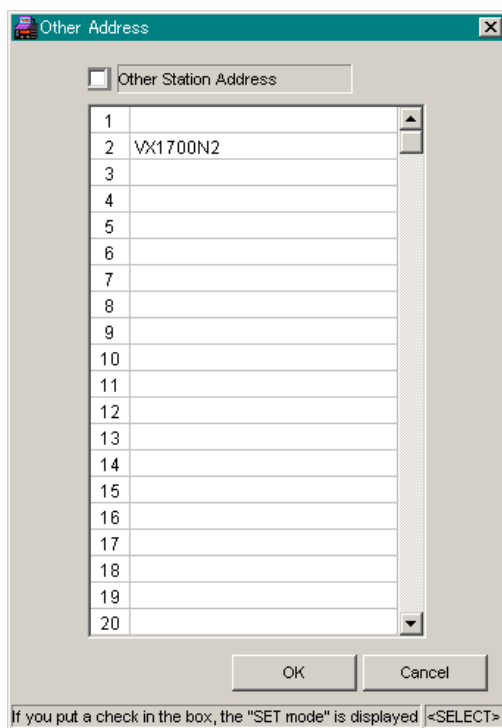

"OTHER STATION ADDRESS" PARAMETERS

ALE MISCELLANEOUS PARAMETERS

This parameter programs the various configurations for the ALE (Automatic Link Establishment) system of the radio.

Put a check mark into the check box to enable adjustment of these parameters from the transceiver's set ("menu") mode.

The available parameters are Net Number, Sounding, All Call Set, LQA Request, Master/Slave, Net Name, Occupancy Detection, Self Address, Silent Mode, Scan Rate, and Tune Time.

NET NUMBER

This pull-down list selects the Network number to be programmed.

SOUNDING

This parameter defines the interval of the automatic sounding feature which is a method for testing the quality of communication channels and propagation paths under field conditions.

The available selections are "30," "60," "90," and "120" (minutes).

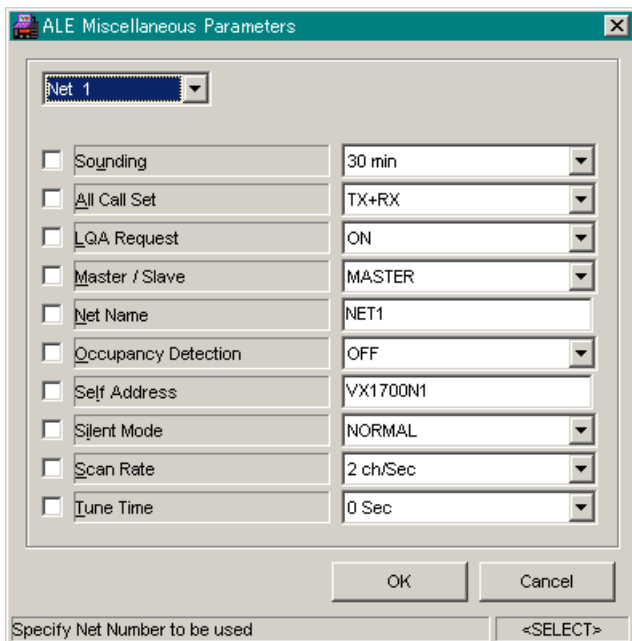

"ALE MISCELLANEOUS" PARAMETERS

ALL CALL SET

This parameter determines whether the ALE is able to receive or transmit an All Call feature.

The available selections are "RX," "TX," "TX+RX," and "OFF."

- RX: Enables the receiving of All Call and disables the sending of All Call.
- TX: Enables the sending of All Call and disables the receiving of All Call.
- TX+RX: Enables both the receiving and sending of All Call.
- OFF: Disables both the receiving and sending of All Call.

LQA REQUEST

This parameter defines whether the LQA (Link Quality Analysis) request shall be "Enabled (ON)" or "Disabled (OFF)."

When this parameter is set to "Enabled (ON)," the ALE will ask the called station for a report on the quality of the communication path every time that a call is initiated.

MASTER/SLAVE

This parameter defines whether the radio shall be act as a "Master" or "Slave" unit.

NET NAME

This parameter programs the network name for the ALE feature.

To enter the network name, double click the left mouse button on the desired column, type in the characters of the desired network name (up to 15 characters), then press the [ENTER] key to save the programmed name.

OCCUPANCY DETECTION

This parameter defines whether the channel "Occupancy" check function shall be "Enabled" or "Disabled" after sending an ALE call.

SELF ADDRESS

This parameter programs the transceiver's Alpha/Numeric self identification for the ALE feature.

To enter the Alpha/Numeric self identification, double click the left mouse button on the desired column, type the characters of the desired Alpha/Numeric self-identification name (up to 15 characters), then press the [ENTER] key to save the programmed self-identification name.

CE77 PC Programming Software

SILENT MODE

This parameter defines whether the Silent mode shall be "Enabled (SILENT)" or "Disabled (NORMAL)."

When this parameter is set to "Enabled (SILENT)," the network can initiate calls but the network is not allowed to respond to an ALE transmission.

SCAN RATE

This parameter toggles the scan speed between the "2 sec/ch" (2 seconds per channel) and "5 sec/ch" (5 seconds per channel) when the radio is in the ALE mode.

We recommend that this parameter is set to "2 sec/ch" when the ALE Unit and Antenna Tuner Unit is used simultaneously.

TUNE TIME

This parameter sets the maximum time that the current ALE will wait for the called station to respond.

The available selections are "1 Sec" to "20 Sec," and "OFF (0 Sec)." However, please set this parameter to "OFF (0 Sec)" at all times.

NET NUMBER

This pull-down list selects the Network number to be programmed.

AUTO DIAL PARAMETER

This parameter programs the address and message for the ALE Call.

To enter the address, double click the left mouse button on the desired "Address" to invoke a pop-up window, select the desired address, then click the [OK] button to accept the address.

To enter the message, if you desired, select the Network Member to be programmed from the pull-down list, then double click the left mouse button on the desired "Message" to invoke a pop-up window, select the desired message, then click the [OK] button to accept the message.

Put a check mark into the check box to enable adjustment of its parameter from the transceiver's set ("menu") mode.

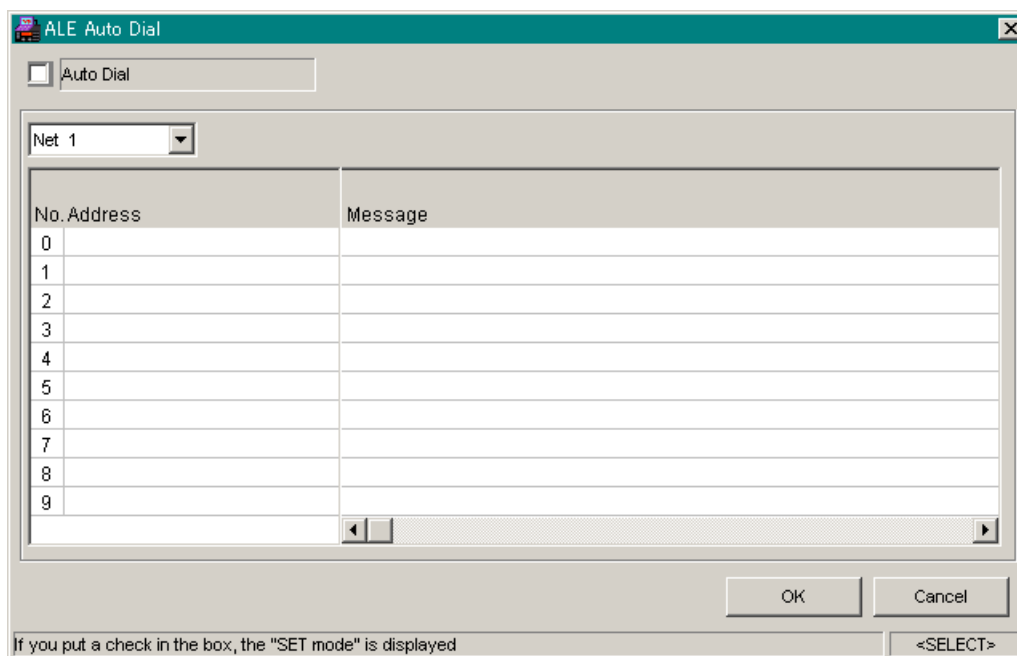

"AUTO DIAL" PARAMETERS

NET MEMBER ADDRESS PARAMETER

This parameter defines the network member address to be called.

To enter the network member address, select the network from the pull-down list, then double click the left mouse button on the desired bank to invoke a pop-up window, select the desired address, then click the [OK] button to accept the address.

Note: Please make sure that the "SELF ADDRESS" setting position is not piled up the other transceiver's setting, and does not duplicate the "SELF ADDRESS" setting to the other bank.

SCAN CHANNEL LIST PARAMETERS

This parameter defines the memory channel to be scanned.

To program the list, select the network from the pull-down list, then double click the left mouse button on each memory channel to be included in the scanning list.

If you put on the "Chn" radio button, indicate the Scan Channel by the "Frequency" display. Meanwhile, If you put on the "TAG" radio button, indicate the Scan Channel by the "Alpha/numeric Tag" display.

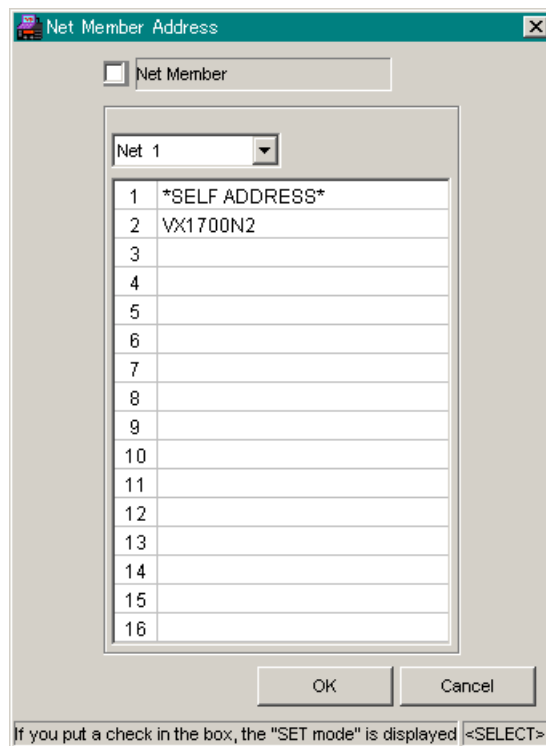

"NET MEMBER ADDRESS" PARAMETERS

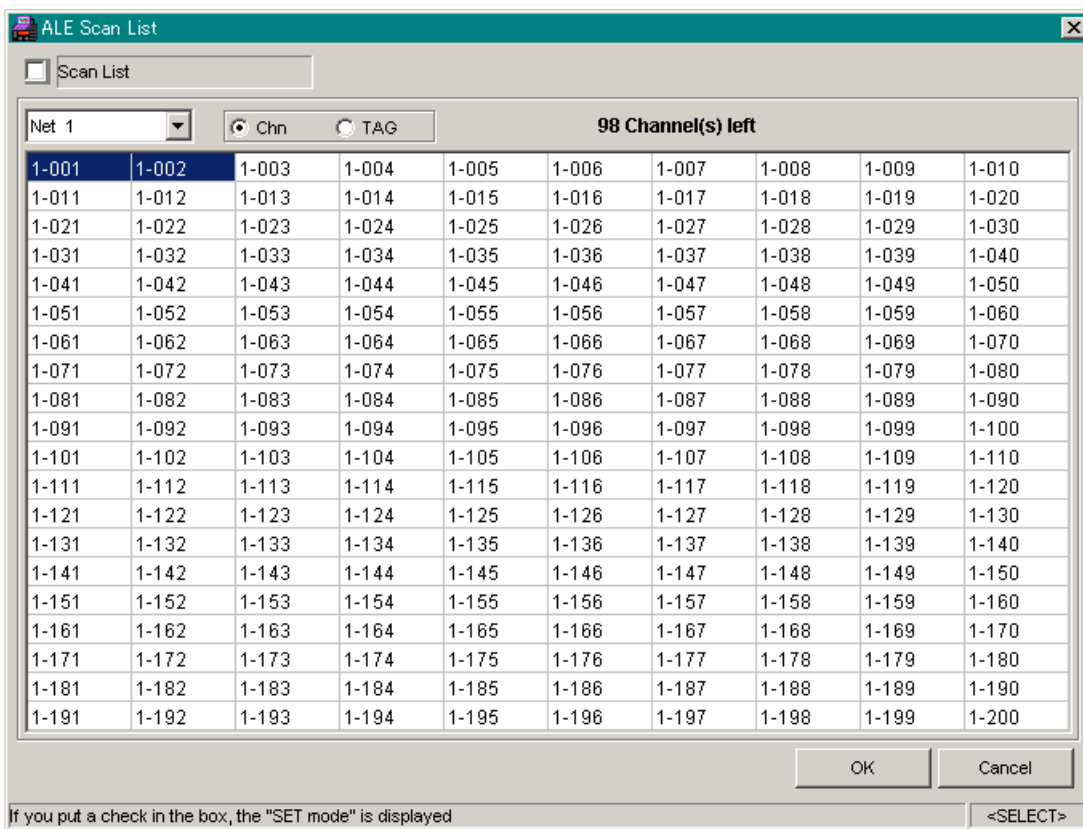

"SCAN CHANNEL LIST" PARAMETERS

CE77 PC Programming Software

Channel Menu

CHANNEL ALLOCATION PARAMETER

The VX-1700 is capable of allocating up to 200 channels into 5 banks.

By default, Bank-1 is filled with all memories (200 channels); Bank-2 through Bank-5 are disabled (empty). Bank-2 will be enabled once Bank-1 is filled to capacity, and will start being filled by the extra memories carried over.

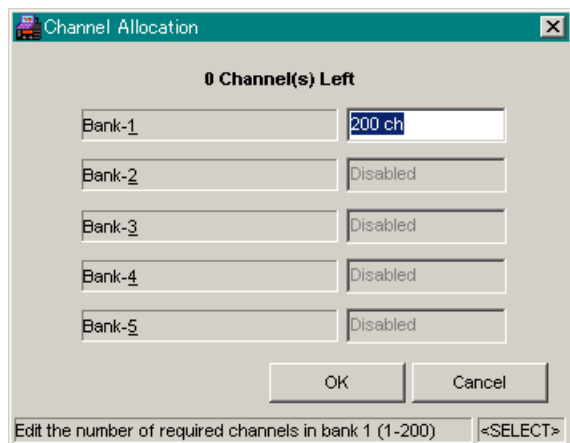

"CHANNEL ALLOCATION" PARAMETERS

Radio Menu

UPLOAD PARAMETER

Reads the configuration data from the radio to the computer. Existing data on the screen will be overwritten with data from the radio, and will be lost unless you save it.

NOTE: Make sure to select the correct communications port to ensure proper operation. The program will lock-up if there is a conflict between the mouse port and PC Programming Cable Port.

Shortcuts

Toolbar:

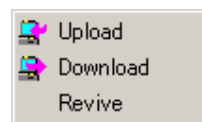

RADIO MENU

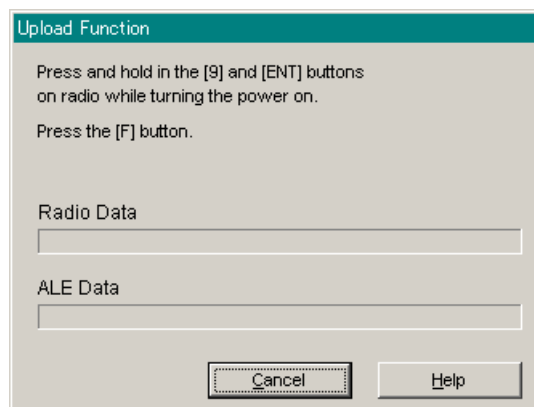

"UPLOAD" PARAMETER

DOWNLOAD PARAMETER

Writes the configuration data from the computer to the radio. Data will be verified for integrity by the program before downloading is initiated.

NOTE: Make sure to select the correct communications port to ensure proper operation. The program will lock-up if there is a conflict between the mouse port and PC Programming Cable Port.

Shortcuts

Toolbar: 

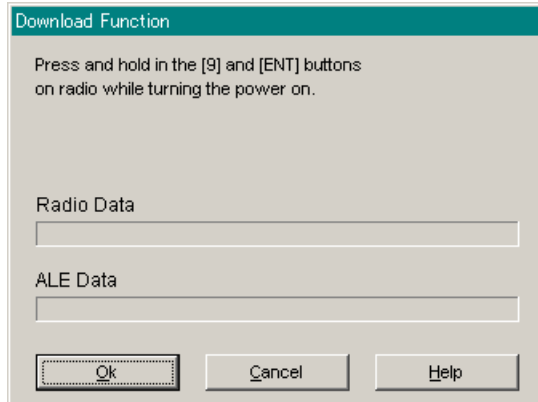

"DOWNLOAD" PARAMETER

REVIVE PARAMETER

This parameter returns the radio to the normal mode from the STUN mode.

Turn the stunned radio on and wait 2 seconds, then click the [Revive] button to return the radio to the normal mode.

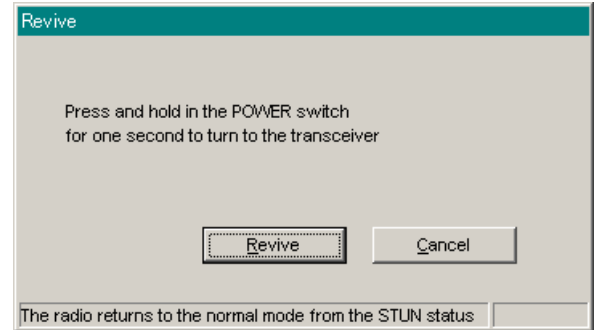

"REVIVE" PARAMETER

CE77 PC Programming Software

Programming Example 1

Selcall Feature Basic Setup

1. Assign the "SELCALL" function into the "Programmable Function key 1 (P1 SET)" and the "CALL" function to the "Programmable Function key 2 (P2 SET)" from the "KEY FUNCTION" parameter in the "Common" menu.
2. Set the "SELCALL" parameter in the "Selcall" menu to the "TX+RX" option, to enable the receiving and sending of a Selcall.
3. Enter the your radio's Selcall ID (four digits) into the "Selcall Self ID" column on the "Main Programming Screen (Memory Screen)" for each memory channel.
4. Enter the station's Selcall ID (four digits) of the station to be called into the "TXID" parameter in the "Selcall" menu.
5. Set the effective channel range (i.e.1-001 and 1-200) for the TX ID into the "FROM" and "TO" columns of the "TX ID" parameter in the "Selcall" menu.
6. Download the programming data to the transceiver from the computer via the "Download" parameter in the "Radio" menu.

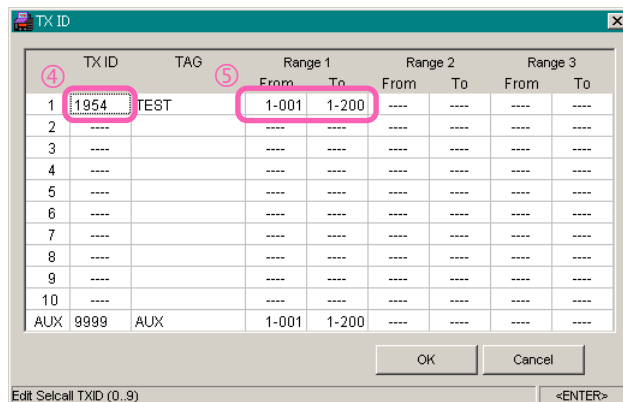
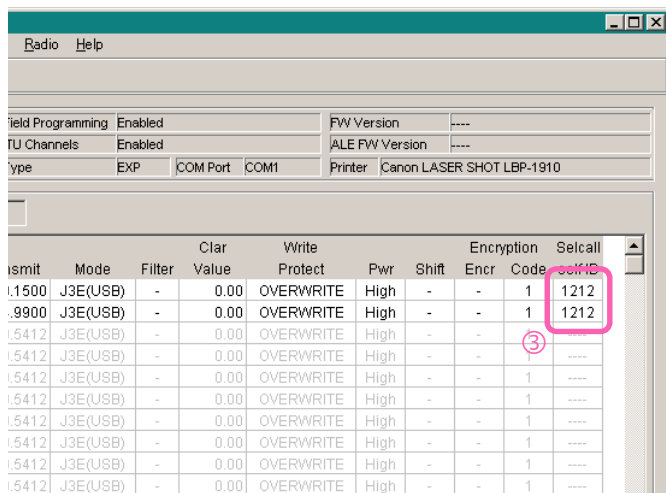
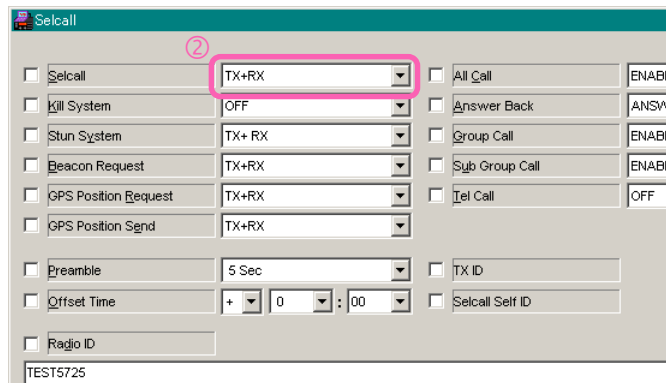
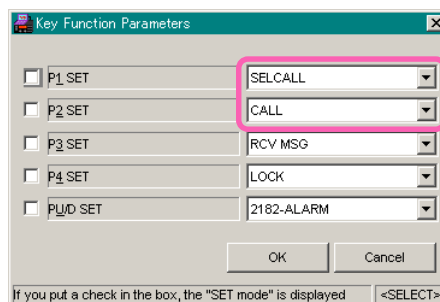

Programming Example 2

ALE Feature Basic Setup

1. Set the "Optional Board" parameter which is located in the "Option" folder in the "Common" menu to the "ALE Unit" to activate the optional ALE-1 Unit.
2. Set the "ALE" parameter in the "ALE Common" folder in the "ALE" menu to "ON" to enable the ALE feature.
3. Enter the Network Address to be used into the "Net Name" parameter in the "ALE Miscellaneous" folder in the "ALE" menu.
4. Enter the to-be-called Station's Address (Net Member's Alpha/Numeric identification) to be called into the "Other Station Address" parameter in the "ALE" menu.
5. Enter your unit's identifying Address into the "Self Address" parameter on the "ALE Miscellaneous" folder in the "ALE" menu.
6. Define the Network Member Address to be called from the "Network Member Address" parameter in the "ALE" menu.
7. Define the Memory Channels to be scanned during from the "Scan Channel List" parameter in the "ALE" menu.

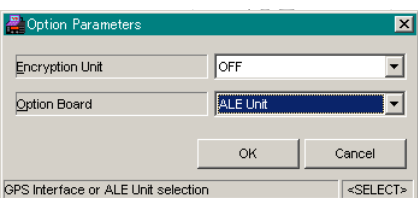
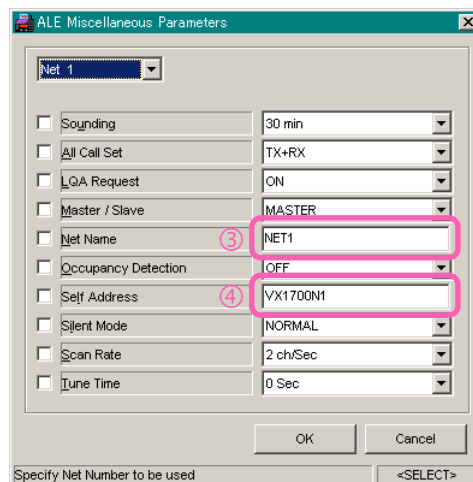
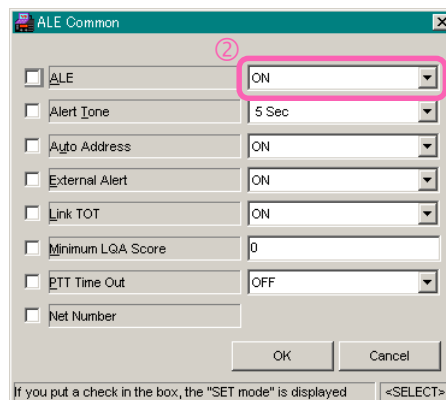

programming data to the trans-computer via the "Download" "Radio" menu.

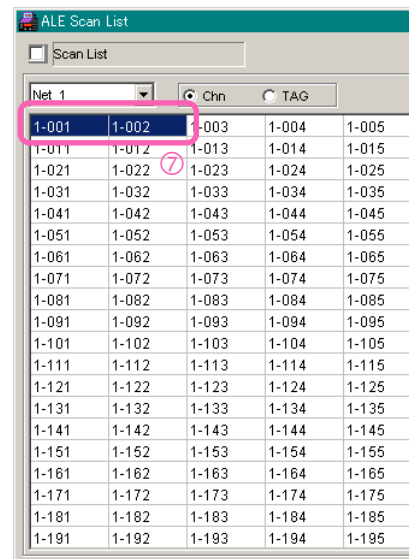

CE77 PC Programming Software

Programming Example 3

Kill Command Setup

- ❑ Enter the Kill Command (CILLIK) and Radio ID (ex. TEST6111) into the "Message" parameter on the "Selcall" folder in the "Selcall" menu.



The screenshot shows a dialog box for setting up a Kill Command. It has two input fields: "Radio ID" and "Message". The "Radio ID" field contains "TEST5725" and has an unchecked checkbox to its left. The "Message" field contains "CILLIKTEST6111" and has a checked checkbox to its left. A pink rectangular box highlights the "Message" field. At the bottom of the dialog, there is a footer text: "Edit Radio ID for Kill System and Stun System (0".

Programming Example 5

Revive Command Setup

- ❑ Enter the Revive Command (SVIVER) and Radio ID (ex. TEST6111) into the "Message" parameter on the "Selcall" folder in the "Selcall" menu.



The screenshot shows a dialog box for setting up a Revive Command. It has two input fields: "Radio ID" and "Message". The "Radio ID" field contains "TEST5725" and has an unchecked checkbox to its left. The "Message" field contains "SVIVERTEST6111" and has a checked checkbox to its left. A pink rectangular box highlights the "Message" field. At the bottom of the dialog, there is a footer text: "If you put a check in the box, the "SET mode" is".

Programming Example 4

Stun Command Setup

- ❑ Enter the Stun Command (ECNUTS) and Radio ID (ex. TEST6111) into the "Message" parameter on the "Selcall" folder in the "Selcall" menu.

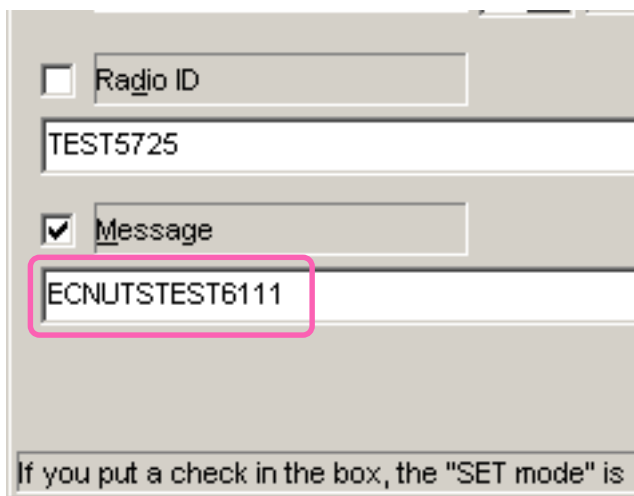

The screenshot shows a dialog box for setting up a Stun Command. It has two input fields: "Radio ID" and "Message". The "Radio ID" field contains "TEST5725" and has an unchecked checkbox to its left. The "Message" field contains "ECNUTSTEST6111" and has a checked checkbox to its left. A pink rectangular box highlights the "Message" field. At the bottom of the dialog, there is a footer text: "If you put a check in the box, the "SET mode" is".

MAIN Unit

Note

MAIN Unit

Parts Layout (Side A)

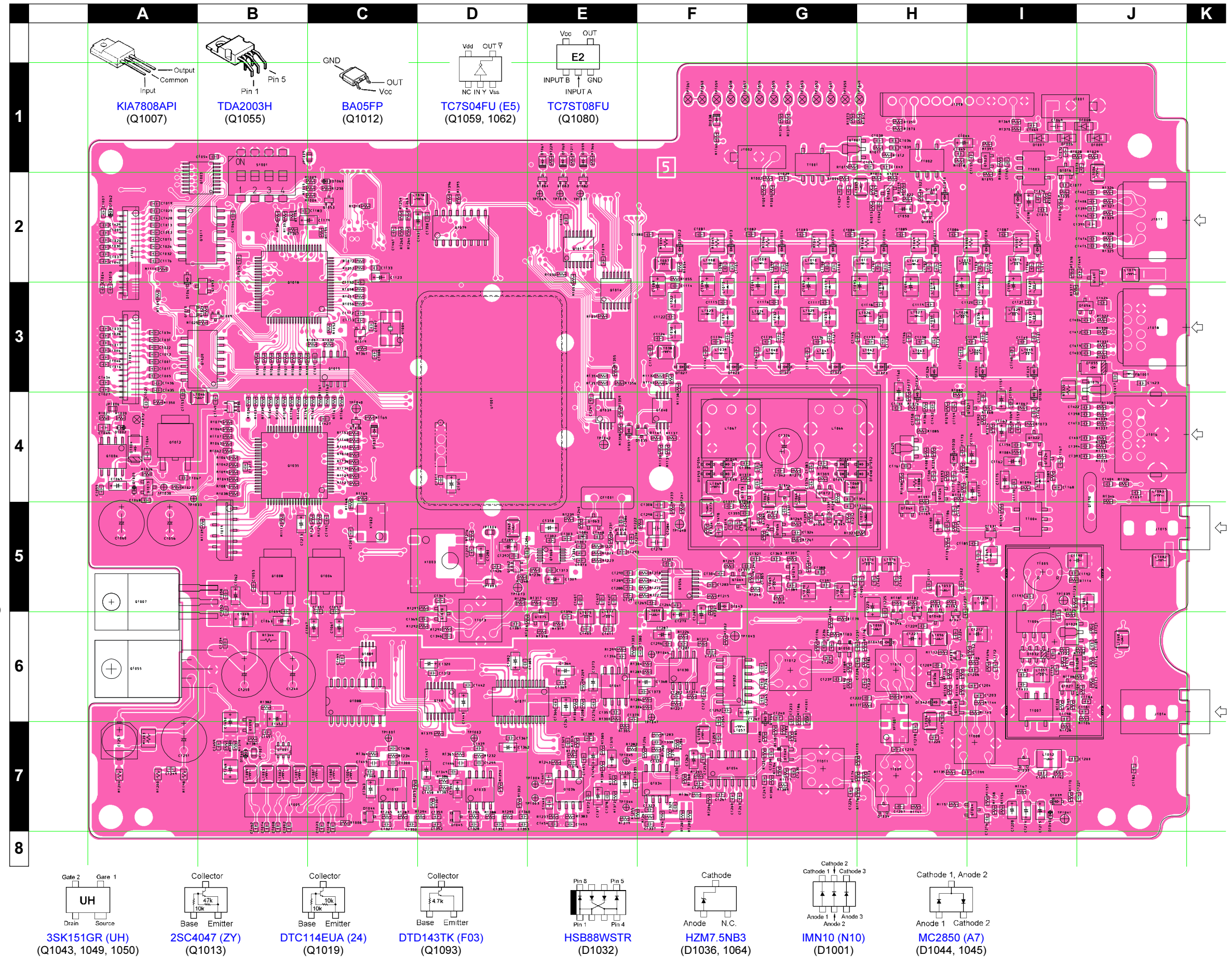
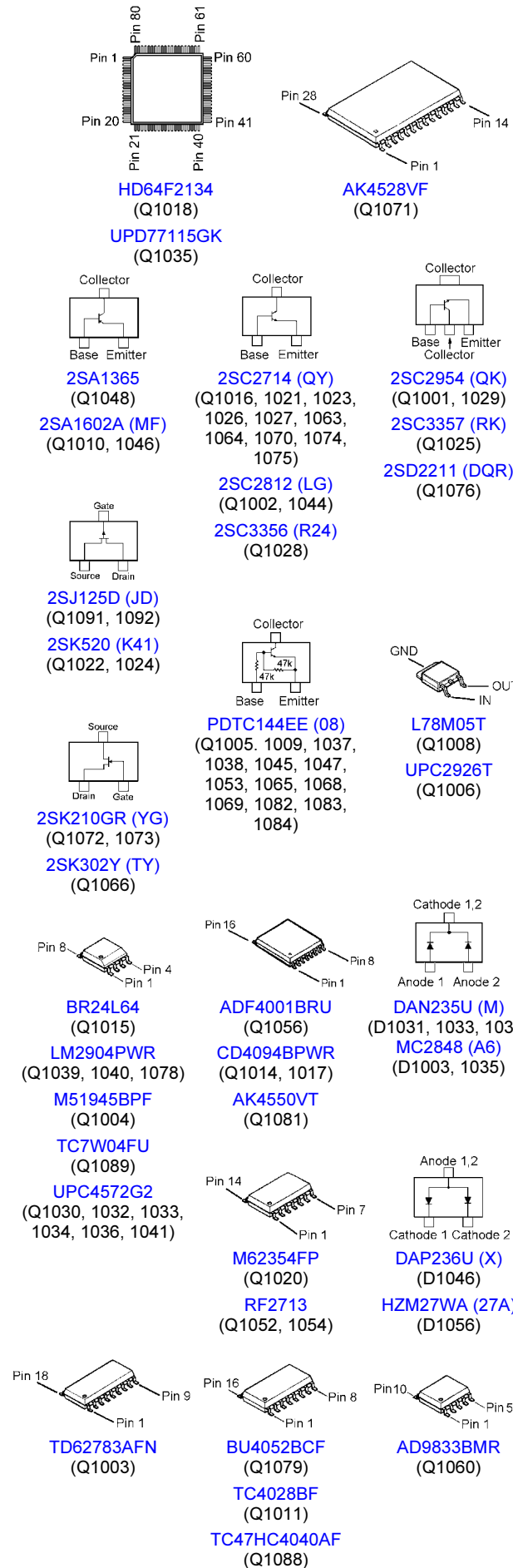

MAIN Unit

Parts Layout (Side B)

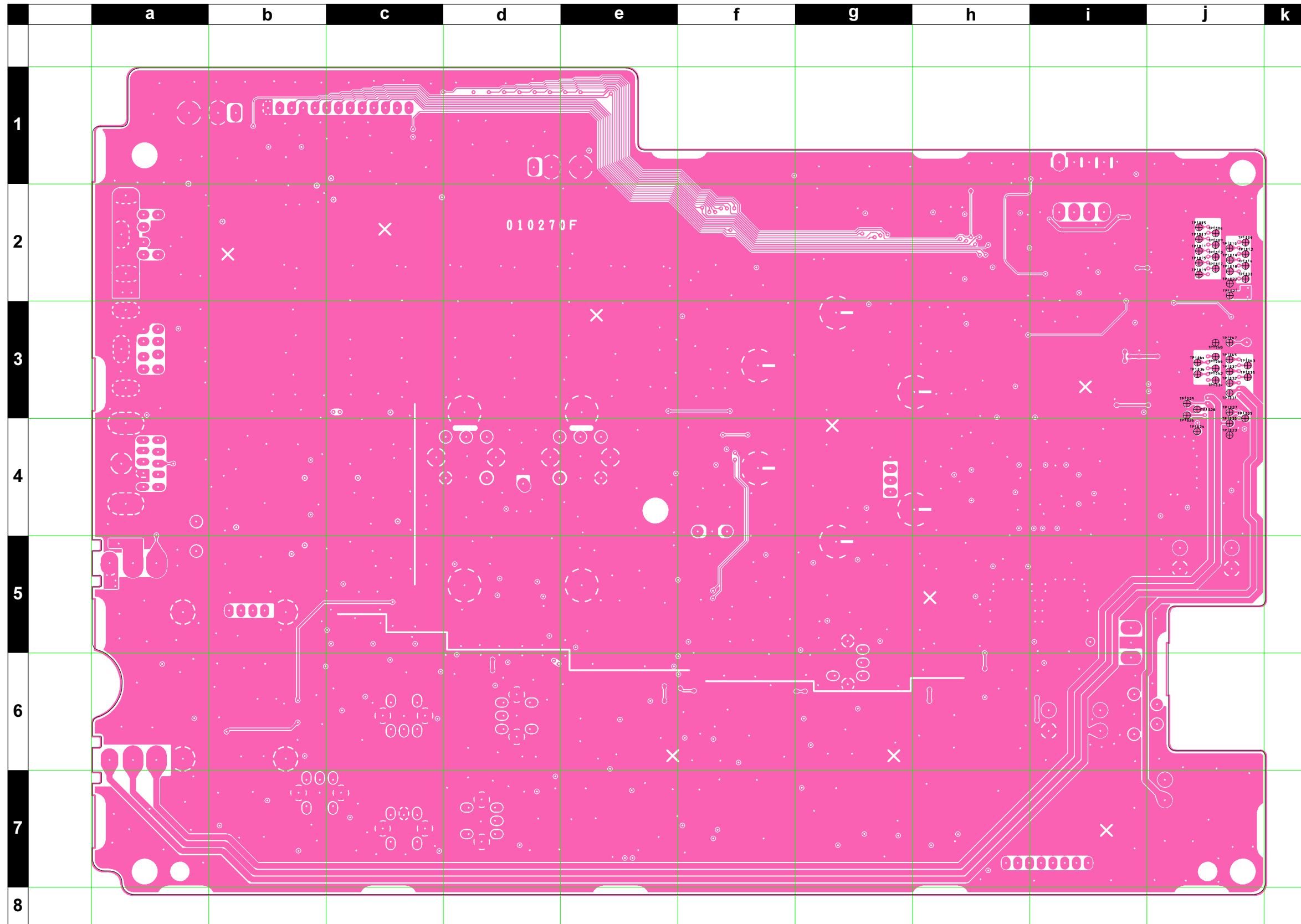

REF.	DESCRIPTION	VALUE	V/W	TOL.	MFR'S DESIG	VXSTD P/N	VERS.	LOT.	SIDE	LAY ADR
PCB with Components						CS1853002				
Printed Circuit Board				AC051H000		FR010270F		1-		
C 1002	CHIP CAP.	0.01uF	25V	B	GRM39B103K25PT	K22144803		1-	A	B7
C 1003	CHIP CAP.	0.01uF	25V	B	GRM39B103K25PT	K22144803		1-	A	A2
C 1008	CHIP CAP.	0.01uF	25V	B	GRM39B103K25PT	K22144803		1-	A	B7
C 1009	CHIP CAP.	0.01uF	25V	B	GRM39B103K25PT	K22144803		1-	A	A2
C 1014	CHIP CAP.	0.01uF	25V	B	GRM39B103K25PT	K22144803		1-	A	B7
C 1015	CHIP CAP.	0.01uF	25V	B	GRM39B103K25PT	K22144803		1-	A	A2
C 1018	CHIP CAP.	0.01uF	25V	B	GRM39B103K25PT	K22144803		1-	A	C7
C 1019	CHIP CAP.	0.01uF	25V	B	GRM39B103K25PT	K22144803		1-	A	A2
C 1020	CHIP CAP.	0.01uF	25V	B	GRM39B103K25PT	K22144803		1-	A	A2
C 1024	CHIP CAP.	0.022uF	25V	B	GRM39B223K25PT	K22144807		1-	A	G2
C 1025	CHIP CAP.	0.01uF	25V	B	GRM39B103K25PT	K22144803		1-	A	A2
C 1026	CHIP CAP.	0.01uF	25V	B	GRM39B103K25PT	K22144803		1-	A	A2
C 1027	CHIP CAP.	0.01uF	25V	B	GRM39B103K25PT	K22144803		1-	A	A3
C 1029	CHIP CAP.	0.022uF	25V	B	GRM39B223K25PT	K22144807		1-	A	G2
C 1030	CHIP CAP.	0.01uF	25V	B	GRM39B103K25PT	K22144803		1-	A	A2
C 1032	CHIP CAP.	0.01uF	25V	B	GRM39B103K25PT	K22144803		1-	A	A2
C 1034	CHIP CAP.	0.01uF	25V	B	GRM39B103K25PT	K22144803		1-	A	A3
C 1035	CHIP CAP.	0.022uF	25V	B	GRM39B223K25PT	K22144807		1-	A	G2
C 1036	CHIP CAP.	0.1uF	16V	B	GRM188B11C104KA01D	K22124805		1-	A	H1
C 1038	CHIP CAP.	470pF	50V	CH	GRM1882C1H471JA01D	K22174249		1-	A	H1
C 1039	CHIP CAP.	0.022uF	25V	B	GRM39B223K25PT	K22144807		1-	A	H1
C 1041	CHIP CAP.	0.01uF	25V	B	GRM39B103K25PT	K22144803		1-	A	H1
C 1042	CHIP CAP.	0.022uF	25V	B	GRM39B223K25PT	K22144807		1-	A	H2
C 1043	CHIP CAP.	0.022uF	25V	B	GRM39B223K25PT	K22144807		1-	A	H1
C 1044	CHIP TA.CAP.	1uF	16V		TESVA1C105M1-8R	K78120009		1-	A	H1
C 1045	CHIP CAP.	0.022uF	25V	B	GRM39B223K25PT	K22144807		1-	A	H1
C 1047	CHIP TA.CAP.	4.7uF	16V		TEMSVA1C475M-8R	K78120031		1-	A	C6
C 1048	CHIP TA.CAP.	4.7uF	25V		TEMSVB21E475M-8R	K78140019		1-	A	B6
C 1049	CHIP CAP.	0.1uF	25V	B	GRM40B104M25PT	K22140811		1-	A	A4
C 1050	CHIP TA.CAP.	2.2uF	16V		TEMSVA1C225M-8R	K78120015		1-	A	H2
C 1051	CHIP CAP.	0.01uF	25V	B	GRM39B103K25PT	K22144803		1-	A	C5
C 1052	CHIP CAP.	0.01uF	25V	B	GRM39B103K25PT	K22144803		1-	A	B5
C 1053	CHIP CAP.	0.01uF	25V	B	GRM39B103K25PT	K22144803		1-	A	B5
C 1054	CHIP CAP.	0.01uF	25V	B	GRM39B103K25PT	K22144803		1-	A	B1
C 1055	CHIP CAP.	0.1uF	16V	B	GRM188B11C104KA01D	K22124805		1-	A	A4
C 1056	AL.ELECTRO.CAP.	470uF	16V		RE3-16V471MG3#	K40129066		1-	A	A5
C 1057	CHIP CAP.	0.01uF	25V	B	GRM39B103K25PT	K22144803		1-	A	C5
C 1058	CHIP CAP.	0.01uF	25V	B	GRM39B103K25PT	K22144803		1-	A	B5
C 1059	CHIP CAP.	0.047uF	16V	B	GRM39B473K16PT	K22124804		1-	A	B5
C 1060	AL.ELECTRO.CAP.	470uF	16V		RE3-16V471MG3#	K40129066		1-	A	A5
C 1061	CHIP TA.CAP.	4.7uF	16V		TEMSVA1C475M-8R	K78120031		1-	A	C6
C 1062	CHIP TA.CAP.	4.7uF	16V		TEMSVA1C475M-8R	K78120031		1-	A	B5
C 1063	CHIP TA.CAP.	10uF	10V		TEMSVA1A106M-8R	K78100028		1-	A	B6
C 1064	CHIP CAP.	0.1uF	25V	B	GRM40B104M25PT	K22140811		1-	A	A4
C 1065	CHIP TA.CAP.	1.5uF	16V		TESVA1C155M1-8R	K78120020		1-	A	A4
C 1066	CHIP CAP.	0.01uF	25V	B	GRM39B103K25PT	K22144803		1-	A	B2
C 1067	CHIP CAP.	0.1uF	16V	B	GRM188B11C104KA01D	K22124805		1-	A	A4
C 1068	CHIP CAP.	0.1uF	16V	B	GRM188B11C104KA01D	K22124805		1-	A	A4
C 1069	CHIP CAP.	0.1uF	50V	B	GRM42-6B104K50PT	K22171820		1-	A	I1
C 1070	CHIP CAP.	0.01uF	25V	B	GRM39B103K25PT	K22144803		1-	A	E2
C 1071	CHIP CAP.	0.1uF	16V	B	GRM188B11C104KA01D	K22124805		1-	A	C3
C 1072	CHIP CAP.	0.01uF	25V	B	GRM39B103K25PT	K22144803		1-	A	I1
C 1073	CHIP CAP.	0.047uF	16V	B	GRM39B473K16PT	K22124804		1-	A	J1
C 1074	CHIP CAP.	0.022uF	25V	B	GRM39B223K25PT	K22144807		1-	A	I2
C 1075	CHIP CAP.	0.1uF	16V	B	GRM188B11C104KA01D	K22124805		1-	A	B2
C 1076	CHIP CAP.	0.022uF	25V	B	GRM39B223K25PT	K22144807		1-	A	I2
C 1077	CHIP CAP.	0.01uF	25V	B	GRM39B103K25PT	K22144803		1-	A	I2

MAIN Unit

Parts List

REF.	DESCRIPTION	VALUE	V/W	TOL.	MFR'S DESIG	VXSTD P/N	VERS.	LOT.	SIDE	LAY ADR
C 1078	CHIP TA.CAP.	1uF	16V		TESVA1C105M1-8R	K78120009		1-	A	I2
C 1079	CHIP CAP.	0.01uF	25V	B	GRM39B103K25PT	K22144803		1-	A	E2
C 1080	CHIP CAP.	0.022uF	25V	B	GRM39B223K25PT	K22144807		1-	A	F2
C 1081	CHIP CAP.	0.022uF	25V	B	GRM39B223K25PT	K22144807		1-	A	F2
C 1082	CHIP CAP.	0.022uF	25V	B	GRM39B223K25PT	K22144807		1-	A	G2
C 1083	CHIP CAP.	0.022uF	25V	B	GRM39B223K25PT	K22144807		1-	A	G2
C 1084	CHIP CAP.	0.022uF	25V	B	GRM39B223K25PT	K22144807		1-	A	G2
C 1085	CHIP CAP.	0.022uF	25V	B	GRM39B223K25PT	K22144807		1-	A	H2
C 1086	CHIP CAP.	0.022uF	25V	B	GRM39B223K25PT	K22144807		1-	A	H2
C 1087	CHIP CAP.	0.022uF	25V	B	GRM39B223K25PT	K22144807		1-	A	I2
C 1088	CHIP CAP.	10pF	50V	CH	GRM1882C1H100JA01D	K22174211		1-	A	C3
C 1089	CHIP TA.CAP.	10uF	16V		TEMSVB21C106M-8R	K78120025		1-	A	F3
C 1090	CHIP TA.CAP.	10uF	16V		TEMSVB21C106M-8R	K78120025		1-	A	F3
C 1091	CHIP TA.CAP.	10uF	16V		TEMSVB21C106M-8R	K78120025		1-	A	G3
C 1092	CHIP TA.CAP.	10uF	16V		TEMSVB21C106M-8R	K78120025		1-	A	G3
C 1093	CHIP TA.CAP.	10uF	16V		TEMSVB21C106M-8R	K78120025		1-	A	H3
C 1094	CHIP TA.CAP.	10uF	16V		TEMSVB21C106M-8R	K78120025		1-	A	H3
C 1095	CHIP TA.CAP.	10uF	16V		TEMSVB21C106M-8R	K78120025		1-	A	H3
C 1096	CHIP TA.CAP.	10uF	16V		TEMSVB21C106M-8R	K78120025		1-	A	I3
C 1097	CHIP CAP.	12pF	50V	CH	GRM1882C1H120JA01D	K22174213		1-	A	C3
C 1098	CHIP CAP.	220pF	50V	CH	GRM1882C1H221JA01D	K22174243		1-	A	F2
C 1099	CHIP CAP.	150pF	50V	CH	GRM1882C1H151JA01D	K22174239		1-	A	G2
C 1100	CHIP CAP.	120pF	50V	CH	GRM1882C1H121JA01D	K22174237		1-	A	G2
C 1101	CHIP CAP.	56pF	50V	CH	GRM1882C1H560JA01D	K22174229		1-	A	H2
C 1102	CHIP CAP.	22pF	50V	CH	GRM1882C1H220JA01D	K22174219		1-	A	H2
C 1103	CHIP CAP.	12pF	50V	CH	GRM1882C1H120JA01D	K22174213		1-	A	I2
C 1104	CHIP CAP.	0.5pF	50V	CK	GRM1884C1HR50CZ01D	K22174201		1-	A	I2
C 1105	CHIP CAP.	100pF	50V	CH	GRM1882C1H101JA01D	K22174235		1-	A	F2
C 1106	CHIP CAP.	68pF	50V	CH	GRM1882C1H680JA01D	K22174231		1-	A	G2
C 1107	CHIP CAP.	47pF	50V	CH	GRM1882C1H470JA01D	K22174227		1-	A	G2
C 1108	CHIP CAP.	24pF	50V	CH	GRM1882C1H240JZ01D	K22174220		1-	A	H2
C 1109	CHIP CAP.	15pF	50V	CH	GRM1882C1H150JA01D	K22174215		1-	A	H2
C 1110	CHIP CAP.	12pF	50V	CH	GRM1882C1H120JA01D	K22174213		1-	A	I2
C 1111	CHIP CAP.	8pF	50V	CH	GRM1882C1H8R0DZ01D	K22174209		1-	A	I2
C 1112	CHIP CAP.	8pF	50V	CH	GRM1882C1H8R0DZ01D	K22174209		1-	A	C3
C 1114	CHIP CAP.	200pF	50V	CH	GRM1882C1H201JA01D	K22174242		1-	A	F3
C 1115	CHIP CAP.	470pF	50V	CH	GRM1882C1H471JA01D	K22174249		1-	A	F3
C 1116	CHIP CAP.	330pF	50V	CH	GRM1882C1H331JA01D	K22174253		1-	A	G3
C 1117	CHIP CAP.	220pF	50V	CH	GRM1882C1H221JA01D	K22174243		1-	A	G3
C 1118	CHIP CAP.	150pF	50V	CH	GRM1882C1H151JA01D	K22174239		1-	A	H3
C 1119	CHIP CAP.	120pF	50V	CH	GRM1882C1H121JA01D	K22174237		1-	A	H3
C 1120	CHIP CAP.	75pF	50V	CH	GRM1882C1H750JZ01D	K22174232		1-	A	I3
C 1121	CHIP CAP.	47pF	50V	CH	GRM1882C1H470JA01D	K22174227		1-	A	I3
C 1122	CHIP CAP.	360pF	50V	CH	GRM39CH361J50PT	K22174254		1-	A	F3
C 1123	CHIP TA.CAP.	10uF	10V		TEMSVA1A106M-8R	K78100028		1-	A	C2
C 1124	CHIP CAP.	200pF	50V	CH	GRM1882C1H201JA01D	K22174242		1-	A	F3
C 1125	CHIP CAP.	100pF	50V	CH	GRM1882C1H101JA01D	K22174235		1-	A	F3
C 1126	CHIP CAP.	68pF	50V	CH	GRM1882C1H680JA01D	K22174231		1-	A	G3
C 1127	CHIP CAP.	39pF	50V	CH	GRM1882C1H390JA01D	K22174225		1-	A	G3
C 1128	CHIP CAP.	24pF	50V	CH	GRM1882C1H240JZ01D	K22174220		1-	A	H3
C 1129	CHIP CAP.	15pF	50V	CH	GRM1882C1H150JA01D	K22174215		1-	A	H3
C 1130	CHIP CAP.	12pF	50V	CH	GRM1882C1H120JA01D	K22174213		1-	A	I3
C 1131	CHIP CAP.	8pF	50V	CH	GRM1882C1H8R0DZ01D	K22174209		1-	A	I3
C 1132	CHIP CAP.	1uF	10V	F	GRM188F11A105ZA01D	K22105001		1-	A	C2
C 1133	CHIP CAP.	0.022uF	25V	B	GRM39B223K25PT	K22144807		1-	A	C2
C 1134	CHIP CAP.	220pF	50V	CH	GRM1882C1H221JA01D	K22174243		1-	A	F3
C 1135	CHIP CAP.	150pF	50V	CH	GRM1882C1H151JA01D	K22174239		1-	A	G3
C 1136	CHIP CAP.	120pF	50V	CH	GRM1882C1H121JA01D	K22174237		1-	A	G3
C 1137	CHIP CAP.	62pF	50V	CH	GRM1882C1H620JZ01D	K22174230		1-	A	H3

REF.	DESCRIPTION	VALUE	V/W	TOL.	MFR'S DESIG	VXSTD P/N	VERS.	LOT.	SIDE	LAY ADR
C 1138	CHIP CAP.	18pF	50V	CH		K22174217		1-	A	H3
C 1139	CHIP CAP.	12pF	50V	CH	GRM1882C1H120JA01D	K22174213		1-	A	I3
C 1140	CHIP CAP.	0.5pF	50V	CK	GRM1884C1HR50CZ01D	K22174201		1-	A	I3
C 1141	CHIP CAP.	0.022uF	25V	B	GRM39B223K25PT	K22144807		1-	A	F3
C 1142	CHIP CAP.	0.022uF	25V	B	GRM39B223K25PT	K22144807		1-	A	F3
C 1143	CHIP CAP.	0.022uF	25V	B	GRM39B223K25PT	K22144807		1-	A	G3
C 1144	CHIP CAP.	0.022uF	25V	B	GRM39B223K25PT	K22144807		1-	A	G3
C 1145	CHIP CAP.	0.022uF	25V	B	GRM39B223K25PT	K22144807		1-	A	G3
C 1146	CHIP CAP.	0.022uF	25V	B	GRM39B223K25PT	K22144807		1-	A	H3
C 1147	CHIP CAP.	0.022uF	25V	B	GRM39B223K25PT	K22144807		1-	A	H3
C 1148	CHIP CAP.	0.022uF	25V	B	GRM39B223K25PT	K22144807		1-	A	I3
C 1149	CHIP CAP.	0.01uF	25V	B	GRM39B103K25PT	K22144803		1-	A	B4
C 1150	CHIP CAP.	0.01uF	25V	B	GRM39B103K25PT	K22144803		1-	A	A4
C 1151	CHIP TA.CAP.	2.2uF	16V		TEMSVA1C225M-8R	K78120015		1-	A	I4
C 1152	CHIP CAP.	0.022uF	25V	B	GRM39B223K25PT	K22144807		1-	A	I4
C 1153	CHIP CAP.	0.1uF	16V	B	GRM188B11C104KA01D	K22124805		1-	A	I4
C 1154	CHIP CAP.	0.022uF	25V	B	GRM39B223K25PT	K22144807		1-	A	I4
C 1155	CHIP CAP.	0.022uF	25V	B	GRM39B223K25PT	K22144807		1-	A	I1
C 1156	CHIP CAP.	0.022uF	25V	B	GRM39B223K25PT	K22144807		1-	A	I4
C 1157	CHIP CAP.	0.022uF	25V	B	GRM39B223K25PT	K22144807		1-	A	I4
C 1158	CHIP CAP.	0.01uF	25V	B	GRM39B103K25PT	K22144803		1-	A	H4
C 1159	CHIP CAP.	0.01uF	25V	B	GRM39B103K25PT	K22144803		1-	A	H4
C 1160	CHIP TA.CAP.	2.2uF	16V		TEMSVA1C225M-8R	K78120015		1-	A	H3
C 1161	CHIP CAP.	0.022uF	25V	B	GRM39B223K25PT	K22144807		1-	A	H4
C 1162	CHIP TA.CAP.	10uF	10V		TEMSVA1A106M-8R	K78100028		1-	A	I4
C 1163	CHIP TA.CAP.	1uF	16V		TESVA1C105M1-8R	K78120009		1-	A	I4
C 1164	CHIP CAP.	0.022uF	25V	B	GRM39B223K25PT	K22144807		1-	A	H4
C 1165	CHIP CAP.	0.01uF	25V	B	GRM39B103K25PT	K22144803		1-	A	I1
C 1166	CHIP CAP.	0.01uF	25V	B	GRM39B103K25PT	K22144803		1-	A	H4
C 1167	CHIP CAP.	0.047uF	16V	B	GRM39B473K16PT	K22124804		1-	A	I4
C 1168	CHIP CAP.	0.001uF	50V	B	GRM188B11H102KA01D	K22174821		1-	A	I4
C 1169	CHIP CAP.	0.022uF	25V	B	GRM39B223K25PT	K22144807		1-	A	H5
C 1170	CHIP CAP.	0.022uF	25V	B	GRM39B223K25PT	K22144807		1-	A	I4
C 1171	CHIP CAP.	0.047uF	16V	B	GRM39B473K16PT	K22124804		1-	A	H4
C 1172	CHIP CAP.	0.001uF	50V	B	GRM188B11H102KA01D	K22174821		1-	A	I6
C 1173	CHIP CAP.	0.047uF	16V	B	GRM39B473K16PT	K22124804		1-	A	H4
C 1174	CHIP TA.CAP.	1uF	16V		TESVA1C105M1-8R	K78120009		1-	A	I4
C 1175	CHIP TA.CAP.	4.7uF	16V		TEMSVA1C475M-8R	K78120031		1-	A	I4
C 1176	CHIP CAP.	0.01uF	25V	B	GRM39B103K25PT	K22144803		1-	A	A2
C 1177	CHIP TA.CAP.	1uF	16V		TESVA1C105M1-8R	K78120009		1-	A	I4
C 1178	CHIP CAP.	0.01uF	25V	B	GRM39B103K25PT	K22144803		1-	A	H5
C 1179	CHIP TA.CAP.	10uF	10V		TEMSVA1A106M-8R	K78100028		1-	A	B2
C 1180	CHIP TA.CAP.	2.2uF	16V		TEMSVA1C225M-8R	K78120015		1-	A	H5
C 1181	CHIP CAP.	0.01uF	25V	B	GRM39B103K25PT	K22144803		1-	A	J6
C 1183	CHIP CAP.	0.022uF	25V	B	GRM39B223K25PT	K22144807		1-	A	B2
C 1184	CHIP CAP.	0.022uF	25V	B	GRM39B223K25PT	K22144807		1-	A	J6
C 1185	CHIP CAP.	68pF	50V	CH	GRM1882C1H680JA01D	K22174231		1-	A	I5
C 1186	CHIP CAP.	0.022uF	25V	B	GRM39B223K25PT	K22144807		1-	A	H5
C 1187	CHIP CAP.	56pF	50V	CH	GRM1882C1H560JA01D	K22174229		1-	A	I5
C 1189	CHIP CAP.	100pF	50V	CH	GRM1882C1H101JA01D	K22174235		1-	A	J6
C 1190	CHIP TA.CAP.	10uF	16V		TEMSVB21C106M-8R	K78120025		1-	A	I5
C 1191	CHIP CAP.	0.022uF	25V	B	GRM39B223K25PT	K22144807		1-	A	I6
C 1192	CHIP CAP.	0.022uF	25V	B	GRM39B223K25PT	K22144807		1-	A	I5
C 1193	CHIP CAP.	68pF	50V	CH	GRM1882C1H680JA01D	K22174231		1-	A	I5
C 1194	CHIP CAP.	0.022uF	25V	B	GRM39B223K25PT	K22144807		1-	A	I6
C 1195	CHIP CAP.	0.022uF	25V	B	GRM39B223K25PT	K22144807		1-	A	C5
C 1196	CHIP CAP.	0.001uF	50V	B	GRM188B11H102KA01D	K22174821		1-	A	I6
C 1197	CHIP CAP.	12pF	50V	CH	GRM1882C1H120JA01D	K22174213		1-	A	I6
C 1198	CHIP CAP.	0.022uF	25V	B	GRM39B223K25PT	K22144807		1-	A	I6

MAIN Unit

Parts List

REF.	DESCRIPTION	VALUE	V/W	TOL.	MFR'S DESIG	VXSTD P/N	VERS.	LOT.	SIDE	LAY ADR
C 1199	CHIP CAP.	0.022uF	25V	B	GRM39B223K25PT	K22144807		1-	A	H7
C 1200	CHIP CAP.	0.022uF	25V	B	GRM39B223K25PT	K22144807		1-	A	I7
C 1201	CHIP CAP.	10pF	50V	CH	GRM1882C1H100JA01D	K22174211		1-	A	I7
C 1202	CHIP CAP.	0.022uF	25V	B	GRM39B223K25PT	K22144807		1-	A	H5
C 1203	CHIP CAP.	0.022uF	25V	B	GRM39B223K25PT	K22144807		1-	A	I6
C 1204	CHIP CAP.	0.022uF	25V	B	GRM39B223K25PT	K22144807		1-	A	I6
C 1205	CHIP CAP.	0.022uF	25V	B	GRM39B223K25PT	K22144807		1-	A	C5
C 1206	CHIP CAP.	0.022uF	25V	B	GRM39B223K25PT	K22144807		1-	A	I6
C 1207	CHIP CAP.	0.022uF	25V	B	GRM39B223K25PT	K22144807		1-	A	H7
C 1208	CHIP TA.CAP.	10uF	10V		TEMSVA1A106M-8R	K78100028		1-	A	I7
C 1209	CHIP CAP.	0.022uF	25V	B	GRM39B223K25PT	K22144807		1-	A	H6
C 1210	CHIP CAP.	2pF	50V	CK	GRM1884C1H2R0CZ01D	K22174203		1-	A	H7
C 1211	CHIP CAP.	0.022uF	25V	B	GRM39B223K25PT	K22144807		1-	A	H5
C 1212	CHIP TA.CAP.	22uF	10V		TEMSVB21A226M-8R	K78100029		1-	A	I6
C 1213	CHIP TA.CAP.	10uF	10V		TEMSVA1A106M-8R	K78100028		1-	A	B5
C 1214	CHIP TA.CAP.	0.22uF	35V		TESVA1V224M1-8R	K78160027		1-	A	I7
C 1215	CHIP TA.CAP.	1uF	35V		TEMSVA1V105M-8R	K78160032		1-	A	I7
C 1216	CHIP CAP.	0.01uF	25V	B	GRM39B103K25PT	K22144803		1-	A	I7
C 1217	CHIP CAP.	0.022uF	25V	B	GRM39B223K25PT	K22144807		1-	A	B4
C 1218	CHIP CAP.	15pF	50V	CH	GRM1882C1H150JA01D	K22174215		1-	A	H7
C 1219	CHIP CAP.	0.001uF	50V	B	GRM188B11H102KA01D	K22174821		1-	A	H6
C 1220	CHIP CAP.	0.001uF	50V	B	GRM188B11H102KA01D	K22174821		1-	A	H7
C 1222	CHIP CAP.	0.022uF	25V	B	GRM39B223K25PT	K22144807		1-	A	H6
C 1223	CHIP TA.CAP.	10uF	16V		TEMSVB21C106M-8R	K78120025		1-	A	H5
C 1224	CHIP CAP.	0.022uF	25V	B	GRM39B223K25PT	K22144807		1-	A	H6
C 1225	CHIP CAP.	0.022uF	25V	B	GRM39B223K25PT	K22144807		1-	A	H6
C 1226	CHIP CAP.	0.022uF	25V	B	GRM39B223K25PT	K22144807		1-	A	G7
C 1227	CHIP TA.CAP.	10uF	16V		TEMSVB21C106M-8R	K78120025		1-	A	H6
C 1228	CHIP CAP.	0.022uF	25V	B	GRM39B223K25PT	K22144807		1-	A	G6
C 1229	CHIP CAP.	0.022uF	25V	B	GRM39B223K25PT	K22144807		1-	A	H6
C 1230	CHIP CAP.	0.022uF	25V	B	GRM39B223K25PT	K22144807		1-	A	G7
C 1231	CHIP CAP.	0.5pF	50V	CK	GRM1884C1HR50CZ01D	K22174201		1-	A	G6
C 1232	CHIP CAP.	0.022uF	25V	B	GRM39B223K25PT	K22144807		1-	A	H6
C 1233	CHIP CAP.	0.022uF	25V	B	GRM39B223K25PT	K22144807		1-	A	G6
C 1234	CHIP TA.CAP.	4.7uF	25V		TEMSVB21E475M-8R	K78140019		1-	A	I5
C 1235	CHIP CAP.	0.033uF	16V	R	GRM188R11C333KA01D	K22124801		1-	A	G6
C 1236	CHIP CAP.	0.001uF	50V	B	GRM188B11H102KA01D	K22174821		1-	A	G6
C 1237	CHIP CAP.	0.01uF	25V	B	GRM39B103K25PT	K22144803		1-	A	H6
C 1238	CHIP CAP.	100pF	50V	CH	GRM1882C1H101JA01D	K22174235		1-	A	G7
C 1239	CHIP CAP.	0.022uF	25V	B	GRM39B223K25PT	K22144807		1-	A	G6
C 1240	CHIP CAP.	0.022uF	25V	B	GRM39B223K25PT	K22144807		1-	A	G6
C 1241	CHIP CAP.	0.022uF	25V	B	GRM39B223K25PT	K22144807		1-	A	E4
C 1242	CHIP CAP.	0.022uF	25V	B	GRM39B223K25PT	K22144807		1-	A	G6
C 1243	CHIP CAP.	0.022uF	25V	B	GRM39B223K25PT	K22144807		1-	A	G7
C 1244	AL.ELECTRO.CAP.	470uF	16V		RE3-16V471MG3#	K40129066		1-	A	B6
C 1245	CHIP CAP.	0.022uF	25V	B	GRM39B223K25PT	K22144807		1-	A	G6
C 1246	CHIP CAP.	0.022uF	25V	B	GRM39B223K25PT	K22144807		1-	A	G6
C 1247	CHIP TA.CAP.	10uF	10V		TEMSVA1A106M-8R	K78100028		1-	A	F6
C 1249	CHIP CAP.	0.1uF	16V	B	GRM188B11C104KA01D	K22124805		1-	A	A7
C 1250	AL.ELECTRO.CAP.	470uF	16V		RE3-16V471MG3#	K40129066		1-	A	B6
C 1251	AL.ELECTRO.CAP.	470uF	16V		RE3-16V471MG3#	K40129066		1-	A	A7
C 1252	CHIP CAP.	0.022uF	25V	B	GRM39B223K25PT	K22144807		1-	A	F6
C 1253	CHIP CAP.	0.022uF	25V	B	GRM39B223K25PT	K22144807		1-	A	F7
C 1254	CHIP CAP.	0.01uF	25V	B	GRM39B103K25PT	K22144803		1-	A	B6
C 1255	CHIP CAP.	0.022uF	25V	B	GRM39B223K25PT	K22144807		1-	A	F6
C 1256	CHIP CAP.	0.1uF	16V	B	GRM188B11C104KA01D	K22124805		1-	A	F7
C 1257	AL.ELECTRO.CAP.	47uF	16V		ECEV1CA470SP	K48120005		1-	A	A7
C 1259	CHIP CAP.	0.022uF	25V	B	GRM39B223K25PT	K22144807		1-	A	F7
C 1260	CHIP CAP.	0.1uF	16V	B	GRM188B11C104KA01D	K22124805		1-	A	F7

REF.	DESCRIPTION	VALUE	V/W	TOL.	MFR'S DESIG	VXSTD P/N	VERS.	LOT.	SIDE	LAY ADR
C 1261	CHIP CAP.	0.1uF	16V	B	GRM188B11C104KA01D	K22124805		1-	A	F7
C 1262	CHIP TA.CAP.	10uF	10V		TEMSVA1A106M-8R	K78100028		1-	A	F7
C 1263	CHIP CAP.	0.1uF	16V	B	GRM188B11C104KA01D	K22124805		1-	A	F7
C 1264	CHIP TA.CAP.	3.3uF	16V		TESVB21C335M8R	K78120010		1-	A	B7
C 1265	CHIP CAP.	0.01uF	25V	B	GRM39B103K25PT	K22144803		1-	A	F5
C 1266	CHIP CAP.	0.01uF	25V	B	GRM39B103K25PT	K22144803		1-	A	F5
C 1269	CHIP TA.CAP.	10uF	10V		TEMSVA1A106M-8R	K78100028		1-	A	F6
C 1270	CHIP TA.CAP.	10uF	10V		TEMSVA1A106M-8R	K78100028		1-	A	F6
C 1271	CHIP CAP.	0.022uF	25V	B	GRM39B223K25PT	K22144807		1-	A	F6
C 1272	CHIP CAP.	0.022uF	25V	B	GRM39B223K25PT	K22144807		1-	A	F6
C 1273	CHIP TA.CAP.	10uF	10V		TEMSVA1A106M-8R	K78100028		1-	A	E6
C 1276	CHIP CAP.	0.022uF	25V	B	GRM39B223K25PT	K22144807		1-	A	E6
C 1277	CHIP CAP.	0.047uF	16V	B	GRM39B473K16PT	K22124804		1-	A	D5
C 1278	FILM CAP.	0.039uF	16V		ECHU1C393JX5	K57120023		1-	A	F5
C 1279	CHIP CAP.	0.01uF	25V	B	GRM39B103K25PT	K22144803		1-	A	E5
C 1280	CHIP TA.CAP.	1uF	16V		TESVA1C105M1-8R	K78120009		1-	A	D5
C 1281	CHIP CAP.	47pF	50V	CH	GRM1882C1H470JA01D	K22174227		1-	A	F6
C 1282	CHIP CAP.	47pF	50V	CH	GRM1882C1H470JA01D	K22174227		1-	A	F6
C 1283	CHIP CAP.	100pF	50V	CH	GRM1882C1H101JA01D	K22174235		1-	A	F5
C 1284	FILM CAP.	0.082uF	16V		ECHU1C823JX5	K57120024		1-	A	F5
C 1285	CHIP TA.CAP.	10uF	10V		TEMSVA1A106M-8R	K78100028		1-	A	D5
C 1286	CHIP CAP.	27pF	50V	CH	GRM1882C1H270JA01D	K22174221		1-	A	E5
C 1287	CHIP TA.CAP.	10uF	10V		TEMSVA1A106M-8R	K78100028		1-	A	F6
C 1288	CHIP CAP.	22pF	50V	CH	GRM1882C1H220JA01D	K22174219		1-	A	E5
C 1289	CHIP CAP.	22pF	50V	CH	GRM1882C1H220JA01D	K22174219		1-	A	E5
C 1290	CHIP CAP.	22pF	50V	CH	GRM1882C1H220JA01D	K22174219		1-	A	E5
C 1291	CHIP CAP.	0.01uF	25V	B	GRM39B103K25PT	K22144803		1-	A	E5
C 1292	CHIP CAP.	0.01uF	25V	B	GRM39B103K25PT	K22144803		1-	A	D5
C 1293	CHIP CAP.	10pF	50V	CH	GRM1882C1H100JA01D	K22174211		1-	A	E5
C 1294	CHIP CAP.	0.01uF	25V	B	GRM39B103K25PT	K22144803		1-	A	D5
C 1296	CHIP CAP.	0.022uF	25V	B	GRM39B223K25PT	K22144807		1-	A	F6
C 1298	FILM CAP.	0.0056uF	16V		ECHU1C562JX5	K57120022		1-	A	F5
C 1299	CHIP CAP.	0.0082uF	25V	B	GRM39B822M25PT	K22144801		1-	A	D7
C 1300	CHIP CAP.	0.0082uF	25V	B	GRM39B822M25PT	K22144801		1-	A	C7
C 1301	CHIP CAP.	0.01uF	25V	B	GRM39B103K25PT	K22144803		1-	A	F5
C 1302	CHIP CAP.	470pF	50V	CH	GRM1882C1H471JA01D	K22174249		1-	A	E5
C 1303	CHIP CAP.	0.01uF	25V	B	GRM39B103K25PT	K22144803		1-	A	E5
C 1304	CHIP CAP.	100pF	50V	CH	GRM1882C1H101JA01D	K22174235		1-	A	F5
C 1305	CHIP CAP.	0.01uF	25V	B	GRM39B103K25PT	K22144803		1-	A	G5
C 1306	CHIP CAP.	22pF	50V	CH	GRM1882C1H220JA01D	K22174219		1-	A	E5
C 1307	CHIP CAP.	22pF	50V	CH	GRM1882C1H220JA01D	K22174219		1-	A	E5
C 1308	FILM CAP.	0.0056uF	16V		ECHU1C562JX5	K57120022		1-	A	F5
C 1309	CHIP TA.CAP.	10uF	10V		TEMSVA1A106M-8R	K78100028		1-	A	E5
C 1310	CHIP CAP.	22pF	50V	CH	GRM1882C1H220JA01D	K22174219		1-	A	E5
C 1311	CHIP CAP.	0.1uF	16V	B	GRM188B11C104KA01D	K22124805		1-	A	D4
C 1312	CHIP CAP.	0.1uF	16V	B	GRM188B11C104KA01D	K22124805		1-	A	D6
C 1313	CHIP CAP.	0.01uF	25V	B	GRM39B103K25PT	K22144803		1-	A	E5
C 1315	CHIP TA.CAP.	10uF	10V		TEMSVA1A106M-8R	K78100028		1-	A	D4
C 1316	CHIP CAP.	0.0039uF	50V	B	GRM188B11H392KA01D	K22174830		1-	A	E7
C 1317	CHIP CAP.	1pF	50V	CK	GRM1884C1H1R0CZ01D	K22174202		1-	A	F5
C 1318	CHIP TA.CAP.	10uF	10V		TEMSVA1A106M-8R	K78100028		1-	A	E5
C 1319	CHIP CAP.	0.01uF	25V	B	GRM39B103K25PT	K22144803		1-	A	F5
C 1320	CHIP TA.CAP.	10uF	10V		TEMSVA1A106M-8R	K78100028		1-	A	D6
C 1321	CHIP CAP.	2pF	50V	CK	GRM1884C1H2R0CZ01D	K22174203		1-	A	G5
C 1323	CHIP CAP.	430pF	50V	CH	GRM1882C1H431JA01D	K22174256		1-	A	F7
C 1324	CHIP CAP.	430pF	50V	CH	GRM1882C1H431JA01D	K22174256		1-	A	F7
C 1325	CHIP CAP.	0.0033uF	50V	B	GRM188B11H332KA01D	K22174831		1-	A	E7
C 1326	CHIP CAP.	0.01uF	25V	B	GRM39B103K25PT	K22144803		1-	A	G5
C 1327	CHIP CAP.	390pF	50V	CH	GRM1882C1H391JA01D	K22174255		1-	A	C7

MAIN Unit

Parts List

REF.	DESCRIPTION	VALUE	V/W	TOL.	MFR'S DESIG	VXSTD P/N	VERS.	LOT.	SIDE	LAY ADR
C 1328	CHIP CAP.	390pF	50V	CH	GRM1882C1H391JA01D	K22174255		1-	A	D7
C 1329	CHIP CAP.	430pF	50V	CH	GRM1882C1H431JA01D	K22174256		1-	A	F7
C 1330	CHIP CAP.	430pF	50V	CH	GRM1882C1H431JA01D	K22174256		1-	A	F7
C 1331	CHIP CAP.	5pF	50V	CH	GRM1882C1H5R0CZ01D	K22174206		1-	A	G5
C 1332	CHIP TA.CAP.	10uF	10V		TEMSVA1A106M-8R	K78100028		1-	A	E7
C 1335	CHIP CAP.	0.022uF	25V	B	GRM39B223K25PT	K22144807		1-	A	E7
C 1336	AL.ELECTRO.CAP.	100uF	16V		RC2-16V101MGZ-T58	K46120007		1-	A	G4
C 1337	CHIP CAP.	0.0033uF	50V	B	GRM188B11H332KA01D	K22174831		1-	A	F7
C 1338	CHIP CAP.	0.0033uF	50V	B	GRM188B11H332KA01D	K22174831		1-	A	F7
C 1339	CHIP CAP.	0.01uF	25V	B	GRM39B103K25PT	K22144803		1-	A	G5
C 1341	CHIP CAP.	0.01uF	25V	B	GRM39B103K25PT	K22144803		1-	A	F5
C 1342	CHIP CAP.	0.001uF	50V	B	GRM188B11H102KA01D	K22174821		1-	A	G4
C 1343	CHIP TA.CAP.	10uF	10V		TEMSVA1A106M-8R	K78100028		1-	A	C7
C 1344	CHIP TA.CAP.	10uF	10V		TEMSVA1A106M-8R	K78100028		1-	A	D7
C 1346	CHIP CAP.	0.01uF	25V	B	GRM39B103K25PT	K22144803		1-	A	D6
C 1347	CHIP CAP.	47pF	50V	CH	GRM1882C1H470JA01D	K22174227		1-	A	D5
C 1348	CHIP CAP.	0.022uF	25V	B	GRM39B223K25PT	K22144807		1-	A	C7
C 1349	CHIP CAP.	0.022uF	25V	B	GRM39B223K25PT	K22144807		1-	A	D7
C 1350	CHIP CAP.	0.22uF	10V	B	GRM188B11A224KA01D	K22104801		1-	A	C7
C 1351	CHIP CAP.	0.22uF	10V	B	GRM188B11A224KA01D	K22104801		1-	A	D7
C 1352	CHIP CAP.	100pF	50V	CH	GRM1882C1H101JA01D	K22174235		1-	A	D7
C 1353	CHIP CAP.	100pF	50V	CH	GRM1882C1H101JA01D	K22174235		1-	A	D7
C 1354	CHIP CAP.	0.01uF	25V	B	GRM39B103K25PT	K22144803		1-	A	G4
C 1355	CHIP CAP.	0.01uF	25V	B	GRM39B103K25PT	K22144803		1-	A	F5
C 1356	CHIP CAP.	47pF	50V	CH	GRM1882C1H470JA01D	K22174227		1-	A	E6
C 1357	CHIP CAP.	47pF	50V	CH	GRM1882C1H470JA01D	K22174227		1-	A	E6
C 1358	CHIP CAP.	0.1uF	16V	B	GRM188B11C104KA01D	K22124805		1-	A	D2
C 1359	CHIP CAP.	100pF	50V	CH	GRM1882C1H101JA01D	K22174235		1-	A	D7
C 1360	CHIP CAP.	100pF	50V	CH	GRM1882C1H101JA01D	K22174235		1-	A	D7
C 1361	CHIP TA.CAP.	10uF	10V		TEMSVA1A106M-8R	K78100028		1-	A	E6
C 1362	CHIP TA.CAP.	10uF	10V		TEMSVA1A106M-8R	K78100028		1-	A	D7
C 1363	CHIP CAP.	47pF	50V	CH	GRM1882C1H470JA01D	K22174227		1-	A	G5
C 1364	CHIP TA.CAP.	10uF	10V		TEMSVA1A106M-8R	K78100028		1-	A	E6
C 1365	CHIP CAP.	0.01uF	25V	B	GRM39B103K25PT	K22144803		1-	A	D6
C 1366	CHIP CAP.	0.022uF	25V	B	GRM39B223K25PT	K22144807		1-	A	E6
C 1367	CHIP CAP.	0.022uF	25V	B	GRM39B223K25PT	K22144807		1-	A	D7
C 1368	CHIP TA.CAP.	10uF	10V		TEMSVA1A106M-8R	K78100028		1-	A	F6
C 1369	CHIP CAP.	0.022uF	25V	B	GRM39B223K25PT	K22144807		1-	A	E6
C 1370	CHIP TA.CAP.	10uF	10V		TEMSVA1A106M-8R	K78100028		1-	A	E7
C 1371	CHIP TA.CAP.	10uF	10V		TEMSVA1A106M-8R	K78100028		1-	A	E7
C 1372	CHIP CAP.	0.022uF	25V	B	GRM39B223K25PT	K22144807		1-	A	E7
C 1373	CHIP CAP.	0.022uF	25V	B	GRM39B223K25PT	K22144807		1-	A	F6
C 1374	CHIP CAP.	15pF	50V	UJ	GRM1883U1H150JZ01D	K22174312		1-	A	G4
C 1375	CHIP CAP.	22pF	50V	CH	GRM1882C1H220JA01D	K22174219		1-	A	G5
C 1376	CHIP CAP.	15pF	50V	CH	GRM1882C1H150JA01D	K22174215		1-	A	G4
C 1377	CHIP CAP.	10pF	50V	CH	GRM1882C1H100JA01D	K22174211		1-	A	F5
C 1378	CHIP CAP.	0.022uF	25V	B	GRM39B223K25PT	K22144807		1-	A	E7
C 1379	CHIP CAP.	0.0012uF	50V	B	GRM188B11H122KA01D	K22174810		1-	A	E6
C 1380	CHIP CAP.	0.0012uF	50V	B	GRM188B11H122KA01D	K22174810		1-	A	F6
C 1381	CHIP CAP.	56pF	50V	CH	GRM1882C1H560JA01D	K22174229		1-	A	D6
C 1382	CHIP TA.CAP.	10uF	10V		TEMSVA1A106M-8R	K78100028		1-	A	D6
C 1383	CHIP CAP.	33pF	50V	CH	GRM1882C1H330JA01D	K22174223		1-	A	G4
C 1384	CHIP CAP.	33pF	50V	UJ	GRM1883U1H330JZ01D	K22174320		1-	A	G4
C 1385	CHIP CAP.	0.022uF	25V	B	GRM39B223K25PT	K22144807		1-	A	D6
C 1386	CHIP CAP.	27pF	50V	CH	GRM1882C1H270JA01D	K22174221		1-	A	F4
C 1387	CHIP CAP.	0.22uF	10V	B	GRM188B11A224KA01D	K22104801		1-	A	E7
C 1388	CHIP CAP.	0.01uF	25V	B	GRM39B103K25PT	K22144803		1-	A	G5
C 1389	CHIP CAP.	68pF	50V	CH	GRM1882C1H680JA01D	K22174231		1-	A	G5
C 1390	CHIP CAP.	33pF	50V	CH	GRM1882C1H330JA01D	K22174223		1-	A	G4

REF.	DESCRIPTION	VALUE	V/W	TOL.	MFR'S DESIG	VXSTD P/N	VERS.	LOT.	SIDE	LAY ADR
C 1391	CHIP CAP.	39pF	50V	CH	GRM1882C1H390JA01D	K22174225		1-	A	G5
C 1392	CHIP CAP.	0.01uF	25V	B	GRM39B103K25PT	K22144803		1-	A	E5
C 1393	CHIP CAP.	0.01uF	25V	B	GRM39B103K25PT	K22144803		1-	A	J4
C 1394	CHIP CAP.	0.01uF	25V	B	GRM39B103K25PT	K22144803		1-	A	J4
C 1395	CHIP CAP.	1uF	10V	B	GRM40B105K10PT	K22100802		1-	A	J2
C 1396	CHIP CAP.	0.01uF	25V	B	GRM39B103K25PT	K22144803		1-	A	E6
C 1397	CHIP CAP.	68pF	50V	CH	GRM1882C1H680JA01D	K22174231		1-	A	G5
C 1398	CHIP CAP.	0.01uF	25V	B	GRM39B103K25PT	K22144803		1-	A	J4
C 1399	CHIP CAP.	0.1uF	16V	B	GRM188B11C104KA01D	K22124805		1-	A	J2
C 1400	CHIP CAP.	39pF	50V	CH	GRM1882C1H390JA01D	K22174225		1-	A	H5
C 1401	CHIP CAP.	43pF	50V	CH	GRM1882C1H430JZ01D	K22174226		1-	A	E5
C 1402	CHIP CAP.	0.01uF	25V	B	GRM39B103K25PT	K22144803		1-	A	J2
C 1403	CHIP CAP.	100pF	50V	CH	GRM1882C1H101JA01D	K22174235		1-	A	J3
C 1404	CHIP CAP.	0.01uF	25V	B	GRM39B103K25PT	K22144803		1-	A	J4
C 1405	CHIP CAP.	8pF	50V	CH	GRM1882C1H8R0DZ01D	K22174209		1-	A	E6
C 1406	CHIP CAP.	100pF	50V	CH	GRM1882C1H101JA01D	K22174235		1-	A	J3
C 1407	CHIP CAP.	0.01uF	25V	B	GRM39B103K25PT	K22144803		1-	A	J4
C 1408	CHIP CAP.	0.01uF	25V	B	GRM39B103K25PT	K22144803		1-	A	J2
C 1409	CHIP CAP.	68pF	50V	CH	GRM1882C1H680JA01D	K22174231		1-	A	H5
C 1410	CHIP CAP.	56pF	50V	CH	GRM1882C1H560JA01D	K22174229		1-	A	E5
C 1411	CHIP CAP.	24pF	50V	CH	GRM1882C1H240JZ01D	K22174220		1-	A	E6
C 1412	CHIP CAP.	0.01uF	25V	B	GRM39B103K25PT	K22144803		1-	A	J3
C 1413	CHIP CAP.	0.01uF	25V	B	GRM39B103K25PT	K22144803		1-	A	J4
C 1414	CHIP CAP.	0.01uF	25V	B	GRM39B103K25PT	K22144803		1-	A	J2
C 1415	CHIP CAP.	0.01uF	25V	B	GRM39B103K25PT	K22144803		1-	A	J2
C 1416	CHIP CAP.	0.01uF	25V	B	GRM39B103K25PT	K22144803		1-	A	J2
C 1417	CHIP CAP.	0.01uF	25V	B	GRM39B103K25PT	K22144803		1-	A	J3
C 1418	FILM CAP.	0.0056uF	16V		ECHU1C562JX5	K57120022		1-	A	F5
C 1419	CHIP CAP.	0.01uF	25V	B	GRM39B103K25PT	K22144803		1-	A	J3
C 1420	CHIP CAP.	39pF	50V	CH	GRM1882C1H390JA01D	K22174225		1-	A	H5
C 1421	CHIP CAP.	33pF	50V	CH	GRM1882C1H330JA01D	K22174223		1-	A	E5
C 1422	CHIP CAP.	0.01uF	25V	B	GRM39B103K25PT	K22144803		1-	A	J4
C 1423	CHIP CAP.	0.01uF	25V	B	GRM39B103K25PT	K22144803		1-	A	J3
C 1424	CHIP CAP.	0.01uF	25V	B	GRM39B103K25PT	K22144803		1-	A	J3
C 1426	CHIP CAP.	0.001uF	50V	B	GRM188B11H102KA01D	K22174821		1-	A	D5
C 1427	CHIP CAP.	0.022uF	25V	B	GRM39B223K25PT	K22144807		1-	A	C4
C 1428	CHIP CAP.	0.01uF	25V	B	GRM39B103K25PT	K22144803		1-	A	A2
C 1429	CHIP CAP.	0.01uF	25V	B	GRM39B103K25PT	K22144803		1-	A	A2
C 1431	CHIP TA.CAP.	10uF	10V		TEMSVA1A106M-8R	K78100028		1-	A	C2
C 1432	CHIP CAP.	33pF	50V	CH	GRM1882C1H330JA01D	K22174223		1-	A	H4
C 1433	CHIP CAP.	15pF	50V	CH	GRM1882C1H150JA01D	K22174215		1-	A	I6
C 1434	CHIP CAP.	0.01uF	25V	B	GRM39B103K25PT	K22144803		1-	A	A3
C 1435	CHIP CAP.	0.01uF	25V	B	GRM39B103K25PT	K22144803		1-	A	A3
C 1436	CHIP CAP.	0.01uF	25V	B	GRM39B103K25PT	K22144803		1-	A	A3
C 1437	CHIP CAP.	0.01uF	25V	B	GRM39B103K25PT	K22144803		1-	A	J4
C 1438	CHIP CAP.	0.0022uF	50V	B	GRM188B11H222KA01D	K22174813		1-	A	C7
C 1439	CHIP CAP.	0.0022uF	50V	B	GRM188B11H222KA01D	K22174813		1-	A	D7
C 1440	CHIP CAP.	1uF	10V	B	GRM40B105K10PT	K22100802		1-	A	E7
C 1441	CHIP CAP.	1uF	10V	B	GRM40B105K10PT	K22100802		1-	A	E7
C 1442	CHIP CAP.	0.1uF	16V	B	GRM188B11C104KA01D	K22124805		1-	A	D6
C 1443	CHIP TA.CAP.	10uF	10V		TEMSVA1A106M-8R	K78100028		1-	A	D6
C 1444	CHIP CAP.	0.022uF	25V	B	GRM39B223K25PT	K22144807		1-	A	C6
C 1445	CHIP CAP.	1uF	10V	B	GRM40B105K10PT	K22100802		1-	A	C7
C 1446	CHIP CAP.	1uF	10V	B	GRM40B105K10PT	K22100802		1-	A	D7
C 1447	CHIP CAP.	0.1uF	16V	B	GRM188B11C104KA01D	K22124805		1-	A	G6
C 1448	CHIP CAP.	470pF	50V	CH	GRM1882C1H471JA01D	K22174249		1-	A	E5
C 1449	CHIP CAP.	470pF	50V	CH	GRM1882C1H471JA01D	K22174249		1-	A	J2
C 1450	CHIP TA.CAP.	3.3uF	16V		TESVB21C335M8R	K78120010		1-	A	B6
C 1451	CHIP CAP.	0.001uF	50V	B	GRM188B11H102KA01D	K22174809		1-	A	B7

MAIN Unit

Parts List

REF.	DESCRIPTION	VALUE	V/W	TOL.	MFR'S DESIG		VERS.	LOT.	SIDE	LAY ADR
C 1452	CHIP TA.CAP.	3.3uF	16V		TESVB21C335M8R	K78120010		1-	A	B6
C 1453	CHIP CAP.	0.0039uF	50V	B	GRM188B11H392KA01D	K22174830		1-	A	E7
C 1454	CHIP CAP.	0.0033uF	50V	B	GRM188B11H332KA01D	K22174831		1-	A	E7
C 1455	CHIP CAP.	0.022uF	25V	B	GRM39B223K25PT	K22144807		1-	A	E7
C 1456	CHIP TA.CAP.	47uF	4V		SK7-0G476M-RA	K78060048		1-	A	E7
C 1457	CHIP TA.CAP.	10uF	10V		TEMSVA1A106M-8R	K78100028		1-	A	D7
C 1458	CHIP CAP.	0.022uF	25V	B	GRM39B223K25PT	K22144807		1-	A	D7
C 1459	CHIP CAP.	0.001uF	50V	B	GRM188B11H102KA01D	K22174809		1-	A	B7
C 1463	FILM CAP.	0.0056uF	16V		ECHU1C562JX5	K57120022		1-		
C 1464	FILM CAP.	0.0056uF	16V		ECHU1C562JX5	K57120022		1-		
CF1001	CERAMIC FILTER				SFSRA6M50DF00-B0	H3900560		1-	A	E4
D 1001	DIODE				IMN10 T108	G2070078		1-	A	B7
D 1002	DIODE				RB521S-30 TE61	G2070642		1-	A	A4
D 1003	DIODE				MC2848-T11-1	G2070694		1-	A	H2
D 1004	DIODE				RB060L-40 TE25	G2070744		1-	A	A4
D 1005	DIODE				RB521S-30 TE61	G2070642		1-	A	A4
D 1006	DIODE				RLS245 TE-11	G2070834		1-	A	I1
D 1007	DIODE				RLS245 TE-11	G2070834		1-	A	I1
D 1008	DIODE				RLS245 TE-11	G2070834		1-	A	J1
D 1009	DIODE				RLS245 TE-11	G2070834		1-	A	J1
D 1010	DIODE				1SS356TW11	G2070468		1-	A	H2
D 1011	DIODE				1SV271 TPH3	G2070476		1-	A	I2
D 1012	DIODE				1SV271 TPH3	G2070476		1-	A	F2
D 1013	DIODE				1SV271 TPH3	G2070476		1-	A	F2
D 1014	DIODE				1SV271 TPH3	G2070476		1-	A	G2
D 1015	DIODE				1SV271 TPH3	G2070476		1-	A	G2
D 1016	DIODE				1SV271 TPH3	G2070476		1-	A	H2
D 1017	DIODE				1SV271 TPH3	G2070476		1-	A	H2
D 1018	DIODE				1SV271 TPH3	G2070476		1-	A	I2
D 1019	DIODE				1SV271 TPH3	G2070476		1-	A	I2
D 1020	DIODE				1SS356TW11	G2070468		1-	A	F3
D 1021	DIODE				1SS356TW11	G2070468		1-	A	G3
D 1022	DIODE				1SS356TW11	G2070468		1-	A	G3
D 1023	DIODE				1SS356TW11	G2070468		1-	A	H3
D 1024	DIODE				1SS356TW11	G2070468		1-	A	I3
D 1025	DIODE				1SS356TW11	G2070468		1-	A	I3
D 1026	DIODE				1SS356TW11	G2070468		1-	A	H3
D 1027	DIODE				1SS356TW11	G2070468		1-	A	F3
D 1028	DIODE				1SS356TW11	G2070468		1-	A	I4
D 1029	DIODE				1SS356TW11	G2070468		1-	A	H4
D 1030	DIODE				1SV271 TPH3	G2070476		1-	A	H4
D 1031	DIODE				DAN235U TL	G2070176		1-	A	I5
D 1032	DIODE				HSB88WSTR	G2070290		1-	A	I6
D 1033	DIODE				DAN235U TL	G2070176		1-	A	I7
D 1034	DIODE				DAN235U TL	G2070176		1-	A	H7
D 1035	DIODE				MC2848-T11-1	G2070694		1-	A	F4
D 1036	DIODE				HZM7.5NB3-TL-E	G2070786		1-	A	H6
D 1037	LED				SML-210MTT86	G2070524		1-	A	C4
D 1038	LED				SML-210MTT86	G2070524		1-	A	F1
D 1039	DIODE				UDZS TE-17 5.6B	G2070910		1-	A	I7
D 1040	DIODE				RB521S-30 TE61	G2070642		1-	A	I7
D 1041	DIODE				1SS356TW11	G2070468		1-	A	H6
D 1042	DIODE				1SS356TW11	G2070468		1-	A	H6
D 1043	LED				SML-210MTT86	G2070524		1-	A	F5
D 1044	DIODE				MC2850-T11-1	G2070704		1-	A	C7
D 1045	DIODE				MC2850-T11-1	G2070704		1-	A	D7
D 1046	DIODE				DAP236U T106	G2070592		1-	A	G4
D 1047	DIODE				HVU359TRF	G2070452		1-	A	G4
D 1048	DIODE				HVU359TRF	G2070452		1-	A	H4

REF.	DESCRIPTION	VALUE	V/W	TOL.	MFR'S DESIG	VXSTD P/N	VERS.	LOT.	SIDE	LAY ADR
D 1049	DIODE				HVU359TRF	G2070452		1-	A	F4
D 1050	DIODE				HVU359TRF	G2070452		1-	A	F4
D 1051	DIODE				HVU359TRF	G2070452		1-	A	G4
D 1052	DIODE				HVU359TRF	G2070452		1-	A	H4
D 1053	DIODE				HVU359TRF	G2070452		1-	A	F4
D 1054	DIODE				HVU359TRF	G2070452		1-	A	F4
D 1055	DIODE				D1F20-4063	G2070474		1-	A	J3
D 1056	DIODE				HZM27WA-TR	G2070530		1-	A	J3
D 1059	LED				SML-210MTT86	G2070524		1-	A	E1
D 1060	LED				SML-210VTT86	G2070768		1-	A	E1
D 1061	LED				SML-210DTT86	G2070772		1-	A	E1
D 1062	DIODE				RB521S-30 TE61	G2070642		1-	A	A2
D 1063	DIODE				RB521S-30 TE61	G2070642		1-	A	C2
D 1064	DIODE				HZM7.5NB3-TL-E	G2070786		1-	A	H5
D 1065	DIODE				UDZS TE-17 6.8B	G2070888		1-	A	G6
D 1067	DIODE				BAS316	G2070716		1-	A	A2
FB1001	CHIP COIL				BLM21PG300SN1D	L1690840		1-	A	J3
J 1001	CONNECTOR				TMP-S01X-C1	P1091254		1-	A	I1
J 1002	CONNECTOR				TMP-S01X-C1	P1091254		1-	A	G1
J 1003	CONNECTOR				30FLT-SM1-TB	P1091142		1-	A	A2
J 1004	CONNECTOR				30FLT-SM1-TB	P1091142		1-	A	A3
J 1005	CONNECTOR				SB20-08WS	P0090615		1-	A	C7
J 1008	CONNECTOR				SB20-13WS	P0090620		1-	A	H1
J 1014	CONNECTOR				SG8035#01	P1090350		1-	A	K6
J 1015	CONNECTOR				SG8035#01	P1090350		1-	A	K5
J 1016	CONNECTOR				TCS7705-5120177	P1091244		1-	A	J4
J 1017	CONNECTOR				CSK-M50-06 R41-0599D	P1090925		1-	A	J2
J 1018	CONNECTOR				M50-08-30-434S R41-0599F	P1091132		1-	A	J3
J 1019	CONNECTOR				09FMN-BMTTN-TFT	P1091089		1-	A	B5
JP1003	CHIP RES.	0	1/16W	5%	RMC1/16 000JATP	J24185000		1-	A	D5
JP1006	CHIP RES.	0	1/16W	5%	RMC1/16 000JATP	J24185000		1-	A	A4
L 1001	M.RFC	100uH			FLC32T-101J	L1690227		1-	A	B7
L 1002	M.RFC	100uH			FLC32T-101J	L1690227		1-	A	B7
L 1003	M.RFC	100uH			FLC32T-101J	L1690227		1-	A	B7
L 1004	M.RFC	100uH			FLC32T-101J	L1690227		1-	A	C7
L 1005	M.RFC	180uH			FLC32T-181J	L1690230		1-	A	H2
L 1006	M.RFC	100uH			FLC32T-101J	L1690227		1-	A	J1
L 1007	M.RFC	470uH			FLC32T-471J	L1690235		1-	A	F2
L 1008	CHIP COIL	27uH			LQH32MN270K23L	L1690092		1-	A	F2
L 1009	CHIP COIL	18uH			LQH32MN180K23L	L1690090		1-	A	G2
L 1010	CHIP COIL	10uH			LQH32MN100K23L	L1690087		1-	A	G2
L 1011	CHIP COIL	5.6uH			LQH32MN5R6K23L	L1690084		1-	A	H2
L 1012	CHIP COIL	3.9uH			LQH32MN3R9M23L	L1690082		1-	A	H2
L 1013	CHIP COIL	2.2uH		2%	C2520C-2R2G	L1691313		1-	A	H2
L 1014	CHIP COIL	1.5uH		2%	C2520C-1R5G	L1691311		1-	A	I2
L 1015	CHIP COIL	68uH			LQH32MN680K23L	L1690097		1-	A	F3
L 1016	CHIP COIL	39uH			LQH32MN390K23L	L1690094		1-	A	G3
L 1017	CHIP COIL	27uH			LQH32MN270K23L	L1690092		1-	A	G3
L 1018	CHIP COIL	22uH			LQH31MN220J03L	L1691005		1-	A	H3
L 1019	CHIP COIL	12uH			LQH31MN120J03L	L1691002		1-	A	H3
L 1020	CHIP COIL	6.8uH			C2520F-6R8K	L1690594		1-	A	I3
L 1021	CHIP COIL	4.7uH		2%	C2520C-4R7G	L1691317		1-	A	I3
L 1022	CHIP COIL	68uH			LQH32MN680K23L	L1690097		1-	A	F3
L 1023	CHIP COIL	15uH			LQH32MN150K23L	L1690089		1-	A	F3
L 1024	CHIP COIL	10uH			LQH32MN100K23L	L1690087		1-	A	G3
L 1025	CHIP COIL	5.6uH			LQH32MN5R6K23L	L1690084		1-	A	G3
L 1026	CHIP COIL	3.3uH			LQH32MN3R3K23L	L1690081		1-	A	H3
L 1027	CHIP COIL	1.8uH			LQH32MN1R8K23L	L1690078		1-	A	H3
L 1028	CHIP COIL	1.2uH		2%	C2520C-1R2G	L1691310		1-	A	H3

MAIN Unit

Parts List

REF.	DESCRIPTION	VALUE	V/W	TOL.	MFR'S DESIG	VXSTD P/N	VERS.	LOT.	SIDE	LAY ADR
L 1029	CHIP COIL	1uH		2%	C2520C-1R0G	L1691309		1-	A	I3
L 1030	CHIP COIL	68uH			LQH32MN680K23L	L1690097		1-	A	F3
L 1031	CHIP COIL	68uH			LQH32MN680K23L	L1690097		1-	A	F3
L 1032	CHIP COIL	39uH			LQH32MN390K23L	L1690094		1-	A	G3
L 1033	CHIP COIL	27uH			LQH32MN270K23L	L1690092		1-	A	G3
L 1034	CHIP COIL	18uH			LQH31MN180J03L	L1691004		1-	A	H3
L 1035	CHIP COIL	12uH			LQH31MN120J03L	L1691002		1-	A	H3
L 1036	CHIP COIL	6.8uH			C2520F-6R8K	L1690594		1-	A	I3
L 1037	CHIP COIL	4.7uH		2%	C2520C-4R7G	L1691317		1-	A	I3
L 1038	M.RFC	470uH			FLC32T-471J	L1690235		1-	A	F3
L 1039	CHIP COIL	27uH			LQH32MN270K23L	L1690092		1-	A	F3
L 1040	CHIP COIL	18uH			LQH32MN180K23L	L1690090		1-	A	G3
L 1041	CHIP COIL	10uH			LQH32MN100K23L	L1690087		1-	A	G3
L 1042	CHIP COIL	5.6uH			LQH32MN5R6K23L	L1690084		1-	A	H3
L 1043	CHIP COIL	3.9uH			LQH32MN3R9M23L	L1690082		1-	A	H3
L 1044	CHIP COIL	2.2uH		2%	C2520C-2R2G	L1691313		1-	A	I3
L 1045	CHIP COIL	1.5uH		2%	C2520C-1R5G	L1691311		1-	A	I3
L 1046	M.RFC	100uH			FLC32T-101J	L1690227		1-	A	B4
L 1047	CHIP COIL	5.6uH			LQH31MN5R6J03L	L1690999		1-	A	I4
L 1048	M.RFC	10uH			FLC32T-100J	L1690215		1-	A	J6
L 1049	CHIP COIL	0.18uH			LQH32MNR18M23L	L1690069		1-	A	I5
L 1050	CHIP COIL	10uH			LQH32MN100K23L	L1690087		1-	A	J5
L 1051	CHIP COIL	0.22uH			C2520C-R22J	L1690548		1-	A	I6
L 1052	CHIP COIL	1mH			LQH43MN102K03L	L1690108		1-	A	I7
L 1053	M.RFC	180uH			FLC32T-181J	L1690230		1-	A	H5
L 1054	M.RFC	180uH			FLC32T-181J	L1690230		1-	A	H6
L 1055	M.RFC	180uH			FLC32T-181J	L1690230		1-	A	H6
L 1056	M.RFC	180uH			FLC32T-181J	L1690230		1-	A	H6
L 1057	M.RFC	180uH			FLC32T-181J	L1690230		1-	A	F7
L 1058	M.RFC	180uH			FLC32T-181J	L1690230		1-	A	F7
L 1059	M.RFC	100uH			FLC32T-101J	L1690227		1-	A	F6
L 1060	M.RFC	100uH			FLC32T-101J	L1690227		1-	A	D5
L 1063	M.RFC	3.3uH			FLC32T-3R3K	L1690209		1-	A	G4
L 1064	M.RFC	3.3uH			FLC32T-3R3K	L1690209		1-	A	G4
L 1065	CHIP COIL	2.2uH			C2520C-2R2K	L1690731		1-	A	G5
L 1066	COIL 10RF				0.49U	L0021398		1-	A	G4
L 1067	COIL 10RF				0.36U	L0021400		1-	A	G4
L 1068	M.RFC	4.7uH			FLC32T-4R7K	L1690211		1-	A	G4
L 1069	M.RFC	4.7uH			FLC32T-4R7K	L1690211		1-	A	F4
L 1070	CHIP COIL	0.15uH			C2520C-R15J	L1690546		1-	A	G5
L 1071	CHIP COIL	0.15uH			C2520C-R15J	L1690546		1-	A	G5
L 1072	M.RFC	4.7uH			FLC32T-4R7K	L1690211		1-	A	H5
L 1073	M.RFC	4.7uH			FLC32T-4R7K	L1690211		1-	A	F5
L 1074	CHIP COIL	0.12uH			C2520C-R12J	L1690545		1-	A	H5
L 1075	CHIP COIL	0.068uH			C2520C-68NK	L1690542		1-	A	E6
L 1076	CHIP COIL	0.12uH			C2520C-R12J	L1690545		1-	A	H5
L 1077	CHIP COIL	0.047uH			C2520C-47NK	L1690540		1-	A	E6
L 1078	M.RFC	180uH			FLC32T-181J	L1690230		1-	A	D2
L 1079	M.RFC	100uH			FLC32T-101J	L1690227		1-	A	J2
L 1080	M.RFC	100uH			FLC32T-101J	L1690227		1-	A	C7
L 1081	M.RFC	100uH			FLC32T-101J	L1690227		1-	A	C7
L 1082	M.RFC	100uH			FLC32T-101J	L1690227		1-	A	J5
L 1083	M.RFC	100uH			FLC32T-101J	L1690227		1-	A	J4
L 1084	M.RFC	1.5uH			LK1608 1R5K-T	L1690846		1-	A	E5
Q 1001	TRANSISTOR				2SC2954-T2	G3329547		1-	A	G1
Q 1002	TRANSISTOR				2SC2812NL6-TB	G3328128F		1-	A	H2
Q 1003	IC				TD62783AFN(EL)	G1092700		1-	A	B2
Q 1004	IC				M51945BFP-600C	G1091990		1-	A	A4
Q 1005	TRANSISTOR				PDTC144EE	G3070244		1-	A	H2

REF.	DESCRIPTION	VALUE	V/W	TOL.	MFR'S DESIG	VXSTD P/N	VERS.	LOT.	SIDE	LAY ADR
Q 1006	IC				UPC2926T(TAPE)	G1093833		1-	A	C5
Q 1007	IC				KIA7808API	G1093164		1-	A	A5
Q 1008	IC				L78M05T-TL	G1091731		1-	A	B5
Q 1009	TRANSISTOR				PDTC144EE	G3070244		1-	A	B3
Q 1010	TRANSISTOR				2SA1602A-T11-1F	G3116028F		1-	A	A3
Q 1011	IC				TC4028BF(EL.N)	G1093433		1-	A	B2
Q 1012	IC				BA05FP-E2	G1093209		1-	A	A4
Q 1013	TRANSISTOR				2SC4047-TA	G3340477		1-	A	A4
Q 1014	IC				CD4094BPWR	G1093866		1-	A	E3
Q 1015	IC				BR24L64F-WE2	G1093876		1-	A	C3
Q 1016	TRANSISTOR				2SC2714YTE85R	G3327147Y		1-	A	I1
Q 1017	IC				CD4094BPWR	G1093866		1-	A	E2
Q 1018	IC				HD64F2134ATF20(FLASH)	✕		1-	A	B3
Q 1019	TRANSISTOR				DTC114EUA T106	G3070084		1-	A	C3
Q 1020	IC				M62354FP-75NC	G1091842		1-	A	B3
Q 1021	TRANSISTOR				2SC2714YTE85R	G3327147Y		1-	A	I4
Q 1022	FET				2SK520-T2B K41	G3805207A		1-	A	I4
Q 1023	TRANSISTOR				2SC2714YTE85R	G3327147Y		1-	A	I1
Q 1024	FET				2SK520-T2B K41	G3805207A		1-	A	I4
Q 1025	TRANSISTOR				2SC3357-T2 RF	G3333577F		1-	A	H4
Q 1026	TRANSISTOR				2SC2714YTE85R	G3327147Y		1-	A	H4
Q 1027	TRANSISTOR				2SC2714YTE85R	G3327147Y		1-	A	I6
Q 1028	TRANSISTOR				2SC3356-T2B R25	G3333567E		1-	A	I6
Q 1029	TRANSISTOR				2SC2954-T2	G3329547		1-	A	I6
Q 1030	IC				UPC4572G2-E2	G1092042		1-	A	F6
Q 1032	IC				UPC4572G2-E2	G1092042		1-	A	C7
Q 1033	IC				UPC4572G2-E2	G1092042		1-	A	D7
Q 1034	IC				UPC4572G2-E2	G1092042		1-	A	F7
Q 1035	IC				UPD77115GK-9EU	G1093832		1-	A	B4
Q 1036	IC				UPC4572G2-E2	G1092042		1-	A	E7
Q 1037	TRANSISTOR				PDTC144EE	G3070244		1-	A	H6
Q 1038	TRANSISTOR				PDTC144EE	G3070244		1-	A	C4
Q 1039	IC				LM2904PWR	G1094010		1-	A	E4
Q 1040	IC				LM2904PWR	G1094010		1-	A	F4
Q 1041	IC				UPC4572G2-E2	G1092042		1-	A	E6
Q 1043	FET				3SK151GR TE85R	G4801517G		1-	A	H6
Q 1044	TRANSISTOR				2SC2812NL6-TB	G3328128F		1-	A	I7
Q 1045	TRANSISTOR				PDTC144EE	G3070244		1-	A	H6
Q 1046	TRANSISTOR				2SA1602A-T11-1F	G3116028F		1-	A	H6
Q 1047	TRANSISTOR				PDTC144EE	G3070244		1-	A	H6
Q 1048	TRANSISTOR				2SA1365-T12-2G	G3113657G		1-	A	H6
Q 1049	FET				3SK151GR TE85R	G4801517G		1-	A	G7
Q 1050	FET				3SK151GR TE85R	G4801517G		1-	A	G6
Q 1052	IC				RF2713(TAPE)	G1093831		1-	A	F6
Q 1053	TRANSISTOR				PDTC144EE	G3070244		1-	A	C2
Q 1054	IC				RF2713(TAPE)	G1093831		1-	A	F7
Q 1055	IC				TDA2003H	G1090815		1-	A	A6
Q 1056	IC				ADF4001BRU	G1093977		1-	A	F5
Q 1059	IC				TC7S04FU TE85R	G1091530		1-	A	E5
Q 1060	IC				AD9833BRM(TAPE)	G1093580		1-	A	E5
Q 1062	IC				TC7S04FU TE85R	G1091530		1-	A	D5
Q 1063	TRANSISTOR				2SC2714YTE85R	G3327147Y		1-	A	E5
Q 1064	TRANSISTOR				2SC2714YTE85R	G3327147Y		1-	A	F5
Q 1065	TRANSISTOR				PDTC144EE	G3070244		1-	A	G5
Q 1066	FET				2SK302Y TE85R	G3803027Y		1-	A	G5
Q 1068	TRANSISTOR				PDTC144EE	G3070244		1-	A	G5
Q 1069	TRANSISTOR				PDTC144EE	G3070244		1-	A	G5
Q 1070	TRANSISTOR				2SC2714YTE85R	G3327147Y		1-	A	D6
Q 1071	IC				AK4528VF E2	G1093829		1-	A	D6

✕: Please contact VERTEX STANDARD

MAIN Unit

Parts List

REF.	DESCRIPTION	VALUE	V/W	TOL.	MFR'S DESIG	VXSTD P/N	VERS.	LOT.	SIDE	LAY ADR
Q 1072	FET				2SK210GR TE85R	G3802107G		1-	A	G4
Q 1073	FET				2SK210GR TE85R	G3802107G		1-	A	F4
Q 1074	TRANSISTOR				2SC2714YTE85R	G3327147Y		1-	A	G5
Q 1075	TRANSISTOR				2SC2714YTE85R	G3327147Y		1-	A	E6
Q 1076	TRANSISTOR				2SD2211 T100 QR	G3422117Q		1-	A	J3
Q 1078	IC				LM2904PWR	G1094010		1-		
Q 1079	IC				BU4052BCF-E2	G1093661		1-	A	D2
Q 1080	IC				TC7ST08FU TE85R	G1092221		1-	A	B4
Q 1081	IC				AK4550VT	G1094072		1-	A	D6
Q 1082	TRANSISTOR				PDTC144EE	G3070244		1-	A	E2
Q 1083	TRANSISTOR				PDTC144EE	G3070244		1-	A	E2
Q 1084	TRANSISTOR				PDTC144EE	G3070244		1-	A	E2
Q 1088	IC				TC74HC4040AF(EL.F)	G1091457		1-	A	C6
Q 1089	IC				TC7W04FU TE12R	G1091539		1-	A	C6
Q 1090	POLY SWITCH				RUE250	G9090135		1-	A	J5
Q 1091	FET				2SJ125D-T12-1D	G3701257D		1-	A	J2
Q 1092	FET				2SJ125D-T12-1D	G3701257D		1-	A	B7
Q 1093	TRANSISTOR				DTD143TK T146	G3070250		1-	A	B3
R 1001	CHIP RES.	270	1/16W	5%	RMC1/16 271JATP	J24185271		1-	A	G2
R 1002	CHIP RES.	18	1/16W	5%	RMC1/16 180JATP	J24185180		1-	A	G2
R 1003	CHIP RES.	270	1/16W	5%	RMC1/16 271JATP	J24185271		1-	A	G2
R 1004	CHIP RES.	10k	1/16W	5%	RMC1/16 103JATP	J24185103		1-	A	C2
R 1005	CHIP RES.	100k	1/16W	5%	RMC1/16 104JATP	J24185104		1-	A	C2
R 1006	CHIP RES.	100	1/16W	5%	RMC1/16 101JATP	J24185101		1-	A	G2
R 1007	CHIP RES.	10k	1/16W	5%	RMC1/16 103JATP	J24185103		1-	A	C3
R 1008	CHIP RES.	47	1/16W	5%	RMC1/16 470JATP	J24185470		1-	A	C7
R 1009	CHIP RES.	100k	1/16W	5%	RMC1/16 104JATP	J24185104		1-	A	C2
R 1010	CHIP RES.	4.7k	1/16W	5%	RMC1/16 472JATP	J24185472		1-	A	C4
R 1011	CHIP RES.	10	1/16W	5%	RMC1/16 100JATP	J24185100		1-	A	H1
R 1012	CHIP RES.	220	1/16W	5%	RMC1/16 221JATP	J24185221		1-	A	H1
R 1013	CHIP RES.	10k	1/16W	5%	RMC1/16 103JATP	J24185103		1-	A	H2
R 1014	CHIP RES.	10k	1/16W	5%	RMC1/16 103JATP	J24185103		1-	A	H2
R 1015	CHIP RES.	1.8k	1/16W	5%	RMC1/16 182JATP	J24185182		1-	A	G1
R 1016	CHIP RES.	12k	1/16W	5%	RMC1/16 123JATP	J24185123		1-	A	H2
R 1017	CHIP RES.	10k	1/16W	5%	RMC1/16 103JATP	J24185103		1-	A	H2
R 1018	CHIP RES.	1.8k	1/16W	5%	RMC1/16 182JATP	J24185182		1-	A	H1
R 1019	CHIP RES.	15k	1/16W	5%	RMC1/16 153JATP	J24185153		1-	A	H2
R 1020	CHIP RES.	8.2k	1/16W	5%	RMC1/16 822JATP	J24185822		1-	A	A4
R 1021	CHIP RES.	1.8k	1/16W	5%	RMC1/16 182JATP	J24185182		1-	A	A4
R 1022	CHIP RES.	3.9k	1/16W	5%	RMC1/16 392JATP	J24185392		1-	A	H2
R 1023	CHIP RES.	10k	1/16W	5%	RMC1/16 103JATP	J24185103		1-	A	H2
R 1024	CHIP RES.	100k	1/16W	5%	RMC1/16 104JATP	J24185104		1-	A	B3
R 1025	CHIP RES.	6.8k	1/16W	5%	RMC1/16 682JATP	J24185682		1-	A	B3
R 1026	CHIP RES.	47k	1/16W	5%	RMC1/16 473JATP	J24185473		1-	A	A4
R 1027	CHIP RES.	47k	1/16W	5%	RMC1/16 473JATP	J24185473		1-	A	A4
R 1028	CHIP RES.	2.2k	1/16W	5%	RMC1/16 222JATP	J24185222		1-	A	I1
R 1029	CHIP RES.	100	1/16W	5%	RMC1/16 101JATP	J24185101		1-	A	J1
R 1030	CHIP RES.	470	1/16W	5%	RMC1/16 471JATP	J24185471		1-	A	E2
R 1031	CHIP RES.	470	1/16W	5%	RMC1/16 471JATP	J24185471		1-	A	E3
R 1032	CHIP RES.	10k	1/16W	5%	RMC1/16 103JATP	J24185103		1-	A	C3
R 1033	CHIP RES.	1.8k	1/16W	5%	RMC1/16 182JATP	J24185182		1-	A	I2
R 1034	CHIP RES.	4.7k	1/16W	5%	RMC1/16 472JATP	J24185472		1-	A	I2
R 1035	CHIP RES.	4.7k	1/16W	5%	RMC1/16 472JATP	J24185472		1-	A	I2
R 1036	CHIP RES.	3.3k	1/16W	5%	RMC1/16 332JATP	J24185332		1-	A	B4
R 1037	CHIP RES.	3.3k	1/16W	5%	RMC1/16 332JATP	J24185332		1-	A	B4
R 1038	CHIP RES.	3.3k	1/16W	5%	RMC1/16 332JATP	J24185332		1-	A	B4
R 1039	CHIP RES.	3.3k	1/16W	5%	RMC1/16 332JATP	J24185332		1-	A	B4
R 1040	CHIP RES.	3.3k	1/16W	5%	RMC1/16 332JATP	J24185332		1-	A	B4
R 1041	CHIP RES.	3.3k	1/16W	5%	RMC1/16 332JATP	J24185332		1-	A	B4

REF.	DESCRIPTION	VALUE	V/W	TOL.	MFR'S DESIG	VXSTD P/N	VERS.	LOT.	SIDE	LAY ADR
R 1042	CHIP RES.	3.3k	1/16W	5%	RMC1/16 332JATP	J24185332		1-	A	B4
R 1043	CHIP RES.	3.3k	1/16W	5%	RMC1/16 332JATP	J24185332		1-	A	B4
R 1044	CHIP RES.	68	1/4W	5%	RMC1/4 680JATP	J24245680		1-	A	F2
R 1045	CHIP RES.	68	1/4W	5%	RMC1/4 680JATP	J24245680		1-	A	F2
R 1046	CHIP RES.	68	1/4W	5%	RMC1/4 680JATP	J24245680		1-	A	G2
R 1047	CHIP RES.	68	1/4W	5%	RMC1/4 680JATP	J24245680		1-	A	G2
R 1048	CHIP RES.	68	1/4W	5%	RMC1/4 680JATP	J24245680		1-	A	H2
R 1049	CHIP RES.	68	1/4W	5%	RMC1/4 680JATP	J24245680		1-	A	H2
R 1050	CHIP RES.	68	1/4W	5%	RMC1/4 680JATP	J24245680		1-	A	I2
R 1051	CHIP RES.	68	1/4W	5%	RMC1/4 680JATP	J24245680		1-	A	I2
R 1052	CHIP RES.	47k	1/16W	5%	RMC1/16 473JATP	J24185473		1-	A	C3
R 1053	CHIP RES.	470	1/16W	5%	RMC1/16 471JATP	J24185471		1-	A	E2
R 1054	CHIP RES.	2.2k	1/16W	5%	RMC1/16 222JATP	J24185222		1-	A	F2
R 1055	CHIP RES.	560	1/16W	5%	RMC1/16 561JATP	J24185561		1-	A	F2
R 1056	CHIP RES.	47k	1/16W	5%	RMC1/16 473JATP	J24185473		1-	A	C3
R 1057	CHIP RES.	47k	1/16W	5%	RMC1/16 473JATP	J24185473		1-	A	C3
R 1059	CHIP RES.	3.3k	1/16W	5%	RMC1/16 332JATP	J24185332		1-	A	B3
R 1060	CHIP RES.	3.3k	1/16W	5%	RMC1/16 332JATP	J24185332		1-	A	B4
R 1061	CHIP RES.	3.3k	1/16W	5%	RMC1/16 332JATP	J24185332		1-	A	B3
R 1062	CHIP RES.	3.3k	1/16W	5%	RMC1/16 332JATP	J24185332		1-	A	B4
R 1063	CHIP RES.	3.3k	1/16W	5%	RMC1/16 332JATP	J24185332		1-	A	B4
R 1064	CHIP RES.	3.3k	1/16W	5%	RMC1/16 332JATP	J24185332		1-	A	B3
R 1065	CHIP RES.	3.3k	1/16W	5%	RMC1/16 332JATP	J24185332		1-	A	B4
R 1066	CHIP RES.	3.3k	1/16W	5%	RMC1/16 332JATP	J24185332		1-	A	B3
R 1067	CHIP RES.	1k	1/16W	5%	RMC1/16 102JATP	J24185102		1-	A	I4
R 1068	CHIP RES.	1k	1/16W	5%	RMC1/16 102JATP	J24185102		1-	A	I4
R 1069	CHIP RES.	10k	1/16W	5%	RMC1/16 103JATP	J24185103		1-	A	I4
R 1070	CHIP RES.	3.3k	1/16W	5%	RMC1/16 332JATP	J24185332		1-	A	B4
R 1071	CHIP RES.	3.3k	1/16W	5%	RMC1/16 332JATP	J24185332		1-	A	B3
R 1072	CHIP RES.	4.7k	1/16W	5%	RMC1/16 472JATP	J24185472		1-	A	C2
R 1073	CHIP RES.	2.2k	1/16W	5%	RMC1/16 222JATP	J24185222		1-	A	I4
R 1074	CHIP RES.	68k	1/16W	5%	RMC1/16 683JATP	J24185683		1-	A	I4
R 1075	CHIP RES.	4.7k	1/16W	5%	RMC1/16 472JATP	J24185472		1-	A	H4
R 1076	CHIP RES.	2.2k	1/16W	5%	RMC1/16 222JATP	J24185222		1-	A	H4
R 1077	CHIP RES.	100	1/16W	5%	RMC1/16 101JATP	J24185101		1-	A	H4
R 1078	CHIP RES.	22	1/16W	5%	RMC1/16 220JATP	J24185220		1-	A	H4
R 1079	CHIP RES.	0	1/16W	5%	RMC1/16 000JATP	J24185000		1-	A	B4
R 1080	CHIP RES.	3.3k	1/16W	5%	RMC1/16 332JATP	J24185332		1-	A	B3
R 1081	CHIP RES.	3.3k	1/16W	5%	RMC1/16 332JATP	J24185332		1-	A	B4
R 1082	CHIP RES.	4.7k	1/16W	5%	RMC1/16 472JATP	J24185472		1-	A	H4
R 1083	CHIP RES.	3.3k	1/16W	5%	RMC1/16 332JATP	J24185332		1-	A	B3
R 1084	CHIP RES.	150	1/16W	5%	RMC1/16 151JATP	J24185151		1-	A	I4
R 1085	CHIP RES.	470	1/16W	5%	RMC1/16 471JATP	J24185471		1-	A	H4
R 1086	CHIP RES.	4.7k	1/16W	5%	RMC1/16 472JATP	J24185472		1-	A	I1
R 1087	CHIP RES.	22k	1/16W	5%	RMC1/16 223JATP	J24185223		1-	A	H4
R 1088	CHIP RES.	270	1/4W	5%	RMC1/4 271JATP	J24245271		1-	A	H4
R 1089	CHIP RES.	2.2M	1/16W	5%	RMC1/16 225JATP	J24185225		1-	A	I4
R 1090	CHIP RES.	3.3k	1/16W	5%	RMC1/16 332JATP	J24185332		1-	A	B4
R 1091	CHIP RES.	10k	1/16W	5%	RMC1/16 103JATP	J24185103		1-	A	H4
R 1092	CHIP RES.	3.3k	1/16W	5%	RMC1/16 332JATP	J24185332		1-	A	B3
R 1093	CHIP RES.	470	1/16W	5%	RMC1/16 471JATP	J24185471		1-	A	H4
R 1094	CHIP RES.	820	1/16W	5%	RMC1/16 821JATP	J24185821		1-	A	I4
R 1095	CHIP RES.	4.7k	1/16W	5%	RMC1/16 472JATP	J24185472		1-	A	I2
R 1096	CHIP RES.	56	1/16W	5%	RMC1/16 560JATP	J24185560		1-	A	I6
R 1097	CHIP RES.	390	1/16W	5%	RMC1/16 391JATP	J24185391		1-	A	H4
R 1098	CHIP RES.	2.2k	1/16W	5%	RMC1/16 222JATP	J24185222		1-	A	H4
R 1099	CHIP RES.	100	1/16W	5%	RMC1/16 101JATP	J24185101		1-	A	I5
R 1100	CHIP RES.	10k	1/16W	5%	RMC1/16 103JATP	J24185103		1-	A	I6
R 1101	CHIP RES.	8.2k	1/16W	5%	RMC1/16 822JATP	J24185822		1-	A	H4

MAIN Unit

Parts List

REF.	DESCRIPTION	VALUE	V/W	TOL.	MFR'S DESIG	VXSTD P/N	VERS.	LOT.	SIDE	LAY ADR
R 1102	CHIP RES.	4.7k	1/16W	5%	RMC1/16 472JATP	J24185472		1-	A	H4
R 1103	CHIP RES.	56	1/16W	5%	RMC1/16 560JATP	J24185560		1-	A	H5
R 1104	CHIP RES.	560	1/16W	5%	RMC1/16 561JATP	J24185561		1-	A	J6
R 1105	CHIP RES.	82	1/16W	5%	RMC1/16 820JATP	J24185820		1-	A	I6
R 1106	CHIP RES.	390	1/16W	5%	RMC1/16 391JATP	J24185391		1-	A	J6
R 1107	CHIP RES.	3.3k	1/16W	5%	RMC1/16 332JATP	J24185332		1-	A	B4
R 1108	CHIP RES.	100	1/16W	5%	RMC1/16 101JATP	J24185101		1-	A	J6
R 1109	CHIP RES.	10k	1/16W	5%	RMC1/16 103JATP	J24185103		1-	A	A3
R 1110	CHIP RES.	10k	1/16W	5%	RMC1/16 103JATP	J24185103		1-	A	A2
R 1111	CHIP RES.	4.7k	1/16W	5%	RMC1/16 472JATP	J24185472		1-	A	C4
R 1112	CHIP RES.	10k	1/16W	5%	RMC1/16 103JATP	J24185103		1-	A	B5
R 1113	CHIP RES.	56	1/16W	5%	RMC1/16 560JATP	J24185560		1-	A	H5
R 1114	CHIP RES.	2.2k	1/16W	5%	RMC1/16 222JATP	J24185222		1-	A	I5
R 1115	CHIP RES.	10	1/16W	5%	RMC1/16 100JATP	J24185100		1-	A	I6
R 1116	CHIP RES.	560	1/16W	5%	RMC1/16 561JATP	J24185561		1-	A	J6
R 1117	CHIP RES.	1k	1/16W	5%	RMC1/16 102JATP	J24185102		1-	A	J6
R 1118	CHIP RES.	3.3k	1/16W	5%	RMC1/16 332JATP	J24185332		1-	A	B4
R 1119	CHIP RES.	10	1/16W	5%	RMC1/16 100JATP	J24185100		1-	A	B2
R 1120	CHIP RES.	5.6k	1/16W	5%	RMC1/16 562JATP	J24185562		1-	A	J6
R 1121	CHIP RES.	3.3k	1/16W	5%	RMC1/16 332JATP	J24185332		1-	A	J6
R 1122	CHIP RES.	100	1/16W	5%	RMC1/16 101JATP	J24185101		1-	A	I6
R 1123	CHIP RES.	220	1/16W	5%	RMC1/16 221JATP	J24185221		1-	A	I5
R 1124	CHIP RES.	47k	1/16W	5%	RMC1/16 473JATP	J24185473		1-	A	C5
R 1125	CHIP RES.	47k	1/16W	5%	RMC1/16 473JATP	J24185473		1-	A	C5
R 1126	CHIP RES.	120	1/16W	5%	RMC1/16 121JATP	J24185121		1-	A	I6
R 1127	CHIP RES.	4.7k	1/16W	5%	RMC1/16 472JATP	J24185472		1-	A	C4
R 1128	CHIP RES.	3.3k	1/16W	5%	RMC1/16 332JATP	J24185332		1-	A	I7
R 1129	CHIP RES.	4.7k	1/16W	5%	RMC1/16 472JATP	J24185472		1-	A	C4
R 1130	CHIP RES.	100k	1/16W	5%	RMC1/16 104JATP	J24185104		1-	A	F4
R 1131	CHIP RES.	47k	1/16W	5%	RMC1/16 473JATP	J24185473		1-	A	F4
R 1132	CHIP RES.	100k	1/16W	5%	RMC1/16 104JATP	J24185104		1-	A	F3
R 1133	CHIP RES.	10k	1/16W	5%	RMC1/16 103JATP	J24185103		1-	A	F3
R 1134	CHIP RES.	4.7k	1/16W	5%	RMC1/16 472JATP	J24185472		1-	A	C4
R 1135	CHIP RES.	470	1/16W	5%	RMC1/16 471JATP	J24185471		1-	A	H7
R 1136	CHIP RES.	4.7k	1/16W	5%	RMC1/16 472JATP	J24185472		1-	A	C4
R 1137	CHIP RES.	47k	1/16W	5%	RMC1/16 473JATP	J24185473		1-	A	F4
R 1138	CHIP RES.	47k	1/16W	5%	RMC1/16 473JATP	J24185473		1-	A	F3
R 1139	CHIP RES.	10k	1/16W	5%	RMC1/16 103JATP	J24185103		1-	A	B5
R 1140	CHIP RES.	150k	1/16W	5%	RMC1/16 154JATP	J24185154		1-	A	F3
R 1141	CHIP RES.	150k	1/16W	5%	RMC1/16 154JATP	J24185154		1-	A	F4
R 1142	CHIP RES.	220	1/16W	5%	RMC1/16 221JATP	J24185221		1-	A	I7
R 1144	CHIP RES.	100	1/16W	5%	RMC1/16 101JATP	J24185101		1-	A	I6
R 1145	CHIP RES.	3.3k	1/16W	5%	RMC1/16 332JATP	J24185332		1-	A	B4
R 1146	CHIP RES.	22k	1/16W	5%	RMC1/16 223JATP	J24185223		1-	A	I6
R 1147	CHIP RES.	3.3k	1/16W	5%	RMC1/16 332JATP	J24185332		1-	A	H7
R 1148	CHIP RES.	47k	1/16W	5%	RMC1/16 473JATP	J24185473		1-	A	C4
R 1149	CHIP RES.	82	1/16W	5%	RMC1/16 820JATP	J24185820		1-	A	H6
R 1150	CHIP RES.	820	1/16W	5%	RMC1/16 821JATP	J24185821		1-	A	H6
R 1151	CHIP RES.	47k	1/16W	5%	RMC1/16 473JATP	J24185473		1-	A	H7
R 1152	CHIP RES.	12k	1/16W	5%	RMC1/16 123JATP	J24185123		1-	A	I6
R 1153	CHIP RES.	47k	1/16W	5%	RMC1/16 473JATP	J24185473		1-	A	C4
R 1154	CHIP RES.	4.7k	1/16W	5%	RMC1/16 472JATP	J24185472		1-	A	I7
R 1155	CHIP RES.	4.7k	1/16W	5%	RMC1/16 472JATP	J24185472		1-	A	H6
R 1156	CHIP RES.	1.2k	1/16W	5%	RMC1/16 122JATP	J24185122		1-	A	H6
R 1157	CHIP RES.	3.3k	1/16W	5%	RMC1/16 332JATP	J24185332		1-	A	I7
R 1158	CHIP RES.	1M	1/16W	5%	RMC1/16 105JATP	J24185105		1-	A	I7
R 1159	CHIP RES.	47k	1/16W	5%	RMC1/16 473JATP	J24185473		1-	A	B4
R 1160	CHIP RES.	47k	1/16W	5%	RMC1/16 473JATP	J24185473		1-	A	C4
R 1161	CHIP RES.	47k	1/16W	5%	RMC1/16 473JATP	J24185473		1-	A	C4

REF.	DESCRIPTION	VALUE	V/W	TOL.	MFR'S DESIG	VXSTD P/N	VERS.	LOT.	SIDE	LAY ADR
R 1162	CHIP RES.	47k	1/16W	5%	RMC1/16 473JATP	J24185473		1-	A	C4
R 1163	CHIP RES.	47k	1/16W	5%	RMC1/16 473JATP	J24185473		1-	A	C4
R 1164	CHIP RES.	47k	1/16W	5%	RMC1/16 473JATP	J24185473		1-	A	C4
R 1165	CHIP RES.	470	1/16W	5%	RMC1/16 471JATP	J24185471		1-	A	C4
R 1166	CHIP RES.	330	1/16W	5%	RMC1/16 331JATP	J24185331		1-	A	F1
R 1167	CHIP RES.	4.7k	1/16W	5%	RMC1/16 472JATP	J24185472		1-	A	I7
R 1168	CHIP RES.	0	1/16W	5%	RMC1/16 000JATP	J24185000		1-	A	C5
R 1169	CHIP RES.	3.3M	1/16W	5%	RMC1/16 335JATP	J24185335		1-	A	C4
R 1170	CHIP RES.	0	1/16W	5%	RMC1/16 000JATP	J24185000		1-	A	I7
R 1171	CHIP RES.	3.9k	1/16W	5%	RMC1/16 392JATP	J24185392		1-	A	H6
R 1172	CHIP RES.	100	1/16W	5%	RMC1/16 101JATP	J24185101		1-	A	H6
R 1173	CHIP RES.	6.8	1/16W	5%	RMC1/16 6R8JATP	J24185689		1-	A	H7
R 1174	CHIP RES.	150	1/16W	5%	RMC1/16 151JATP	J24185151		1-	A	G7
R 1175	CHIP RES.	6.8	1/16W	5%	RMC1/16 6R8JATP	J24185689		1-	A	G7
R 1176	CHIP RES.	150	1/16W	5%	RMC1/16 151JATP	J24185151		1-	A	G7
R 1177	CHIP RES.	100	1/16W	5%	RMC1/16 101JATP	J24185101		1-	A	G7
R 1178	CHIP RES.	10k	1/16W	5%	RMC1/16 103JATP	J24185103		1-	A	H6
R 1179	CHIP RES.	1k	1/16W	5%	RMC1/16 102JATP	J24185102		1-	A	G6
R 1180	CHIP RES.	2.2k	1/16W	5%	RMC1/16 222JATP	J24185222		1-	A	H6
R 1181	CHIP RES.	100k	1/16W	5%	RMC1/16 104JATP	J24185104		1-	A	H5
R 1182	CHIP RES.	6.8k	1/16W	5%	RMC1/16 682JATP	J24185682		1-	A	H5
R 1183	CHIP RES.	68k	1/16W	5%	RMC1/16 683JATP	J24185683		1-	A	G6
R 1184	CHIP RES.	1k	1/16W	5%	RMC1/16 102JATP	J24185102		1-	A	G6
R 1185	CHIP RES.	22	1/16W	5%	RMC1/16 220JATP	J24185220		1-	A	G7
R 1187	CHIP RES.	10k	1/16W	5%	RMC1/16 103JATP	J24185103		1-	A	G7
R 1188	CHIP RES.	1.5k	1/16W	5%	RMC1/16 152JATP	J24185152		1-	A	G7
R 1189	CHIP RES.	10	1/16W	5%	RMC1/16 100JATP	J24185100		1-	A	G6
R 1190	CHIP RES.	270	1/16W	5%	RMC1/16 271JATP	J24185271		1-	A	G6
R 1191	CHIP RES.	100k	1/16W	5%	RMC1/16 104JATP	J24185104		1-	A	H5
R 1192	CHIP RES.	15k	1/16W	5%	RMC1/16 153JATP	J24185153		1-	A	H5
R 1193	CHIP RES.	10k	1/16W	5%	RMC1/16 103JATP	J24185103		1-	A	G7
R 1194	CHIP RES.	4.7k	1/16W	5%	RMC1/16 472JATP	J24185472		1-	A	G7
R 1196	CHIP RES.	100	1/16W	5%	RMC1/16 101JATP	J24185101		1-	A	G6
R 1198	CHIP RES.	220	1/10W	5%	RMC1/10T 221J	J24205221		1-	A	A7
R 1199	CHIP RES.	47k	1/16W	5%	RMC1/16 473JATP	J24185473		1-	A	C2
R 1200	CHIP RES.	4.7	1/10W	5%	RMC1/10T 4R7J	J24205479		1-	A	A7
R 1201	CHIP RES.	1k	1/16W	5%	RMC1/16 102JATP	J24185102		1-	A	G7
R 1202	CHIP RES.	56	1/16W	5%	RMC1/16 560JATP	J24185560		1-	A	F6
R 1203	CHIP RES.	220	1/4W	5%	RMC1/4 221JATP	J24245221		1-	A	A7
R 1204	CHIP RES.	4.7	1/10W	5%	RMC1/10T 4R7J	J24205479		1-	A	A7
R 1205	CHIP RES.	330	1/16W	5%	RMC1/16 331JATP	J24185331		1-	A	F7
R 1206	CHIP RES.	330	1/16W	5%	RMC1/16 331JATP	J24185331		1-	A	F7
R 1207	CHIP RES.	470	1/16W	5%	RMC1/16 471JATP	J24185471		1-	A	F5
R 1208	CHIP RES.	220	1/16W	5%	RMC1/16 221JATP	J24185221		1-	A	E6
R 1209	CHIP RES.	220	1/16W	5%	RMC1/16 221JATP	J24185221		1-	A	E6
R 1210	CHIP RES.	47k	1/16W	5%	RMC1/16 473JATP	J24185473		1-	A	C2
R 1211	CHIP RES.	470	1/16W	5%	RMC1/16 471JATP	J24185471		1-	A	E1
R 1213	CHIP RES.	33k	1/16W	5%	RMC1/16 333JATP	J24185333		1-	A	F6
R 1214	CHIP RES.	33k	1/16W	5%	RMC1/16 333JATP	J24185333		1-	A	F6
R 1215	CHIP RES.	10k	1/16W	5%	RMC1/16 103JATP	J24185103		1-	A	F5
R 1216	CHIP RES.	10	1/16W	5%	RMC1/16 100JATP	J24185100		1-	A	D5
R 1217	CHIP RES.	220	1/16W	5%	RMC1/16 221JATP	J24185221		1-	A	F5
R 1218	CHIP RES.	220	1/16W	5%	RMC1/16 221JATP	J24185221		1-	A	F5
R 1220	CHIP RES.	220	1/16W	5%	RMC1/16 221JATP	J24185221		1-	A	F5
R 1221	CHIP RES.	2.2k	1/16W	5%	RMC1/16 222JATP	J24185222		1-	A	F5
R 1222	CHIP RES.	2.2k	1/16W	5%	RMC1/16 222JATP	J24185222		1-	A	F5
R 1223	CHIP RES.	220	1/16W	5%	RMC1/16 221JATP	J24185221		1-	A	E5
R 1224	CHIP RES.	220	1/16W	5%	RMC1/16 221JATP	J24185221		1-	A	E5
R 1225	CHIP RES.	220	1/16W	5%	RMC1/16 221JATP	J24185221		1-	A	E5

MAIN Unit

Parts List

REF.	DESCRIPTION	VALUE	V/W	TOL.	MFR'S DESIG	VXSTD P/N	VERS.	LOT.	SIDE	LAY ADR
R 1226	CHIP RES.	33k	1/16W	5%	RMC1/16 333JATP	J24185333		1-	A	F6
R 1227	CHIP RES.	33k	1/16W	5%	RMC1/16 333JATP	J24185333		1-	A	F6
R 1229	CHIP RES.	470	1/16W	5%	RMC1/16 471JATP	J24185471		1-	A	E1
R 1230	CHIP RES.	10k	1/16W	5%	RMC1/16 103JATP	J24185103		1-	A	C2
R 1231	CHIP RES.	1M	1/16W	5%	RMC1/16 105JATP	J24185105		1-	A	E5
R 1232	CHIP RES.	3.9k	1/16W	5%	RMC1/16 392JATP	J24185392		1-	A	D7
R 1233	CHIP RES.	1k	1/16W	5%	RMC1/16 102JATP	J24185102		1-	A	F5
R 1234	CHIP RES.	3.9k	1/16W	5%	RMC1/16 392JATP	J24185392		1-	A	C7
R 1236	CHIP RES.	100	1/16W	5%	RMC1/16 101JATP	J24185101		1-	A	E5
R 1237	CHIP RES.	15k	1/16W	5%	RMC1/16 153JATP	J24185153		1-	A	E7
R 1239	CHIP RES.	1k	1/16W	5%	RMC1/16 102JATP	J24185102		1-	A	E5
R 1240	CHIP RES.	100k	1/16W	5%	RMC1/16 104JATP	J24185104		1-	A	E5
R 1243	CHIP RES.	15k	1/16W	5%	RMC1/16 153JATP	J24185153		1-	A	E7
R 1244	CHIP RES.	100	1/16W	5%	RMC1/16 101JATP	J24185101		1-	A	G5
R 1245	CHIP RES.	470	1/16W	5%	RMC1/16 471JATP	J24185471		1-	A	F5
R 1246	CHIP RES.	100k	1/16W	5%	RMC1/16 104JATP	J24185104		1-	A	G5
R 1247	CHIP RES.	1k	1/16W	5%	RMC1/16 102JATP	J24185102		1-	A	F5
R 1248	CHIP RES.	1M	1/16W	5%	RMC1/16 105JATP	J24185105		1-	A	D5
R 1252	CHIP RES.	12k	1/16W	5%	RMC1/16 123JATP	J24185123		1-	A	E7
R 1253	CHIP RES.	3.3k	1/16W	5%	RMC1/16 332JATP	J24185332		1-	A	C7
R 1254	CHIP RES.	3.3k	1/16W	5%	RMC1/16 332JATP	J24185332		1-	A	D7
R 1255	CHIP RES.	4.7k	1/16W	5%	RMC1/16 472JATP	J24185472		1-	A	E7
R 1256	CHIP RES.	4.7k	1/16W	5%	RMC1/16 472JATP	J24185472		1-	A	F7
R 1259	CHIP RES.	100k	1/16W	5%	RMC1/16 104JATP	J24185104		1-	A	C2
R 1260	CHIP RES.	100k	1/16W	5%	RMC1/16 104JATP	J24185104		1-	A	C2
R 1261	CHIP RES.	100	1/16W	5%	RMC1/16 101JATP	J24185101		1-	A	G5
R 1262	CHIP RES.	390	1/16W	5%	RMC1/16 391JATP	J24185391		1-	A	G5
R 1263	CHIP RES.	100k	1/16W	5%	RMC1/16 104JATP	J24185104		1-	A	C2
R 1264	CHIP RES.	100k	1/16W	5%	RMC1/16 104JATP	J24185104		1-	A	C2
R 1265	CHIP RES.	100k	1/16W	5%	RMC1/16 104JATP	J24185104		1-	A	C7
R 1266	CHIP RES.	100k	1/16W	5%	RMC1/16 104JATP	J24185104		1-	A	D7
R 1267	CHIP RES.	180	1/16W	5%	RMC1/16 181JATP	J24185181		1-	A	F7
R 1268	CHIP RES.	180	1/16W	5%	RMC1/16 181JATP	J24185181		1-	A	F7
R 1269	CHIP RES.	100k	1/16W	5%	RMC1/16 104JATP	J24185104		1-	A	G5
R 1270	CHIP RES.	100	1/16W	5%	RMC1/16 101JATP	J24185101		1-	A	G4
R 1272	CHIP RES.	4.7k	1/16W	5%	RMC1/16 472JATP	J24185472		1-	A	G5
R 1273	CHIP RES.	22k	1/16W	5%	RMC1/16 223JATP	J24185223		1-	A	G5
R 1274	CHIP RES.	180	1/16W	5%	RMC1/16 181JATP	J24185181		1-	A	F7
R 1275	CHIP RES.	180	1/16W	5%	RMC1/16 181JATP	J24185181		1-	A	F7
R 1279	CHIP RES.	10k	1/16W	5%	RMC1/16 103JATP	J24185103		1-	A	E7
R 1280	CHIP RES.	10k	1/16W	5%	RMC1/16 103JATP	J24185103		1-	A	F7
R 1281	CHIP RES.	4.7k	1/16W	5%	RMC1/16 472JATP	J24185472		1-	A	F7
R 1282	CHIP RES.	10k	1/16W	5%	RMC1/16 103JATP	J24185103		1-	A	E7
R 1283	CHIP RES.	10k	1/16W	5%	RMC1/16 103JATP	J24185103		1-	A	F7
R 1284	CHIP RES.	4.7k	1/16W	5%	RMC1/16 472JATP	J24185472		1-	A	F7
R 1285	CHIP RES.	10k	1/16W	5%	RMC1/16 103JATP	J24185103		1-	A	F6
R 1286	CHIP RES.	10k	1/16W	5%	RMC1/16 103JATP	J24185103		1-	A	F6
R 1287	CHIP RES.	1.8k	1/16W	5%	RMC1/16 182JATP	J24185182		1-	A	C7
R 1288	CHIP RES.	5.6k	1/16W	5%	RMC1/16 562JATP	J24185562		1-	A	D7
R 1289	CHIP RES.	150	1/16W	5%	RMC1/16 151JATP	J24185151		1-	A	G5
R 1290	CHIP RES.	100k	1/16W	5%	RMC1/16 104JATP	J24185104		1-	A	D6
R 1291	CHIP RES.	10k	1/16W	5%	RMC1/16 103JATP	J24185103		1-	A	D5
R 1292	CHIP RES.	10	1/16W	5%	RMC1/16 100JATP	J24185100		1-	A	D6
R 1293	CHIP RES.	150	1/16W	5%	RMC1/16 151JATP	J24185151		1-	A	G5
R 1294	CHIP RES.	1k	1/16W	5%	RMC1/16 102JATP	J24185102		1-	A	D7
R 1295	CHIP RES.	1k	1/16W	5%	RMC1/16 102JATP	J24185102		1-	A	D7
R 1296	CHIP RES.	100	1/16W	5%	RMC1/16 101JATP	J24185101		1-	A	D5
R 1297	CHIP RES.	22k	1/16W	5%	RMC1/16 223JATP	J24185223		1-	A	G4
R 1298	CHIP RES.	22k	1/16W	5%	RMC1/16 223JATP	J24185223		1-	A	F5

Parts List

REF.	DESCRIPTION	VALUE	V/W	TOL.	MFR'S DESIG	VXSTD P/N	VERS.	LOT.	SIDE	LAY ADR
R 1299	CHIP RES.	10k	1/16W	5%	RMC1/16 103JATP	J24185103		1-	A	E6
R 1300	CHIP RES.	10k	1/16W	5%	RMC1/16 103JATP	J24185103		1-	A	E6
R 1301	CHIP RES.	1k	1/16W	5%	RMC1/16 102JATP	J24185102		1-	A	D7
R 1302	CHIP RES.	1k	1/16W	5%	RMC1/16 102JATP	J24185102		1-	A	D7
R 1303	CHIP RES.	330	1/16W	5%	RMC1/16 331JATP	J24185331		1-	A	E6
R 1304	CHIP RES.	330	1/16W	5%	RMC1/16 331JATP	J24185331		1-	A	F6
R 1305	CHIP RES.	330	1/16W	5%	RMC1/16 331JATP	J24185331		1-	A	E7
R 1306	CHIP RES.	330	1/16W	5%	RMC1/16 331JATP	J24185331		1-	A	F6
R 1307	CHIP RES.	68k	1/16W	5%	RMC1/16 683JATP	J24185683		1-	A	G5
R 1308	CHIP RES.	10	1/16W	5%	RMC1/16 100JATP	J24185100		1-	A	E6
R 1309	CHIP RES.	100k	1/16W	5%	RMC1/16 104JATP	J24185104		1-	A	G4
R 1310	CHIP RES.	100k	1/16W	5%	RMC1/16 104JATP	J24185104		1-	A	F4
R 1311	CHIP RES.	220	1/16W	5%	RMC1/16 221JATP	J24185221		1-	A	E7
R 1312	CHIP RES.	220	1/16W	5%	RMC1/16 221JATP	J24185221		1-	A	E7
R 1313	CHIP RES.	47	1/16W	5%	RMC1/16 470JATP	J24185470		1-	A	G5
R 1314	CHIP RES.	100	1/16W	5%	RMC1/16 101JATP	J24185101		1-	A	G5
R 1315	CHIP RES.	100	1/16W	5%	RMC1/16 101JATP	J24185101		1-	A	E7
R 1316	CHIP RES.	100k	1/16W	5%	RMC1/16 104JATP	J24185104		1-	A	D6
R 1317	CHIP RES.	100	1/16W	5%	RMC1/16 101JATP	J24185101		1-	A	E5
R 1318	CHIP RES.	220	1/16W	5%	RMC1/16 221JATP	J24185221		1-	A	E6
R 1319	CHIP RES.	22	1/16W	5%	RMC1/16 220JATP	J24185220		1-	A	E6
R 1320	CHIP RES.	470	1/4W	5%	RMC1/4 471JATP	J24245471		1-	A	I3
R 1321	CHIP RES.	220	1/16W	5%	RMC1/16 221JATP	J24185221		1-	A	J3
R 1322	CHIP RES.	220	1/16W	5%	RMC1/16 221JATP	J24185221		1-	A	J3
R 1323	CHIP RES.	220	1/16W	5%	RMC1/16 221JATP	J24185221		1-	A	H5
R 1324	CHIP RES.	220	1/16W	5%	RMC1/16 221JATP	J24185221		1-	A	F5
R 1325	CHIP RES.	1k	1/16W	5%	RMC1/16 102JATP	J24185102		1-	A	J2
R 1326	CHIP RES.	470	1/16W	5%	RMC1/16 471JATP	J24185471		1-	A	J2
R 1327	CHIP RES.	1k	1/16W	5%	RMC1/16 102JATP	J24185102		1-	A	J2
R 1328	CHIP RES.	1k	1/16W	5%	RMC1/16 102JATP	J24185102		1-	A	J2
R 1329	CHIP RES.	1k	1/16W	5%	RMC1/16 102JATP	J24185102		1-	A	J2
R 1330	CHIP RES.	1k	1/16W	5%	RMC1/16 102JATP	J24185102		1-	A	J3
R 1331	CHIP RES.	1k	1/16W	5%	RMC1/16 102JATP	J24185102		1-	A	J3
R 1333	CHIP RES.	1k	1/16W	5%	RMC1/16 102JATP	J24185102		1-	A	J4
R 1334	CHIP RES.	1k	1/16W	5%	RMC1/16 102JATP	J24185102		1-	A	J4
R 1335	CHIP RES.	1k	1/16W	5%	RMC1/16 102JATP	J24185102		1-	A	J4
R 1336	CHIP RES.	1k	1/16W	5%	RMC1/16 102JATP	J24185102		1-	A	J4
R 1337	CHIP RES.	1k	1/16W	5%	RMC1/16 102JATP	J24185102		1-	A	J4
R 1338	CHIP RES.	1k	1/16W	5%	RMC1/16 102JATP	J24185102		1-	A	J4
R 1339	CHIP RES.	1k	1/16W	5%	RMC1/16 102JATP	J24185102		1-	A	J4
R 1340	CHIP RES.	10k	1/16W	5%	RMC1/16 103JATP	J24185103		1-		
R 1341	CHIP RES.	1k	1/16W	5%	RMC1/16 102JATP	J24185102		1-		
R 1342	CHIP RES.	100k	1/16W	5%	RMC1/16 104JATP	J24185104		1-		
R 1343	CHIP RES.	22k	1/16W	5%	RMC1/16 223JATP	J24185223		1-		
R 1344	CHIP RES.	1	1W	5%	RMC1 1R0JTE	J24305010		1-	A	B6
R 1346	CHIP RES.	100k	1/16W	5%	RMC1/16 104JATP	J24185104		1-	A	J4
R 1347	CHIP RES.	100k	1/16W	5%	RMC1/16 104JATP	J24185104		1-	A	B2
R 1352	CHIP RES.	47k	1/16W	5%	RMC1/16 473JATP	J24185473		1-	A	C2
R 1353	CHIP RES.	100k	1/16W	5%	RMC1/16 104JATP	J24185104		1-	A	B2
R 1354	CHIP RES.	100k	1/16W	5%	RMC1/16 104JATP	J24185104		1-	A	E3
R 1355	CHIP RES.	100k	1/16W	5%	RMC1/16 104JATP	J24185104		1-	A	E3
R 1356	CHIP RES.	47k	1/16W	5%	RMC1/16 473JATP	J24185473		1-	A	E3
R 1357	CHIP RES.	47k	1/16W	5%	RMC1/16 473JATP	J24185473		1-	A	E3
R 1358	CHIP RES.	47k	1/16W	5%	RMC1/16 473JATP	J24185473		1-	A	E4
R 1359	CHIP RES.	10k	1/16W	5%	RMC1/16 103JATP	J24185103		1-	A	E4
R 1360	CHIP RES.	220	1/16W	5%	RMC1/16 221JATP	J24185221		1-	A	H4
R 1361	CHIP RES.	0	1/16W	5%	RMC1/16 000JATP	J24185000		1-	A	C3
R 1362	CHIP RES.	4.7k	1/16W	5%	RMC1/16 472JATP	J24185472		1-	A	B2
R 1364	CHIP RES.	470	1/16W	5%	RMC1/16 471JATP	J24185471		1-	A	C7

MAIN Unit

Parts List

REF.	DESCRIPTION	VALUE	V/W	TOL.	MFR'S DESIG	VXSTD P/N	VERS.	LOT.	SIDE	LAY ADR
R 1365	CHIP RES.	470	1/16W	5%	RMC1/16 471JATP	J24185471		1-	A	D7
R 1366	CHIP RES.	470	1/16W	5%	RMC1/16 471JATP	J24185471		1-	A	E1
R 1367	CHIP RES.	1k	1/16W	5%	RMC1/16 102JATP	J24185102		1-	A	F7
R 1368	CHIP RES.	1k	1/16W	5%	RMC1/16 102JATP	J24185102		1-	A	F7
R 1369	CHIP RES.	33k	1/16W	5%	RMC1/16 333JATP	J24185333		1-	A	I1
R 1370	CHIP RES.	33k	1/16W	5%	RMC1/16 333JATP	J24185333		1-	A	I1
R 1371	CHIP RES.	33k	1/16W	5%	RMC1/16 333JATP	J24185333		1-	A	G1
R 1372	CHIP RES.	33k	1/16W	5%	RMC1/16 333JATP	J24185333		1-	A	H1
R 1373	CHIP RES.	10k	1/16W	5%	RMC1/16 103JATP	J24185103		1-	A	G1
R 1374	CHIP RES.	10k	1/16W	5%	RMC1/16 103JATP	J24185103		1-	A	G1
R 1375	CHIP RES.	47k	1/16W	5%	RMC1/16 473JATP	J24185473		1-	A	D7
R 1376	CHIP RES.	0	1/16W	5%	RMC1/16 000JATP	J24185000		1-	A	H1
R 1377	CHIP RES.	1k	1/16W	5%	RMC1/16 102JATP	J24185102		1-	A	I3
R 1378	CHIP RES.	100k	1/16W	5%	RMC1/16 104JATP	J24185104		1-	A	I2
R 1379	CHIP RES.	18k	1/16W	5%	RMC1/16 183JATP	J24185183		1-	A	B7
R 1380	CHIP RES.	68k	1/16W	5%	RMC1/16 683JATP	J24185683		1-	A	B7
R 1381	CHIP RES.	100k	1/16W	5%	RMC1/16 104JATP	J24185104		1-	A	B7
R 1382	CHIP RES.	8.2k	1/16W	5%	RMC1/16 822JATP	J24185822		1-	A	B6
R 1383	CHIP RES.	12k	1/16W	5%	RMC1/16 123JATP	J24185123		1-	A	E7
R 1384	CHIP RES.	220	1/16W	5%	RMC1/16 221JATP	J24185221		1-	A	E7
R 1385	CHIP RES.	220	1/16W	5%	RMC1/16 221JATP	J24185221		1-	A	E7
R 1386	CHIP RES.	220	1/16W	5%	RMC1/16 221JATP	J24185221		1-	A	D7
R 1387	CHIP RES.	220	1/16W	5%	RMC1/16 221JATP	J24185221		1-	A	D7
R 1388	CHIP RES.	2.7k	1/16W	5%	RMC1/16 272JATP	J24185272		1-		
R 1389	CHIP RES.	4.7k	1/16W	5%	RMC1/16 472JATP	J24185472		1-	A	G7
R 1390	CHIP RES.	4.7k	1/16W	5%	RMC1/16 472JATP	J24185472		1-	A	G7
R 1391	CARBON FILM RES.	100k	1/6W	5%	RD16PJ104 100K	J01225104		1-	A	I1
R 1391	CHIP RES.	100k	1/16W	5%	RMC1/16 104JATP	J24185104		1-	A	I1
R 1392	CHIP RES.	100k	1/16W	5%	RMC1/16 104JATP	J24185104		1-	A	I4
R 1393	CHIP RES.	1.2k	1/16W	5%	RMC1/16 122JATP	J24185122		1-	A	H6
S 1001	DIP SWITCH				SSGM140100	N7090148		1-	A	B2
T 1001	COIL WIDE-TRANS.				040812480	L0022904		1-	A	G1
T 1002	COIL WIDE-TRANS.				040812480	L0022904		1-	A	H1
T 1003	COIL WIDE-TRANS.				040812480	L0022904		1-	A	I1
T 1004	COIL WIDE-TRANS.				040812480	L0022904		1-	A	I5
T 1005	COIL WIDE-TRANS.				EKMA07PB07	L0021123		1-	A	I5
T 1006	COIL WIDE-TRANS.				040812479	L0022905		1-	A	I6
T 1007	COIL WIDE-TRANS.				040812479	L0022905		1-	A	I6
T 1008	COIL 07RF	47MHz			47.0M	L0021546		1-	A	I7
T 1009	COIL 07RF	47MHz			47.0M	L0021536		1-	A	H7
T 1010	COIL 07RF	47MHz			47.0M	L0021537		1-	A	H6
T 1011	COIL 07RF	47MHz			47.0M	L0021546		1-	A	G7
T 1012	COIL 07RF	47MHz			47.0M	L0021546		1-	A	G6
T 1013	COIL 07RF	90MHz			90.0M R12-S602A	L0020803		1-	A	D5
TH1001	THERMISTOR				157-152-53009-TP	G9090123		1-	A	G6
X 1002	XTAL OSC	36.864MHz			TPS11XC 36.864MHZ	H9500770		1-	A	C5
X 1003	TCXO	22.625MHz			TTS01NS-P1 22.625MHZ	H9500840		1-	A	D5
X 1004	XTAL TSS-6035B	19.82MHz			19.820MHZ	H0103262		1-	A	C3
X 1004	XTAL TSS-6035B	19.82MHz			19.820MHZ	H0103262A		7-	A	C3
XF1001	XTAL FILTER				MFT45N 45.275MHZ	H1102390		1-	A	H7
	SHIELD CASE					R0128100		1-		
	SHIELD CASE COVER					R0128110		1-		
	SHIELD CASE					R0131630		1-		

PA Unit

Note

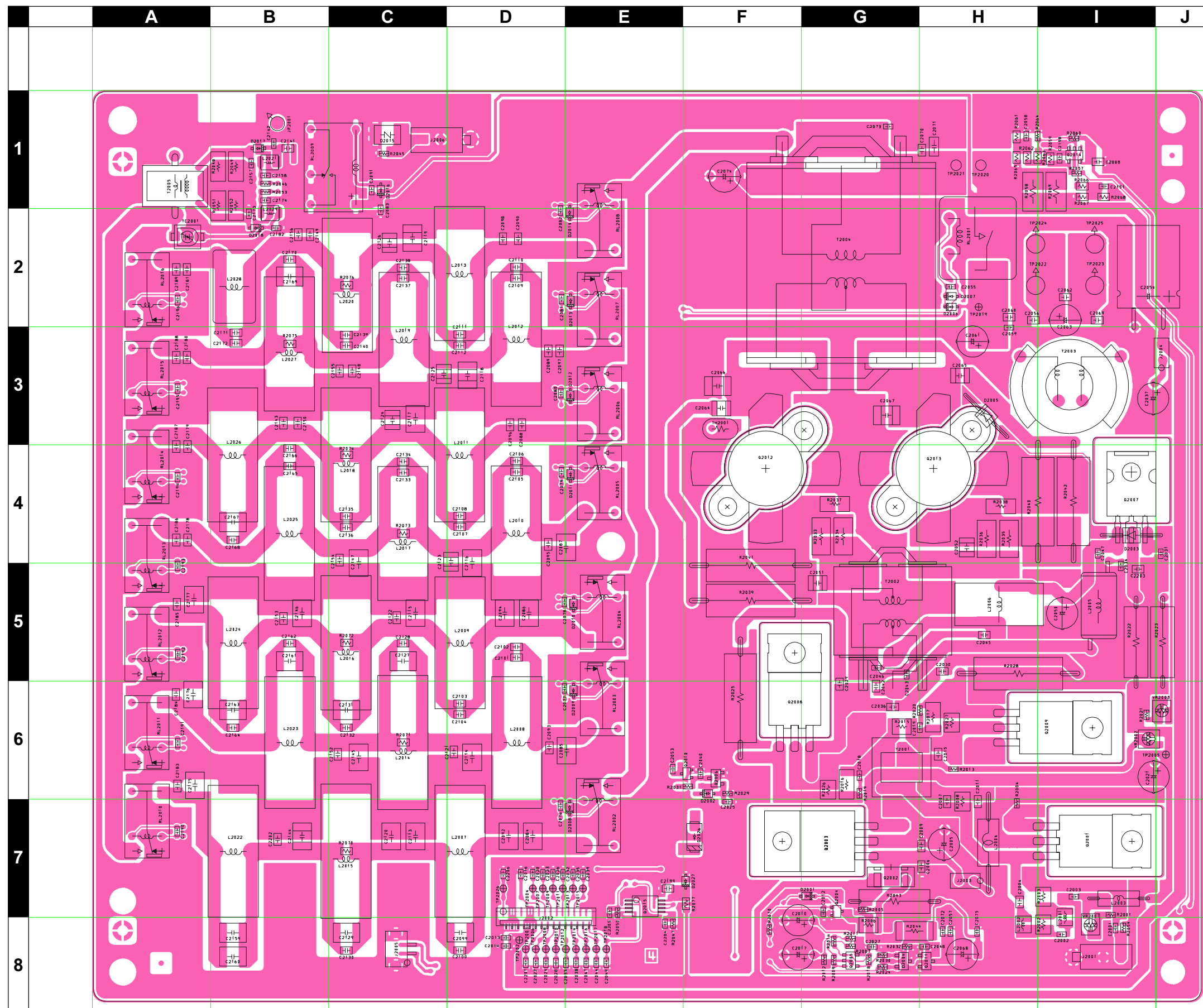
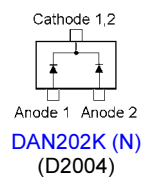
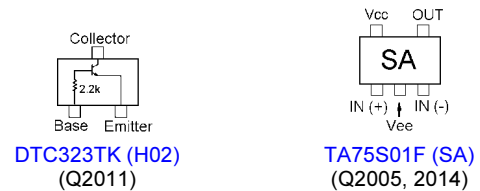
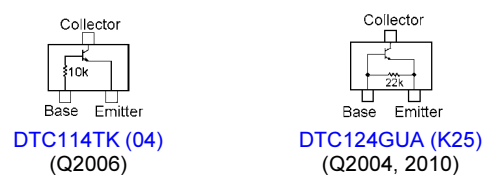
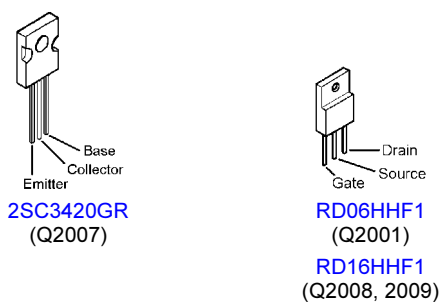
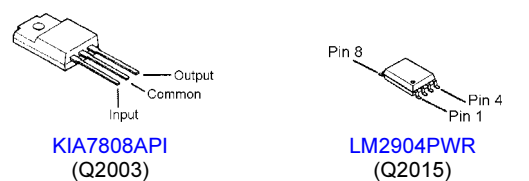
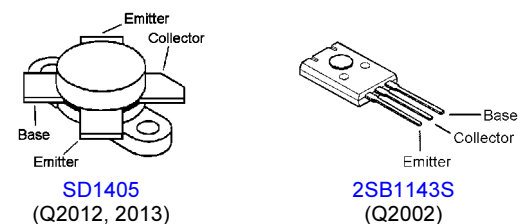

PA Unit

Parts Layout (Side B)

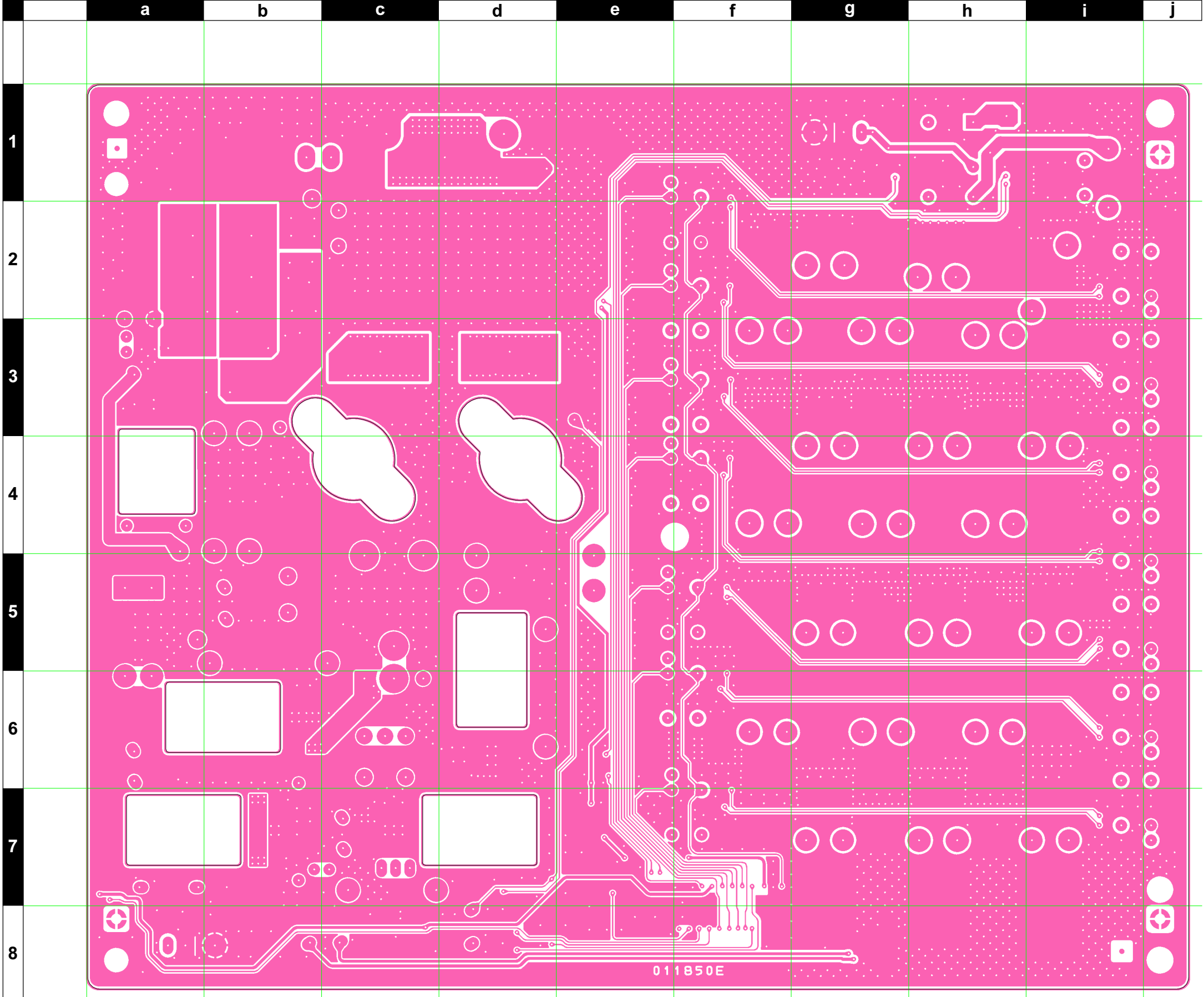

REF.	DESCRIPTION	VALUE	V/W	TOL.	MFR'S DESIG	VXSTD P/N	VERS.	LOT.	SIDE	LAY ADR
PCB with Components						CS1854001				
Printed Circuit Board				AC051H000		FR011850E		1-		
C 2001	CHIP CAP.	0.047uF	16V	B	GRM39B473K16PT	K22124804		1-	A	I8
C 2002	CHIP CAP.	470pF	50V	B	GRM188B11H471KA01D	K22174805		1-	A	I8
C 2003	CHIP CAP.	0.047uF	16V	B	GRM39B473K16PT	K22124804		1-	A	I7
C 2004	CHIP CAP.	0.047uF	50V	B	GRM40B473M50PT	K22170823		1-	A	H7
C 2005	AL.ELECTRO.CAP.	10uF	50V		RE2-50V100MMA-T2	K46170021		1-	A	H7
C 2006	CHIP CAP.	0.1uF	25V	B	GRM40B104M25PT	K22140811		1-	A	H7
C 2008	CHIP CAP.	0.1uF	25V	B	GRM40B104M25PT	K22140811		1-	A	I1
C 2009	CHIP CAP.	0.047uF	50V	B	GRM40B473M50PT	K22170823		1-	A	H7
C 2010	AL.ELECTRO.CAP.	1uF	50V		RE2-50V010MMA-T2	K46170017		1-	A	G8
C 2011	CHIP CAP.	0.1uF	25V	B	GRM40B104M25PT	K22140811		1-	A	H7
C 2012	CHIP CAP.	0.01uF	25V	B	GRM39B103K25PT	K22144803		1-	A	G7
C 2013	CHIP CAP.	0.01uF	50V	B	GRM188B11H103KA01D	K22174823		1-	A	D8
C 2015	CHIP CAP.	0.1uF	25V	B	GRM40B104M25PT	K22140811		1-	A	H6
C 2017	AL.ELECTRO.CAP.	1uF	50V		RE2-50V010MMA-T2	K46170017		1-	A	G8
C 2018	CHIP CAP.	68pF	50V	CH	GRM1882C1H680JA01D	K22174231		1-	A	G6
C 2019	CHIP CAP.	68pF	50V	CH	GRM1882C1H680JA01D	K22174231		1-	A	G6
C 2021	AL.ELECTRO.CAP.	10uF	50V		RE2-50V100MMA-T2	K46170021		1-	A	I6
C 2025	CHIP CAP.	0.01uF	50V	B	GRM188B11H103KA01D	K22174823		1-	A	F7
C 2027	CHIP CAP.	0.047uF	16V	B	GRM39B473K16PT	K22124804		1-	A	G8
C 2029	CHIP CAP.	0.047uF	50V	B	GRM40B473M50PT	K22170823		1-	A	G6
C 2030	CHIP CAP.	0.047uF	50V	B	GRM40B473M50PT	K22170823		1-	A	H5
C 2031	CHIP CAP.	0.047uF	16V	B	GRM39B473K16PT	K22124804		1-	A	J4
C 2034	CHIP CAP.	0.047uF	16V	B	GRM39B473K16PT	K22124804		1-	A	I5
C 2036	CHIP CAP.	150pF	200V	CH	GRM21B2C2D151JV01L	K22230230		1-	A	G6
C 2037	AL.ELECTRO.CAP.	10uF	50V		RE2-50V100MMA-T2	K46170021		1-	A	I3
C 2040	CHIP CAP.	0.001uF	50V	B	GRM188B11H102KA01D	K22174821		1-	A	F6
C 2042	CHIP CAP.	0.1uF	25V	B	GRM40B104M25PT	K22140811		1-	A	G6
C 2044	CHIP CAP.	0.001uF	50V	B	GRM188B11H102KA01D	K22174821		1-	A	E8
C 2047	CHIP CAP.	0.047uF	16V	B	GRM39B473K16PT	K22124804		1-	A	I4
C 2048	CHIP CAP.	0.047uF	16V	B	GRM39B473K16PT	K22124804		1-	A	H8
C 2049	CHIP CAP.	0.001uF	50V	B	GRM188B11H102KA01D	K22174821		1-	A	E8
C 2050	AL.ELECTRO.CAP.	10uF	50V		RE2-50V100MMA-T2	K46170021		1-	A	I5
C 2051	CHIP CAP.	0.1uF	250V	X7R	GRM32DR72E104KW01L	K22245801		1-	A	G5
C 2052	CHIP CAP.	0.1uF	250V	X7R	GRM32DR72E104KW01L	K22245801		1-	A	H4
C 2053	CHIP CAP.	0.01uF	50V	B	GRM188B11H103KA01D	K22174823		1-	A	E6
C 2054	AL.ELECTRO.CAP.	1000uF	16V		RE3-16V102MH3#	K40129096		1-	A	I2
C 2055	CHIP CAP.	0.047uF	16V	B	GRM39B473K16PT	K22124804		1-	A	H2
C 2057	CHIP CAP.	0.047uF	16V	B	GRM39B473K16PT	K22124804		1-	A	H8
C 2060	CHIP CAP.	0.1uF	25V	B	GRM40B104M25PT	K22140811		1-	A	H2
C 2062	CHIP CAP.	0.1uF	25V	B	GRM40B104M25PT	K22140811		1-	A	I2
C 2064	CHIP CAP.	0.1uF	250V	X7R	GRM32DR72E104KW01L	K22245801		1-	A	F3
C 2065	CHIP CAP.	0.1uF	250V	X7R	GRM32DR72E104KW01L	K22245801		1-	A	H3
C 2066	FILM CAP.	330pF	500V		UC342H3300J-T	K33279014		1-	A	F3
C 2067	FILM CAP.	330pF	500V		UC342H3300J-T	K33279014		1-	A	G3
C 2068	AL.ELECTRO.CAP.	1uF	50V		RE2-50V010MMA-T2	K46170017		1-	A	H8
C 2070	CHIP CAP.	0.047uF	50V	B	GRM40B473M50PT	K22170823		1-	A	H1
C 2071	CHIP CAP.	0.1uF	50V	B	GRM42-6B104K50PT	K22171820		1-	A	H1
C 2072	CHIP CAP.	0.001uF	50V	B	GRM188B11H102KA01D	K22174821		1-	A	H8
C 2073	CHIP CAP.	0.01uF	25V	B	GRM39B103K25PT	K22144803		1-	A	G1
C 2074	AL.ELECTRO.CAP.	10uF	50V		RE2-50V100MMA-T2	K46170021		1-	A	F1
C 2076	CHIP CAP.	0.047uF	16V	B	GRM39B473K16PT	K22124804		1-	A	D7
C 2077	CHIP CAP.	0.047uF	16V	B	GRM39B473K16PT	K22124804		1-	A	D6
C 2078	CHIP CAP.	0.047uF	16V	B	GRM39B473K16PT	K22124804		1-	A	D5
C 2079	CHIP CAP.	0.047uF	16V	B	GRM39B473K16PT	K22124804		1-	A	D4
C 2080	CHIP CAP.	0.047uF	16V	B	GRM39B473K16PT	K22124804		1-	A	D3
C 2081	CHIP CAP.	0.047uF	16V	B	GRM39B473K16PT	K22124804		1-	A	D2
C 2082	CHIP CAP.	0.047uF	16V	B	GRM39B473K16PT	K22124804		1-	A	D2

PA Unit

Parts List

REF.	DESCRIPTION	VALUE	V/W	TOL.	MFR'S DESIG	VXSTD P/N	VERS.	LOT.	SIDE	LAY ADR
C 2084	CHIP CAP.	0.001uF	500V	CH	CF43CH102J500AT	K22277222		1-	A	D7
C 2085	CHIP CAP.	820pF	500V	CH	CF43CH821J500AT	K22277220		1-	A	E6
C 2086	CHIP CAP.	560pF	500V	CH	CF43CH561J500AT	K22277216		1-	A	D5
C 2087	CHIP CAP.	330pF	500V	CH	CF43CH331J500AT	K22277210		1-	A	E4
C 2088	CHIP CAP.	120pF	200V	CH	GRM21B2C2D121JV01L	K22230229		1-	A	D3
C 2089	CHIP CAP.	160pF	500V	CH	CF43CH161J500AT	K22277203		1-	A	D3
C 2090	CHIP CAP.	100pF	200V	CH	GRM21B2C2D101JV01L	K22230228		1-	A	D2
C 2091	CHIP CAP.	0.047uF	16V	B	GRM39B473K16PT	K22124804		1-	A	C1
C 2092	CHIP CAP.	330pF	500V	CH	CF43CH331J500AT	K22277210		1-	A	D7
C 2093	CHIP CAP.	39pF	200V	CH	GRM2192C2D390JV01D	K22230223		1-	A	D6
C 2095	CHIP CAP.	39pF	200V	CH	GRM2192C2D390JV01D	K22230223		1-	A	D4
C 2096	CHIP CAP.	120pF	200V	CH	GRM21B2C2D121JV01L	K22230229		1-	A	D3
C 2098	CHIP CAP.	10pF	200V	CH	GRM2192C2D100JV01D	K22230216		1-	A	D2
C 2099	CHIP CAP.	220pF	500V	CH	CF43CH221J500AT	K22277206		1-	A	D8
C 2100	CHIP CAP.	10pF	200V	CH	GRM2192C2D100JV01D	K22230216		1-	A	D8
C 2101	CHIP CAP.	82pF	200V	CH	GRM21B2C2D820JV01L	K22230227		1-	A	D5
C 2102	CHIP CAP.	68pF	200V	CH	GRM21B2C2D680JV01L	K22230226		1-	A	D5
C 2103	FILM CAP.	100pF	500V		UC342H1000J-T	K33279031		1-	A	D6
C 2105	CHIP CAP.	56pF	200V	CH	GRM2192C2D560JV01D	K22230225		1-	A	D4
C 2106	CHIP CAP.	8pF	200V	CH	GRH708CH080D200PT	K22230201		1-	A	D4
C 2107	CHIP CAP.	39pF	200V	CH	GRM2192C2D390JV01D	K22230223		1-	A	D4
C 2108	CHIP CAP.	3pF	200V	CJ	GRM2193C2D3R0CY21D	K22230210		1-	A	D4
C 2109	CHIP CAP.	15pF	200V	CH	GRM2192C2D150JV01D	K22230218		1-	A	D2
C 2110	CHIP CAP.	12pF	200V	CH	GRM2192C2D120JV01D	K22230217		1-	A	D2
C 2111	CHIP CAP.	8pF	200V	CH	GRM2192C2D8R0DY21D	K22230214		1-	A	D3
C 2112	CHIP CAP.	8pF	200V	CH	GRM2192C2D8R0DY21D	K22230214		1-	A	D3
C 2113	CHIP CAP.	0.001uF	500V	CH	CF43CH102J500AT	K22277222		1-	A	C7
C 2114	CHIP CAP.	820pF	500V	CH	CF43CH821J500AT	K22277220		1-	A	D6
C 2115	CHIP CAP.	470pF	500V	CH	CF43CH471J500AT	K22277214		1-	A	C5
C 2116	CHIP CAP.	470pF	500V	CH	CF43CH471J500AT	K22277214		1-	A	D4
C 2117	CHIP CAP.	180pF	500V	CH	CF43CH181J500AT	K22277204		1-	A	C3
C 2118	CHIP CAP.	220pF	500V	CH	CF43CH221J500AT	K22277206		1-	A	D3
C 2119	CHIP CAP.	160pF	500V	CH	CF43CH161J500AT	K22277203		1-	A	C2
C 2120	CHIP CAP.	560pF	500V	CH	CF43CH561J500AT	K22277216		1-	A	C7
C 2121	CHIP CAP.	390pF	500V	CH	CF43CH391J500AT	K22277212		1-	A	D6
C 2122	CHIP CAP.	330pF	500V	CH	CF43CH331J500AT	K22277210		1-	A	C5
C 2123	CHIP CAP.	47pF	200V	CH	GRM2192C2D470JV01D	K22230224		1-	A	D4
C 2124	CHIP CAP.	160pF	500V	CH	CF43CH161J500AT	K22277203		1-	A	C3
C 2125	CHIP CAP.	6pF	200V	CH	GRM2192C2D6R0DY21D	K22230212		1-	A	C3
C 2127	CHIP CAP.	330pF	500V	CH	CF43CH331J500AT	K22277210		1-	A	C2
C 2128	CHIP CAP.	120pF	200V	CH	GRM21B2C2D121JV01L	K22230229		1-	A	C2
C 2129	CHIP CAP.	680pF	500V	CH	CF43CH681J500AT	K22277218		1-	A	C8
C 2130	CHIP CAP.	18pF	200V	CH	GRM2192C2D180JV01D	K22230219		1-	A	C8
C 2131	CHIP CAP.	270pF	500V	CH	CF43CH271J500AT	K22277208		1-	A	C6
C 2132	CHIP CAP.	27pF	200V	CH	GRM2192C2D270JV01D	K22230221		1-	A	C6
C 2133	CHIP CAP.	180pF	200V	CH	GRM21B2C2D181JY21L	K22230231		1-	A	C4
C 2134	CHIP CAP.	15pF	200V	CH	GRM2192C2D150JV01D	K22230218		1-	A	C4
C 2135	CHIP CAP.	120pF	200V	CH	GRM21B2C2D121JV01L	K22230229		1-	A	C4
C 2136	CHIP CAP.	8pF	200V	CH	GRM2192C2D8R0DY21D	K22230214		1-	A	C4
C 2137	CHIP CAP.	56pF	200V	CH	GRM2192C2D560JV01D	K22230225		1-	A	C2
C 2138	CHIP CAP.	27pF	200V	CH	GRM2192C2D270JV01D	K22230221		1-	A	C2
C 2139	CHIP CAP.	27pF	200V	CH	GRM2192C2D270JV01D	K22230221		1-	A	C3
C 2140	CHIP CAP.	22pF	200V	CH	GRM2192C2D220JV01D	K22230220		1-	A	C3
C 2141	CHIP CAP.	10pF	200V	CH	GRM2192C2D100JV01D	K22230216		1-	A	B1
C 2142	CHIP CAP.	220pF	50V	CH	GRM1882C1H221JA01D	K22174243		1-	A	B1
C 2143	CHIP CAP.	180pF	200V	CH	GRM21B2C2D181JY21L	K22230231		1-	A	B3
C 2144	CHIP CAP.	0.001uF	500V	CH	CF43CH102J500AT	K22277222		1-	A	B7
C 2145	CHIP CAP.	820pF	500V	CH	CF43CH821J500AT	K22277220		1-	A	C6
C 2146	CHIP CAP.	560pF	500V	CH	CF43CH561J500AT	K22277216		1-	A	B5

REF.	DESCRIPTION	VALUE	V/W	TOL.	MFR'S DESIG	VXSTD P/N	VERS.	LOT.	SIDE	LAY ADR
C 2147	CHIP CAP.	390pF	500V	CH	CF43CH391J500AT	K22277212		1-	A	C4
C 2148	CHIP CAP.	120pF	200V	CH	GRM21B2C2D121JV01L	K22230229		1-	A	C3
C 2149	CHIP CAP.	120pF	200V	CH	GRM21B2C2D121JV01L	K22230229		1-	A	B2
C 2150	CHIP CAP.	82pF	200V	CH	GRM21B2C2D820JV01L	K22230227		1-	A	B3
C 2152	FILM CAP.	120pF	500V		UC342H1200J-T	K33279026		1-	A	C6
C 2153	CHIP CAP.	56pF	200V	CH	GRM2192C2D560JV01D	K22230225		1-	A	B5
C 2154	CHIP CAP.	10pF	200V	CH	GRM2192C2D100JV01D	K22230216		1-	A	C4
C 2155	CHIP CAP.	56pF	200V	CH	GRM2192C2D560JV01D	K22230225		1-	A	C3
C 2156	CHIP CAP.	7pF	200V	CH	GRM2192C2D7R0DY21D	K22230213		1-	A	B2
C 2158	CHIP CAP.	0.022uF	25V	B	GRM39B223K25PT	K22144807		1-	A	B1
C 2159	CHIP CAP.	820pF	500V	CH	CF43CH821J500AT	K22277220		1-	A	B8
C 2160	CHIP CAP.	680pF	500V	CH	CF43CH681J500AT	K22277218		1-	A	B8
C 2161	CHIP CAP.	0.001uF	500V	CH	CF43CH102J500AT	K22277222		1-	A	B5
C 2162	CHIP CAP.	27pF	200V	CH	GRM2192C2D270JV01D	K22230221		1-	A	B5
C 2163	CHIP CAP.	560pF	500V	CH	CF43CH561J500AT	K22277216		1-	A	B6
C 2165	CHIP CAP.	390pF	500V	CH	CF43CH391J500AT	K22277212		1-	A	B4
C 2166	CHIP CAP.	47pF	200V	CH	GRM2192C2D470JV01D	K22230224		1-	A	B4
C 2167	CHIP CAP.	270pF	500V	CH	CF43CH271J500AT	K22277208		1-	A	B4
C 2168	CHIP CAP.	27pF	200V	CH	GRM2192C2D270JV01D	K22230221		1-	A	B4
C 2169	CHIP CAP.	180pF	500V	CH	CF43CH181J500AT	K22277204		1-	A	B2
C 2170	CHIP CAP.	10pF	200V	CH	GRM2192C2D100JV01D	K22230216		1-	A	B2
C 2171	CHIP CAP.	56pF	200V	CH	GRM2192C2D560JV01D	K22230225		1-	A	B3
C 2172	CHIP CAP.	47pF	200V	CH	GRM2192C2D470JV01D	K22230224		1-	A	B3
C 2173	CHIP CAP.	39pF	50V	CH	GRM1882C1H390JA01D	K22174225		1-	A	B2
C 2174	CHIP CAP.	0.022uF	25V	B	GRM39B223K25PT	K22144807		1-	A	B1
C 2175	CHIP CAP.	560pF	500V	CH	CF43CH561J500AT	K22277216		1-	A	A6
C 2176	CHIP CAP.	390pF	500V	CH	CF43CH391J500AT	K22277212		1-	A	A6
C 2177	CHIP CAP.	270pF	500V	CH	CF43CH271J500AT	K22277208		1-	A	A5
C 2178	CHIP CAP.	180pF	500V	CH	CF43CH181J500AT	K22277204		1-	A	A4
C 2179	CHIP CAP.	120pF	500V	CH	CF32CH121J500AT	K22275247		1-	A	A4
C 2180	CHIP CAP.	56pF	200V	CH	GRM2192C2D560JV01D	K22230225		1-	A	A3
C 2181	CHIP CAP.	39pF	200V	CH	GRM2192C2D390JV01D	K22230223		1-	A	A2
C 2182	CHIP CAP.	220pF	50V	CH	GRM1882C1H221JA01D	K22174243		1-	A	B2
C 2183	CHIP CAP.	100pF	200V	CH	GRM21B2C2D101JV01L	K22230228		1-	A	A6
C 2184	CHIP CAP.	39pF	200V	CH	GRM2192C2D390JV01D	K22230223		1-	A	A6
C 2188	CHIP CAP.	22pF	200V	CH	GRM2192C2D220JV01D	K22230220		1-	A	A3
C 2189	CHIP CAP.	22pF	200V	CH	GRM2192C2D220JV01D	K22230220		1-	A	A2
C 2190	CHIP CAP.	0.047uF	16V	B	GRM39B473K16PT	K22124804		1-	A	A7
C 2191	CHIP CAP.	0.047uF	16V	B	GRM39B473K16PT	K22124804		1-	A	A6
C 2192	CHIP CAP.	0.047uF	16V	B	GRM39B473K16PT	K22124804		1-	A	A5
C 2193	CHIP CAP.	0.047uF	16V	B	GRM39B473K16PT	K22124804		1-	A	A5
C 2194	CHIP CAP.	0.047uF	16V	B	GRM39B473K16PT	K22124804		1-	A	A4
C 2195	CHIP CAP.	0.047uF	16V	B	GRM39B473K16PT	K22124804		1-	A	A3
C 2196	CHIP CAP.	0.047uF	16V	B	GRM39B473K16PT	K22124804		1-	A	A2
C 2199	CHIP CAP.	0.1uF	25V	B	GRM40B104M25PT	K22140811		1-	A	E7
C 2201	CHIP CAP.	0.01uF	50V	B	GRM188B11H103KA01D	K22174823		1-	A	D8
C 2202	CHIP CAP.	470pF	500V	CH	CF43CH471J500AT	K22277214		1-		
C 2203	CHIP CAP.	0.1uF	25V	B	GRM40B104M25PT	K22140811		1-	A	I5
C 2204	CHIP CAP.	0.001uF	50V	B	GRM188B11H102KA01D	K22174821		1-	A	E8
C 2205	CHIP CAP.	0.001uF	50V	B	GRM188B11H102KA01D	K22174821		1-	A	E7
C 2207	FILM CAP.	100pF	500V		UC342H1000J-T	K33279031		1-		
C 2208	CHIP CAP.	330pF	500V	CH	CF43CH331J500AT	K22277210		1-		
C 2301	CHIP CAP.	680pF	500V	CH	CF43CH681J500AT	K22277218		1-		
C 2302	FILM CAP.	820pF	500V		UC552H8200J-T	K33279016		1-		
C 2303	FILM CAP.	470pF	500V		UC342H4700J-T	K33279015		1-		
D 2001	DIODE				BAS316	G2070716		1-	A	G7
D 2002	DIODE				UDZS TE-17 16B	G2070914		1-	A	F6
D 2003	DIODE				10EDB10	G2090781		1-	A	I4
D 2004	DIODE				DAN202K T146	G2070182		1-	A	G8

PA Unit

Parts List

REF.	DESCRIPTION	VALUE	V/W	TOL.	MFR'S DESIG	VXSTD P/N	VERS.	LOT.	SIDE	LAY ADR
D 2005	DIODE				10EDB10	G2090781		1-	A	H3
D 2006	DIODE				BAS316	G2070716		1-	A	H2
D 2007	DIODE				BAS316	G2070716		1-	A	H2
D 2008	DIODE				BAS316	G2070716		1-	A	E7
D 2009	DIODE				BAS316	G2070716		1-	A	E6
D 2010	DIODE				BAS316	G2070716		1-	A	E5
D 2011	DIODE				BAS316	G2070716		1-	A	E4
D 2012	DIODE				BAS316	G2070716		1-	A	E3
D 2013	DIODE				BAS316	G2070716		1-	A	E2
D 2014	DIODE				BAS316	G2070716		1-	A	E2
D 2015	SURGE ABSORBER				RHCA-301Q43U	Q9000827		1-	A	C1
D 2016	DIODE				BAS316	G2070716		1-	A	C1
D 2017	DIODE				MA729-(TX)	G2070320		1-	A	B1
D 2018	DIODE				MA729-(TX)	G2070320		1-	A	B2
D 2026	DIODE				RB060L-40 TE25	G2070744		1-	A	F7
D 2027	DIODE				UDZS TE-17 6.8B	G2070888		1-	A	F7
J 2001	CONNECTOR				TMP-S01X-C1	P1091254		1-	A	I8
J 2002	CONNECTOR				30FLT-SM1-TB	P1091142		1-	A	D8
J 2003	CONNECTOR				IMSA-9202B-1-02-T	P0091174		1-	A	H7
J 2004	CONNECTOR				IMSA-9202B-1-02-T	P0091174		1-	A	J3
J 2005	CONNECTOR				B2B-ZR-SM3-TFT	P0091342		1-	A	C8
J 2006	CONNECTOR				TMP-S01X-C1	P1091254		1-	A	C1
JP2001	WIRE ASSY				VIO 30 <5>/<5>	T9318189		1-	A	B1
L 2001	CHIP COIL	1.5uH			C2520C-1R5K	L1690729		1-	A	I7
L 2002	CHIP COIL	0.56uH			C2520C-R56J	L1690553		1-	A	H8
L 2003	M.RFC	33uH			LAL03TA330K	L1790101		1-	A	I7
L 2004	M.RFC	2.2uH			LAL04NA2R2M	L1190319		1-	A	H7
L 2005	RFC WITH BEADS				FB-43-5111	L1020015		1-	A	I4
L 2006	TOROIDAL COIL	41uH			41.00U 3A FR9.5*5	L0021432		1-	A	H5
L 2007	TOROIDAL COIL	3.22uH			3.22U T68-2	L0022858		1-	A	D7
L 2008	TOROIDAL COIL	2.24uH			2.24U T68-2	L0022860		1-	A	D6
L 2009	TOROIDAL COIL	1.38uH			1.38U T68-6	L0022956		1-	A	D5
L 2010	TOROIDAL COIL	0.84uH			0.84U T68-6	L0022912		1-	A	D4
L 2011	TOROIDAL COIL	0.62uH			0.62U T68-6	L0022949		1-	A	D4
L 2012	TOROIDAL COIL	0.35uH			0.35U T68-6	L0022951		1-	A	D3
L 2013	TOROIDAL COIL	0.27uH			0.27U T68-6	L0022909		1-	A	D2
L 2014	TOROIDAL COIL	1.61uH			1.61U T68-2	L0022862		1-	A	C6
L 2015	TOROIDAL COIL	2.69uH			2.69U T68-2	L0022859		1-	A	C7
L 2016	TOROIDAL COIL	1.1uH			1.10U T68-6	L0022914		1-	A	C5
L 2017	TOROIDAL COIL	0.72uH			0.72U T68-6	L0022911		1-	A	C4
L 2018	TOROIDAL COIL	0.52uH			0.52U T68-6	L0022952		1-	A	C4
L 2019	TOROIDAL COIL	0.27uH			0.27U T68-6	L0022909		1-	A	C3
L 2020	TOROIDAL COIL	0.21uH			0.21U T68-6	L0022953		1-	A	B2
L 2021	M.RFC	470uH			FLC32T-471J	L1690235		1-	A	B1
L 2022	TOROIDAL COIL	1.51uH			1.51U T68-2	L0022955		1-	A	B7
L 2023	TOROIDAL COIL	0.85uH			0.85U T68-2	L0022863		1-	A	B6
L 2024	TOROIDAL COIL	0.72uH			0.72U T68-6	L0022911		1-	A	B5
L 2025	TOROIDAL COIL	0.43uH			0.43U T68-6	L0022910		1-	A	B4
L 2026	TOROIDAL COIL	0.27uH			0.27U T68-6	L0022909		1-	A	B4
L 2027	TOROIDAL COIL	0.21uH			0.21U T68-6	L0022953		1-	A	B3
L 2028	COIL A1				3.5T9.0D1.2UEW R	L0022145		1-	A	B2
L 2029	M.RFC	470uH			FLC32T-471J	L1690235		1-	A	B2
P 2001	CONNECTOR				IMSA-9206H-T	P1090988		1-	A	
P 2002	WIRE ASSY				AC051H	T9207202A		1-	A	
P 2003	CONNECTOR				IMSA-9206H-T	P1090988		1-	A	
P 2004	TERMINAL				B3	Q6000113		1-	A	
Q 2001	FET				RD06HHF1-01	G3090145		1-	A	I7
Q 2002	TRANSISTOR				2SB1143S	G3211430S		1-	A	G7
Q 2003	IC				KIA7808API	G1093164		1-	A	G7

REF.	DESCRIPTION	VALUE	V/W		MFR'S DESIG	VXSTD P/N	VERS.		SIDE	LAY ADR
Q 2004	TRANSISTOR				DTC124GUA T106	G3070184		1-	A	G7
Q 2005	IC				TA75S01F TE85R	G1091593		1-	A	G8
Q 2006	TRANSISTOR				DTC114TK T146	G3070073		1-	A	I7
Q 2007	TRANSISTOR				2SC3420GR	G3334200G		1-	A	G7
Q 2008	FET				RD16HHF1	G3090148		1-	A	F7
Q 2009	FET				RD16HHF1	G3090148		1-	A	G8
Q 2010	TRANSISTOR				DTC124GUA T106	G3070184		1-	A	F6
Q 2011	TRANSISTOR				DTC323TK T146	G3070042		1-	A	I4
Q 2012	TRANSISTOR				2SC2879A	G3328790A		1-	A	F5
Q 2013	TRANSISTOR				2SC2879A	G3328790A		1-	A	I6
Q 2015	IC				LM2904PWR	G1094010		1-	A	F6
R 2001	CHIP RES.	470	1/16W	5%	RMC1/16 471JATP	J24185471		1-	A	F4
R 2002	CHIP RES.	150	1/4W	5%	RMC1/4 151JATP	J24245151		1-	A	F4
R 2003	CHIP RES.	150	1/4W	5%	RMC1/4 151JATP	J24245151		1-	A	G4
R 2004	CHIP RES.	1.8k	1/16W	5%	RMC1/16 182JATP	J24185182		1-	A	G4
R 2005	CHIP RES.	10k	1/16W	5%	RMC1/16 103JATP	J24185103		1-	A	I1
R 2006	CHIP RES.	1k	1/4W	5%	RMC1/4 102JATP	J24245102		1-	A	E7
R 2007	CHIP RES.	2.7k	1/16W	5%	RMC1/16 272JATP	J24185272		1-	A	I7
R 2009	CHIP RES.	10k	1/16W	5%	RMC1/16 103JATP	J24185103		1-	A	I7
R 2010	CHIP RES.	10k	1/16W	5%	RMC1/16 103JATP	J24185103		1-	A	I8
R 2011	CHIP RES.	1.8k	1/16W	5%	RMC1/16 182JATP	J24185182		1-	A	I7
R 2012	CHIP RES.	2.7k	1/16W	5%	RMC1/16 272JATP	J24185272		1-	A	H7
R 2013	CHIP RES.	0	1/16W	5%	RMC1/16 000JATP	J24185000		1-	A	G7
R 2014	CHIP RES.	10k	1/16W	5%	RMC1/16 103JATP	J24185103		1-	A	G8
R 2015	CHIP RES.	470	1/4W	5%	RMC1/4 471JATP	J24245471		1-	A	G8
R 2016	CHIP RES.	100	1/2W	5%	RK73B2HTTE101J	J24279017		1-	A	G8
R 2017	CHIP RES.	100	1/2W	5%	RK73B2HTTE101J	J24279017		1-	A	F8
R 2018	CHIP RES.	100k	1/16W	5%	RMC1/16 104JATP	J24185104		1-	A	G8
R 2019	CHIP RES.	100	1/16W	5%	RMC1/16 101JATP	J24185101		1-	A	G8
R 2020	CHIP RES.	100	1/16W	5%	RMC1/16 101JATP	J24185101		1-	A	H6
R 2021	CHIP RES.	390	1/16W	5%	RMC1/16 391JATP	J24185391		1-	A	G6
R 2022	METAL FILM RES.	8.2	2W	5%	ERX-2SJ8R2P 8.2	J22339020		1-	A	G6
R 2023	METAL FILM RES.	8.2	2W	5%	ERX-2SJ8R2P 8.2	J22339020		1-	A	H6
R 2024	CHIP RES.	2.2k	1/16W	5%	RMC1/16 222JATP	J24185222		1-	A	G8
R 2025	METAL FILM RES.	470	3W	5%	ERG-3SJ471P 470	J22359019		1-	A	G6
R 2026	CHIP RES.	1k	1/4W	5%	RMC1/4 102JATP	J24245102		1-	A	G6
R 2027	CHIP RES.	1k	1/4W	5%	RMC1/4 102JATP	J24245102		1-	A	I6
R 2028	METAL FILM RES.	470	3W	5%	ERG-3SJ471P 470	J22359019		1-	A	I6
R 2029	CHIP RES.	1k	1/16W	5%	RMC1/16 102JATP	J24185102		1-	A	I6
R 2030	CHIP RES.	2.2k	1/16W	5%	RMC1/16 222JATP	J24185222		1-	A	J6
R 2031	CHIP RES.	10k	1/16W	5%	RMC1/16 103JATP	J24185103		1-	A	G8
R 2032	CHIP RES.	47k	1/16W	5%	RMC1/16 473JATP	J24185473		1-	A	F6
R 2033	CHIP RES.	1	1W	5%	RMC1 1R0JTE	J24305010		1-	A	G6
R 2034	CHIP RES.	1	1W	5%	RMC1 1R0JTE	J24305010		1-	A	H6
R 2035	CHIP RES.	1	1W	5%	RMC1 1R0JTE	J24305010		1-	A	I5
R 2036	CHIP RES.	1	1W	5%	RMC1 1R0JTE	J24305010		1-	A	F6
R 2037	CHIP RES.	10	1/2W	5%	RK73B2HTTE100J	J24279005		1-	A	G8
R 2038	CHIP RES.	10	1/2W	5%	RK73B2HTTE100J	J24279005		1-	A	F6
R 2039	METAL FILM RES.	100	3W	5%	ERG-3SJ101P 100	J22359023		1-	A	G8
R 2040	METAL FILM RES.	100	3W	5%	ERG-3SJ101P 100	J22359023		1-	A	G4
R 2041	METAL FILM RES.	100	3W	5%	ERG-3SJ101P 100	J22359023		1-	A	G4
R 2042	METAL FILM RES.	100	3W	5%	ERG-3SJ101P 100	J22359023		1-	A	H4
R 2043	METAL FILM RES.	15	2W	5%	ERG-2SJ150P 15	J22339023		1-	A	H4
R 2044	CHIP RES.	56	1W	5%	RMC1 560JTE	J24305560		1-	A	G4
R 2045	CHIP RES.	47k	1/16W	5%	RMC1/16 473JATP	J24185473		1-	A	H4
R 2046	CHIP RES.	6.8k	1/16W	5%	RMC1/16 682JATP	J24185682		1-	A	G5
R 2047	CHIP RES.	10k	1/16W	5%	RMC1/16 103JATP	J24185103		1-	A	H3
R 2048	CHIP RES.	56	1/2W	5%	RMC1/2 560JTE	J24275560		1-	A	G5
R 2049	CHIP RES.	56	1/2W	5%	RMC1/2 560JTE	J24275560		1-	A	I4

PA Unit

Parts List

REF.	DESCRIPTION	VALUE	V/W	TOL.	MFR'S DESIG	VXSTD P/N	VERS.	LOT.	SIDE	LAY ADR
R 2050	CHIP RES.	10k	1/16W	5%	RMC1/16 103JATP	J24185103		1-	A	H7
R 2051	CHIP RES.	56	1/2W	5%	RMC1/2 560JTE	J24275560		1-	A	G8
R 2052	CHIP RES.	56	1/2W	5%	RMC1/2 560JTE	J24275560		1-	A	C1
R 2053	CHIP RES.	1k	1/16W	5%	RMC1/16 102JATP	J24185102		1-	A	B1
R 2054	CHIP RES.	150	1/16W	5%	RMC1/16 151JATP	J24185151		1-	A	E8
R 2077	CHIP RES.	560	1/10W	5%	RMC1/10T 561J	J24205561		1-	A	C7
RL2001	RELAY		DC12V		ACP331 DC12V	M1190175		1-	A	C6
RL2002	RELAY		DC12V		G5V-1 DC12V	M1190120		1-	A	C5
RL2003	RELAY		DC12V		G5V-1 DC12V	M1190120		1-	A	C4
RL2004	RELAY		DC12V		G5V-1 DC12V	M1190120		1-	A	C4
RL2005	RELAY		DC12V		G5V-1 DC12V	M1190120		1-	A	B3
RL2006	RELAY		DC12V		G5V-1 DC12V	M1190120		1-	A	C2
RL2007	RELAY		DC12V		G5V-1 DC12V	M1190120		1-	A	F7
RL2008	RELAY		DC12V		G5V-1 DC12V	M1190120		1-	A	H1
RL2009	RELAY		DC12V		AG231344 DC12V	M1190145		1-	A	E6
RL2010	RELAY		DC12V		G5V-1 DC12V	M1190120		1-	A	E5
RL2011	RELAY		DC12V		G5V-1 DC12V	M1190120		1-	A	E5
RL2012	RELAY		DC12V		G5V-1 DC12V	M1190120		1-	A	E4
RL2013	RELAY		DC12V		G5V-1 DC12V	M1190120		1-	A	E3
RL2014	RELAY		DC12V		G5V-1 DC12V	M1190120		1-	A	E2
RL2015	RELAY		DC12V		G5V-1 DC12V	M1190120		1-	A	E1
RL2016	RELAY		DC12V		G5V-1 DC12V	M1190120		1-	A	C1
T 2001	COIL 10WIDE				#223153	L0022857		1-	A	A7
T 2002	COIL PWR-WIDE				D12A RIB10	L0022249A		1-	A	A6
T 2003	TOROIDAL COIL				D12A R116X8X8(H007)	L0022745		1-	A	A5
T 2004	COIL PWR-WIDE				#223152	L0022856		1-	A	A5
T 2005	COIL WIDE-TRANS.				#223093	L0022792		1-	A	A4
TC2001	TRIMMER CAP.	20pF			ECR-JA020E11X	K91000228		1-	A	A3
TH2001	THERMISTOR				112103-2	G9090043		1-	A	A2
TP2020	TERMINAL				TP-H MK-10160	Q5000037		1-	A	H6
TP2021	TERMINAL				TP-H MK-10160	Q5000037		1-	A	G5
VR2001	POT.	2.2k			EVN-5ESX50BE3	J51811222		1-	A	G1
VR2002	POT.	1k			EVN-5ESX50B13	J51811102		1-	A	A1
VR2003	POT.	470			EVN-5ESX50BQ2	J51811471		1-	A	A2

PANEL Unit

Circuit Diagram

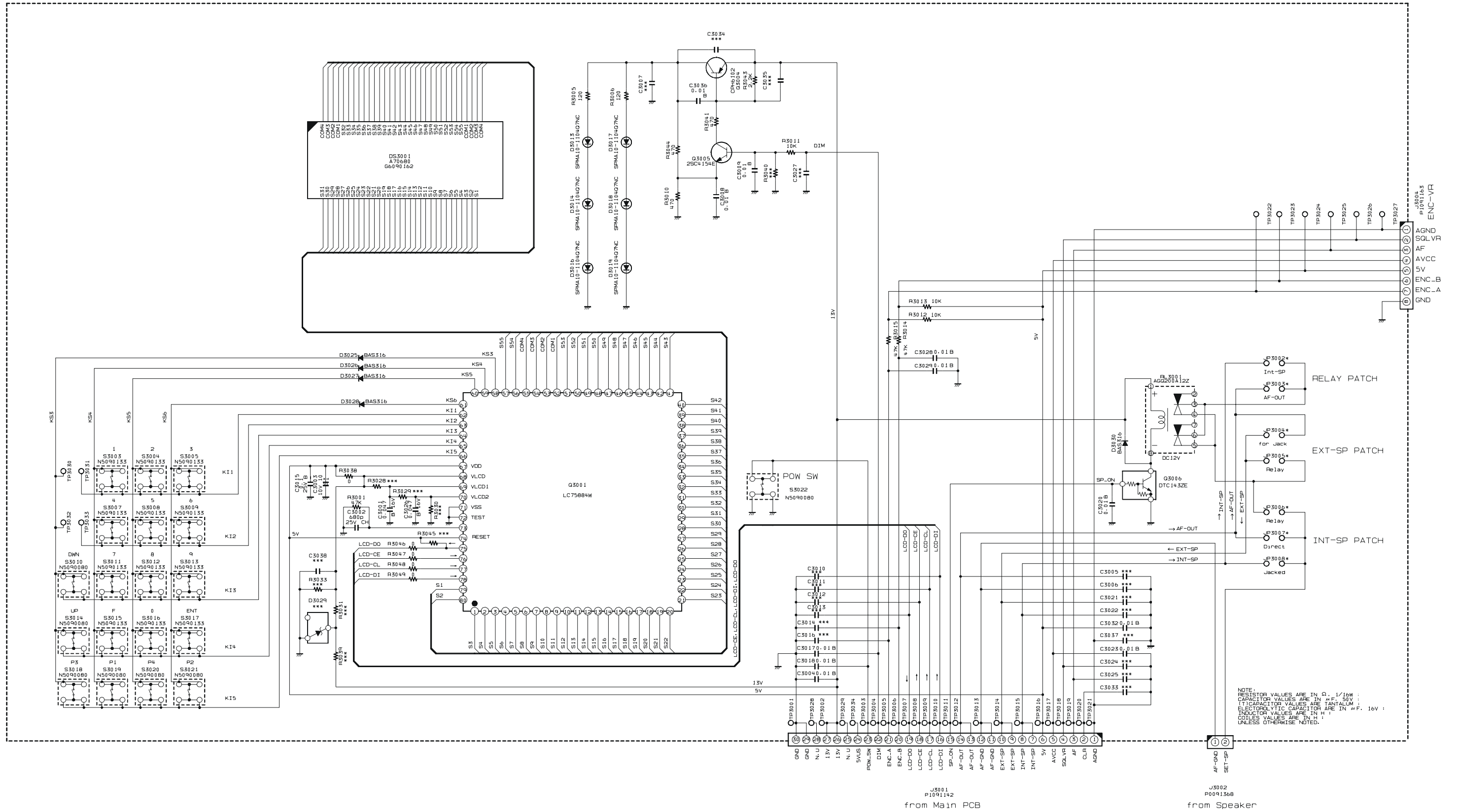

PANEL Unit

Note

PANEL Unit
Parts Layout (Side A)

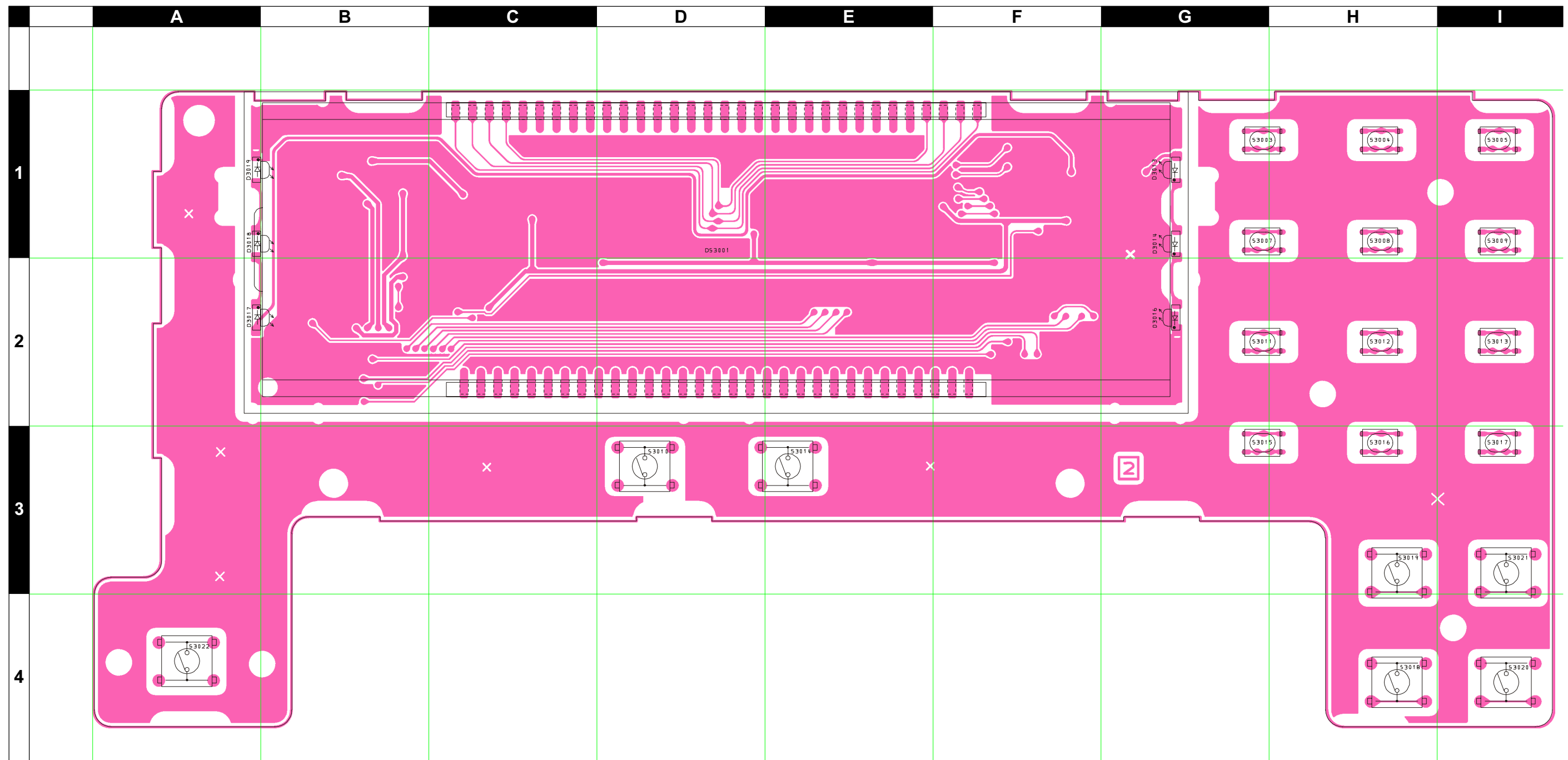

PANEL Unit

Parts Layout (Side B)

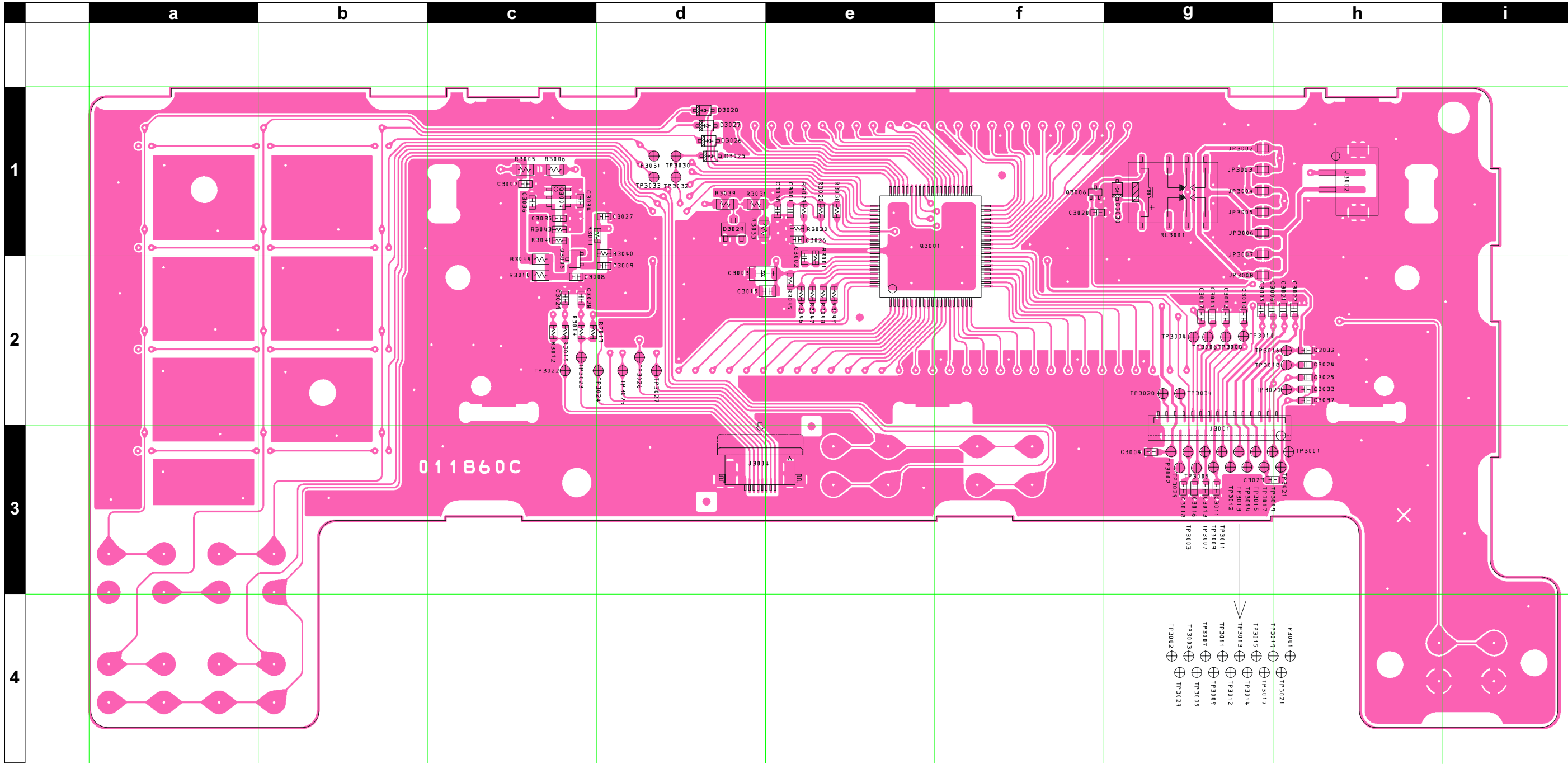

REF.	DESCRIPTION	VALUE	V/W	TOL.	MFR'S DESIG	VXSTD P/N	VERS.	LOT.	SIDE	LAY ADR
PCB with Components						CB2833001				
Printed Circuit Board					AC051H000	FR0118600		1-		
C 3001	CHIP CAP.	0.047uF	16V	B	GRM39B473K16PT	K22124804		1-	B	e1
C 3002	CHIP CAP.	680pF	25V	CH	GRM39CH681J25PT	K22144203		1-	B	e2
C 3003	CHIP TA.CAP.	10uF	10V		TEMSVA1A106M-8R	K78100028		1-	B	d2
C 3004	CHIP CAP.	0.01uF	50V	B	GRM188B11H103KA01D	K22174823		1-	B	g3
C 3008	CHIP CAP.	0.01uF	50V	B	GRM188B11H103KA01D	K22174823		1-	B	c2
C 3009	CHIP CAP.	0.01uF	50V	B	GRM188B11H103KA01D	K22174823		1-	B	d2
C 3015	CHIP CAP.	0.1uF	25V	B	GRM40B104M25PT	K22140811		1-	B	e2
C 3017	CHIP CAP.	0.01uF	50V	B	GRM188B11H103KA01D	K22174823		1-	B	g2
C 3018	CHIP CAP.	0.01uF	50V	B	GRM188B11H103KA01D	K22174823		1-	B	g3
C 3020	CHIP CAP.	0.01uF	50V	B	GRM188B11H103KA01D	K22174823		1-	B	f1
C 3023	CHIP CAP.	0.01uF	50V	B	GRM188B11H103KA01D	K22174823		1-	B	g3
C 3026	CHIP CAP.	0.047uF	16V	B	GRM39B473K16PT	K22124804		1-	B	e1
C 3028	CHIP CAP.	0.01uF	50V	B	GRM188B11H103KA01D	K22174823		1-	B	c2
C 3029	CHIP CAP.	0.01uF	50V	B	GRM188B11H103KA01D	K22174823		1-	B	c2
C 3032	CHIP CAP.	0.01uF	50V	B	GRM188B11H103KA01D	K22174823		1-	B	h2
C 3036	CHIP CAP.	0.01uF	50V	B	GRM188B11H103KA01D	K22174823		1-	B	c1
D 3013	LED				SPMA10-1104Q7NC	G2070878		1-	A	G1
D 3014	LED				SPMA10-1104Q7NC	G2070878		1-	A	G1
D 3016	LED				SPMA10-1104Q7NC	G2070878		1-	A	G2
D 3017	LED				SPMA10-1104Q7NC	G2070878		1-	A	A2
D 3018	LED				SPMA10-1104Q7NC	G2070878		1-	A	A1
D 3019	LED				SPMA10-1104Q7NC	G2070878		1-	A	A1
D 3025	DIODE				BAS316	G2070716		1-	B	d1
D 3026	DIODE				BAS316	G2070716		1-	B	d1
D 3027	DIODE				BAS316	G2070716		1-	B	d1
D 3028	DIODE				BAS316	G2070716		1-	B	d1
D 3030	DIODE				BAS316	G2070716		1-	B	g1
DS3001	LCD				A70680	G6090162		1-	A	D1
J 3001	CONNECTOR				30FLT-SM1-TB	P1091142		1-	B	g2
J 3002	CONNECTOR				B2B-PH-SM3-TBT	P0091368		1-	B	h1
J 3004	CONNECTOR				52746-0890	P1091163		1-	B	d3
JP3003	CHIP RES.	0	1/16W	5%	RMC1/16 000JATP	J24185000		1-	B	g1
JP3005	CHIP RES.	0	1/16W	5%	RMC1/16 000JATP	J24185000		1-	B	g1
JP3008	CHIP RES.	0	1/16W	5%	RMC1/16 000JATP	J24185000		1-	B	g2
Q 3001	IC				LC75884W	G1094014		1-	B	e1
Q 3004	TRANSISTOR				CPH6102-TL	G3070223		1-	B	c1
Q 3005	TRANSISTOR				2SC4154-T11-1E	G3341548E		1-	B	c2
Q 3006	TRANSISTOR				DTC143ZE TL	G3070102		1-	B	f1
R 3001	CHIP RES.	47k	1/16W	5%	RMC1/16 473JATP	J24185473		1-	B	e2
R 3005	CHIP RES.	120	1/10W	5%	RMC1/10T 121J	J24205121		1-	B	c1
R 3006	CHIP RES.	120	1/10W	5%	RMC1/10T 121J	J24205121		1-	B	c1
R 3010	CHIP RES.	470	1/10W	5%	RMC1/10T 471J	J24205471		1-	B	c2
R 3011	CHIP RES.	10k	1/16W	5%	RMC1/16 103JATP	J24185103		1-	B	c1
R 3012	CHIP RES.	10k	1/16W	5%	RMC1/16 103JATP	J24185103		1-	B	c2
R 3013	CHIP RES.	10k	1/16W	5%	RMC1/16 103JATP	J24185103		1-	B	c2
R 3014	CHIP RES.	47k	1/16W	5%	RMC1/16 473JATP	J24185473		1-	B	c2
R 3015	CHIP RES.	47k	1/16W	5%	RMC1/16 473JATP	J24185473		1-	B	c2
R 3038	CHIP RES.	0	1/16W	5%	RMC1/16 000JATP	J24185000		1-	B	e1
R 3041	CHIP RES.	470	1/16W	5%	RMC1/16 471JATP	J24185471		1-	B	c1
R 3043	CHIP RES.	2.2k	1/16W	5%	RMC1/16 222JATP	J24185222		1-	B	c1
R 3044	CHIP RES.	470	1/10W	5%	RMC1/10T 471J	J24205471		1-	B	c2
R 3046	CHIP RES.	0	1/16W	5%	RMC1/16 000JATP	J24185000		1-	B	e2
R 3047	CHIP RES.	0	1/16W	5%	RMC1/16 000JATP	J24185000		1-	B	e2
R 3048	CHIP RES.	0	1/16W	5%	RMC1/16 000JATP	J24185000		1-	B	e2
R 3049	CHIP RES.	0	1/16W	5%	RMC1/16 000JATP	J24185000		1-	B	e2
RL3001	RELAY		DC12V		AGQ200A12Z DC12V	M1190188		1-	B	g1
S 3003	TACT SWITCH				SKRPABE010	N5090133		1-	A	G1

PANEL Unit

Parts List

REF.	DESCRIPTION	VALUE	V/W	TOL.	MFR'S DESIG	VXSTD P/N	VERS.	LOT.	SIDE	LAY ADR
S 3004	TACT SWITCH				SKRPABE010	N5090133		1-	A	H1
S 3005	TACT SWITCH				SKRPABE010	N5090133		1-	A	I1
S 3007	TACT SWITCH				SKRPABE010	N5090133		1-	A	G1
S 3008	TACT SWITCH				SKRPABE010	N5090133		1-	A	H1
S 3009	TACT SWITCH				SKRPABE010	N5090133		1-	A	I1
S 3010	TACT SWITCH				SKHHDU	N5090080		1-	A	D3
S 3011	TACT SWITCH				SKRPABE010	N5090133		1-	A	G2
S 3012	TACT SWITCH				SKRPABE010	N5090133		1-	A	H2
S 3013	TACT SWITCH				SKRPABE010	N5090133		1-	A	I2
S 3014	TACT SWITCH				SKHHDU	N5090080		1-	A	E3
S 3015	TACT SWITCH				SKRPABE010	N5090133		1-	A	G3
S 3016	TACT SWITCH				SKRPABE010	N5090133		1-	A	H3
S 3017	TACT SWITCH				SKRPABE010	N5090133		1-	A	I3
S 3018	TACT SWITCH				SKHHDU	N5090080		1-	A	H4
S 3019	TACT SWITCH				SKHHDU	N5090080		1-	A	H3
S 3020	TACT SWITCH				SKHHDU	N5090080		1-	A	I4
S 3021	TACT SWITCH				SKHHDU	N5090080		1-	A	I3
S 3022	TACT SWITCH				SKHHDU	N5090080		1-	A	A4
	DIFFUSER SHEET				(LCD)	RA0727100		1-		
	REFLECTOR SHEET				(BLIND)	RA0727200		1-		
	LIGHT GUIDE				(LCD)	RA0695900		1-		
	LCD HOLDER					RA0696000		1-		
	REFLECTOR SHEET					RA069610A		1-		
	INTER CONNECTOR					RA0695800		1-		
	SPONGE RUBBER				(LCD)	RA0696200		1-		

GPS-INTERFACE Unit

Circuit Diagram

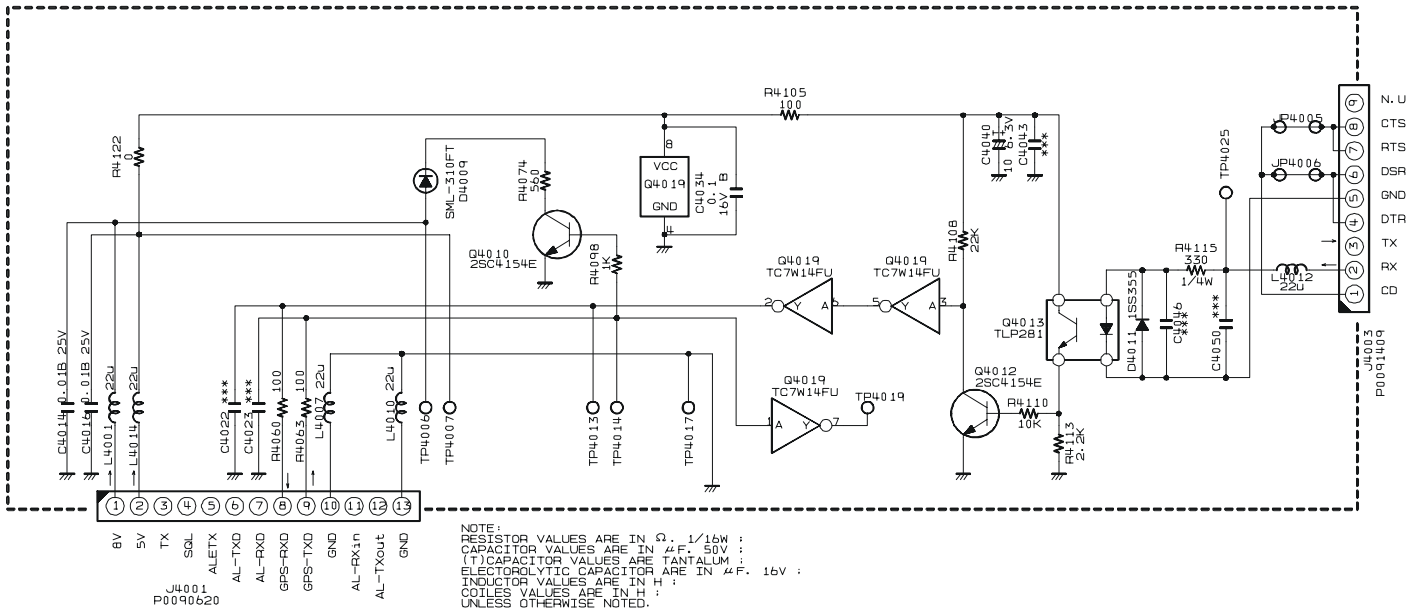

GPS-INTERFACE Unit

Parts Layout (Side A)

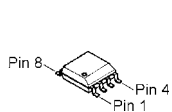
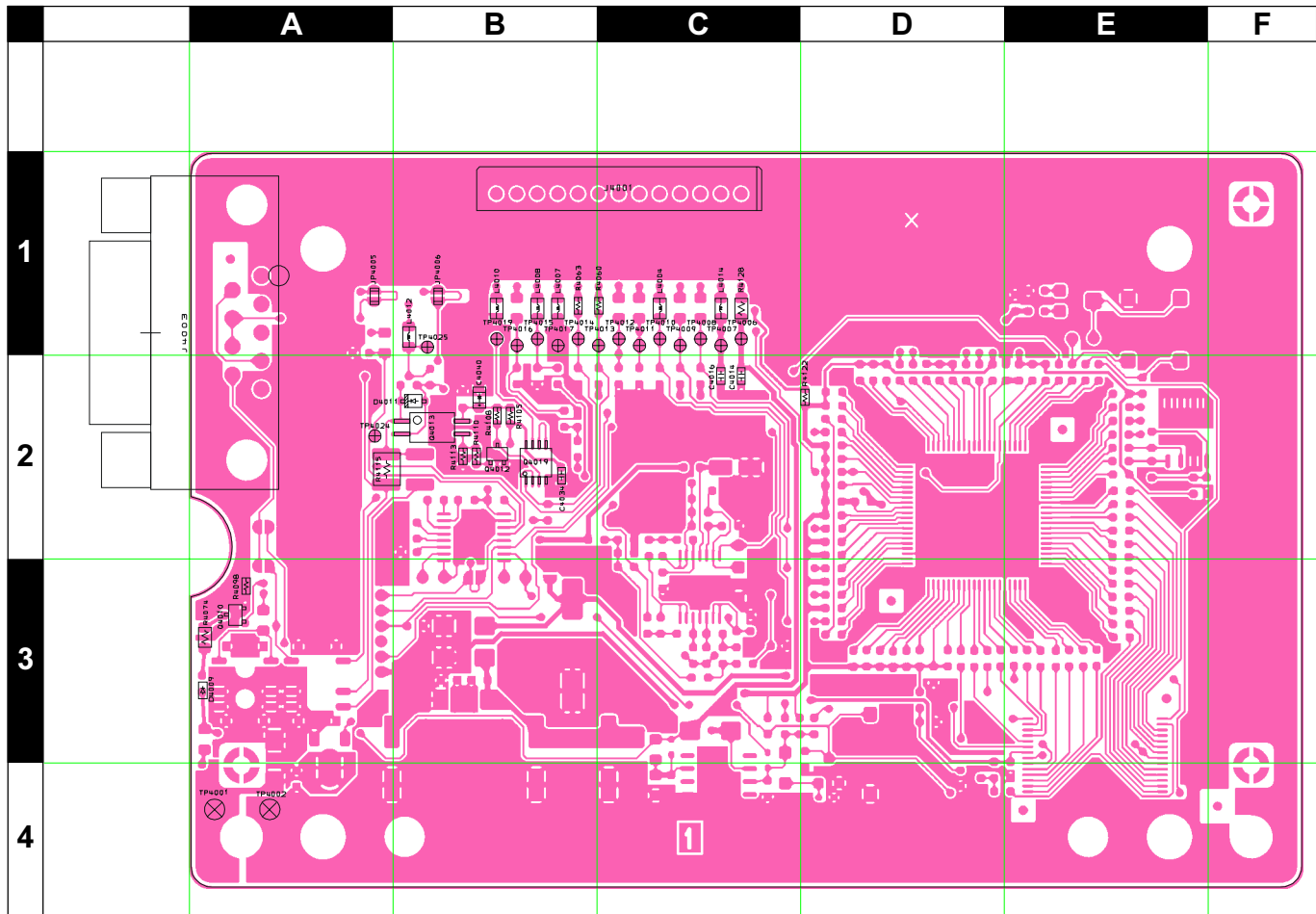

TC7W04FU
(Q4019)

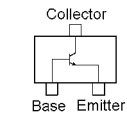

2SC4154 (E)
(Q4010, 4012)

GPS-INTERFACE Unit

Parts Layout (Side B)

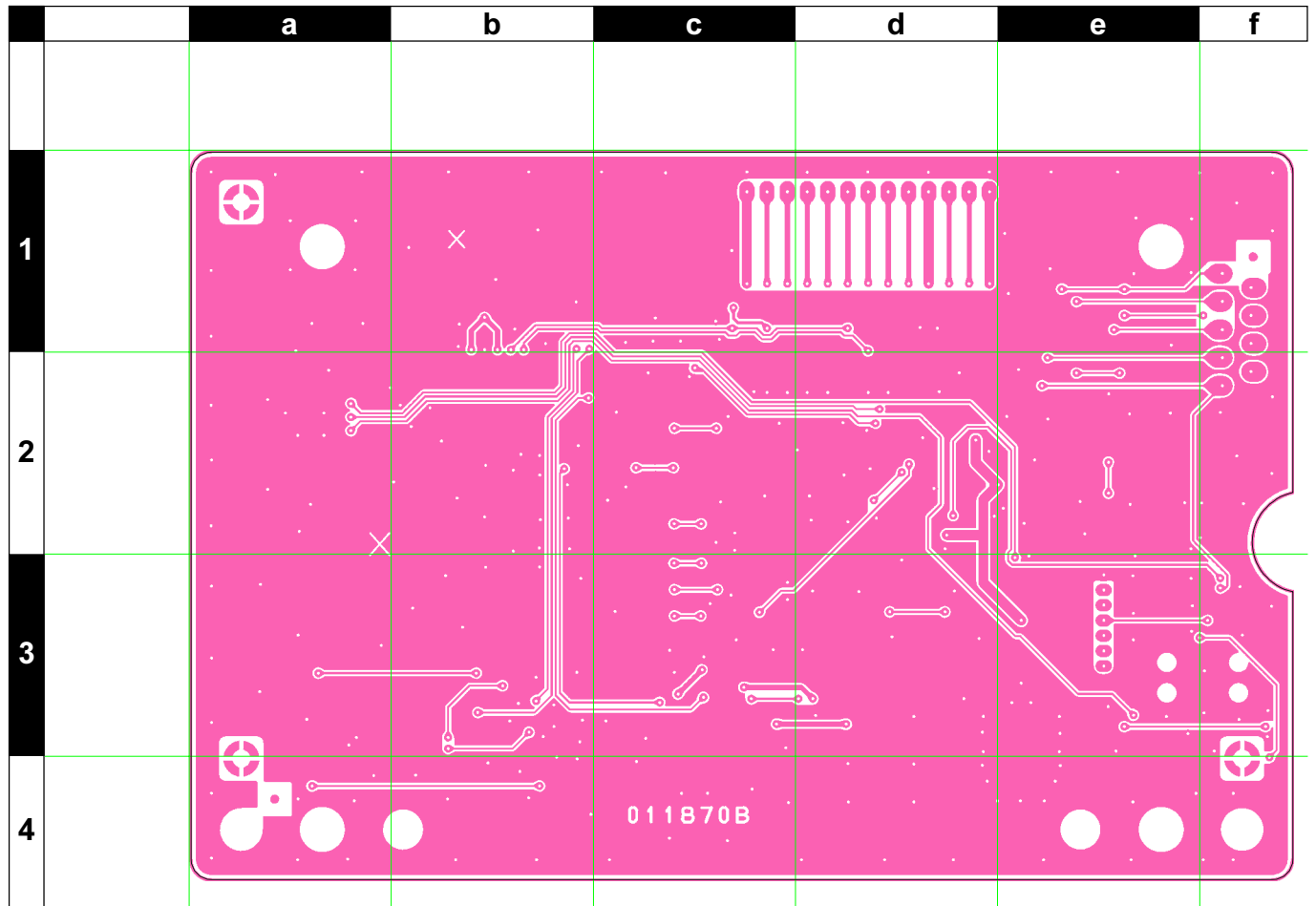

GPS-INTERFACE Unit

Parts List

REF.	DESCRIPTION	VALUE	V/W	TOL.	MFR'S DESIG	VXSTD P/N	VERS.	LOT.	SIDE	LAY ADR
PCB with Components						CB3183001				
Printed Circuit Board					AC051H000	FR011870C		1-		
C 4014	CHIP CAP.	0.01uF	25V	B	GRM39B103K25PT	K22144803		1-	A	C2
C 4016	CHIP CAP.	0.01uF	25V	B	GRM39B103K25PT	K22144803		1-	A	C2
C 4034	CHIP CAP.	0.1uF	16V	B	GRM188B11C104KA01D	K22124805		1-	A	B2
C 4040	CHIP TA.CAP.	10uF	6.3V		TESVSP0J106M-8R	K78080055		1-	A	B2
D 4009	LED				SML-310FTT86KL	G2071026		1-	A	A3
D 4011	DIODE				1SS355 TE-17	G2070470		1-	A	B2
J 4001	CONNECTOR				SB20-13WS	P0090620		1-	A	C1
J 4003	CONNECTOR				XM2C-0942-232L	P0091409		1-	A	A1
L 4001	M.RFC	22uH			LK2125 220M-T	L1690335		1-		
L 4007	M.RFC	22uH			LK2125 220M-T	L1690335		1-	A	B1
L 4010	M.RFC	22uH			LK2125 220M-T	L1690335		1-	A	B1
L 4012	M.RFC	22uH			LK2125 220M-T	L1690335		1-	A	B1
L 4014	M.RFC	22uH			LK2125 220M-T	L1690335		1-	A	C1
Q 4010	TRANSISTOR				2SC4154-T11-1E	G3341548E		1-	A	A3
Q 4012	TRANSISTOR				2SC4154-T11-1E	G3341548E		1-	A	B2
Q 4013	PHOTO COUPLER				TLP281(GB-TP)	G0090037		1-	A	B2
Q 4019	IC				TC7W14FU(TE12L)	G1093321		1-	A	B2
R 4060	CHIP RES.	100	1/16W	5%	RMC1/16 101JATP	J24185101		1-	A	C1
R 4063	CHIP RES.	100	1/16W	5%	RMC1/16 101JATP	J24185101		1-	A	B1
R 4074	CHIP RES.	560	1/10W	5%	RMC1/10T 561J	J24205561		1-	A	A3
R 4098	CHIP RES.	1k	1/16W	5%	RMC1/16 102JATP	J24185102		1-	A	A3
R 4105	CHIP RES.	100	1/16W	5%	RMC1/16 101JATP	J24185101		1-	A	B2
R 4108	CHIP RES.	22k	1/16W	5%	RMC1/16 223JATP	J24185223		1-	A	B2
R 4110	CHIP RES.	10k	1/16W	5%	RMC1/16 103JATP	J24185103		1-	A	B2
R 4113	CHIP RES.	2.2k	1/16W	5%	RMC1/16 222JATP	J24185222		1-	A	B2
R 4115	CHIP RES.	330	1/4W	5%	RMC1/4 331JATP	J24245331		1-	A	A2
R 4122	CHIP RES.	0	1/16W	5%	RMC1/16 000JATP	J24185000		1-	A	D2

MIC Unit Circuit Diagram

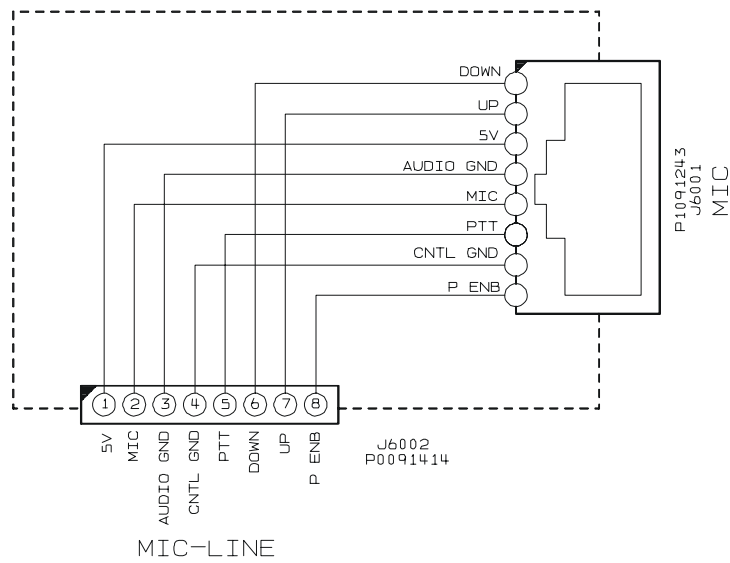

Parts Layout

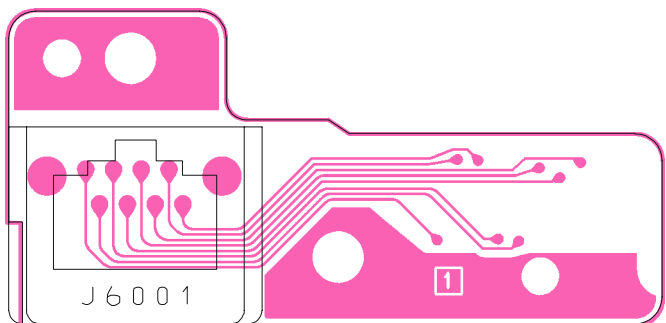

Side A

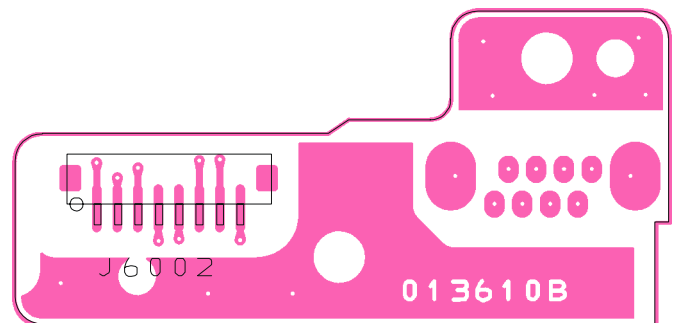

Side B

Parts List

REF.	DESCRIPTION	VALUE	V/W	TOL.	MFR'S DESIG	VXSTD P/N	VERS.	LOT.	SIDE	LAY ADR
	PCB with Components					CB3199001				
	Printed Circuit Board				AC051H000	FR0136100		1-		
J 6001	CONNECTOR				R41-2509R	P1091243		1-	A	A1
J 6002	CONNECTOR				B8B-ZR-SM3-TFT	P0091414		1-	B	a1

ENC Unit

Circuit Diagram

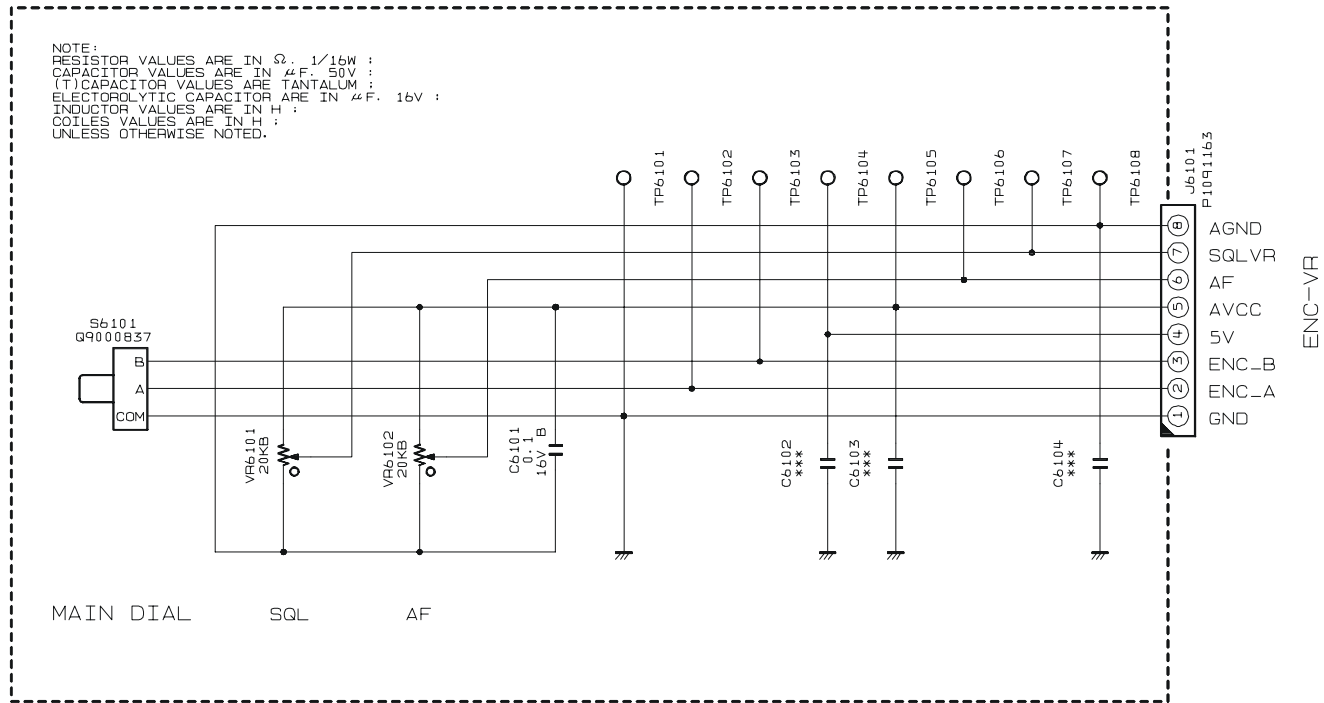

Parts Layout

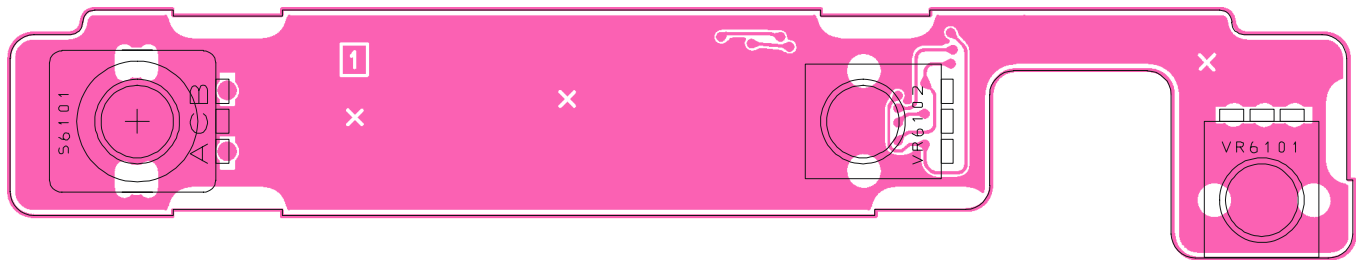

Side A

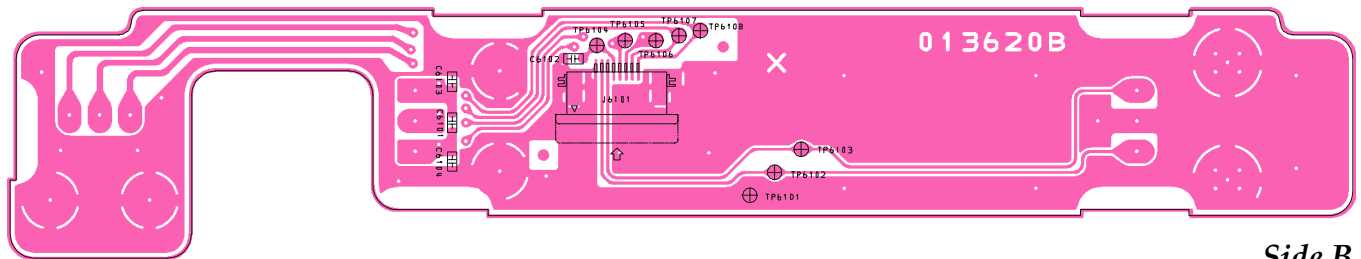

Side B

Parts List

REF.	DESCRIPTION	VALUE	V/W	TOL.	MFR'S DESIG	VXSTD P/N	VERS.	LOT.	SIDE	LAY ADR
PCB with Components						CB3200001				
Printed Circuit Board					AC051H000	FR0136200		1-		
C 6101	CHIP CAP.	0.1uF	16V	B	GRM188B11C104KA01D	K22124805		1-	B	
J 6101	CONNECTOR				52746-0890	P1091163		1-	B	
S 6101	ROTARY ENCODER				EC11B15204AU	Q9000837		1-	A	
VR6101	POT.				RH96N74 23F B103 RY-7862	J60800285		1-	A	
VR6102	POT.				RH96N220 23F B103 RY-7861	J60800284		1-	A	

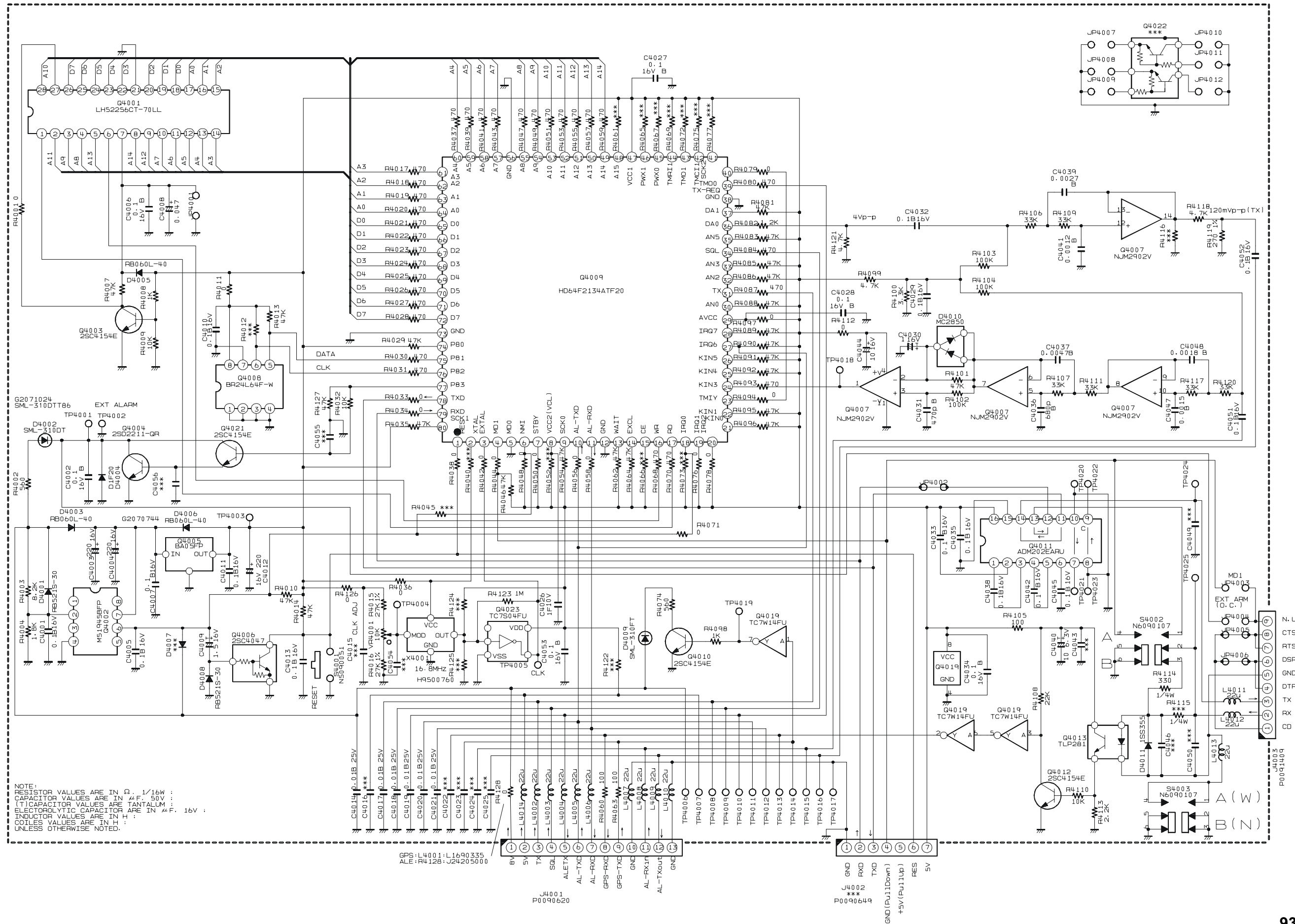

ALE Unit (Option)

Parts Layout

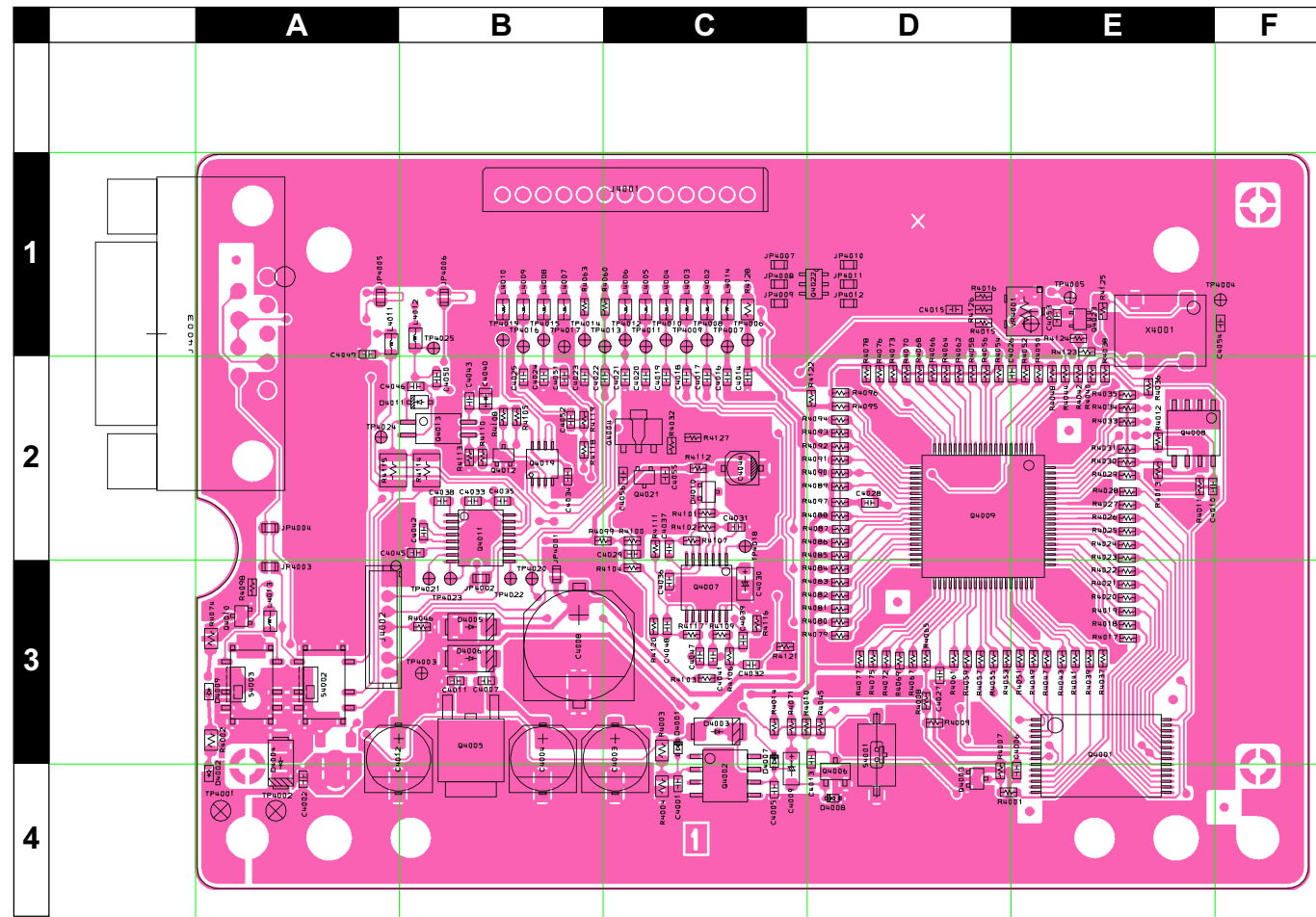

Side A

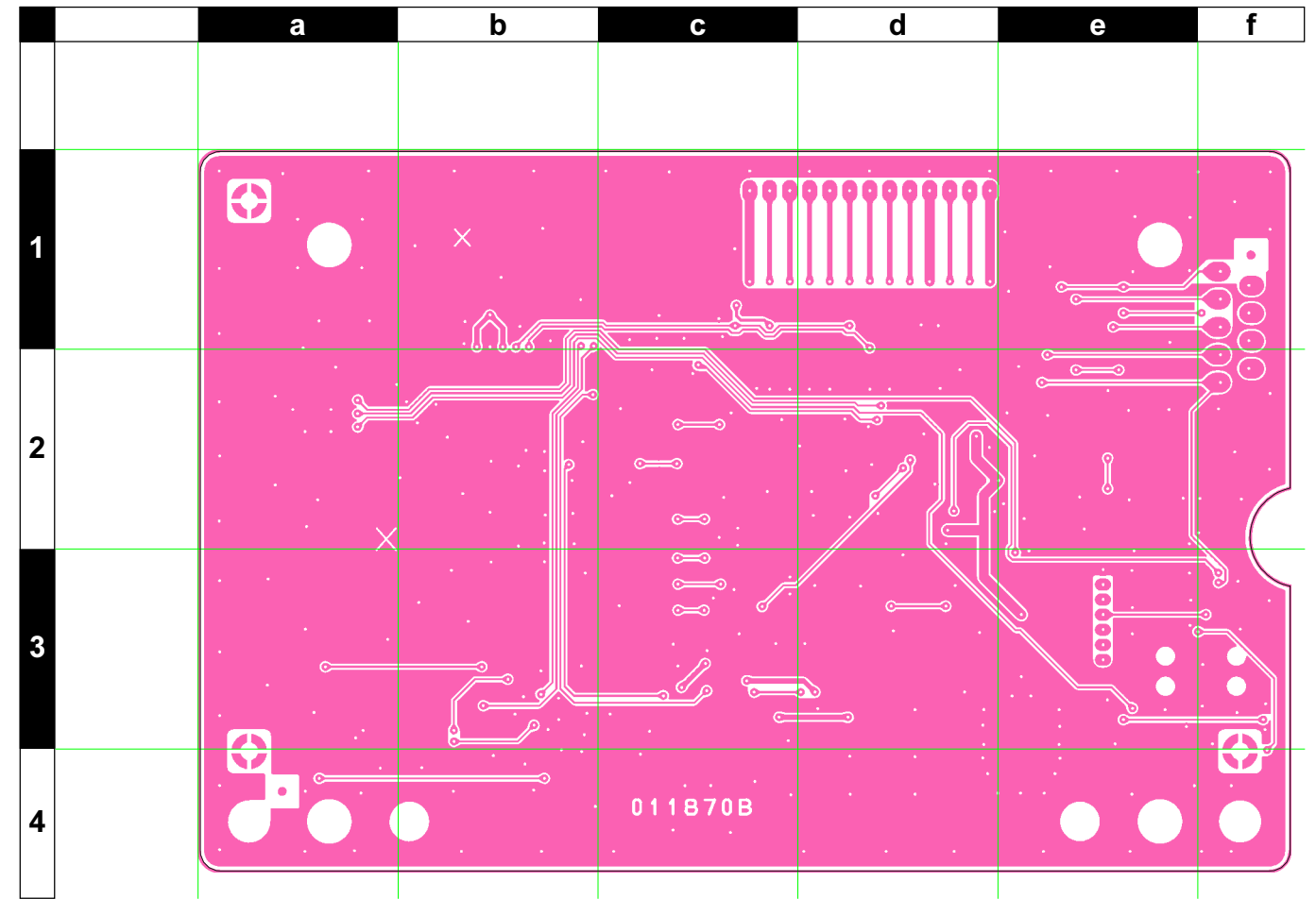

Side B

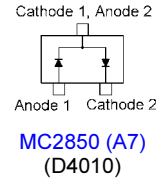
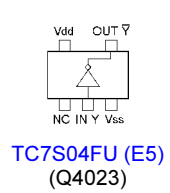
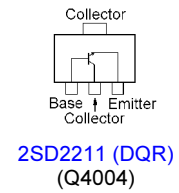
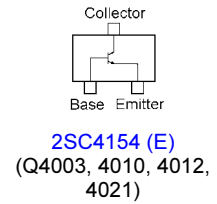
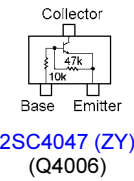
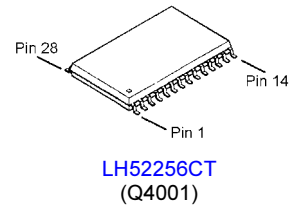
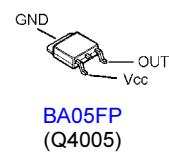
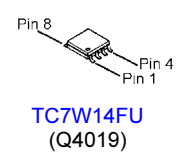
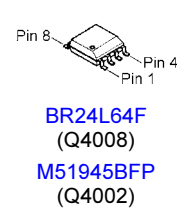
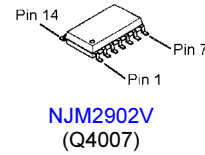
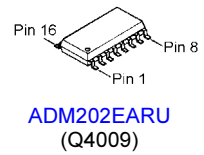
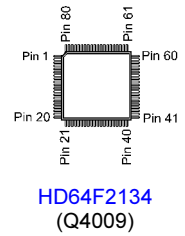

ALE Unit (Option)

Parts List

REF.	DESCRIPTION	VALUE	V/W	TOL.	MFR'S DESIG	VXSTD P/N	VERS.	LOT.	SIDE	LAY ADR
Printed Circuit Board					AC051H000	FR011870B		1-		
C 4001	CHIP CAP.	0.1uF	16V	B	GRM188B11C104KA01D	K22124805		1-	A	C4
C 4002	CHIP CAP.	0.1uF	16V	B	GRM188B11C104KA01D	K22124805		1-	A	A4
C 4003	AL.ELECTRO.CAP.	220uF	16V		MVA16VC220MF80	K48120021		1-	A	C3
C 4004	AL.ELECTRO.CAP.	220uF	16V		MVA16VC220MF80	K48120021		1-	A	B3
C 4005	CHIP CAP.	0.1uF	16V	B	GRM188B11C104KA01D	K22124805		1-	A	C4
C 4006	CHIP CAP.	0.1uF	16V	B	GRM188B11C104KA01D	K22124805		1-	A	E4
C 4007	CHIP CAP.	0.1uF	16V	B	GRM188B11C104KA01D	K22124805		1-	A	B3
C 4008	CAP.	0.047uF			FC0H473ZTBR24	K60070002		1-	A	B3
C 4009	CHIP TA.CAP.	1.5uF	16V		TESVA1C155M1-8R	K78120020		1-	A	C4
C 4010	CHIP CAP.	0.1uF	16V	B	GRM188B11C104KA01D	K22124805		1-	A	E2
C 4011	CHIP CAP.	0.1uF	16V	B	GRM188B11C104KA01D	K22124805		1-	A	B3
C 4012	AL.ELECTRO.CAP.	220uF	16V		MVA16VC220MF80	K48120021		1-	A	A3
C 4013	CHIP CAP.	0.1uF	16V	B	GRM188B11C104KA01D	K22124805		1-	A	D3
C 4014	CHIP CAP.	0.01uF	25V	B	GRM39B103K25PT	K22144803		1-	A	C2
C 4017	CHIP CAP.	0.01uF	25V	B	GRM39B103K25PT	K22144803		1-	A	C2
C 4018	CHIP CAP.	0.01uF	25V	B	GRM39B103K25PT	K22144803		1-	A	C2
C 4019	CHIP CAP.	0.01uF	25V	B	GRM39B103K25PT	K22144803		1-	A	C2
C 4020	CHIP CAP.	0.01uF	25V	B	GRM39B103K25PT	K22144803		1-	A	C2
C 4021	CHIP CAP.	0.01uF	25V	B	GRM39B103K25PT	K22144803		1-	A	C2
C 4026	CHIP CAP.	1uF	10V	F	GRM188F11A105ZA01D	K22105001		1-	A	D2
C 4027	CHIP CAP.	0.1uF	16V	B	GRM188B11C104KA01D	K22124805		1-	A	D3
C 4028	CHIP CAP.	0.1uF	16V	B	GRM188B11C104KA01D	K22124805		1-	A	D2
C 4029	CHIP CAP.	0.1uF	16V	B	GRM188B11C104KA01D	K22124805		1-	A	C2
C 4030	CHIP TA.CAP.	1uF	16V		TESVA1C105M1-8R	K78120009		1-	A	C3
C 4031	CHIP CAP.	470pF	50V	B	GRM188B11H471KA01D	K22174805		1-	A	C2
C 4032	CHIP CAP.	0.1uF	16V	B	GRM188B11C104KA01D	K22124805		1-	A	C3
C 4033	CHIP CAP.	0.1uF	16V	B	GRM188B11C104KA01D	K22124805		1-	A	B2
C 4034	CHIP CAP.	0.1uF	16V	B	GRM188B11C104KA01D	K22124805		1-	A	B2
C 4035	CHIP CAP.	0.1uF	16V	B	GRM188B11C104KA01D	K22124805		1-	A	B2
C 4036	CHIP CAP.	680pF	50V	B	GRM188B11H681KA01D	K22174807		1-	A	C3
C 4037	CHIP CAP.	0.0047uF	50V	B	GRM188B11H472KA01D	K22174833		1-	A	C2
C 4038	CHIP CAP.	0.1uF	16V	B	GRM188B11C104KA01D	K22124805		1-	A	B2
C 4039	CHIP CAP.	0.0027uF	50V	B	GRM188B11H272KA01D	K22174829		1-	A	C3
C 4040	CHIP TA.CAP.	10uF	6.3V		TESVSP0J106M-8R	K78080055		1-	A	B2
C 4041	CHIP CAP.	0.0012uF	50V	B	GRM188B11H122KA01D	K22174826		1-	A	C3
C 4042	CHIP CAP.	0.1uF	16V	B	GRM188B11C104KA01D	K22124805		1-	A	B2
C 4044	AL.ELECTRO.CAP.	10uF	16V		RV2-16V100MB55-R	K48120014		1-	A	C2
C 4045	CHIP CAP.	0.1uF	16V	B	GRM188B11C104KA01D	K22124805		1-	A	B2
C 4047	CHIP CAP.	0.0015uF	50V	B	GRM188B11H152KA01D	K22174827		1-	A	C3
C 4048	CHIP CAP.	0.0018uF	50V	B	GRM188B11H182KA01D	K22174828		1-	A	C3
C 4051	CHIP CAP.	0.1uF	16V	B	GRM188B11C104KA01D	K22124805		1-	A	B2
C 4052	CHIP CAP.	0.1uF	16V	B	GRM188B11C104KA01D	K22124805		1-	A	B2
C 4053	CHIP CAP.	0.1uF	16V	B	GRM188B11C104KA01D	K22124805		1-	A	E1
D 4001	DIODE				RB521S-30 TE61	G2070642		1-	A	C3
D 4002	LED				SML-310DTT86KL	G2071024		1-	A	A4
D 4003	DIODE				RB060L-40 TE25	G2070744		1-	A	C3
D 4004	DIODE				D1F20-4063	G2070474		1-	A	A4
D 4005	DIODE				RB060L-40 TE25	G2070744		1-	A	B3
D 4006	DIODE				RB060L-40 TE25	G2070744		1-	A	B3
D 4008	DIODE				RB521S-30 TE61	G2070642		1-	A	D4
D 4009	LED				SML-310FTT86KL	G2071026		1-	A	A3
D 4010	DIODE				MC2850-T11-1	G2070704		1-	A	C2
D 4011	DIODE				1SS355 TE-17	G2070470		1-	A	B2
J 4001	CONNECTOR				SB20-13WS	P0090620		1-	A	C1
J 4003	CONNECTOR				XM2C-0942-232L	P0091409		1-	A	A1
L 4002	M.RFC	22uH			LK2125 220M-T	L1690335		1-	A	C1
L 4003	M.RFC	22uH			LK2125 220M-T	L1690335		1-	A	C1
L 4004	M.RFC	22uH			LK2125 220M-T	L1690335		1-	A	C1

ALE Unit (Option)

Parts List

REF.	DESCRIPTION	VALUE	V/W	TOL.	MFR'S DESIG	VXSTD P/N	VERS.	LOT.	SIDE	LAY ADR
L 4005	M.RFC	22uH			LK2125 220M-T	L1690335		1-	A	C1
L 4006	M.RFC	22uH			LK2125 220M-T	L1690335		1-	A	C1
L 4007	M.RFC	22uH			LK2125 220M-T	L1690335		1-	A	B1
L 4008	M.RFC	22uH			LK2125 220M-T	L1690335		1-	A	B1
L 4009	M.RFC	22uH			LK2125 220M-T	L1690335		1-	A	B1
L 4010	M.RFC	22uH			LK2125 220M-T	L1690335		1-	A	B1
L 4011	M.RFC	22uH			LK2125 220M-T	L1690335		1-	A	A1
L 4012	M.RFC	22uH			LK2125 220M-T	L1690335		1-	A	B1
L 4013	M.RFC	22uH			LK2125 220M-T	L1690335		1-	A	A3
L 4014	M.RFC	22uH			LK2125 220M-T	L1690335		1-	A	C1
Q 4001	IC				LH52256CT-70LL	G1093162		1-	A	E3
Q 4002	IC				M51945BFP-600C	G1091990		1-	A	C4
Q 4003	TRANSISTOR				2SC4154-T11-1E	G3341548E		1-	A	D4
Q 4004	TRANSISTOR				2SD2211 T100 QR	G3422117Q		1-	A	C2
Q 4005	IC				BA05FP-E2	G1093209		1-	A	B3
Q 4006	TRANSISTOR				2SC4047-TA	G3340477		1-	A	D4
Q 4007	IC				NJM2902V-TE1	G1091679		1-	A	C3
Q 4008	IC				BR24L64F-WE2	G1093876		1-	A	E2
Q 4009	IC				HD64F2134ATF20(FLASH)	✘		1-	A	D2
Q 4010	TRANSISTOR				2SC4154-T11-1E	G3341548E		1-	A	A3
Q 4011	IC				ADM202EARU-REEL	G1092958		1-	A	B2
Q 4012	TRANSISTOR				2SC4154-T11-1E	G3341548E		1-	A	B2
Q 4013	PHOTO COUPLER				TLP281(GB-TP)	G0090037		1-	A	B2
Q 4019	IC				TC7W14FU(TE12L)	G1093321		1-	A	B2
Q 4021	TRANSISTOR				2SC4154-T11-1E	G3341548E		1-	A	C2
Q 4023	IC				TC7S04FU TE85R	G1091530		1-	A	E1
R 4001	CHIP RES.	0	1/16W	5%	RMC1/16 000JATP	J24185000		1-	A	D4
R 4003	CHIP RES.	8.2k	1/10W	5%	RMC1/10T 822J	J24205822		1-	A	C3
R 4004	CHIP RES.	1.8k	1/10W	5%	RMC1/10T 182J	J24205182		1-	A	C4
R 4007	CHIP RES.	47k	1/16W	5%	RMC1/16 473JATP	J24185473		1-	A	D4
R 4008	CHIP RES.	1k	1/16W	5%	RMC1/16 102JATP	J24185102		1-	A	D3
R 4009	CHIP RES.	10k	1/16W	5%	RMC1/16 103JATP	J24185103		1-	A	D3
R 4010	CHIP RES.	47k	1/16W	5%	RMC1/16 473JATP	J24185473		1-	A	C3
R 4011	CHIP RES.	0	1/16W	5%	RMC1/16 000JATP	J24185000		1-	A	E2
R 4013	CHIP RES.	47k	1/16W	5%	RMC1/16 473JATP	J24185473		1-	A	E2
R 4014	CHIP RES.	47k	1/16W	5%	RMC1/16 473JATP	J24185473		1-	A	C3
R 4015	CHIP RES.	27k	1/16W	1%	RMC1/16 273FTP	J24183273		1-	A	D1
R 4016	CHIP RES.	27k	1/16W	1%	RMC1/16 273FTP	J24183273		1-	A	D1
R 4017	CHIP RES.	470	1/16W	5%	RMC1/16 471JATP	J24185471		1-	A	E3
R 4018	CHIP RES.	470	1/16W	5%	RMC1/16 471JATP	J24185471		1-	A	E3
R 4019	CHIP RES.	470	1/16W	5%	RMC1/16 471JATP	J24185471		1-	A	E3
R 4020	CHIP RES.	470	1/16W	5%	RMC1/16 471JATP	J24185471		1-	A	E3
R 4021	CHIP RES.	470	1/16W	5%	RMC1/16 471JATP	J24185471		1-	A	E3
R 4022	CHIP RES.	470	1/16W	5%	RMC1/16 471JATP	J24185471		1-	A	E3
R 4023	CHIP RES.	470	1/16W	5%	RMC1/16 471JATP	J24185471		1-	A	E3
R 4024	CHIP RES.	470	1/16W	5%	RMC1/16 471JATP	J24185471		1-	A	E2
R 4025	CHIP RES.	470	1/16W	5%	RMC1/16 471JATP	J24185471		1-	A	E2
R 4026	CHIP RES.	470	1/16W	5%	RMC1/16 471JATP	J24185471		1-	A	E2
R 4027	CHIP RES.	470	1/16W	5%	RMC1/16 471JATP	J24185471		1-	A	E2
R 4028	CHIP RES.	470	1/16W	5%	RMC1/16 471JATP	J24185471		1-	A	E2
R 4029	CHIP RES.	47k	1/16W	5%	RMC1/16 473JATP	J24185473		1-	A	E2
R 4030	CHIP RES.	470	1/16W	5%	RMC1/16 471JATP	J24185471		1-	A	E2
R 4031	CHIP RES.	470	1/16W	5%	RMC1/16 471JATP	J24185471		1-	A	E2
R 4032	CHIP RES.	10k	1/16W	5%	RMC1/16 103JATP	J24185103		1-	A	C2
R 4033	CHIP RES.	0	1/16W	5%	RMC1/16 000JATP	J24185000		1-	A	E2
R 4034	CHIP RES.	0	1/16W	5%	RMC1/16 000JATP	J24185000		1-	A	E2
R 4035	CHIP RES.	47k	1/16W	5%	RMC1/16 473JATP	J24185473		1-	A	E2
R 4036	CHIP RES.	0	1/16W	5%	RMC1/16 000JATP	J24185000		1-	A	E2
R 4037	CHIP RES.	470	1/16W	5%	RMC1/16 471JATP	J24185471		1-	A	E3

ALE Unit (Option)

Parts List

REF.	DESCRIPTION	VALUE	V/W	TOL.	MFR'S DESIG	VXSTD P/N	VERS.	LOT.	SIDE	LAY ADR
R 4038	CHIP RES.	0	1/16W	5%	RMC1/16 000JATP	J24185000		1-	A	E2
R 4039	CHIP RES.	470	1/16W	5%	RMC1/16 471JATP	J24185471		1-	A	E3
R 4041	CHIP RES.	470	1/16W	5%	RMC1/16 471JATP	J24185471		1-	A	E3
R 4042	CHIP RES.	0	1/16W	5%	RMC1/16 000JATP	J24185000		1-	A	E2
R 4043	CHIP RES.	470	1/16W	5%	RMC1/16 471JATP	J24185471		1-	A	E3
R 4044	CHIP RES.	0	1/16W	5%	RMC1/16 000JATP	J24185000		1-	A	E2
R 4046	CHIP RES.	47k	1/16W	5%	RMC1/16 473JATP	J24185473		1-	A	B3
R 4047	CHIP RES.	470	1/16W	5%	RMC1/16 471JATP	J24185471		1-	A	E3
R 4048	CHIP RES.	0	1/16W	5%	RMC1/16 000JATP	J24185000		1-	A	E2
R 4049	CHIP RES.	470	1/16W	5%	RMC1/16 471JATP	J24185471		1-	A	E3
R 4050	CHIP RES.	0	1/16W	5%	RMC1/16 000JATP	J24185000		1-	A	E2
R 4051	CHIP RES.	470	1/16W	5%	RMC1/16 471JATP	J24185471		1-	A	E3
R 4053	CHIP RES.	470	1/16W	5%	RMC1/16 471JATP	J24185471		1-	A	D3
R 4054	CHIP RES.	47k	1/16W	5%	RMC1/16 473JATP	J24185473		1-	A	D2
R 4055	CHIP RES.	470	1/16W	5%	RMC1/16 471JATP	J24185471		1-	A	D3
R 4056	CHIP RES.	0	1/16W	5%	RMC1/16 000JATP	J24185000		1-	A	D2
R 4057	CHIP RES.	470	1/16W	5%	RMC1/16 471JATP	J24185471		1-	A	D3
R 4058	CHIP RES.	0	1/16W	5%	RMC1/16 000JATP	J24185000		1-	A	D2
R 4059	CHIP RES.	470	1/16W	5%	RMC1/16 471JATP	J24185471		1-	A	D3
R 4060	CHIP RES.	100	1/16W	5%	RMC1/16 101JATP	J24185101		1-	A	C1
R 4062	CHIP RES.	47k	1/16W	5%	RMC1/16 473JATP	J24185473		1-	A	D2
R 4063	CHIP RES.	100	1/16W	5%	RMC1/16 101JATP	J24185101		1-	A	B1
R 4064	CHIP RES.	47k	1/16W	5%	RMC1/16 473JATP	J24185473		1-	A	D2
R 4068	CHIP RES.	470	1/16W	5%	RMC1/16 471JATP	J24185471		1-	A	D2
R 4070	CHIP RES.	470	1/16W	5%	RMC1/16 471JATP	J24185471		1-	A	D2
R 4071	CHIP RES.	0	1/16W	5%	RMC1/16 000JATP	J24185000		1-	A	C3
R 4074	CHIP RES.	560	1/10W	5%	RMC1/10T 561J	J24205561		1-	A	A3
R 4076	CHIP RES.	0	1/16W	5%	RMC1/16 000JATP	J24185000		1-	A	D2
R 4078	CHIP RES.	0	1/16W	5%	RMC1/16 000JATP	J24185000		1-	A	D2
R 4079	CHIP RES.	0	1/16W	5%	RMC1/16 000JATP	J24185000		1-	A	D3
R 4080	CHIP RES.	470	1/16W	5%	RMC1/16 471JATP	J24185471		1-	A	D3
R 4081	CHIP RES.	47k	1/16W	5%	RMC1/16 473JATP	J24185473		1-	A	D3
R 4082	CHIP RES.	1.2k	1/16W	5%	RMC1/16 122JATP	J24185122		1-	A	D3
R 4083	CHIP RES.	47k	1/16W	5%	RMC1/16 473JATP	J24185473		1-	A	D3
R 4084	CHIP RES.	470	1/16W	5%	RMC1/16 471JATP	J24185471		1-	A	D3
R 4085	CHIP RES.	47k	1/16W	5%	RMC1/16 473JATP	J24185473		1-	A	D2
R 4086	CHIP RES.	47k	1/16W	5%	RMC1/16 473JATP	J24185473		1-	A	D2
R 4087	CHIP RES.	470	1/16W	5%	RMC1/16 471JATP	J24185471		1-	A	D2
R 4088	CHIP RES.	47k	1/16W	5%	RMC1/16 473JATP	J24185473		1-	A	D2
R 4089	CHIP RES.	47k	1/16W	5%	RMC1/16 473JATP	J24185473		1-	A	D2
R 4090	CHIP RES.	47k	1/16W	5%	RMC1/16 473JATP	J24185473		1-	A	D2
R 4091	CHIP RES.	47k	1/16W	5%	RMC1/16 473JATP	J24185473		1-	A	D2
R 4092	CHIP RES.	47k	1/16W	5%	RMC1/16 473JATP	J24185473		1-	A	D2
R 4093	CHIP RES.	470	1/16W	5%	RMC1/16 471JATP	J24185471		1-	A	D2
R 4094	CHIP RES.	0	1/16W	5%	RMC1/16 000JATP	J24185000		1-	A	D2
R 4095	CHIP RES.	47k	1/16W	5%	RMC1/16 473JATP	J24185473		1-	A	D2
R 4096	CHIP RES.	47k	1/16W	5%	RMC1/16 473JATP	J24185473		1-	A	D2
R 4097	CHIP RES.	0	1/16W	5%	RMC1/16 000JATP	J24185000		1-	A	D2
R 4098	CHIP RES.	1k	1/16W	5%	RMC1/16 102JATP	J24185102		1-	A	A3
R 4099	CHIP RES.	4.7k	1/16W	5%	RMC1/16 472JATP	J24185472		1-	A	B2
R 4100	CHIP RES.	3.3k	1/16W	5%	RMC1/16 332JATP	J24185332		1-	A	C2
R 4101	CHIP RES.	47k	1/16W	5%	RMC1/16 473JATP	J24185473		1-	A	C2
R 4102	CHIP RES.	100k	1/16W	5%	RMC1/16 104JATP	J24185104		1-	A	C2
R 4103	CHIP RES.	100k	1/16W	5%	RMC1/16 104JATP	J24185104		1-	A	C3
R 4104	CHIP RES.	100k	1/16W	5%	RMC1/16 104JATP	J24185104		1-	A	C3
R 4105	CHIP RES.	100	1/16W	5%	RMC1/16 101JATP	J24185101		1-	A	B2
R 4106	CHIP RES.	33k	1/16W	5%	RMC1/16 333JATP	J24185333		1-	A	C3
R 4107	CHIP RES.	33k	1/16W	5%	RMC1/16 333JATP	J24185333		1-	A	C2
R 4108	CHIP RES.	22k	1/16W	5%	RMC1/16 223JATP	J24185223		1-	A	B2

ALE Unit (Option)

Parts List

REF.	DESCRIPTION	VALUE	V/W	TOL.	MFR'S DESIG	VXSTD P/N	VERS.	LOT.	SIDE	LAY ADR
R 4109	CHIP RES.	33k	1/16W	5%	RMC1/16 333JATP	J24185333		1-	A	C3
R 4110	CHIP RES.	10k	1/16W	5%	RMC1/16 103JATP	J24185103		1-	A	B2
R 4111	CHIP RES.	33k	1/16W	5%	RMC1/16 333JATP	J24185333		1-	A	C2
R 4112	CHIP RES.	0	1/16W	5%	RMC1/16 000JATP	J24185000		1-	A	C2
R 4113	CHIP RES.	2.2k	1/16W	5%	RMC1/16 222JATP	J24185222		1-	A	B2
R 4114	CHIP RES.	330	1/4W	5%	RMC1/4 331JATP	J24245331		1-	A	B2
R 4117	CHIP RES.	33k	1/16W	5%	RMC1/16 333JATP	J24185333		1-	A	C3
R 4118	CHIP RES.	4.7k	1/16W	5%	RMC1/16 472JATP	J24185472		1-	A	B2
R 4119	CHIP RES.	270	1/16W	1%	RMC1/16 271FTP	J24183271		1-	A	B2
R 4120	CHIP RES.	33k	1/16W	5%	RMC1/16 333JATP	J24185333		1-	A	C3
R 4121	CHIP RES.	4.7k	1/16W	5%	RMC1/16 472JATP	J24185472		1-	A	C3
R 4123	CHIP RES.	1M	1/16W	5%	RMC1/16 105JATP	J24185105		1-	A	E1
R 4126	CHIP RES.	0	1/16W	5%	RMC1/16 000JATP	J24185000		1-	A	D1
R 4127	CHIP RES.	47k	1/16W	5%	RMC1/16 473JATP	J24185473		1-	A	C2
R 4128	CHIP RES.	0	1/10W	5%	RMC1/10T 000J	J24205000		1-	A	C1
S 4001	TACT SWITCH				SKQDAA	N5090051		1-	A	D3
S 4002	SLIDE SWITCH				SSSS820201	N6090107		1-	A	A3
S 4003	SLIDE SWITCH				SSSS820201	N6090107		1-	A	A3
VR4001	POT.	10k			PVG5A103A01R00	J51832103		1-	A	E1
X 4001	XTAL OSC	16.8MHz			TTS05VS-P2 16.8MHZ	H9500760		1-	A	E1



Copyright 2005
VERTEX STANDARD CO., LTD.
All rights reserved

No portion of this manual
may be reproduced without
the permission of
VERTEX STANDARD CO., LTD.