

# VHF FM Transceiver

## VX-2100 Series VX-2200 Series

### Service Manual

©2006 VERTEX STANDARD CO., LTD. EC061N90C

**VERTEX STANDARD CO., LTD.**  
4-8-8 Nakameguro, Meguro-Ku, Tokyo 153-8644, Japan

**VERTEX STANDARD**  
**US Headquarters**  
10900 Walker Street, Cypress, CA 90630, U.S.A.

**YAESU EUROPE B.V.**  
P.O. Box 75525, 1118 ZN Schiphol, The Netherlands

**YAESU UK LTD.**  
Unit 12, Sun Valley Business Park, Winnall Close  
Winchester, Hampshire, SO23 0LB, U.K.

**VERTEX STANDARD HK LTD.**  
Unit 5, 20/F., Seaview Centre, 139-141 Hoi Bun Road,  
Kwun Tong, Kowloon, Hong Kong

**VERTEX STANDARD (AUSTRALIA) PTY., LTD.**  
Normanby Business Park, Unit 14/45 Normanby Road  
Notting Hill 3168, Victoria, Australia

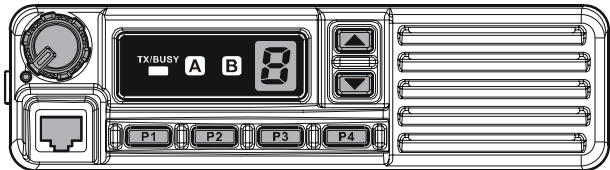

**VX-2100 Series**

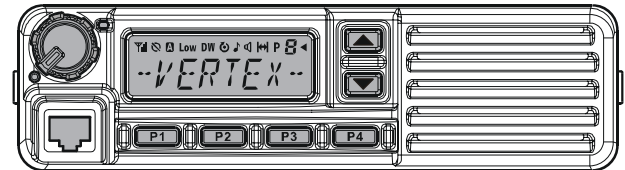

**VX-2200 Series**

### Introduction

This manual provides the technical information necessary for servicing the **VX-2100/-2200 Series** Mobile Transceiver.

Servicing this equipment requires expertise in handling surface-mount chip components. Attempts by non-qualified persons to service this equipment may result in permanent damage not covered by the warranty, and may be illegal in some countries.

Two PCB layout diagrams are provided for each double-sided board in this transceiver. Each side of the board is referred to by the type of the majority of components installed on that side ("Side A" or "Side B"). In most cases one side has only chip components (surface-mount devices), and the other has either a mixture of both chip and leaded components (trimmers, coils, electrolytic capacitors, ICs, etc.), or leaded components only.

As described in the pages to follow, the advanced microprocessor design of the **VX-2100/-2200** allows a complete alignment of this transceiver to be performed without opening the case of the radio; all adjustments can be performed from the personal computer, using with the Vertex Standard VPL-1 Programming Cable and CE82 Software.

While we believe the information in this manual to be correct, Vertex Standard assumes no liability for damage that may occur as a result of typographical or other errors that may be present. Your cooperation in pointing out any inconsistencies in the technical information would be appreciated.

### Important Note

This transceiver was assembled using Pb (lead) free solder, based on the RoHS specification.

Only lead-free solder (Alloy Composition: Sn-3.0Ag-0.5Cu) should be used for repairs performed on this apparatus. The solder stated above utilizes the alloy composition required for compliance with the lead-free specification, and any solder with the above alloy composition may be used.

## Contents

|  |            |   |     |
|--|------------|---|-----|
| <b>Specifications</b> .....                          | <b>A-1</b> | <b>Board Units (Schematics, Layouts &amp; Parts)</b>    |     |
| <b>DSUB 15-pin Accessory Connector</b> .....         | <b>B-1</b> | MAIN Unit .....   | H-1 |
| <b>Exploded View &amp; Miscellaneous Parts</b> ..... | <b>C-1</b> | FRONT-A Unit (VX-2100) .....                            | I-1 |
| <b>Block Diagram</b> .....                           | <b>D-1</b> | FRONT-B Unit (VX-2200) .....                            | J-1 |
| <b>Circuit Description</b> .....                     | <b>E-1</b> | <b>Optional Units (Schematics, Layouts &amp; Parts)</b> |     |
| <b>Alignment</b> .....                               | <b>F-1</b> | FVP-25 Encryption/DTMF Pager Unit .....                 | K-1 |
| <b>Installation of Option</b> .....                  | <b>G-1</b> | FVP-36 Voice Inversion Type Encryption Unit .....       | L-1 |

# Specifications

## General

|                                |   |
|--------------------------------|---|
| Frequency Ranges:              | 134 -174 MHz  |
| Number of Groups:              | 1 groups (VX-2100 Series)<br>8 groups (VX-2200 Series)        |
| Number of Channels:            | 8 channels (VX-2100 Series)<br>128 channels (VX-2200 Series)  |
| Power Supply Voltage:          | 13.6 V $\pm$ 15%  |
| Channel Spacing:               | 12.5 / 20 / 25 kHz  |
| Current Consumption (Approx.): | TX: 11 A (50 W) or 6 A (25 W)<br>RX: 2.5 A<br>Standby: 250 mA |
| Operating Temperature Range:   | -22 °F to +140 °F (-30 °C to +60 °C)                          |
| Frequency Stability:           | Better than $\pm$ 2.5 ppm                                     |
| RF Input-Output Impedance:     | 50 $\Omega$   |
| Dimension (W x H x D):         | 6.5" x 1.8" x 6.1" inch (165 x 46 x 155 mm) (W/O knob)        |
| Weight (Approx.):              | 2.87 lbs (1.3 kg)   |

## Receiver (Measured by TIA/EIA-603-A)

|                               |  |
|-------------------------------|--|
| Sensitivity (12 dB SINAD):    | 0.25 $\mu$ V   |
| Intermediate Frequency:       | 1st: 67.65 MHz, 2nd: 450 kHz   |
| Adjacent Channel Selectivity: | 75 dB (25 kHz)<br>65 dB (12.5 kHz)   |
| Intermodulation:              | 73 dB (25 kHz)<br>70 dB (12.5 kHz)   |
| Spurious & Image Rejection:   | 90 dB  |
| Audio Output:                 | Internal: 4 W @18 $\Omega$ , 5% THD<br>External: 12 W @4 $\Omega$ , 5% THD |

## Transmitter (Measured by TIA/EIA-603-A)

|                              |   |
|------------------------------|---|
| Output Power :               | 50 / 25 / 10 W (50 W)<br>25 / 12.5 / 5 / 1 W (25 W) |
| Modulation:                  | 16K0F3E, 11K0F3E                                    |
| Maximum Deviation:           | $\pm$ 5 kHz (25 kHz)<br>$\pm$ 2.5 kHz (12.5 kHz)    |
| Audio Distortion:            | < 3 % (@1 kHz)                                      |
| Conducted Spurious Emission: | 70 dB below carrier                                 |

*Specifications subject to change without notice or obligation.*

# DSUB 15-pin Accessory Connector

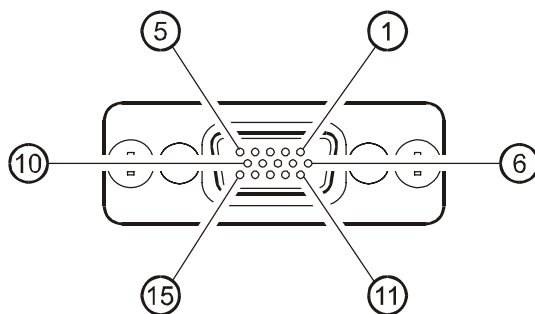

## Pin 1: AF IN (ANALOG INPUT)

External Microphone Input. Nominal input level is 6 mV at 600-ohm.

When connect the External Microphone to this port, insert a 0.1  $\mu\text{F}$  coupling capacitor between the microphone and this port; as shown illustration.

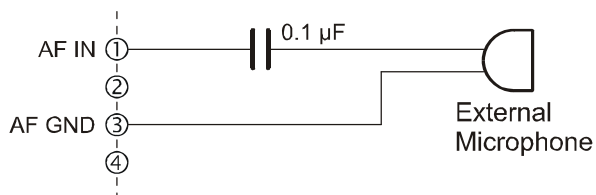

## Pin 2: AF OUT (ANALOG OUTPUT)

Low-level receiver output. Peak signal level is 150 mV at 600-ohm.

## Pin 3: AF GND

Ground for all logic levels and power supply return.

## Pin 4: DC OUT (13.6 V DC OUTPUT)

Switched 13.6V output for supplying power to an accessory.

## Pin 5: RSSI (ANALOG OUTPUT)

A DC voltage proportional to the strength of the signal currently being received (Receiver Signal Strength Indicator) is provided on this pin. This low impedance output is generated by the receiver IF sub-system and buffered by an internal op-amp. Typical output voltages are 1 V (@No Signal Input) through 2.0 V (@50 dB Signal Input).

## Pin 6: EXT PTT

Shorting this port to ground causes the transceiver to be placed in the Transmit mode, while opening the connection to this port returns the transceiver to the Receive mode. Opening voltage is 5 V, closed current approx. 5 mA.

## Pin 7: TRX

This port is intended for controlling an external TX/RX switching circuit. When the transceiver is placed in the the Receiver mode, this port is 5 V. When the transceiver is placed in the the Transmit mode, this port reduce to 0 V.

## Pin 8: IGN (IGNITION SENSE FEATURE)

The VX-2100/-2200 may be automatically be switched to the STND-BY mode when the vehicle's ignition key is turned on. Maximum current is 20 mA.

## Pin 9 - 12: ACC1 - ACC4 (ACCESSORY PORT)

These port features can be programmed via the CE82 programmer. Each port is open collector output which can sink approx. 100 mA when active. Max. output 16V. When the input is selected, it becomes active between 2V and 16V.

## Pin 13: ACC5 (ACCESSORY PORT)

The port 5 is available to set only for Output function, and active logic is the opposite side against the Port 1 ~ 4.

Max.output 5V, closed current approx. 1 mA.  
(CMOS output)

## Pin 14: ACC6 (ACCESSORY PORT)

The port 6 is available to set only for Input function, and active logic is the opposite side against the Port 1 ~ 4.

Max.input 5V. (CMOS input)

## Pin 15: GND

Chassis ground

*Note*

# Exploded View & Miscellaneous Parts

## VX-2100 FRONT PANEL

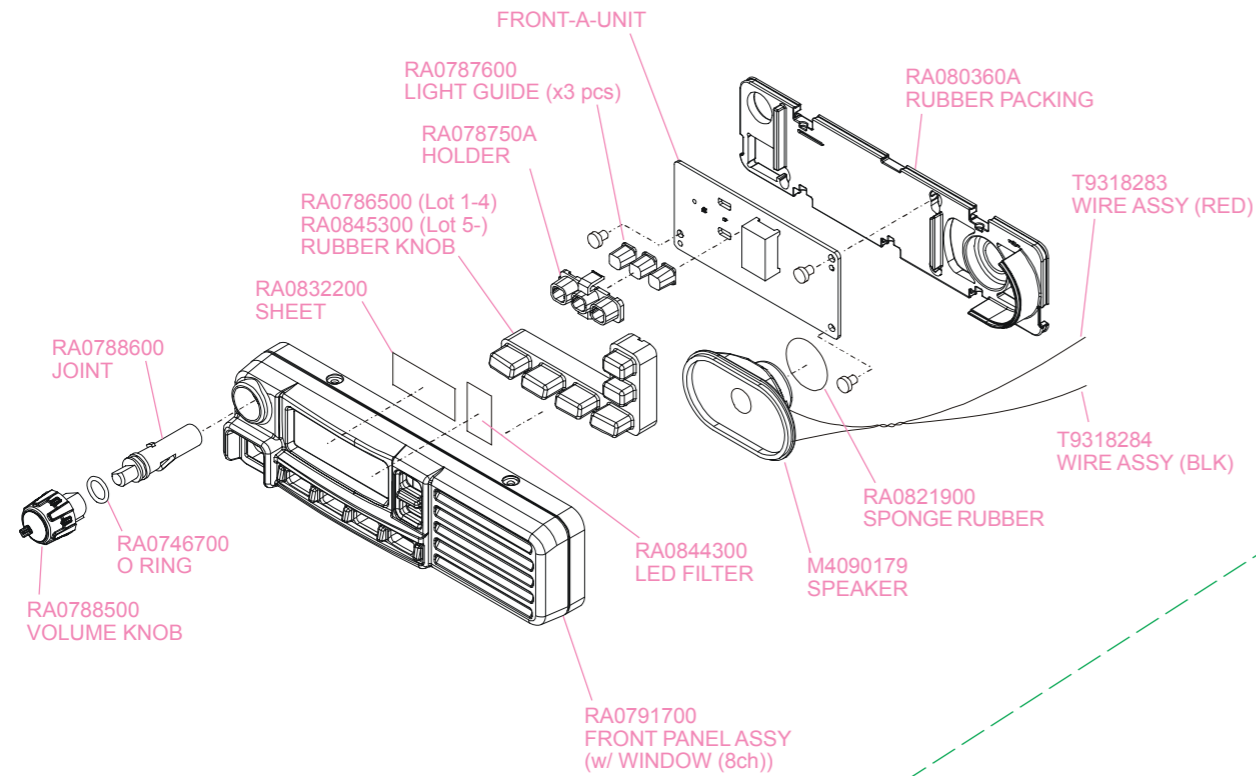

## VX-2200 FRONT PANEL

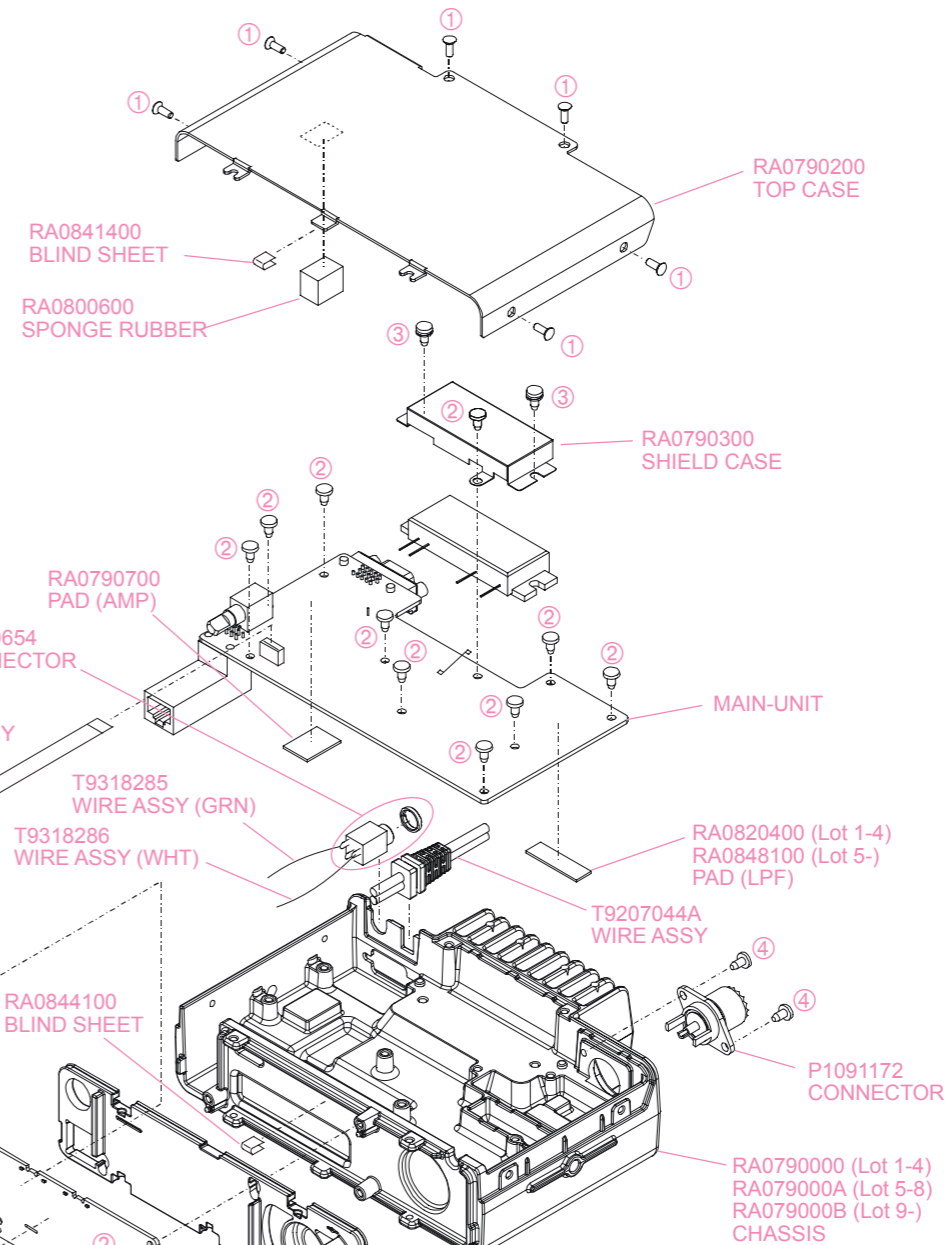
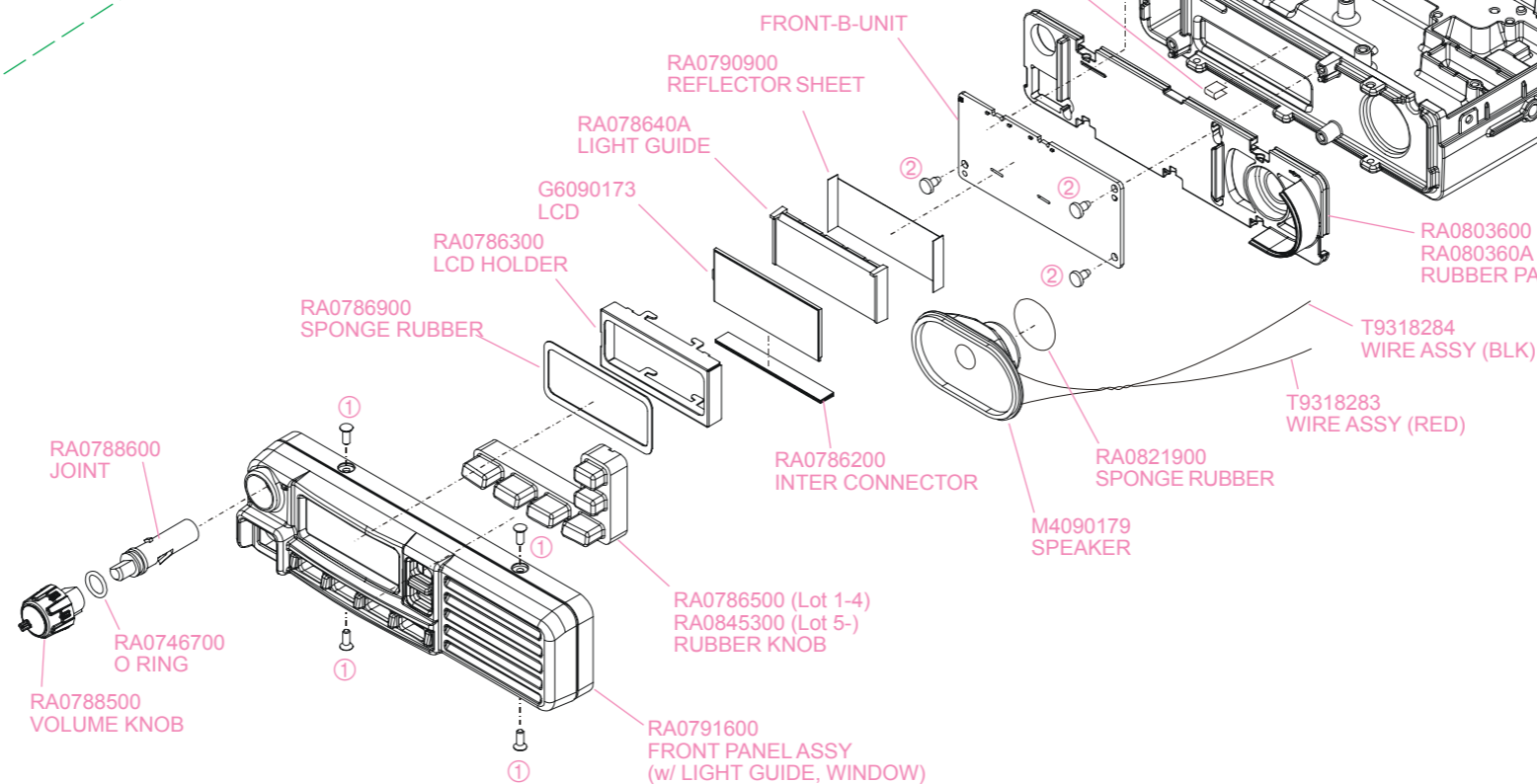

Non-designated parts are available only as part of a designated assembly.

| SUPPLIED ACCESSORIES |                                |      |
|----------------------|--------------------------------|------|
| VXSTD P/N            | DESCRIPTION                    | QTY. |
| Q000075              | BLADE FUSE ATC 15A (50 W TYPE) | 2    |
| Q000112              | BLADE FUSE ATC 10A (25 W TYPE) | 2    |
| AAE60X001            | MICROPHONE MH-67A8J (W/ CLIP)  | 1    |
| T9021015             | DC CABLE (50 W TYPE)           | 1    |
| T9021010             | DC CABLE (25 W TYPE)           | 1    |
| RA079050A            | MOBILE BRACKET                 | 1    |
| RA0796600            | KNOB SCREW (for BRACKET)       | 2    |
| U9900209             | HEX HEAD BOLT HSM5X12B         | 2    |

| No. | VXSTD P/N | DESCRIPTION              | QTY. |
|-----|-----------|--------------------------|------|
| ①   | U10206007 | TRUSS HEAD SCREW M2.6X6B | 10   |
| ②   | U24308002 | TAPTITE SCREW M3X8NI     | 13   |
| ③   | U03308002 | SEMS SCREW ASM3X8NI      | 2    |
| ④   | U24306002 | TAPTITE SCREW M3X6NI     | 2    |

## *Exploded View & Miscellaneous Parts*

*Note:*



## *Block Diagram*

*Note:*



## 1. Circuit Configuration by Frequency

The receiver is a double-conversion superheterodyne with a first intermediate frequency (IF) of 67.65 MHz and a second IF of 450kHz. The incoming signal from the antenna is mixed with the local signal from the VCO/PLL to produce the first IF of 50.85MHz. This is then mixed with the 67.2 MHz second local oscillator output to produce the 450 kHz second IF. This is detected to give the demodulated signal. The transmit signal frequency is generated by the PLL VCO and modulated by the signal from the microphone. It is then amplified and sent to the antenna.

## 2. Receiver System

### 2-1. Front-end RF amplifier

The incoming RF signal from the antenna is delivered to the RF Unit and passes through the Low-pass filter which removes undesired frequencies by use of varactor diodes, tuned band-pass filter consisting of diodes **D1003**, **D1004**, **D1005**, & **D1006** (all **1SV323**), coils L1006 & L1009, and capacitors C1013, C1016, C1033, C1039, C1041, & C1044. The passed signal is amplified in **Q1007 (2SC3356)** and moreover cuts an image frequency with the band pass filter consisting of coils L1011, L1013, L1014, & L1015, capacitors C1003, C1011, C1012, C1016, C1022, C1023, C1027, C1028, C1334, & C1141 and comes into the 1st mixer.

### 2-2. First Mixer

The 1st mixer consists of the **Q1025 (3SK293)**. Buffered output from the VCO is amplified by **Q1023 (2SC5226)** to provide a pure first local signal between 201.65 and 241.65 MHz for injection to the first mixer. The output IF signal enters from the mixer to the crystal filter. The IF signal then passes through monolithic crystal filters XF1001 ( $\pm 5.5$  kHz BW) to strip away all but the desired signal.

### 2-3. IF Amplifier

The first IF signal is amplified by **Q1033 (2SC5226)**. The amplified first IF signal is applied to FM IF subsystem IC **Q1036 (NJM2591)** which contains the second mixer second local oscillator limiter amplifier noise amplifier and S-meter amplifier. The signal from the reference oscillator is tripled by **Q1033 (2SC5226)**, it is mixed with the IF signal and becomes 450 kHz. The second IF then passes through the ceramic filter CF1001 (for wide channels) CF1002 (for narrow channels) to strip away unwanted mixer products which removes amplitude variations in the 450 kHz IF before detection of the speech by the ceramic discriminator CD1001.

### 2-4. Audio amplifier

Detected signal from **Q1036 (NJM2591V)** is inputted to **Q1042 (LM2902PW)** and is output through the band pass filter inside **Q1042 (LM2902PW)**. When the optional unit is installed **Q1044 (SN74LV4066APW)** is turned "OFF" and the AF signal from **Q1042 (LM2902PW)** goes the optional unit. When the optional unit is not installed, **Q1042 (LM2902PW)** is turned "ON" and the signal goes through **Q1004 (SN74LV4053APM)**. The signal then goes through AF mute switch **Q1044 (SN74LV4066APW)** de-emphasis part **Q1042 (LM2902PW)**, amplified with AF power amplifier **Q1003 (TDA1519CTH)** after passing AF volume **Q1014 (M62364FP)**. The output of **Q1003 (TDA1519CTH)** drives a speaker (either the internal or external speaker).

### 2-5. Squelch Circuit

There are 13 levels of squelch setting from 0 to 12. The level 0 means open the squelch. The level 1 means the threshold setting level and level 11 means tight squelch. From 2 to 10 is established in the middle of threshold and tight. The bigger figure is nearer the tight setting. The level 12 becomes setting of carrier squelch.

#### 2-5-1. Noise Squelch

The noise squelch circuit is composed of the band pass filter of **Q1036 (NJM2591V)** noise amplifier **Q1047 (LM2902PW)** and noise detector **D1047** and **D1048** (both **MC2850**). When a carrier isn't received, the noise ingredient which goes out of the demodulator **Q1036 (NJM2591V)** is amplified in **Q1047 (LM2902PW)** through the band pass filter **Q1036 (NJM2591V)** is detected to DC voltage with **D1047**, **D1048** (both **MC2850**) and is inputted to 15 pin (the A/D port) of the **Q1065 (CPU: LC87F5CC8A)**. When a carrier is received the DC voltage becomes "LOW" because the noise is compressed. When the detected voltage to CPU is "HIGH," the CPU stops AF output with **Q1044 (SN74LV4053)** "OFF" by making pin 80 low. When the detection voltage is low the CPU makes **Q1068** "ON" making pin 80 "H" enabling AF output.

#### 2-5-2. Carrier Squelch

The Pin 14 (A/D port) of **Q1065 (CPU: LC87F5CC8A)** detects RSSI voltage output from pin 12 of **Q1036 (NJM2591V)**, and controls AF output. The RSSI output voltage changes according to the signal strength of carrier. The stronger signal makes the RSSI voltage higher. The process of the AF signal control is the same as Noise Squelch. The shipping data is adjusted 3dB higher than squelch tight sensitivity.

# Circuit Description

## 3. Transmitter System

### 3-1. Mic Amplifier

There are two microphone inputs, J1004 (front) and J1006 (D-Sub). Each microphone inputs has its own amplifier. Which microphone is selected is controlled by the CPU and in addition, the amplified AF signal is selected with Flat-AF selection switch **Q1043 (LM2902PW)**. Mic Gain is adjusted with Mic gain VR **Q1014 (M62364PF)** through HPF-AMP **Q1043 (LM2902PW)**, and Pre Emphasis and Mic Mute **Q1044 (SN74LV4066)** are passed at FLAT-AF OFF. And, the option use is selected with OPT selection switch **Q1044 (SN74LV4066)** by the control from CPU. The selected signal enters maximum deviation adjustment volume **Q1014 (M62364FP)** after it goes out of Buffer Amp **Q1043 (LM2902PW)** through limiter and splatter filter of **Q1040 (LM2902PW)**. The adjusted low frequency signal ingredient is amplified by **Q1047 (LM2902PW)** added modulation terminal of TCXO (**X1002**) the FM modulation is made by reference oscillator. The high frequency signal ingredient is amplified **Q1043 (LM2902PW)**, and the level is adjusted by volume control **Q1014 (M62364FP)** to make frequency balance between low frequency. After that, the signal is delivered to the transmit carrier by modulator **D1023 (HVC383B)**.

### 3-2. Drive and Final amplifier

The modulated signal from the VCO **Q1031 (2SC3356)** is buffered by **Q1027 (2SC5226)** and amplified by **Q1015 (2SC3357)**. The low-level transmit signal is then applied to the Power Module **Q1009 (S-AV32)** for final amplification up to 50 watts output power or **Q1009 (S-AV33A)** for final amplification up to 25 watts output power. The transmit signal then passes through a low-pass filter to suppress harmonic spurious radiation before delivery to the antenna.

### 3-3. Automatic Transmit Power Control

The output power of Power Module is detected by CM coupler, and is detected by **D1008** and **D1038** (both **HSM88AS**) and is inputted to comparator **Q1048 (LM2902PW)**. The comparator compares two different voltages and makes output power stable by controlling the bias voltage of the power module. There are 3 levels of output power (High, Low-Hi, and Low-Middle for 50 W model) or 4 levels of output power (High, Low-Hi, Low-Middle, and E-Low for 25 W model) which is switched by the voltage of **Q1014-CH1 (M62364FP)**.

### 3-4. PLL Frequency Synthesizer

The frequency synthesizer consists of PLL IC **Q1054 (ADF411BRU)** VCO, TCXO (**X1002**) and buffer amplifier. The output frequency from TCXO is 16.8 MHz and the tolerance is  $\pm 2.5$  ppm (in the temperature range  $-30$  to  $+60$  degrees).

#### 3-4-1. VCO

While the radio is receiving, the RX oscillator **Q1029 (2SK508)** in the VCO generates a programmed frequency between 201.65 and 241.65 MHz as 1st local signal. While the radio is transmitting the TX oscillator **Q1031 (2SC3356)** in the VCO generates a frequency between 134 and 174 MHz. The output from oscillator is amplified by buffer amplifier **Q1027 (2SC5226)** and becomes the output of the VCO. The output from VCO is divided one is amplified by **Q1024 (2SC5226)** and feed back to pin 6 of the PLL IC **Q1054 (TRF3750IP)**. The other is amplified in **Q1023 (2SC5226)** and in case of the reception it is put into the mixer as the 1st local signal through **D1020 (DAN222)** in transmission it is amplified in **Q1027 (2SC5226)** and more amplified in **Q1023 (2SC5226)** through **D1022 (DA222)** and it is put the input terminal of the Power Module **Q1009 (S-AV32)** for 50 W model or **S-AV33A** for 25 W model).

#### 3-4-2. VCV CNTRL

Tuning voltage (VCV) of the VCO expands the lock range of VCO by controlling the of varactor diode voltage and the control voltage from PLL IC **Q1054 (ADF411BRU)**. Control voltage is added to the varactor diode after converted to D/A converter **Q1029 (M62364FP)**.

#### 3-4-3. PLL

The PLL IC **Q1054 (ADF411BRU)** consists of reference divider, main divider, phase detector, charge pumps and Pulse Swallow Frequency Synthesis. The reference frequency from TCXO is inputted to pin 8 of PLL IC **Q1054 (ADF411BRU)** and is divided by reference divider. This IC is decimal point dividing PLL IC **Q1054 (ADF411BRU)** and the dividing ratio becomes 1/8 of usual PLL frequency step. Therefore, the output of reference divider is 8 times of frequencies of the channel step. For example when the channel stepping is 5 kHz, the output of reference divider becomes 40 kHz. On the other hand, inputted feed back signal to pin 6 of PLL IC **Q1054 (ADF411BRU)** from VCO is divided with the dividing ratio which becomes same frequency as the output of reference divider. These two signals are compared by phase detector, a phase pulse is generated. The phase difference pulse and the pulse from fractional accumulator pass through the charge pumps and LPF. This becomes the DC voltage (VCV) to control the VCO. The oscillation frequency of VCO is locked by the control of this DC voltage. The PLL serial data from CPU **Q1065** (CPU: **LC87F5CC8A**) is sent with three lines of SDO (pin 12), SCK (pin 11) and PSTB (pin 13). The lock condition of PLL is output from the UL (pin 14) terminal and UL becomes "H" at the time of the lock condition and becomes "L" at the time of the unlocked condition. The CPU **Q1065** (CPU: **LC87F5CC8A**) always watches over the UL condition, and when it becomes "L" unlocked condition, the CPU **Q1065** (CPU: **LC87F5CC8A**) prohibits transmitting and receiving.

## Introduction

The VX-2100/-2200 series has been aligned at the factory for the specified performance across the entire frequency range specified. Realignment should therefore not be necessary except in the event of a component failure. All component replacement and service should be performed only by an authorized Vertex Standard representative, or the warranty policy may be voided.

The following procedures cover the sometimes critical and tedious adjustments that are not normally required once the transceiver has left the factory. However, if damage occurs and some parts are replaced, realignment may be required. If a sudden problem occurs during normal operation, it is likely due to component failure; realignment should not be done until after the faulty component has been replaced.

We recommend that servicing be performed only by authorized Vertex Standard service technicians who are experienced with the circuitry and fully equipped for repair and alignment. Therefore, if a fault is suspected, contact the dealer from whom the transceiver was purchased for instructions regarding repair. Authorized Vertex Standard service technicians realign all circuits and make complete performance checks to ensure compliance with factory specifications after replacing any faulty components. Those who do undertake any of the following alignments are cautioned to proceed at their own risk. Problems caused by unauthorized attempts at realignment are not covered by the warranty policy. Also, Vertex Standard must reserve the right to change circuits and alignment procedures in the interest of improved performance, without notifying owners. Under no circumstances should any alignment be attempted unless the normal function and operation of the transceiver are clearly understood, the cause of the malfunction has been clearly pinpointed and any faulty components replaced, and the need for realignment determined to be absolutely necessary. The following test equipment (and thorough familiarity with its correct use) is necessary for complete realignment. Correction of problems caused by misalignment resulting from use of improper test equipment is not covered under the warranty policy. While most steps do not require all of the equipment listed, the interactions of some adjustments may require that more complex adjustments be performed afterwards. Do not attempt to perform only a single step unless it is clearly isolated electrically from all other steps. Have all test equipment ready before beginning, and follow all of the steps in a section in the order presented.

## Required Test Equipment

- Radio Tester with calibrated output level at 200 MHz
- In-line Wattmeter with 5% accuracy at 200 MHz
- 50-ohm, 50-W RF Dummy Load
- Regulated DC Power Supply (standard 13.6V DC, 15A)
- Frequency Counter:  $\pm 0.2$  ppm accuracy at 200 MHz
- AF Signal Generator
- AC Voltmeter
- DC Voltmeter
- VHF Sampling Coupler
- Microsoft® Windows® 95 or later operating system
- Vertex Standard VPL-1 Connection Cable and CE82 Alignment program

## Alignment Preparation & Precautions

A 50-ohm RF Dummy load and in-line wattmeter must be connected to the main antenna jack in all procedures that call for transmission, except where specified otherwise. Correct alignment is not possible with an antenna.

Because of the BTL (Bridged TransLess) Amplifier circuit used in the VX-2200/-2100, do not connect either side of the speaker leads to chassis "ground."

After completing one step, read the following step to determine whether the same test equipment will be required. If not, remove the test equipment (except dummy load and wattmeter, if connected) before proceeding.

Correct alignment requires that the ambient temperature be the same as that of the transceiver and test equipment, and that this temperature be held constant between 20 °C and 30 °C (68 °F ~ 86 °F). When the transceiver is brought into the shop from hot or cold air, it should be allowed time to come to room temperature before alignment.

Whenever possible, alignments should be made with oscillator shields and circuit boards firmly affixed in place. Also, the test equipment must be thoroughly warmed up before beginning.

**Note:** Signal levels in dB referred to in this procedure are based on 0 dB $\mu$  EMF = 1.0  $\mu$ V.

# Alignment

## Test Setup

Setup the test equipment as shown for transceiver alignment, apply 13.6V DC power to the transceiver. Refer to the drawings above for Alignment Points.

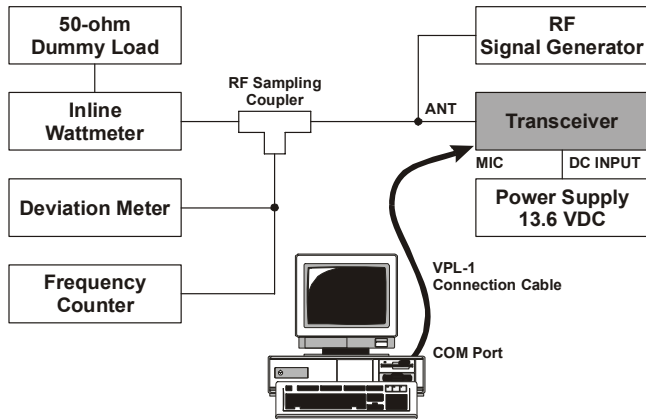

## The Alignment Tool Outline

### Installation the tool

Install the CE82 (Clone Editor) to your PC.

The re-alignment for VX-2200/-2100 series may use the "Alignment" menu of CE82.

### Action of the switches

When the transceiver is in alignment mode, the action of PTT and KEY is ignored. All of the action is remote controlled by PC.

## Basic Alignment Mode

The Basic Alignment mode allows you to align the entire radio. The value of each parameter can be changed to the desired position by use of the "←" / "→" and up/down arrow keys, along with direct number input and dragging of the PC mouse.

To enter the Basic Alignment Mode, select "Basic Alignment" in the main "Radio" menu. It will start to "Upload" the written personalized data from the radio. Pressing the "OK" button will then start the Basic Alignment Mode.

*Note:* when all items are to be aligned, it is strongly rec-

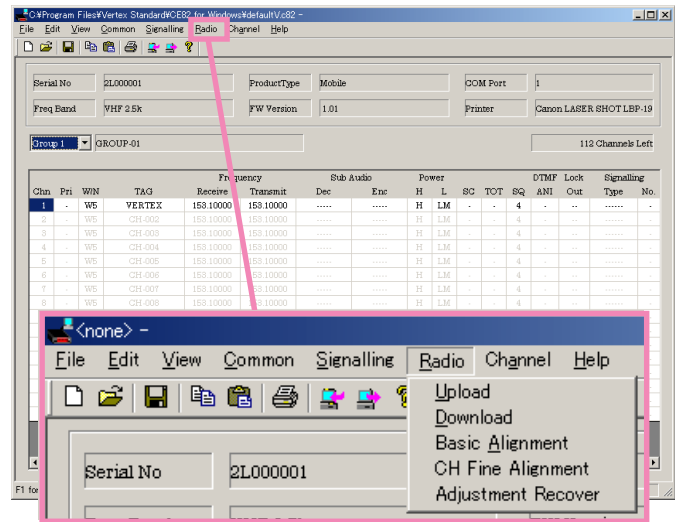

ommended to align them according to following sequence. When the item is selected with TAB key, and the F1 key is pushed, the "Help" file is displayed. Detailed information for each step may be found in the "Help" file within CE82 (Clone Editor).

1. RX VCO Tune Voltage (RX VCO)
2. TX VCO Tune Voltage (TX VCO)
3. PLL Reference Frequency (Frequency)
4. RX Sensitivity (RX Tune)
5. Squelch (SQL)
6. TX Power
7. Maximum Deviation <Wide> / <Narrow>
8. Sub Audio Deviation <CTCSS> / <DCS>
9. Sequential Tone Deviation

## Unit

During alignment, the values of dB $\mu$ V or  $\mu$ V (EMF or PD) can be selected or dBm.

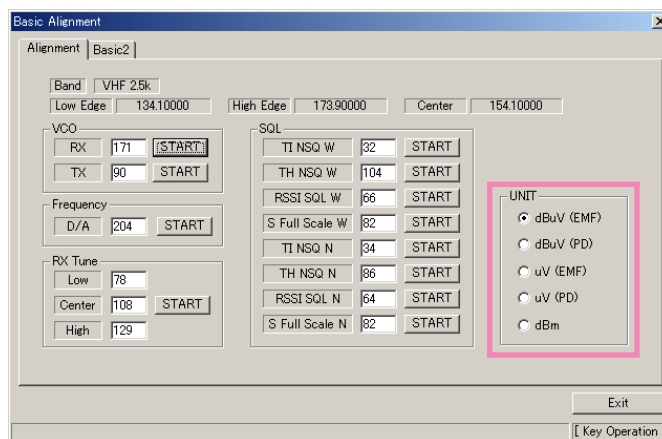

## 1. RX VCO Tune Voltage (RX VCO)

This parameter is to align the “Tune Voltage” of RX VCO. This alignment will be done automatically between the radio and PC.

1. Press the “Start” button on the “Basic Alignment” window to open the RX VCO Adjustment window.
2. Press the “Start” button to start the alignment then the “OK” and “Cancel” buttons are inhibited during the alignment.
3. The aligned value will appear and the “OK”, “Cancel” buttons come alive when auto-alignment is finished.
4. Press the “OK” button on the window, the value of the alignment for RX VCO will be saved in the radio.

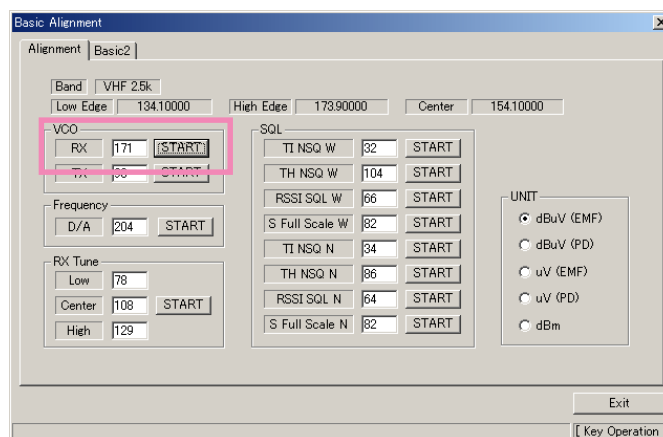

## 2. TX VCO Tune Voltage (TX VCO)

This parameter is to align the “Tune Voltage” of TX VCO. This alignment will be done automatically between the radio and PC.

1. Press the “Start” button on the “Basic Alignment” window to open the TX VCO Adjustment window.
2. Press the “Start” button to start the alignment then the “OK” and “Cancel” buttons are inhibited during the alignment.
3. The aligned value will appear and the “OK”, “Cancel” buttons come alive when auto-alignment is finished.
4. Press the “OK” button on the window, the value of the alignment for TX VCO will be saved in the radio.

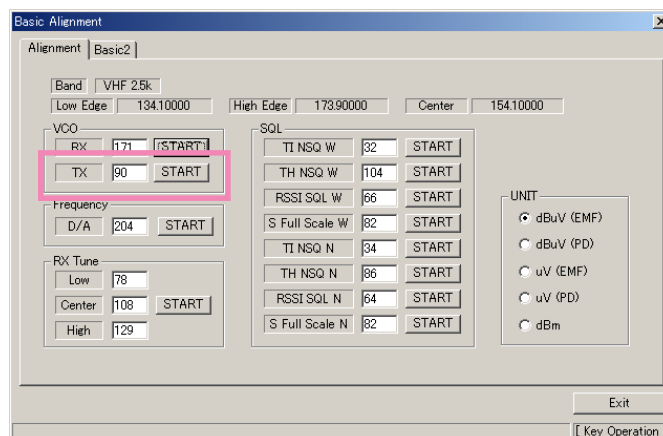

# Alignment

## 3. PLL Reference Frequency (Frequency)

This parameter is to align the reference frequency for PLL. The “TX VCO Tune Voltage” alignment must be done before this alignment is going to start.

1. Press the “Start” button to start the alignment then the radio will transmit on the center frequency. It will appear the Frequency Alignment window.
2. Set the value to get desired frequency by left/right arrow key, drag the slide bar by mouse or direct number input.
3. Press the “OK” button on the alignment window to save the re-aligned value, the alignment of the PLL Reference Frequency is accomplished.

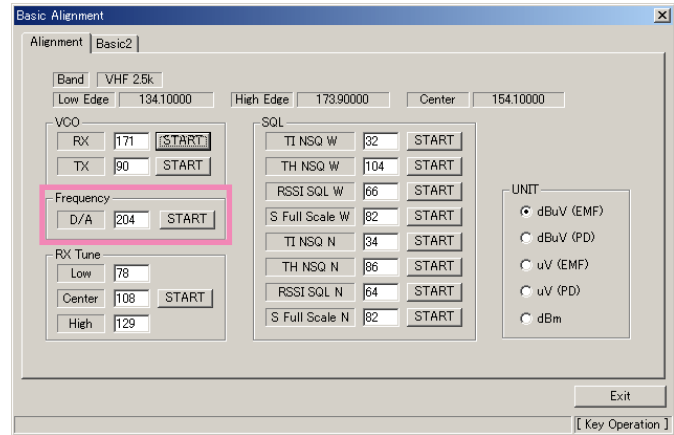

## 4. RX Sensitivity (RX Tune)

This parameter is to align the RX BPF (Band Pass Filter) for Rx sensitivity. It must be done both alignments of the “RX VCO Tune Voltage” and “PLL Reference Frequency” before this alignment is going to start.

1. Press the “Start” button to start the alignment.
2. Set the Signal Generator according to the indication, then press “OK”.
3. Repeat the procedure no.2 until the 3point alignment is finished.
4. It will show the result of 3 points alignment and press “OK” then the confirmation window will open.
5. Press “OK” to finish the RX Sensitivity alignment and save the data.

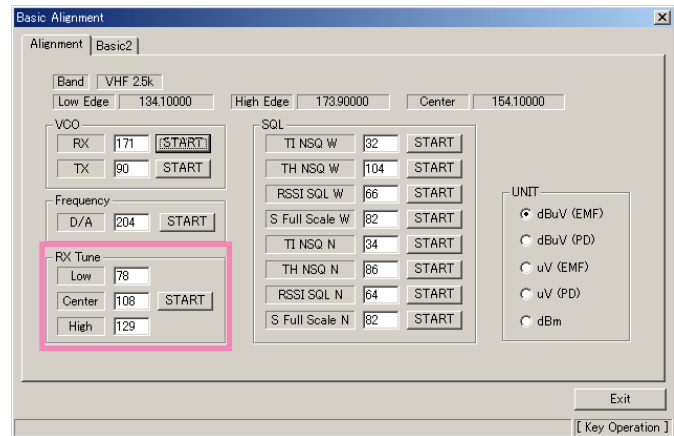

## 5. Squelch (SQL)

This parameter is to align the SQL (Squelch) Sensitivity. The “RX VCO Tune Voltage”, “PLL Reference Frequency” and “RX Sensitivity (RX Tune)” must be done before this alignment is started.

There are several alignments as follows in the Squelch Sensitivity.

### Noise SQL Tight <Wide> (TH NSQ W)

The Alignment for the Noise SQL Tight level at Wide (5k/4k).

### Noise SQL Threshold <Wide> (TH NSQ W)

The Alignment for the Noise SQL Threshold level at Wide (5k/4k).

### RSSI SQL Level 11 <Wide> (RSSI SQL W)

The Alignment for the “level 11” of the RSSI SQL level at Wide (5k/4k).

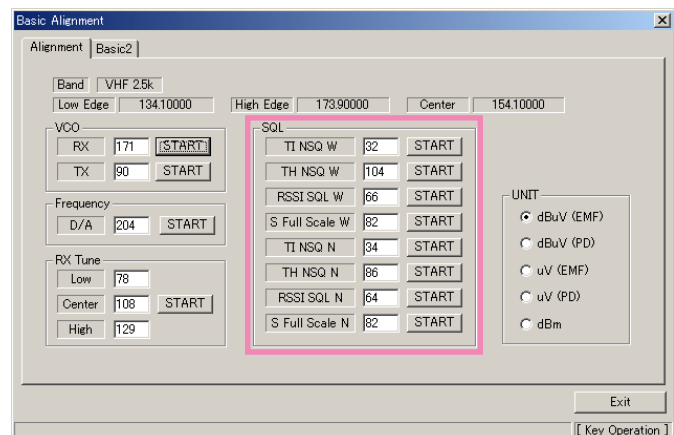

## RSSI SQL Full Scale <Wide> (S Full Scale W)

The Alignment for the RSSI Full Scale level at Wide (5k/4k).

## Noise SQL Tight <Narrow> (TI NSQ N)

The Alignment for the Noise SQL Tight level at Narrow (2.5k).

## Noise SQL Threshold <Narrow> (TH NSQ N)

The Alignment for the Noise SQL Threshold level at Narrow (2.5k).

## RSSI SQL Level 11 <Narrow> (RSSI SQL N)

The Alignment for the “level 11” of the RSSI SQL level at Narrow (2.5k).

## RSSI SQL Full Scale <Narrow> (S Full Scale N)

The Alignment for the RSSI Full Scale level at Narrow (2.5k).

The procedure for all the alignment is as follows.

1. Press the “Start” button to start the alignment.
2. Set the signal generator according to the level indicated, then press “OK”.
3. Press the “OK” button after finish the alignment, then the data will be saved and the alignment is accomplished.

## 6. TX Power

Open the “Basic2” window, this parameter is to align the Transmit Output (Hi/Low) Power. The factory default is as followings.

|                   | 50 W model | 25 W model |
|-------------------|------------|------------|
| <b>High</b>       | 50 W       | 25 W       |
| <b>Low-High</b>   | 25 W       | 12.5 W     |
| <b>Low-Middle</b> | 10 W       | 5 W        |
| <b>E-Low</b>      | —          | 1 W        |

The procedure for the alignments of the TX Power is followings.

1. Press the “Start” button to start the alignment then the radio will transmit on the center frequency. The TX Power Alignment window will open on the PC.
2. Set the value to get desired output power by left/right arrow key, drag the slide bar by mouse or direct number input.
3. Press the “OK” button on the alignment window to save the re-aligned value, the alignment of the TX POWER is accomplished.

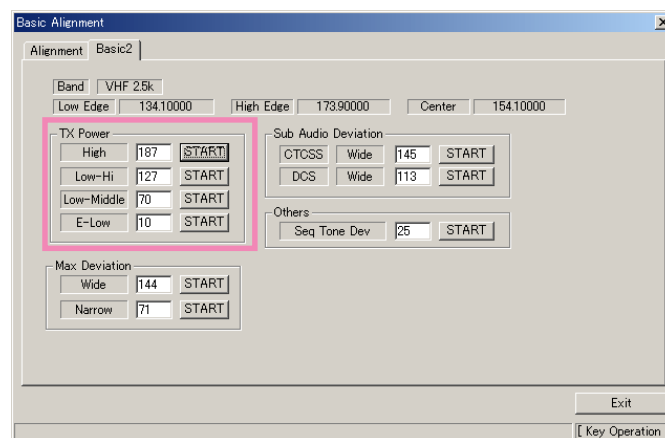

# Alignment

## 7. Maximum Deviation <Wide> / <Narrow>

This parameter is to align the Maximum Deviation (Wide/Narrow). The “TX VCO Tune Voltage” must be done before this alignment is started.

1. Press the “Start” button to start the alignment.
2. Set the value to get desired deviation (Wide: 4.2kHz, Narrow: 2.1kHz) on the deviation meter by changing the slide bar on your PC.
3. Press the “OK” button after getting the desired Deviation to save the re-aligned value, the alignment of the MAX DEVIATION is accomplished.

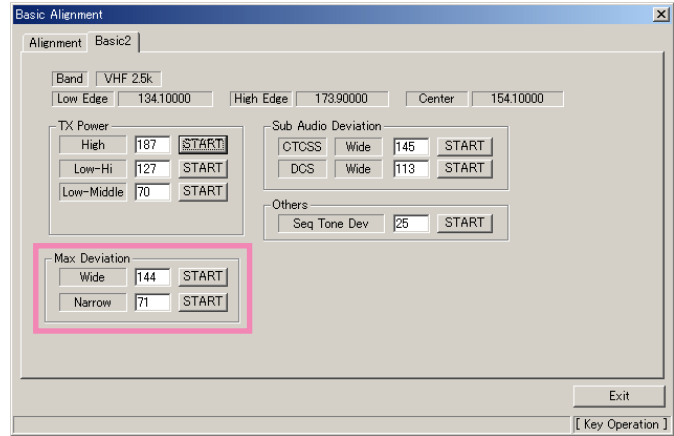

## 8. Sub Audio Deviation <CTCSS> / <DCS>

This parameter is to align the Deviation of Sub-Audio (CTCSS/DCS). The “TX VCO Tune Voltage” and “Max Deviation” must be done before this alignment is started.

1. Press the “Start” button to start the alignment.
2. Set the value to get desired deviation (Wide: 0.6kHz) on the deviation meter by changing the slide bar on your PC.
3. Press the “OK” button after getting the desired value to save the re-aligned value, the alignment of the MAX DEVIATION is accomplished.

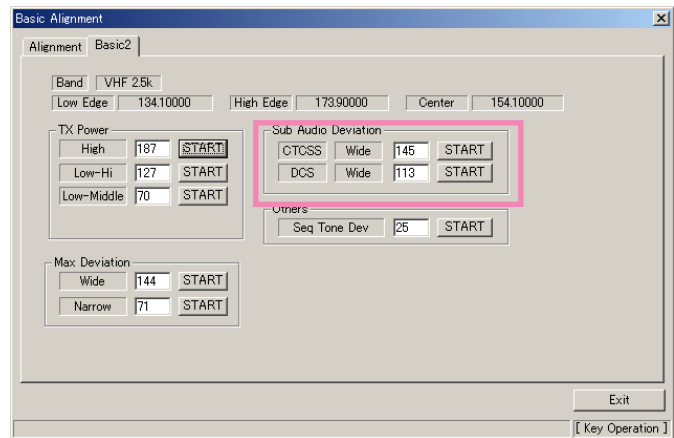

## 9. Sequential Tone Deviation

This parameter is to align the “Sequential Tone Deviation” (for 2-Tone, 5-Tone and DTMF sequential tones).

1. Press the “Start” button to start the alignment.
2. Set the value to get desired deviation by changing the slide bar on your PC.
3. Press the “OK” button after getting the desired value to save the re-aligned value, the alignment of the SEQUENTIAL TONE DEVIATION is accomplished.

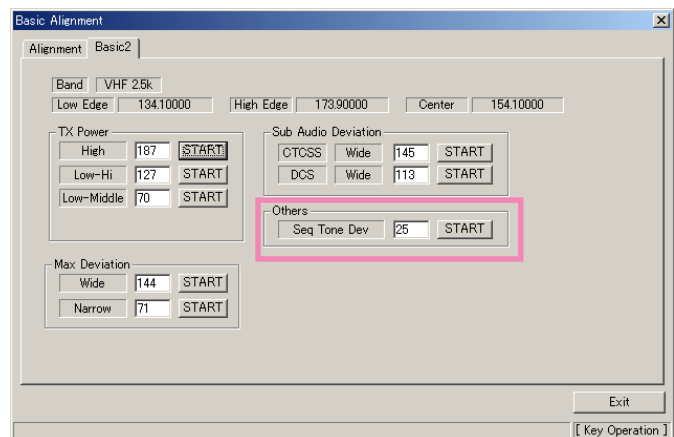



## CH (Channel-by-Channel) Fine Alignment Mode

The CH Fine Alignment Mode allows you to align the radio separately for every operating channel. The value of each parameter can be changed to the desired position using the “←” / “→” and up/down arrow keys, direct number input, and by dragging the PC mouse.

To enter the CH Fine Alignment Mode, select “CH Fine Alignment” in the main “Radio” menu. It will start to “Upload” the written personalized data from the radio. Pressing the “OK” button will then start the CH Fine Alignment Mode.

*Note:* Detailed information for each step may be found in the “Help” file within CE82 (Clone Editor).

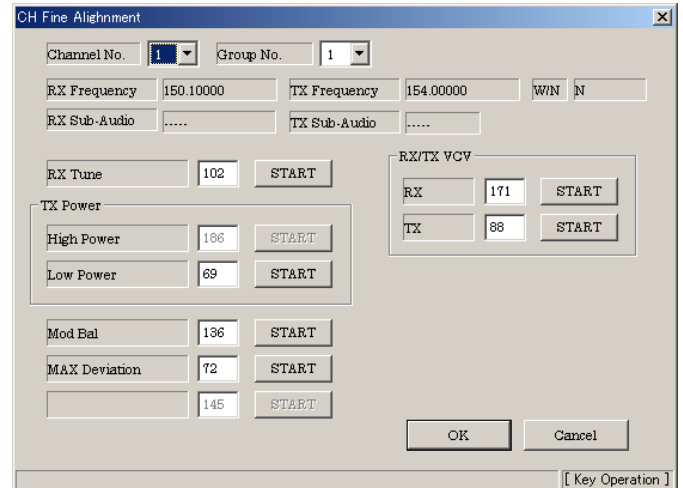

# Installation of Option

## FVP-25/FVP-35/FVP-36

The **FVP-25** is an Encryption/DTMF Paging Unit which permits secure voice communications with station within your network, while preventing others from listening using normal communications equipment. It allows paging, and enables selective calling using DTMF tone sequences.

The **FVP-35** is an Rolling Code Encryption Unit which permits secure voice communications with station within your network, while preventing others from listening using normal communications equipment.

The **FVP-36** is an Voice Inversion Type Encryption Unit which permits secure voice communications with station within your network, while preventing others from listening using normal communications equipment.

Each optional Unit is easily programmed the configurations using a Vertex CE82 programmer with an IBM PC-compatible computer.

1. Disconnect the DC power cable.
2. Referring to Figure 1, remove the 8 screws affixing the Top Cover, then remove the top cover.
3. Referring to Figure 2 & Figure 3, locate the empty connector for the Optional Unit, connect the Optional Unit here.
4. Replace the Top Cover and 8 screws . Installation is now complete.

*Do not install all Optional Unit at once*

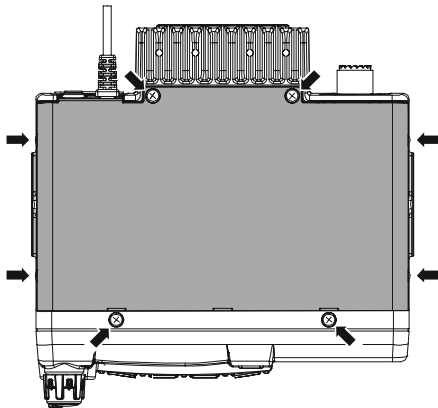

Figure 1

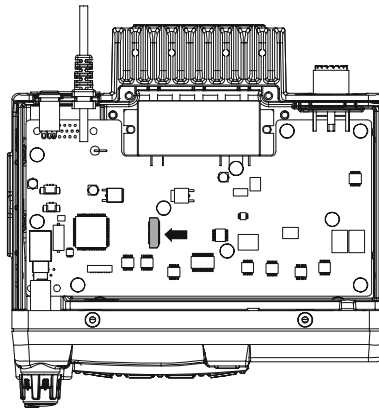

Figure 2

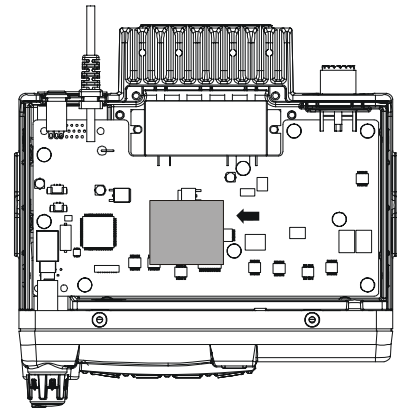
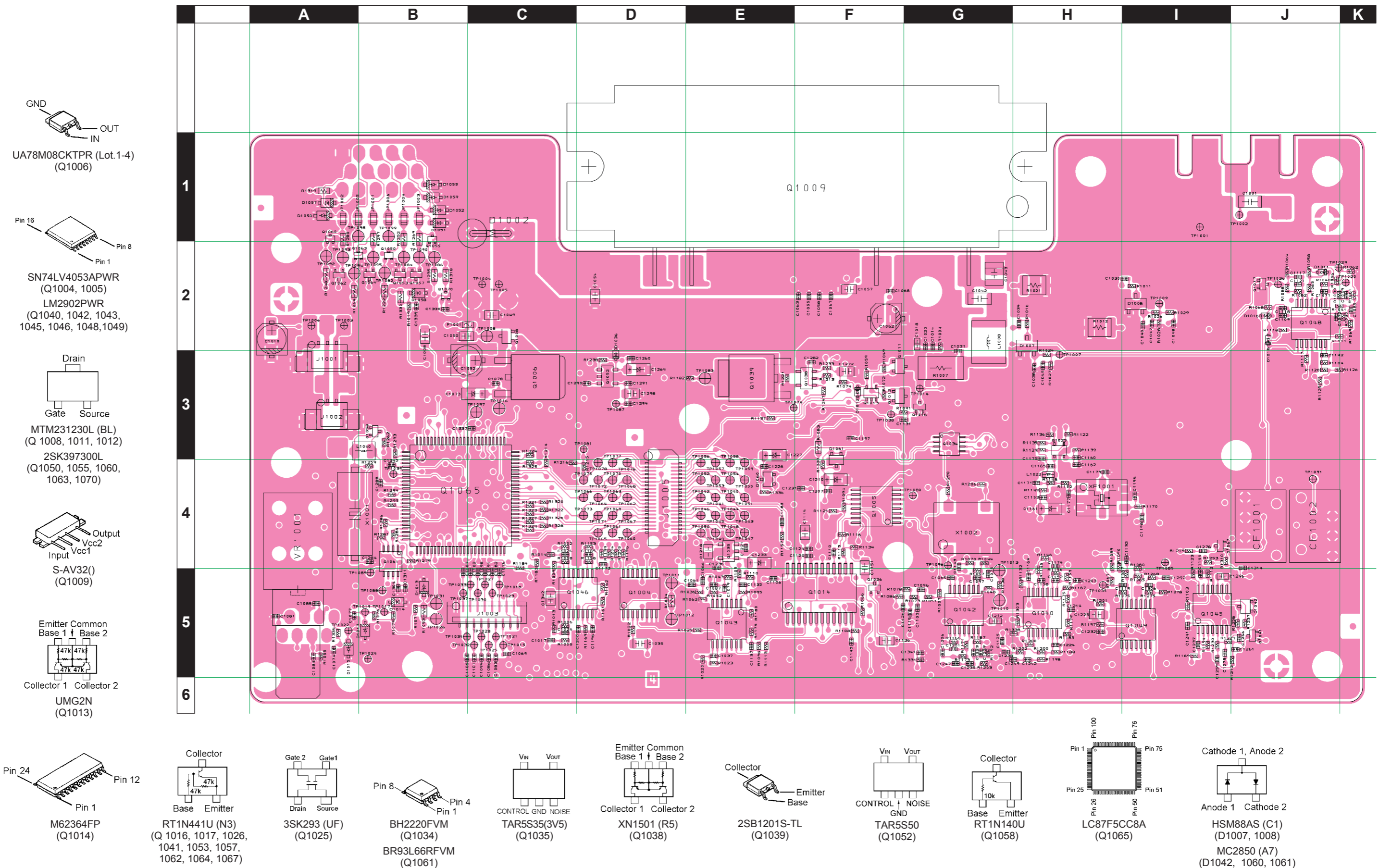

Figure 3



***MAIN Unit (Lot. 1~4)***

*Note*







***MAIN Unit (Lot. 5~8)***

*Note*



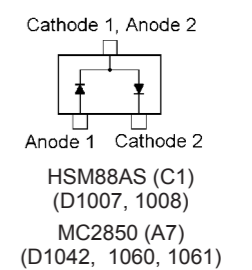
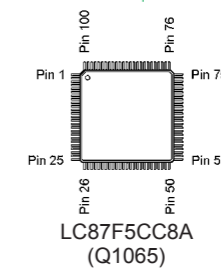
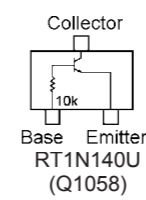
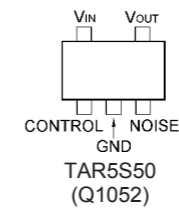
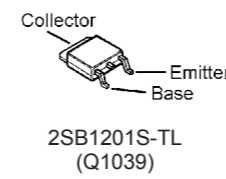
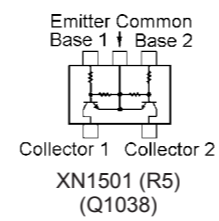
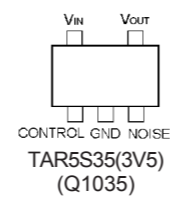
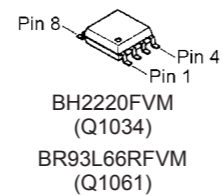
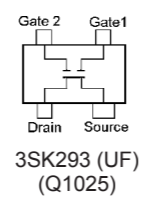
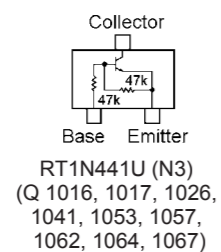
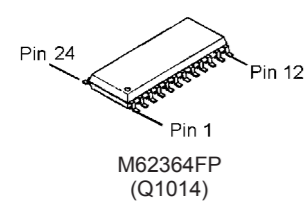
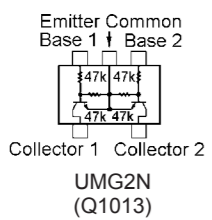
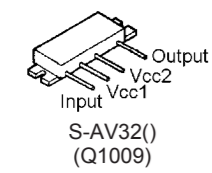
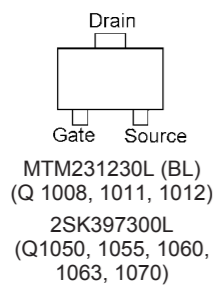
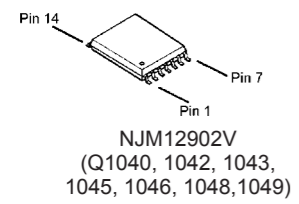
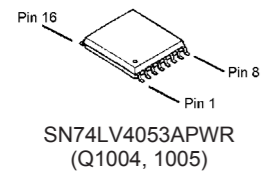
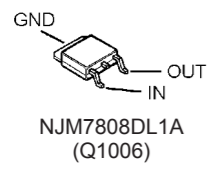
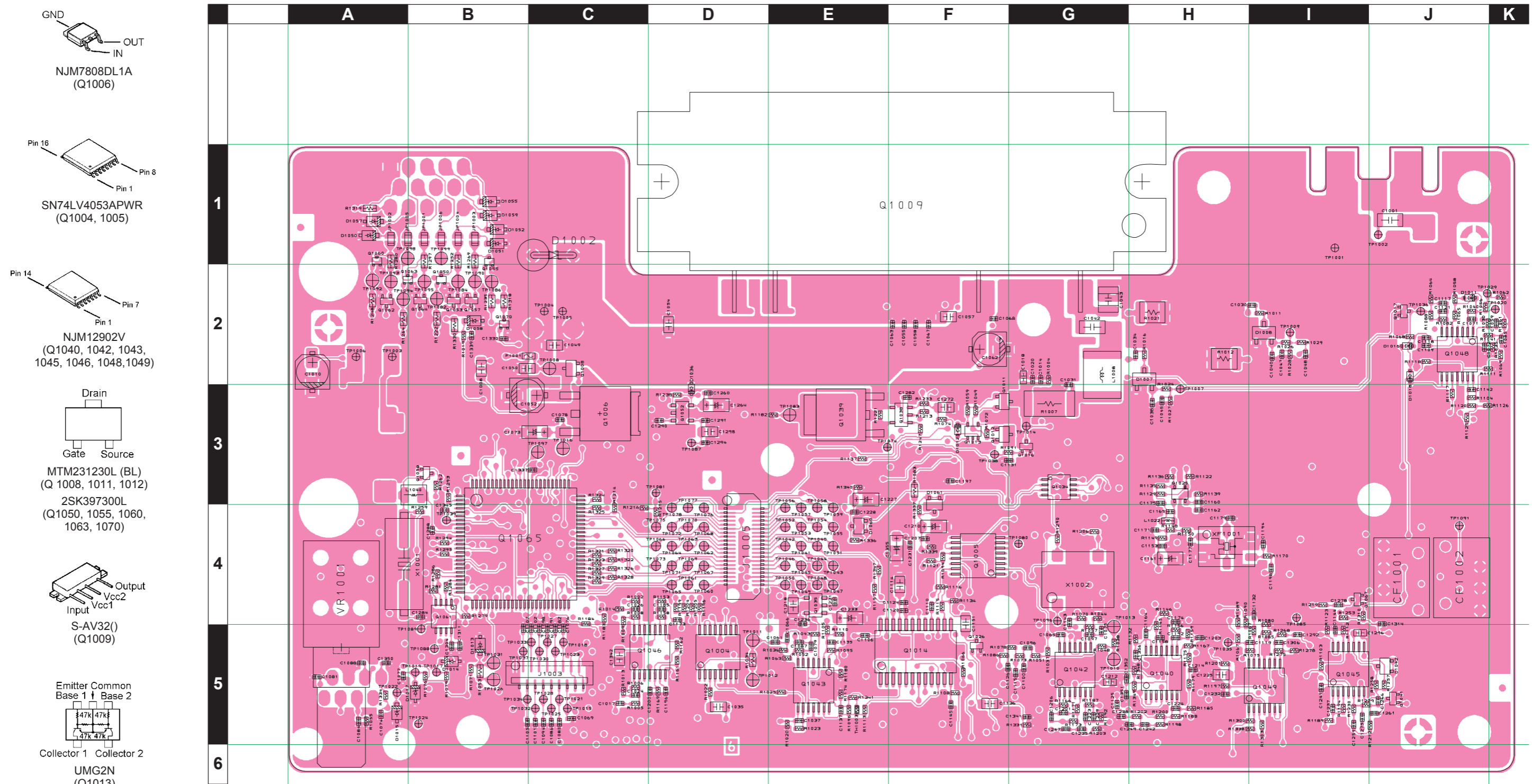

# MAIN Unit (Lot. 5~8)

## Parts Layout (Side B)

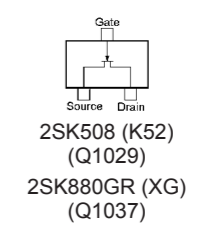
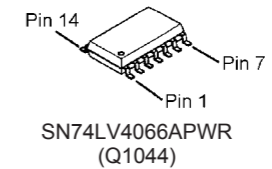
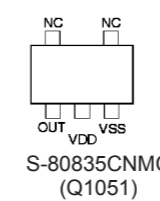
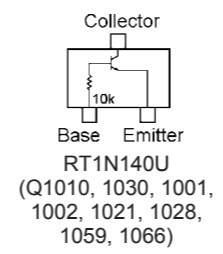
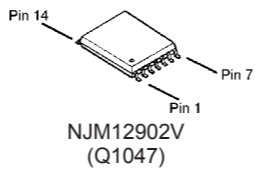
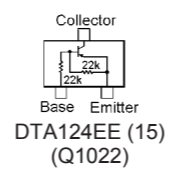
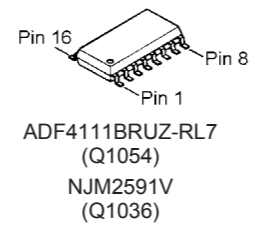
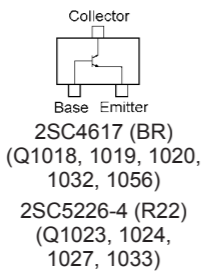
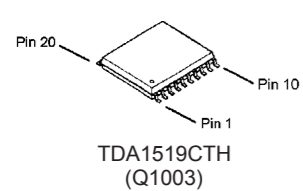
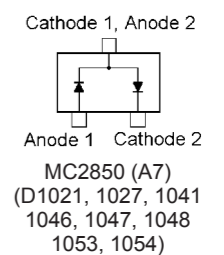
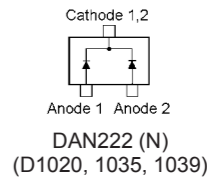
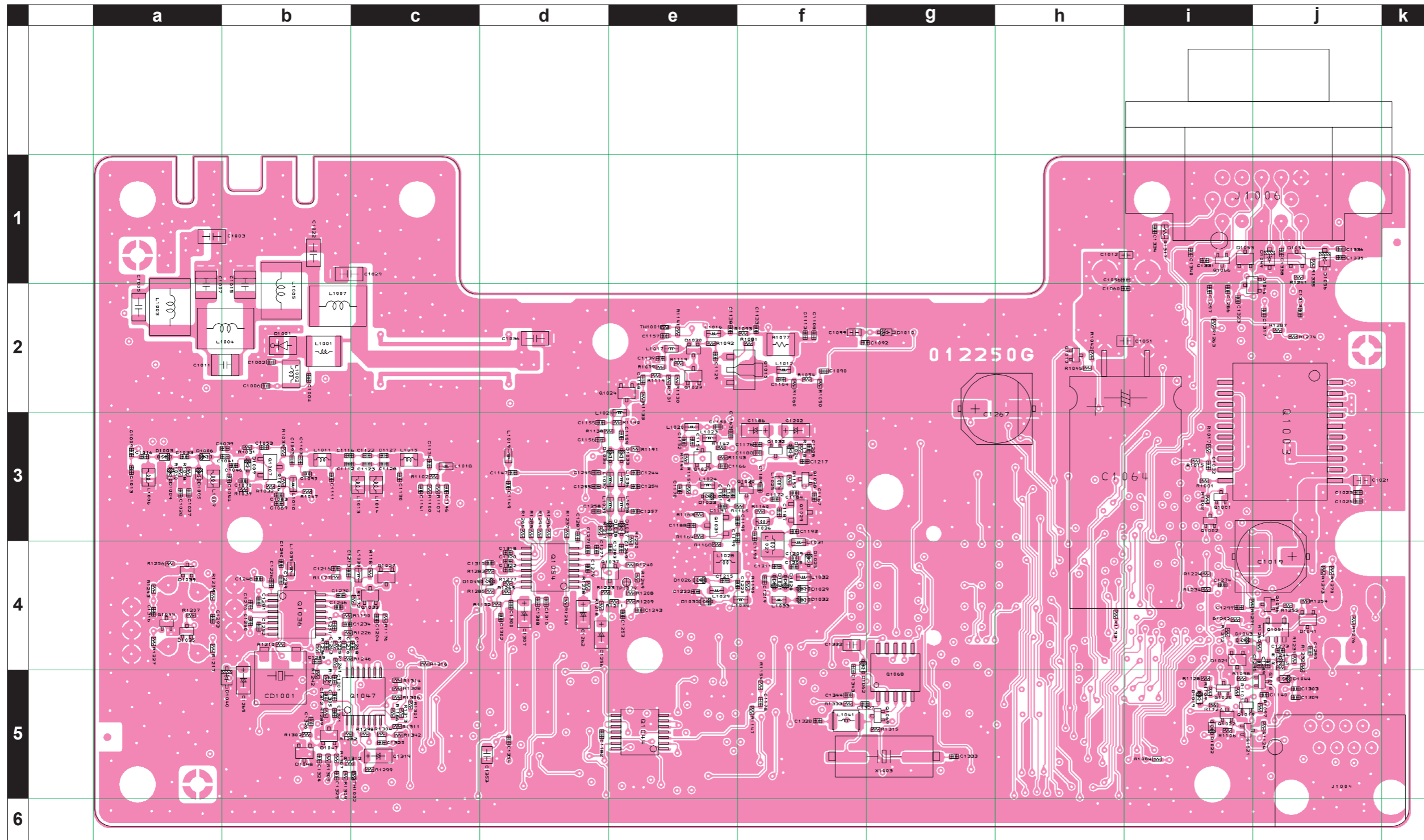

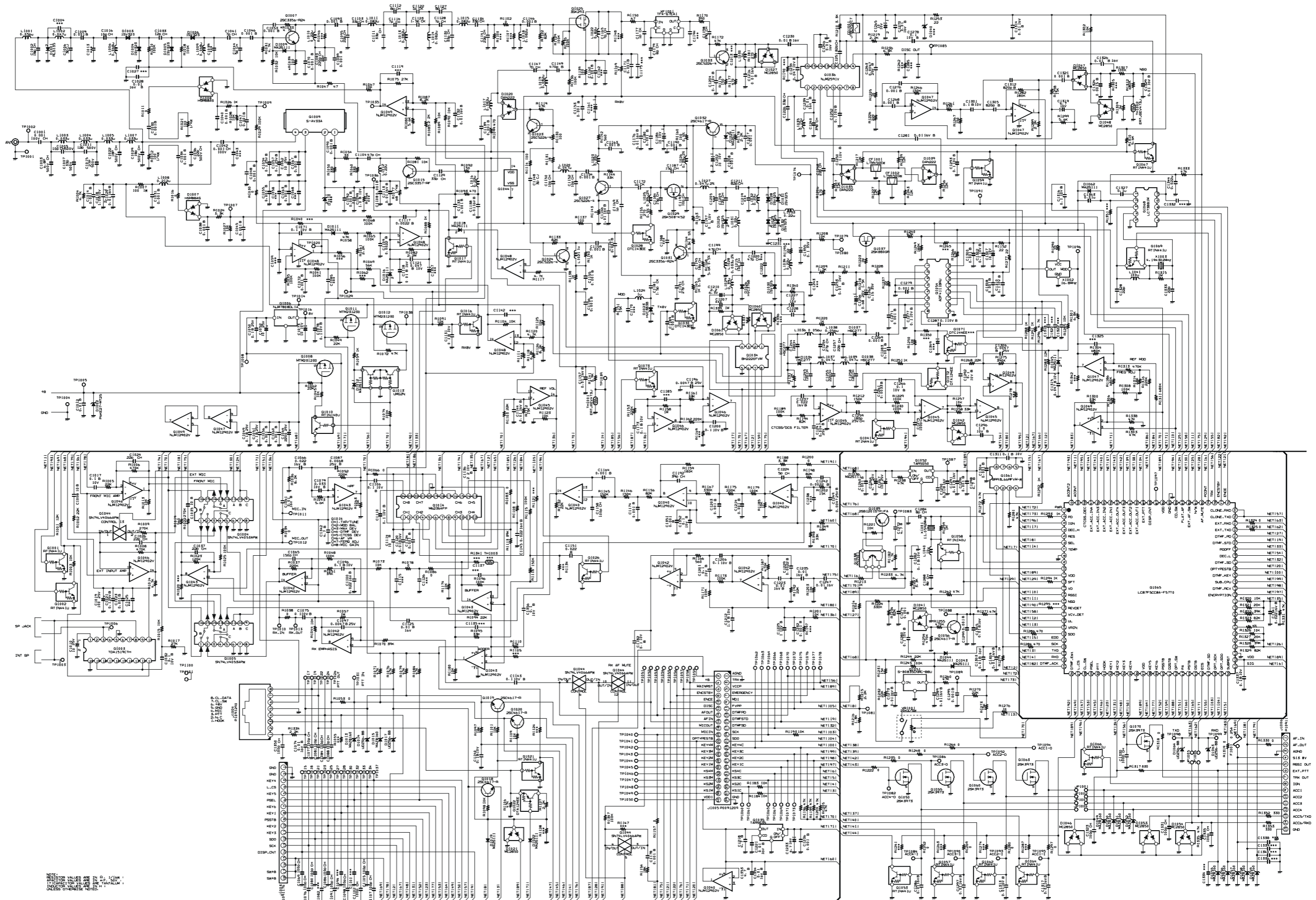

***MAIN Unit (Lot. 9~)***

*Note*



# MAIN Unit (Lot. 9~)

## Parts Layout (Side B)

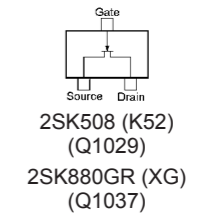
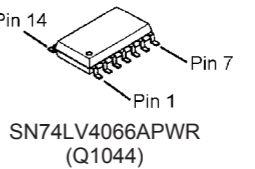
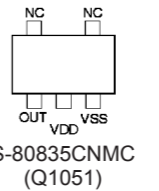
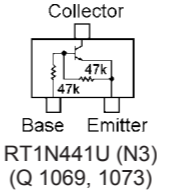
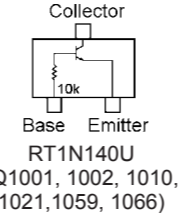
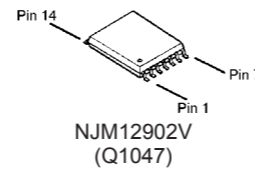
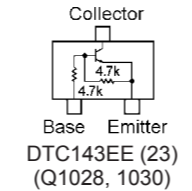
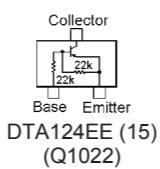
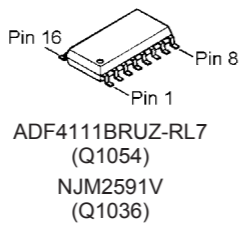
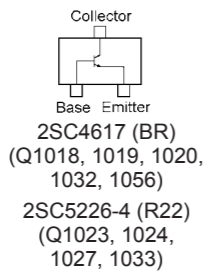
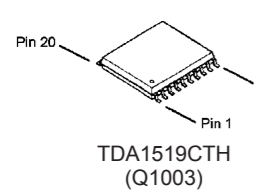
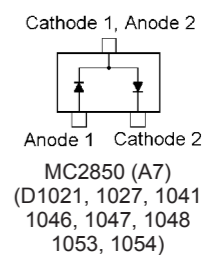
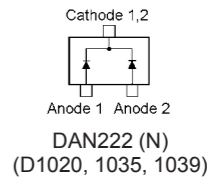
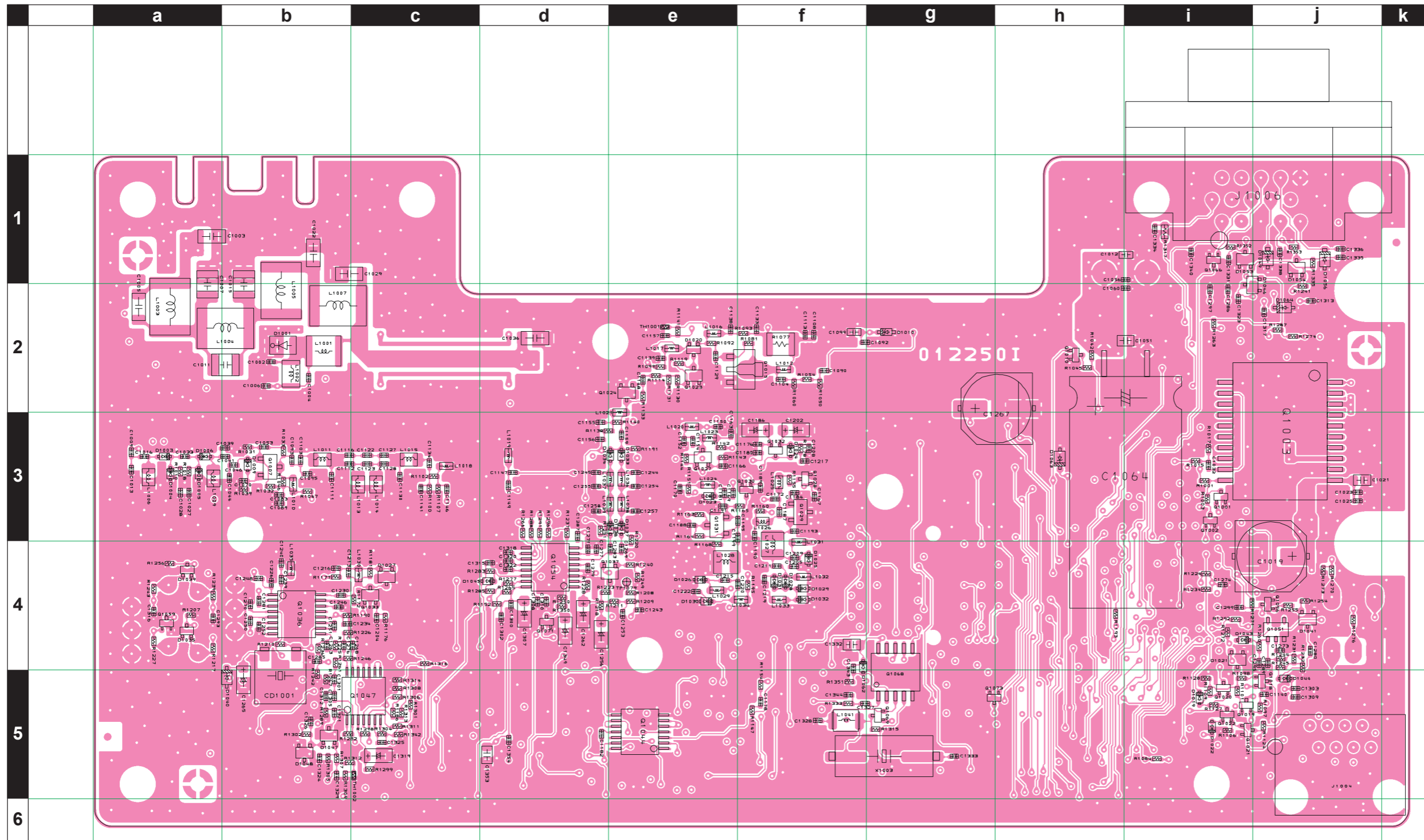

# MAIN Unit

## Parts List

| REF                   | DESCRIPTION     | VALUE   | V/W  | TOL. | MFR'S DESIG        | VXSTD P/N | VERS.      | LOT | SIDE | LAY | ADR |
|-----------------------|-----------------|---------|------|------|--------------------|-----------|------------|-----|------|-----|-----|
| PCB with Components   |                 |         |      |      |                    | CS1873001 | VTX 50 W   |     |      |     |     |
|                       |                 |         |      |      |                    | CS1873002 | VTX 25 W   |     |      |     |     |
|                       |                 |         |      |      |                    | CS1873003 | EU 25 W    |     |      |     |     |
|                       |                 |         |      |      |                    | CS1873004 | EXP 50 W   |     |      |     |     |
|                       |                 |         |      |      |                    | CS1873005 | EXP 25 W   |     |      |     |     |
|                       |                 |         |      |      |                    | CS1873007 | CHN 50 W   |     |      |     |     |
|                       |                 |         |      |      |                    | CS1873008 | CHN 25 W   |     |      |     |     |
| Printed Circuit Board |                 |         |      |      |                    | FR012250E |            | 1-  |      |     |     |
|                       |                 |         |      |      |                    | FR012250G |            | 5-  |      |     |     |
|                       |                 |         |      |      |                    | FR012250I |            | 9-  |      |     |     |
| C 1001                | CERAMIC CAP.    | 0.001uF | 100V | CH   | GRM42-6CH102J100PT | K22201202 |            | 1-  | A    |     | J1  |
| C 1002                | CHIP CAP.       | 18pF    | 50V  | CH   | GRM1552C1H180JZ01D | K22178218 |            | 1-  | B    |     | b2  |
| C 1003                | CHIP CAP.       | 5.6pF   | 500V | CH   | 1206N5R6C501LT     | K22278206 |            | 1-8 | B    |     | a1  |
| C 1003                | CHIP CAP.       | 6.8pF   | 500V | CH   | 1206N6R8D501LT     | K22278207 | 25W        | 9-  | B    |     | a1  |
| C 1003                | CHIP CAP.       | 5.6pF   | 500V | CH   | 1206N5R6C501LT     | K22278206 | 50W        | 9-  | B    |     | a1  |
| C 1005                | CHIP CAP.       | 10pF    | 500V | CH   | CF316CH100D500AT   | K22271255 |            | 1-  | B    |     | a2  |
| C 1006                | CHIP CAP.       | 3pF     | 50V  | CJ   | GRM1553C1H3R0BZ01D | K22178290 |            | 1-  | B    |     | b2  |
| C 1007                | FILM CAP.       | 33pF    | 500V |      | UC232H0330G-T      | K33279053 |            | 1-8 | B    |     | a1  |
| C 1007                | CHIP CAP.       | 33pF    | 500V | CH   | GRM42-6CH330J500PT | K22271225 | 25W        | 9-  | B    |     | a1  |
| C 1007                | FILM CAP.       | 33pF    | 500V |      | UC232H0330G-T      | K33279053 | 50W        | 9-  | B    |     | a1  |
| C 1008                | CHIP CAP.       | 10uF    | 6.3V | B    | JMK212BJ106KG-T    | K22080802 |            | 1-  | A    |     | B2  |
| C 1009                | CHIP CAP.       | 0.001uF | 50V  | B    | GRM155B11H102KA01D | K22178809 |            | 1-  | B    |     | a3  |
| C 1010                | AL.ELECTRO.CAP. | 10uF    | 25V  |      | EMVA250ADA100MD55G | K48140014 |            | 1-  | A    |     | A2  |
| C 1011                | FILM CAP.       | 12pF    | 500V |      | UC232H0120J-T      | K33279020 |            | 1-8 | B    |     | b2  |
| C 1011                | CHIP CAP.       | 12pF    | 500V | CH   | 1206N120J501LT     | K22278210 | 25W        | 9-  | B    |     | b2  |
| C 1011                | FILM CAP.       | 12pF    | 500V |      | UC232H0120J-T      | K33279020 | 50W        | 9-  | B    |     | b2  |
| C 1012                | CHIP CAP.       | 0.01uF  | 50V  | B    | GRM188B11H103KA01D | K22174823 |            | 1-  | B    |     | i1  |
| C 1014                | CHIP CAP.       | 0.001uF | 50V  | B    | GRM155B11H102KA01D | K22178809 |            | 1-  | A    |     | G2  |
| C 1015                | FILM CAP.       | 33pF    | 500V |      | UC232H0330G-T      | K33279053 |            | 1-8 | B    |     | b1  |
| C 1015                | CHIP CAP.       | 27pF    | 500V | CH   | GRM42-6CH270J500PT | K22271223 | 25W/CE:OFF | 9-  | B    |     | b1  |
| C 1015                | CHIP CAP.       | 22pF    | 500V | CH   | CF316CH220J500AT   | K22271259 | 25W/CE:ON  | 9-  | B    |     | b1  |
| C 1015                | FILM CAP.       | 33pF    | 500V |      | UC232H0330G-T      | K33279053 | 50W        | 9-  | B    |     | b1  |
| C 1016                | CHIP CAP.       | 10pF    | 50V  | CH   | GRM1552C1H100JZ01D | K22178212 |            | 1-  | B    |     | a3  |
| C 1017                | CHIP CAP.       | 0.1uF   | 10V  | B    | GRM36B104K10PT     | K22108802 |            | 1-  | A    |     | C5  |
| C 1018                | CHIP CAP.       | 1uF     | 10V  | B    | ECJ1VB1A105K       | K22104806 |            | 1-  | A    |     | G2  |
| C 1019                | AL.ELECTRO.CAP. | 100uF   | 25V  |      | EEE1EA101UP        | K48140018 |            | 1-  | B    |     | j4  |
| C 1020                | CHIP CAP.       | 0.01uF  | 16V  | B    | GRM36B103K16PT     | K22128804 |            | 1-  | A    |     | G2  |
| C 1021                | CHIP CAP.       | 0.1uF   | 25V  | B    | GRM40B104M25PT     | K22140811 |            | 1-  | B    |     | j3  |
| C 1022                | CHIP CAP.       | 22pF    | 500V | CH   | 1206N220J501LT     | K22278213 |            | 1-8 | B    |     | b1  |
| C 1022                | CHIP CAP.       | 18pF    | 500V | CH   | 1206N180J501LT     | K22278212 | 25W        | 9-  | B    |     | b1  |
| C 1022                | CHIP CAP.       | 22pF    | 500V | CH   | 1206N220J501LT     | K22278213 | 50W        | 9-  | B    |     | b1  |
| C 1023                | CHIP CAP.       | 0.001uF | 50V  | B    | GRM155B11H102KA01D | K22178809 |            | 1-  | B    |     | j3  |
| C 1024                | CHIP CAP.       | 22pF    | 50V  | CH   | GRM1552C1H220JZ01D | K22178220 |            | 1-  | A    |     | C5  |
| C 1026                | CHIP CAP.       | 22pF    | 50V  | CH   | GRM1552C1H220JZ01D | K22178220 |            | 1-  | A    |     | C4  |
| C 1028                | CHIP CAP.       | 0.01uF  | 16V  | B    | GRM36B103K16PT     | K22128804 |            | 1-  | B    |     | a3  |
| C 1029                | CHIP CAP.       | 18pF    | 500V | CH   | 1206N180J501LT     | K22278212 |            | 1-  | B    |     | b1  |
| C 1030                | CHIP CAP.       | 0.001uF | 50V  | B    | GRM155B11H102KA01D | K22178809 |            | 1-  | A    |     | I2  |
| C 1031                | CHIP CAP.       | 0.001uF | 50V  | B    | GRM155B11H102KA01D | K22178809 |            | 1-  | A    |     | G2  |
| C 1032                | CHIP CAP.       | 0.1uF   | 10V  | B    | GRM36B104K10PT     | K22108802 |            | 1-  | B    |     | i3  |
| C 1033                | CHIP CAP.       | 12pF    | 50V  | CH   | GRM1552C1H120JZ01D | K22178214 |            | 1-  | B    |     | a3  |
| C 1034                | CHIP CAP.       | 0.001uF | 50V  | B    | GRM155B11H102KA01D | K22178809 |            | 1-  | A    |     | H2  |
| C 1035                | CHIP CAP.       | 10uF    | 6.3V | B    | JMK212BJ106KG-T    | K22080802 |            | 1-  | A    |     | D5  |
| C 1036                | CHIP CAP.       | 2.2pF   | 500V | CH   | 1206N2R2C501LT     | K22278201 |            | 1-8 | B    |     | d2  |
| C 1036                | CHIP CAP.       | 22pF    | 500V | CH   | 1206N220J501LT     | K22278213 | 25W        | 9-  | B    |     | d2  |
| C 1036                | CHIP CAP.       | 2.2pF   | 500V | CH   | 1206N2R2C501LT     | K22278201 | 50W        | 9-  | B    |     | d2  |
| C 1037                | CHIP CAP.       | 22pF    | 50V  | CH   | GRM1552C1H220JZ01D | K22178220 |            | 1-  | A    |     | E5  |
| C 1038                | CHIP CAP.       | 0.001uF | 50V  | B    | GRM155B11H102KA01D | K22178809 |            | 1-  | A    |     | H3  |
| C 1040                | CHIP CAP.       | 0.001uF | 50V  | B    | GRM155B11H102KA01D | K22178809 |            | 1-  | A    |     | I2  |
| C 1041                | CHIP CAP.       | 7pF     | 50V  | CH   | GRM1552C1H7R0BZ01D | K22178294 |            | 1-  | B    |     | b3  |
| C 1042                | CERAMIC CAP.    | 0.001uF | 100V | CH   | GRM42-6CH102J100PT | K22201202 |            | 1-  | A    |     | G2  |
| C 1043                | FILM CAP.       | 22pF    | 500V |      | UC232H0220J-T      | K33279021 |            | 1-8 | A    |     | G2  |
| C 1043                | FILM CAP.       | 22pF    | 500V |      | UC232H0220J-T      | K33279021 | 50W        | 9-  | A    |     | G2  |
| C 1044                | CHIP CAP.       | 5pF     | 50V  | CH   | GRM1552C1H5R0CZ01D | K22178207 |            | 1-  | B    |     | b3  |
| C 1045                | CHIP CAP.       | 0.001uF | 50V  | B    | GRM155B11H102KA01D | K22178809 |            | 1-  | A    |     | H3  |
| C 1046                | CHIP CAP.       | 0.001uF | 50V  | B    | GRM155B11H102KA01D | K22178809 |            | 1-  | B    |     | b3  |
| C 1047                | CHIP CAP.       | 0.001uF | 50V  | B    | GRM155B11H102KA01D | K22178809 |            | 1-  | A    |     | I2  |
| C 1048                | CHIP CAP.       | 0.001uF | 50V  | B    | GRM155B11H102KA01D | K22178809 |            | 1-  | A    |     | I2  |
| C 1049                | CHIP CAP.       | 0.1uF   | 25V  | B    | GRM40B104M25PT     | K22140811 |            | 1-  | A    |     | C2  |
| C 1050                | CHIP CAP.       | 0.1uF   | 25V  | B    | GRM40B104M25PT     | K22140811 |            | 1-  | A    |     | B2  |
| C 1051                | CHIP CAP.       | 0.1uF   | 25V  | B    | GRM40B104M25PT     | K22140811 |            | 1-  | B    |     | i2  |
| C 1052                | AL.ELECTRO.CAP. | 10uF    | 25V  |      | EMVA250ADA100MD55G | K48140014 |            | 1-  | A    |     | B3  |
| C 1053                | CHIP CAP.       | 0.001uF | 50V  | B    | GRM155B11H102KA01D | K22178809 |            | 1-  | B    |     | b3  |
| C 1054                | CHIP CAP.       | 0.1uF   | 25V  | B    | GRM40B104M25PT     | K22140811 |            | 1-  | A    |     | D2  |

# MAIN Unit

## Parts List

| REF    | DESCRIPTION     | VALUE    | V/W  | TOL. | MFR'S DESIG        | VXSTD P/N | VERS.    | LOT  | SIDE | LAY ADR |
|--------|-----------------|----------|------|------|--------------------|-----------|----------|------|------|---------|
| C 1055 | CHIP CAP.       | 0.001uF  | 50V  | B    | GRM155B11H102KA01D | K22178809 |          | 1-   | A    | F2      |
| C 1056 | CHIP CAP.       | 0.001uF  | 50V  | B    | GRM155B11H102KA01D | K22178809 |          | 1-   | B    | i1      |
| C 1057 | CHIP CAP.       | 0.1uF    | 25V  | B    | GRM40B104M25PT     | K22140811 |          | 1-   | A    | F2      |
| C 1060 | CHIP CAP.       | 0.001uF  | 50V  | B    | GRM155B11H102KA01D | K22178809 |          | 1-   | B    | i2      |
| C 1061 | CHIP CAP.       | 0.01uF   | 16V  | B    | GRM36B103K16PT     | K22128804 |          | 1-   | A    | E5      |
| C 1062 | AL.ELECTRO.CAP. | 10uF     | 25V  |      | EMVA250ADA100MD55G | K48140014 |          | 1-   | A    | F2      |
| C 1063 | CHIP CAP.       | 0.001uF  | 50V  | B    | GRM155B11H102KA01D | K22178809 |          | 1-   | A    | F2      |
| C 1064 | AL.ELECTRO.CAP. | 2200uF   | 25V  |      | RE3-25V222MI6#     | K40149055 |          | 1-   | B    | i2      |
| C 1065 | CHIP CAP.       | 150pF    | 50V  | CH   | GRM1552C1H151JA01D | K22178240 |          | 1-   | A    | G5      |
| C 1066 | CHIP CAP.       | 0.015uF  | 16V  | B    | GRM36B153K16PT     | K22128807 |          | 1-   | A    | E5      |
| C 1066 | CHIP CAP.       | 0.022uF  | 16V  | B    | GRM36B223K16PT     | K22128806 |          | 5-10 | A    | E5      |
| C 1066 | CHIP CAP.       | 0.033uF  | 10V  | B    | GRM36B333K10PT     | K22108803 | CHINA    | 11-  | A    | E5      |
| C 1066 | CHIP CAP.       | 0.022uF  | 16V  | B    | GRM36B223K16PT     | K22128806 | EUROPE   | 11-  | A    | E5      |
| C 1066 | CHIP CAP.       | 0.022uF  | 16V  | B    | GRM36B223K16PT     | K22128806 | EXPORT   | 11-  | A    | E5      |
| C 1066 | CHIP CAP.       | 0.022uF  | 16V  | B    | GRM36B223K16PT     | K22128806 | VTX(USA) | 11-  | A    | E5      |
| C 1067 | CHIP CAP.       | 0.001uF  | 50V  | B    | GRM155B11H102KA01D | K22178809 |          | 1-   | A    | F2      |
| C 1069 | CHIP CAP.       | 100pF    | 50V  | CH   | GRM1552C1H101JD01D | K22178236 |          | 1-   | A    | C5      |
| C 1070 | CHIP CAP.       | 0.001uF  | 50V  | B    | GRM155B11H102KA01D | K22178809 |          | 1-   | B    | b3      |
| C 1071 | CHIP CAP.       | 0.1uF    | 10V  | B    | GRM36B104K10PT     | K22108802 |          | 1-   | A    | J2      |
| C 1072 | CHIP CAP.       | 0.001uF  | 50V  | B    | GRM155B11H102KA01D | K22178809 |          | 1-   | A    | J2      |
| C 1073 | CHIP TA.CAP.    | 10uF     | 10V  |      | TEMSVA1A106M-8R    | K78100028 |          | 1-   | A    | C3      |
| C 1074 | CHIP CAP.       | 0.01uF   | 16V  | B    | GRM36B103K16PT     | K22128804 |          | 1-   | A    | A5      |
| C 1075 | CHIP CAP.       | 0.1uF    | 10V  | B    | GRM36B104K10PT     | K22108802 |          | 1-   | A    | G5      |
| C 1076 | CHIP CAP.       | 100pF    | 50V  | CH   | GRM1552C1H101JD01D | K22178236 |          | 1-   | A    | C5      |
| C 1077 | CHIP CAP.       | 100pF    | 50V  | CH   | GRM1552C1H101JD01D | K22178236 |          | 1-   | A    | A5      |
| C 1078 | CHIP CAP.       | 0.1uF    | 10V  | B    | GRM36B104K10PT     | K22108802 |          | 1-   | A    | C3      |
| C 1079 | CHIP CAP.       | 0.033uF  | 10V  | B    | GRM36B333K10PT     | K22108803 |          | 1-   | A    | E5      |
| C 1080 | CHIP CAP.       | 100pF    | 50V  | CH   | GRM1552C1H101JD01D | K22178236 |          | 1-   | A    | C5      |
| C 1081 | CHIP CAP.       | 100pF    | 50V  | CH   | GRM1552C1H101JD01D | K22178236 |          | 1-   | A    | A5      |
| C 1083 | CHIP CAP.       | 220pF    | 25V  | CH   | GRM36CH221J25PT    | K22148203 |          | 1-   | B    | b3      |
| C 1084 | CHIP CAP.       | 100pF    | 50V  | CH   | GRM1552C1H101JD01D | K22178236 |          | 1-   | A    | A5      |
| C 1086 | CHIP CAP.       | 100pF    | 50V  | CH   | GRM1552C1H101JD01D | K22178236 |          | 1-   | A    | C5      |
| C 1087 | CHIP CAP.       | 0.0015uF | 50V  | B    | GRM155B11H152KA01D | K22178811 |          | 1-   | A    | E5      |
| C 1087 | CHIP CAP.       | 0.0056uF | 25V  | B    | GRM36B562K25PT     | K22148802 |          | 3-   | A    | E5      |
| C 1087 | CHIP CAP.       | 0.0068uF | 25V  | B    | GRM36B682K25PT     | K22148803 |          | 5-10 | A    | E5      |
| C 1087 | CHIP CAP.       | 0.0082uF | 16V  | B    | GRM36B822K16PT     | K22128801 | CHINA    | 11-  | A    | E5      |
| C 1087 | CHIP CAP.       | 0.0068uF | 25V  | B    | GRM36B682K25PT     | K22148803 | EUROPE   | 11-  | A    | E5      |
| C 1087 | CHIP CAP.       | 0.0068uF | 25V  | B    | GRM36B682K25PT     | K22148803 | EXPORT   | 11-  | A    | E5      |
| C 1087 | CHIP CAP.       | 0.0068uF | 25V  | B    | GRM36B682K25PT     | K22148803 | VTX(USA) | 11-  | A    | E5      |
| C 1088 | CHIP CAP.       | 100pF    | 50V  | CH   | GRM1552C1H101JD01D | K22178236 |          | 1-   | A    | A5      |
| C 1089 | CHIP CAP.       | 0.001uF  | 50V  | B    | GRM155B11H102KA01D | K22178809 |          | 1-   | B    | b3      |
| C 1090 | CHIP CAP.       | 0.001uF  | 50V  | B    | GRM155B11H102KA01D | K22178809 |          | 1-   | B    | f2      |
| C 1091 | CHIP CAP.       | 100pF    | 50V  | CH   | GRM1552C1H101JD01D | K22178236 |          | 1-   | A    | C5      |
| C 1092 | CHIP CAP.       | 0.001uF  | 50V  | B    | GRM155B11H102KA01D | K22178809 |          | 1-   | B    | f2      |
| C 1093 | CHIP CAP.       | 0.001uF  | 50V  | B    | GRM155B11H102KA01D | K22178809 |          | 1-   | B    | b3      |
| C 1095 | CHIP CAP.       | 22pF     | 50V  | CH   | GRM1552C1H220JZ01D | K22178220 |          | 1-   | B    | b3      |
| C 1096 | CHIP CAP.       | 0.1uF    | 10V  | B    | GRM36B104K10PT     | K22108802 |          | 1-   | A    | G5      |
| C 1097 | CHIP CAP.       | 0.0047uF | 25V  | B    | GRM36B472K25PT     | K22148830 |          | 1-   | A    | G5      |
| C 1098 | CHIP CAP.       | 100pF    | 50V  | CH   | GRM1552C1H101JD01D | K22178236 |          | 1-   | A    | C5      |
| C 1099 | CHIP CAP.       | 1uF      | 10V  | B    | ECJ1VB1A105K       | K22104806 |          | 1-   | B    | f2      |
| C 1100 | CHIP CAP.       | 0.022uF  | 16V  | B    | GRM36B223K16PT     | K22128806 |          | 1-   | A    | G5      |
| C 1102 | CHIP CAP.       | 100pF    | 50V  | CH   | GRM1552C1H101JD01D | K22178236 |          | 1-   | A    | C5      |
| C 1103 | CHIP CAP.       | 33pF     | 50V  | CH   | GRM1552C1H330JZ01D | K22178224 |          | 1-   | B    | b3      |
| C 1104 | CHIP CAP.       | 47pF     | 50V  | CH   | GRM1552C1H470JZ01D | K22178228 |          | 1-   | B    | f2      |
| C 1105 | CHIP CAP.       | 100pF    | 50V  | CH   | GRM1552C1H101JD01D | K22178236 |          | 1-   | A    | B5      |
| C 1106 | CHIP CAP.       | 0.1uF    | 10V  | B    | GRM36B104K10PT     | K22108802 |          | 1-   | A    | E5      |
| C 1107 | CHIP CAP.       | 100pF    | 50V  | CH   | GRM1552C1H101JD01D | K22178236 |          | 1-   | A    | B5      |
| C 1108 | CHIP CAP.       | 0.001uF  | 50V  | B    | GRM155B11H102KA01D | K22178809 |          | 1-   | B    | f2      |
| C 1109 | CHIP CAP.       | 0.0022uF | 50V  | B    | GRM155B11H222KA01D | K22178813 |          | 1-   | A    | J2      |
| C 1110 | CHIP CAP.       | 0.1uF    | 10V  | B    | GRM36B104K10PT     | K22108802 |          | 1-   | A    | F4      |
| C 1111 | CHIP CAP.       | 33pF     | 50V  | CH   | GRM1552C1H330JZ01D | K22178224 |          | 1-   | B    | b3      |
| C 1112 | CHIP CAP.       | 8pF      | 50V  | CH   | GRM1552C1H8R0BZ01D | K22178295 |          | 1-   | B    | b3      |
| C 1113 | CHIP CAP.       | 0.01uF   | 16V  | B    | GRM36B103K16PT     | K22128804 |          | 1-   | B    | f2      |
| C 1114 | CHIP CAP.       | 10uF     | 6.3V | B    | JMK212BJ106KG-T    | K22080802 |          | 1-   | A    | F4      |
| C 1116 | CHIP CAP.       | 7pF      | 50V  | CH   | GRM1552C1H7R0BZ01D | K22178294 |          | 1-   | B    | b3      |
| C 1117 | CHIP CAP.       | 0.0022uF | 50V  | B    | GRM155B11H222KA01D | K22178813 |          | 1-   | A    | J2      |
| C 1118 | CHIP CAP.       | 0.01uF   | 16V  | B    | GRM36B103K16PT     | K22128804 |          | 1-   | A    | J2      |
| C 1120 | CHIP CAP.       | 0.01uF   | 16V  | B    | GRM36B103K16PT     | K22128804 |          | 1-   | A    | F4      |
| C 1121 | CHIP CAP.       | 0.047uF  | 10V  | B    | GRM36B473K10PT     | K22108801 |          | 1-   | A    | J2      |
| C 1122 | CHIP CAP.       | 1pF      | 50V  | CK   | GRM1554C1H1R0CZ01D | K22178202 |          | 1-   | B    | c3      |
| C 1123 | CHIP CAP.       | 1.5pF    | 50V  | CK   | GRM1554C1H1R5CZ01D | K22178203 |          | 1-   | B    | c3      |
| C 1124 | CHIP CAP.       | 0.001uF  | 50V  | B    | GRM155B11H102KA01D | K22178809 |          | 1-   | A    | F4      |
| C 1125 | CHIP CAP.       | 0.01uF   | 16V  | B    | GRM36B103K16PT     | K22128804 |          | 1-   | A    | G5      |



# MAIN Unit

## Parts List

| REF    | DESCRIPTION  | VALUE    | V/W | TOL. | MFR'S DESIG        | VXSTD P/N | VERS.    | LOT  | SIDE | LAY ADR |
|--------|--------------|----------|-----|------|--------------------|-----------|----------|------|------|---------|
| C 1127 | CHIP CAP.    | 8pF      | 50V | CH   | GRM1552C1H8R0BZ01D | K22178295 |          | 1-   | B    | c3      |
| C 1128 | CHIP CAP.    | 7pF      | 50V | CH   | GRM1552C1H7R0BZ01D | K22178294 |          | 1-   | B    | c3      |
| C 1129 | CHIP CAP.    | 33pF     | 50V | CH   | GRM1552C1H330JZ01D | K22178224 |          | 1-   | B    | e2      |
| C 1130 | CHIP CAP.    | 33pF     | 50V | CH   | GRM1552C1H330JZ01D | K22178224 |          | 1-   | B    | c3      |
| C 1131 | CHIP CAP.    | 0.1uF    | 10V | B    | GRM36B104K10PT     | K22108802 |          | 1-   | A    | F3      |
| C 1132 | CHIP CAP.    | 0.01uF   | 16V | B    | GRM36B103K16PT     | K22128804 |          | 1-   | A    | I4      |
| C 1133 | CHIP CAP.    | 0.001uF  | 50V | B    | GRM155B11H102KA01D | K22178809 |          | 1-   | B    | f2      |
| C 1134 | CHIP CAP.    | 33pF     | 50V | CH   | GRM1552C1H330JZ01D | K22178224 |          | 1-   | B    | c3      |
| C 1136 | CHIP CAP.    | 2.2uF    | 10V | B    | GRM21BB11A225KA01L | K22100804 |          | 1-   | A    | F5      |
| C 1138 | CHIP CAP.    | 0.01uF   | 16V | B    | GRM36B103K16PT     | K22128804 |          | 1-   | B    | e2      |
| C 1139 | CHIP CAP.    | 0.001uF  | 50V | B    | GRM155B11H102KA01D | K22178809 |          | 1-   | B    | e2      |
| C 1140 | CHIP CAP.    | 0.1uF    | 10V | B    | GRM36B104K10PT     | K22108802 |          | 1-   | B    | j5      |
| C 1141 | CHIP CAP.    | 22pF     | 50V | CH   | GRM1552C1H220JZ01D | K22178220 |          | 1-   | B    | c3      |
| C 1143 | CHIP CAP.    | 0.1uF    | 10V | B    | GRM36B104K10PT     | K22108802 |          | 1-   | A    | G4      |
| C 1144 | CHIP CAP.    | 0.01uF   | 16V | B    | GRM36B103K16PT     | K22128804 |          | 1-   | A    | I5      |
| C 1145 | CHIP CAP.    | 0.022uF  | 16V | B    | GRM36B223K16PT     | K22128806 |          | 1-   | A    | F5      |
| C 1146 | CHIP CAP.    | 0.001uF  | 50V | B    | GRM155B11H102KA01D | K22178809 |          | 1-   | B    | c3      |
| C 1147 | CHIP CAP.    | 7pF      | 50V | CH   | GRM1552C1H7R0DZ01D | K22178209 |          | 1-   | B    | d3      |
| C 1147 | CHIP CAP.    | 4pF      | 50V | CH   | GRM1552C1H4R0CZ01D | K22178206 |          | 11-  | B    | d3      |
| C 1148 | CHIP CAP.    | 3pF      | 50V | CJ   | GRP1553C1H3R0CZ01E | K22178205 |          | 1-   | B    | e2      |
| C 1149 | CHIP CAP.    | 470pF    | 50V | B    | GRM155B11H471KA01D | K22178805 |          | 1-   | B    | d3      |
| C 1150 | CHIP CAP.    | 10pF     | 50V | CH   | GRM1552C1H100JZ01D | K22178212 |          | 1-   | B    | e3      |
| C 1151 | CHIP CAP.    | 0.022uF  | 50V | B    | GRM40B223M50PT     | K22170821 |          | 1-   | A    | F4      |
| C 1152 | CHIP CAP.    | 10pF     | 50V | CH   | GRM1552C1H100JZ01D | K22178212 |          | 1-   | B    | e3      |
| C 1153 | CHIP CAP.    | 0.001uF  | 50V | B    | GRM155B11H102KA01D | K22178809 |          | 1-   | A    | H4      |
| C 1154 | CHIP CAP.    | 0.001uF  | 50V | B    | GRM155B11H102KA01D | K22178809 |          | 1-   | B    | e3      |
| C 1155 | CHIP CAP.    | 0.001uF  | 50V | B    | GRM155B11H102KA01D | K22178809 |          | 1-   | B    | d3      |
| C 1156 | CHIP CAP.    | 0.001uF  | 50V | B    | GRM155B11H102KA01D | K22178809 |          | 1-   | B    | d3      |
| C 1157 | CHIP CAP.    | 0.01uF   | 16V | B    | GRM36B103K16PT     | K22128804 |          | 1-   | B    | e2      |
| C 1158 | CHIP CAP.    | 100pF    | 50V | CH   | GRM1552C1H101JD01D | K22178236 |          | 1-   | A    | H5      |
| C 1159 | CHIP CAP.    | 0.001uF  | 50V | B    | GRM155B11H102KA01D | K22178809 |          | 1-   | B    | e3      |
| C 1160 | CHIP CAP.    | 0.001uF  | 50V | B    | GRM155B11H102KA01D | K22178809 |          | 1-   | A    | H3      |
| C 1163 | CHIP CAP.    | 0.001uF  | 50V | B    | GRM155B11H102KA01D | K22178809 |          | 1-   | B    | e3      |
| C 1164 | CHIP CAP.    | 0.001uF  | 50V | B    | GRM155B11H102KA01D | K22178809 |          | 1-   | A    | H5      |
| C 1165 | CHIP CAP.    | 7pF      | 50V | CH   | GRM1552C1H7R0DZ01D | K22178209 |          | 1-   | A    | H4      |
| C 1166 | CHIP CAP.    | 0.01uF   | 16V | B    | GRM36B103K16PT     | K22128804 |          | 1-   | B    | e3      |
| C 1167 | CHIP CAP.    | 0.001uF  | 50V | B    | GRM155B11H102KA01D | K22178809 |          | 1-   | B    | f3      |
| C 1169 | CHIP CAP.    | 1pF      | 50V | CK   | GRM1554C1H1R0BZ01D | K22178287 |          | 1-   | B    | e3      |
| C 1171 | CHIP CAP.    | 0.001uF  | 50V | B    | GRM155B11H102KA01D | K22178809 |          | 1-   | A    | H4      |
| C 1172 | CHIP CAP.    | 1pF      | 50V | CK   | GRM1554C1H1R0BZ01D | K22178287 |          | 1-   | B    | f3      |
| C 1173 | CHIP CAP.    | 0.1uF    | 10V | B    | GRM36B104K10PT     | K22108802 |          | 1-   | A    | D4      |
| C 1174 | CHIP CAP.    | 0.001uF  | 50V | B    | GRM155B11H102KA01D | K22178809 |          | 1-   | A    | H4      |
| C 1176 | CHIP CAP.    | 0.01uF   | 16V | B    | GRM36B103K16PT     | K22128804 |          | 1-   | B    | f3      |
| C 1177 | CHIP CAP.    | 1pF      | 50V | CK   | GRM1554C1H1R0CZ01D | K22178202 |          | 1-   | A    | H4      |
| C 1178 | CHIP CAP.    | 0.001uF  | 50V | B    | GRM155B11H102KA01D | K22178809 |          | 1-   | B    | f5      |
| C 1179 | CHIP CAP.    | 8pF      | 50V | CH   | GRM1552C1H8R0DZ01D | K22178210 |          | 1-   | A    | H4      |
| C 1180 | CHIP CAP.    | 0.001uF  | 50V | B    | GRM155B11H102KA01D | K22178809 |          | 1-   | B    | f3      |
| C 1181 | CHIP CAP.    | 1.5pF    | 50V | CK   | GRM1554C1H1R5BZ01D | K22178288 |          | 1-   | B    | e3      |
| C 1182 | CHIP CAP.    | 0.1uF    | 10V | B    | GRM36B104K10PT     | K22108802 |          | 1-   | B    | d5      |
| C 1184 | CHIP CAP.    | 15pF     | 50V | CH   | GRM1552C1H150JZ01D | K22178216 |          | 1-   | B    | f3      |
| C 1186 | CHIP TA.CAP. | 10uF     | 10V |      | TEMSVA1A106M-8R    | K78100028 |          | 1-   | B    | f3      |
| C 1187 | CHIP CAP.    | 15pF     | 50V | CH   | GRM1552C1H150JZ01D | K22178216 |          | 1-   | B    | f3      |
| C 1189 | CHIP CAP.    | 0.001uF  | 50V | B    | GRM155B11H102KA01D | K22178809 |          | 1-   | B    | f3      |
| C 1190 | CHIP CAP.    | 0.001uF  | 50V | B    | GRM155B11H102KA01D | K22178809 |          | 1-   | B    | f3      |
| C 1191 | CHIP CAP.    | 27pF     | 50V | CH   | GRM1552C1H270JZ01D | K22178222 |          | 1-   | B    | e3      |
| C 1192 | CHIP CAP.    | 39pF     | 50V | CH   | GRM1552C1H390JZ01D | K22178226 |          | 1-10 | A    | H5      |
| C 1192 | CHIP CAP.    | 27pF     | 50V | CH   | GRM1552C1H270JZ01D | K22178222 | CHINA    | 11-  | A    | H5      |
| C 1192 | CHIP CAP.    | 39pF     | 50V | CH   | GRM1552C1H390JZ01D | K22178226 | EUROPE   | 11-  | A    | H5      |
| C 1192 | CHIP CAP.    | 39pF     | 50V | CH   | GRM1552C1H390JZ01D | K22178226 | EXPORT   | 11-  | A    | H5      |
| C 1192 | CHIP CAP.    | 39pF     | 50V | CH   | GRM1552C1H390JZ01D | K22178226 | VTX(USA) | 11-  | A    | H5      |
| C 1193 | CHIP CAP.    | 10pF     | 50V | CH   | GRM1552C1H100JZ01D | K22178212 |          | 1-   | B    | f3      |
| C 1195 | CHIP CAP.    | 18pF     | 50V | CH   | GRM1552C1H180JZ01D | K22178218 |          | 1-   | B    | e3      |
| C 1196 | CHIP CAP.    | 0.0047uF | 25V | B    | GRM36B472K25PT     | K22148830 |          | 1-   | A    | D5      |
| C 1197 | CHIP CAP.    | 0.1uF    | 10V | B    | GRM36B104K10PT     | K22108802 |          | 1-   | A    | F3      |
| C 1198 | CHIP CAP.    | 39pF     | 50V | CH   | GRM1552C1H390JZ01D | K22178226 |          | 1-   | A    | I4      |
| C 1199 | CHIP CAP.    | 47pF     | 50V | CH   | GRM1552C1H470JZ01D | K22178228 |          | 1-   | B    | e3      |
| C 1200 | CHIP CAP.    | 0.1uF    | 10V | B    | GRM36B104K10PT     | K22108802 |          | 1-   | A    | D5      |
| C 1201 | CHIP CAP.    | 0.1uF    | 10V | B    | GRM36B104K10PT     | K22108802 |          | 1-   | A    | G5      |
| C 1202 | CHIP TA.CAP. | 10uF     | 10V |      | TEMSVA1A106M-8R    | K78100028 |          | 1-   | B    | f3      |
| C 1203 | CHIP CAP.    | 0.001uF  | 50V | B    | GRM155B11H102KA01D | K22178809 |          | 1-   | A    | H5      |
| C 1204 | CHIP CAP.    | 0.1uF    | 10V | B    | GRM36B104K10PT     | K22108802 |          | 1-   | B    | c4      |
| C 1206 | CHIP CAP.    | 0.1uF    | 10V | B    | GRM36B104K10PT     | K22108802 |          | 1-   | A    | G5      |
| C 1208 | CHIP CAP.    | 0.001uF  | 50V | B    | GRM155B11H102KA01D | K22178809 |          | 1-   | B    | f3      |

# MAIN Unit

## Parts List

| REF    | DESCRIPTION     | VALUE    | V/W  | TOL. | MFR'S DESIG          | VXSTD P/N | VERS. | LOT | SIDE | LAY ADR |
|--------|-----------------|----------|------|------|----------------------|-----------|-------|-----|------|---------|
| C 1209 | CHIP CAP.       | 15pF     | 50V  | CH   | GRM1552C1H150JZ01D   | K22178216 |       | 1-  | B    | f4      |
| C 1209 | CHIP CAP.       | 12pF     | 50V  | CH   | GRM1552C1H120JZ01D   | K22178214 |       | 3-  | B    | f4      |
| C 1210 | CHIP TA.CAP.    | 2.2uF    | 6.3V |      | TESVA0J225M1-8R      | K78080009 |       | 1-  | A    | F4      |
| C 1211 | CHIP CAP.       | 82pF     | 50V  | CH   | GRM1552C1H820JD01D   | K22178234 |       | 1-  | B    | f4      |
| C 1212 | CHIP CAP.       | 1uF      | 10V  | B    | ECJ1VB1A105K         | K22104806 |       | 1-  | A    | G5      |
| C 1214 | CHIP CAP.       | 0.001uF  | 50V  | B    | GRM155B11H102KA01D   | K22178809 |       | 1-  | A    | H5      |
| C 1215 | CHIP CAP.       | 10pF     | 50V  | CH   | GRM1552C1H100JZ01D   | K22178212 |       | 1-  | B    | e4      |
| C 1216 | CHIP CAP.       | 0.01uF   | 16V  | B    | GRM36B103K16PT       | K22128804 |       | 1-  | B    | b4      |
| C 1217 | CHIP CAP.       | 0.001uF  | 50V  | B    | GRM155B11H102KA01D   | K22178809 |       | 1-  | B    | f3      |
| C 1218 | CHIP CAP.       | 4.7uF    | 6.3V | B    | JMK212BJ475KG-T      | K22080804 |       | 1-  | A    | E4      |
| C 1220 | CHIP CAP.       | 47pF     | 50V  | CH   | GRM1552C1H470JZ01D   | K22178228 |       | 1-  | B    | e4      |
| C 1221 | CHIP CAP.       | 0.01uF   | 16V  | B    | GRM36B103K16PT       | K22128804 |       | 1-  | A    | E4      |
| C 1223 | CHIP CAP.       | 0.01uF   | 16V  | B    | GRM36B103K16PT       | K22128804 |       | 1-  | A    | G5      |
| C 1224 | CHIP CAP.       | 5pF      | 50V  | CH   | GRM1552C1H5R0CZ01D   | K22178207 |       | 1-  | A    | H5      |
| C 1225 | CHIP CAP.       | 1uF      | 10V  | B    | GRM40B105K10PT(0.85) | K22100803 |       | 1-  | A    | H5      |
| C 1226 | CHIP CAP.       | 33pF     | 50V  | CH   | GRM1552C1H330JZ01D   | K22178224 |       | 1-  | B    | b4      |
| C 1227 | CHIP TA.CAP.    | 4.7uF    | 6.3V |      | TEMSVA0J475M-8R      | K78080017 |       | 1-  | A    | E3      |
| C 1227 | CHIP TA.CAP.    | 10uF     | 10V  |      | TEMSVA1A106M-8R      | K78100028 |       | 7-  | A    | E3      |
| C 1229 | CHIP CAP.       | 0.0022uF | 50V  | B    | GRM155B11H222KA01D   | K22178813 |       | 1-  | A    | G5      |
| C 1230 | CHIP CAP.       | 0.01uF   | 16V  | B    | GRM36B103K16PT       | K22128804 |       | 1-  | B    | b4      |
| C 1231 | CHIP CAP.       | 0.047uF  | 10V  | B    | GRM36B473K10PT       | K22108801 |       | 1-4 | A    | F4      |
| C 1232 | CHIP CAP.       | 0.001uF  | 50V  | B    | GRM155B11H102KA01D   | K22178809 |       | 1-  | A    | H5      |
| C 1233 | CHIP TA.CAP.    | 4.7uF    | 16V  |      | TEMSVA1C475M-8R      | K78120031 |       | 1-  | A    | E4      |
| C 1234 | CHIP CAP.       | 0.047uF  | 10V  | B    | GRM36B473K10PT       | K22108801 |       | 1-  | B    | b4      |
| C 1235 | CHIP CAP.       | 0.01uF   | 16V  | B    | GRM36B103K16PT       | K22128804 |       | 1-  | A    | G5      |
| C 1236 | CHIP CAP.       | 0.001uF  | 50V  | B    | GRM155B11H102KA01D   | K22178809 |       | 1-  | A    | E4      |
| C 1237 | CHIP CAP.       | 0.022uF  | 16V  | B    | GRM36B223K16PT       | K22128806 |       | 1-  | A    | I5      |
| C 1239 | CHIP CAP.       | 0.01uF   | 16V  | B    | GRM36B103K16PT       | K22128804 |       | 1-  | B    | b4      |
| C 1240 | CHIP CAP.       | 39pF     | 50V  | CH   | GRM1552C1H390JZ01D   | K22178226 |       | 1-  | B    | b4      |
| C 1241 | CHIP CAP.       | 0.0047uF | 25V  | B    | GRM36B472K25PT       | K22148830 |       | 1-  | A    | I5      |
| C 1242 | CHIP CAP.       | 0.0047uF | 25V  | B    | GRM36B472K25PT       | K22148830 |       | 1-  | A    | H5      |
| C 1242 | CHIP CAP.       | 0.0022uF | 50V  | B    | GRM155B11H222KA01D   | K22178813 |       | 5-  | A    | H5      |
| C 1243 | CHIP CAP.       | 0.047uF  | 10V  | B    | GRM36B473K10PT       | K22108801 |       | 1-4 | B    | e4      |
| C 1244 | CHIP CAP.       | 12pF     | 50V  | CH   | GRM1552C1H120JZ01D   | K22178214 |       | 1-  | B    | e3      |
| C 1245 | CHIP CAP.       | 12pF     | 50V  | CH   | GRM1552C1H120JZ01D   | K22178214 |       | 1-  | B    | d3      |
| C 1246 | CHIP CAP.       | 0.01uF   | 16V  | B    | GRM36B103K16PT       | K22128804 |       | 1-  | B    | b4      |
| C 1247 | CHIP CAP.       | 0.01uF   | 16V  | B    | GRM36B103K16PT       | K22128804 |       | 1-  | A    | G5      |
| C 1248 | CHIP CAP.       | 22pF     | 50V  | CH   | GRM1552C1H220JZ01D   | K22178220 |       | 1-  | B    | b4      |
| C 1249 | CHIP CAP.       | 0.0047uF | 25V  | B    | GRM36B472K25PT       | K22148830 |       | 1-  | A    | G5      |
| C 1250 | CHIP CAP.       | 0.1uF    | 10V  | B    | GRM36B104K10PT       | K22108802 |       | 1-  | B    | b4      |
| C 1251 | CHIP CAP.       | 82pF     | 50V  | CH   | GRM1552C1H820JD01D   | K22178234 |       | 1-  | B    | b4      |
| C 1252 | CHIP CAP.       | 0.1uF    | 10V  | B    | GRM36B104K10PT       | K22108802 |       | 1-  | B    | b4      |
| C 1253 | CHIP CAP.       | 0.01uF   | 16V  | B    | GRM36B103K16PT       | K22128804 |       | 1-  | B    | e4      |
| C 1254 | CHIP CAP.       | 27pF     | 50V  | CH   | GRM1552C1H270JZ01D   | K22178222 |       | 1-  | B    | e3      |
| C 1255 | CHIP CAP.       | 22pF     | 50V  | CH   | GRM1552C1H220JZ01D   | K22178220 |       | 1-  | B    | d3      |
| C 1256 | CHIP TA.CAP.    | 0.68uF   | 20V  |      | TESVA1D684M1-8R      | K78130009 |       | 1-  | B    | d4      |
| C 1257 | CHIP CAP.       | 22pF     | 50V  | CH   | GRM1552C1H220JZ01D   | K22178220 |       | 1-  | B    | e3      |
| C 1258 | CHIP CAP.       | 12pF     | 50V  | CH   | GRM1552C1H120JZ01D   | K22178214 |       | 1-  | B    | d3      |
| C 1259 | CHIP CAP.       | 180pF    | 25V  | CH   | GRM36CH181J25PT      | K22148201 |       | 1-  | A    | I5      |
| C 1260 | CHIP CAP.       | 0.001uF  | 50V  | B    | GRM155B11H102KA01D   | K22178809 |       | 1-  | A    | D3      |
| C 1261 | CHIP CAP.       | 0.0033uF | 50V  | B    | GRM155B11H332KA01D   | K22178815 |       | 1-  | A    | J5      |
| C 1262 | CHIP TA.CAP.    | 0.15uF   | 35V  |      | TESVA1V154M1-8R      | K78160026 |       | 1-  | B    | d4      |
| C 1263 | CHIP CAP.       | 0.0047uF | 25V  | B    | GRM36B472K25PT       | K22148830 |       | 1-  | B    | b4      |
| C 1264 | CHIP TA.CAP.    | 4.7uF    | 16V  |      | TEMSVA1C475M-8R      | K78120031 |       | 1-  | A    | D3      |
| C 1264 | CHIP TA.CAP.    | 4.7uF    | 20V  |      | TEMSVA1D475M-8R      | K78130048 |       | 7-  | A    | D3      |
| C 1265 | CHIP TA.CAP.    | 10uF     | 10V  |      | TEMSVA1A106M-8R      | K78100028 |       | 1-  | B    | b5      |
| C 1266 | CHIP CAP.       | 0.1uF    | 10V  | B    | GRM36B104K10PT       | K22108802 |       | 1-  | A    | J5      |
| C 1267 | AL.ELECTRO.CAP. | 100uF    | 25V  |      | EEE1EA101UP          | K48140018 |       | 1-  | B    | h2      |
| C 1268 | CHIP CAP.       | 470pF    | 50V  | B    | GRM155B11H471KA01D   | K22178805 |       | 1-  | B    | c4      |
| C 1268 | CHIP CAP.       | 0.001uF  | 50V  | B    | GRM155B11H102KA01D   | K22178809 |       | 5-  | B    | c4      |
| C 1269 | CHIP CAP.       | 0.001uF  | 50V  | B    | GRM155B11H102KA01D   | K22178809 |       | 1-  | B    | e4      |
| C 1270 | CHIP CAP.       | 0.01uF   | 16V  | B    | GRM36B103K16PT       | K22128804 |       | 1-  | B    | b4      |
| C 1271 | CHIP CAP.       | 0.001uF  | 50V  | B    | GRM155B11H102KA01D   | K22178809 |       | 1-  | B    | d4      |
| C 1272 | CHIP CAP.       | 4.7uF    | 6.3V | B    | JMK212BJ475KG-T      | K22080804 |       | 1-  | A    | F3      |
| C 1273 | CHIP CAP.       | 0.01uF   | 16V  | B    | GRM36B103K16PT       | K22128804 |       | 1-  | B    | j4      |
| C 1274 | CHIP CAP.       | 0.001uF  | 50V  | B    | GRM155B11H102KA01D   | K22178809 |       | 1-  | B    | i4      |
| C 1275 | CHIP CAP.       | 100pF    | 50V  | CH   | GRM1552C1H101JD01D   | K22178236 |       | 1-  | A    | I5      |
| C 1276 | CHIP CAP.       | 470pF    | 50V  | B    | GRM155B11H471KA01D   | K22178805 |       | 1-  | B    | b4      |
| C 1276 | CHIP CAP.       | 0.001uF  | 50V  | B    | GRM155B11H102KA01D   | K22178809 |       | 5-  | B    | b4      |
| C 1277 | CHIP CAP.       | 0.1uF    | 10V  | B    | GRM36B104K10PT       | K22108802 |       | 1-  | B    | d4      |
| C 1278 | CHIP CAP.       | 0.1uF    | 10V  | B    | GRM36B104K10PT       | K22108802 |       | 1-  | A    | I4      |
| C 1279 | CHIP CAP.       | 0.001uF  | 50V  | B    | GRM155B11H102KA01D   | K22178809 |       | 1-  | B    | d4      |
| C 1280 | CHIP CAP.       | 0.1uF    | 10V  | B    | GRM36B104K10PT       | K22108802 |       | 1-  | B    | j4      |

# MAIN Unit

## Parts List

| REF    | DESCRIPTION  | VALUE    | V/W  | TOL. | MFR'S DESIG        | VXSTD P/N | VERS.    | LOT | SIDE | LAY ADR |
|--------|--------------|----------|------|------|--------------------|-----------|----------|-----|------|---------|
| C 1281 | CHIP CAP.    | 0.01uF   | 16V  | B    | GRM36B103K16PT     | K22128804 |          | 1-  | B    | b4      |
| C 1282 | CHIP CAP.    | 0.1uF    | 10V  | B    | GRM36B104K10PT     | K22108802 |          | 1-  | A    | F3      |
| C 1283 | CHIP CAP.    | 0.001uF  | 50V  | B    | GRM155B11H102KA01D | K22178809 |          | 1-  | B    | e4      |
| C 1284 | CHIP CAP.    | 8pF      | 50V  | CH   | GRM1552C1H8R0DZ01D | K22178210 |          | 1-  | A    | B4      |
| C 1286 | CHIP CAP.    | 0.01uF   | 16V  | B    | GRM36B103K16PT     | K22128804 |          | 1-  | B    | i2      |
| C 1287 | CHIP CAP.    | 0.1uF    | 10V  | B    | GRM36B104K10PT     | K22108802 |          | 1-  | B    | d3      |
| C 1288 | CHIP CAP.    | 8pF      | 50V  | CH   | GRM1552C1H8R0DZ01D | K22178210 |          | 1-  | A    | B4      |
| C 1289 | CHIP CAP.    | 0.01uF   | 16V  | B    | GRM36B103K16PT     | K22128804 |          | 1-  | B    | j4      |
| C 1290 | CHIP CAP.    | 0.01uF   | 16V  | B    | GRM36B103K16PT     | K22128804 |          | 1-  | A    | D3      |
| C 1291 | CHIP CAP.    | 0.01uF   | 16V  | B    | GRM36B103K16PT     | K22128804 |          | 1-  | A    | D3      |
| C 1292 | CHIP CAP.    | 0.1uF    | 10V  | B    | GRM36B104K10PT     | K22108802 |          | 1-  | A    | I5      |
| C 1293 | CHIP CAP.    | 0.1uF    | 10V  | B    | GRM36B104K10PT     | K22108802 |          | 1-  | B    | a4      |
| C 1294 | CHIP CAP.    | 0.001uF  | 50V  | B    | GRM155B11H102KA01D | K22178809 |          | 1-  | A    | D3      |
| C 1295 | CHIP CAP.    | 0.001uF  | 50V  | B    | GRM155B11H102KA01D | K22178809 |          | 1-  | B    | j4      |
| C 1296 | CHIP CAP.    | 1uF      | 10V  | B    | ECJ1VB1A105K       | K22104806 |          | 1-  | A    | I5      |
| C 1297 | CHIP CAP.    | 0.01uF   | 16V  | B    | GRM36B103K16PT     | K22128804 |          | 1-  | B    | i2      |
| C 1298 | CHIP CAP.    | 4.7uF    | 6.3V | B    | JMK212BJ475KG-T    | K22080804 |          | 1-  | A    | D3      |
| C 1299 | CHIP CAP.    | 0.001uF  | 50V  | B    | GRM155B11H102KA01D | K22178809 |          | 1-  | B    | i4      |
| C 1300 | CHIP CAP.    | 0.001uF  | 50V  | B    | GRM155B11H102KA01D | K22178809 |          | 1-  | B    | d4      |
| C 1301 | CHIP CAP.    | 0.1uF    | 10V  | B    | GRM36B104K10PT     | K22108802 |          | 1-  | B    | b5      |
| C 1302 | CHIP CAP.    | 0.1uF    | 10V  | B    | GRM36B104K10PT     | K22108802 |          | 1-  | B    | d4      |
| C 1303 | CHIP CAP.    | 0.01uF   | 16V  | B    | GRM36B103K16PT     | K22128804 |          | 1-  | B    | j5      |
| C 1304 | CHIP CAP.    | 0.001uF  | 50V  | B    | GRM155B11H102KA01D | K22178809 |          | 1-  | A    | B5      |
| C 1305 | CHIP CAP.    | 470pF    | 50V  | B    | GRM155B11H471KA01D | K22178805 |          | 1-  | B    | b5      |
| C 1305 | CHIP CAP.    | 820pF    | 50V  | B    | GRM36B821K50PT     | K22178808 |          | 5-  | B    | b5      |
| C 1306 | CHIP CAP.    | 0.0047uF | 25V  | B    | GRM36B472K25PT     | K22148830 |          | 1-  | A    | I5      |
| C 1307 | CHIP TA.CAP. | 10uF     | 10V  |      | TEMSVA1A106M-8R    | K78100028 |          | 1-  | B    | d4      |
| C 1308 | CHIP CAP.    | 0.001uF  | 50V  | B    | GRM155B11H102KA01D | K22178809 |          | 1-  | B    | d4      |
| C 1309 | CHIP CAP.    | 0.01uF   | 16V  | B    | GRM36B103K16PT     | K22128804 |          | 1-  | B    | j5      |
| C 1310 | CHIP CAP.    | 0.1uF    | 10V  | B    | GRM36B104K10PT     | K22108802 |          | 1-  | B    | d4      |
| C 1311 | CHIP CAP.    | 0.1uF    | 10V  | B    | GRM36B104K10PT     | K22108802 |          | 1-  | A    | B5      |
| C 1312 | CHIP CAP.    | 470pF    | 50V  | B    | GRM155B11H471KA01D | K22178805 |          | 1-  | B    | b5      |
| C 1312 | CHIP CAP.    | 820pF    | 50V  | B    | GRM36B821K50PT     | K22178808 |          | 5-  | B    | b5      |
| C 1313 | CHIP CAP.    | 0.01uF   | 16V  | B    | GRM36B103K16PT     | K22128804 |          | 1-  | B    | j2      |
| C 1314 | CHIP CAP.    | 0.01uF   | 16V  | B    | GRM36B103K16PT     | K22128804 |          | 1-  | A    | J4      |
| C 1315 | CHIP CAP.    | 0.047uF  | 10V  | B    | GRM36B473K10PT     | K22108801 |          | 1-  | B    | d4      |
| C 1316 | CHIP CAP.    | 0.1uF    | 10V  | B    | GRM36B104K10PT     | K22108802 |          | 1-  | B    | a4      |
| C 1317 | CHIP CAP.    | 0.01uF   | 16V  | B    | GRM36B103K16PT     | K22128804 |          | 1-  | B    | j2      |
| C 1319 | CHIP TA.CAP. | 4.7uF    | 16V  |      | TEMSVA1C475M-8R    | K78120031 |          | 1-  | B    | c5      |
| C 1321 | CHIP CAP.    | 0.001uF  | 50V  | B    | GRM155B11H102KA01D | K22178809 |          | 1-  | B    | b5      |
| C 1323 | CHIP CAP.    | 100pF    | 50V  | CH   | GRM1552C1H101JD01D | K22178236 |          | 1-  | B    | i2      |
| C 1324 | CHIP CAP.    | 0.0015uF | 50V  | B    | GRM155B11H152KA01D | K22178811 |          | 1-  | B    | b5      |
| C 1326 | CHIP CAP.    | 0.01uF   | 16V  | B    | GRM36B103K16PT     | K22128804 |          | 1-  | B    | b5      |
| C 1327 | CHIP CAP.    | 0.1uF    | 10V  | B    | GRM36B104K10PT     | K22108802 | CHINA    | 9-  | B    | f5      |
| C 1327 | CHIP CAP.    | 0.1uF    | 10V  | B    | GRM36B104K10PT     | K22108802 | VTX(USA) | 9-  | B    | f5      |
| C 1328 | CHIP CAP.    | 22pF     | 50V  | CH   | GRM1552C1H220JZ01D | K22178220 | CHINA    | 9-  | B    | f5      |
| C 1328 | CHIP CAP.    | 22pF     | 50V  | CH   | GRM1552C1H220JZ01D | K22178220 | VTX(USA) | 9-  | B    | f5      |
| C 1329 | CHIP CAP.    | 0.01uF   | 16V  | B    | GRM36B103K16PT     | K22128804 |          | 1-  | B    | b5      |
| C 1330 | CHIP CAP.    | 100pF    | 50V  | CH   | GRM1552C1H101JD01D | K22178236 |          | 1-  | A    | B2      |
| C 1331 | CHIP CAP.    | 100pF    | 50V  | CH   | GRM1552C1H101JD01D | K22178236 |          | 1-  | B    | i1      |
| C 1333 | CHIP CAP.    | 22pF     | 50V  | CH   | GRM1552C1H220JZ01D | K22178220 | CHINA    | 9-  | B    | g5      |
| C 1333 | CHIP CAP.    | 22pF     | 50V  | CH   | GRM1552C1H220JZ01D | K22178220 | VTX(USA) | 9-  | B    | g5      |
| C 1335 | CHIP CAP.    | 100pF    | 50V  | CH   | GRM1552C1H101JD01D | K22178236 |          | 1-  | B    | j1      |
| C 1337 | CHIP CAP.    | 0.1uF    | 10V  | B    | GRM36B104K10PT     | K22108802 |          | 1-  | A    | C3      |
| C 1341 | CHIP CAP.    | 0.022uF  | 16V  | B    | GRM36B223K16PT     | K22128806 |          | 1-  | A    | G5      |
| C 1342 | CHIP CAP.    | 4.7uF    | 6.3V | B    | JMK212BJ475KG-T    | K22080804 |          | 1-  | A    | C5      |
| C 1343 | CHIP CAP.    | 0.01uF   | 16V  | B    | GRM36B103K16PT     | K22128804 | CHINA    | 9-  | B    | f4      |
| C 1343 | CHIP CAP.    | 0.01uF   | 16V  | B    | GRM36B103K16PT     | K22128804 | VTX(USA) | 9-  | B    | f4      |
| C 1344 | CHIP CAP.    | 0.022uF  | 16V  | B    | GRM36B223K16PT     | K22128806 | CHINA    | 9-  | B    | f5      |
| C 1344 | CHIP CAP.    | 0.022uF  | 16V  | B    | GRM36B223K16PT     | K22128806 | VTX(USA) | 9-  | B    | f5      |
| C 1345 | CHIP CAP.    | 0.01uF   | 16V  | B    | GRM36B103K16PT     | K22128804 |          | 1-  | A    | B4      |
| C 1350 | CHIP CAP.    | 100pF    | 50V  | CH   | GRM1882C1H101JA01D | K22174235 |          | 1-  | A    | A5      |
| C 1350 | CHIP CAP.    | 100pF    | 50V  | CH   | GRM1552C1H101JD01D | K22178236 |          | 5-  | A    | A5      |
| C 1351 | CHIP CAP.    | 0.001uF  | 50V  | B    | GRM155B11H102KA01D | K22178809 |          | 5-  | A    | G5      |
| C 1352 | CHIP CAP.    | 0.1uF    | 10V  | B    | GRM36B104K10PT     | K22108802 |          | 5-  | A    | G5      |
| C 1353 | CHIP CAP.    | 4.7uF    | 6.3V | B    | JMK212BJ475KG-T    | K22080804 |          | 5-  | B    | d5      |
| C 1354 | CHIP CAP.    | 0.01uF   | 16V  | B    | GRM36B103K16PT     | K22128804 |          | 5-  | B    | d5      |
| C 1355 | CHIP TA.CAP. | 0.1uF    | 35V  |      | TESVA1V104M1-8R    | K78160025 |          | 5-  | A    | F4      |
| C 1356 | CHIP CAP.    | 0.1uF    | 10V  | B    | GRM36B104K10PT     | K22108802 |          | 5-  | A    | H5      |
| C 1357 | CHIP TA.CAP. | 3.3uF    | 6.3V |      | TESVA0J335M1-8R    | K78080021 | W/ CE    | 9-  | A    | J2      |
| C 1358 | CHIP CAP.    | 3.3pF    | 500V |      | 1206N3R3C501LT     | K22278203 | W/ CE    | 9-  |      |         |
| C 1359 | CHIP CAP.    | 47pF     | 50V  | CH   | GRM1882C1H470JA01D | K22174227 | W/ CE    | 9-  |      |         |
| CD1001 | CERAMIC DISC |          |      |      | JTBC450C7          | H7901500  |          | 1-  | B    | b5      |

# MAIN Unit

## Parts List

| REF    | DESCRIPTION    | VALUE | V/W   | TOL. | MFR'S DESIG     | VXSTD P/N | VERS.    | LOT | SIDE | LAY ADR |
|--------|----------------|-------|-------|------|-----------------|-----------|----------|-----|------|---------|
| CF1001 | CERAMIC FILTER |       |       |      | LTM450EW        | H3900574  |          | 1-  | A    | J4      |
| CF1002 | CERAMIC FILTER |       |       |      | LTM450GW        | H3900573  |          | 1-  | A    | J4      |
| D 1001 | DIODE          |       |       |      | RLS135 TE-11    | G2070128  |          | 1-  | B    | b2      |
| D 1002 | SURGE ABSORBER |       |       |      | P6KE27-MT25     | Q9000854  |          | 1-  | A    | C1      |
| D 1003 | DIODE          |       |       |      | 1SV323(TPH3.F)  | G2071006  |          | 1-  | B    | a3      |
| D 1004 | DIODE          |       |       |      | 1SV323(TPH3.F)  | G2071006  |          | 1-  | B    | a3      |
| D 1005 | DIODE          |       |       |      | 1SV323(TPH3.F)  | G2071006  |          | 1-  | B    | a3      |
| D 1006 | DIODE          |       |       |      | 1SV323(TPH3.F)  | G2071006  |          | 1-  | B    | a3      |
| D 1007 | DIODE          |       |       |      | HSM88AS TR      | G2070170  |          | 1-  | A    | H2      |
| D 1008 | DIODE          |       |       |      | HSM88AS TR      | G2070170  |          | 1-  | A    | I2      |
| D 1009 | DIODE          |       |       |      | MA2S111-(TX)    | G2070614  |          | 1-  | B    | b3      |
| D 1011 | DIODE          |       |       |      | MA2S111-(TX)    | G2070614  |          | 1-  | A    | J2      |
| D 1012 | DIODE          |       |       |      | MA2S111-(TX)    | G2070614  |          | 1-  | A    | F3      |
| D 1013 | DIODE          |       |       |      | MAZ816000L      | G2071120  |          | 1-  | A    | B5      |
| D 1014 | DIODE          |       |       |      | UDZS TE-17 6.8B | G2070888  |          | 1-  | A    | B5      |
| D 1015 | DIODE          |       |       |      | MAZ816000L      | G2071120  |          | 1-  | A    | A5      |
| D 1016 | DIODE          |       |       |      | MA2S111-(TX)    | G2070614  |          | 1-  | A    | J2      |
| D 1017 | DIODE          |       |       |      | UDZS TE-17 6.8B | G2070888  |          | 1-  | A    | B5      |
| D 1018 | DIODE          |       |       |      | MA2S111-(TX)    | G2070614  |          | 1-  | A    | J2      |
| D 1019 | DIODE          |       |       |      | MA2S111-(TX)    | G2070614  |          | 1-  | B    | i5      |
| D 1020 | DIODE          |       |       |      | DAN222 TL       | G2070174  |          | 1-  | B    | e2      |
| D 1021 | DIODE          |       |       |      | MC2850-T11-1    | G2070704  |          | 1-  | B    | i4      |
| D 1022 | DIODE          |       |       |      | MA2S111-(TX)    | G2070614  |          | 1-  | B    | i5      |
| D 1023 | DIODE          |       |       |      | HVC383B TRF-E   | G2070922  |          | 1-  | B    | e3      |
| D 1024 | DIODE          |       |       |      | MA2S111-(TX)    | G2070614  |          | 1-  | B    | f3      |
| D 1025 | DIODE          |       |       |      | 1SV325(TPH3.F)  | G2070848  |          | 1-  | B    | f4      |
| D 1026 | DIODE          |       |       |      | HVC376B TRF-E   | G2071122  |          | 1-  | B    | e4      |
| D 1027 | DIODE          |       |       |      | MC2850-T11-1    | G2070704  |          | 1-  | B    | c4      |
| D 1028 | DIODE          |       |       |      | 1SV325(TPH3.F)  | G2070848  |          | 1-  | B    | f4      |
| D 1029 | DIODE          |       |       |      | 1SV325(TPH3.F)  | G2070848  |          | 1-  | B    | f4      |
| D 1030 | DIODE          |       |       |      | 1SV325(TPH3.F)  | G2070848  |          | 1-  | B    | e4      |
| D 1031 | DIODE          |       |       |      | 1SV325(TPH3.F)  | G2070848  |          | 1-  | B    | f4      |
| D 1032 | DIODE          |       |       |      | 1SV325(TPH3.F)  | G2070848  |          | 1-  | B    | f4      |
| D 1033 | DIODE          |       |       |      | HSC277TRF-E     | G2070584  |          | 1-  | B    | e3      |
| D 1034 | DIODE          |       |       |      | HSC277TRF-E     | G2070584  |          | 1-  | B    | e3      |
| D 1035 | DIODE          |       |       |      | DAN222 TL       | G2070174  |          | 1-  | B    | a4      |
| D 1036 | DIODE          |       |       |      | MA2S111-(TX)    | G2070614  |          | 1-  | A    | D3      |
| D 1037 | DIODE          |       |       |      | HSC277TRF-E     | G2070584  |          | 1-  | B    | e3      |
| D 1038 | DIODE          |       |       |      | HSC277TRF-E     | G2070584  |          | 1-  | B    | e3      |
| D 1039 | DIODE          |       |       |      | DAN222 TL       | G2070174  |          | 1-  | B    | a4      |
| D 1041 | DIODE          |       |       |      | MC2850-T11-1    | G2070704  |          | 1-  | B    | j4      |
| D 1042 | DIODE          |       |       |      | MC2850-T11-1    | G2070704  |          | 1-  | A    | J5      |
| D 1043 | DIODE          |       |       |      | MA2S111-(TX)    | G2070614  |          | 1-  | B    | i4      |
| D 1044 | DIODE          |       |       |      | MA2S111-(TX)    | G2070614  |          | 1-  | B    | j5      |
| D 1045 | DIODE          |       |       |      | MA2S111-(TX)    | G2070614  |          | 1-  | B    | d4      |
| D 1046 | DIODE          |       |       |      | MC2850-T11-1    | G2070704  |          | 1-  | B    | i1      |
| D 1047 | DIODE          |       |       |      | MC2850-T11-1    | G2070704  |          | 1-  | B    | b5      |
| D 1048 | DIODE          |       |       |      | MC2850-T11-1    | G2070704  |          | 1-  | B    | b5      |
| D 1049 | DIODE          |       |       |      | MAZ816000L      | G2071120  |          | 1-  | B    | j1      |
| D 1050 | DIODE          |       |       |      | MAZ816000L      | G2071120  |          | 1-  | A    | A1      |
| D 1051 | DIODE          |       |       |      | MAZ816000L      | G2071120  |          | 1-  | A    | B1      |
| D 1052 | DIODE          |       |       |      | MAZ816000L      | G2071120  |          | 1-  | A    | B1      |
| D 1053 | DIODE          |       |       |      | MC2850-T11-1    | G2070704  |          | 1-  | B    | i1      |
| D 1054 | DIODE          |       |       |      | MC2850-T11-1    | G2070704  |          | 1-  | B    | j1      |
| D 1055 | DIODE          |       |       |      | MAZ816000L      | G2071120  |          | 1-  | A    | B1      |
| D 1056 | DIODE          |       |       |      | MAZ816000L      | G2071120  |          | 1-  | B    | j1      |
| D 1057 | DIODE          |       |       |      | MAZ816000L      | G2071120  |          | 1-  | A    | A1      |
| D 1058 | DIODE          |       |       |      | MAZ816000L      | G2071120  |          | 1-  | A    | B2      |
| D 1059 | DIODE          |       |       |      | MAZ816000L      | G2071120  |          | 1-  | A    | B1      |
| D 1060 | DIODE          |       |       |      | MC2850-T11-1    | G2070704  |          | 1-  | A    | E4      |
| D 1061 | DIODE          |       |       |      | MC2850-T11-1    | G2070704  |          | 1-  | A    | F3      |
| D 1062 | DIODE          |       |       |      | MA2S111-(TX)    | G2070614  | CHINA    | 9-  | B    | f4      |
| D 1062 | DIODE          |       |       |      | MA2S111-(TX)    | G2070614  | VTX(USA) | 9-  | B    | f4      |
| D 1063 | DIODE          |       |       |      | UDZS TE-17 6.8B | G2070888  |          | 9-  | B    | h3      |
| D 1064 | DIODE          |       |       |      | UDZS TE-17 6.8B | G2070888  |          | 9-  | B    | j2      |
| F 1001 | CHIP FUSE      | 0.25A |       |      | 0434.250 0.25A  | Q0000106  |          | 1-  | A    | B2      |
| J 1003 | CONNECTOR      |       |       |      | 18FLT-SM1-TB    | P1091176  |          | 1-  | A    | C5      |
| J 1004 | CONNECTOR      |       |       |      | 657PCB-HIL      | P1091290  |          | 1-  | B    | j6      |
| J 1005 | CONNECTOR      |       |       |      | AXK6S40535P     | P0091209  |          | 1-  | A    | D4      |
| J 1006 | CONNECTOR      |       |       |      | AE0195-00       | P1091177  |          | 1-  | B    | j1      |
| JP1001 | CHIP RES.      | 0     | 1/16W | 5%   | RMC1/16 000JATP | J24185000 |          | 1-  | A    | B1      |
| JP1002 | CHIP RES.      | 0     | 1/16W | 5%   | RMC1/16 000JATP | J24185000 |          | 1-  | A    | A1      |
| JP1003 | CHIP RES.      | 0     | 1/16W | 5%   | RMC1/16 000JATP | J24185000 |          | 1-  | A    | B1      |

# MAIN Unit

## Parts List

| REF    | DESCRIPTION | VALUE   | V/W   | TOL. | MFR'S DESIG     | VXSTD P/N | VERS.    | LOT | SIDE | LAY ADR |
|--------|-------------|---------|-------|------|-----------------|-----------|----------|-----|------|---------|
| JP1004 | CHIP RES.   | 0       | 1/16W | 5%   | RMC1/16 000JATP | J24185000 |          | 1-  | A    | B1      |
| JP1005 | CHIP RES.   | 0       | 1/16W | 5%   | RMC1/16 000JATP | J24185000 |          | 1-  | A    | A1      |
| JP1006 | CHIP RES.   | 0       | 1/16W | 5%   | RMC1/16 000JATP | J24185000 |          | 1-  | A    | B1      |
| L 1001 | COIL        | 0.056uH |       |      | AS050635-56N    | L0022813  |          | 1-  | B    | b2      |
| L 1002 | COIL        | 0.047uH |       |      | AS030821-47NJ   | L0022824  |          | 1-  | B    | b2      |
| L 1003 | COIL        | 0.033uH |       |      | AS1005-33NK     | L0022546  |          | 1-  | B    | a2      |
| L 1004 | COIL        | 0.033uH |       |      | AS1005-33NK     | L0022546  |          | 1-  | B    | b2      |
| L 1005 | COIL        | 0.033uH |       |      | AS1005-33NK     | L0022546  |          | 1-  | B    | b2      |
| L 1006 | CHIP COIL   | 0.068uH |       |      | LQW2BHN68NJ03L  | L1690605  |          | 1-  | B    | a3      |
| L 1007 | COIL        | 0.033uH |       |      | AS1005-33NK     | L0022546  |          | 1-  | B    | b2      |
| L 1008 | COIL        | 0.212uH |       |      | AS051047-212N   | L0022834  |          | 1-  | A    | G2      |
| L 1009 | CHIP COIL   | 0.068uH |       |      | LQW2BHN68NJ03L  | L1690605  |          | 1-  | B    | a3      |
| L 1010 | M.RFC       | 0.22uH  |       |      | HK1608 R22J-T   | L1690940  |          | 1-  | B    | b3      |
| L 1011 | CHIP COIL   | 0.082uH |       |      | LQW2BHN82NJ03L  | L1690619  |          | 1-  | B    | b3      |
| L 1012 | M.RFC       | 0.22uH  |       |      | HK1608 R22J-T   | L1690940  |          | 1-  | B    | f2      |
| L 1013 | CHIP COIL   | 0.082uH |       |      | LQW2BHN82NJ03L  | L1690619  |          | 1-  | B    | c3      |
| L 1014 | CHIP COIL   | 0.082uH |       |      | LQW2BHN82NJ03L  | L1690619  |          | 1-  | B    | c3      |
| L 1015 | CHIP COIL   | 0.082uH |       |      | LQW2BHN82NJ03L  | L1690619  |          | 1-  | B    | c3      |
| L 1016 | M.RFC       | 0.22uH  |       |      | HK1608 R22J-T   | L1690940  |          | 1-  | B    | e2      |
| L 1017 | M.RFC       | 0.082uH |       |      | HK1608 82NJ-T   | L1690527  |          | 1-  | B    | e2      |
| L 1018 | M.RFC       | 0.082uH |       |      | HK1608 82NJ-T   | L1690527  |          | 1-  | B    | c3      |
| L 1019 | M.RFC       | 0.082uH |       |      | HK1608 82NJ-T   | L1690527  |          | 1-  | B    | d3      |
| L 1020 | M.RFC       | 0.047uH |       |      | HK1608 47NJ-T   | L1690524  |          | 1-  | B    | e3      |
| L 1021 | M.RFC       | 1uH     |       |      | LK1608 1R0K-T   | L1690687  |          | 1-  | B    | e2      |
| L 1022 | M.RFC       | 0.82uH  |       |      | LK1608 R82K-T   | L1690417  |          | 1-  | A    | H4      |
| L 1023 | M.RFC       | 0.22uH  |       |      | HK1608 R22J-T   | L1690940  |          | 1-  | B    | e3      |
| L 1024 | M.RFC       | 1uH     |       |      | LK1608 1R0K-T   | L1690687  |          | 1-  | B    | e3      |
| L 1025 | M.RFC       | 0.39uH  |       | 2%   | C1608CB-R39G    | L1691107  |          | 1-  | B    | f3      |
| L 1026 | M.RFC       | 0.39uH  |       | 2%   | C1608CB-R39G    | L1691107  |          | 1-  | B    | f3      |
| L 1027 | CHIP COIL   | 0.047uH |       | 2%   | C2520C-47NG     | L1691290  |          | 1-  | B    | f4      |
| L 1028 | CHIP COIL   | 0.033uH |       | 2%   | C2520C-33NG     | L1691288  |          | 1-  | B    | e4      |
| L 1029 | M.RFC       | 0.39uH  |       |      | LK1608 R39K-T   | L1690413  |          | 1-  | B    | e4      |
| L 1030 | M.RFC       | 1uH     |       |      | LK1608 1R0K-T   | L1690687  |          | 1-  | B    | c4      |
| L 1031 | M.RFC       | 0.22uH  |       |      | HK1608 R22J-T   | L1690940  |          | 1-  | B    | f3      |
| L 1032 | M.RFC       | 0.22uH  |       |      | HK1608 R22J-T   | L1690940  |          | 1-  | B    | f4      |
| L 1033 | M.RFC       | 0.22uH  |       |      | HK1608 R22J-T   | L1690940  |          | 1-  | B    | f4      |
| L 1034 | M.RFC       | 0.22uH  |       |      | HK1608 R22J-T   | L1690940  |          | 1-  | B    | f4      |
| L 1035 | M.RFC       | 0.15uH  |       |      | HK1608 R15J-T   | L1690938  |          | 1-  | B    | b4      |
| L 1036 | M.RFC       | 0.056uH |       |      | HK1608 56NJ-T   | L1690525  |          | 1-  | B    | e3      |
| L 1037 | M.RFC       | 0.047uH |       |      | HK1608 47NJ-T   | L1690524  |          | 1-  | B    | e3      |
| L 1038 | M.RFC       | 0.056uH |       |      | HK1608 56NJ-T   | L1690525  |          | 1-  | B    | e3      |
| L 1039 | M.RFC       | 0.047uH |       |      | HK1608 47NJ-T   | L1690524  |          | 1-  | B    | e3      |
| L 1040 | CHIP COIL   | 10uH    |       |      | LQH32MN100K23L  | L1690087  |          | 1-  | A    | B3      |
| L 1041 | CHIP COIL   | 100uH   |       |      | LQH32MN101K23L  | L1690099  | CHINA    | 9-  | B    | f5      |
| L 1041 | CHIP COIL   | 100uH   |       |      | LQH32MN101K23L  | L1690099  | VTX(USA) | 9-  | B    | f5      |
| Q 1001 | TRANSISTOR  |         |       |      | RT1N441U-T11-1  | G3070247  |          | 1-  | B    | i3      |
| Q 1002 | TRANSISTOR  |         |       |      | RT1N441U-T11-1  | G3070247  |          | 1-  | B    | i3      |
| Q 1003 | IC          |         |       |      | TDA1519CTH      | G1093778  |          | 1-  | B    | j3      |
| Q 1004 | IC          |         |       |      | SN74LV4053APWR  | G1093870  |          | 1-  | A    | D5      |
| Q 1005 | IC          |         |       |      | SN74LV4053APWR  | G1093870  |          | 1-  | A    | F4      |
| Q 1006 | IC          |         |       |      | UA78M08CKTPR    | G1094157  |          | 1-  | A    | C3      |
| Q 1006 | IC          |         |       |      | NJM7808DL1A-TE1 | G1093802  |          | 5-  | A    | C3      |
| Q 1007 | TRANSISTOR  |         |       |      | 2SC3356-T2B R24 | G3333567D |          | 1-  | B    | b3      |
| Q 1008 | FET         |         |       |      | MTM231230L      | G3070357  |          | 1-  | A    | C2      |
| Q 1009 | IC          |         |       |      | S-AV32(VX)      | G1093916  |          | 1-8 | A    | D1      |
| Q 1009 | IC          |         |       |      | S-AV33A(VX.Q)   | G1094415  | 25W      | 9-  | A    | D1      |
| Q 1009 | IC          |         |       |      | S-AV32(VX)      | G1093916  | 50W      | 9-  | A    | D1      |
| Q 1010 | TRANSISTOR  |         |       |      | RT1N140U(TAPE)  | G3070359  |          | 1-  | B    | h2      |
| Q 1011 | FET         |         |       |      | MTM231230L      | G3070357  |          | 1-  | A    | F3      |
| Q 1012 | FET         |         |       |      | MTM231230L      | G3070357  |          | 1-  | A    | F3      |
| Q 1013 | TRANSISTOR  |         |       |      | UMG2N TR        | G3070088  |          | 1-  | A    | F3      |
| Q 1014 | IC          |         |       |      | M62364FP 600D   | G1093033  |          | 1-  | A    | F5      |
| Q 1015 | TRANSISTOR  |         |       |      | 2SC3357-T2 RF   | G3333577F |          | 1-  | B    | f2      |
| Q 1016 | TRANSISTOR  |         |       |      | RT1N441U-T11-1  | G3070247  |          | 1-  | A    | G3      |
| Q 1017 | TRANSISTOR  |         |       |      | RT1N441U-T11-1  | G3070247  |          | 1-  | A    | J2      |
| Q 1018 | TRANSISTOR  |         |       |      | 2SC4617 TL R    | G3346178R |          | 1-  | B    | j5      |
| Q 1019 | TRANSISTOR  |         |       |      | 2SC4617 TL R    | G3346178R |          | 1-  | B    | i5      |
| Q 1020 | TRANSISTOR  |         |       |      | 2SC4617 TL R    | G3346178R |          | 1-  | B    | i5      |
| Q 1021 | TRANSISTOR  |         |       |      | RT1N441U-T11-1  | G3070247  |          | 1-  | B    | i5      |
| Q 1022 | TRANSISTOR  |         |       |      | DTA124EE TL     | G3070116  |          | 1-  | B    | i5      |
| Q 1023 | TRANSISTOR  |         |       |      | 2SC5226-4-TL    | G3352268D |          | 1-  | B    | e2      |
| Q 1024 | TRANSISTOR  |         |       |      | 2SC5226-4-TL    | G3352268D |          | 1-  | B    | e2      |
| Q 1025 | FET         |         |       |      | 3SK293(TE85L,F) | G4802938  |          | 1-  | A    | H3      |

# MAIN Unit

## Parts List

| REF    | DESCRIPTION | VALUE | V/W   | TOL. | MFR'S DESIG          | VXSTD P/N | VERS.    | LOT | SIDE | LAY ADR |
|--------|-------------|-------|-------|------|----------------------|-----------|----------|-----|------|---------|
| Q 1026 | TRANSISTOR  |       |       |      | RT1N441U-T11-1       | G3070247  |          | 1-  | A    | F5      |
| Q 1027 | TRANSISTOR  |       |       |      | 2SC5226-4-TL         | G3352268D |          | 1-  | B    | e3      |
| Q 1028 | TRANSISTOR  |       |       |      | RT1N441U-T11-1       | G3070247  |          | 1-  | B    | f3      |
| Q 1028 | TRANSISTOR  |       |       |      | DTC143EE TL          | G3070114  |          | 7-  | B    | f3      |
| Q 1029 | FET         |       |       |      | 2SK508-T2B K52 A     | G3805087B |          | 1-  | B    | f3      |
| Q 1030 | TRANSISTOR  |       |       |      | RT1N140U(TAPE)       | G3070359  |          | 1-  | B    | f3      |
| Q 1030 | TRANSISTOR  |       |       |      | DTC143EE TL          | G3070114  |          | 7-  | B    | f3      |
| Q 1031 | TRANSISTOR  |       |       |      | 2SC3356-T2B R24      | G3333567D |          | 1-  | B    | e3      |
| Q 1032 | TRANSISTOR  |       |       |      | 2SC4617 TL R         | G3346178R |          | 1-  | B    | f3      |
| Q 1033 | TRANSISTOR  |       |       |      | 2SC5226-4-TL         | G3352268D |          | 1-  | B    | c4      |
| Q 1034 | IC          |       |       |      | BH2220FVM-TR         | G1094269  |          | 1-  | A    | G3      |
| Q 1035 | IC          |       |       |      | TAR5S35(TE85L.F)     | G1093939  |          | 1-  | A    | E4      |
| Q 1036 | IC          |       |       |      | NJM2591V-TE1         | G1094024  |          | 1-  | B    | b4      |
| Q 1037 | FET         |       |       |      | 2SK880GR(TE85R_F)    | G3808807G |          | 1-  | B    | d4      |
| Q 1038 | TRANSISTOR  |       |       |      | XN1501-(TX)          | G3070149  |          | 1-  | A    | F3      |
| Q 1039 | TRANSISTOR  |       |       |      | 2SB1201S-TL          | G3070195  |          | 1-  | A    | E3      |
| Q 1040 | IC          |       |       |      | LM2902PWR            | G1094009  |          | 1-  | A    | H5      |
| Q 1040 | IC          |       |       |      | NJM12902V-TE1        | G1093592  |          | 5-  | A    | H5      |
| Q 1041 | TRANSISTOR  |       |       |      | RT1N441U-T11-1       | G3070247  |          | 1-  | A    | J5      |
| Q 1042 | IC          |       |       |      | LM2902PWR            | G1094009  |          | 1-  | A    | G5      |
| Q 1042 | IC          |       |       |      | NJM12902V-TE1        | G1093592  |          | 5-  | A    | G5      |
| Q 1043 | IC          |       |       |      | LM2902PWR            | G1094009  |          | 1-  | A    | E5      |
| Q 1043 | IC          |       |       |      | NJM12902V-TE1        | G1093592  |          | 5-  | A    | E5      |
| Q 1044 | IC          |       |       |      | SN74LV4066APWR       | G1093871  |          | 1-  | B    | e5      |
| Q 1045 | IC          |       |       |      | LM2902PWR            | G1094009  |          | 1-  | A    | I5      |
| Q 1045 | IC          |       |       |      | NJM12902V-TE1        | G1093592  |          | 5-  | A    | I5      |
| Q 1045 | IC          |       |       |      | LM2902PWR            | G1094009  |          | 7-  | A    | I5      |
| Q 1045 | IC          |       |       |      | NJM12902V-TE1        | G1093592  |          | 9-  | A    | I5      |
| Q 1046 | IC          |       |       |      | LM2902PWR            | G1094009  |          | 1-  | A    | D5      |
| Q 1046 | IC          |       |       |      | NJM12902V-TE1        | G1093592  |          | 5-  | A    | D5      |
| Q 1047 | IC          |       |       |      | LM2902PWR            | G1094009  |          | 1-  | B    | c5      |
| Q 1047 | IC          |       |       |      | NJM12902V-TE1        | G1093592  |          | 5-  | B    | c5      |
| Q 1048 | IC          |       |       |      | LM2902PWR            | G1094009  |          | 1-  | A    | J2      |
| Q 1048 | IC          |       |       |      | NJM12902V-TE1        | G1093592  |          | 5-  | A    | J2      |
| Q 1049 | IC          |       |       |      | LM2902PWR            | G1094009  |          | 1-  | A    | I5      |
| Q 1049 | IC          |       |       |      | NJM12902V-TE1        | G1093592  |          | 5-  | A    | I5      |
| Q 1050 | FET         |       |       |      | 2SK397300L           | G3839738  |          | 1-  | A    | B2      |
| Q 1051 | IC          |       |       |      | S-80835CNMC-B8U-T2-G | G1093606  |          | 1-  | B    | j4      |
| Q 1052 | IC          |       |       |      | TAR5S50(TE85L.F)     | G1093914  |          | 1-  | A    | D3      |
| Q 1053 | TRANSISTOR  |       |       |      | RT1N441U-T11-1       | G3070247  |          | 1-  | A    | B2      |
| Q 1054 | IC          |       |       |      | ADF4111BRUZ-RL7      | G1094342  |          | 1-  | B    | d4      |
| Q 1055 | FET         |       |       |      | 2SK397300L           | G3839738  |          | 1-  | A    | B1      |
| Q 1056 | TRANSISTOR  |       |       |      | 2SC4617 TL R         | G3346178R |          | 1-  | B    | j4      |
| Q 1057 | TRANSISTOR  |       |       |      | RT1N441U-T11-1       | G3070247  |          | 1-  | A    | B2      |
| Q 1058 | TRANSISTOR  |       |       |      | RT1N140U(TAPE)       | G3070359  |          | 1-  | A    | B3      |
| Q 1059 | TRANSISTOR  |       |       |      | RT1N441U-T11-1       | G3070247  |          | 1-  | B    | a4      |
| Q 1060 | FET         |       |       |      | 2SK397300L           | G3839738  |          | 1-  | A    | A1      |
| Q 1061 | IC          |       |       |      | BR93L66RFVM-WTR      | G1093874  |          | 1-  | A    | B4      |
| Q 1062 | TRANSISTOR  |       |       |      | RT1N441U-T11-1       | G3070247  |          | 1-  | A    | A2      |
| Q 1063 | FET         |       |       |      | 2SK397300L           | G3839738  |          | 1-  | A    | A2      |
| Q 1064 | TRANSISTOR  |       |       |      | RT1N441U-T11-1       | G3070247  |          | 1-  | A    | B2      |
| Q 1065 | IC          |       |       |      | LC87F5CC8A-F57T0-E   | ✖         |          | 1-  | A    | B4      |
| Q 1066 | TRANSISTOR  |       |       |      | RT1N441U-T11-1       | G3070247  |          | 1-  | B    | i1      |
| Q 1067 | TRANSISTOR  |       |       |      | RT1N441U-T11-1       | G3070247  |          | 1-  | A    | I4      |
| Q 1068 | IC          |       |       |      | LC73881M-TLM         | G1092755  | CHINA    | 9-  | B    | g5      |
| Q 1068 | IC          |       |       |      | LC73881M-TLM         | G1092755  | VTX(USA) | 9-  | B    | g5      |
| Q 1069 | TRANSISTOR  |       |       |      | RT1N441U-T11-1       | G3070247  | CHINA    | 9-  | B    | g5      |
| Q 1069 | TRANSISTOR  |       |       |      | RT1N441U-T11-1       | G3070247  | VTX(USA) | 9-  | B    | g5      |
| Q 1070 | FET         |       |       |      | 2SK397300L           | G3839738  |          | 1-  | A    | B2      |
| Q 1072 | TRANSISTOR  |       |       |      | DTA124EE TL          | G3070116  |          | 9-  | A    | J5      |
| Q 1073 | TRANSISTOR  |       |       |      | RT1N441U-T11-1       | G3070247  |          | 9-  | B    | g5      |
| R 1001 | CHIP RES.   | 12k   | 1/16W | 5%   | RMC1/16S 123JTH      | J24189038 |          | 1-  | B    | i3      |
| R 1002 | CHIP RES.   | 47k   | 1/16W | 5%   | RMC1/16S 473JTH      | J24189045 |          | 1-  | A    | C4      |
| R 1002 | CHIP RES.   | 22k   | 1/16W | 5%   | RMC1/16S 223JTH      | J24189041 |          | 3-  | A    | C4      |
| R 1003 | CHIP RES.   | 10k   | 1/16W | 5%   | RMC1/16S 103JTH      | J24189037 |          | 1-  | B    | i3      |
| R 1004 | CHIP RES.   | 4.7k  | 1/16W | 5%   | RMC1/16S 472JTH      | J24189033 |          | 1-  | A    | G2      |
| R 1005 | CHIP RES.   | 47k   | 1/16W | 5%   | RMC1/16S 473JTH      | J24189045 |          | 1-  | A    | C5      |
| R 1005 | CHIP RES.   | 22k   | 1/16W | 5%   | RMC1/16S 223JTH      | J24189041 |          | 3-  | A    | C5      |
| R 1006 | CHIP RES.   | 470k  | 1/16W | 5%   | RMC1/16S 474JTH      | J24189057 |          | 1-  | A    | C5      |
| R 1007 | CHIP RES.   | 100   | 1W    | 5%   | RMC1 101JTE          | J24305101 |          | 1-  | A    | G3      |
| R 1008 | CHIP RES.   | 470k  | 1/16W | 5%   | RMC1/16S 474JTH      | J24189057 |          | 1-  | A    | C4      |
| R 1009 | CHIP RES.   | 470k  | 1/16W | 5%   | RMC1/16S 474JTH      | J24189057 |          | 1-  | A    | C4      |
| R 1009 | CHIP RES.   | 270k  | 1/16W | 5%   | RMC1/16S 274JTH      | J24189054 |          | 3-  | A    | C4      |

✖: Please contact Vertex Standard

# MAIN Unit

## Parts List

| REF    | DESCRIPTION | VALUE | V/W   | TOL. | MFR'S DESIG     | VXSTD P/N | VERS.    | LOT  | SIDE | LAY ADR |
|--------|-------------|-------|-------|------|-----------------|-----------|----------|------|------|---------|
| R 1010 | CHIP RES.   | 100k  | 1/16W | 5%   | RMC1/16S 104JTH | J24189049 |          | 1-   | B    | a3      |
| R 1011 | CHIP RES.   | 0     | 1/16W | 5%   | RMC1/16S JPTH   | J24189070 |          | 1-   | A    | I2      |
| R 1012 | CHIP RES.   | 100   | 1/4W  | 5%   | RMC1/4 101JATP  | J24245101 |          | 1-   | A    | H2      |
| R 1013 | CHIP RES.   | 10k   | 1/16W | 5%   | RMC1/16S 103JTH | J24189037 |          | 1-   | A    | C5      |
| R 1014 | CHIP RES.   | 4.7k  | 1/16W | 5%   | RMC1/16S 472JTH | J24189033 |          | 1-   | A    | C4      |
| R 1015 | CHIP RES.   | 10k   | 1/16W | 5%   | RMC1/16S 103JTH | J24189037 |          | 1-   | B    | i3      |
| R 1016 | CHIP RES.   | 0     | 1/16W | 5%   | RMC1/16S JPTH   | J24189070 |          | 1-   | A    | H2      |
| R 1017 | CHIP RES.   | 27k   | 1/16W | 5%   | RMC1/16S 273JTH | J24189042 |          | 1-   | B    | i3      |
| R 1018 | CHIP RES.   | 100k  | 1/16W | 5%   | RMC1/16S 104JTH | J24189049 |          | 1-   | B    | a3      |
| R 1019 | CHIP RES.   | 560   | 1/16W | 5%   | RMC1/16S 561JTH | J24189022 |          | 1-   | A    | B2      |
| R 1021 | CHIP RES.   | 100   | 1/4W  | 5%   | RMC1/4 101JATP  | J24245101 |          | 1-   | A    | H2      |
| R 1022 | CHIP RES.   | 270k  | 1/16W | 5%   | RMC1/16S 274JTH | J24189054 |          | 1-   | A    | D5      |
| R 1023 | CHIP RES.   | 120k  | 1/16W | 5%   | RMC1/16S 124JTH | J24189050 |          | 1-   | A    | E5      |
| R 1024 | CHIP RES.   | 3.3k  | 1/16W | 5%   | RMC1/16S 332JTH | J24189031 |          | 1-   | A    | H3      |
| R 1025 | CHIP RES.   | 100k  | 1/16W | 5%   | RMC1/16S 104JTH | J24189049 |          | 1-   | A    | E5      |
| R 1026 | CHIP RES.   | 3.3k  | 1/16W | 5%   | RMC1/16S 332JTH | J24189031 |          | 1-8  | A    | I2      |
| R 1026 | CHIP RES.   | 1k    | 1/16W | 5%   | RMC1/16S 102JTH | J24189025 | 25W      | 9-   | A    | I2      |
| R 1026 | CHIP RES.   | 3.3k  | 1/16W | 5%   | RMC1/16S 332JTH | J24189031 | 50W      | 9-   | A    | I2      |
| R 1027 | CHIP RES.   | 3.3k  | 1/16W | 5%   | RMC1/16S 332JTH | J24189031 |          | 1-   | A    | H3      |
| R 1027 | CHIP RES.   | 2.7k  | 1/16W | 5%   | RMC1/16S 272JTH | J24189030 |          | 3-8  | A    | H3      |
| R 1027 | CHIP RES.   | 10k   | 1/16W | 5%   | RMC1/16S 103JTH | J24189037 | 25W      | 9-   | A    | H3      |
| R 1027 | CHIP RES.   | 2.7k  | 1/16W | 5%   | RMC1/16S 272JTH | J24189030 | 50W      | 9-   | A    | H3      |
| R 1028 | CHIP RES.   | 3.3k  | 1/16W | 5%   | RMC1/16S 332JTH | J24189031 |          | 1-   | A    | I2      |
| R 1028 | CHIP RES.   | 2.7k  | 1/16W | 5%   | RMC1/16S 272JTH | J24189030 |          | 5-8  | A    | I2      |
| R 1028 | CHIP RES.   | 10k   | 1/16W | 5%   | RMC1/16S 103JTH | J24189037 | 25W      | 9-   | A    | I2      |
| R 1028 | CHIP RES.   | 2.7k  | 1/16W | 5%   | RMC1/16S 272JTH | J24189030 | 50W      | 9-   | A    | I2      |
| R 1029 | CHIP RES.   | 220k  | 1/16W | 5%   | RMC1/16S 224JTH | J24189053 |          | 1-8  | A    | I2      |
| R 1029 | CHIP RES.   | 100k  | 1/16W | 5%   | RMC1/16S 104JTH | J24189049 | 25W      | 9-   | A    | I2      |
| R 1029 | CHIP RES.   | 220k  | 1/16W | 5%   | RMC1/16S 224JTH | J24189053 | 50W      | 9-   | A    | I2      |
| R 1030 | CHIP RES.   | 0     | 1/16W | 5%   | RMC1/16S JPTH   | J24189070 |          | 1-   | A    | J2      |
| R 1031 | CHIP RES.   | 4.7k  | 1/16W | 5%   | RMC1/16S 472JTH | J24189033 |          | 1-   | B    | b3      |
| R 1032 | CHIP RES.   | 10k   | 1/16W | 5%   | RMC1/16S 103JTH | J24189037 |          | 1-   | B    | b3      |
| R 1033 | CHIP RES.   | 4.7k  | 1/16W | 5%   | RMC1/16S 472JTH | J24189033 |          | 1-8  | B    | b3      |
| R 1033 | CHIP RES.   | 3.3k  | 1/16W | 5%   | RMC1/16S 332JTH | J24189031 | W/ CE    | 9-   | B    | b3      |
| R 1033 | CHIP RES.   | 4.7k  | 1/16W | 5%   | RMC1/16S 472JTH | J24189033 | W/O CE   | 9-   | B    | b3      |
| R 1034 | CHIP RES.   | 0     | 1/16W | 5%   | RMC1/16 000JATP | J24185000 |          | 1-   | A    | D5      |
| R 1035 | CHIP RES.   | 100k  | 1/16W | 5%   | RMC1/16S 104JTH | J24189049 |          | 1-   | A    | K2      |
| R 1036 | CHIP RES.   | 15k   | 1/16W | 5%   | RMC1/16S 153JTH | J24189039 |          | 1-   | A    | E5      |
| R 1036 | CHIP RES.   | 8.2k  | 1/16W | 5%   | RMC1/16S 822JTH | J24189036 |          | 3-10 | A    | E5      |
| R 1036 | CHIP RES.   | 10k   | 1/16W | 5%   | RMC1/16S 103JTH | J24189037 | CHINA    | 11-  | A    | E5      |
| R 1036 | CHIP RES.   | 8.2k  | 1/16W | 5%   | RMC1/16S 822JTH | J24189036 | EUROPE   | 11-  | A    | E5      |
| R 1036 | CHIP RES.   | 8.2k  | 1/16W | 5%   | RMC1/16S 822JTH | J24189036 | EXPORT   | 11-  | A    | E5      |
| R 1036 | CHIP RES.   | 8.2k  | 1/16W | 5%   | RMC1/16S 822JTH | J24189036 | VTX(USA) | 11-  | A    | E5      |
| R 1037 | CHIP RES.   | 220k  | 1/16W | 5%   | RMC1/16S 224JTH | J24189053 |          | 1-   | A    | G5      |
| R 1038 | CHIP RES.   | 0     | 1/16W | 5%   | RMC1/16S JPTH   | J24189070 |          | 1-   | A    | G5      |
| R 1039 | CHIP RES.   | 100   | 1/16W | 5%   | RMC1/16S 101JTH | J24189013 |          | 1-8  | B    | b3      |
| R 1039 | CHIP RES.   | 47    | 1/16W | 5%   | RMC1/16S 470JTH | J24189009 | W/ CE    | 9-   | B    | b3      |
| R 1039 | CHIP RES.   | 100   | 1/16W | 5%   | RMC1/16S 101JTH | J24189013 | W/O CE   | 9-   | B    | b3      |
| R 1041 | CHIP RES.   | 150k  | 1/16W | 5%   | RMC1/16S 154JTH | J24189051 |          | 1-   | A    | J2      |
| R 1041 | CHIP RES.   | 100k  | 1/16W | 5%   | RMC1/16S 104JTH | J24189049 |          | 7-   | A    | J2      |
| R 1042 | CHIP RES.   | 22k   | 1/16W | 5%   | RMC1/16S 223JTH | J24189041 |          | 1-   | B    | h2      |
| R 1043 | CHIP RES.   | 5.6k  | 1/16W | 5%   | RMC1/16S 562JTH | J24189034 |          | 1-   | A    | E5      |
| R 1044 | CHIP RES.   | 10k   | 1/16W | 5%   | RMC1/16S 103JTH | J24189037 |          | 1-   | A    | G4      |
| R 1045 | CHIP RES.   | 10k   | 1/16W | 5%   | RMC1/16S 103JTH | J24189037 |          | 1-   | B    | h2      |
| R 1047 | CHIP RES.   | 47    | 1/16W | 5%   | RMC1/16S 470JTH | J24189009 |          | 1-   | B    | b3      |
| R 1048 | CHIP RES.   | 100k  | 1/16W | 5%   | RMC1/16S 104JTH | J24189049 |          | 1-   | A    | G5      |
| R 1049 | CHIP RES.   | 22k   | 1/16W | 5%   | RMC1/16S 223JTH | J24189041 |          | 1-   | A    | F3      |
| R 1050 | CHIP RES.   | 330   | 1/16W | 5%   | RMC1/16S 331JTH | J24189019 |          | 1-   | B    | f2      |
| R 1051 | CHIP RES.   | 39k   | 1/16W | 5%   | RMC1/16S 393JTH | J24189044 |          | 1-   | A    | G5      |
| R 1052 | CHIP RES.   | 560k  | 1/16W | 5%   | RMC1/16S 564JTH | J24189058 |          | 1-   | A    | E5      |
| R 1052 | CHIP RES.   | 180k  | 1/16W | 5%   | RMC1/16S 184JTH | J24189052 |          | 3-   | A    | E5      |
| R 1052 | CHIP RES.   | 220k  | 1/16W | 5%   | RMC1/16S 224JTH | J24189053 |          | 5-10 | A    | E5      |
| R 1052 | CHIP RES.   | 330k  | 1/16W | 5%   | RMC1/16S 334JTH | J24189055 | CHINA    | 11-  | A    | E5      |
| R 1052 | CHIP RES.   | 220k  | 1/16W | 5%   | RMC1/16S 224JTH | J24189053 | EUROPE   | 11-  | A    | E5      |
| R 1052 | CHIP RES.   | 220k  | 1/16W | 5%   | RMC1/16S 224JTH | J24189053 | EXPORT   | 11-  | A    | E5      |
| R 1052 | CHIP RES.   | 220k  | 1/16W | 5%   | RMC1/16S 224JTH | J24189053 | VTX(USA) | 11-  | A    | E5      |
| R 1053 | CHIP RES.   | 0     | 1/16W | 5%   | RMC1/16 000JATP | J24185000 |          | 1-   | A    | B5      |
| R 1054 | CHIP RES.   | 18    | 1/16W | 5%   | RMC1/16S 180JTH | J24189004 |          | 1-   | B    | f2      |
| R 1054 | CHIP RES.   | 100   | 1/16W | 5%   | RMC1/16S 101JTH | J24189013 |          | 5-   | B    | f2      |
| R 1054 | CHIP RES.   | 33    | 1/16W | 5%   | RMC1/16S 330JTH | J24189007 |          | 7-8  | B    | f2      |
| R 1054 | CHIP RES.   | 56    | 1/16W | 5%   | RMC1/16S 560JTH | J24189010 | W/ CE    | 9-   | B    | f2      |
| R 1054 | CHIP RES.   | 33    | 1/16W | 5%   | RMC1/16S 330JTH | J24189007 | W/O CE   | 9-   | B    | f2      |
| R 1057 | CHIP RES.   | 1M    | 1/16W | 5%   | RMC1/16S 105JTH | J24189061 |          | 1-   | A    | G4      |

# MAIN Unit

## Parts List

| REF    | DESCRIPTION | VALUE | V/W   | TOL. | MFR'S DESIG     | VXSTD P/N | VERS. | LOT | SIDE | LAY ADR |
|--------|-------------|-------|-------|------|-----------------|-----------|-------|-----|------|---------|
| R 1058 | CHIP RES.   | 100k  | 1/16W | 5%   | RMC1/16S 104JTH | J24189049 |       | 1-8 | A    | J2      |
| R 1058 | CHIP RES.   | 47k   | 1/16W | 5%   | RMC1/16S 473JTH | J24189045 | 25W   | 9-  | A    | J2      |
| R 1058 | CHIP RES.   | 100k  | 1/16W | 5%   | RMC1/16S 104JTH | J24189049 | 50W   | 9-  | A    | J2      |
| R 1059 | CHIP RES.   | 1k    | 1/16W | 5%   | RMC1/16S 102JTH | J24189025 |       | 1-  | A    | F3      |
| R 1060 | CHIP RES.   | 330   | 1/16W | 5%   | RMC1/16S 331JTH | J24189019 |       | 1-  | B    | f2      |
| R 1061 | CHIP RES.   | 2.2k  | 1/16W | 5%   | RMC1/16S 222JTH | J24189029 |       | 1-  | A    | K2      |
| R 1063 | CHIP RES.   | 10k   | 1/16W | 5%   | RMC1/16S 103JTH | J24189037 |       | 1-  | A    | E5      |
| R 1065 | CHIP RES.   | 100k  | 1/16W | 5%   | RMC1/16S 104JTH | J24189049 |       | 1-  | A    | J2      |
| R 1066 | CHIP RES.   | 0     | 1/16W | 5%   | RMC1/16S JPTH   | J24189070 |       | 1-  | A    | F5      |
| R 1067 | CHIP RES.   | 10k   | 1/16W | 5%   | RMC1/16S 103JTH | J24189037 |       | 1-  | A    | H5      |
| R 1068 | CHIP RES.   | 100k  | 1/16W | 5%   | RMC1/16S 104JTH | J24189049 |       | 1-  | A    | J2      |
| R 1069 | CHIP RES.   | 56k   | 1/16W | 5%   | RMC1/16S 563JTH | J24189046 |       | 1-  | A    | K2      |
| R 1070 | CHIP RES.   | 39k   | 1/16W | 5%   | RMC1/16S 393JTH | J24189044 |       | 1-  | A    | G4      |
| R 1071 | CHIP RES.   | 47k   | 1/16W | 5%   | RMC1/16S 473JTH | J24189045 |       | 1-  | A    | B5      |
| R 1072 | CHIP RES.   | 47k   | 1/16W | 5%   | RMC1/16S 473JTH | J24189045 |       | 1-  | A    | F3      |
| R 1073 | CHIP RES.   | 10k   | 1/16W | 5%   | RMC1/16S 103JTH | J24189037 |       | 1-  | A    | G5      |
| R 1074 | CHIP RES.   | 100k  | 1/16W | 5%   | RMC1/16S 104JTH | J24189049 |       | 1-  | A    | F3      |
| R 1075 | CHIP RES.   | 27k   | 1/16W | 5%   | RMC1/16S 273JTH | J24189042 |       | 1-  | A    | I5      |
| R 1076 | CHIP RES.   | 47k   | 1/16W | 5%   | RMC1/16S 473JTH | J24189045 |       | 1-  | A    | B5      |
| R 1077 | CHIP RES.   | 68    | 1/4W  | 5%   | RMC1/4 680JATP  | J24245680 |       | 1-  | B    | f2      |
| R 1078 | CHIP RES.   | 0     | 1/16W | 5%   | RMC1/16S JPTH   | J24189070 |       | 1-  | A    | G5      |
| R 1079 | CHIP RES.   | 47k   | 1/16W | 5%   | RMC1/16S 473JTH | J24189045 |       | 1-  | A    | B5      |
| R 1080 | CHIP RES.   | 5.6k  | 1/16W | 5%   | RMC1/16S 562JTH | J24189034 |       | 1-  | A    | I4      |
| R 1081 | CHIP RES.   | 10k   | 1/16W | 5%   | RMC1/16S 103JTH | J24189037 |       | 1-  | B    | f2      |
| R 1082 | CHIP RES.   | 2.2M  | 1/16W | 5%   | RMC1/16S 225JTH | J24189065 | 25W   | 9-  | A    | J2      |
| R 1083 | CHIP RES.   | 0     | 1/16W | 5%   | RMC1/16 000JATP | J24185000 |       | 1-  | A    | F3      |
| R 1084 | CHIP RES.   | 47k   | 1/16W | 5%   | RMC1/16S 473JTH | J24189045 |       | 1-  | B    | i5      |
| R 1085 | CHIP RES.   | 2.2k  | 1/16W | 5%   | RMC1/16S 222JTH | J24189029 |       | 1-  | A    | I5      |
| R 1086 | CHIP RES.   | 0     | 1/16W | 5%   | RMC1/16S JPTH   | J24189070 |       | 1-  | A    | F5      |
| R 1087 | CHIP RES.   | 8.2k  | 1/16W | 5%   | RMC1/16S 822JTH | J24189036 |       | 1-  | A    | I5      |
| R 1088 | CHIP RES.   | 1k    | 1/16W | 5%   | RMC1/16S 102JTH | J24189025 |       | 1-  | A    | J2      |
| R 1089 | CHIP RES.   | 10k   | 1/16W | 5%   | RMC1/16S 103JTH | J24189037 |       | 1-  | A    | H4      |
| R 1090 | CHIP RES.   | 10k   | 1/16W | 5%   | RMC1/16S 103JTH | J24189037 |       | 1-  | A    | H4      |
| R 1091 | CHIP RES.   | 10k   | 1/16W | 5%   | RMC1/16S 103JTH | J24189037 |       | 1-  | A    | F3      |
| R 1092 | CHIP RES.   | 150   | 1/16W | 5%   | RMC1/16S 151JTH | J24189015 |       | 1-  | B    | e2      |
| R 1093 | CHIP RES.   | 470   | 1/16W | 5%   | RMC1/16S 471JTH | J24189021 |       | 1-  | B    | f2      |
| R 1094 | CHIP RES.   | 10k   | 1/16W | 5%   | RMC1/16S 103JTH | J24189037 |       | 1-  | A    | F4      |
| R 1094 | CHIP RES.   | 22k   | 1/16W | 5%   | RMC1/16S 223JTH | J24189041 |       | 3-  | A    | F4      |
| R 1095 | CHIP RES.   | 33k   | 1/16W | 5%   | RMC1/16S 333JTH | J24189043 |       | 1-  | A    | E5      |
| R 1096 | CHIP RES.   | 100k  | 1/16W | 5%   | RMC1/16S 104JTH | J24189049 |       | 1-  | A    | E5      |
| R 1097 | CHIP RES.   | 18k   | 1/16W | 5%   | RMC1/16S 183JTH | J24189040 |       | 1-  | B    | j5      |
| R 1098 | CHIP RES.   | 10k   | 1/16W | 5%   | RMC1/16S 103JTH | J24189037 |       | 1-  | B    | i5      |
| R 1099 | CHIP RES.   | 470   | 1/16W | 5%   | RMC1/16S 471JTH | J24189021 |       | 1-  | B    | e2      |
| R 1101 | CHIP RES.   | 10k   | 1/16W | 5%   | RMC1/16S 103JTH | J24189037 |       | 1-  | B    | i5      |
| R 1102 | CHIP RES.   | 0     | 1/16W | 5%   | RMC1/16S JPTH   | J24189070 |       | 1-  | B    | c3      |
| R 1103 | CHIP RES.   | 22k   | 1/16W | 5%   | RMC1/16S 223JTH | J24189041 |       | 1-  | A    | I5      |
| R 1104 | CHIP RES.   | 10k   | 1/16W | 5%   | RMC1/16S 103JTH | J24189037 |       | 1-  | A    | J3      |
| R 1106 | CHIP RES.   | 47k   | 1/16W | 5%   | RMC1/16S 473JTH | J24189045 |       | 1-  | B    | i5      |
| R 1108 | CHIP RES.   | 0     | 1/16W | 5%   | RMC1/16S JPTH   | J24189070 |       | 1-  | A    | F5      |
| R 1109 | CHIP RES.   | 10k   | 1/16W | 5%   | RMC1/16S 103JTH | J24189037 |       | 1-  | B    | i5      |
| R 1110 | CHIP RES.   | 39k   | 1/16W | 5%   | RMC1/16S 393JTH | J24189044 |       | 1-  | A    | E5      |
| R 1110 | CHIP RES.   | 27k   | 1/16W | 5%   | RMC1/16S 273JTH | J24189042 |       | 5-  | A    | E5      |
| R 1112 | CHIP RES.   | 15k   | 1/16W | 5%   | RMC1/16S 153JTH | J24189039 |       | 1-  | A    | I5      |
| R 1113 | CHIP RES.   | 39k   | 1/16W | 5%   | RMC1/16S 393JTH | J24189044 |       | 1-  | A    | E5      |
| R 1114 | CHIP RES.   | 100   | 1/16W | 5%   | RMC1/16S 101JTH | J24189013 |       | 1-  | B    | e2      |
| R 1115 | CHIP RES.   | 100k  | 1/16W | 5%   | RMC1/16S 104JTH | J24189049 |       | 1-  | A    | F4      |
| R 1116 | CHIP RES.   | 150k  | 1/16W | 5%   | RMC1/16S 154JTH | J24189051 |       | 1-  | A    | F4      |
| R 1117 | CHIP RES.   | 4.7k  | 1/16W | 5%   | RMC1/16S 472JTH | J24189033 |       | 1-  | A    | J3      |
| R 1118 | CHIP RES.   | 6.8k  | 1/16W | 5%   | RMC1/16S 682JTH | J24189035 |       | 1-  | A    | J2      |
| R 1119 | CHIP RES.   | 47k   | 1/16W | 5%   | RMC1/16S 473JTH | J24189045 |       | 1-  | B    | e2      |
| R 1120 | CHIP RES.   | 4.7k  | 1/16W | 5%   | RMC1/16S 472JTH | J24189033 |       | 1-  | A    | J3      |
| R 1122 | CHIP RES.   | 82k   | 1/16W | 5%   | RMC1/16S 823JTH | J24189048 |       | 1-  | A    | H3      |
| R 1123 | CHIP RES.   | 10k   | 1/16W | 5%   | RMC1/16S 103JTH | J24189037 |       | 1-  | A    | I5      |
| R 1125 | CHIP RES.   | 10k   | 1/16W | 5%   | RMC1/16S 103JTH | J24189037 |       | 1-  | A    | J3      |
| R 1126 | CHIP RES.   | 10k   | 1/16W | 5%   | RMC1/16S 103JTH | J24189037 |       | 1-8 | A    | J3      |
| R 1126 | CHIP RES.   | 8.2k  | 1/16W | 5%   | RMC1/16S 822JTH | J24189036 | 25W   | 9-  | A    | J3      |
| R 1126 | CHIP RES.   | 10k   | 1/16W | 5%   | RMC1/16S 103JTH | J24189037 | 50W   | 9-  | A    | J3      |
| R 1127 | CHIP RES.   | 2.2k  | 1/16W | 5%   | RMC1/16S 222JTH | J24189029 |       | 1-  | B    | i5      |
| R 1129 | CHIP RES.   | 100k  | 1/16W | 5%   | RMC1/16S 104JTH | J24189049 |       | 1-  | A    | H3      |
| R 1130 | CHIP RES.   | 100   | 1/16W | 5%   | RMC1/16S 101JTH | J24189013 |       | 1-  | B    | e2      |
| R 1131 | CHIP RES.   | 18    | 1/16W | 5%   | RMC1/16S 180JTH | J24189004 |       | 1-  | B    | e2      |
| R 1132 | CHIP RES.   | 22k   | 1/16W | 5%   | RMC1/16S 223JTH | J24189041 |       | 1-  | A    | H5      |
| R 1133 | CHIP RES.   | 82k   | 1/16W | 5%   | RMC1/16S 823JTH | J24189048 |       | 1-  | B    | e2      |



# MAIN Unit

## Parts List

| REF    | DESCRIPTION | VALUE | V/W   | TOL. | MFR'S DESIG     | VXSTD P/N | VERS. | LOT  | SIDE | LAY ADR |
|--------|-------------|-------|-------|------|-----------------|-----------|-------|------|------|---------|
| R 1135 | CHIP RES.   | 100k  | 1/16W | 5%   | RMC1/16S 104JTH | J24189049 |       | 1-   | A    | H3      |
| R 1136 | CHIP RES.   | 100k  | 1/16W | 5%   | RMC1/16S 104JTH | J24189049 |       | 1-   | A    | H3      |
| R 1137 | CHIP RES.   | 100   | 1/16W | 5%   | RMC1/16S 101JTH | J24189013 |       | 1-   | A    | E3      |
| R 1138 | CHIP RES.   | 1k    | 1/16W | 5%   | RMC1/16S 102JTH | J24189025 |       | 1-   | B    | d3      |
| R 1139 | CHIP RES.   | 100   | 1/16W | 5%   | RMC1/16S 101JTH | J24189013 |       | 1-   | A    | H3      |
| R 1140 | CHIP RES.   | 1k    | 1/16W | 5%   | RMC1/16S 102JTH | J24189025 |       | 1-   | B    | e3      |
| R 1141 | CHIP RES.   | 3.9k  | 1/16W | 5%   | RMC1/16S 392JTH | J24189032 |       | 1-   | B    | e2      |
| R 1142 | CHIP RES.   | 560   | 1/16W | 5%   | RMC1/16S 561JTH | J24189022 |       | 1-   | B    | e3      |
| R 1143 | CHIP RES.   | 0     | 1/16W | 5%   | RMC1/16S JPTH   | J24189070 |       | 1-   | B    | e3      |
| R 1144 | CHIP RES.   | 33k   | 1/16W | 5%   | RMC1/16S 333JTH | J24189043 |       | 1-   | B    | e3      |
| R 1145 | CHIP RES.   | 150k  | 1/16W | 5%   | RMC1/16S 154JTH | J24189051 |       | 1-   | A    | H4      |
| R 1146 | CHIP RES.   | 150k  | 1/16W | 5%   | RMC1/16S 154JTH | J24189051 |       | 1-   | A    | H4      |
| R 1149 | CHIP RES.   | 47    | 1/16W | 5%   | RMC1/16S 470JTH | J24189009 |       | 1-   | A    | H4      |
| R 1150 | CHIP RES.   | 47    | 1/16W | 5%   | RMC1/16S 470JTH | J24189009 |       | 1-   | A    | H4      |
| R 1151 | CHIP RES.   | 15k   | 1/16W | 5%   | RMC1/16S 153JTH | J24189039 |       | 1-   | B    | e3      |
| R 1152 | CHIP RES.   | 22    | 1/16W | 5%   | RMC1/16S 220JTH | J24189005 |       | 1-   | B    | d4      |
| R 1153 | CHIP RES.   | 220k  | 1/16W | 5%   | RMC1/16S 224JTH | J24189053 |       | 1-   | A    | D4      |
| R 1154 | CHIP RES.   | 18k   | 1/16W | 5%   | RMC1/16S 183JTH | J24189040 |       | 1-   | B    | f5      |
| R 1155 | CHIP RES.   | 270   | 1/16W | 5%   | RMC1/16S 271JTH | J24189018 |       | 1-   | B    | f3      |
| R 1155 | CHIP RES.   | 270   | 1/16W | 0.5% | MHR01MZPD2700   | J24189427 |       | 7-   | B    | f3      |
| R 1156 | CHIP RES.   | 68k   | 1/16W | 5%   | RMC1/16S 683JTH | J24189047 |       | 1-   | A    | H5      |
| R 1156 | CHIP RES.   | 82k   | 1/16W | 5%   | RMC1/16S 823JTH | J24189048 |       | 5-10 | A    | H5      |
| R 1156 | CHIP RES.   | 68k   | 1/16W | 5%   | RMC1/16S 683JTH | J24189047 |       | 11-  | A    | H5      |
| R 1156 | CHIP RES.   | 82k   | 1/16W | 5%   | RMC1/16S 823JTH | J24189048 |       | 11-  | A    | H5      |
| R 1156 | CHIP RES.   | 82k   | 1/16W | 5%   | RMC1/16S 823JTH | J24189048 |       | 11-  | A    | H5      |
| R 1156 | CHIP RES.   | 82k   | 1/16W | 5%   | RMC1/16S 823JTH | J24189048 |       | 11-  | A    | H5      |
| R 1157 | CHIP RES.   | 0     | 1/16W | 5%   | RMC1/16S JPTH   | J24189070 |       | 1-   | A    | E4      |
| R 1158 | CHIP RES.   | 1M    | 1/16W | 5%   | RMC1/16S 105JTH | J24189061 |       | 1-   | A    | D4      |
| R 1159 | CHIP RES.   | 180k  | 1/16W | 5%   | RMC1/16S 184JTH | J24189052 |       | 1-   | A    | H5      |
| R 1160 | CHIP RES.   | 100   | 1/16W | 5%   | RMC1/16S 101JTH | J24189013 |       | 1-   | B    | f3      |
| R 1160 | CHIP RES.   | 100   | 1/16W | 0.5% | MHR01MZPD1000   | J24189422 |       | 8-   | B    | f3      |
| R 1161 | CHIP RES.   | 33k   | 1/16W | 5%   | RMC1/16S 333JTH | J24189043 |       | 1-   | A    | D5      |
| R 1162 | CHIP RES.   | 220k  | 1/16W | 5%   | RMC1/16S 224JTH | J24189053 |       | 1-   | A    | D5      |
| R 1163 | CHIP RES.   | 47    | 1/16W | 5%   | RMC1/16S 470JTH | J24189009 |       | 1-   | B    | e3      |
| R 1164 | CHIP RES.   | 3.3k  | 1/16W | 5%   | RMC1/16S 332JTH | J24189031 |       | 1-   | B    | e3      |
| R 1164 | CHIP RES.   | 3.3k  | 1/16W | 0.5% | MHR01MZPD3301   | J24189440 |       | 7-   | B    | e3      |
| R 1165 | CHIP RES.   | 1k    | 1/16W | 5%   | RMC1/16S 102JTH | J24189025 |       | 1-   | B    | f3      |
| R 1165 | CHIP RES.   | 1k    | 1/16W | 0.5% | MHR01MZPD1001   | J24189434 |       | 8-   | B    | f3      |
| R 1166 | CHIP RES.   | 560   | 1/16W | 5%   | RMC1/16S 561JTH | J24189022 |       | 1-   | A    | G5      |
| R 1167 | CHIP RES.   | 330k  | 1/16W | 5%   | RMC1/16S 334JTH | J24189055 |       | 1-   | A    | H5      |
| R 1168 | CHIP RES.   | 5.6k  | 1/16W | 5%   | RMC1/16S 562JTH | J24189034 |       | 1-   | B    | e4      |
| R 1168 | CHIP RES.   | 5.6k  | 1/16W | 0.5% | MHR01MZPD5601   | J24189443 |       | 7-   | B    | e4      |
| R 1170 | CHIP RES.   | 390   | 1/16W | 5%   | RMC1/16S 391JTH | J24189020 |       | 1-   | A    | I4      |
| R 1171 | CHIP RES.   | 100k  | 1/16W | 5%   | RMC1/16S 104JTH | J24189049 |       | 1-   | A    | G5      |
| R 1172 | CHIP RES.   | 47k   | 1/16W | 5%   | RMC1/16S 473JTH | J24189045 |       | 1-   | B    | c4      |
| R 1173 | CHIP RES.   | 100k  | 1/16W | 5%   | RMC1/16S 104JTH | J24189049 |       | 1-   | A    | G5      |
| R 1174 | CHIP RES.   | 10k   | 1/16W | 5%   | RMC1/16S 103JTH | J24189037 |       | 1-   | A    | E5      |
| R 1175 | CHIP RES.   | 220k  | 1/16W | 5%   | RMC1/16S 224JTH | J24189053 |       | 1-   | A    | H5      |
| R 1176 | CHIP RES.   | 150   | 1/16W | 5%   | RMC1/16S 151JTH | J24189015 |       | 1-   | B    | c4      |
| R 1177 | CHIP RES.   | 470   | 1/16W | 5%   | RMC1/16S 471JTH | J24189021 |       | 1-   | B    | b4      |
| R 1178 | CHIP RES.   | 2.2k  | 1/16W | 5%   | RMC1/16S 222JTH | J24189029 |       | 1-   | B    | f3      |
| R 1179 | CHIP RES.   | 100k  | 1/16W | 5%   | RMC1/16S 104JTH | J24189049 |       | 1-10 | A    | H5      |
| R 1179 | CHIP RES.   | 56k   | 1/16W | 5%   | RMC1/16S 563JTH | J24189046 |       | 11-  | A    | H5      |
| R 1179 | CHIP RES.   | 100k  | 1/16W | 5%   | RMC1/16S 104JTH | J24189049 |       | 11-  | A    | H5      |
| R 1179 | CHIP RES.   | 100k  | 1/16W | 5%   | RMC1/16S 104JTH | J24189049 |       | 11-  | A    | H5      |
| R 1179 | CHIP RES.   | 100k  | 1/16W | 5%   | RMC1/16S 104JTH | J24189049 |       | 11-  | A    | H5      |
| R 1180 | CHIP RES.   | 10k   | 1/16W | 5%   | RMC1/16S 103JTH | J24189037 |       | 1-   | A    | E5      |
| R 1181 | CHIP RES.   | 270   | 1/16W | 5%   | RMC1/16S 271JTH | J24189018 |       | 1-   | B    | c4      |
| R 1182 | CHIP RES.   | 4.7k  | 1/16W | 5%   | RMC1/16S 472JTH | J24189033 |       | 1-   | A    | E3      |
| R 1183 | CHIP RES.   | 10k   | 1/16W | 5%   | RMC1/16S 103JTH | J24189037 |       | 1-   | A    | C4      |
| R 1184 | CHIP RES.   | 10k   | 1/16W | 5%   | RMC1/16S 103JTH | J24189037 |       | 1-   | A    | C4      |
| R 1185 | CHIP RES.   | 10k   | 1/16W | 5%   | RMC1/16S 103JTH | J24189037 |       | 1-   | A    | H5      |
| R 1186 | CHIP RES.   | 680k  | 1/16W | 5%   | RMC1/16S 684JTH | J24189059 |       | 1-   | B    | c5      |
| R 1187 | CHIP RES.   | 470k  | 1/16W | 5%   | RMC1/16S 474JTH | J24189057 |       | 1-   | A    | G5      |
| R 1188 | CHIP RES.   | 4.7M  | 1/16W | 5%   | RMC1/16S 475JTH | J24189337 |       | 1-   | A    | H5      |
| R 1188 | CHIP RES.   | 3.3M  | 1/16W | 5%   | RMC1/16S 335JTH | J24189324 |       | 5-   | A    | H5      |
| R 1189 | CHIP RES.   | 100k  | 1/16W | 5%   | RMC1/16S 104JTH | J24189049 |       | 1-   | A    | I5      |
| R 1191 | CHIP RES.   | 1.2k  | 1/16W | 5%   | RMC1/16S 122JTH | J24189026 |       | 1-   | B    | e3      |
| R 1192 | CHIP RES.   | 22k   | 1/16W | 5%   | RMC1/16S 223JTH | J24189041 |       | 1-   | A    | G5      |
| R 1193 | CHIP RES.   | 10k   | 1/16W | 5%   | RMC1/16S 103JTH | J24189037 |       | 1-   | B    | h4      |
| R 1194 | CHIP RES.   | 82k   | 1/16W | 5%   | RMC1/16S 823JTH | J24189048 |       | 1-   | A    | I5      |
| R 1195 | CHIP RES.   | 22    | 1/16W | 5%   | RMC1/16S 220JTH | J24189005 |       | 1-   | B    | f4      |
| R 1196 | CHIP RES.   | 47k   | 1/16W | 5%   | RMC1/16S 473JTH | J24189045 |       | 1-   | A    | D4      |

CHINA  
EUROPE  
EXPORT  
VTX(USA)

# MAIN Unit

## Parts List

| REF    | DESCRIPTION | VALUE | V/W   | TOL. | MFR'S DESIG     | VXSTD P/N | VERS. | LOT | SIDE | LAY ADR |
|--------|-------------|-------|-------|------|-----------------|-----------|-------|-----|------|---------|
| R 1198 | CHIP RES.   | 68k   | 1/16W | 5%   | RMC1/16S 683JTH | J24189047 |       | 1-  | A    | H5      |
| R 1198 | CHIP RES.   | 82k   | 1/16W | 5%   | RMC1/16S 823JTH | J24189048 |       | 5-  | A    | H5      |
| R 1199 | CHIP RES.   | 47k   | 1/16W | 5%   | RMC1/16S 473JTH | J24189045 |       | 1-  | A    | D4      |
| R 1200 | CHIP RES.   | 0     | 1/16W | 5%   | RMC1/16S JPTH   | J24189070 |       | 1-  | A    | H5      |
| R 1201 | CHIP RES.   | 10k   | 1/16W | 5%   | RMC1/16S 103JTH | J24189037 |       | 1-  | A    | H5      |
| R 1202 | CHIP RES.   | 15k   | 1/16W | 5%   | RMC1/16S 153JTH | J24189039 |       | 1-  | A    | H5      |
| R 1203 | CHIP RES.   | 10k   | 1/16W | 5%   | RMC1/16S 103JTH | J24189037 |       | 1-  | A    | G5      |
| R 1204 | CHIP RES.   | 47k   | 1/16W | 5%   | RMC1/16S 473JTH | J24189045 |       | 1-  | A    | D4      |
| R 1205 | CHIP RES.   | 47k   | 1/16W | 5%   | RMC1/16S 473JTH | J24189045 |       | 1-  | A    | D4      |
| R 1206 | CHIP RES.   | 470   | 1/16W | 5%   | RMC1/16S 471JTH | J24189021 |       | 1-  | A    | G4      |
| R 1207 | CHIP RES.   | 12k   | 1/16W | 5%   | RMC1/16S 123JTH | J24189038 |       | 1-  | B    | a4      |
| R 1208 | CHIP RES.   | 10k   | 1/16W | 5%   | RMC1/16S 103JTH | J24189037 |       | 1-  | B    | e4      |
| R 1209 | CHIP RES.   | 1.5k  | 1/16W | 5%   | RMC1/16S 152JTH | J24189027 |       | 1-  | B    | e4      |
| R 1210 | CHIP RES.   | 3.3k  | 1/16W | 5%   | RMC1/16S 332JTH | J24189031 |       | 1-  | B    | b4      |
| R 1211 | CHIP RES.   | 0     | 1/16W | 5%   | RMC1/16S JPTH   | J24189070 |       | 1-  | B    | e4      |
| R 1212 | CHIP RES.   | 150k  | 1/16W | 5%   | RMC1/16S 154JTH | J24189051 |       | 1-  | A    | J5      |
| R 1213 | CHIP RES.   | 1k    | 1/16W | 5%   | RMC1/16S 102JTH | J24189025 |       | 1-  | A    | F3      |
| R 1215 | CHIP RES.   | 2.2k  | 1/16W | 5%   | RMC1/16S 222JTH | J24189029 |       | 1-  | A    | D4      |
| R 1216 | CHIP RES.   | 1.8k  | 1/16W | 5%   | RMC1/16S 182JTH | J24189028 |       | 1-  | A    | C4      |
| R 1217 | CHIP RES.   | 12k   | 1/16W | 5%   | RMC1/16S 123JTH | J24189038 |       | 1-  | B    | a4      |
| R 1218 | CHIP RES.   | 1.5k  | 1/16W | 5%   | RMC1/16S 152JTH | J24189027 |       | 1-  | B    | d4      |
| R 1219 | CHIP RES.   | 2.2k  | 1/16W | 5%   | RMC1/16S 222JTH | J24189029 |       | 1-  | A    | I4      |
| R 1220 | CHIP RES.   | 1k    | 1/16W | 5%   | RMC1/16S 102JTH | J24189025 |       | 1-  | B    | e3      |
| R 1221 | CHIP RES.   | 10k   | 1/16W | 5%   | RMC1/16S 103JTH | J24189037 |       | 1-  | A    | E3      |
| R 1222 | CHIP RES.   | 0     | 1/16W | 5%   | RMC1/16 000JATP | J24185000 |       | 1-  | A    | B2      |
| R 1223 | CHIP RES.   | 1M    | 1/16W | 5%   | RMC1/16S 105JTH | J24189061 |       | 1-  | B    | d4      |
| R 1224 | CHIP RES.   | 330k  | 1/16W | 5%   | RMC1/16S 334JTH | J24189055 |       | 1-  | B    | i4      |
| R 1225 | CHIP RES.   | 1k    | 1/16W | 5%   | RMC1/16S 102JTH | J24189025 |       | 1-  | B    | b4      |
| R 1226 | CHIP RES.   | 220   | 1/16W | 5%   | RMC1/16S 221JTH | J24189017 |       | 5-  | B    | b4      |
| R 1227 | CHIP RES.   | 12k   | 1/16W | 5%   | RMC1/16S 123JTH | J24189038 |       | 1-  | B    | a4      |
| R 1228 | CHIP RES.   | 0     | 1/16W | 5%   | RMC1/16S JPTH   | J24189070 |       | 1-  | B    | d4      |
| R 1229 | CHIP RES.   | 100k  | 1/16W | 5%   | RMC1/16S 104JTH | J24189049 |       | 1-  | A    | I5      |
| R 1230 | CHIP RES.   | 100k  | 1/16W | 5%   | RMC1/16S 104JTH | J24189049 |       | 1-  | A    | I5      |
| R 1231 | CHIP RES.   | 15k   | 1/16W | 5%   | RMC1/16S 153JTH | J24189039 |       | 1-  | B    | j4      |
| R 1232 | CHIP RES.   | 22k   | 1/16W | 5%   | RMC1/16S 223JTH | J24189041 |       | 1-  | B    | j4      |
| R 1233 | CHIP RES.   | 4.7k  | 1/16W | 5%   | RMC1/16S 472JTH | J24189033 |       | 1-  | A    | F3      |
| R 1234 | CHIP RES.   | 82k   | 1/16W | 5%   | RMC1/16S 823JTH | J24189048 |       | 1-  | B    | i4      |
| R 1235 | CHIP RES.   | 0     | 1/16W | 5%   | RMC1/16 000JATP | J24185000 |       | 1-  | A    | B2      |
| R 1236 | CHIP RES.   | 6.8k  | 1/16W | 5%   | RMC1/16S 682JTH | J24189035 |       | 1-  | B    | b4      |
| R 1237 | CHIP RES.   | 22    | 1/16W | 5%   | RMC1/16S 220JTH | J24189005 |       | 1-  | B    | d3      |
| R 1238 | CHIP RES.   | 47k   | 1/16W | 5%   | RMC1/16S 473JTH | J24189045 |       | 1-  | A    | D3      |
| R 1239 | CHIP RES.   | 12k   | 1/16W | 5%   | RMC1/16S 123JTH | J24189038 |       | 1-  | B    | a4      |
| R 1240 | CHIP RES.   | 47k   | 1/16W | 5%   | RMC1/16S 473JTH | J24189045 |       | 1-  | B    | e4      |
| R 1243 | CHIP RES.   | 12k   | 1/16W | 5%   | RMC1/16S 123JTH | J24189038 |       | 1-  | B    | a4      |
| R 1244 | CHIP RES.   | 22k   | 1/16W | 5%   | RMC1/16S 223JTH | J24189041 |       | 1-  | B    | j4      |
| R 1245 | CHIP RES.   | 100k  | 1/16W | 5%   | RMC1/16S 104JTH | J24189049 |       | 1-  | B    | j4      |
| R 1246 | CHIP RES.   | 150k  | 1/16W | 5%   | RMC1/16S 154JTH | J24189051 |       | 1-  | B    | b4      |
| R 1247 | CHIP RES.   | 3.3k  | 1/16W | 5%   | RMC1/16S 332JTH | J24189031 |       | 1-  | A    | F3      |
| R 1248 | CHIP RES.   | 0     | 1/16W | 5%   | RMC1/16 000JATP | J24185000 |       | 1-  | A    | A2      |
| R 1249 | CHIP RES.   | 180k  | 1/16W | 5%   | RMC1/16S 184JTH | J24189052 |       | 1-  | B    | e4      |
| R 1250 | CHIP RES.   | 10k   | 1/16W | 5%   | RMC1/16S 103JTH | J24189037 |       | 1-  | B    | d4      |
| R 1251 | CHIP RES.   | 1k    | 1/16W | 5%   | RMC1/16S 102JTH | J24189025 |       | 1-  | B    | d3      |
| R 1252 | CHIP RES.   | 0     | 1/16W | 5%   | RMC1/16 000JATP | J24185000 |       | 1-  | A    | B1      |
| R 1253 | CHIP RES.   | 22    | 1/16W | 5%   | RMC1/16S 220JTH | J24189005 |       | 1-  | A    | I4      |
| R 1254 | CHIP RES.   | 470k  | 1/16W | 5%   | RMC1/16S 474JTH | J24189057 |       | 1-  | B    | j4      |
| R 1255 | CHIP RES.   | 470k  | 1/16W | 5%   | RMC1/16S 474JTH | J24189057 |       | 1-  | B    | j4      |
| R 1256 | CHIP RES.   | 12k   | 1/16W | 5%   | RMC1/16S 123JTH | J24189038 |       | 1-  | B    | a4      |
| R 1257 | CHIP RES.   | 0     | 1/16W | 5%   | RMC1/16S JPTH   | J24189070 |       | 1-  | A    | J5      |
| R 1257 | CHIP RES.   | 10k   | 1/16W | 5%   | RMC1/16S 103JTH | J24189037 |       | 5-  | A    | J5      |
| R 1258 | CHIP RES.   | 33k   | 1/16W | 5%   | RMC1/16S 333JTH | J24189043 |       | 1-  | A    | J5      |
| R 1259 | CHIP RES.   | 1M    | 1/16W | 5%   | RMC1/16S 105JTH | J24189061 |       | 1-  | A    | B4      |
| R 1260 | CHIP RES.   | 47k   | 1/16W | 5%   | RMC1/16S 473JTH | J24189045 |       | 1-  | B    | j4      |
| R 1261 | CHIP RES.   | 2.2k  | 1/16W | 5%   | RMC1/16S 222JTH | J24189029 |       | 1-  | B    | b4      |
| R 1261 | CHIP RES.   | 330   | 1/16W | 5%   | RMC1/16S 331JTH | J24189019 |       | 5-  | B    | b4      |
| R 1262 | CHIP RES.   | 47k   | 1/16W | 5%   | RMC1/16S 473JTH | J24189045 |       | 1-  | A    | B3      |
| R 1264 | CHIP RES.   | 0     | 1/16W | 5%   | RMC1/16 000JATP | J24185000 |       | 1-  | A    | A2      |
| R 1266 | CHIP RES.   | 47k   | 1/16W | 5%   | RMC1/16S 473JTH | J24189045 |       | 1-  | B    | d3      |
| R 1267 | CHIP RES.   | 180   | 1/16W | 5%   | RMC1/16S 181JTH | J24189016 |       | 1-  | B    | b5      |
| R 1267 | CHIP RES.   | 150   | 1/16W | 5%   | RMC1/16S 151JTH | J24189015 |       | 5-  | B    | b5      |
| R 1268 | CHIP RES.   | 22k   | 1/16W | 5%   | RMC1/16S 223JTH | J24189041 |       | 1-  | A    | I5      |
| R 1269 | CHIP RES.   | 0     | 1/16W | 5%   | RMC1/16 000JATP | J24185000 |       | 1-  | A    | B1      |
| R 1270 | CHIP RES.   | 22k   | 1/16W | 5%   | RMC1/16S 223JTH | J24189041 |       | 1-  | B    | j4      |
| R 1271 | CHIP RES.   | 47k   | 1/16W | 5%   | RMC1/16S 473JTH | J24189045 |       | 1-  | B    | i4      |

# MAIN Unit

## Parts List

| REF    | DESCRIPTION | VALUE | V/W   | TOL. | MFR'S DESIG     | VXSTD P/N | VERS.    | LOT | SIDE | LAY ADR |
|--------|-------------|-------|-------|------|-----------------|-----------|----------|-----|------|---------|
| R 1272 | CHIP RES.   | 47k   | 1/16W | 5%   | RMC1/16S 473JTH | J24189045 |          | 1-  | B    | i4      |
| R 1273 | CHIP RES.   | 15k   | 1/16W | 5%   | RMC1/16S 153JTH | J24189039 |          | 1-  | B    | j4      |
| R 1275 | CHIP RES.   | 390k  | 1/16W | 5%   | RMC1/16S 394JTH | J24189056 |          | 1-  | A    | l5      |
| R 1276 | CHIP RES.   | 1k    | 1/16W | 5%   | RMC1/16S 102JTH | J24189025 |          | 1-  | B    | j4      |
| R 1277 | CHIP RES.   | 22    | 1/16W | 5%   | RMC1/16S 220JTH | J24189005 |          | 1-  | B    | d4      |
| R 1279 | CHIP RES.   | 1k    | 1/16W | 5%   | RMC1/16S 102JTH | J24189025 |          | 1-  | A    | B4      |
| R 1280 | CHIP RES.   | 0     | 1/16W | 5%   | RMC1/16 000JATP | J24185000 |          | 1-  | A    | A1      |
| R 1281 | CHIP RES.   | 47k   | 1/16W | 5%   | RMC1/16S 473JTH | J24189045 |          | 1-  | A    | B4      |
| R 1282 | CHIP RES.   | 150k  | 1/16W | 5%   | RMC1/16S 154JTH | J24189051 |          | 1-  | B    | b5      |
| R 1282 | CHIP RES.   | 180k  | 1/16W | 5%   | RMC1/16S 184JTH | J24189052 |          | 5-  | B    | b5      |
| R 1283 | CHIP RES.   | 12k   | 1/16W | 5%   | RMC1/16S 123JTH | J24189038 |          | 1-  | B    | d4      |
| R 1284 | CHIP RES.   | 470   | 1/16W | 5%   | RMC1/16S 471JTH | J24189021 |          | 1-  | A    | B4      |
| R 1285 | CHIP RES.   | 10k   | 1/16W | 5%   | RMC1/16S 103JTH | J24189037 |          | 1-  | B    | d4      |
| R 1286 | CHIP RES.   | 470   | 1/16W | 5%   | RMC1/16S 471JTH | J24189021 |          | 1-  | A    | B4      |
| R 1288 | CHIP RES.   | 1k    | 1/16W | 5%   | RMC1/16S 102JTH | J24189025 |          | 1-  | B    | d3      |
| R 1289 | CHIP RES.   | 2.2k  | 1/16W | 5%   | RMC1/16S 222JTH | J24189029 |          | 1-  | B    | b5      |
| R 1290 | CHIP RES.   | 22    | 1/16W | 5%   | RMC1/16S 220JTH | J24189005 |          | 1-  | A    | G4      |
| R 1291 | CHIP RES.   | 1k    | 1/16W | 5%   | RMC1/16S 102JTH | J24189025 |          | 1-  | B    | d3      |
| R 1292 | CHIP RES.   | 1k    | 1/16W | 5%   | RMC1/16S 102JTH | J24189025 |          | 1-  | B    | i4      |
| R 1293 | CHIP RES.   | 1k    | 1/16W | 5%   | RMC1/16S 102JTH | J24189025 |          | 1-  | A    | B3      |
| R 1294 | CHIP RES.   | 1k    | 1/16W | 5%   | RMC1/16S 102JTH | J24189025 |          | 1-  | A    | B4      |
| R 1296 | CHIP RES.   | 4.7k  | 1/16W | 5%   | RMC1/16S 472JTH | J24189033 |          | 1-  | B    | d3      |
| R 1297 | CHIP RES.   | 0     | 1/16W | 5%   | RMC1/16 000JATP | J24185000 |          | 1-  | A    | B1      |
| R 1298 | CHIP RES.   | 15k   | 1/16W | 5%   | RMC1/16S 153JTH | J24189039 |          | 1-  | B    | c5      |
| R 1299 | CHIP RES.   | 5.6k  | 1/16W | 5%   | RMC1/16S 562JTH | J24189034 |          | 1-  | B    | c5      |
| R 1300 | CHIP RES.   | 33k   | 1/16W | 5%   | RMC1/16S 333JTH | J24189043 |          | 1-  | A    | l5      |
| R 1301 | CHIP RES.   | 6.8k  | 1/16W | 5%   | RMC1/16S 682JTH | J24189035 |          | 1-  | B    | c5      |
| R 1302 | CHIP RES.   | 10k   | 1/16W | 5%   | RMC1/16S 103JTH | J24189037 |          | 1-  | B    | b5      |
| R 1303 | CHIP RES.   | 47k   | 1/16W | 5%   | RMC1/16S 473JTH | J24189045 |          | 1-  | A    | l5      |
| R 1304 | CHIP RES.   | 680k  | 1/16W | 5%   | RMC1/16S 684JTH | J24189059 |          | 1-  | B    | c5      |
| R 1306 | CHIP RES.   | 220k  | 1/16W | 5%   | RMC1/16S 224JTH | J24189053 |          | 1-  | B    | c5      |
| R 1306 | CHIP RES.   | 82k   | 1/16W | 5%   | RMC1/16S 823JTH | J24189048 |          | 3-  | B    | c5      |
| R 1307 | CHIP RES.   | 100k  | 1/16W | 5%   | RMC1/16S 104JTH | J24189049 |          | 1-  | B    | b5      |
| R 1308 | CHIP RES.   | 100k  | 1/16W | 5%   | RMC1/16S 104JTH | J24189049 |          | 1-  | B    | c5      |
| R 1309 | CHIP RES.   | 1M    | 1/16W | 5%   | RMC1/16S 105JTH | J24189061 |          | 1-  | B    | b5      |
| R 1310 | CHIP RES.   | 5.6k  | 1/16W | 5%   | RMC1/16S 562JTH | J24189034 |          | 1-  | A    | l4      |
| R 1311 | CHIP RES.   | 680k  | 1/16W | 5%   | RMC1/16S 684JTH | J24189059 |          | 1-  | B    | c5      |
| R 1312 | CHIP RES.   | 680k  | 1/16W | 5%   | RMC1/16S 684JTH | J24189059 |          | 1-  | B    | b5      |
| R 1313 | CHIP RES.   | 100k  | 1/16W | 5%   | RMC1/16S 104JTH | J24189049 |          | 1-  | B    | c5      |
| R 1313 | CHIP RES.   | 470k  | 1/16W | 5%   | RMC1/16S 474JTH | J24189057 |          | 3-  | B    | c5      |
| R 1314 | CHIP RES.   | 27k   | 1/16W | 5%   | RMC1/16S 273JTH | J24189042 |          | 1-  | B    | c5      |
| R 1314 | CHIP RES.   | 68k   | 1/16W | 5%   | RMC1/16S 683JTH | J24189047 |          | 3-  | B    | c5      |
| R 1315 | CHIP RES.   | 1M    | 1/16W | 5%   | RMC1/16S 105JTH | J24189061 | CHINA    | 9-  | B    | g5      |
| R 1315 | CHIP RES.   | 1M    | 1/16W | 5%   | RMC1/16S 105JTH | J24189061 | VTX(USA) | 9-  | B    | g5      |
| R 1316 | CHIP RES.   | 27k   | 1/16W | 5%   | RMC1/16S 273JTH | J24189042 |          | 1-  | B    | c4      |
| R 1316 | CHIP RES.   | 220k  | 1/16W | 5%   | RMC1/16S 224JTH | J24189053 |          | 3-  | B    | c4      |
| R 1317 | CHIP RES.   | 0     | 1/16W | 5%   | RMC1/16 000JATP | J24185000 |          | 1-  | B    | i1      |
| R 1317 | CHIP RES.   | 330   | 1/16W | 5%   | RMC1/16S 331JTH | J24189019 |          | 8   | B    | i1      |
| R 1317 | CHIP RES.   | 1k    | 1/16W | 5%   | RMC1/16 102JATP | J24185102 |          | 9-  | B    | i1      |
| R 1318 | CHIP RES.   | 0     | 1/16W | 5%   | RMC1/16 000JATP | J24185000 |          | 1-  | A    | B2      |
| R 1319 | CHIP RES.   | 0     | 1/16W | 5%   | RMC1/16 000JATP | J24185000 |          | 1-  | A    | A1      |
| R 1320 | CHIP RES.   | 10k   | 1/16W | 5%   | RMC1/16S 103JTH | J24189037 |          | 1-  | A    | C4      |
| R 1321 | CHIP RES.   | 20k   | 1/16W | 0.5% | RR0510R-203-D   | J24189150 |          | 1-  | A    | C4      |
| R 1322 | CHIP RES.   | 39k   | 1/16W | 5%   | RMC1/16S 393JTH | J24189044 |          | 1-  | A    | C4      |
| R 1323 | CHIP RES.   | 82k   | 1/16W | 5%   | RMC1/16S 823JTH | J24189048 |          | 1-  | A    | C4      |
| R 1324 | CHIP RES.   | 0     | 1/16W | 5%   | RMC1/16S JPTH   | J24189070 |          | 1-  | A    | C3      |
| R 1325 | CHIP RES.   | 0     | 1/16W | 5%   | RMC1/16S JPTH   | J24189070 |          | 1-  | A    | C4      |
| R 1326 | CHIP RES.   | 10k   | 1/16W | 5%   | RMC1/16S 103JTH | J24189037 |          | 1-  | A    | C4      |
| R 1327 | CHIP RES.   | 20k   | 1/16W | 0.5% | RR0510R-203-D   | J24189150 |          | 1-  | A    | C4      |
| R 1328 | CHIP RES.   | 39k   | 1/16W | 5%   | RMC1/16S 393JTH | J24189044 |          | 1-  | A    | C4      |
| R 1329 | CHIP RES.   | 82k   | 1/16W | 5%   | RMC1/16S 823JTH | J24189048 |          | 1-  | A    | C4      |
| R 1330 | CHIP RES.   | 0     | 1/16W | 5%   | RMC1/16 000JATP | J24185000 |          | 1-  | A    | B2      |
| R 1331 | CHIP RES.   | 47k   | 1/16W | 5%   | RMC1/16S 473JTH | J24189045 |          | 1-  | A    | G5      |
| R 1333 | CHIP RES.   | 47k   | 1/16W | 5%   | RMC1/16S 473JTH | J24189045 | CHINA    | 9-  | B    | f5      |
| R 1333 | CHIP RES.   | 47k   | 1/16W | 5%   | RMC1/16S 473JTH | J24189045 | VTX(USA) | 9-  | B    | f5      |
| R 1334 | CHIP RES.   | 2.2k  | 1/16W | 5%   | RMC1/16S 222JTH | J24189029 |          | 1-  | A    | A5      |
| R 1335 | CHIP RES.   | 47k   | 1/16W | 5%   | RMC1/16S 473JTH | J24189045 |          | 1-  | B    | j1      |
| R 1338 | CHIP RES.   | 47k   | 1/16W | 5%   | RMC1/16S 473JTH | J24189045 |          | 1-  | A    | l5      |
| R 1339 | CHIP RES.   | 1M    | 1/16W | 5%   | RMC1/16S 105JTH | J24189061 |          | 1-  | A    | F4      |
| R 1340 | CHIP RES.   | 1M    | 1/16W | 5%   | RMC1/16S 105JTH | J24189061 |          | 1-  | A    | E3      |
| R 1343 | CHIP RES.   | 0     | 1/16W | 5%   | RMC1/16S JPTH   | J24189070 |          | 1-4 |      |         |
| R 1347 | CHIP RES.   | 100k  | 1/16W | 5%   | RMC1/16S 104JTH | J24189049 |          | 5-  | A    | E4      |
| R 1348 | CHIP RES.   | 33k   | 1/16W | 5%   | RMC1/16S 333JTH | J24189043 |          | 5-  | A    | H5      |

# MAIN Unit

## Parts List

| REF    | DESCRIPTION   | VALUE       | V/W   | TOL. | MFR'S DESIG        | VXSTD P/N | VERS.    | LOT | SIDE | LAY ADR |
|--------|---------------|-------------|-------|------|--------------------|-----------|----------|-----|------|---------|
| R 1349 | CHIP RES.     | 68k         | 1/16W | 5%   | RMC1/16S 683JTH    | J24189047 |          | 5-  | A    | H5      |
| R 1352 | CHIP RES.     | 330         | 1/16W | 5%   | RMC1/16S 331JTH    | J24189019 |          | 9-  | B    | i1      |
| R 1353 | CHIP RES.     | 330         | 1/16W | 5%   | RMC1/16S 331JTH    | J24189019 |          | 9-  | B    | j1      |
| SC1001 | SHIELD CASE   |             |       |      | (VCO)              | RA0790400 |          | 1-  |      |         |
| TH1001 | THERMISTOR    |             |       |      | ERTJ0EV473J        | G9090120  |          | 1-  | B    | e2      |
| TH1002 | THERMISTOR    |             |       |      | ERTJ0EV473J        | G9090120  |          | 1-  | B    | c5      |
| VR1001 | POT.          |             |       |      | RK0971111 20KA/SW  | J60800256 |          | 1-  | A    | A5      |
| X 1001 | XTAL HC-49SMD | 11.0592MHz  |       |      | FYSMD110592        | H0103318  |          | 1-  | A    | A4      |
| X 1002 | XTAL OSC      | 16.8MHz     |       |      | TTS05VS-P2 16.8MHZ | H9500760  |          | 1-  | A    | G4      |
| X 1003 | XTAL U3B      | 4.194304MHz |       |      | 4.194304MHZ        | H0103284  | CHINA    | 9-  | B    | g5      |
| X 1003 | XTAL U3B      | 4.194304MHz |       |      | 4.194304MHZ        | H0103284  | VTX(USA) | 9-  | B    | g5      |
| XF1001 | XTAL FILTER   |             |       |      | TF4-67EA1 67.65MHZ | H1102399  |          | 1-  | A    | H4      |
|        | LEAF SPRING   |             |       |      |                    | RA0824400 |          | 1-  |      |         |
|        | GROUND PLATE  |             |       |      | (L=10)             | RA0337900 | 25W      | 9-  |      |         |
|        | GASKET        |             |       |      |                    | RA0896300 | 25W      | 9-  |      |         |

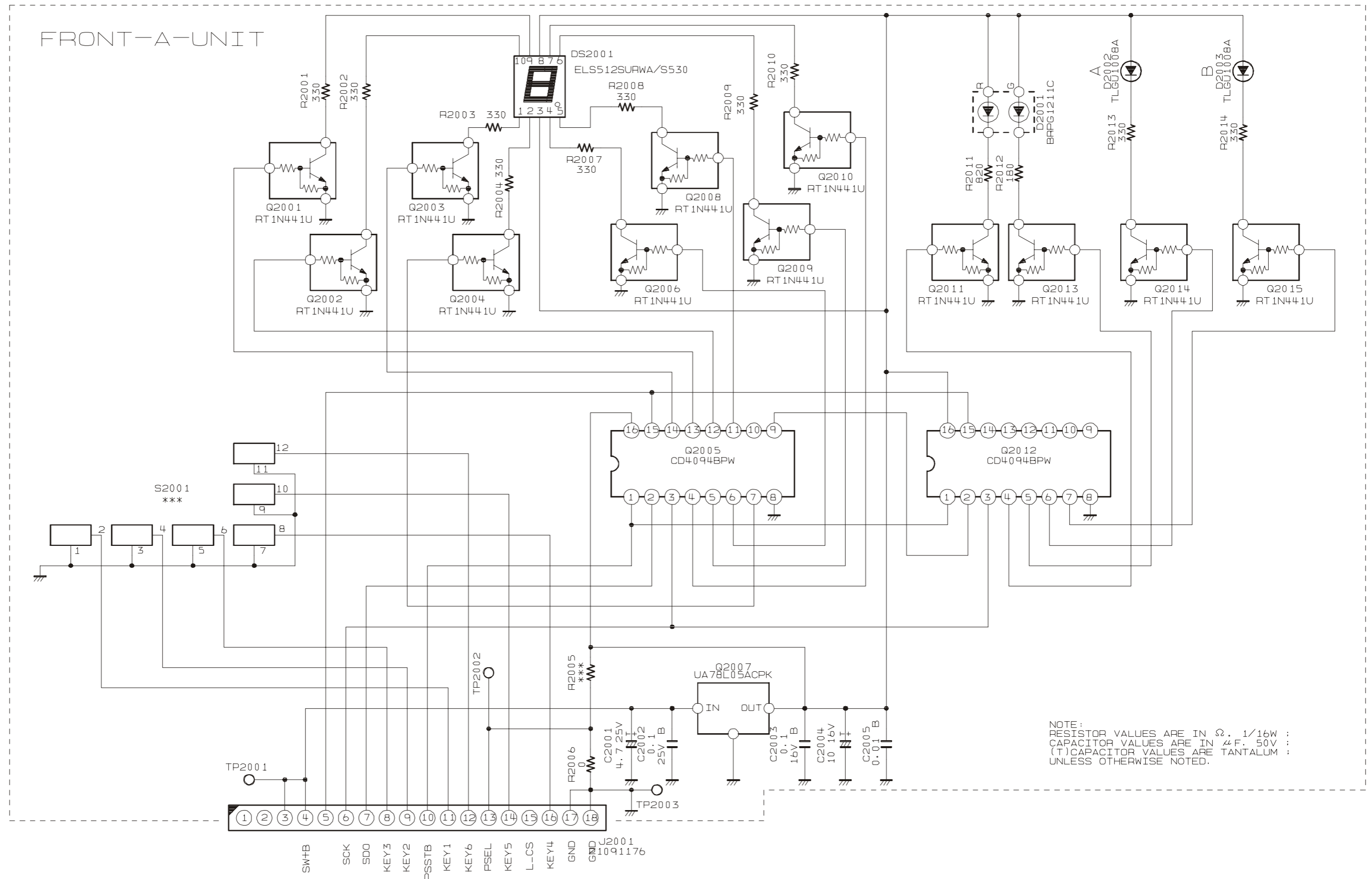

NOTE:  
 RESISTOR VALUES ARE IN Ω. 1/16W ;  
 CAPACITOR VALUES ARE IN μF. 50V ;  
 (T)CAPACITOR VALUES ARE TANTALUM ;  
 UNLESS OTHERWISE NOTED.



# FRONT-A Unit (VX-2100)

## Parts List

| REF                   | DESCRIPTION  | VALUE  | V/W   | TOL. | MFR'S DESIG          | VXSTD P/N | VERS. | LOT | SIDE | LAY ADR |
|-----------------------|--------------|--------|-------|------|----------------------|-----------|-------|-----|------|---------|
| PCB with Components   |              |        |       |      |                      | CB3472001 |       |     |      |         |
| Printed Circuit Board |              |        |       |      |                      | FR014510B |       | 1-  |      |         |
| C 2001                | CHIP TA.CAP. | 4.7uF  | 25V   |      | TEMSVB21E475M-8R     | K78140019 |       | 1-  | B    | e2      |
| C 2002                | CHIP CAP.    | 0.1uF  | 25V   | B    | GRM40B104M25PT       | K22140811 |       | 1-  | B    | e2      |
| C 2003                | CHIP CAP.    | 0.1uF  | 16V   | B    | GRM188B11C104KA01D   | K22124805 |       | 1-  | B    | e2      |
| C 2004                | CHIP TA.CAP. | 10uF   | 16V   |      | TEMSVB21C106M-8R     | K78120025 |       | 1-  | B    | e2      |
| C 2005                | CHIP CAP.    | 0.01uF | 50V   | B    | GRM188B11H103KA01D   | K22174823 |       | 1-  | B    | e2      |
| D 2001                | LED          |        |       |      | BRPG1211C-TR         | G2070654  |       | 1-  | A    | B1      |
| D 2002                | LED          |        |       |      | TLGU1008A(TAPE)      | G2070956  |       | 1-  | A    | B1      |
| D 2003                | LED          |        |       |      | TLGU1008A(TAPE)      | G2070956  |       | 1-  | A    | C1      |
| DS2001                | LED          |        |       |      | ELS-512SURWA/S530-A3 | G2090796  |       | 1-  | A    | D1      |
| J 2001                | CONNECTOR    |        |       |      | 18FLT-SM1-TB         | P1091176  |       | 1-  | B    | e1      |
| Q 2001                | TRANSISTOR   |        |       |      | RT1N441U-T11-1       | G3070247  |       | 1-  | B    | b1      |
| Q 2002                | TRANSISTOR   |        |       |      | RT1N441U-T11-1       | G3070247  |       | 1-  | B    | c1      |
| Q 2003                | TRANSISTOR   |        |       |      | RT1N441U-T11-1       | G3070247  |       | 1-  | B    | c2      |
| Q 2004                | TRANSISTOR   |        |       |      | RT1N441U-T11-1       | G3070247  |       | 1-  | B    | b2      |
| Q 2005                | IC           |        |       |      | CD4094BPWR           | G1093866  |       | 1-  | B    | b1      |
| Q 2006                | TRANSISTOR   |        |       |      | RT1N441U-T11-1       | G3070247  |       | 1-  | B    | b2      |
| Q 2007                | IC           |        |       |      | UA78L05ACPK          | G1094156  |       | 1-  | B    | e2      |
| Q 2008                | TRANSISTOR   |        |       |      | RT1N441U-T11-1       | G3070247  |       | 1-  | B    | b2      |
| Q 2009                | TRANSISTOR   |        |       |      | RT1N441U-T11-1       | G3070247  |       | 1-  | B    | b1      |
| Q 2010                | TRANSISTOR   |        |       |      | RT1N441U-T11-1       | G3070247  |       | 1-  | B    | b1      |
| Q 2011                | TRANSISTOR   |        |       |      | RT1N441U-T11-1       | G3070247  |       | 1-  | A    | B2      |
| Q 2012                | IC           |        |       |      | CD4094BPWR           | G1093866  |       | 1-  | B    | d2      |
| Q 2013                | TRANSISTOR   |        |       |      | RT1N441U-T11-1       | G3070247  |       | 1-  | A    | B2      |
| Q 2014                | TRANSISTOR   |        |       |      | RT1N441U-T11-1       | G3070247  |       | 1-  | A    | C1      |
| Q 2015                | TRANSISTOR   |        |       |      | RT1N441U-T11-1       | G3070247  |       | 1-  | A    | C2      |
| R 2001                | CHIP RES.    | 330    | 1/16W | 5%   | RMC1/16S 331JTH      | J24189019 |       | 1-  | B    | c1      |
| R 2002                | CHIP RES.    | 330    | 1/16W | 5%   | RMC1/16S 331JTH      | J24189019 |       | 1-  | B    | c1      |
| R 2003                | CHIP RES.    | 330    | 1/16W | 5%   | RMC1/16S 331JTH      | J24189019 |       | 1-  | B    | c2      |
| R 2004                | CHIP RES.    | 330    | 1/16W | 5%   | RMC1/16S 331JTH      | J24189019 |       | 1-  | B    | c2      |
| R 2006                | CHIP RES.    | 0      | 1/16W | 5%   | RMC1/16S JPTH        | J24189070 |       | 1-  | B    | f1      |
| R 2007                | CHIP RES.    | 330    | 1/16W | 5%   | RMC1/16S 331JTH      | J24189019 |       | 1-  | B    | c2      |
| R 2008                | CHIP RES.    | 330    | 1/16W | 5%   | RMC1/16S 331JTH      | J24189019 |       | 1-  | B    | b2      |
| R 2009                | CHIP RES.    | 330    | 1/16W | 5%   | RMC1/16S 331JTH      | J24189019 |       | 1-  | B    | b1      |
| R 2010                | CHIP RES.    | 330    | 1/16W | 5%   | RMC1/16S 331JTH      | J24189019 |       | 1-  | B    | c1      |
| R 2011                | CHIP RES.    | 820    | 1/16W | 5%   | RMC1/16S 821JTH      | J24189024 |       | 1-  | A    | B2      |
| R 2012                | CHIP RES.    | 180    | 1/16W | 5%   | RMC1/16S 181JTH      | J24189016 |       | 1-  | A    | B2      |
| R 2013                | CHIP RES.    | 330    | 1/16W | 5%   | RMC1/16S 331JTH      | J24189019 |       | 1-  | A    | C1      |
| R 2014                | CHIP RES.    | 330    | 1/16W | 5%   | RMC1/16S 331JTH      | J24189019 |       | 1-  | A    | C2      |
|                       | HOLDER       |        |       |      | (LG)                 | RA0787500 |       | 1-  |      |         |
|                       | HOLDER       |        |       |      | (LG)                 | RA078750A |       | 5-  |      |         |
|                       | LIGHT GUIDE  |        |       |      | (8ch)                | RA0787600 |       | 1-  |      |         |

# *FRONT-A Unit (VX-2100)*

*Note*



# FRONT-B Unit (VX-2200)

## Circuit Diagram

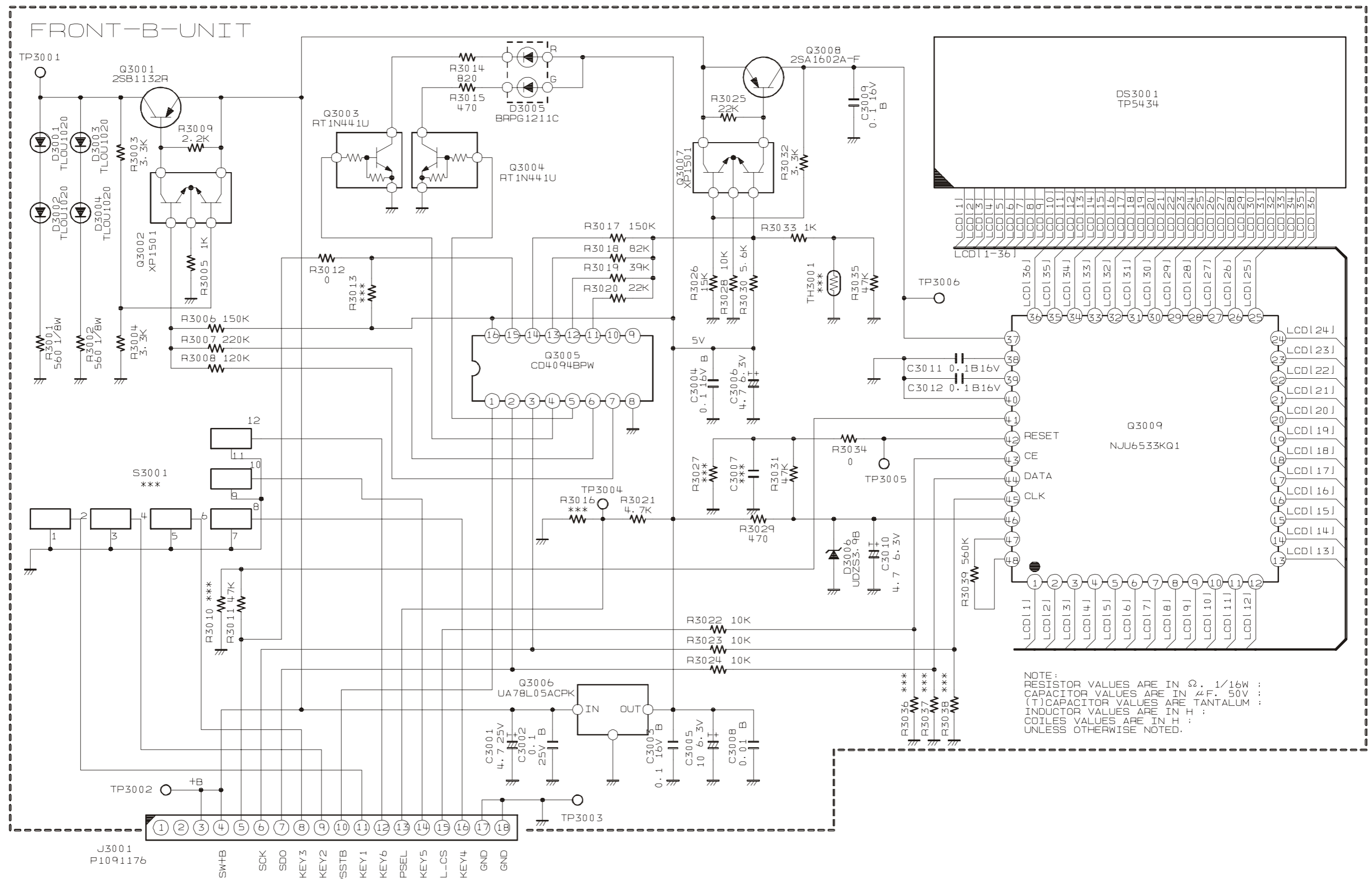

NOTE:  
 RESISTOR VALUES ARE IN Ω. 1/16W ;  
 CAPACITOR VALUES ARE IN μF. 50V ;  
 (T)CAPACITOR VALUES ARE TANTALUM ;  
 INDUCTOR VALUES ARE IN H ;  
 COILS VALUES ARE IN H ;  
 UNLESS OTHERWISE NOTED.

# FRONT-B Unit (VX-2200)

## Parts Layout (Side A)

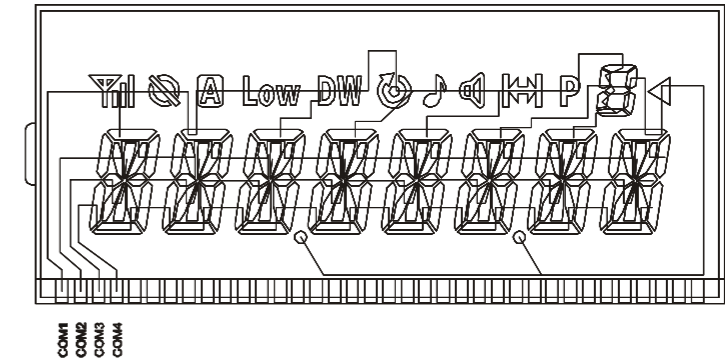
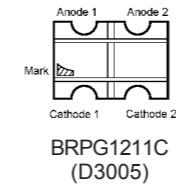
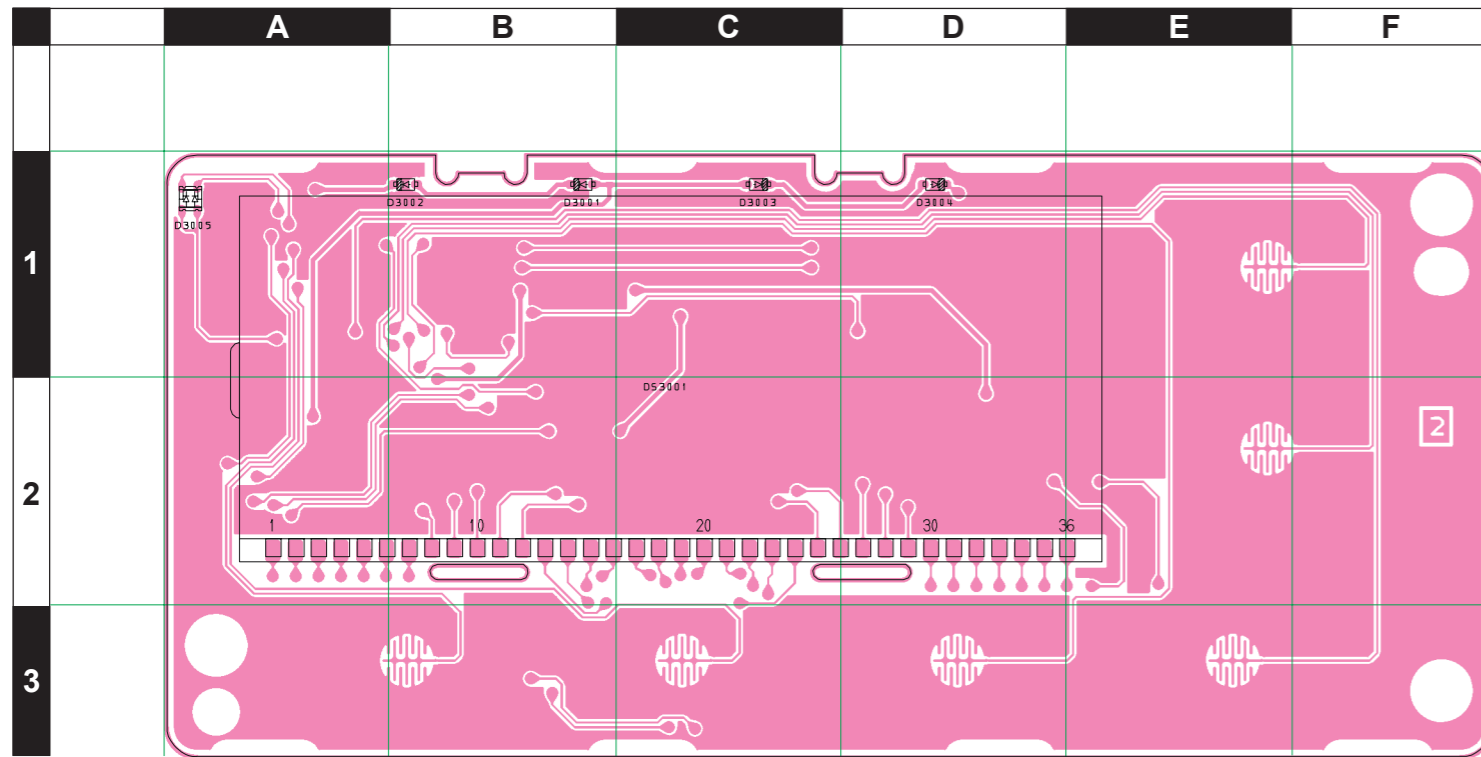

comment

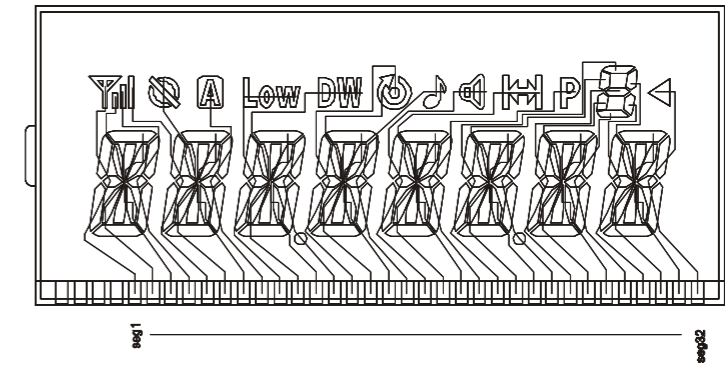

segment

LCD  
(DS3001)

## Parts Layout (Side B)

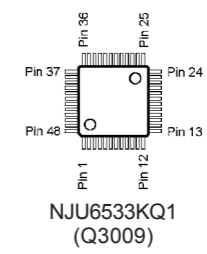
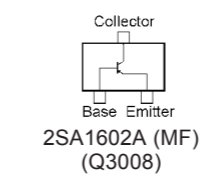
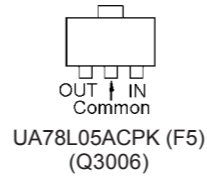
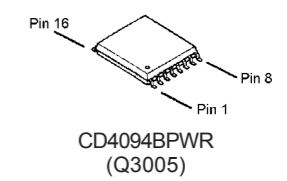
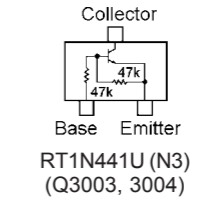
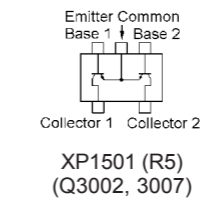
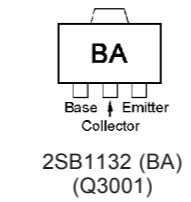
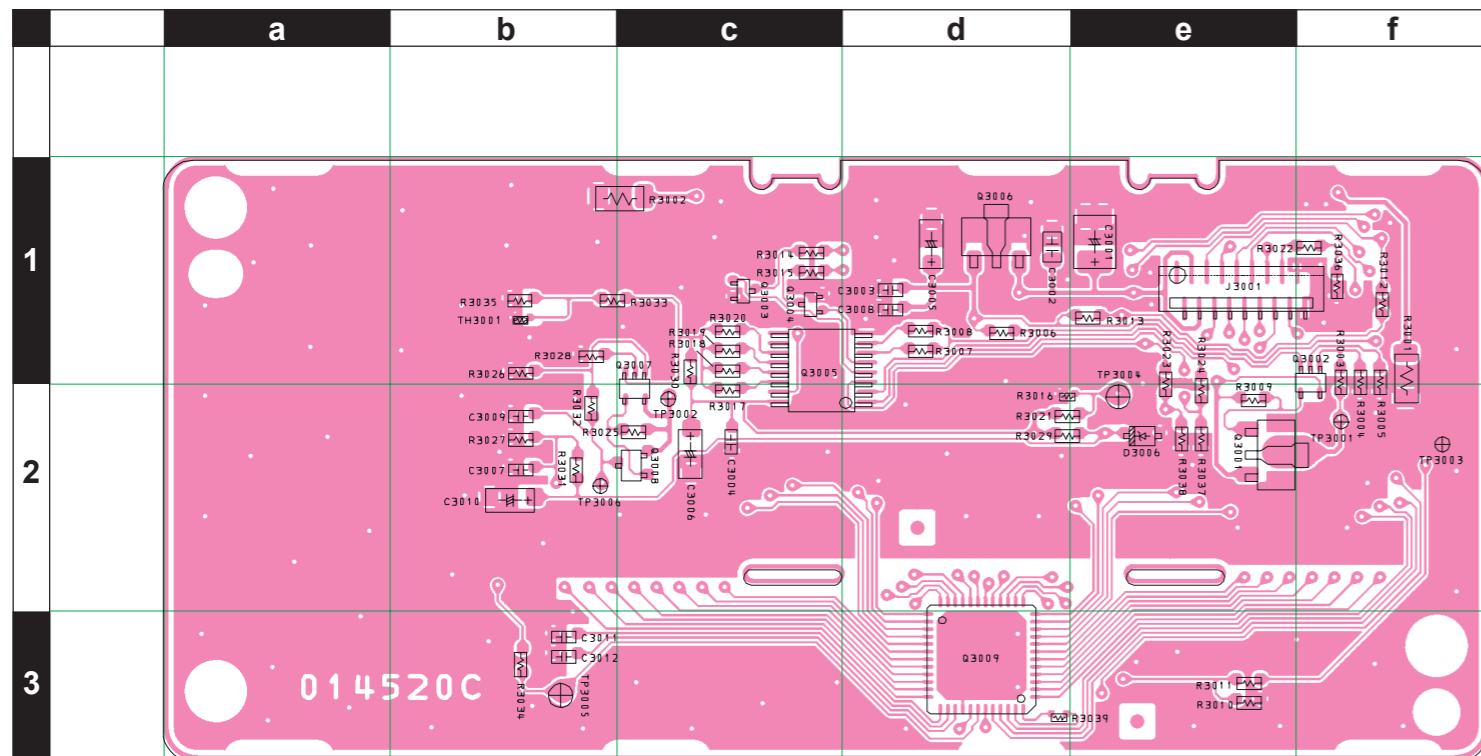

# FRONT-B Unit (VX-2200)

## Parts List

| REF                   | DESCRIPTION     | VALUE  | V/W   | TOL. | MFR'S DESIG        | VXSTD P/N | VERS. | LOT | SIDE | LAY ADR |
|-----------------------|-----------------|--------|-------|------|--------------------|-----------|-------|-----|------|---------|
| PCB with Components   |                 |        |       |      |                    | CB3473001 |       |     |      |         |
| Printed Circuit Board |                 |        |       |      |                    | FR014520C |       | 1-  |      |         |
| C 3001                | CHIP TA.CAP.    | 4.7uF  | 25V   |      | TEMSVB21E475M-8R   | K78140019 |       | 1-  | B    | e1      |
| C 3002                | CHIP CAP.       | 0.1uF  | 25V   | B    | GRM40B104M25PT     | K22140811 |       | 1-  | B    | d1      |
| C 3003                | CHIP CAP.       | 0.1uF  | 16V   | B    | GRM188B11C104KA01D | K22124805 |       | 1-  | B    | d1      |
| C 3004                | CHIP CAP.       | 0.1uF  | 16V   | B    | GRM188B11C104KA01D | K22124805 |       | 1-  | B    | c2      |
| C 3005                | CHIP TA.CAP.    | 10uF   | 6.3V  |      | TEMSVA0J106M-8R    | K78080027 |       | 1-  | B    | d1      |
| C 3006                | CHIP TA.CAP.    | 4.7uF  | 6.3V  |      | TEMSVA0J475M-8R    | K78080017 |       | 1-  | B    | c2      |
| C 3008                | CHIP CAP.       | 0.01uF | 50V   | B    | GRM188B11H103KA01D | K22174823 |       | 1-  | B    | d1      |
| C 3009                | CHIP CAP.       | 0.1uF  | 16V   | B    | GRM188B11C104KA01D | K22124805 |       | 1-  | B    | b2      |
| C 3010                | CHIP TA.CAP.    | 4.7uF  | 6.3V  |      | TEMSVA0J475M-8R    | K78080017 |       | 1-  | B    | b2      |
| C 3011                | CHIP CAP.       | 0.1uF  | 16V   | B    | GRM188B11C104KA01D | K22124805 |       | 1-  | B    | b3      |
| C 3012                | CHIP CAP.       | 0.1uF  | 16V   | B    | GRM188B11C104KA01D | K22124805 |       | 1-  | B    | b3      |
| D 3001                | LED             |        |       |      | TLOU1020(T14.F)    | G2070990  |       | 1-  | A    | B1      |
| D 3002                | LED             |        |       |      | TLOU1020(T14.F)    | G2070990  |       | 1-  | A    | B1      |
| D 3003                | LED             |        |       |      | TLOU1020(T14.F)    | G2070990  |       | 1-  | A    | C1      |
| D 3004                | LED             |        |       |      | TLOU1020(T14.F)    | G2070990  |       | 1-  | A    | D1      |
| D 3005                | LED             |        |       |      | BRPG1211C-TR       | G2070654  |       | 1-  | A    | A1      |
| D 3006                | DIODE           |        |       |      | UDZS TE-17 3.9B    | G2070906  |       | 1-  | B    | e2      |
| DS3001                | LCD             |        |       |      | TP5434 (AC061)     | G6090173  |       | 1-  | A    | C2      |
| J 3001                | CONNECTOR       |        |       |      | 18FLT-SM1-TB       | P1091176  |       | 1-  | B    | e1      |
| Q 3001                | TRANSISTOR      |        |       |      | 2SB1132 T100 R     | G3211327R |       | 1-  | B    | e2      |
| Q 3002                | TRANSISTOR      |        |       |      | XP1501-(TX)        | G3070143  |       | 1-  | B    | f1      |
| Q 3003                | TRANSISTOR      |        |       |      | RT1N441U-T11-1     | G3070247  |       | 1-  | B    | c1      |
| Q 3004                | TRANSISTOR      |        |       |      | RT1N441U-T11-1     | G3070247  |       | 1-  | B    | c1      |
| Q 3005                | IC              |        |       |      | CD4094BPWR         | G1093866  |       | 1-  | B    | c1      |
| Q 3006                | IC              |        |       |      | UA78L05ACPK        | G1094156  |       | 1-  | B    | d1      |
| Q 3007                | TRANSISTOR      |        |       |      | XP1501-(TX)        | G3070143  |       | 1-  | B    | c2      |
| Q 3008                | TRANSISTOR      |        |       |      | 2SA1602A-T11-1F    | G3116028F |       | 1-  | B    | c2      |
| Q 3009                | IC              |        |       |      | NJU6533KQ1         | G1094259  |       | 1-  | B    | d3      |
| R 3001                | CHIP RES.       | 560    | 1/8W  | 5%   | RMC1/8T 561J       | J24215561 |       | 1-  | B    | f1      |
| R 3002                | CHIP RES.       | 560    | 1/8W  | 5%   | RMC1/8T 561J       | J24215561 |       | 1-  | B    | c1      |
| R 3003                | CHIP RES.       | 3.3k   | 1/16W | 5%   | RMC1/16 332JATP    | J24185332 |       | 1-  | B    | f1      |
| R 3004                | CHIP RES.       | 3.3k   | 1/16W | 5%   | RMC1/16 332JATP    | J24185332 |       | 1-  | B    | f1      |
| R 3005                | CHIP RES.       | 1k     | 1/16W | 5%   | RMC1/16 102JATP    | J24185102 |       | 1-  | B    | f1      |
| R 3006                | CHIP RES.       | 150k   | 1/16W | 5%   | RMC1/16 154JATP    | J24185154 |       | 1-  | B    | d1      |
| R 3007                | CHIP RES.       | 220k   | 1/16W | 5%   | RMC1/16 224JATP    | J24185224 |       | 1-  | B    | d1      |
| R 3008                | CHIP RES.       | 120k   | 1/16W | 5%   | RMC1/16 124JATP    | J24185124 |       | 1-  | B    | d1      |
| R 3009                | CHIP RES.       | 2.2k   | 1/16W | 5%   | RMC1/16 222JATP    | J24185222 |       | 1-  | B    | e2      |
| R 3011                | CHIP RES.       | 47k    | 1/16W | 5%   | RMC1/16 473JATP    | J24185473 |       | 1-  | B    | e3      |
| R 3012                | CHIP RES.       | 0      | 1/16W | 5%   | RMC1/16 000JATP    | J24185000 |       | 1-  | B    | f1      |
| R 3014                | CHIP RES.       | 820    | 1/16W | 5%   | RMC1/16 821JATP    | J24185821 |       | 1-  | B    | c1      |
| R 3015                | CHIP RES.       | 470    | 1/16W | 5%   | RMC1/16 471JATP    | J24185471 |       | 1-  | B    | c1      |
| R 3017                | CHIP RES.       | 150k   | 1/16W | 5%   | RMC1/16 154JATP    | J24185154 |       | 1-  | B    | c2      |
| R 3018                | CHIP RES.       | 82k    | 1/16W | 5%   | RMC1/16 823JATP    | J24185823 |       | 1-  | B    | c1      |
| R 3019                | CHIP RES.       | 39k    | 1/16W | 5%   | RMC1/16 393JATP    | J24185393 |       | 1-  | B    | c1      |
| R 3020                | CHIP RES.       | 22k    | 1/16W | 5%   | RMC1/16 223JATP    | J24185223 |       | 1-  | B    | c1      |
| R 3021                | CHIP RES.       | 4.7k   | 1/16W | 5%   | RMC1/16 472JATP    | J24185472 |       | 1-  | B    | d2      |
| R 3022                | CHIP RES.       | 10k    | 1/16W | 5%   | RMC1/16 103JATP    | J24185103 |       | 1-  | B    | f1      |
| R 3023                | CHIP RES.       | 10k    | 1/16W | 5%   | RMC1/16 103JATP    | J24185103 |       | 1-  | B    | e2      |
| R 3024                | CHIP RES.       | 10k    | 1/16W | 5%   | RMC1/16 103JATP    | J24185103 |       | 1-  | B    | e2      |
| R 3025                | CHIP RES.       | 22k    | 1/16W | 5%   | RMC1/16 223JATP    | J24185223 |       | 1-  | B    | c2      |
| R 3026                | CHIP RES.       | 15k    | 1/16W | 5%   | RMC1/16 153JATP    | J24185153 |       | 1-  | B    | b1      |
| R 3028                | CHIP RES.       | 10k    | 1/16W | 5%   | RMC1/16 103JATP    | J24185103 |       | 1-  | B    | b1      |
| R 3029                | CHIP RES.       | 470    | 1/16W | 5%   | RMC1/16 471JATP    | J24185471 |       | 1-  | B    | d2      |
| R 3030                | CHIP RES.       | 5.6k   | 1/16W | 5%   | RMC1/16 562JATP    | J24185562 |       | 1-  | B    | c1      |
| R 3031                | CHIP RES.       | 47k    | 1/16W | 5%   | RMC1/16 473JATP    | J24185473 |       | 1-  | B    | b2      |
| R 3032                | CHIP RES.       | 3.3k   | 1/16W | 5%   | RMC1/16 332JATP    | J24185332 |       | 1-  | B    | b2      |
| R 3033                | CHIP RES.       | 1k     | 1/16W | 5%   | RMC1/16 102JATP    | J24185102 |       | 1-  | B    | b1      |
| R 3034                | CHIP RES.       | 0      | 1/16W | 5%   | RMC1/16 000JATP    | J24185000 |       | 1-  | B    | b3      |
| R 3035                | CHIP RES.       | 47k    | 1/16W | 5%   | RMC1/16 473JATP    | J24185473 |       | 1-  | B    | b1      |
| R 3039                | CHIP RES.       | 560k   | 1/16W | 5%   | RMC1/16S 564JTH    | J24189058 |       | 1-  | B    | d3      |
|                       | LCD HOLDER      |        |       |      | (LCD)              | RA0786300 |       | 1-  |      |         |
|                       | SPONGE RUBBER   |        |       |      | (LCD)              | RA0786900 |       | 1-  |      |         |
|                       | LIGHT GUIDE     |        |       |      |                    | RA078640A |       | 1-  |      |         |
|                       | REFLECTOR SHEET |        |       |      |                    | RA0790900 |       | 1-  |      |         |
|                       | INTERCONNECTOR  |        |       |      |                    | RA0786200 |       | 1-  |      |         |

# ***FRONT-B Unit (VX-2200)***

***Note:***



# FVP-25 Encryption/DTMF Pager Unit (Option)

## Parts List

| REF                   | DESCRIPTION      | VALUE       | V/W   | TOL. | MFR'S DESIG        | VXSTD P/N | VERS. | LOT  | SIDE | LAY ADR |
|-----------------------|------------------|-------------|-------|------|--------------------|-----------|-------|------|------|---------|
| Printed Circuit Board |                  |             |       |      |                    | FR005010F |       |      |      |         |
| C 1001                | CHIP CAP.        | 0.1uF       | 16V   | B    | GRM188B11C104KA01D | K22124805 |       | 1-   |      |         |
| C 1002                | CHIP CAP.        | 0.01uF      | 25V   | B    | GRM39B103M25PT     | K22144802 |       | 1-   |      |         |
| C 1003                | CHIP CAP.        | 10pF        | 50V   | CH   | GRM1882C1H100JA01D | K22174211 |       | 1-   |      |         |
| C 1004                | CHIP CAP.        | 10pF        | 50V   | CH   | GRM1882C1H100JA01D | K22174211 |       | 1-   |      |         |
| C 1005                | CHIP CAP.        | 0.1uF       | 16V   | B    | GRM188B11C104KA01D | K22124805 |       | 1-   |      |         |
| C 1007                | CHIP CAP.        | 0.1uF       | 16V   | B    | GRM188B11C104KA01D | K22124805 |       | 1-   |      |         |
| C 1007                | CHIP CAP.        | 0.01uF      | 25V   | B    | GRM39B103M25PT     | K22144802 |       | 32-  |      |         |
| C 1008                | CHIP CAP.        | 0.1uF       | 16V   | B    | GRM188B11C104KA01D | K22124805 |       | 1-   |      |         |
| C 1009                | CHIP CAP.        | 68pF        | 50V   | CH   | GRM1882C1H680JA01D | K22174231 |       | 1-   |      |         |
| C 1010                | CHIP CAP.        | 390pF       | 50V   | CH   | GRM1882C1H391JA01D | K22174255 |       | 1-   |      |         |
| C 1011                | CHIP CAP.        | 0.001uF     | 50V   | B    | GRM188B11H102KA01D | K22174821 |       | 1-   |      |         |
| C 1012                | CHIP TA.CAP.     | 4.7uF       | 6.3V  |      | TEMSVA0J475M-8R    | K78080017 |       | 1-   |      |         |
| C 1013                | CHIP CAP.        | 0.022uF     | 25V   | B    | GRM39B223K25PT     | K22144807 |       | 1-   |      |         |
| C 1014                | CHIP CAP.        | 0.1uF       | 16V   | B    | GRM188B11C104KA01D | K22124805 |       | 1-   |      |         |
| D 1001                | DIODE            |             |       |      | 1SS355 TE-17       | G2070470  |       | 1-   |      |         |
| D 1002                | DIODE            |             |       |      | 1SS355 TE-17       | G2070470  |       | 1-   |      |         |
| J 1001                | CONNECTOR        |             |       |      | AXK5S40035P        | P1091012  |       | 1-   |      |         |
| Q 1001                | IC               |             |       |      | M64026FP-650C      | G1092754  |       | 1-   |      |         |
| Q 1002                | IC               |             |       |      | LC73881M-TLM       | G1092755  |       | 1-   |      |         |
| Q 1003                | TRANSISTOR       |             |       |      | DTC144EUA T106     | G3070041  |       | 1-13 |      |         |
| R 1001                | CHIP RES.        | 47k         | 1/16W | 5%   | RMC1/16 473JATP    | J24185473 |       | 1-   |      |         |
| R 1002                | CHIP RES.        | 1M          | 1/16W | 5%   | RMC1/16 105JATP    | J24185105 |       | 1-   |      |         |
| R 1003                | CHIP RES.        | 22k         | 1/16W | 5%   | RMC1/16 223JATP    | J24185223 |       | 1-   |      |         |
| R 1004                | CHIP RES.        | 680k        | 1/16W | 5%   | RMC1/16 684JATP    | J24185684 |       | 1-   |      |         |
| R 1006                | CHIP RES.        | 150k        | 1/16W | 5%   | RMC1/16 154JATP    | J24185154 |       | 1-   |      |         |
| R 1007                | CHIP RES.        | 47k         | 1/16W | 5%   | RMC1/16 473JATP    | J24185473 |       | 1-   |      |         |
| R 1008                | CHIP RES.        | 10k         | 1/16W | 5%   | RMC1/16 103JATP    | J24185103 |       | 1-   |      |         |
| R 1008                | CARBON FILM RES. | 22k         | 1/8W  | 5%   | RD18TJ223 22K      | J01215223 |       | 14-  |      |         |
| R 1008                | CHIP RES.        | 22k         | 1/16W | 5%   | RMC1/16 223JATP    | J24185223 |       | 17-  |      |         |
| R 1009                | CHIP RES.        | 3.3M        | 1/16W | 5%   | RMC1/16 335JATP    | J24185335 |       | 68-  |      |         |
| X 1001                | XTAL SX-1315     | 3.6263MHz   |       |      | 3.6263MHZ          | H0103183  |       | 1-   |      |         |
| X 1002                | XTAL SX-1315     | 4.194304MHz |       |      | 4.194304MHZ        | H0103184  |       | 1-   |      |         |

# FVP-36 Voice Inversion Type Encryption Unit (Option)

## Circuit Diagram

DTMF-UNIT BR005010F

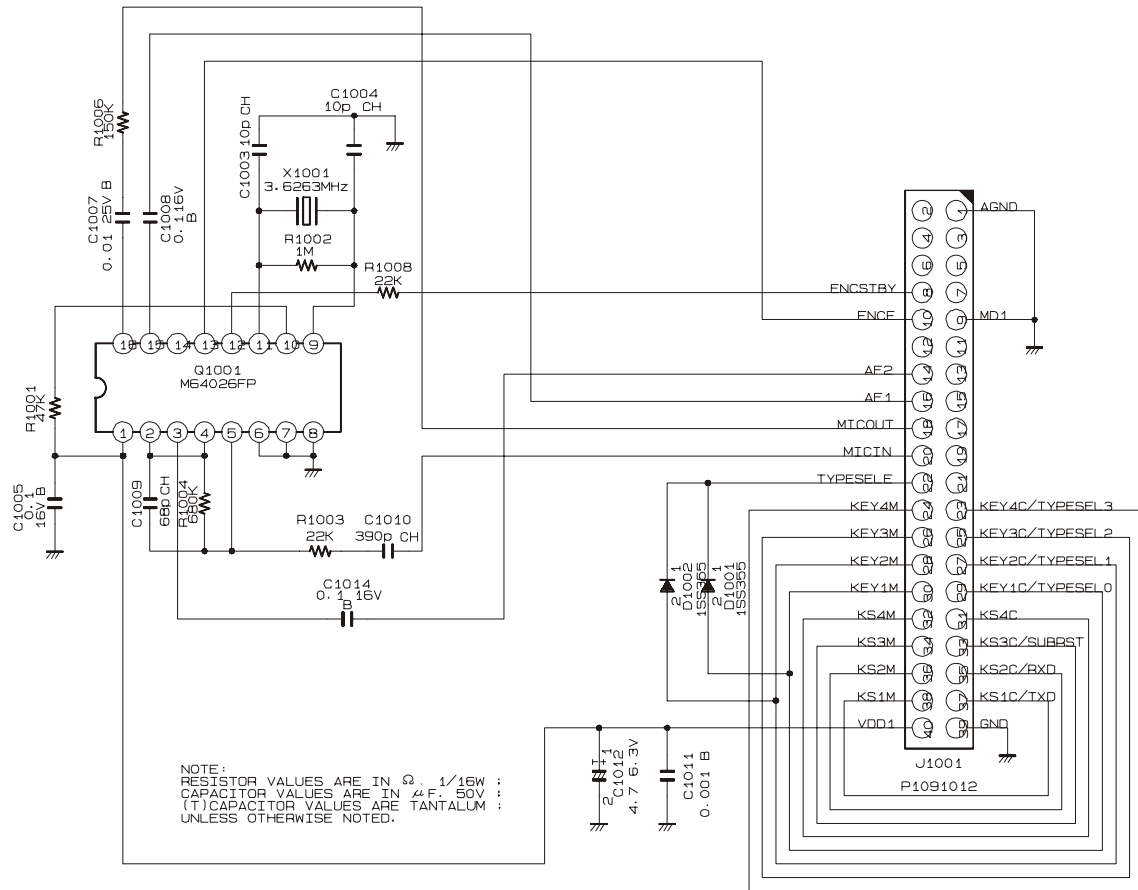

## Parts Layout

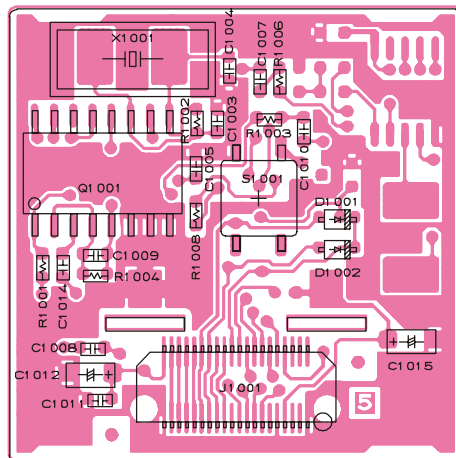
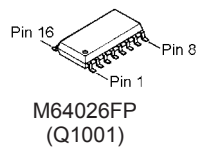

Side A

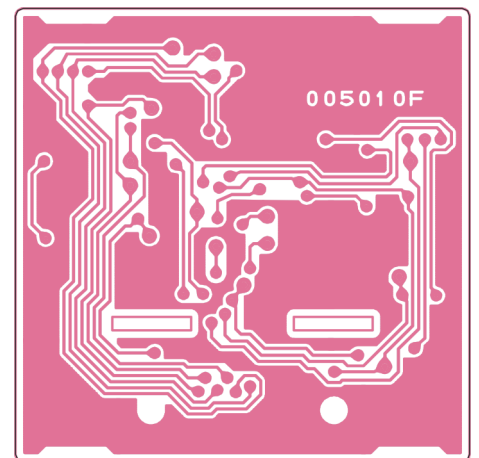

Side B

# FVP-36 Voice Inversion Type Encryption Unit (Option)

## Parts List

| REF                   | DESCRIPTION      | VALUE     | V/W   | TOL. | MFR'S DESIG        | VXSTD P/N | VERS. | LOT | SIDE | LAY ADR |
|-----------------------|------------------|-----------|-------|------|--------------------|-----------|-------|-----|------|---------|
| Printed Circuit Board |                  |           |       |      |                    | FR005010F |       |     |      |         |
| C 1003                | CHIP CAP.        | 10pF      | 50V   | CH   | GRM1882C1H100JA01D | K22174211 |       | 1-  |      |         |
| C 1004                | CHIP CAP.        | 10pF      | 50V   | CH   | GRM1882C1H100JA01D | K22174211 |       | 1-  |      |         |
| C 1005                | CHIP CAP.        | 0.1uF     | 16V   | B    | GRM188B11C104KA01D | K22124805 |       | 1-  |      |         |
| C 1007                | CHIP CAP.        | 0.01uF    | 25V   | B    | GRM39B103M25PT     | K22144802 |       | 1-  |      |         |
| C 1008                | CHIP CAP.        | 0.1uF     | 16V   | B    | GRM188B11C104KA01D | K22124805 |       | 1-  |      |         |
| C 1009                | CHIP CAP.        | 68pF      | 50V   | CH   | GRM1882C1H680JA01D | K22174231 |       | 1-  |      |         |
| C 1010                | CHIP CAP.        | 390pF     | 50V   | CH   | GRM1882C1H391JA01D | K22174255 |       | 1-  |      |         |
| C 1011                | CHIP CAP.        | 0.001uF   | 50V   | B    | GRM188B11H102KA01D | K22174821 |       | 1-  |      |         |
| C 1012                | CHIP TA.CAP.     | 4.7uF     | 6.3V  |      | TEMSVA0J475M-8R    | K78080017 |       | 1-  |      |         |
| C 1014                | CHIP CAP.        | 0.1uF     | 16V   | B    | GRM188B11C104KA01D | K22124805 |       | 1-  |      |         |
| D 1001                | DIODE            |           |       |      | 1SS355 TE-17       | G2070470  |       | 1-  |      |         |
| D 1002                | DIODE            |           |       |      | 1SS355 TE-17       | G2070470  |       | 1-  |      |         |
| J 1001                | CONNECTOR        |           |       |      | AXK5S40035P        | P1091012  |       | 1-  |      |         |
| Q 1001                | IC               |           |       |      | M64026FP-650C      | G1092754  |       | 1-  |      |         |
| R 1001                | CHIP RES.        | 47k       | 1/16W | 5%   | RMC1/16 473JATP    | J24185473 |       | 1-  |      |         |
| R 1002                | CHIP RES.        | 1M        | 1/16W | 5%   | RMC1/16 105JATP    | J24185105 |       | 1-  |      |         |
| R 1003                | CHIP RES.        | 22k       | 1/16W | 5%   | RMC1/16 223JATP    | J24185223 |       | 1-  |      |         |
| R 1004                | CHIP RES.        | 680k      | 1/16W | 5%   | RMC1/16 684JATP    | J24185684 |       | 1-  |      |         |
| R 1006                | CHIP RES.        | 150k      | 1/16W | 5%   | RMC1/16 154JATP    | J24185154 |       | 1-  |      |         |
| R 1008                | CHIP RES.        | 10k       | 1/16W | 5%   | RMC1/16 103JATP    | J24185103 |       | 1-  |      |         |
| R 1008                | CARBON FILM RES. | 22k       | 1/8W  | 5%   | RD18TJ223 22K      | J01215223 |       | 1-  |      |         |
| R 1008                | CHIP RES.        | 22k       | 1/16W | 5%   | RMC1/16 223JATP    | J24185223 |       | 1-  |      |         |
| R 1009                | CHIP RES.        | 3.3M      | 1/16W | 5%   | RMC1/16 335JATP    | J24185335 |       | 1-  |      |         |
| X 1001                | XTAL SX-1315     | 3.6263MHz |       |      | 3.6263MHZ          | H0103183  |       | 1-  |      |         |







Copyright 2006  
VERTEX STANDARD CO., LTD.  
All rights reserved

No portion of this manual  
may be reproduced without  
the permission of  
VERTEX STANDARD CO., LTD.