



DIGITAL TWO-WAY RADIO SYSTEM

VXD-7200

OPERATING MANUAL



DECLARATION OF CONFORMITY

This declaration is applicable to your radio only if your radio is labeled with the FCC logo shown below.

DECLARATION OF CONFORMITY

Per FCC CFR 47 Part 2 Section 2.1077(a)



Name: Vertex Standard LMR, Inc.

Address: US Headquarters: 10900 Walker Street, Cypress, CA 90630 U.S.A.

Phone Number: 1-800-283-7839

Hereby declares that the product:

Model Name: **VXD-7200**

conforms to the following regulations:

FCC Part 15, subpart B, section 15.107(a), 15.107(d) and section 15.109(a)

Class B Digital Device

As a personal computer peripheral, this device complies with Part 15 of the FCC Rules. Operation is subject to the following two conditions:

1. This device may not cause harmful interference, and
2. This device must accept any interference received, including interference that may cause undesired operation.

Note: This equipment has been tested and found to comply with the limits for a Class B digital device, pursuant to part 15 of the FCC Rules. These limits are designed to provide reasonable protection against harmful interference in a residential installation. This equipment generates, uses and can radiate radio frequency energy and, if not installed and used in accordance with the instructions, may cause harmful interference to radio communications. However, there is no guarantee that interference will not occur in a particular installation.

If this equipment does cause harmful interference to radio or television reception, which can be determined by turning the equipment off and on, the user is encouraged to try to correct the interference by one or more of the following measures:

- Reorient or relocate the receiving antenna.
- Increase the separation between the equipment and receiver.
- Connect the equipment into an outlet on a circuit different from that to which the receiver is connected.
- Consult the dealer or an experienced radio/TV technician for help.

CONTENTS

This User Guide contains all the information you need to use the Vertex Standard VXD-7200 Digital Two-Way Radio System.

- Product Safety and RF Energy Exposure 6**
- Important Safety Information 14**
- Software Version 14**
- Computer Software Copyrights 15**
- Getting Started..... 16**
 - How to Use This User Guide 16
 - What Your Dealer/System Administrator Can Tell You 16
 - Powering Up the Radio 17
 - Adjusting the Volume..... 17
- Identifying Radio Controls..... 18**
 - Radio Controls..... 18
 - Programmable Buttons..... 19
 - Assignable Radio Functions..... 19
 - Assignable Settings/Utility Functions 20
 - Accessing the Programmed Functions..... 21
 - Push-To-Talk (PTT) Button 22
 - Switching Between Conventional Analog and Digital Mode 23

- Identifying Status Indicators 24**
 - Display Icons 24
 - Call Icons..... 25
 - Sent Item Icons 26
 - LED Indicators..... 26
 - Audio Tones..... 27
 - Indicator Tones 27
- Receiving and Making Calls 28**
 - Selecting a Zone 28
 - Selecting a Radio Channel, Subscriber Alias or ID, or Group Alias or ID 29
 - Receiving and Responding to a Radio Call... 30
 - Receiving and Responding to a Group Call 30
 - Receiving and Responding to a Private Call..... 31
 - Receiving an All Call..... 32
 - Making a Radio Call 32
 - Making a Call with the Channel Rocker 33
 - Making a Group Call 33
 - Making a Private Call 33
 - Making an All Call..... 34
 - Making a Group or Private Call with the One Touch Access Button..... 35
 - Talkaround..... 36
 - Permanent Monitor..... 37

Advanced Features	38	Assigning Ring Styles.....	50
Radio Check.....	38	Escalating Alarm Tone Volume.....	50
Sending a Radio Check.....	38	Call Log Features	51
Remote Monitor.....	40	Viewing Recent Calls	51
Initiating Remote Monitor	40	Missed Call Screen	51
Stopping Remote Monitor.....	41	Deleting a Call from a Call List.....	52
Scan Lists.....	42	Call Alert Operation	53
Viewing an Entry in the Scan List.....	42	Receiving and Responding	
Editing the Scan List.....	42	to a Call Alert.....	53
Adding a New Entry to the Scan List....	42	Making a Call Alert	
Deleting an Entry from the Scan List....	43	from the Contacts List	53
Setting and Editing Priority		Making a Call Alert	
for an Entry in the Scan List.....	43	with the One Touch Access Button.....	54
Scan	44	Emergency Operation	54
Starting and Stopping Scan.....	44	Receiving an Emergency Alarm	55
Responding to a Transmission		Responding to an Emergency Alarm.....	56
During a Scan.....	45	Sending an Emergency Alarm.....	57
Deleting a Nuisance Channel.....	45	Sending an Emergency Alarm with Call	57
Restoring a Nuisance Channel.....	46	Sending an Emergency Alarm	
Contacts Settings	46	with Voice to Follow.....	58
Making a Group Call from Contacts	47	Reinitiating an Emergency Mode	59
Making a Private Call from Contacts	48	Exiting Emergency Mode	60
Call Indicator Settings	49	Text Messaging Features	60
Activating and Deactivating Call Ringers		Sending a Quick Text Message.....	60
for Private Calls.....	49	Sending a Quick Text Message	
Activating and Deactivating Call Ringers		with the One Touch Access Button.....	62
for Text Messaging	49	Managing Text Messages	
		in the Drafts Folder.....	62

Viewing a Saved Text Message	61	Utilities.....	72
Deleting a Saved Text Message		Setting the Squelch Level.....	72
from Drafts	62	Setting the Power Level	73
Managing Fail-to-Send Text Messages	62	Turning the Voice Operating Transmission	
Resending a Text Message	62	(VOX) Feature On or Off	73
Forwarding a Text Message	62	Turning the Public Address System	
Managing Sent Text Messages	63	On or Off.....	74
Viewing a Sent Text Message	63	Turning the External Public	
Sending a Sent Text Message	63	Address System On or Off	74
Deleting All Sent Text Messages		Controlling the Display Backlight.....	75
from Sent Items	65	Turning Horns/Lights On or Off	75
Receiving a Text Message	65	Turning the Radio Tones/Alerts	
Reading a Text Message	65	On or Off.....	76
Managing Received Text Messages.....	66	Setting the Tone Alert Volume	
Viewing a Text Message		Offset Level	76
from the Inbox	66	Turning the Talk Permit Tone On or Off	77
Replying to a Text Message		Turning the LED Indicators On or Off	77
with Quick Text	66	Turning the Introduction Screen	
Deleting a Text Message		On or Off.....	78
from the Inbox	67	Accessing General Radio Information.....	78
Deleting All Text Messages		Checking the Radio ID	78
from the Inbox	68	Checking the Firmware Version	79
Privacy.....	69	Checking the Codeplug Version	79
Security	70	Accessories	80
Radio Disable	70		
Radio Enable.....	71		
Lone Worker.....	72		



Caution

ATTENTION!

BEFORE USING THIS RADIO, READ THIS CHAPTER WHICH CONTAINS IMPORTANT OPERATING INSTRUCTIONS FOR SAFE USAGE AND RF ENERGY AWARENESS AND CONTROL INFORMATION FOR COMPLIANCE WITH RF ENERGY EXPOSURE LIMITS IN APPLICABLE NATIONAL AND INTERNATIONAL STANDARDS.

The information provided in this document supersedes the general safety information contained in user guides published prior to February 2002.

RF Energy Exposure Awareness and Control Information, and Operational Instructions for FCC Occupational Use Requirements

NOTICE: This radio is intended for use in occupational/controlled conditions, where users have full knowledge of their exposure and can exercise control over their exposure to meet FCC limits. This radio device is NOT authorized for general population, consumer, or any other use.

This 2-way radio uses electromagnetic energy in the radio frequency (RF) spectrum to provide communications between two or more users over a distance. It uses radio frequency (RF) energy or radio waves to send and receive calls. RF energy is one form of electromagnetic energy. Other forms include, but are not limited to, sunlight and x-rays. RF energy, however, should not be confused with these other forms of electromagnetic energy, which when used improperly, can cause biological damage. Very high levels of x-rays, for example, can damage tissues and genetic material.

Experts in science, engineering, medicine, health, and industry work with organizations to develop standards for safe exposure to RF energy. These standards provide recommended levels of RF exposure for both workers and the general public. These recommended RF exposure levels include substantial margins of protection.

All Vertex Standard 2-way radios are designed, manufactured, and tested to ensure they meet government-established RF exposure levels. In addition, manufacturers also recommend specific operating instructions

to users of 2-way radios. These instructions are important because they inform users about RF energy exposure and provide simple procedures on how to control it.

Please refer to the following Web sites for more information on what RF energy exposure is and how to control your exposure to assure compliance with established RF exposure limits.

<http://www.fcc.gov/oet/rfsafety/rf-faqs.html>

<http://www.osha.gov/SLTC/radiofrequencyradiation/index.html>

Federal Communication Commission Regulations

The FCC rules require manufacturers to comply with the FCC RF energy exposure limits for mobile 2-way radios before they can be marketed in the U.S. When 2-way radios are used as a consequence of employment, the FCC requires users to be fully aware of and able to control their exposure to meet occupational requirements. Exposure awareness can be facilitated by the use of a label directing users to specific user awareness information. Your Vertex Standard 2-way radio has a RF exposure product label. Also, your Vertex Standard user manual, or separate safety booklet, includes information and operating instructions required to control your RF exposure and to satisfy compliance requirements.

Compliance with RF Exposure Standard

Your Vertex Standard two-way radio is designed and tested to comply with a number of national and international standards and guidelines (listed below) regarding human exposure to radio frequency electromagnetic energy. This radio complies with the IEEE and ICNIRP exposure limits for occupational/controlled RF exposure environment at duty factors of up to 50% talk-50% listen and is authorized by the FCC for occupational use. In terms of measuring RF energy for compliance with the FCC exposure guidelines, your radio antenna radiates measurable RF energy only while it is transmitting (during talking), not when it is receiving (listening) or in standby mode.

Your Vertex Standard two-way radio complies with the following RF energy exposure standards and guidelines:

- United States Federal Communications Commission, Code of Federal Regulations; 47CFR part 2 sub-part J
- American National Standards Institute (ANSI) / Institute of Electrical and Electronic Engineers (IEEE) C95.1-1992
- Institute of Electrical and Electronic Engineers (IEEE) C95.1-1999 Edition
- International Commission on Non-Ionizing Radiation Protection (ICNIRP) 1998
- Ministry of Health (Canada) Safety Code 6. Limits of Human Exposure to Radiofrequency Electromagnetic Fields in the Frequency Range from 3 kHz to 300 GHz, 1999
- Australian Communications Authority Radiocommunications (Electromagnetic Radiation - Human Exposure) Standard, 2003
- ANATEL, Brasil Regulatory Authority, Resolution 256 (April 11, 2001) “additional requirements for SMR, cellular, and PCS product certification.”

RF Exposure Compliance and Control Guidelines and Operating Instructions

To control exposure to yourself and others and to ensure compliance with the RF exposure limits, always adhere to the following procedures.

Guidelines:

- User awareness instructions should accompany device when transferred to other users.
- Do not use this device if the operational requirements described herein are not met.

Instructions:

- Transmit no more than the rated duty factor of 50% of the time. To transmit (talk), push the Push-To-Talk (PTT) button or, for radios equipped with VOX, speak into the microphone. The red LED will illuminate when the radio is transmitting. To receive calls, release the PTT button, or, for radios equipped with VOX, stop talking. The red LED will extinguish when the radio stops transmitting. Transmitting 50% of the time, or less, is important because this radio generates measurable RF energy exposure only when transmitting

(in terms of measuring for standards compliance).

- **Transmit only when people outside the vehicle are at least the recommended minimum lateral distance away, as shown in Table 1, from the body of a vehicle with a properly installed antenna.** This separation distance will ensure that there is sufficient distance from a properly installed (according to installation instructions) externally-mounted antenna to satisfy the RF exposure requirements in the standards listed above.

NOTE: Table 1 below lists the recommended lateral distance for people in an uncontrolled environment from the body of a vehicle with an approved, properly installed transmitting antenna (i.e., monopoles over a ground plane, or dipoles) at several different ranges of rated radio power for mobile radios installed in a vehicle.

Table 1. Rated Power of Vehicle-Installed Mobile Two-Way Radio and Recommended Minimum Lateral Distance from Vehicle Body

Mobile Radio Rated Power (see Note)	Minimum Lateral Distance from Vehicle Body
Less than 7 watts	8 inches (20 centimeters)
7 to 15 watts	1 foot (30 centimeters)
16 to 39 watts	2 feet (60 centimeters)
40 to 110 watts	3 feet (90 centimeters)

- When a mobile radio is used in conjunction with another co-located transmitter such as a Vehicular Repeater, it is the vehicle operator’s responsibility to take appropriate steps to keep bystanders at the required separation distance from the vehicle to ensure compliance with the FCC’s RF energy exposure limits for the general population. See the co-located transmitter’s user manual for more details.

NOTE: If you are not sure of the rated power of your radio, contact your Vertex Standard representative or dealer and supply the radio model number found on the radio model label. If you can not determine the rated power out, then assure 3-foot separation from the body of the vehicle. The maximum power shown on the FCC Grant may be higher than the rated power allowing for production variation.

Mobile Antenna Installation Guidelines

- These mobile antenna installation guidelines are limited to metal body motor vehicles or vehicles with appropriate ground planes.
- Antennas should be installed in the center area of the roof or the trunk lid taking into account exposure conditions of backseat passengers and according to the specific instructions and restrictions in the Radio Installation Manual along with the requirements of the antenna supplier.
- Trunk lid installations are limited to vehicles with clearly defined flat trunk lids, and in some cases, to specific radio models and antennas. See the Radio Installation Manual for specific information on how and where to install specific types of approved antennas to facilitate recommended operating distances to all potentially exposed persons.
- **Use only the Vertex Standard -approved, supplied antenna or a Vertex Standard-approved replacement antenna.** Unauthorized antennas, modifications, or attachments could damage the radio and may result in non-compliance with RF Safety Standards.

Approved Accessories

- This radio has been tested and meets RF Safety Standards when used with the Vertex Standard accessories supplied or designated for this product. Use of other accessories may result in non-compliance with RF Safety Standards.
- For a list of Vertex Standard -approved antennas, visit the following Web site, which lists approved accessories for your radio model:
<http://www.vertexstandard.com/lmr>.

Compliance and Control Guidelines and Operating Instructions for Mobile Two-Way Radios Installed as Fixed Site Control Stations

If mobile radio equipment is installed at a fixed location and operated as a control station or as a fixed unit, the antenna installation must comply with the following requirements in order to ensure optimal performance and compliance with the RF energy exposure limits in the standards and guidelines listed on page 4:

- The antenna should be mounted outside the building on the roof or a tower if at all possible.
- As with all fixed site antenna installations, it is the responsibility of the licensee to manage the site in accordance with applicable regulatory requirements and may require additional compliance actions such as site survey measurements, signage, and site access restrictions in order to ensure that exposure limits are not exceeded.
- For additional installation information, see the guidelines for minimum separation distances provided above in the RF Exposure Compliance and Control Guidelines and Operating Instructions section of this document.

Electromagnetic Interference/Compatibility

NOTE: Nearly every electronic device is susceptible to electromagnetic interference (EMI) if inadequately shielded, designed, or otherwise configured for electromagnetic compatibility. It may be necessary to conduct compatibility testing to determine if any electronic equipment used in or around vehicles or near fixed site antenna is sensitive to external RF energy or if any procedures need to be followed to eliminate or mitigate the potential for interaction between the radio transmitter and the equipment or device.

Facilities

To avoid electromagnetic interference and/or compatibility conflicts, turn off your radio in any facility where posted notices instruct you to do so. Hospitals or health care facilities may be using equipment that is sensitive to external RF energy.

Vehicles

To avoid possible interaction between the radio transmitter and any vehicle electronic control modules, such as ABS, engine, or transmission controls, the radio should be installed only by an experienced installer and the following precautions should be used when installing the radio:

1. Refer to the manufacturer’s instructions or other technical bulletins for recommendations on radio installation.
2. Before installing the radio, determine the location of the electronic control modules and their harnesses in the vehicle.
3. Route all radio wiring, including the antenna transmission line, as far away as possible from the electronic control units and associated wiring.

Driver Safety

Check the laws and regulations on the use of radios in the area where you drive. Always obey them.

When using your radio while driving, please:

- Give full attention to driving and to the road.
- Pull off the road and park before making or answering a call if driving conditions so require.

Operational Warnings



WARNING

For Vehicles with an Air Bag

Do not mount or place a mobile radio in the area over an air bag or in the air bag deployment area. Air bags inflate with great force.

If a radio is placed in the air bag deployment area and the air bag inflates, the radio may be propelled with great force and cause serious injury to occupants of the vehicle.

Potentially Explosive Atmospheres

Turn off your radio prior to entering any area with a potentially explosive atmosphere. Sparks in a potentially explosive atmosphere can cause an explosion or fire resulting in bodily injury or even death.

The areas with potentially explosive atmospheres include fueling areas such as below decks on boats, fuel or chemical transfer or storage facilities, and areas where the air contains chemicals or particles such as grain, dust or metal powders. Areas with potentially explosive atmospheres are often, but not always, posted.

Blasting Caps and Blasting Areas

To avoid possible interference with blasting operations, turn off your radio when you are near electrical blasting caps, in a blasting area, or in areas posted: "Turn off two-way radio." Obey all signs and instructions.

For radios installed in vehicles fueled by liquefied petroleum gas, refer to the (U.S.) National Fire Protection Association standard, NFPA 58, for storage, handling, and/or container information. For a copy of the LP-gas standard, NFPA 58, contact the National Fire Protection Association, One Battery Park, Quincy, MA.

IMPORTANT SAFETY INFORMATION

Product Safety and RF Exposure Compliance



Caution

Before using this product, read the “Product Safety and RF Exposure chapter” beginning with page 6.

ATTENTION!

This radio is restricted to occupational use only to satisfy FCC RF energy exposure requirements.

For a list of Vertex Standard-approved antennas, batteries, and other accessories, visit the following website: <http://www.vertexstandard.com/lmr>

SOFTWARE VERSION

All the features described in the following sections are supported by the radio’s software version 1.0 Build 10 or later.

See ***Checking the Firmware Version*** on page 79 to determine your radio’s software version.

Check with your dealer or system administrator for more details of all the features supported.

COMPUTER SOFTWARE COPYRIGHTS

The Vertex Standard products described in this manual may include copyrighted Vertex Standard computer programs stored in semiconductor memories or other media. Laws in the United States and other countries preserve for Vertex Standard certain exclusive rights for copyrighted computer programs including, but not limited to, the exclusive right to copy or reproduce in any form the copyrighted computer program. Accordingly, any copyrighted computer programs contained in the products described in this manual may not be copied, reproduced, modified, reverse-engineered, or distributed in any manner without the express written permission of.

Furthermore, the purchase of products shall not be deemed to grant either directly or by implication, estoppel, or otherwise, any license under the copyrights, patents or patent applications of, except for the normal non-exclusive license to use that arises by operation of law in the sale of a product.

The AMBE+2™ voice coding Technology embodied in this product is protected by intellectual property rights including patent rights, copyrights and trade secrets of Digital Voice Systems, Inc.

This voice coding Technology is licensed solely for use within this Communications Equipment. The user of this Technology is explicitly prohibited from attempting to de-compile, reverse engineer, or disassemble the Object Code, or in any other way convert the Object Code into a human-readable form.

U.S. Pat. Nos. #5,870,405, #5,826,222, #5,754,974, #5,701,390, #5,715,365, #5,649,050, #5,630,011, #5,581,656, #5,517,511, #5,491,772, #5,247,579, #5,226,084 and #5,195,166.

GETTING STARTED

Take a moment to review the following:



How to Use This Guide.....	page 16
What Your Dealer/System Administrator Can Tell You.....	page 16
Power Up the Radio	page 17
Adjusting the Volume.....	page 17

■ How to Use This Guide

This User Guide covers the basic operation of the Vertex Standard Mobile.

However, your dealer or system administrator may have customized your radio for your specific needs. Check with your dealer or system administrator for more information.

Throughout this publication, the icons below are used to indicate features supported in either the conventional Analog mode or conventional Digital mode:

-  Indicates a conventional Analog Mode-Only feature.
-  Indicates a conventional Digital Mode-Only feature.

For features that are available in both conventional Analog and Digital modes, no icon is shown.

■ What Your Dealer/System Administrator Can Tell You

You can consult your dealer or system administrator about the following:

- Is your radio programmed with any preset conventional channels?
- Which buttons have been programmed to access other features?
- What optional accessories may suit your needs?

■ Powering Up the Radio

Press the **On/Off Button** briefly.

The green LED blinks and the Home screen lights up if the backlight setting is set to turn on automatically.

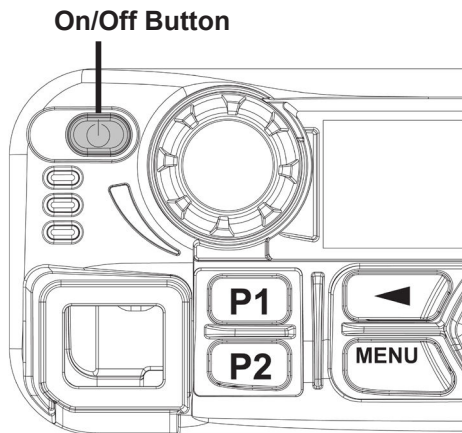

NOTE: The Home screen does not light up during a power up if the LED indicator is disabled (see **Turning the LED Indicator On or Off** on page 77).

A brief tone sounds, indicating that the power up test is successful.

NOTE: There is no power up tone if the radio tones/alerts function is disabled (see **Turning the Radio Tones/ Alerts On or Off** on page 76).

If your radio does not power up, contact your dealer.

To turn off the radio, press and hold the On/Off Button until you see “Powering Down” on the radio’s display.

■ Adjusting the Volume

To increase the volume, turn the **Volume Knob** clockwise.

To decrease the volume, turn this knob counter-clockwise.

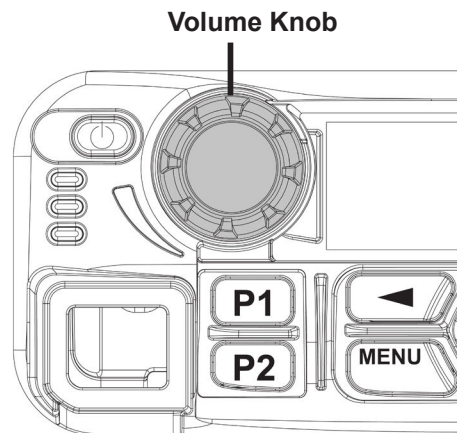



IDENTIFYING RADIO CONTROLS





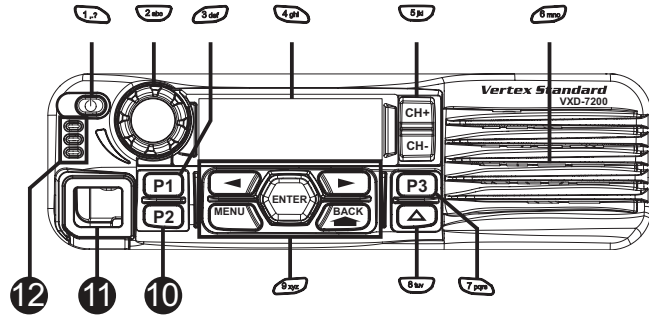

Take a moment to review the following:

Radio Controls.....	page 18
Programmable Buttons.....	page 19
Accessing the Programmed Functions.....	page 21
Push-To-Talk (PTT) Button.....	page 22
Switching Between Conventional Analog and Digital Mode.....	page 23

■ Radio Controls

- : On/Off Button
- : Volume Knob
- : Front Button P1*
- : Display
- : Channel Rocker
- : Speaker



- : Front Button P3*
- : Front Button Δ*
- : Menu Navigation Buttons
- : Front Button P2*
- : Accessory Connector
- : LED Indicator

* These buttons are programmable.

■ Programmable Buttons

Your dealer can program the programmable buttons as shortcuts to **radio functions** or up to a maximum of six (6) **preset channels/groups** depending on the duration of a button press:

- Short press – Pressing and releasing rapidly (0.05 seconds).
- Long press – Pressing and holding for the programmed duration (between 1.00 second and 3.75 seconds).
- Hold down – Keeping the button pressed.

NOTE: The programmed duration of a button press is applicable for all assignable radio/utility functions or settings. See **Emergency Operation** on page 52 for more information on the programmed duration of the **Emergency** button.

📄 Assignable Radio Functions

Contacts – Provides direct access to the Contacts list.

Emergency – Depending on the programming, initiates or cancels an emergency alarm or call.

Ext PA On/Off – Toggles the audio routing between the connected public address (PA) loudspeaker amplifier and the radio's internal public address (PA) system.

Manual Dial 📞 – Initiates a call by keying in any subscriber ID. Only available with a keypad microphone.

Nuisance Channel Delete – Temporarily removes an unwanted channel, except for the Selected Channel, from the scan list. The Selected Channel refers to the user's selected zone/channel combination from which scan is initiated.

One Touch Access 📞 – Directly initiates a predefined Private or Group Call, a Call Alert or a Quick Text message.

PA On/Off – Toggles the audio's internal public address (PA) system on or off.

Permanent Monitor – Monitors a selected channel for all radio traffic until function is disabled.

Privacy 📞 – Toggles privacy on or off.

Radio Check 📞 – Determines if a radio is active in a system.

Radio Enable  – Allows a target radio to be remotely enabled.

Radio Disable  – Allows a target radio to be remotely disabled.

Remote Monitor – Turns on the microphone of a target radio without it giving any indicators.

Repeater/Talkaround – Toggles between using a repeater and communicating directly with another radio.

Scan – Toggles scan on or off.

Site Lock On/Off  – Toggles the automatic site roam on or off.

Text Message  – Selects the text message menu.

Voice Operating Transmission (VOX) – Toggles VOX on or off.

Zone – Allows selection from a list of zones.

Assignable Settings or Utility Functions

All Tones/Alerts – Toggles all tones and alerts on or off.

Backlight – Toggles display backlight on or off.

Horns/Lights – Toggles horns and lights feature on or off.

Power Level – Toggles transmit power level between high and low.

Squelch  – Toggles squelch level between normal and tight.







■ Accessing the Programmed Functions

You can access various radio functions through one of the following ways:

- A short or long press of the relevant programmable buttons.

OR

- Use the Menu Navigation Buttons as follows:

- 1 To access the menu, press the  button. Press the appropriate **Menu Scroll** button ( or ) to access the menu functions.
- 2 To select a function or enter a sub-menu, press the  button.
- 3 To go back one menu level, or to return to the previous screen, press the  button. Long press the  button to return to the Home screen.

NOTE: Your radio automatically exits the menu after a period of inactivity and returns to your Home screen.

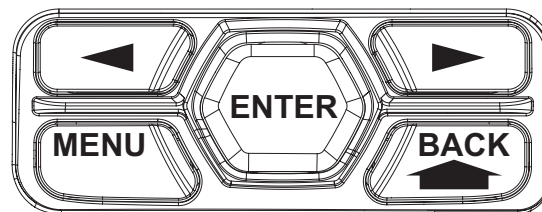



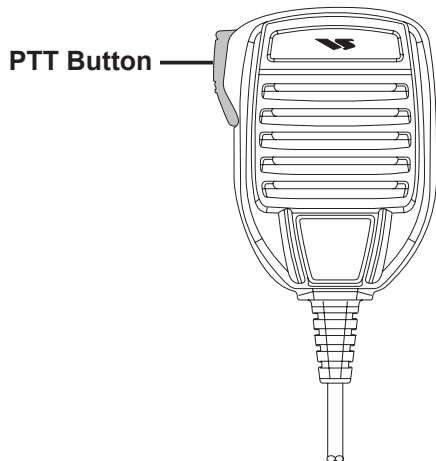

■ Push-To-Talk (PTT) Button

The **PTT** button on the side of the microphone serves two basic purposes:



- While a call is in progress, the **PTT** button allows the radio to transmit to other radios in the call. Press and hold down **PTT** button to talk. Release the **PTT** button to listen. The microphone is activated when the **PTT** button is pressed.
- While a call is not in progress, the **PTT** button is used to make a new call (see **Making a Radio Call** on page 32).

If the Talk Permit Tone (see **Turning the Talk Permit Tone On or Off** on page 77) or the PTT Sidetone  is enabled, wait until the short alert tone ends before talking.

-  During a call, if the Channel Free Indication feature is enabled on your radio (programmed by your dealer), you will hear a short alert tone the moment the target radio (the radio that is receiving your call) releases the **PTT** button, indicating the channel is free for you to respond.
-  You will also hear the Channel Free Indication tone if your call is interrupted, for example when the radio receives an Emergency Call. You can turn off the Channel Free Indication tone or the PTT Sidetone  by disabling all radio tones and alerts (see **Turning the Radio Tones/Alerts On or Off** on page 76).

■ Switching Between Conventional Analog and Digital Mode

Each channel in your radio can be configured as a conventional analog or conventional digital channel. Use the **Channel Rocker** to switch between an analog or a digital channel.

When switching from digital to analog mode, certain features are unavailable. Icons for the digital features (such as Messages) reflect this change by appearing 'grayed out'.

Disabled features are hidden in the menu.

Your radio also has features available in both analog and digital mode. However, the minor differences in the way each feature works does **NOT** affect the performance of your radio.

NOTE: Your radio also switches between digital and analog modes during a dual mode scan (see **Scan** on page 44).

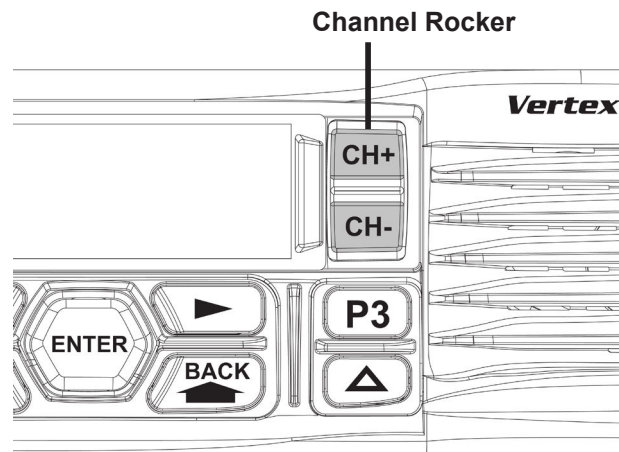

IDENTIFYING STATUS INDICATORS

Your radio indicates its operational status through the following:

Display Icons	page 24
Call Icons.....	page 25
Sent Item Icons.....	page 26
LED Indicator.....	page 26
Audio Tones.....	page 27
Indicator Tones	page 27

■ Display Icons



The liquid crystal display (LCD) of your radio shows radio status, text entries, and menu entries.

The following are icons that appear on the radio's display.

 **Received Signal Strength Indicator (RSSI)**

The number of bars displayed represents the radio signal strength. Four bars indicate the strongest signal. This icon is only displayed while receiving.



 **Monitor**
Selected channel is being monitored.

 **Power Level**
Radio is set at Low power.
or
 Radio is set at High power.

 **Tones Disable**
Tones are turned off.

 **Scan**
Scan feature is enabled.

 **Priority Scan**
Radio detects activity on channel/group designated as Priority 1 (if "■" is blinking) or Priority 2 (if "■" is steady).

 **Unread Message** 
User has unread message(s) in the Inbox.

 **Inbox Full** 
User's Inbox is full.

 **Emergency**
Radio is in Emergency mode.

 **Secure** 
The Privacy feature is enabled.

 **Unsecure** 
The Privacy feature is disabled.



Talkaround

In the absence of a repeater, radio is currently configured for direct radio to radio communication.

■ Call Icons

The following icons appear on the radio's display during a call.

These icons also appear in the Contacts list to indicate ID type.



Private Call

Indicates a Private Call in progress. In the Contacts list, it indicates a subscriber alias (name) or ID (number).



Group Call/All Call

Indicates a Group Call or All Call in progress. In the Contacts list, it indicates a group alias (name) or ID (number).

■ Sent Item Icons

The following icons appear at the top right corner of the radio's display in the Sent Items folder.



Sent Successfully

The text message is sent successfully.



Send Failed

The text message cannot be sent.



In-Progress

- The text message to a group alias or ID is pending transmission.
- The text message to a subscriber alias or ID is pending transmission, followed by waiting for acknowledgement.

■ LED Indicator

LED indicator shows the operational status of your radio.

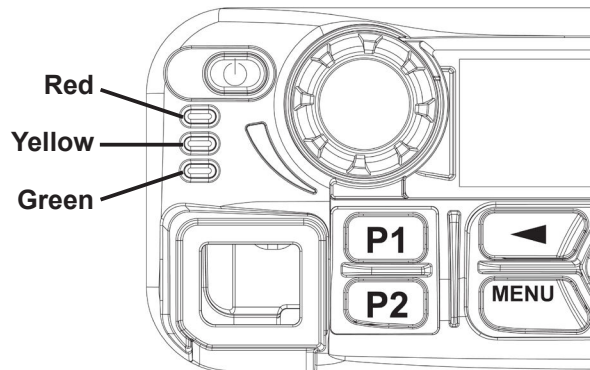

Blinking red – Radio is receiving an emergency transmission or has failed the self-test upon powering up.

Solid yellow – Radio is monitoring a channel.

Blinking yellow – Radio is scanning for activity or receiving a Call Alert.

Solid green – Radio is transmitting.

Blinking green – Radio is powering up, receiving a non privacy-enabled call or data, or detecting activity over the air.

Rapidly blinking green – Radio is receiving a privacy-enabled call or data .

NOTE: While in conventional mode, when the green LED blinks, it indicates the radio detects activity over the air. Due to the nature of the digital protocol, this activity may or may not affect the radio’s programmed channel.

Upon a **PTT** button press, if the radio is programmed for polite operation, the radio automatically determines whether a transmission is permitted via a Talk Permit or a Talk Denial tone.

■ **Audio Tones**

Alert tones provide you with audible indications of the radio’s status or the radio’s response to data received.

Continuous Tone  A monotone sound. Sounds continuously until termination.

Periodic Tone  Sounds periodically depending on the duration set by the radio. Tone starts, stops, and repeats itself.

Repetitive Tone  A single tone that repeats itself until it is terminated by the user.

Momentary Tone  Sounds only once for a short period of time defined by the radio.

■ **Indicator Tones**

High pitched tone Low pitched tone

 Positive Indicator Tone

 Negative Indicator Tone

RECEIVING AND MAKING CALLS

Once you understand how your Vertex Standard Mobile is configured, you are ready to use your radio.

Use this navigation guide to familiarize yourself with the basic Call features:

Selecting a Zone.....	page 28
Selecting a Radio Channel, Subscriber ID, or Group ID.....	page 29
Receiving and Responding to a Radio Call	page 30
Making a Radio Call	page 32
Talkaround	page 36
Permanent Monitor	page 37

■ Selecting a Zone

A zone is a group of channels. Your radio supports up to 250 zones, with a maximum of 160 channels per zone.

Use the following procedure to select a zone.



Procedure:

Press the programmed Zone button and proceed to Step 3.



OR

Follow the procedure below.

- 1  to access the menu.

- 2  or  to Zone and press  to select.

- 3 The current zone is displayed and indicated by a "√".

- 4  or  to the required zone and press  to select.

- 5 The display shows "<Zone> Selected" momentarily and returns to the selected zone screen.

■ Selecting a Radio Channel, Subscriber Alias ID, or Group Alias or ID

Procedure:

Once the required zone is displayed (if you have multiple zones in your radio), press the **Channel Rocker** to select the channel, subscriber alias or ID, or group alias or ID.

or

Press the programmed **One Touch Access** button to select the preset channel assigned to the button.

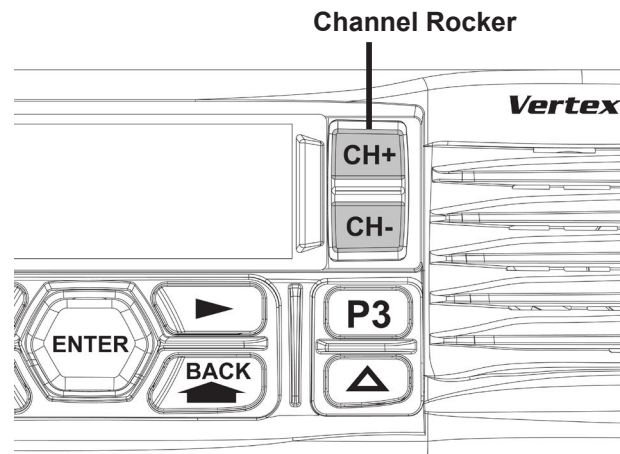

■ Receiving and Responding to a Radio Call

Once the channel, subscriber alias or ID, or group alias or ID is displayed, you can proceed to receive and respond to calls.

The green LED lights up while the radio is transmitting and blinks when the radio is receiving.

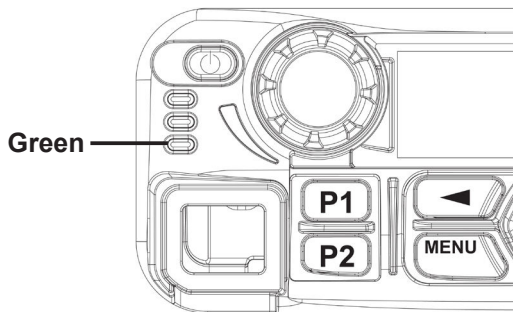

NOTE: The green LED lights up while the radio is transmitting and blinks rapidly when the radio is receiving a privacy-enabled call.

To unscramble a privacy-enabled call, your radio must have the same Privacy Key, OR the same Key Value and Key ID (programmed by your dealer), as the transmitting radio (the radio you are receiving the call from).



See **Privacy** on page 69 for more information .

Receiving and Responding to a Group Call

To receive a call from a group of users, your radio must be configured as part of that group.

Procedure:

When you receive a Group Call (while on the Home screen):

- 1 The green LED blinks.
- 2 The first line of the display shows the caller alias, and the RSSI icon. The second line displays the group alias or ID, and the Group Call icon (in Digital mode only).
- 3  If the Channel Free Indication feature is enabled, you will hear a short alert tone the moment the transmitting radio releases the **PTT** button, indicating the channel is free for you to respond. Press the **PTT** button to respond to the call.
or
 If the Voice Interrupt feature is enabled, press the **PTT** button to stop the current call from the transmitting radio and free the channel for you to talk/respond.
- 4 The green LED lights up.

5 Wait for the Talk Permit Tone to finish (if enabled) and speak clearly into the microphone.

OR

 Wait for the PTT Sidetone to finish (if enabled) and speak clearly into the microphone.

6 Release the **PTT** button to listen.

7 If there is no voice activity for a predetermined period of time, the call ends.

See ***Making a Group Call*** on page 25 for details on making a Group Call.

NOTE: If the radio receives a Group Call while not on the Home screen, it remains on its current screen prior to answering the call.

Long press the  button to go to the Home screen to view the caller alias before replying.

Receiving and Responding to a Private Call

A Private Call is a call from an individual radio to another individual radio.

There are two types of Private Calls. The first type, where a radio presence check is performed prior to setting up the call, while the other sets up the call immediately.

When your radio is checked, the green LED blinks.

Only **one** of these call types can be programmed to your radio by your dealer.

Procedure:

When you receive a Private Call:

- 1 The green LED blinks.
- 2 The first line of the display shows the subscriber alias or ID, and the RSSI icon. The second line displays "Private Call" and the Private Call icon.
- 3 If the Channel Free Indication feature is enabled, you will hear a short alert tone the moment the transmitting radio releases the **PTT** button, indicating the channel is free for you to respond. Press the **PTT** button to respond to the call.
- 4 The green LED lights up.
- 5 Wait for the Talk Permit Tone to finish (if enabled) and speak clearly into the microphone.
- 6 Release the **PTT** button to listen.
- 7 If there is no voice activity for a predetermined period of time, the call ends.
- 8 You hear a short tone. The display shows "Call Ended".

See ***Making a Private Call*** on page 33 for details on making a Private Call.

Receiving an All Call

An All Call is a call from an individual radio to every radio on the channel. It is used to make important announcements requiring the user's full attention.

Procedure:

When you receive an All Call:

- 1 A tone sounds and the green LED blinks.
- 2 The first line of the display shows the caller alias, and the RSSI icon. The second line displays "All Call" and the All Call icon.
- 3 Once the All Call ends, the radio returns to the previous screen before receiving the call.
 -  If the Channel Free Indication feature is enabled, you will hear a short alert tone the moment the transmitting radio releases the **PTT** button, indicating the channel is now available for use.

You cannot respond to an All Call.



See **Making an All Call** on page 34 for details on making an All Call.

NOTE: The radio stops receiving the All Call if you switch to a different channel while receiving the call.

During an All Call, you will **not** be able to use any programmed button functions until the call ends.

■ Making a Radio Call

You can select a channel, subscriber alias or ID, or group alias or ID by using:

- The Channel Rocker
- A programmed **One Touch Access** button 
- The Contacts list (see **Contacts Settings** on page 47)
- Manual Dial (via Contacts) – This method is for Private Calls only and is dialed using the keypad (see **Making a Private Call from Contacts** on page 48) 

NOTE: Your radio must have the Privacy feature enabled on the channel to send a privacy-enabled transmission.

Only target radios with the same Privacy Key OR the same Key Value and Key ID as your radio will be able to unscramble the transmission.



See **Privacy** on page 69 for more information. 

Making a Call with the Channel Rocker

Making a Group Call

To make a call to a group of users, your radio must be configured as part of that group.

Procedure:

- 1 Press the Channel Rocker to select the channel with the active group alias or ID.
- 2 Press the **PTT** button to make the call. The green LED lights up. The display shows the group alias or ID, and the Group Call icon.
- 3 Wait for the Talk Permit Tone to finish (if enabled) and speak clearly into the microphone.
OR
 Wait for the PTT Sidetone to finish (if enabled) and speak clearly into the microphone.
- 4 Release the **PTT** button to listen. When the target radio responds, the green LED blinks. You see the Group Call icon, the group alias or ID, and transmitting radio alias or ID on your display.
- 5  If the Channel Free Indication feature is enabled, you will hear a short alert tone the moment the target radio releases the **PTT** button, indicating the channel is free for you to respond. Press the **PTT** button to respond.
OR

If there is no voice activity for a predetermined period of time, the call ends.

- 7 Radio returns to the screen you were on prior to initiating the call.

*You can also make a Group Call via Contacts (see **Making a Group Call from Contacts** on page 47).*

Making a Private Call

While you can receive and/or respond to a Private Call initiated by an authorized individual radio, your radio must be programmed for you to initiate a Private Call.

You will hear a negative indicator tone, when you make a Private Call via Menu, Call Log, Contacts list, **One Touch Access** button, or the Channel Rocker, if this feature is not enabled.

Use the Text Message or Call Alert features to contact an individual radio. See **Text Message Features** on page 60 or **Call Alert Operation** on page 53 for more information.

Procedure:

- 1 Press the Channel Rocker to select the channel with the active subscriber alias or ID.

- 2 Press the **PTT** button to make the call. The green LED lights up. The first line displays the subscriber alias or ID. The second line displays “Private Call” and the Private Call icon.
- 3 Wait for the Talk Permit Tone to finish (if enabled) and speak clearly into the microphone.
- 4 Release the **PTT** button to listen. When the target radio responds, the LED blinks green.
- 5 If the Channel Free Indication feature is enabled, you will hear a short alert tone the moment the target radio releases the **PTT** button, indicating the channel is free for you to respond. Press the **PTT** button to respond.
OR
If there is no voice activity for a predetermined period of time, the call ends.
- 6 You hear a short tone. The display shows “Call Ended”.

*You can also make a Private Call via Contacts (see **Making a Private Call from Contacts** on page 48).*

Making an All Call

This feature allows you to transmit to all users on the channel.

Your radio must be programmed to allow you to use this feature.

Procedure:

- 1 Press the Channel Rocker to select the channel with the active All Call group alias or ID.
- 2 Press the **PTT** button to make the call. The green LED lights up. The display shows the All Call group alias or ID, and the All Call icon.
- 3 Wait for the Talk Permit Tone to finish (if enabled) and speak clearly into the microphone.
OR
 Wait for the PTT Sidetone to finish (if enabled) and speak clearly into the microphone.

Users on the channel cannot respond to an All Call.

Making a Group or Private Call with the One Touch Access Button

The One Touch Access feature allows you to make a Group or Private Call to a predefined alias or ID easily. This feature can be assigned to a short or long programmable button press.

You can **ONLY** have one alias or ID assigned to a **One Touch Access** button. Your radio can have multiple **One Touch Access** buttons programmed.

Procedure:

- 1** Press the programmed **One Touch Access** button to make a Group or Private Call to the predefined alias or ID.

- 2** Press the **PTT** button to make the call. The green LED lights up. The display shows the group/subscriber alias or ID, and the Group/Private Call icon.

- 3** Wait for the Talk Permit Tone to finish (if enabled) and speak clearly into the microphone.
OR
 **For Group Call only:** Wait for the PTT Sidetone to finish (if enabled) and speak clearly into the microphone.

- 4** Release the **PTT** button to listen. When the target radio responds, the green LED blinks.

- 5** If the Channel Free Indication feature is enabled, you will hear a short alert tone the moment the target radio releases the **PTT** button, indicating the channel is free for you to respond. Press the **PTT** button to respond.

OR

If there is no voice activity for a predetermined period of time, the call ends.

- 6** Radio returns to the screen you were on prior to initiating the call.

For a Private Call, you hear a short tone when the call ends.

■ Talkaround

You can continue to communicate when your repeater is not operating, or when your radio is out of the repeater's range but within talking range of other radios. This is called "talkaround".



Procedure:



Press the programmed **Repeater/Talkaround** button to toggle between talkaround and repeater modes.



OR

Follow the procedure below.

- 1  to access the menu.

- 2  or  to "Utilities" and press  to select.

- 3  or  to "Radio Settings" and press  to select.

- 4  or  to "Talkaround" and press  to select.

- 5 You see "Turn On" if the radio is currently in Repeater mode.
OR
You see "Turn Off" if the radio is currently in Talkaround mode.

- 6 Press  to select.

- 7 The display shows "Talkaround On".

OR

The display shows "Talkaround Off".

- 8 The screen automatically returns to the previous menu.

The Talkaround setting is retained even after powering down.

■ Permanent Monitor

Use the Permanent Monitor feature to continuously monitor a selected channel for activity.

Procedure:

- 1 Press the programmed **Permanent Monitor** button.
- 2 Radio sounds an alert tone, the yellow LED lights up, and the display shows "Permanent Monitor On". The monitor icon appears on the display.
- 3 Press the programmed **Permanent Monitor** button to exit Permanent Monitor mode.
- 4 Radio sounds an alert tone, the yellow LED turns off, and display shows "Permanent Monitor Off".

ADVANCED FEATURES

Use this navigation guide to learn more about advanced features available with your radio:

Radio Check.....	page 38
Remote Monitor.....	page 40
Scan Lists.....	page 42
Scan.....	page 44
Contacts Settings.....	page 46
Call Indicator Settings.....	page 49
Call Log Features.....	page 51
Call Alert Operation.....	page 53
Emergency Operation.....	page 54
Text Message Features.....	page 60
Privacy.....	page 69
Security.....	page 70
Lone Worker.....	page 72
Utilities.....	page 72

■ Radio Check



If enabled, this feature allows you to determine if another radio is active in a system without disturbing the user of that radio. No audible or visual notification is shown on the target radio.

This feature is only applicable for subscriber aliases or IDs.

Sending a Radio Check

Procedure:

Use the programmed **Radio Check** button.



- 1 Press the programmed **Radio Check** button.
- 2  or  to the required subscriber alias or ID and press  to select.
- 3 The display shows “Radio Check: <Subscriber Alias or ID>”, indicating that Radio Check is in progress. The green LED lights up.
- 4 Wait for acknowledgement.
- 5 If the target radio is active in the system, a tone sounds and the display briefly shows “Target Radio Available”.
OR
If the target radio is not active in the system, a tone sounds and the display briefly shows “Target Radio Not Available”.
- 6 Radio returns to the subscriber alias or ID screen.



OR



Procedure:

Use the menu.

- 1  to access the menu.

 - 2  or  to “Contacts” and press  to select.

 - 3  or  to the required subscriber alias or ID and press  to select.

 - 4  or  to “Radio Check” and press  to select.

 - 5 The display shows “Radio Check: <Subscriber Alias or ID>”, indicating that Radio Check is in progress. The green LED lights up.

 - 6 Wait for acknowledgement.

 - 7 If the target radio is active in the system, a tone sounds and the display briefly shows “Target Radio Available”.
- OR
- If the target radio is not active in the system, a tone sounds and the display briefly shows “Target Radio Not Available”.
-
- 8 Radio returns to the subscriber alias or ID screen.
-

If the  button is pressed when the radio is waiting for acknowledgement, a tone sounds, and the radio terminates all retries and exits Radio Check mode.

■ Remote Monitor

Use the Remote Monitor feature to turn on the microphone of a target radio (subscriber alias or IDs only). No audible or visual indication is given to the target radio. You can use this feature to monitor, remotely, any audible activity surrounding the target radio.



Your radio must be programmed to allow you to use this feature.

Initiating Remote Monitor

Procedure:

Use the programmed **Remote Monitor** button.

- 1 Press the programmed **Remote Monitor** button.

- 2  or  to the required subscriber alias or ID and press  to select.

- 3 Radio sounds an alert tone and the green LED blinks.

- 4 Wait for acknowledgment.

- 5 The display shows “Remote Monitor Successful”.
OR
The display shows “Remote Monitor Failed”.

6 If successful:

The radio starts receiving audio from the monitored radio for a programmed duration.

Once the timer expires, the radio sounds an alert tone and the LED turns off. The display shows “Remote Monitor Ended”.

OR

If unsuccessful:



The radio repeats the attempt until the programmed number of tries expires.



OR



Procedure:

Use the menu.

- 1  to access the menu.

- 2  or  to “Contacts” and press  to select.

- 3  or  to the required subscriber alias or ID and press  to select.

- 4  or  to “Remote Mon.” and press  to select.

- 5 Radio sounds an alert tone and the green LED blinks.

- 6 Wait for acknowledgment.

- 7 The display shows “Remote Monitor Successful”.
OR
The display shows “Remote Monitor Failed”.

- 8 If successful:
The radio starts receiving audio from the monitored radio for a programmed duration. Once the timer expires, the radio sounds an alert tone and the LED turns off. The display shows “Remote Monitor Ended”.
OR
If unsuccessful:
The radio repeats the attempt until the programmed number of tries expires.
-

Stopping Remote Monitor

Procedure:

- 1 Press the programmed **Transmit Interrupt Remote Dekey** button.
 - 2 The display shows “Remote Dekey”.
 - 3 Wait for acknowledgment.
 - 4 The radio sounds a positive indicator tone and the display shows “Remote Dekey Success”, indicating that the channel is now free.
OR
The radio sounds a negative indicator tone and the display shows “Remote Dekey Failed”.
-

■ Scan Lists

Scan lists are created and assigned to individual channels/groups. Your radio scans for voice activity by cycling through the channel/group sequence specified in the scan list for the current channel/group.



Your radio can support up to 250 scan lists, with a maximum of 16 members in a list. Each scan list supports a mixture of both analog and digital entries.



You can add, delete, or prioritize channels by editing a scan list.



📄 Viewing an Entry in the Scan List

Procedure:

- 1  to access the menu.

- 2  or  to “Scan” and press  to select.

- 3  or  to “View/Edit List” and press  to select.

- 4 Use  or  to view each member on the list.

*The priority icon appears left of the member’s alias, if set, to indicate whether the member is on a Priority 1 or Priority 2 channel list. You **cannot** have multiple Priority 1 or Priority 2 channels in a scan list.*



*There is no priority icon if priority is set to **None**.*



📄 Editing the Scan List



📄 Adding a New Entry to the Scan List



Procedure:



- 1  to access the menu.

- 2  or  to “Scan” and press  to select.







- 3  or  to “View/Edit List” and press  to select.

- 4  or  to “Add Member” and press  to select.

- 5  or  to the required alias or ID and press  to select.

- 6  or  to the required priority level and press  to select.



- 7 The display shows “Entry Saved”, followed immediately by “Add Another?”.



- 8  or  to “Yes” and press  to select, to add another entry, and repeat Steps 5 and 6.
OR
 or  to “No” and press  to select to save the current list.



Deleting an Entry from the Scan List



Procedure:







- 1  to access the menu.

- 2  or  to “Scan” and press  to select.

- 3  or  to “View/Edit List” and press  to select.

- 4  or  to the required alias or ID and press  to select.

- 5  or  to “Delete” and press  to select.

- 6 At “Delete Entry?”,  or  to “Yes” and press  to select, to delete the entry. The display shows “Entry Deleted”.
OR
 or  to “No” and press  to select to return to the previous screen.



- 7 Repeat Steps 4 to 6 to delete other entries.



After deleting all required aliases or IDs, long press  to return to the Home screen.



Setting and Editing Priority for an Entry in the Scan List



Procedure:



- 1  to access the menu.

- 2  or  to “Scan” and press  to select.

- 3  or  to “View/Edit List” and press  to select.

- 4  or  to the required alias or ID and press  to select.

- 5  or  to “Edit Priority” and press  to select.

- 6  or  to the required priority level and press  to select.

- 7 The display shows “Entry Saved” before returning to the previous screen.

- 8 The priority icon appears left of the member’s name.

*There is no priority icon if priority is set to **None**.*

■ Scan

When you start a scan, your radio cycles through the programmed scan list for the current channel looking for voice activity.

The yellow LED blinks and you see the scan icon on the display.

During a dual mode scan, if you are on a digital channel, and your radio locks onto an analog channel, it automatically switches from digital mode to analog mode for the duration of the call. This is also true for the reverse.

There are two ways of initiating scan:

- **Main Channel Scan (Manual):** Your radio scans all the channels/groups in your scan list. On entering scan, your radio may – depending on the settings – automatically start on the last scanned “active” channel/group or on the channel where scan was initiated.
- **Auto Scan (Automatic):** Your radio automatically starts scanning when you select a channel/group that has Auto Scan enabled.

📄 Starting and Stopping Scan

Procedure:



Press the programmed **Scan** button to start or stop Scan.

OR

Follow the procedure below.

- 1 Use the **Channel Rocker** to select a channel programmed with a scan list.

- 2  to access the menu.

- 3  or  to “Scan” and press  to select.

- 4 The display shows “Turn On” if scan is disabled.
OR
The display shows “Turn Off” if scan is enabled.

- 5 Press  to select.

- 6 The yellow LED blinks and the scan icon is displayed when Scan is enabled.
OR
The LED turns off and the scan icon is not displayed when Scan is disabled.

While scanning, the radio will only accept data (e.g. text message) if received on its Selected Channel.

☐ Responding to a Transmission During a Scan

During scanning, your radio stops on a channel/group where activity is detected. The radio stays on that channel for a programmed time period known as “hang time”.

Procedure:

- 1  If the Channel Free Indication feature is enabled, you will hear a short alert tone the moment the transmitting radio releases the **PTT** button, indicating the channel is free for you to respond.

- 2 Press the **PTT** button during hang time. The green LED lights up.

- 3 Wait for the Talk Permit Tone to finish (if enabled) and speak clearly into the microphone.
OR
 Wait for the PTT Sidetone to finish (if enabled) and speak clearly into the microphone.

- 4 Release the **PTT** button to listen.

- 5 If you do not respond within the hang time, the radio returns to scanning other channels/groups.

☐ Deleting a Nuisance Channel

If a channel continually generates unwanted calls or noise (termed a “nuisance” channel), you can temporarily remove the unwanted channel from the scan list.

This capability does not apply to the channel designated as the Selected Channel.

Procedure:

- 1 When your radio “locks on to” an unwanted or nuisance channel, press the programmed **Nuisance Channel Delete** button until you hear a tone.

- 2 Release the **Nuisance Channel Delete** button.
The nuisance channel is deleted.

*Deleting a “nuisance” channel is **only** possible through the programmed **Nuisance Channel Delete** button. This feature is **not** accessible through the menu.*

Restoring a Nuisance Channel

Procedure:

To restore the deleted nuisance channel, do one of the following:

- Turn the radio off and then power it on again, OR
- Stop and restart a scan via the programmed **Scan** button or menu, OR
- Change the channel via the Channel Rocker.

■ Contacts Settings

Contacts provides “address-book” capabilities on your radio. Each entry corresponds to an alias or ID that you use to initiate a call.

Additionally, each entry, depending on context, associates with one of five types of calls: Group Call, Private Call or All Call.

NOTE: If the Privacy feature is enabled on a channel, you can make privacy-enabled Group Call, Private Call, and All Call on that channel. Only target radios with the same Privacy Key OR the same Key Value and Key ID as your radio will be able to unscramble the transmission.

See **Privacy** on page 69 for more information. 

Your radio supports two Contacts lists, one for Analog contacts and one for Digital contacts, with a maximum of 500 members for each Contacts list.

Each entry within Contacts displays the following information:







- Call Type
- Call Alias
- Call ID

NOTE: You can add, delete, or edit subscriber IDs for the Digital Contacts list.

For the Analog Contacts list, you can only view the list and initiate a Call Alert. Adding, deleting, and editing capabilities can only be performed by your dealer.

Making a Group Call from Contacts

Procedure:

- 1  to access the menu.
- 2  or  to “Contact” and press  to select. The entries are alphabetically sorted.
- 3  or  to the required group alias or ID.
- 4 Press the **PTT** button to make the call. The green LED lights up. The display shows the group alias or ID, and the Group Call icon.
- 5 Wait for the Talk Permit Tone to finish (if enabled) and speak clearly into the microphone.

OR

 Wait for the PTT Sidetone to finish (if enabled) and speak clearly into the microphone.

- 6 Release the **PTT** button to listen. When any user in the group responds, the green LED blinks. You see the Group Call icon, the group alias or ID, and that user’s alias or ID on your display.

- 7  If the Channel Free Indication feature is enabled, you will hear a short alert tone the moment the target radio releases the **PTT** button, indicating the channel is free for you to respond. Press the **PTT** button to respond.



OR



If there is no voice activity for a programmed period of time, the call ends.

Making a Private Call from Contacts

Procedure:

- 1  to access the menu.

- 2  or  to “Contact” and press  to select. The entries are alphabetically sorted.

- 3  or  to the required subscriber alias or ID.

- 4 Press the **PTT** button to make the call. The green LED lights up. The first line displays the subscriber alias or ID. The second line displays “Private Call” and the Private Call icon.

- 5 Wait for the Talk Permit Tone to finish (if enabled) and speak clearly into the microphone.

- 6 Release the **PTT** button to listen. When the target radio responds, the green LED blinks and the display shows the transmitting user’s alias or ID.

- 7 If the Channel Free Indication feature is enabled, you will hear a short alert tone the moment the target radio releases the **PTT** button, indicating the channel is free for you to respond. Press the **PTT** button to respond.
OR
If there is no voice activity for a programmed period of time, the call ends.

- 8 You hear a short tone. The display shows “Call Ended”.

NOTE: If you release the **PTT** button while the radio is setting up the call, it exits without any indication and returns to the previous screen.

Your radio may be programmed to perform a radio presence check prior to setting up the Private Call. If the target radio is not available, you hear a short tone and see “Party Not Available” on the display.

















The radio returns to the menu prior to initiating the radio presence check.

■ Call Indicator Settings

☐ Activating and Deactivating Call Ringers for Private Calls

You can turn on or off the ringing tones for a received Private Call.

Procedure:

- 1  to access the menu.
- 2  or  to “Utilities” and press  to select.
- 3  or  to “Radio Settings” and press  to select.
- 4  or  to “Tones/Alerts” and press  to select.
- 5  or  to “Call Ringers” and press  to select.
- 6  or  to “Private Call” and press  to select.
- 7 The display shows “Turn On”. Press  to enable Call Ringers for Private Calls. The display shows “Private Call Ringer On”.



















OR

The display shows “Turn Off”. Press  to disable Call Ringers for Private Calls. The display shows “Private Call Ringer Off”.

☐ Activating and Deactivating Call Ringers for Text Message



You can turn on or off the ringing tones for a received Text Message.

Procedure:

- 1  to access the menu.
- 2  or  to “Utilities” and press  to select.
- 3  or  to “Radio Settings” and press  to select.
- 4  or  to “Tones/Alerts” and press  to select.
- 5  or  to “Call Ringers” and press  to select.
- 6  or  to “Text Message” and press  to select.
- 7 The current tone is indicated by a “✓”.
- 8  or  to the preferred tone and press  to select.

The display shows “Tone <Number> Selected” and a “✓” appears left of the selected tone.

OR



 or  to “Turn Off” and press N to select. The display shows “Text Message Ringer Off” and a “✓” appears left of “Turn Off”.



Assigning Ring Styles



You can program your radio to sound one of ten predefined ringing tones when receiving a Call Alert or a Text Message from a particular contact.

Procedure:



- 1  to access the menu.

- 2  or  to “Contacts” and press  to select. The entries are alphabetically sorted.

- 3  or  to the required alias or ID and press N to select.

- 4  or  to “Ring Style” and press  to select.

- 5 A “✓” indicates the current selected tone.

- 6  or  to the required tone and press  to select.

- 7 The display shows “Contact Saved”.



The radio sounds out each ring style as you navigate through the list.



Escalating Alarm Tone Volume



You can program your radio to continually alert you when a radio call remains unanswered. This is done by automatically increasing the alarm tone volume over time. This feature is known as Escalert.



Procedure:



- 1  to access the menu.

- 2  or  to “Utilities” and press  to select.

- 3  or  to “Radio Settings” and press  to select.

- 4  or  to “Tones/Alerts” and press  to select.

- 5  or  to “Escalert” and press  to select.

- 6 The display shows Turn On. Press  to enable Escalert.
The display shows “Escalert On”.
OR
The display shows “Turn Off”. Press  to disable Escalert.
The display shows “Escalert Off”.

■ Call Log Features

Your radio keeps track of all recent outgoing, answered, and missed Private Calls. Use the call log feature to view and manage recent calls.









You can perform the following tasks in each of your call lists:

- Store ID to Contacts
- Delete

Viewing Recent Calls

The lists are Missed, Answered, and Outgoing.

Procedure:

- 1  to access the menu.
- 2  or  to “Call Log” and press  to select.
- 3  or  to preferred list and press  to select.
- 4 The display shows the most recent entry at the top of the list.
- 5  or  to view the list.





Press the **PTT** button to start a Private Call with the current selected alias or ID.

Missed Call Screen

Whenever a call is missed, your radio displays a missed call message. Select “View” to view it immediately or “View Later” to view at a later time.

NOTE: The radio exits the Missed Call screen and sets up a Private Call if you press the **PTT** button while viewing a missed call number.



Procedure:



- 1 The display shows “Missed Calls”, along with the number of calls missed and “View?”.
- 2 Press  to view the missed call ID. The missed call log list appears on display. Press  to store or delete the entry.
OR
 or  to “View Later” and press  to select. You return to the Home screen.



Deleting a Call from a Call List



Procedure:



- 1  to access the menu.

- 2  or  to “Call Log” and press  to select.

- 3  or  to the required list and press  to select.

- 4  or  to the required alias or ID and press  to select.

- 5  or  to “Delete Entry?” and press  to select.

- 6  or  to select “Yes” and press  to select.

- 7 The display shows “Entry Deleted”.

When you select a call list and it contains no entries, the display shows “List Empty”, and sounds a low tone.

■ Call Alert Operation

Call Alert paging enables you to alert a specific radio user to call you back when they are able to do so.

This feature is applicable for subscriber aliases or IDs only and is accessible through the menu via Contacts or manual dial.

📄 Receiving and Responding to a Call Alert









When you receive a Call Alert page, you see “Call Alert” that alternates with the alias or ID of the calling radio on the display.

Procedure:

- 1 You hear a repetitive tone. The yellow LED blinks.
- 2 Press the **PTT** button within four (4) seconds of receiving a Call Alert page to respond to the Private Call.
OR
Press  to exit the Call Alert.

📄 Making a Call Alert from the Contacts List

Procedure:

- 1  to access the menu.
- 2  or  to “Contacts” and press  to select.
- 3  or  to the required subscriber alias or ID and press **[OK]** to select.
- 4  or  to “Call Alert” and press  to select.
- 5 The display shows “Call Alert: <Subscriber Alias or ID>”, indicating that the Call Alert has been sent.
- 6 The green LED lights up when your radio is sending the Call Alert.
- 7 If the Call Alert acknowledgement is received, a tone sounds and the display shows “Call Alert Successful”.
OR
If the Call Alert acknowledgement is not received, a tone sounds and the display shows “Call Alert Failed”.

📄 Making a Call Alert with the One Touch Access Button

Procedure:

- 1 Press the programmed **One Touch Access** button to make a Call Alert to the predefined alias or ID.

- 2 The display shows “Call Alert: <Subscriber Alias or ID>”, indicating that the Call Alert has been sent.

- 3 The green LED lights up when your radio is sending the Call Alert.

- 4 If the Call Alert acknowledgement is received, a tone sounds and the display shows “Call Alert Successful”.
OR
If the Call Alert acknowledgement is not received, a tone sounds and the display shows “Call Alert Failed”.

■ Emergency Operation

An Emergency Alarm is used to indicate a critical situation. You are able to initiate an Emergency at any time on any screen display even when there is activity on the current channel.

Your dealer can set the duration of a button press for the programmed **Emergency** button, except for long press, which is similar with all other buttons:

- Short press – Between 0.05 seconds and 0.75 seconds
- Long press – Between 1.00 second and 3.75 seconds

The B button is assigned with the Emergency On/Off feature. Check with your dealer for the assigned operation of the **Emergency** button.

*If short press the **Emergency** button is assigned to turn on the Emergency mode, then long press the **Emergency** button is assigned to exit the Emergency mode.*

*If long press the **Emergency** button is assigned to turn on the Emergency mode, then short press the **Emergency** button is assigned to exit the Emergency mode.*

Your radio supports three Emergency Alarms:

- Emergency Alarm
- Emergency Alarm with Call
- Emergency Alarm with Voice to Follow 

In addition, each alarm has the following types:

- **Regular** – Radio transmits an alarm signal and shows audio and/or visual indicators.
- **Silent** – Radio transmits an alarm signal without any audio or visual indicators. Radio receives calls without any sound through the radio's speaker, until you press the **PTT** button to initiate the call.
- **Silent with Voice** – Radio transmits an alarm signal without any audio or visual indicators, but allow incoming calls to sound through the radio's speaker.

Only **ONE** of the Emergency Alarms above can be assigned to the programmed **Emergency** button or the **Emergency** footswitch.

Receiving an Emergency Alarm

Procedure:

- 1 When receiving an Emergency Alarm, the display shows the Emergency icon, the number of alarms received, and "Alarm Rcvd", which alternates with the alias or ID of the sender.
- 2 A tone sounds and the red LED blinks.
- 3 Your radio automatically acknowledges the Emergency Alarm (if enabled).

When your radio receives an Emergency Alarm, it displays the Emergency Alarm received indications until acknowledgement is sent (if enabled) and you exit the Emergency mode.

You will not be able to receive any other indications or displays for any other calls until you exit the Emergency Alarm received screen.

NOTE: Press , then press **Emergency Off** button immediately to clear the Emergency Alarm received indications and exit Emergency mode.

Press , then press **Emergency On** button immediately to toggle the Emergency feature between hidden or shown.

When your radio receives an Emergency Alarm, and you change the radio channel, the Emergency Alarm list is hidden.

The new channel displays the Emergency icon and the red LED blinks. When you change the radio channel back to the previous channel, it also displays the Emergency icon and the red LED blinks.

Responding to an Emergency Alarm

Procedure:

When receiving an Emergency Alarm:

- 1 Press any button to stop all Emergency Alarm received indications.

- 2  If the Channel Free Indication feature is enabled, you will hear a short alert tone the moment the transmitting radio releases the **PTT** button, indicating the channel is free for you to respond.

- 3 Press **PTT** button to transmit non-emergency voice to the same group that the Emergency Alarm was targeted to. The green LED lights up. Your radio remains in the Emergency mode.

- 4 Wait for the Talk Permit Tone to finish (if enabled) and speak clearly into the microphone.
OR
 Wait for the PTT Sidetone to finish (if enabled) and speak clearly into the microphone.

- 5 Release the **PTT** button to listen. When the emergency initiating radio responds, the green LED blinks. You see the Group Call icon, the group alias or ID, and transmitting radio alias or ID on your display.

- 6 Once your call ends, press , then press **Emergency Off** button immediately to clear the Emergency Call received indications and exit Emergency mode.

- 7 The radio returns to the Home screen.

Emergency voice can only be transmitted by the emergency initiating radio. All other radios (including the emergency receiving radio) transmit non-emergency voice.

Sending an Emergency Alarm

This feature allows you to send an Emergency Alarm, a non-voice signal, which triggers an alert indication on a group of radios.

Procedure:

- 1 Press the programmed **Emergency On** button or the **Emergency** footswitch.

- 2 The display shows “Sending Alarm”, which alternates with your radio ID. The green LED lights up and the Emergency icon appears on the Home screen display.

- 3 When an Emergency Alarm acknowledgment is received, the Emergency tone sounds and the LED blinks green. The display shows “Emergency Alarm Successful”.
OR
If your radio does not receive an Emergency Alarm acknowledgement, and after all retries have been exhausted, a tone sounds and the display shows “Emergency Alarm Failed”.

- 4 Radio exits the Emergency Alarm mode and returns to the Home screen.

If your radio is set to Silent, it will not display any audio or visual indicators during Emergency mode.

Sending an Emergency Alarm with Call

This feature allows you to send an Emergency Alarm to a group of radios. Upon acknowledgement by a radio within the group, the group of radios can communicate over a programmed Emergency channel.

Procedure:

- 1 Press the programmed **Emergency On** button.

- 2 The display shows “Sending Alarm”, which alternates with your radio ID. The green LED lights up and the Emergency icon appears on the Home screen display.

- 3 When an Emergency Alarm acknowledgment is received, the Emergency tone sounds and the green LED blinks. The display shows “Emergency Alarm Successful”.

- 4 Press **PTT** button to make the call. The green LED lights up and the group icon appears on the display.

- 5 Wait for the Talk Permit Tone to finish (if enabled) and speak clearly into the microphone.
OR
 Wait for the PTT Sidetone to finish (if enabled) and speak clearly into the microphone.

- 6 Release the **PTT** button to listen.

7 When the channel is free for you to respond, a short alert tone sounds (🔊 if the Channel Free Indication feature is enabled). Press the **PTT** button to respond.

OR

Once your call ends, press **Emergency Off** button to exit the Emergency mode.

9 The radio returns to the Home screen.

*If your radio is set to Silent, it will not display any audio or visual indicators during Emergency mode, or allow any received calls to sound through the radio's speaker, until you press the **PTT** button to initiate the call.*

*If your radio is set to Silent with Voice, it will not display any audio or visual indicators during Emergency mode, but allow incoming calls to sound through the radio's speaker. The indicators will only appear once you press the **PTT** button to initiate, or respond to, the call.*

📄 Sending an Emergency Alarm with Voice to Follow 🔊

This feature allows you to send an Emergency Alarm to a group of radios. Your radio's microphone is automatically activated, allowing you to communicate with the group of radios without pressing the **PTT** button.

This activated microphone state is also known as "hot mic".

If you press the **PTT** button during the programmed hot mic transmission period, the radio ignores the **PTT** press and remains in Emergency mode.

NOTE: If you press the **PTT** button during hot mic, and continue to press it after the hot mic duration expires, the radio continues to transmit until you release the **PTT** button.

Procedure:

- 1 Press the programmed **Emergency On** button.
- 2 The display shows "Sending Alarm". The green LED lights up and the Emergency icon is displayed.

- 3 Once the display shows “Emergency Alarm Successful”, speak clearly into the microphone. When hot mic has been enabled, the radio automatically transmits without a **PTT** press until the hot mic duration expires.

- 4 While transmitting, the green LED lights up and the Emergency icon appears on the display.

- 5 Once the hot mic duration expires, the radio automatically stops transmitting. To transmit again, press the **PTT** button.

*If your radio is set to Silent, it will not display any audio or visual indicators during Emergency mode, or allow any received calls to sound through the radio’s speaker, until the programmed hot mic transmission period is over, and you press the **PTT** button.*

*If your radio is set to Silent with Voice, it will not display any audio or visual indicators during Emergency mode when you are making the call with hot mic, but allow sound through the radio’s speaker when the target radio responds after the programmed hot mic transmission period is over. The indicators will only appear when you press the **PTT** button.*

NOTE: If the Emergency Alarm request fails, the radio does not retry to send the request, and enters the hot mic state directly.

Reinitiating an Emergency Mode

NOTE: This feature is only applicable to the radio sending the Emergency Alarm.

There are two instances where this can happen:

- You change the channel while the radio is in Emergency mode. This exits the Emergency mode. If Emergency Alarm is enabled on this new channel, the radio reinitiates Emergency.
- You press the programmed **Emergency On** button during an Emergency initiation/transmission state. This causes the radio to exit this state, and to reinitiate Emergency.

📄 Exiting Emergency Mode

NOTE: This feature is only applicable to the radio sending the Emergency Alarm.

Your radio exits Emergency mode when **one** of the following occurs:

- Emergency Alarm acknowledgement is received (for **Emergency Alarm** only), OR
- All retries to send the alarm have been exhausted, OR
- The **Emergency Off** button is pressed.

NOTE: If your radio is powered off, it exits the Emergency mode. The radio will not reinitiate the Emergency mode automatically when it is turned on again.

■ Text Message Features

Your radio is able to receive a text message from another radio or an e-mail application.

📄 Sending a Quick Text Message













Your radio supports a maximum of ten (10) Quick Text messages as programmed by your dealer.

Procedure:

Press the programmed **Text Message** button and proceed to Step 3.

OR

Follow the procedure below.

- 1  to access the menu.
- 2  or  to “Message” and press  to select.
- 3  or  to “Quick Text” and press  to select.
- 4  or  to the required Quick Text and press  to select.
- 5  or  to the required alias or ID and press  to select.
- 6 The display shows “Text Message: <Subscriber/ Group Alias or ID>”, confirming your message is being sent.
- 7 If the message is sent successfully, a tone sounds and the display shows “Message Sent”.

OR

If the message cannot be sent, a low tone sounds the display shows “Message Send Failed”.

Sending a Quick Text Message with the One Touch Access Button

Procedure:

- 1 Press the programmed **One Touch Access** button to send a predefined Quick Text message to a predefined alias or ID.

- 2 The display shows “Text Message: <Subscriber/ Group Alias or ID>”, confirming your message is being sent.

- 3 If the message is sent successfully, a tone sounds and the display shows “Message Sent”.
OR
If the message cannot be sent, the display shows “Message Send Failed”.

Managing Text Messages in the Drafts Folder

The Drafts folder stores a maximum of ten (10) last saved messages. When the folder is full, the next saved text message automatically replaces the oldest text message in the folder.

Viewing a Saved Text Message



Procedure:



Press the programmed **Text Message** button and proceed to Step 3.



OR

Follow the procedure below.

- 1  to access the menu.

- 2  or  to “Message” and press  to select.

- 3  or  to “Drafts” and press  to select.

- 4  or  to the required message and press  to select.

 **Deleting a Saved Text Message from Drafts**



Procedure:



Press the programmed **Text Message** button and proceed to Step 3.



OR



Follow the procedure below.

- 1  to access the menu.

- 2  or  to “Messages” and press  to select.

- 3  or  to “Drafts” and press  to select.

- 4  or  to the required message and press  to select.

- 5  or  to “Delete” and press  to delete the text message.

 **Managing Fail-to-Send Text Messages**

You can select one of the following options while at the “Resend” option screen:

- Resend
- Forward

NOTE: If the channel type (i.e. conventional digital) is not a match, you can only edit and forward a Fail-to-Send message.

 **Resending a Text Message**

Procedure:





- 1 Press  to resend the same message to the same subscriber/group alias or ID.

- 2 If the message is sent successfully, a tone sounds and the display shows “Message Sent”.
OR
If the message cannot be sent, the display shows “Message Send Failed”.

 **Forwarding a Text Message**

Select “Forward” to send the message to another subscriber/group alias or ID.

Procedure:

- 1  or  to “Forward” and press  to select.
- 2  or  to the required alias or ID and press **[OK]** to select.

- 3 The display shows “Text Message: <Subscriber/ Group Alias or ID>”, confirming your message is being sent.

- 4 If the message is sent, a tone sounds and the display shows “Message Sent”.
OR
If the message is not sent, a low tone sounds and the display shows “Message Send Failed”.

Managing Sent Text Messages

Once a message is sent to another radio, it is saved in Sent Items. The most recent sent text message is always added to the top of the Sent Items list.

The Sent Items folder is capable of storing a maximum of thirty (30) last sent messages. When the folder is full, the next sent text message automatically replaces the oldest text message in the folder.

NOTE: Long press  at any time to return to the Home screen.

Viewing a Sent Text Message



Procedure:



Press the programmed **Text Message** button and proceed to Step 3.



OR

Follow the procedure below.

- 1  to access the menu.

- 2  or  to “Messages” and press  to select.

- 3  or  to “Sent Items” and press  to select.

- 4  or  to the required message and press  to select.

A subject line may be shown if the message is from an e-mail application.

- 5 The icon at the top right corner of the screen indicates the status of the message (see **Sent Item Icons** on page 26).

Sending a Sent Text Message



You can select one of the following options while viewing a sent text message:

- Resend
- Forward
- Edit
- Delete

NOTE: If the channel type (i.e. conventional digital) is not a match, you can only edit, forward, or delete a Sent message.

Procedure:



- 1 Press  again while viewing the message.

- 2  or  to “Resend” and press  to select.

- 3 The display shows “Sending to: <Subscriber/Group Alias or ID>”, confirming that the same message is being sent to the same target radio.



- 4 If the message is sent, a tone sounds and the display shows “Message Sent”.
OR
If the message is not sent, a low tone sounds and the display shows “Message Send Failed”.

If the message fails to send, the radio returns you to the “Resend” option screen. Press  to resend the message to the same subscriber/group alias or ID.

NOTE: Changing the volume, and pressing any button, except for , , or , returns you to the message.

The radio exits the “Resend” option screen if you press the **PTT** button to initiate a Private or Group Call, or to respond to a Group Call. The radio also exits the screen when it receives a text or telemetry message, an emergency call or alarm, or a call alert.

The display returns to the “Resend” option screen if you press the **PTT** button to respond to a Private Call (except when the radio is displaying the Missed Call screen), and at the end of an All Call.

Press  or  to access the “Forward”, “Edit”, or “Delete” option screen:

- Select “Forward” to send the selected text message to another subscriber/group alias or ID (see **Forwarding a Text Message** on page 62).
- Select “Delete” to delete the text message.

NOTE: If you exit the message sending screen while the message is being sent, the radio updates the status of the message in the Sent Items folder without providing any indication in the display or via sound.

If the radio changes mode or powers down before the status of the message in Sent Items is updated, the radio cannot complete any In-Progress messages and automatically marks it with a Send Failed icon.

The radio supports a maximum of five (5) In-Progress messages at one time. During this period, the radio cannot send any new message and automatically marks it with a Send Failed icon.

Deleting All Sent Text Messages from Sent Items



Procedure:



Press the programmed **Text Message** button and proceed to Step 3.



OR

Follow the procedure below.

- 1  to access the menu.



- 2  or  to “Messages” and press  to select.

- 3  or  to “Sent Items” and press  to select.

- 4  or  to “Delete All” and press  to select.

- 5 At “Delete Message?”, press  to select “Yes”.
The display shows “Sent Items Cleared”.

OR

At “Delete Message?”,  or  to “No” and press  to return to the previous screen.

When you select Sent Items and it contains no text messages, the display shows “List Empty”.

Receiving a Text Message

When your radio receives a message, the display shows the alias or ID of the sender and the message icon at the far left of the screen.



You can select one of the following options when receiving a text message:

- Read?
- Read Later
- Delete



NOTE: The radio exits the Text Message alert screen and sets up a Private or Group Call if the **PTT** button is pressed when the radio is displaying the alert screen.

Reading a Text Message

Procedure:

- 1  or  to “Read?” and press  to select.

- 2 Selected message in the Inbox opens.
A subject line may be shown if the message is from an e-mail application.

- 3 Press  to return to the Inbox.
OR
Press  to reply, forward, or delete the text message.

Press or to access the “Read Later” or “Delete” option screen:

- Select “Read Later” to return to the screen you were on prior to receiving the text message.
- Select “Delete” to delete the text message.

Managing Received Text Messages

Use the Inbox to manage your text messages. The Inbox is capable of storing a maximum of 30 messages.

Your radio supports the following options for text messages:

- Reply (via Quick Text)
- Forward
- Delete
- Delete All

NOTE: If the channel type (i.e. conventional digital) is not a match, you can only forward, delete, or delete all Received messages.

Text messages in the Inbox are sorted according to the most recently received.

NOTE: Long press at any time to return to the Home screen.

Viewing a Text Message from the Inbox

Procedure:

- 1 to access the menu.
- 2 or to “Messages” and press to select.
- 3 or to “Inbox” and press to select.
- 4 or to view the messages.

A subject line may be shown if the message is from an e-mail application.

- 5 Press to select the current message, and press again to reply, forward, or delete that message.

OR

Long press to return to the Home screen.

Unread messages are indicated with an exclamation mark (!).

Replying to a Text Message from the Inbox

Procedure:









Press the programmed **Text Message** button and proceed to Step 3.

OR

Follow the procedure below.

- 1 to access the menu.
- 2 or to “Messages” and press to select.
- 3 or to “Inbox” and press to select.
- 4 or to the required message and press to select.

A subject line may be shown if the message is from an e-mail application.

- 5 Press [OK] once more to access the sub-menu.
- 6  or  to "Reply" and press  to select.
- 7  or  to "Quick Text" and press  to select.
- 8  or  to the required message and press  to select.
- 9 The display shows "Text Message: <Subscriber/Group Alias or ID>", confirming your message is being sent.
- 10 If the message is sent successfully, a tone sounds and the display shows "Message Sent".
OR
If the message cannot be sent, the display shows "Message Send Failed".

















Deleting a Text Message from the Inbox

Procedure:

Press the programmed **Text Message** button and proceed to Step 3.

OR

Follow the procedure below.

- 1  to access the menu.
- 2  or  to "Messages" and press  to select.
- 3  or  to "Inbox" and press  to select.
- 4  or  to the required message and press  to select.
A subject line may be shown if the message is from an e-mail application.
- 5 Press  once more to access the sub-menu.
- 6  or  to "Delete" and press  to select.
- 7 At "Delete Message?",  or  to "Yes" and press  to select.
- 8 The display shows "Message Deleted".
- 9 The screen returns to the Inbox.

Deleting All Text Messages from the Inbox



Procedure:



Press the programmed **Text Message** button and proceed to Step 3.



OR



Follow the procedure below.

- 1  to access the menu.

- 2  or  to "Messages" and press  to select.

- 3  or  to "Inbox" and press  to select.

- 4  or  to "Delete All" and press  to select.

- 5 At "Delete Message?",  or  to "Yes" and press  to select.

- 6 The display shows "Inbox Cleared".

When you select the Inbox and it contains no text messages, the display shows "List Empty".

■ Privacy

If enabled, this feature helps to prevent eavesdropping by unauthorized users on a channel by the use of a software-based scrambling solution. The signaling and user identification portions of a transmission are not scrambled.

Your radio must have privacy enabled on the channel to send a privacy-enabled transmission, although this is not a necessary requirement for receiving a transmission. While on a privacy-enabled channel, the radio is still able to receive clear (unscrambled) transmissions.

To unscramble a privacy-enabled call or data transmission, your radio must be programmed to have the same Privacy Key as the transmitting radio.

If your radio receives a scrambled call that is of a different Privacy Key, you will hear a garbled transmission.

The green LED lights up while the radio is transmitting and blinks green rapidly when the radio is receiving an ongoing privacy-enabled transmission.







Procedure:





Press the programmed **Privacy** button to toggle privacy on or off.

OR

Follow the procedure below.

- 1  to access the menu.

- 2  or  to “Utilities” and press  to select.
- 3  or  to “Radio Settings” and press  to select.

- 4  or  to “Privacy” and press  to select.
- 5 The display shows “Privacy” and “Turn On”. Press  to enable privacy. The display shows the secure icon and “Privacy On”.
OR
The display shows “Privacy” and “Turn Off”. Press  to disable privacy. The display shows the unsecure icon and “Privacy Off”.

If the radio has a privacy type assigned, the Home screen shows the secure or unsecure icon, except when the radio is sending or receiving an Emergency call or alarm.

■ Security 



You can enable or disable any radio in the system. For example, you might want to disable a stolen radio, to prevent the thief from using it, and enable that radio, when it is recovered.

NOTE: Performing Radio Disable and Enable is limited to radios with these functions enabled.

 **Radio Disable**

Procedure:

Use the programmed **Radio Disable** button.

- 1 Press the programmed **Radio Disable** button.
- 2  or  to the required subscriber alias or ID and press  to select.
- 3 The display shows “Radio Disable: <Subscriber Alias or ID>” and the green LED lights up.
- 4 Wait for acknowledgment.
- 5 If successful, a tone sounds and the display shows “Radio Disable Successful”.









OR

If not successful, a tone sounds and the display shows “Radio Disable Failed”.

OR

Procedure:

Use the menu.

- 1  to access the menu.
- 2  or  to “Contacts” and press  to select. The entries are alphabetically sorted.
- 3  or  to the required alias or ID and press **[OK]** to select.
- 4  or  to “Radio Disable” and press  to select. The green LED blinks.
- 5 The display shows “Radio Disable: <Subscriber Alias or ID>” and the green LED lights up.
- 6 Wait for acknowledgment.
- 7 If successful, a tone sounds and the display shows “Radio Disable Successful”.

OR



If not successful, a tone sounds and the display shows “Radio Disable Failed”.

Do not press  during the Radio Disable operation as you will not get an acknowledgement message.

Radio Enable

Procedure:

Use the programmed **Radio Enable** button.

- 1 Press the programmed **Radio Enable** button.
- 2  or  to the required alias or ID and press  to select.
- 3 The display shows “Radio Enable: <Subscriber Alias or ID>” and the green LED lights up.
- 4 Wait for acknowledgment.
- 5 If successful, a tone sounds and the display shows “Radio Enable Successful”.











OR

If not successful, a tone sounds and the display shows “Radio Enable Failed”.

OR

Procedure:

Use the menu.

- 1  to access the menu.
- 2  or  to “Contacts” and press  to select. The entries are alphabetically sorted.
- 3  or  to the required alias or ID and press  to select.
- 4  or  to “Radio Enable” and press  to select. The green LED blinks.
- 5 The display shows “Radio Enable: <Subscriber Alias or ID>” and the green LED lights up.
- 6 Wait for acknowledgment.
- 7 If successful, a tone sounds and the display shows “Radio Enable Successful”.

OR

If not successful, a tone sounds and the display shows “Radio Enable Failed”.

Do not press  during the Radio Enable operation as you will not get an acknowledgement message.

■ Lone Worker

This feature prompts an emergency to be raised if there is no user activity, such as any radio button press or activation of the channel selector, for a predefined time.

Following no user activity for a programmed duration, the radio pre-warns the user via an audio indicator once the inactivity timer expires.

If there is still no acknowledgment by the user before the predefined reminder timer expires, the radio initiates an Emergency Alarm.

Only one of the following Emergency Alarms is assigned to this feature:

- Emergency Alarm
- Emergency Alarm with Call
- Emergency Alarm with Voice to Follow 

The radio remains in the emergency state allowing voice messages to proceed until action is taken. See **Emergency Operation** on page 52 on ways to exit Emergency.

NOTE: This feature is limited to radios with this function enabled. Check with your dealer or system administrator for more information.

■ Utilities

Setting the Squelch Level

You can adjust your radio's squelch level to filter out unwanted calls with low signal strength or channels that have a higher than normal background noise.

Settings: "Normal" is the default. "Tight" filters out (unwanted) calls and/or background noise. However, calls from remote locations may also be filtered out.



Procedure:



Press the programmed **Squelch** button to toggle squelch level between normal and tight.



OR

Follow the procedure below.

- 1  to access the menu.

- 2  or  to "Utilities" and press  to select.

- 3  or  to "Radio Settings" and press  to select.

- 4  or  to "Squelch" and press  to select.

- 5 Choose either "Tight" or "Normal" and press  to select.

- 6 Screen returns to the previous menu.

Setting the Power Level

You can customize your radio's power setting to high or low for each channel.



Settings: “High” enables communication with radios located at a considerable distance from you. “Low” enables communication with radios in closer proximity.



Procedure:



Press the programmed **Power Level** button to toggle transmit power level between high and low.
OR

Follow the procedure below.

- 1  to access the menu.

- 2  or  to “Utilities” and press  to select.

- 3  or  to “Radio Settings” and press  to select.

- 4  or  to “Power” and press  to select.

- 5 Change your current setting as prompted on the display.

- 6 Press  to select a new power level.

- 7 Screen returns to the previous menu.

Long press  to return to the Home screen. The power level icon is visible.

Turning the Voice Operating Transmission (VOX) Feature On or Off

This feature allows you to initiate a hands-free voice activated call on a programmed channel. The radio automatically transmits, for a programmed period, whenever the microphone on the VOX-capable accessory detects voice.

NOTE: You may need to turn off the radio and power it up again after detaching the VOX-capable microphone from it to allow the radio to switch to another valid accessory.

Pressing the **PTT** button during radio operation will disable VOX. To re-enable VOX, do **one** of the following:

- Turn the radio off and power it on again, OR
- Change the channel via the Channel Rocker, OR
- Follow the procedure below.

NOTE: Turning this feature on or off is limited to radios with this function enabled. Check with your dealer or system administrator for more information.



Procedure:



Press the programmed **VOX** button to toggle the feature on or off.



OR

Follow the procedure below.

- 1  to access the menu.

- 2  or  to “Utilities” and press  to select.

- 3  or  to “Radio Settings” and press  to select.

- 4  or  to “VOX” and press  to select.

- 5 The display shows “VOX On”. Press  to disable VOX. A tone sounds and the display shows “VOX Off”.

OR

The display shows “VOX Off”. Press  to enable VOX. A tone sounds and the display shows “VOX On”.

*If the Talk Permit Tone feature is enabled (see **Turning the Talk Permit Tone On or Off** on page 77), use a trigger word to initiate the call. Wait for the Talk Permit Tone to finish before speaking clearly into the microphone.*

Turning the Public Address System On or Off

You can enable and disable the radio’s internal public address (PA) system.

Procedure:

Press the programmed **PA On/Off** button to toggle the feature on or off.

Turning the External Public Address System On or Off

You can enable or disable the audio routing between the connected public address (PA) loud-speaker amplifier and the radio’s internal public address (PA) system.

Procedure:

Press the programmed **Ext PA On/Off** button to toggle the feature on or off.

Controlling the Display Backlight

You can set the radio's display backlight intensity to either "Low", "Medium", "High", or "Off", to light up the display and the Menu Navigation Buttons backlighting accordingly. The setting also affects the keypad backlighting on a keypad microphone.



Procedure:



Press the programmed **Backlight** button to toggle the backlight intensity. Each press changes the display backlight setting to a new setting.



OR

Follow the procedure below.



- 1  to access the menu.

- 2  or  to "Utilities" and press  to select.

- 3  or  to "Radio Settings" and press  to select.

- 4  or  to "Backlight" and press  to select.

- 5 A "✓" indicates the current setting.

- 6  or  to required setting and press  to select.

- 7 The display lights up accordingly and the screen returns to the previous menu.

*The display backlight, buttons and/or keypad backlighting are automatically turned off if the LED indicator is disabled (see **Turning the LED Indicator On or Off** on page 77).*

Turning Horns/Lights On or Off

Your radio is able to notify you of an incoming call via the horns and lights feature. When activated, an incoming call sounds your vehicle's horn and turns on its lights.

This feature needs to be installed through your radio's rear accessory connector by your dealer.



Procedure:



Press the programmed **Horns/Lights** button to toggle horns and lights feature on or off.



OR



Follow the procedure below.

- 1  to access the menu.

 - 2  or  to "Utilities" and press  to select.

 - 3  or  to "Radio Settings" and press  to select.

 - 4  or  to "Horns/Lights" and press  to select.

 - 5 The display shows "Turn On". Press  to enable the horns and lights feature. The display shows "Horns and Lights On".
- OR
- 5 The display shows "Turn Off". Press  to disable the horns and lights feature. The display shows "Horns and Lights Off".

Turning the Radio Tones/Alerts On or Off

You can enable and disable all radio tones and alerts (except for the incoming Emergency alert tone) if needed.



Procedure:



Press the programmed **All Tones/Alerts** button to toggle all tones on or off.



OR



Follow the procedure below.

- 1  to access the menu.

- 2  or  to “Utilities” and press  to select.

- 3  or  to “Radio Settings” and press  to select.

- 4  or  to “Tones/Alerts” and press  to select.

- 5  or  to “All Tones” and press  to select.

- 6 The display shows “Turn On”. Press  to enable all tones and alerts. The display shows “All Tones On”.

OR

The display shows “Turn Off”. Press  to disable all tones and alerts. The display shows “All Tones Off”.



Setting the Tone Alert Volume Offset Level



You can adjust the Tone Alert Volume Offset level if needed.



This feature adjusts the volume of the tones/alerts, allowing it to be higher or lower than the voice volume.



Procedure:



- 1  to access the menu.



 - 2  or  to “Utilities” and press  to select.

 - 3  or  to “Radio Settings” and press  to select.

 - 4  or  to “Tones/Alerts” and press  to select.

 - 5  or  to “Vol. Offset” and press  to select.

 - 6  or  to the required volume value. The radio sounds a feedback tone with each corresponding volume value.



 - 7 Press  to keep the required displayed volume value. The display shows “Volume Offset Selected”.
- OR
- Repeat Step 6 to select another volume value.
- OR
-  to exit without changing the current volume offset settings.
-



☐ Turning the Talk Permit Tone On or Off



You can enable and disable the Talk Permit Tone if needed.



Procedure:

- 1  to access the menu.

- 2  or  to “Utilities” and press  to select.

- 3  or  to “Radio Settings” and press  to select.

- 4  or  to “Tones/Alerts” and press  to select.

- 5  or  to “Talk Permit” and press  to select.

- 6 The display shows “Turn On”. Press  to enable the Talk Permit Tone. The display shows “Talk Permit Tone On”.

OR



The display shows “Turn Off”. Press  to disable the Talk Permit Tone. The display shows “Talk Permit Tone Off”.



☐ Turning the LED Indicators On or Off



You can enable and disable the LED Indicator if needed.



Procedure:

- 1  to access the menu.

- 2  or  to “Utilities” and press  to select.

- 3  or  to “Radio Settings” and press  to select.

- 4  or  to “LED Indicator” and press  to select.



- 5 Select “Turn On”. Press  to enable the LED Indicators. The display shows “All LEDs On”.
OR
Select “Turn Off”. Press  to disable the LED Indicators. The display shows “All LEDs Off”.



*The display backlight, buttons, and/or keypad backlighting are automatically turned off if the LED indicators are disabled (see **Controlling the Display Backlight** on page 75).*



 **Turning the Introduction Screen On or Off**
 You can enable and disable the Introduction Screen if needed.



Procedure:

- 1  to access the menu.

- 2  or  to “Utilities” and press  to select.



- 3  or  to “Radio Settings” and press  to select.



- 4  or  to “Intro Screen” and press  to select.

- 5 The display shows “Turn On”. Press  to enable the Introduction Screen. The display shows “Intro Screen On”.
 OR
 The display shows “Turn Off”. Press  to disable the Introduction Screen. The display shows “Intro Screen Off”.

 **Accessing General Radio Information**
 Your radio contains information on the following:



- Radio ID 
- Software Version
- Codeplug Version



NOTE: Press  at any time to return to the previous screen or long press  to return to the Home screen.



 **Checking the Radio ID** 
 Displays the ID of your radio.

Procedure:

- 1  to access the menu.

- 2  or  to “Utilities” and press  to select.

- 3  or  to “Radio Info” and press  to select.











- 4  or  to “My Number” and press  to select.

- 5 The display shows the radio ID.

Checking the Firmware Version

Displays the Firmware version on your radio.











Procedure:

- 1  to access the menu.
- 2  or  to “Utilities” and press  to select.
- 3  or  to “Radio Info” and press  to select.
- 4  or  to “Firmware Ver.” and press  to select.
- 5 The display shows the current firmware version.

Checking the Codeplug Version

Displays the codeplug version on your radio.

Procedure:

- 1  to access the menu.
- 2  or  to “Utilities” and press  to select.
- 3  or  to “Radio Info” and press  to select.
- 4  or  to “CP Ver.” and press  to select.
- 5 The display shows the current codeplug version.

Accessories

Your radio is compatible with the accessories listed in this chapter. Contact your dealer for details.

■ Microphone

- Desktop Microphone (MD-12A&J)
- Standard Microphone (MH-67A&J)

■ Cables

- Power Cable to Battery, 10-foot (3-meter) Cable, 15 amp (1 - 25 Watt) (E-DC-27)
- Power Cable to Battery, 20-foot (6-meter) Cable, 20 amp (1 - 45 Watt) (E-DC-28)
- Mobile and Repeater Rear Accessory Connector Universal Cable (CT-149)
- Ignition Sense Cable (CT-148)

■ Desktop Accessories

- Radio Power Cable (E-DC-26)
- Desktop Tray without Speaker (DTT-1)

■ Mounting Kit

- In Dash (DIN) Mounting Kit (MMB-96)
- Low Profile Trunnion Kit (MMB-93)
- High Profile Trunnion Kit (MMB-94)
- Key Lock Trunnion Kit (MMB-95)

■ Programming Cables

- Front Programming Cable for Mobile (CT-154)
- Rear Accessory Connector Programming Cable for Mobile (CT-150)

WARRANTY POLICY

Vertex Standard warrants, to the original purchaser only, its Vertex Standard manufactured communications products against defects in materials and workmanship under normal use and service for a given period of time from the date of purchase.

Limited Warranty Details:

- North America customers (USA and Canada): <http://www.vertexstandard.com/lmr/warranty-terms.aspx>
- Customers outside of North America: contact the authorized dealer in your country.

Part 15.21: Changes or modifications to this device not expressly approved by Vertex Standard could void the user's authorization to operate this device.



Vertex Standard LMR, Inc.

Copyright 2013
Vertex Standard LMR, Inc.
All rights reserved.

No portion of this manual
may be reproduced
without the permission of
Vertex Standard LMR, Inc.