

AR2002

SERVICE MANUAL

downloaded by radioaficion.com

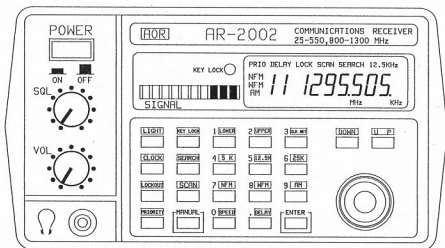

AOR, LTD.

TABLE OF CONTENTS

	PAGE
<u>SPECIFICATIONS</u> -----	(1)
 <u>THEORY OF OPERATION</u>	
GENERAL -----	(2)
SIGNAL PATH CIRCUITS -----	(3)
MAIN UNIT -----	(4)
PLL UNIT -----	(4)
CPU/LCD UNIT -----	(5)
 <u>MAINTENANCE</u>	
TEST EQUIPMENT REQUIRED -----	(6)
ALIGNMENT AND CALIBRATION -----	(6)
TROUBLE SHOOTING -----	(8)
 <u>LIST OF ILLUSTRATIONS</u>	
BLOCK DIAGRAM SERIAL NUMBER UP TO 1500 -----	(9)
" " " " 1500 UP -----	(10)
 <u>PRINTED CIRCUIT BOARDS</u>	
MAIN UNIT COMPONENT LOCATION -----	(11)
COMPONENT SIDE -----	(12)
SOLDER FOIL SIDE -----	(13)
PLL UNIT (UP TO 1500)	
COMPONENT LOCATION -----	(14)
COMPONENT SIDE -----	(15)
SOLDER FOIL SIDE -----	(16)
(1500 UP)	
COMPONENT LOCATION -----	(17)
COMPONENT SIDE -----	(18)
SOLDER FOIL SIDE -----	(19)
CPU/LCD UNIT COMPONENT LOCATION -----	(20)
COMPONENT SIDE -----	(21)
SOLDER FOIL SIDE -----	(22)
SEMI-CONDUCTORS -----	(23)
FIGURES. 1. - 11. -----	(24)
FIGURES.12. - 23. -----	(25)
BIRDIE LIST/PLL BOARD INSTALLATION -----	(26)
 <u>MAIN PARTS LIST</u>	
MAIN UNIT -----	(27)
PLL UNIT -----	(28)
CPU/LCD UNIT -----	(28)
MISCELLANEOUS -----	(29)
CPU/LCD UNIT ASSEMBLY -----	(29)
SCHEMATIC DIAGRAM FOR NEW PLL UNIT -----	(30)
SCHEMATIC DIAGRAM -----	(31)

SPECIFICATIONS

Frequency ranges:	25.000-550.000MHz & 800.000-1300.000MHz												
Modes of operation:	Narrow FM, Wide FM & AM												
Frequency readout:	Complete to .5KHz on LCD screen												
Number of memory channel:	20 channels with mode, step & lockout informations												
Frequency selection:	Keyboard entry & rotary up/down tuning												
Channel steps:	5 KHz, 12.5 KHz & 25 KHz												
Frequency stability:	Within +/-10 PPM at 25°C and +/-50 PPM between -10°C and +60°C												
Sensitivity:	Narrow FM .35 uV for 12dB SINAD Wide FM 1.0 uV for 12dB SINAD AM 1.0 uV for 10dB S/N												
Selectivity:	<table><thead><tr><th><u>MODE</u></th><th><u>@-6dB</u></th><th><u>@-60dB</u></th></tr></thead><tbody><tr><td>NFM</td><td>+/-7.5KHz</td><td>+/-20KHz</td></tr><tr><td>WFM</td><td>+/-50KHz</td><td>+/-250KHz</td></tr><tr><td>AM</td><td>+/- 5KHz</td><td>+/- 10KHz</td></tr></tbody></table>	<u>MODE</u>	<u>@-6dB</u>	<u>@-60dB</u>	NFM	+/-7.5KHz	+/-20KHz	WFM	+/-50KHz	+/-250KHz	AM	+/- 5KHz	+/- 10KHz
<u>MODE</u>	<u>@-6dB</u>	<u>@-60dB</u>											
NFM	+/-7.5KHz	+/-20KHz											
WFM	+/-50KHz	+/-250KHz											
AM	+/- 5KHz	+/- 10KHz											
Intermediate frequencies:	750 MHz for range 25-550 MHz 45.03 MHz .455 KHz for NFM/AM modes 5.5 MHz for WFM												
Scan rate:	5 channel per second												
Search speed:	10 second per megahertz by 25KHz step												
Scan delay:	2.5 seconds												
Audio power output:	1 watt at 10% maximum distortion												
Power requirement:	DC 12 to 16 volts .6 ampere maximum												
Dimensions:	80mm High x 138mm Wide x 200mm Deep												
Weight:	1.1 Kgs. (less rod antenna & AC adaptor)												
Standard accessories:	AC adaptor, DC cable, Rod antenna & Operator's manual												
Optional accessories:	Mobil mounting bracket/model MM-1 Outdoor antenna with 10 meter coaxial cable with connectors/model DA300 Computer interface RS232C with cable/ connectors/model "RC PACK"												

THEORY OF OPERATION

GENERAL:

The AR2002 receiver provides high performance monitor and surveillance reception over a wide frequency range of 25-550MHz and 800-1300MHz.

The wide frequency coverage, combined with reception modes of AM, NFM & WFM, make the AR2002 a versatile unit for a range of applications:

- * General off air monitoring
- * Spot frequency monitoring/measurement
- * Selective multi frequency analysis
- * Spectrum surveillance
- * Detection of unwanted transmission etc.

The two frequency ranges are covered in selectable increments of 5 KHz 12.5 KHz or 25 KHz, and any mode of reception can be used at any frequency or channel spacing.

Typical measured sensitivity(NFM) is better than .3 uV for 12dB SINAD, and the sensitivity is maintained across the tuning range.

Control of the AR2002 is either from a professional keyboard allied to a front panel tuning control which allows conventional rotary up/down tuning or by external control, an interface outlet being provided on the rear panel of the receiver.

Twenty memory channels are provided, with easy keyboard entry and recall. Each memory channel stores frequency and mode information without any restrictions. The memories can be recalled manually, or may be automatically scanned in sequence for unattended monitoring. The complete frequency coverage of the receiver can be scanned in 5, 12.5 or 25KHz steps, and a further facility is the ability to search between two user programmed limits with high to low, or low to high searching.

A comprehensive search facility between two user designated frequencies is included. Two speeds of search are available as is the receiver's ability to scan frequencies from low to high, or high to low. So that nothing is missed a delay function can be switched in to cope with the slight delay pause between transmissions when listening to a two way simplex conversation. Carrying on the receiver's ability to miss nothing memory channel 1 holds the priority frequency which is monitored at 2 second intervals.

Front panel readout of information is by liquid crystal display which shows frequency, mode, memory channel number, frequency increment, delay engaged, channel lockout, etc. A bar type signal strength meter allows comparative measurements to be made, and aids in direction finding applications.

A crystal controlled real time clock is provided in the AR2002, and time readout is also by the liquid crystal front panel display.

Power requirements for the AR2002 are 12 - 14V DC at .3 - .5A, and a suitable mains adaptor is included with the set, as is a power lead to allow operation from a battery or other power source.

The AR2002 consists of a triple conversion super-heterodyne receiver with 750MHz 1st IF for 25 - 550MHz, and double conversion super-heterodyne receiver with 45.03MHz 1st IF (2nd IF for 25 - 550MHz range) for 800 - 1300MHz range.

SIGNAL PATH CIRCUITS:

Refer to the block diagram of the AR2002. All signals from antenna pass through attenuator circuit, then enter to RF amplifier IC-1 through bandpass filter for 25-550MHz range and IC-9 through highpass filter for 800-1300MHz range. Protection for the RF amplifiers provided by a diode at the input of each amplifier stage. Amplified signals from the RF amplifiers are mixed in the first mixer with the 1st local oscillator frequency to produce 750MHz 1st IF for low range(25-550MHz), and 45.03MHz 1st IF for high range(800-1300MHz). In the low range, output signal of 1st mixer passes through a bandpass filter, centered on 750MHz, and is amplified by two stages of IF amplifiers with AGC circuit in AM mode then mixed in the 2nd mixer with 2nd local oscillator frequency of 704.97MHz to produce 45.03MHz 2nd IF frequency. In the case of high range, output signal of 1st mixer switched to bypass the 1st IF amplifier and 2nd mixer to get in the bandpass filter 45.03MHz.

The 2nd IF signal(1st IF for high range) is switched to further IF stages for WFM IF or NFM/AM IF.

In WFM IF, 45.03MHz signal passes through band pass filter and is amplified by two stage IF amplifier and converted to 5.5MHz 3rd IF by 39.53MHz oscillator and amplified/FM detected for further de-emphasis circuit and audio gate.

In NFM/AM IF, 45.03MHz signal passes through a pair of monolithic crystal filters, centered on 45.0275MHz +/-8KHz @3dB bandwidth, and is amplified by two stage IF amplifier and converted to 455KHz 3rd IF by 44.575 or 44.570MHz crystal oscillator according to channel step of 0/12.5KHz or 5KHz. The 455KHz 3rd IF signal passes through ceramic filter, centered on 455KHz, and is switched to further IF amplifiers/detectors for NFM or AM.

The detected signal is gated in audio gate circuit and amplified in audio power amplifier to level of 1 watt.

MAIN UNIT:

Main unit board contains a pair of RF amplifiers, 1st mixer, 2nd mixer, 2nd local oscillator, bandpass filters, WFM IF circuit, NFM/AM IF circuit, audio power amplifier, squelch circuit and power control circuits.

A pair of RF amplifiers amplify all signals from 25 to 550MHz and 800 to 1300MHz with flat response, low noise figure and low intermodulation distortion. The 1st mixer D30 consists of 4 diodes in ring configuration as a passive double balanced mixer which offers high intercept point. The IF amplifier Q31 acts as an impedance matcher and an amplifier. The bandpass filter consists of triple helical resonators for +/-2MHz at 35dB, +/-40MHz at 65dB.

The IF amplifier Q1 is a Ga-As FET high gain amplifier compensating insertion loss of helical resonators and gain automatically controlled along with Q31 by Q2 AGC controller.

The 2nd mixer is an active mixer by Q3 bipolar transistor. 2nd local oscillator frequency of 704.97MHz is made by 46.998MHz quartz crystal oscillator and multiplier stage for 15 (5x3). Q13 is a power amplifier for 704.97MHz and its output passes through double helical resonators. In WFM mode, D2 conducts and signal passes through bandpass filter consists of T-15, 16, 17 then amplified by Q14, 15, and gets into IC-5 MC3357P.

IC-5 converts signal to 5.5MHz 3rd IF with its own 39.53MHz oscillator and amplified and discriminates to audio frequency along with ceramic filter CF3 and discriminator CF4.

In NFM/AM mode, D3 conducts and signal passes through a pair of monolithic crystal filteres then amplified by Q4, 5 with AGC controlled and gets into IC-4 MC3357P. IC-4 converts signal to 455KHz with its own 44.575 or 44.570 MHz crystal oscillator and amplifies/discriminates to audio frequency along with ceramic filter CFI and discriminator CF2. IC-2 is capacitor/resistor network for MC3357P circuit. The squelch circuit works in NFM mode as well as in AM and WFM modes. IC-3 NIS-112 amplifies and detects AM/AGC. Q36 works as a buffer amplifier for AGC and supplies AGC voltage to Q31, 2, 4 and 5. Q6 inhibits 3rd local oscillation when mode is WFM. Q7 switches quartz crystal oscillator for proper frequency by 0/5KHz signal from CPU uPD7503. The mode switch consists of 6 transistors, Q22 through Q27, selects/controls Q18 AM, Q21 NFM and Q20 WFM each preamplifiers. Audio level output of each mode is equalized within +/-6dB tolerance at 1KHz 60% modulation on AM, 1KHz modulation 3.5KHz deviation on NFM and 1KHz modulation 25KHz deviation on WFM.

The audio gate circuit consists of IC-6 TC4066 and Q28, 29 2SC2785. Two transistors control IC-6 by squelch signal from IC-4 or PLL lock signal from PLL unit. The audio power amplifier IC-8 uPD2002 including protection circuit brings enough power output into internal speaker of 8 ohms while specified power output can be obtained with 4 ohm load at external speaker jack.

Power supply circuit has two output voltages for 6 and 10 volts. IC-7 uA78M06 regulates 6 volt output and controls 10 volt regulator consists of 4 transistors Q32 through Q35. These regulators work also as effective ripple and noise filters.

PLL UNIT:

This unit is Phase Lock Loop oscillator controlled by CPU/LCD unit for supplying enough carrier frequency of 754.97 to 1300MHz to 1st mixer. Two kind PLL units exist, one for serial number up to 1500, new one for serial more than 1500.

* For the AR2002 serial number up to 1500

IC-1 NIS-118 oscillates 377.5-490MHz and IC-3 NIS-116 doubles frequency to 755-980MHz, IC-2 NIS-119 oscillates 490-650MHz and IC-5 NIS-117 doubles frequency to 980-1300MHz. IC-1 and IC-2 are voltage controlled oscillators and IC-3 and IC-5 are of band pass filters. Doubled carrier is buffered by Q5 or Q6 then amplified by Q7, 8, power amplifier to the output level of 1 milliwatt. VCO outputs via Q1, 3, are also buffered by Q2, 4 and pass through IC-4 NIS-115 low pass filter. IC-12 uPC1651 wide band amplifier boosts carrier for enough level to drive IC-6 prescaler. IC-6 uPB566 is a dual modulus prescaler and forms pulse swallow counters as combination with PLL IC-7 uPD2833C.

Reference frequency is controlled by quartz crystal oscillator Q9 at 3.200MHz and divided by 128 or 512 in IC-7 internal fixed divider for 25KHz or 6.25KHz accordingly. IC-9 TC5026 divides 25KHz by 5 for 5KHz. IC-8 switches 5KHz or 6.25KHz by 5K/12.5K step signal from CPU.

Output signal from internal tri-state phase detector enters into low pass filter Q13, 14, 15 which produces VCO control voltage VCV in 2-20 volt range. IC-11 TCA-720 is DC DC converter for 30 volts.

Lock detector circuit consists of Q10, 11, 12, 16 transfers PLL lock signal to CPU in order to confirm PLL lock completed in each frequency. Q20 cooperates as compensator when lock is failed at initial state by noise mixing in data. VCO switch circuit consists of three transistors Q17, 18, 19 selects VCO by control signal from CPU(VCO SW).

Back up circuit backs up CPU by IC-10 uA78L62 when DC supply is connected in AR2002. When DC supply is removed, super capacitor C58 1 farad backs up CPU until its voltage drops to 3 volts or approximately one week.

* For the AR2002 serial number more than 1500

IC-1 NIS-130 is voltage controlled oscillator and oscillates directly 754.97-1300MHz frequency carrier. The VCO output carrier passes through Low Pass Filter composed with L1, L2 and C7-11 then it is buffered and amplified by Q1-4 transistors to the output level of 1 milliwatt. The VCO output carrier is also buffered by Q5 transistor and amplified by IC-2 uPC1651G wide band amplifier for enough level to drive IC-3 NIS-131 prescaler which divides carrier to 1/2. Divided carrier 377.485-650MHz is then applied to IC-4 uPB566 dual modulus counter which works as pulse swallow counter combined with PLL IC-5 uPD2833C. Reference frequency is controlled by quartz crystal oscillator Q6 at 6.400MHz and divided by 128 or 1024 in IC-5 internal fixed divider for 50KHz or 6.25KHz accordingly. IC-7 uPD4510BG divides 50KHz by 10 for 5KHz. IC-6 uPD4011BG switches 5KHz or 6.25KHz by 5/12.5KHz step signal from CPU. Output signal from internal tri-state phase detector enters into Low Pass Filter composed of Q7-9 which produces VCO control voltage and D1 diode rectifies it to get DC 30 volts supply source for VCV voltage. Lock detector circuit consists of Q10-13 transfers PLL lock signal to CPU in order to confirm PLL lock completed with each frequency. Back up circuit backs up CPU by IC-8 uA78L05 when DC supply is connected in AR2002. When DC supply is removed, super capacitor C62 0.47 Farad backs up CPU until its voltage drops to 3 volts or approximately one week.

CPU/LCD UNIT:

This unit consists of CPU, keyboard, LCD display and S meter circuit. The CPU uPD7503G is one chip 4 bit microprocessor including 4 bit parallel process ALU, ROM, RAM, I/O port, 8 bit serial interface, 8 bit programmable counter and LCD controller/driver. The CPU uPD7503G has many features of ROM capacity of 4096 x 8 bit, RAM capacity of 224 x 4 bit, direct drive LCD, low voltage data maintain, RC oscillator for system clock, crystal oscillator, single power supply, low current drain, etc. The CPU accepts 4 signals and outputs 6 signals and drives LCD screen.

Control signal input to CPU.

1. Squelch signal from IC-4 MC3357P pin 14 in the main unit.
2. PLL lock signal from the PLL unit,
3. 6 volt signal from IC-7 uA7806 in the main unit.
4. Key lock signal from CPU/LCD unit.

Control signal output from CPU.

1. Mode switching signal of AM, NFM, WFM to the main unit.
2. VCO switching signal of high/low to the PLL unit (for serial less than 1500).
3. Alarm signal for beep tone to audio amplifier in the main unit.
4. 5KHz switching signal 0/5KHz in NFM/AM mode to 3rd oscillator in the main unit.
5. Step switching signal 5/12.5KHz to IC-6 TC4011 in the PLL unit.
6. PLL data signals of clock(CK), data(DATA) and strobe(STB) to IC-7 uPD2833C in 17 bit binary serial input.

LCD screen displays frequency, channel number, mode, priority, delay, scan, lock out, search, steps and real time.

Bar type 'S' meter consists of LED's Green/Red and IC-2 TA7612AP S-meter driver along with Q8 transistor as AGC inverter.

Rotary shaft encoder is provided for manual control up/down.

MAINTENANCE:

Cover removal

Remove the two screws close to rubber foot on the bottom of the AR2002 and the two screws on the back of the lower cabinet.

Remove lower cabinet then remove the two screws on the back of the upper cabinet and lift upward the back wall of the upper cabinet then pull backward to remove.

TEST EQUIPMENT REQUIRED

Following is a list of test equipment recommended for maintenance of this receiver.

1. DC volt meter.
2. AC volt meter.
3. Oscilloscope with 10 MHz response.
4. Frequency counter with 1350 MHz response.
5. Signal generator with range of 455 KHz to 1300 MHz.
6. Spectrum analyzer with 1350 MHz response.
7. Tracking generator or sweep generator with 50 MHz response.
8. DC power supply with 12 V 500 mA capacity.
9. Special RF probe for use with spectrum analyzer and frequency counter. recommended probe by adding two short pins soldered on the BNC female connector illustrated below.



ALIGNMENT AND CALIBRATION:

It is not necessary to align a new receiver. Each receiver is carefully aligned and checked by the manufacturer's staff of expert technicians before it is shipped from the factory. If it becomes necessary to align any of the units in the AR2002 receiver, proceed as follows.

1. Clock time base oscillator:
On the CPU, LCD unit board, find test point TP-1 and trimmer capacitor TC-1. Set the receiver at 100.000 MHz in any mode but flashing CH condition. Connect a frequency counter to TP-1 and adjust carefully TC-1 to get exact 512.000 HZ on the counter. Clock accuracy depends on this alignment. Approx. 20 seconds tolerance/month can be obtained.
2. DC 10 V alignment:
On the main unit board, measure DC voltage at pin 5 of IC-8 uPC2002 and adjust variable resistor VR3 near RF input connector to get 10V on the DC voltmeter.
3. Reference oscillator alignment:
On the PLL unit board, find RF output connector RCA type and trimmer capacitor TC-1 in the center part of the board. Set receiver at 550.000MHz in any mode, touch frequency counter probe to the back terminal of RCA type RF output connector, then adjust TC-1 to get exact 1300.000MHz on the frequency counter. +/-500 Hz can be allowed at ambient temperature.

4. 2nd IF alignment:

Find R15 220 K ohm at the corner of T8 and R32 2.2 K ohm at pin 3 of IC-4 MC3357P. Prepare a short jumper wire with alligator clips on both ends and jumper R15 top and R32 top. This wire jumps Q36 emitter to +6 V line for disabling AGC on Q36. Connect output of tracking generator or sweep generator to base of Q3 2SC3355 2nd mixer and connect spectrum analyzer input cable to pin 16 of IC-4 MC3357P. Set the receiver in AM or NFM mode at any frequency. Output level of -40dBm from tracking/sweep generator and input range of 0dBm, 10KHz/division for spectrum analyzer. Adjust T4 and T8 so as to get illustrated curve as high as possible for height and as flat as possible for horizontal line.

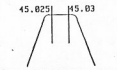

Remove spectrum analyzer connection from pin 16 of IC-4 and connect it to pin 16 of IC-5 MC3357P. Set the receiver in WFM mode with any frequency and change spectrum analyzer dispersion to 50 KHz/division. Adjust T15, T16, T17 and T18 so as to get a curve as high as possible.

5. 2nd oscillator alignment:

Connect spectrum analyzer probe at Q12 2SC3355 base and adjust T10, T11 and T12 for peak on 234.99 MHz. Change probe connection to Q3 2SC3355 base and adjust T12 again, T13 and T14 for peak on 704.97 MHz. Connect frequency counter probe to Q3 2SC3355 base and adjust T3 so as to get exact 704.970 MHz.

6. 1st IF alignment:

Connect signal generator output at 225.105 MHz with 1 KHz 60% AM -80dBm to input the receiver. Connect DC voltmeter at top of R15 220 K ohm at T8 corner and ground. Connect AC voltmeter and oscilloscope in parallel at speaker terminal. Set the receiver at 225.105 MHz in AM mode and adjust volume control for proper distortion free indication on the oscilloscope. Adjust T2 and T3 for minimum indication on DC voltmeter. If AGC voltage becomes less than 3 volts, decrease the output of signal generator and re-adjust T2 and T3 until no improvement occurs.

7. RF amplifier alignment:

Same setting with above 1st IF alignment procedure except frequency. Set signal generator and receiver at 25.105 MHz. Adjust T1 for minimum indication on DC voltmeter. Check the sensitivity within +/-2 dB at any frequency for both frequency ranges of 25 - 550MHz and 800 - 1300MHz.

TROUBLE SHOOTING

1. Defective on one of three receiving modes.
 - * Check the voltage at pin 3 and 4 of J-4 connector on the MAIN UNIT board (next to IC-7 uA7806 regulator) for proper voltage on selected mode.
 - * Check the voltage at W3 marked jumper wire (orange) on AM, W4 marked jumper wire (grey) on NFM, pin 4 of IC-5 MC3357P on WFM.
 - * Check the detected output from each detector by connecting oscilloscope.
2. No sound except beep tone when keying in any mode.
 - * Check the voltage at D10 and D11 for Q28 2SC2785 conducting.
 - * Check the wiring for volume control.
 - * Check the leakage of C9 .1uF on the CPU,LCD unit for muting IC-8 uPC2002 in the main unit.
3. Low sensitivity.
 - * Check defective IC-1 MC5800 or IC-9 MC5805 according to frequency in low sensitivity.
 - * Check the frequency and output level of the 1st oscillator (PLL UNIT)
 - * Check the frequency and output level of the 2nd oscillator (704.97MHz)
4. No sound, fixed display or only channel number display without frequency.
 - * This is caused by PLL unlock. Try to ground PLL UNLOCK line and check if display moves then set receiver in scan mode and check data from CPU appear on pin 1(STB), pin 6 (DATA), pin 7 (CK) of IC-5 uPD2833C on PLL board.
 - * Check voltages of 30 V line and VCV line at certain frequencies listed as follow:

<u>Freq.</u>	<u>30 V line</u>	<u>VCV line</u>
25.03MHz	29 V	3.2 V
273.70	34	10.9
550.00	41	23.4

In case of very low voltage on VCV line, check whether 5KHz or 6.25KHz appears on pin 2 of IC-5 uPD2833C.

In case of high enough voltage on VCV line, check RF signal on pin 2 of IC-4 uPB566 by connecting spectrum analyzer or RF volt meter.

- * Check the defective VCO IC-1 by connecting spectrum analyzer if it oscillates at random or parastically.
5. Unlock on special frequencies or random frequencies.
 - * Check 5KHz or 6.25KHz on pin 2 of IC-5 uPD2833C.
 - * Check wave form on pin 5 of IC-5 uPD2833C according to the frequencies.
 - * Check defective IC-5 uPD2833C.
 6. No receive on 5KHz up or down.
 - * Check the 3rd oscillator on the main unit whether quartz crystal unit is properly switched or not.
 - * Check the defective quartz crystal unit 44.570 MHz for 5KHz
 7. Acoustic coupling.
 - * In NFM mode:
 - °Check the VCO IC-1 in the shield case if adhesive tape is not enough to secure to wall.
 - °Check the crystal X-1 46.998 MHz in the 2nd oscillator.
 - °Check the screws for every printed circuit board mountings.
 - °Check the solder joints at 4 corners of separating shield plate between the main and PLL units.
 - * In AM mode:
 - °Check the vibrating helical resonators.
 - °Check the connections of RF coaxial cables.

AR2002
MAIN UNIT COMPONENT LOCATION

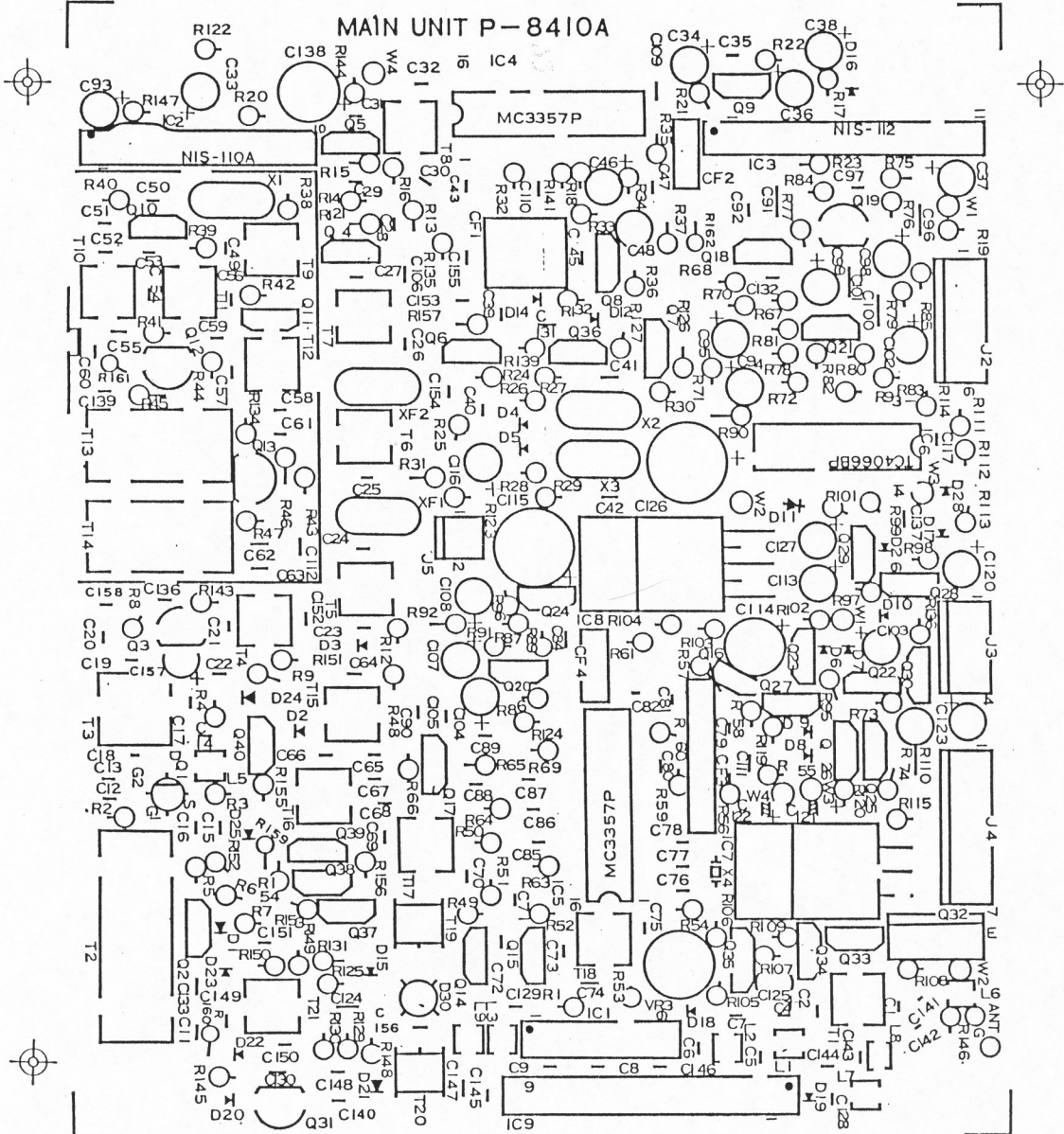

AR2002

MAIN UNIT COMPONENT SIDE

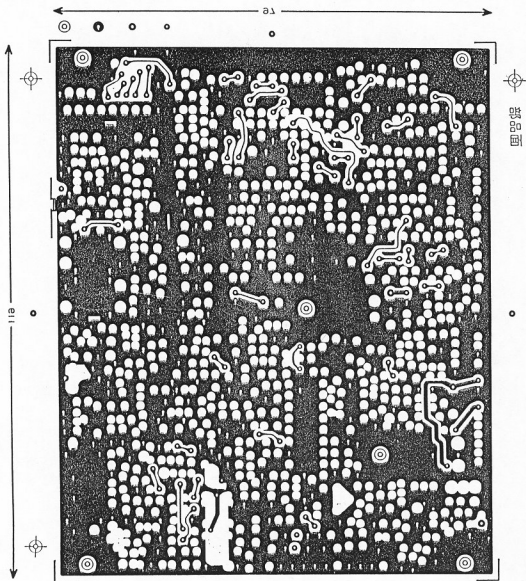

AR2002

MAIN UNIT SOLDER FOIL SIDE

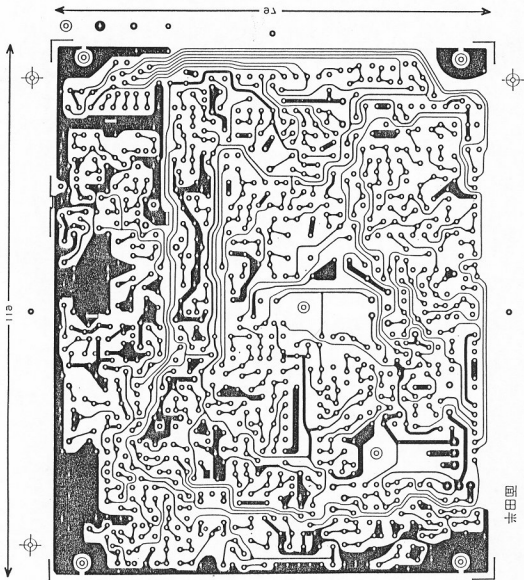

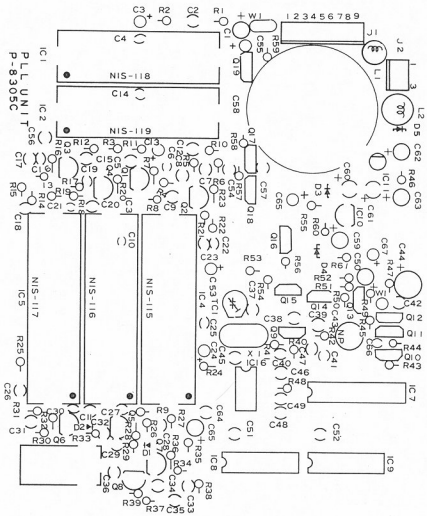

PLL UNIT COMPONENT LOCATION
 FOR THE AR2002 SERIAL NUMBERS UP TO 1500.

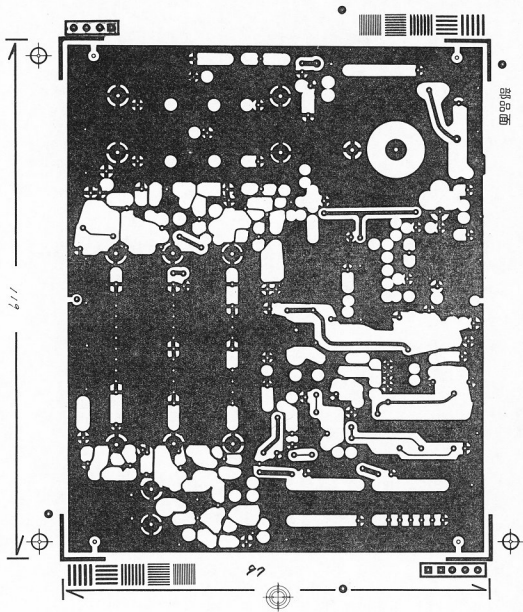

PLL UNIT COMPONENT SIDE
 FOR THE AR2002 SERIAL NUMBERS UP TO 1500

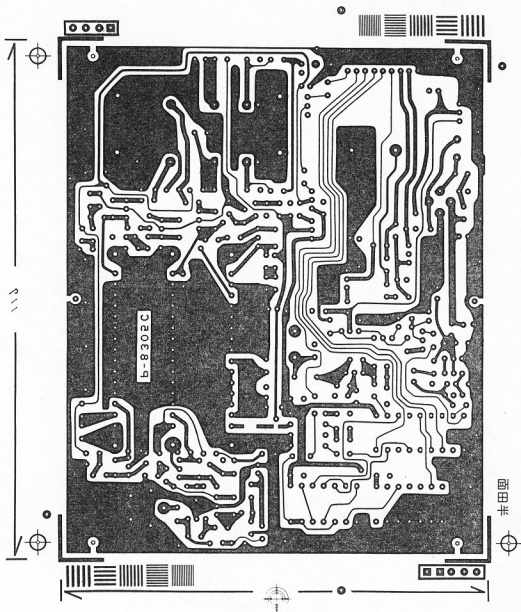

井田

PLL UNIT SOLDER FOIL SIDE

FOR THE AR2002 SERIAL NUMBERS UP TO 1500

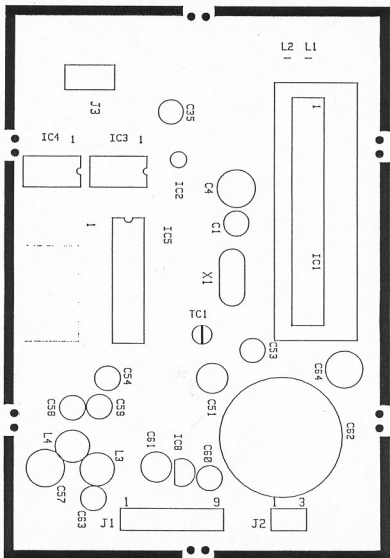

PLL UNIT COMPONENT LOCATION
 FOR THE AR2002 SERIAL NUMBERS 1500 UP

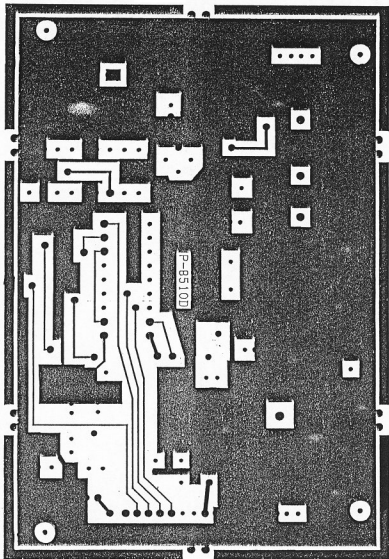

PLL UNIT COMPONENT SIDE

FOR THE AR2002 SERIAL NUMBERS 1500 UP

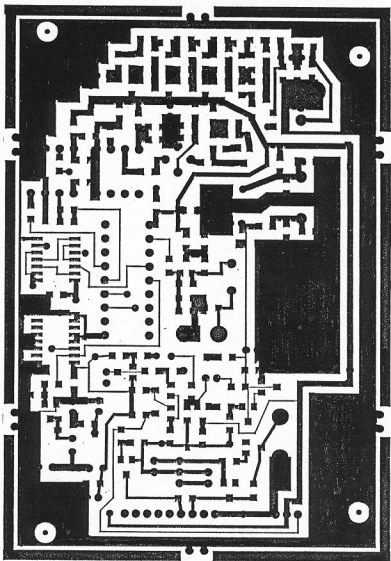

PLL UNIT SOLDER FOIL SIDE
FOR THE AR2002 SERIAL NUMBERS 1500 UP

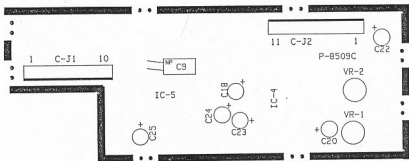
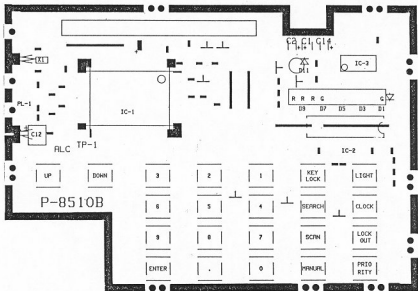

AR2002
 CPU/LCD UNIT COMPONENT LOCATION

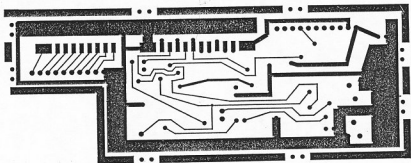
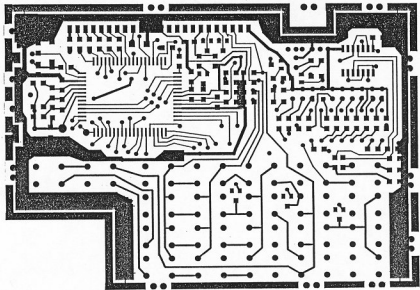

AR2002
CPU/LCD UNIT COMPONENT SIDE

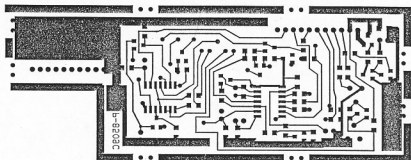
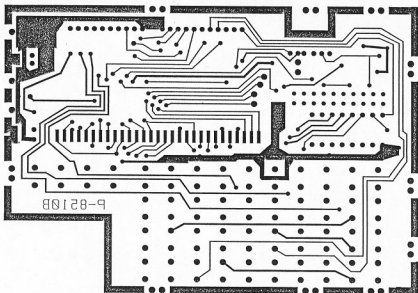

AR2002
CPU/LCD UNIT SOLDER FOIL SIDE

SEMI-CONDUCTORS

<u>MAIN UNIT</u>	<u>PART NO.</u>	<u>DESCRIPTION</u>	<u>FIGURE #</u>
	MC5800	Wideband RF amplifier 10dB gain, 3dB NF	1-A.
	MC5805	" " 17dB gain, 4dB NF	1-B.
	MC3357P	Low power consumption NFM IF amplifier with squelch circuit	2.
	NIS-110A	Noise detector network for MC3357P	3.
	NIS-112	AM detector and AGC amplifier	4.
	TC4066	C ² -MOS quad bilateral switch	5.
	uA78M06	3 terminal positive voltage regulator 6.0 V .5 A output	6.
	uPC2002	Audio power amplifier Po:5.4 W	7.
	3SK121	GaAs FET 1.5dB NF 20dB GP	8.
	2SC3355	NPN transistor 1.1dB NF fT6.5GHz	9.
	2SA1175	PNP transistor Ic=-100mA fT150MHz	10.
	2SC2785	NPN transistor Ic=100mA fT250MHz	10.
	2SC2786	NPN transistor fT600MHz	10.
	2SC2787	NPN transistor fT250MHz	10.
	2SD288	NPN transistor Ic=3A max.	11.
	2SK68	N channel silicon junction FET	12.
	487C1-3R	Quad diode silicon epitaxial schottky	13.
	BA282	Switching diode max. resistance .7 ohm @3mA (f=50-1000MHz) 2.5nH 1.25pF	14.
	1S2588	Switching diode max. resistance .6 ohm @10mA (100MHz) 2pF	14.
<u>PLL UNIT</u>	NIS-130	Voltage controlled oscillator 775-1300MHz	15.
	NIS-131	1/2 prescaler 2.2 GHz	16.
	uPC1651G	Wideband amplifier 19dB gain	17.
	uPB566C	Dual modulus prescaler 900MHz 400mV	18.
	uPD2833C	CMOS pulse swallow counter PLL	19.
	TC4011	C ² MOS quad 2 input positive NAND gate	20.
	uPD4510BG	4 bit up/down decade counter	21.
	uA78L05	3 terminal positive voltage regulator 5.0 V .1 A output	22.
<u>CPU/LCD UNIT</u>	uPD7503	Micro processor control	23.

TC4066

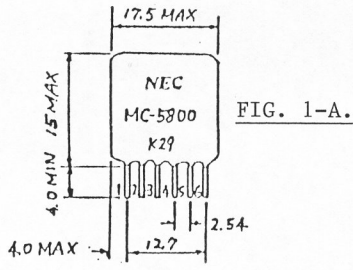

FIG. 1-A.

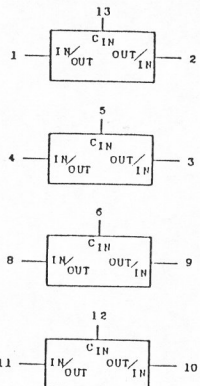
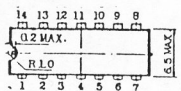
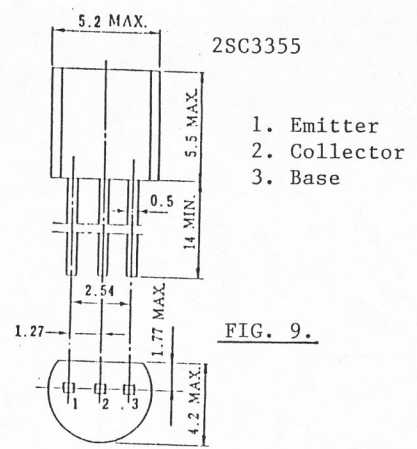

FIG. 5.

V_{DD}: 14, V_{SS}: 7



2SC3355

1. Emitter
2. Collector
3. Base

FIG. 9.

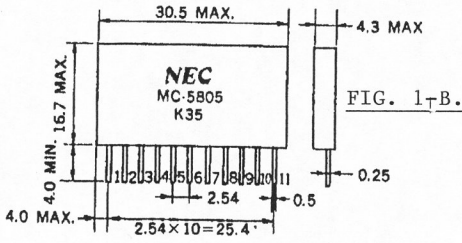

FIG. 1-B.

PIN CONNECTIONS

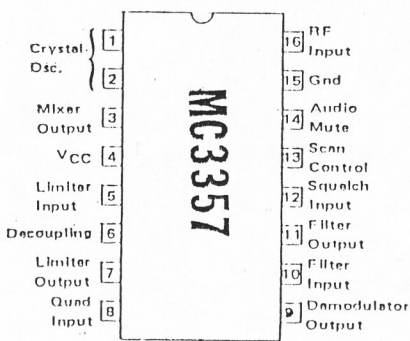

FIG. 2.

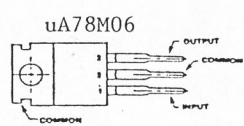

FIG. 6.

μPC2002H

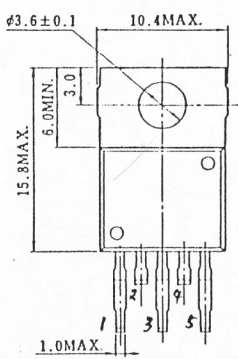
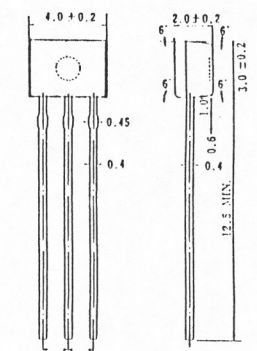

FIG. 7.

2SA1175
2SC2785
2SC2786
2SC2787



- 電極接続
1. Emitter
 2. Collector
 3. Base

FIG. 10.

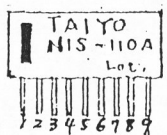
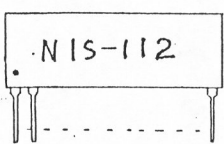

FIG. 3.



- PIN CONNECTIONS
1. INPUT, 2,3. GND,
 4. AF OUT, 5,6,7. NC
 8. GND, 9. NC, 10. Vcc
 11. AGC OUT

FIG. 4.

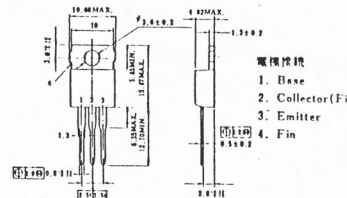

FIG. 11.

1. GATE 1
2. SOURCE
3. DRAIN
4. GATE 2

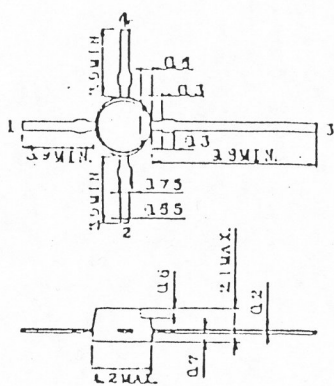

FIG. 8.

3SK121

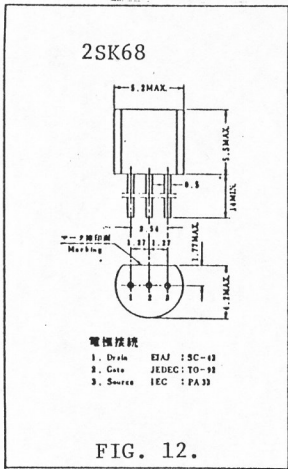

FIG. 12.

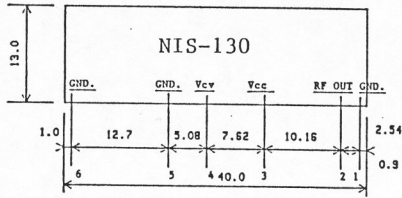

FIG. 15.

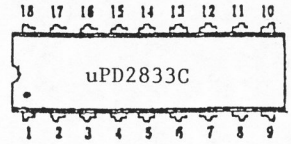
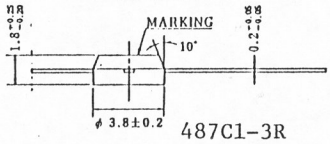
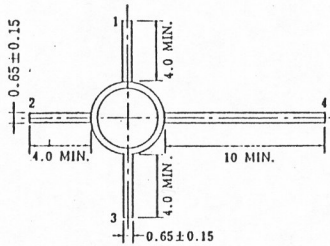

FIG. 19.



端子接続

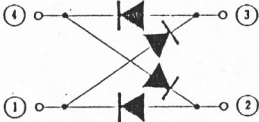
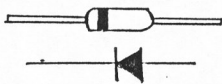

FIG. 13.



BA282
1S2588

FIG. 14.



- | | |
|-----------|-----------|
| 1. Vcc | 5. Ground |
| 2. IN | 6. Out 1 |
| 3. Bypass | 7. Out 2 |
| 4. Ground | 8. NC |

FIG. 16.

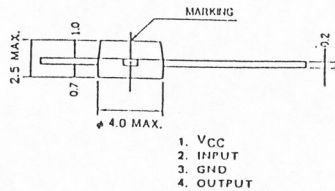
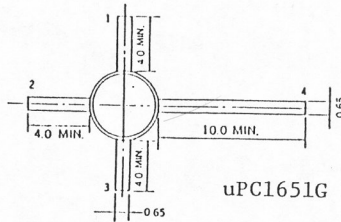
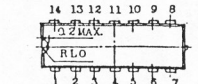

FIG. 17.



TC4011

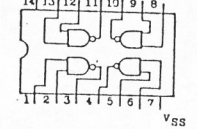

FIG. 20.

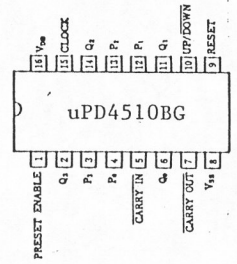
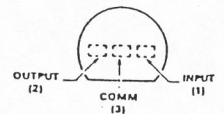

FIG. 21.

uA78L05



TOP VIEW

FIG. 22.

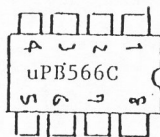

FIG. 18.

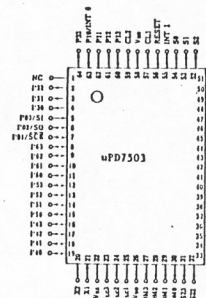

FIG. 23.

BIRDIE LIST

Every complex receiver has frequencies that are difficult or impossible to receive because of internally generated signals.

These frequencies are called "BIRDIES". The following is a partial list of such frequencies that may occur in the AR2002.

(Noted at squelch threshold on NFM mode in 5KHz steps.)

46.995 47.000 48.310 48.315 81.170 81.175 88.425 88.430 88.435 93.990
93.995 94.000 94.980 94.985 99.980 99.990 99.905 99.910 99.915 99.925

104.970 126.640 126.645 140.990 140.995 141.000 144.920 144.930 144.935
144.945 159.940 159.945 174.950 174.955 187.985 187.990 187.995 204.970
204.975 212.470 212.475 219.980 219.985 234.985 234.990 234.995 281.985
281.990 283.300 284.940 284.945 299.180 299.185 305.905 318.710 318.715
329.970 329.975 376.640 379.920 379.925 379.935 409.945 426.925 439.960
447.460 447.465 449.990 449.995 450.000 450.005 450.010 469.970 469.975
469.980 469.985 470.965 473.910 516.975 516.980 533.300 533.305

In addition, there are other frequencies that are difficult to receive because of interference from externally generated signals, such as T.V. stations, other receivers nearby and various other sources of man-made noise.

These frequencies vary from location to location and are therefore impossible to list. When this type of interference is encountered, it can sometimes be eliminated by moving the squelch control knob counter-clockwise (increase squelch action).

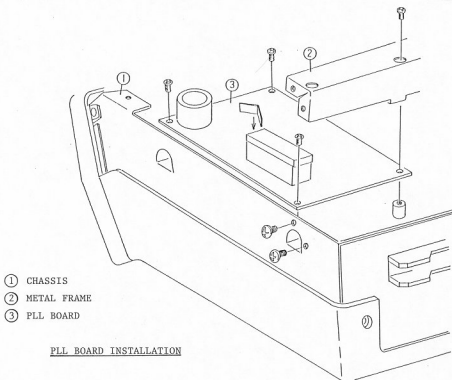

MAIN PARTS LIST (MAIN UNIT)

<u>ITEM</u>	<u>SPECIFICATION</u>	<u>QUANTITY</u>	<u>PART NO.</u>	
TRANSISTOR	3SK124	1	Q1	
	2SC3355	5	Q3, 12, 13, 31, 4,	
	2SA1175	9	Q7, 22, 23, 24, 27, 33, 37, 38, 40	
	2SK68	1	Q19	
	2SD288	1	Q32	
	2SC2785	15	Q2, 9, 17, 18, 20, 21, 25, 26, 28, 29, 30, 34, 35, 36, 39	
	2SC2786	2	Q10, 11	
	2SC2787	6	Q5, 6, 8, 14, 15, 16	
IC	MC5800	1	IC1	
	MC5805	1	IC9	
	NIS110A	1	IC2	
	NIS112A	1	IC3	
	MC3357P	2	IC4, 5	
	TC4066BP	1	IC6	
	uA78M06	1	IC7	
	uPC2002	1	IC8	
DIODE	1S1588	12	D6, 7, 8, 9, 10, 11, 12, 16, 17, 25, 26, 28	
	BA282	9	D2, 3, 4, 5, 20, 21, 22, 23, 24	
	487C1-3R	1	D30	
	1SS97	2	D18, 19	
CRYSTAL	46.998MHz	1	X1	
	44.575	1	X2	
	44.570	1	X3	
	39.530	1	X4	
VARIABLE RESISTOR	10 K ohm	1	VR3	
	4.7K ohm	1	TWO TERMINAL	
PC BOARD	8410A	1		
FILTER	MCF	1 pair	45M16B	
	5.5MHz	1	SFT5.5MA	
	455KHz	1	CFU455F	
DISCRIMINATOR	5.5MHz	1	CDA5.5MDZ	
	455KHz	1	CDB455C7	
DBM		2	T19, 20	
RF TRANS	01436	7	T1, 4, 8, 15, 16, 17, 18	
	03748	1	T3	
	03875	1	T9	
	02670	3	T10, 11, 12	
	03747	2	T13, 14	
	03988	1	T2	
	04309	1	T21	
RF COIL	03876	2	L1, 2, (2t)	
	04266	2	L7, 8, (1t)	
	03307	2	L6, 3, (4t)	
	03877	1	L5 (9t)	
	03291	1	L9 (3t)	

MAIN PARTS LIST(PLL UNIT)

<u>ITEM</u>	<u>SPECIFICATION</u>	<u>QUANTITY</u>	<u>PART NO.</u>
TRANSISTOR	2SC3356	5	Q1,2,3,4,5
	2SC1009	1	Q6
	2SC1623	7	Q7,8,9,11,12,13,14
	2SA812	1	Q10
IC	NIS130	1	IC1
	uPC1651G	1	IC2
	NIS131	1	IC3
	uPB566C	1	IC4
	uPD2833C	1	IC5
	uA78L05	1	IC8
	uPD4011	1	IC6
	uPD4510	1	IC7
DIODE	1S2837	3	D1, 2, 3
CRYSTAL	6.400MHz	1	X1
PC BOARD	8510D	1	
TRIMMER	20 PF	1	TC1
RF COIL	04266	2	L1, 2
INDUCTOR	220uH	1	L3
	1 MH	1	L4
SUPER CAP.	0.47F	1	C62
<u>(CPU/LCD UNIT)</u>			
TRANSISTOR	2SA812	1	Q1
	2SB624	2	Q2, 5
	2SC1623	7	Q4,6,7,8,9,10,11
IC	uPD7503	1	IC1
	uPD4013	1	IC3
	uPD4030	1	IC4
	uPD4066	1	IC5
	TA7612AP	1	IC2
DIODE	1S2837	10	D12,13,14,15,16,17,18,19,20,21
CRYSTAL	32.768KHz	1	X1
VARIABLE RESISTOR	1K ohm	1	VR1
	47K ohm	1	VR2
PC BOARD	8510B	1	
	8509C	1	
LED	TLG211	7	D1,2,3,4,5,6,7
	TLR211	3	D8,9,10
LAMP		1	
TACT SWITCH		22	S1,2,3,4,5,6,7,8,9,10,11,12,13,14, 15,16,17,18,19,20,21,22

MAIN PARTS LIST(MISCELLANEOUS)

<u>ITEM</u>	<u>SPECIFICATION</u>	<u>QUANTITY</u>	<u>PARTS NO.</u>
LCD	LIQUID CRYSTAL	1	
ROTARY SW	MAIN DIAL	1	SRBMIL ALPS
VARIABLE RESISTOR	50K ohm	1	VOL
	10K ohm	1	SQL
PUSH SW	SPJ	1	ON-OFF
SLIDE SW	SSF	1	
SPEAKER	SM-66NR	1	
PC BOARD	8505B	1	EAR
	8507A	1	REMOTE
	8305F	1	EXT. SP.
	8305G	1	ANT.
CHASSIS	FRONT	1	
	MAIN	1	
LCD WINDOW		1	
KNOB	DIAL	1	
	CONTROL	2	
	POWER	1	
	KEY TOP	22	
CASE	FRONT	1	
	UPPER	1	
	LOWER	1	

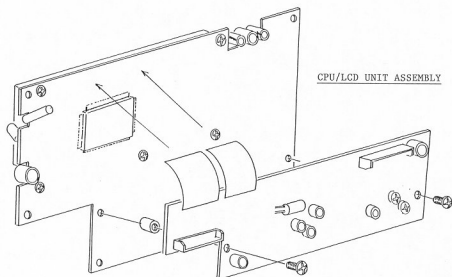

PLL UNIT

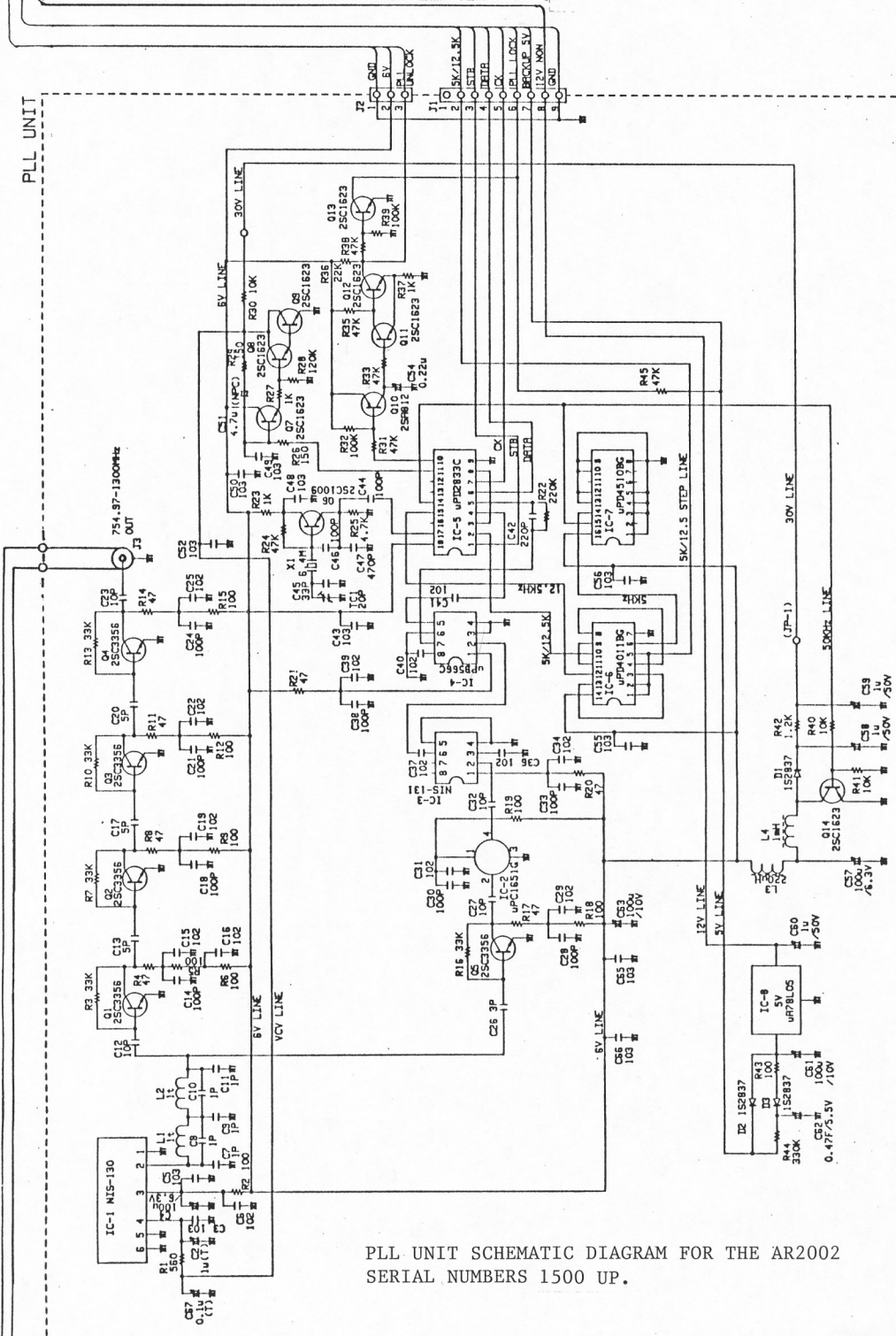

PLL UNIT SCHEMATIC DIAGRAM FOR THE AR2002 SERIAL NUMBERS 1500 UP.

AR2002 SCHEMATIC DIAGRAM



NO.	DATE	BY	REVISION
1	11. SEPT. 1985	F. HAYASHI	1
2			2
3			3
4			4