

## Contents

<b>(1) Table of contents</b> .....	<b>1</b>	6-18 CONFIG - EXTERNAL I.F. output (SDU5000) .....	29
<b>(2) Introduction</b> .....	<b>2</b>	6-19 CONFIG - Computer control BPS .....	29
2-1 Key information and common menus .....	3	6-20 CONFIG - Advanced aerial switching .....	30
2-2 Accessories supplied .....	4	6-21 CONFIG - Frequency standard .....	32
<b>(3) Major Features</b> .....	<b>4</b>	<b>(7) Memory banks &amp; channels</b> .....	<b>33</b>
<b>(4) Precautions</b> .....	<b>4</b>	7-1 Storing receive data into memory - VFO mode .....	33
4-1 Location .....	4	7-2 Memory recall - Recalling receive data from memory .....	34
4-2 Looking after your receiver .....	5	7-3 Transfer of memory channel to VFO .....	35
4-3 Power requirements .....	5	7-4 Changing and deleting memory data .....	35
4-4 Aerial (antenna) connection .....	5	7-5 Deleting memory channels and banks .....	36
<b>(5) Controls and functions</b> .....	<b>6</b>	<b>(8) SCAN - scanning memory channels &amp; banks</b> .....	<b>37</b>
<b>Front panel</b>		8-1 SCAN - outline introduction to facilities available .....	37
5-1 On/Off power switch .....	6	8-2 Starting to SCAN, considerations .....	37
5-2 S-meter (signal strength meter) .....	6	8-3 SCANNING a memory bank .....	38
5-3 Liquid Crystal Display (LCD) .....	6	8-4 Selecting a single memory bank to scan .....	38
5-4 Main (large) rotary tuning control - <i>MAIN DIAL</i> .....	8	8-5 Memory bank linking to scan ALL memory banks .....	39
5-5 Sub (small) rotary tuning control - <i>SUB DIAL</i> .....	8	8-6 Specifying memory bank linking .....	39
5-6 Torque adjustment ( <i>MAIN DIAL</i> brake) .....	8	8-7 Scanning a memory bank which is not linked .....	39
5-7 Removable feet .....	9	8-8 SCAN channel PASS (lockout) .....	40
5-8 Internal speaker .....	9	8-9 <i>Cyber Scan</i> in SCAN mode .....	41
5-9 SQ - squelch control (plus RF control) .....	9	<b>(9) Additional SCAN facilities</b> .....	<b>41</b>
5-10 Volume control (AF GAIN) .....	10	9-1 SCAN - PAUSE .....	41
5-11 ACC 1 accessory number one socket .....	10	9-2 SCAN - DELAY .....	42
5-12 Headphone socket .....	10	9-3 SCAN - LEVEL SQUELCH .....	42
5-13 Front panel keys .....	10	9-4 SCAN - VOICE .....	42
<b>Rear panel</b>		9-5 SCAN - MODE (receive mode AM, FM etc) .....	43
5-14 DC 12V - external power connection .....	15	<b>(10) SELECT SCAN - special <i>select scan list</i> overview</b> .....	<b>43</b>
5-15 ACC 2 (accessory 2 socket) .....	15	10-1 Tagging scan select channels .....	43
5-16 EXT SP - external speaker output socket .....	16	10-2 SELECT SCAN - while in SCAN MODE .....	44
5-17 REMOTE - RS232C computer control port .....	16	10-3 SELECT SCAN while in MEMORY RECALL mode .....	44
5-18 I.F. OUTPUT (10.7 MHz) .....	16	10-4 Starting SELECT SCAN .....	44
5-19 STD IN (10 MHz) .....	16	10-5 Deleting all SELECT SCAN channels in one go .....	44
5-20 MUTE .....	16	<b>(11) Priority operation</b> .....	<b>45</b>
5-21 ANT 2 .....	17	11-1 Engaging PRIORITY channel .....	45
5-22 ANT 1 .....	17	11-2 Changing PRIORITY channel parameters .....	45
<b>(6) Basic manual operation of the receiver</b> .....	<b>17</b>	<b>(12) SEARCH</b> .....	<b>46</b>
6-1 Switching on for the first time .....	17	12-1 Manual SEARCH between two VFO frequencies (VA, VB) ...	46
6-2 Changing VFO .....	17	12-2 Simple search (VC, VD, VE) .....	47
6-3 Tuning the receiver using the rotary controls .....	18	12-3 Optimising VFO search parameters .....	48
6-4 Entering a frequency via the numeric keypad .....	18	12-4 Program search banks .....	49
6-5 Correction of frequency input via the numeric keypad .....	19	12-5 Starting program search .....	50
6-6 Selecting tuning step (increment) .....	19	12-6 Cancelling, restarting program search .....	50
6-7 Step-adjust .....	20	12-7 Programming and reprogramming SEARCH BANKS .....	51
6-8 FREQUENCY OFFSET .....	22	12-8 Deleting PROGRAM SEARCH BANKS .....	53
6-9 Changing receive mode (AUTOMODE) .....	22	12-9 SEARCH - outline introduction to additional facilities .....	53
6-10 IF BANDWIDTH .....	24	12-10 Linking program search banks .....	54
6-11 AF SET - (Audio characteristics) .....	25	12-11 Linking only a few search banks .....	55
6-12 Audio tone eliminator (T-ELMT) .....	27	12-12 Searching a bank which is not selected in BANK LINK .....	55
6-13 DTMF decoder .....	28	12-13 Additional PROGRAM SEARCH facilities (introduction) .....	55
6-14 RF Attenuator & preamplifier .....	28	12-14 PROGRAM SEARCH - PAUSE .....	55
6-15 CONFIG menu outline of facilities .....	28	12-15 PROGRAM SEARCH - DELAY .....	56
6-16 CONFIG - LAMP .....	29	12-16 PROGRAM SEARCH - LEVEL SQUELCH .....	56
6-17 CONFIG menu - BEEP .....	29	12-17 PROGRAM SEARCH - VOICE .....	57
		12-18 <i>Cyber Search</i> .....	57
		12-19 AUTO-STORE .....	58

<b>(13) Frequency Pass .....</b>	<b>58</b>
13-1 Register PASS Frequency .....	59
13-2 Manually adding a PASS frequency .....	59
13-3 Editing pass frequencies .....	60
13-4 Deleting individual pass frequencies .....	60
13-5 Deleting complete banks of pass frequencies .....	61
<b>(14) Real time clock .....</b>	<b>61</b>
14-1 Displaying the clock .....	61
14-2 Setting time .....	62
14-3 Alarm clock .....	63
14-4 ALARM programming .....	63
14-5 ALARM activation .....	64
14-6 SLEEP timer .....	64
<b>(15) Option - Descrambler (voice inverter) - DS8000 .....</b>	<b>65</b>
15-1 Descrambler installation .....	65
15-2 Descrambler operation .....	66
<b>(16) Option - CTCSS tone squelch - CT5000 .....</b>	<b>66</b>
16-1 Installation of the CT5000 .....	67
16-2 Operation of the CT5000 - overview .....	67
16-3 CTCSS SEARCH .....	67
16-4 CTCSS SQUELCH .....	68
<b>(17) Optional I.F. filters (500 Hz, 2.5 kHz &amp; 5.5 kHz) .....</b>	<b>68</b>
17-1 Fitting the optional 500 Hz filter .....	68
17-2 Installation of other filters .....	69
<b>(18) Trouble shooting - microprocessor reset .....</b>	<b>70</b>
18-1 Power Off / On .....	70
18-2 CPU reset switch .....	70
18-3 CPU soft reset .....	70
18-4 AF.SET INT/EXT .....	71
18-5 What next - dealer support .....	71
18-6 Power-up special key sequences .....	71
<b>(19) Optional accessories .....</b>	<b>72</b>
<b>(20) Aerials (Antennas) and earth systems .....</b>	<b>72</b>
<b>(21) Propagation - short wave bands .....</b>	<b>75</b>
<b>(22) Specification .....</b>	<b>76</b>

## (2) Introduction

Thank you for purchasing the AOR AR5000 wide band all mode receiver. The AR5000 uses the very latest NCO (**N**umerically **C**ontrolled **O**scillator) technology to ensure the highest levels of design, performance and reliability.

It is recommended that you carefully read this handbook and familiarise yourself with the receiver before placing it into operation. Every effort has been made to make this manual correct and up to date. Due to continuous development of the receiver and by error or omissions anomalies may be found and this is acknowledged. Most apparent faults are usually due to accidental misoperation of the receiver, carefully read all of the manual before deciding to return the receiver for repair.

Although carefully designed, this receiver (like all receivers) suffers from a degree of internal noises known as spurious. They are a product of the receiver's circuitry and do not represent a fault.

© This manual is protected by copyright AOR Ltd 1995, 1996. No information contained in this manual may be copied or transferred by any means without the prior written consent of AOR Ltd. ® AOR and the **AOR** logo are registered trade marks of AOR, Ltd. All other trade marks and names acknowledged. E&OE.

***If you are very familiar with operating similar equipment you may choose to refer directly to section (6) once you are sure the precautions are fully understood.***

### Operating manual Conventions

Where text appears in a graphic format such as **SCAN**, the key is to be pressed exactly as shown.

For example: **4** **9** **ENTER**

Means press the **4** key followed by the **9** key followed by the **enter** key.

Words contained in speech marks "**PASS**" or "**F - P R 5 5** **∪ F ∩**" refer to indications displayed on the Liquid Crystal Display.

Where the mode of FM is referred to, this indicates **F**requency **M**odulation (narrow and wide depending upon I.F. filter selection). For clarity, the triple function [MHz] [ENT] [TEXT] key is referred to as **ENTER**.

**Note: If you take too long entering data (about 90 seconds) the display will revert to it's original condition.**

## 2-1 Key information and common menus

### The five VFOs are assigned special status (6-2):

<b>VFO-A</b> (V A)	Manual search between VFO-A and VFO-B
<b>VFO-B</b> (V B)	Manual search between VFO-A and VFO-B
<b>VFO-C</b> (V C)	Simple search
<b>VFO-D</b> (V D)	Simple search & accept frequency from the search mode
<b>VFO-E</b> (V E)	Simple search & accept frequency from the scan mode

### Memory write (7-1):

Press and hold the **ENTER** key for more than one second and follow the prompts.

### Mode selection (6-9):

To change the receive mode, briefly press the **MODE** key. The "MODE" legend will flash on the LCD to confirm that the mode select menu has been activated. The following modes are available from the MODE menu: "AUTO", "FM", "AM", "LSB", "USB" and "CW". If automode is currently in use, the legend "AUTO" will be displayed on the LCD. When you have made selection, press **ENTER** to accept the new mode.

To select automode press and hold the **MODE** key for more than one second, the legend "AUTO" is displayed on the LCD to confirm operation.

### AGC (6-9):

Press **FUNC** **STEP**

When in automode the legend "AUT" is displayed.

```
AGC OFF
AGC FAST
AGC MIDDLE
AGC SLOW
```

### Audio characteristics (6-11):

Press **FUNC** **MODE**

```
R-LPF 3.0 kHz
R-HPF 0.05 kHz
DE.EMP 750
CW.PITCH 0.7 kHz
AUDIO INT
```

### Option menu (6-12, 6-13, 15-2, 16-2):

Press **FUNC** **0**

```
DE-SCR OFF (if DS8000 option is fitted)
CTCSS OFF (if CT5000 option is fitted)
DTMF OFF
T-ELMT OFF
```

### Config menu (6-16, 6-17, 6-18, 6-19, 6-20, 6-21):

Press **FUNC** **kHz**

```
LAMP ON
BEEP 4
EXT-IF OFF
BPS 9600
ANT 1
STD.INT 12.8 MHz
```

### Delete menu (7-5, 10-5, 8-8, 12-8, 13-5):

Press **FUNC** then press and hold the **•** key for more than one second.

```
DEL MEM-CH
DEL SEL-CH
DEL M-PASS
DEL SRCH
DEL F-PASS
```

### Additional scan facilities (9-1, 9-2, 9-3, 9-4, 9-5):

Press **FUNC** **SCAN** **UP**

```
PAUSE OFF
DELAY 2.0
L-SQ OFF
VOICE OFF
MODE ALL
```

### Additional VFO facilities (12-3):

Press **FUNC** **VFO**

```
DELAY 2.0
L-SQ OFF
VOICE OFF
```

### Programming search banks (12-7):

Press **FUNC** **1**

```
LO
HI
MODE FM (set to AUTO if AUTOMODE is used)
IFBW 0.5 (skipped if AUTOMODE is used)
STEP 1.000 (skipped if AUTOMODE is used)
TXT
```

### Additional search facilities (12-14, 12-15, 12-16, 12-17, 12-19):

Press **FUNC** **SRCH** **UP**

```
PAUSE OFF
DELAY 2.0
L-SQ OFF
VOICE OFF
A.STORE OFF
```

### Clock programming (14-2):

Press **FUNC** then press and hold the **7** key for more than one second.

```
SELECT 24H / SELECT 12H
6-25-00 1 / AM.6-25-00 1
TXT 1
4-23-30 2 / PM.4-23-30 2
TXT 2
```

### Alarm clock programming (14-4):

Press **FUNC** then press and hold the **8** key for more than one second.

```
ALARM 0-00
ALARM LENGTH 15
ALARM ALM RADIO / ALARM ALM BEEP
ALARM VOLUME 80
```

## 2-2 Accessories supplied

a.c. mains power supply

Operating manual

Additional extensions for front feet

## (3) Major Features

### ● Large LCD

A large rear illuminated liquid crystal display (LCD) provides display of receive frequency, mode, etc plus alpha numeric text along with each search bank and memory channel.

### ● Massive memory

A large EEPROM memory store holds a total of 1000 memory channels (100 ch x 10 banks), and 20 search banks. Each search bank has a total of 100 PASS frequencies plus a further 100 for VFO operation. This type of memory store does not require external power or internal battery power to retain the memory contents. The real time clock is backed by an additional super capacitor which will maintain the correct time for approximately 50 hours even with no external power connected to the receiver.

### ● Wide frequency coverage, all mode, automode

The AR5000 has a very wide frequency coverage of 10kHz to 2600MHz (acceptable input from 5 kHz) in FM, AM, USB, LSB & CW. The all new receive circuitry provides high sensitivity and superior strong signal handling thanks to the clever RF design which is optimised to each receiving band with electronic tuning (pre-selector) circuits up to 1GHz.

Comprehensive bandplan information specific to the target market area has been programmed into the AR5000

receiver. This inclusion will greatly simplify both frequency entry and search programming.

The receiver will *automatically* select the appropriate mode and channel step. Of course, should you wish then both the mode and channel step may be manually changed as desired.

### ● Wide variety of useful operational features

- ◆ High speed *Cyber Scan* and *Cyber Search*
- ◆ Multi VFO (5-VFO)
- ◆ A minimum of 1 Hz tuning rate by NCO
- ◆ Frequency Offset facility to help follow duplex transmission
- ◆ RF preamp & attenuator
- ◆ Auto aerial selection - programmable
- ◆ Wide range of search/scan facilities
- ◆ Pre-programmed automode (receive mode, step size, IF bandwidth)
- ◆ Step-adjust for unusual banplans
- ◆ Standard TCXO plus external 10 MHz input
- ◆ Twin tuning knob (*MAIN DIAL* has a variable torque controller)

### ● Other useful features

- ◆ Variable beep tone
- ◆ Sleep timer On/Off, alarm
- ◆ Analogue signal meter for easy reading
- ◆ Output terminals for external decoder, etc
- ◆ Auto-memory facility (On/Off switchable)
- ◆ RS232 PC remote control
- ◆ Large capacity EEPROM for memory backup
- ◆ Tuning step size from 1Hz to 999.999kHz

## (4) Precautions

### 4-1 Location

Do not use or leave the receiver in direct sunlight (especially the LCD). It is best to avoid locations where excessive heat, humidity, dust and vibration are expected. Always treat the receiver with care.

Take care to avoid spillage or leakage of liquids into the receiver and a.c. power supply. Special care should be taken to avoid liquid entering via the power jack and earphone sockets.

Avoid static discharge from discones or long wire aerials, earth to a central heating radiator or similar earthing point in order to discharge the wire before connection to the receiver. Always disconnect and earth any external aerial system if an electrical storm is expected.

Avoid a rapid power switch On/Off sequence. If switched off, leave at least two seconds before switching on again. Ensure the a.c. mains plug connections are tight and other d.c. connections (such as cigar lighter plugs) are secure.

Avoid strong RF fields from nearby transmitters. If in doubt, disconnect the AR5000 from the aerial and switch the set off.

## 4-2 Looking after your receiver

Always keep the receiver free from dust and water. Use a soft dry cloth to gently wipe the set clean. Never use chemicals such as benzene or thinners which will damage certain parts.

## 4-3 Power requirements

The AR5000 is designed for operation from an external d.c. supply of 12 ~ 16V at approximately 1.0A minimum.

Always use the mains power supply provided, or a regulated d.c. power supply of 13.5V @ 1.0A or more using the optional DC3000 connecting lead. Always switch the receiver off when connecting or disconnecting the power lead.

**Note:** The d.c. input socket uses a special type of connector. This plug / socket is of a moulded type and pre-wired, positive is the RED wire. The chassis of the receiver is negative ground.

The power supply is pre-fitted with the correct mains (a.c.) plug for the appropriate market. This AR5000 power supply has no connection to the EARTH pin of the mains plug. A separate earth may be taken to the outer connection of the SO239, N-type or BNC rear panel sockets, then to a water pipe, central heating system radiator or external earth rod. If fitting a separate external earth rod, consider the implications carefully if your a.c. mains supply uses a Protective Multiple Earth (PME) system. If in doubt consult an expert electrician. Never earth to a gas pipe!

**Safety notice:** Allow air to circulate around the power supply, never cover the top with paper, clothing etc. Always disconnect the power supply from the a.c. mains supply when not in use.

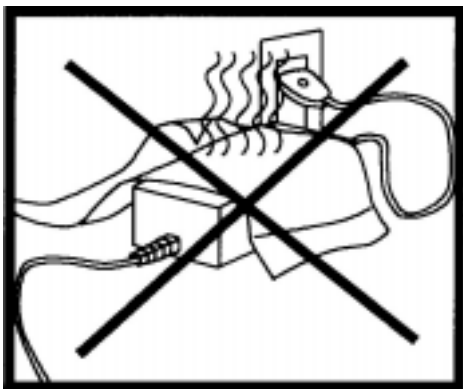

## 4-4 Aerial (antenna) connection

The AR5000 has two 50 OHM aerial input sockets fitted as standard to the rear panel. Further aerials may be connected using the optional aerial switching unit AS5000 with switching data being fed from a rear panel accessory socket (**ACC 2**).

The aerials input selection may be programmed by the user for different bands, at default these are:

**ANT 1:** 50 OHM N-type socket - All frequencies

**ANT 2:** 50 OHM SO239 socket - User selectable

Aerial inter-series adapters are readily available to convert from N-type, SO239 etc to BNC or other plugs & sockets as required allowing straight forward connection to almost any aerial.

An aerial attenuator system allows selection of AUTO, 0dB, 10dB or 20dB. The attenuator control switches in / out of circuit the RF preamplifier and attenuator affecting the sensitivity of the receiver. 20dB may not be selected above 230 MHz. RF gain is also available in all modes via a front panel rotary control, this is especially useful in providing optimum audio quality for SSB operation.

### Aerial Tuning Units (ATU)

An ATU can improve the selectivity of any receiver when listening to the short wave bands when connected to long wire aerials (other than a short wire of a few metres). This valuable extra selectivity is created provided by rejecting out of band signals enabling the receiver to *single out* one band of frequencies while rejecting potentially strong unwanted transmissions. The AR5000 has a built in *automatic preselected front end* for frequencies up to 1GHz.

An ATU is usually constructed in a small box with about two or three controls on the front panel. One disadvantage however is the need to constantly retune the ATU when changing frequency. An ATU of this type has no active circuitry so is known as a **passive** device.

### Active short wave desktop loop aerials

Designed for the short wave bands (such as the AOR LA320), loop aerials have the advantage of small size when compared to long wire aerials, and being within easy reach of the operator it can be rotated to provide directivity. The circuitry offers a small level of gain with the advantage of selectivity similar to that of an ATU.

\* For further information please refer to section 20 of this manual regarding aerial and earth systems.

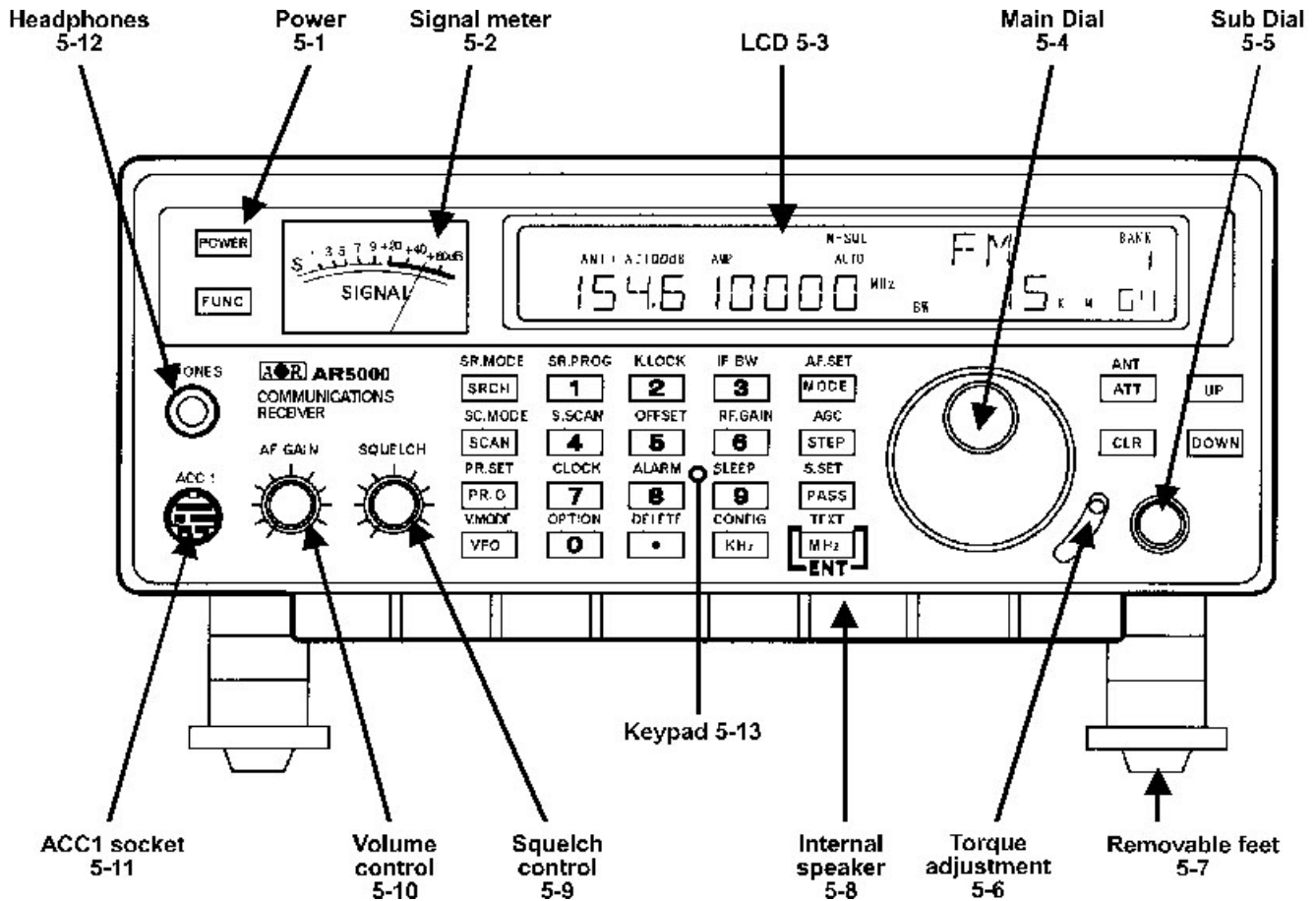

## (5) Controls and functions

The AR5000 receiver is housed in a strong metal cabinet. Controls for operation are located on the front of the cabinet with connections to the rear.

### Front panel

#### 5-1 On/Off power switch **POWER**

This rectangular shaped plastic button (key) is located in the top left corner of the front panel and switches the set On/Off.

To switch the set on, connect a suitable power source and depress the **POWER** switch, the microprocessor will then power the set up.

To switch the receiver off press the **POWER** switch a second time, the microprocessor will then switch the set off.

#### 5-2 S-meter (signal strength meter)

The rear illuminated analogue SIGNAL METER is located to the left hand side of the front panel. Relative strength of incoming signal is indicated in standard **S** points where S1 is weak and S9 is strong. Calibration above S9 is in dB up to +60dB. As with other receivers, the meter is for *relative* signal strength comparison and calibration may not be totally reliable especially on FM mode.

#### 5-3 Liquid Crystal Display (LCD)

Display of operational information is provided via a high contrast wide angle backlit green LCD, this includes frequency, mode, bandwidth, alpha-numeric comments for memory channels and search banks etc.

#### LCD test

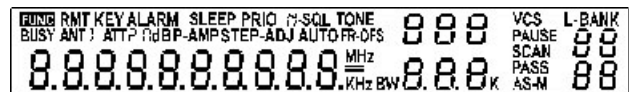

The LCD may be tested by holding the **ENTER** key while switching on the receiver using the **POWER** key.

- 1 Ensure that set is switched off. Press and hold the **ENTER** key... don't let go of it!
- 2 Press the **POWER** key to switch on the AR5000, this may be a two handed operation.
- 3 Release the **ENTER** key. All LCD characters will be displayed.
- 4 Press the **POWER** key to restore a normal display.

Downloaded by   
 Amateur Radio Directory   
  
[www.hamdirectory.info](http://www.hamdirectory.info)

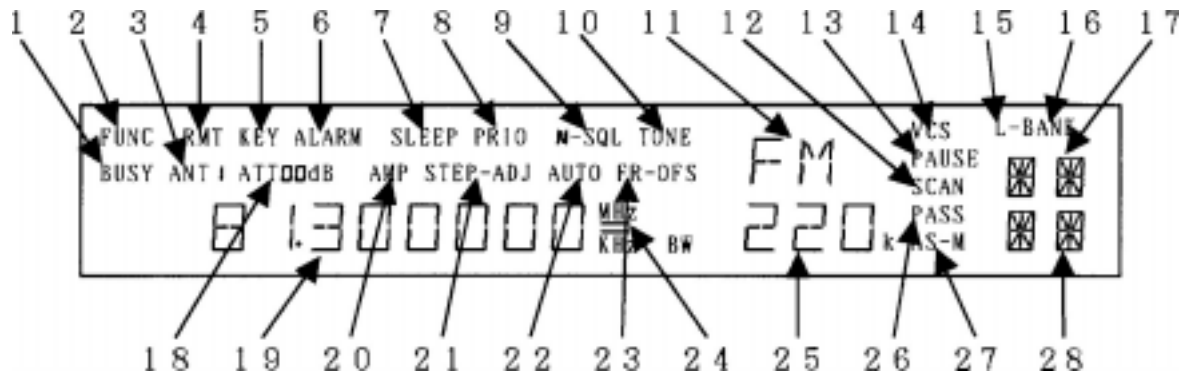

**The display is split into 28 specific areas, a summary of which follows:**

1 **"BUSY"** legend appears when the squelch is open (signal present).

2 **"FUNC"** as a reverse legend appears when the **[FUNC]** key is pressed signifying that the receiver's microprocessor is awaiting the press of another key, where the SECOND FUNCTION shown in white (not orange) adjacent to the keys will be activated... an example is **[FUNC] [2]** to activate the keylock. When the second function is activated, the **"FUNC"** legend disappears and often a new LCD legend appears to confirm selection.

3 **"ANT"** aerial (ANTENNA) number currently in use. As standard this will be **"ANT 1"** or **"ANT 2"** but may be higher if the optional aerial switch AS5000 is in use.

4 **"RMT"** signifies whether the receiver is under normal keypad control or by a REMOTE device such as the optional SDU5000 spectrum display unit or computer. RMT = ReMoTe, *no legend* indicates standard keypad operation.

5 **"KEY"** indicates that KEY LOCK has been selected, this is activated by the key sequence **[FUNC] [2]**. Key lock prevents accidental changing of the receiver's front panel controls. When in the locked condition only the Volume, Squelch, Power and **[FUNC]** controls will respond.

6 **"ALARM"** indicates that the alarm facility has been activated. The legend **"ALARM"** will be displayed on the LCD even when the AR5000 is switched off (as long as power is maintained to the receiver). At the prescribed time, the receiver will automatically switch on. It is possible to program the switch on time, select radio or beep, volume level and duration before switch off.

To activate the alarm use the sequence **[FUNC] [8]**, the same sequence cancels the alarm as a toggle. This is very useful for setting up unattended recording or when using the AR5000 as an alarm clock!

7 **"SLEEP"** indicates that the sleep timer circuit has been activated. When the prescribed time for sleep has elapsed the receiver will switch off automatically... very useful when listening to the radio in bed.

To program the sleep time press **[FUNC]** then press and

hold **[9]** for more than one second. A sleep selection menu will be displayed, use the *MAIN DIAL* or *SUB DIAL* to select the required time (between 1 & 120 minutes) then press **[ENTER]**

To activate / deactivate the SLEEP facility use the toggle sequence **[FUNC] [9]**

8 **"PRIO"** indicates when the PRIORITY facility has been activated by pressing the **[PRIO]** key.

9 **"N-SQL"** and **"L-SQL"** indicate that the receiver is set to operate from its squelch circuit, the **"BUSY"** legend appearing during activity. In normal use **"N-SQL"** noise squelch is used but **"L-SQL"** (level squelch) may be selected for search and scan operations. If neither legend is displayed, the RF GAIN facility has been activated.

10 **"TONE"** is displayed when the optional CTCSS board has been selected for tone decoding, often used by amateur radio repeaters and utility users.

11 **"FM"**, **"AM"**, **"LSB"**, **"USB"** or **"CW"** - indicates AR5000 receive mode.

12 **"SCAN"** is displayed when the memory banks are SCANNED (automatically checked for activity).

13 **"PAUSE"** is a selectable parameter for SCAN and SEARCH modes, the legend indicates that the facility is in operation. The AR5000 will wait the specified duration of pause time on a busy frequency before moving off again even if the frequency is still busy.

14 **"VCS"** is a selectable parameter (VOICE) for SCAN and SEARCH modes, the legend indicates that the facility is in operation. The AR5000 may be programmed to ignore certain types of blank carriers and unwanted signals. The value may be selected between 1 to 255 and OFF while in the scan and search parameter program sub menus.

15 **"L-BANK"** as opposed to **"BANK"** indicates that more than one scan or search bank has been selected to be scanned or searched as a group. In other works the banks have been LINKED, bank link.

16 **"BANK"** indicates that the receiver is currently in memory recall mode (no SCAN legend), scan mode (two lines of bank & channel numbers) or search mode.

In search mode only a bank number and the legend "5 R" is displayed - but no channel number.

**17** The one or two digit number indicates which scan or search banks have been selected. In scan mode the range is 0 to 9 (ten banks) and in search mode 00 to 19 (twenty banks).

**18** Attenuator setting. The display is always preceded by "ATT" (for attenuator) and followed with dB for level (decibel). "ATT 00 dB" indicates attenuator OFF, "ATT 10 dB" indicates that 10dB of attenuation has been applied and "ATT 20 dB" indicates that 20dB of attenuation has been applied. The attenuator menu is activated by the **ATT** key.

**Note:** Above 230 MHz only 0dB & 10dB are available and the RF preamplifier is always in circuit ("AMP" legend displayed). Below 230 MHz the "AMP" is displayed in the "00" position.

**19** Frequency, text and various status messages are displayed in this area. There are a maximum of ten digits providing frequency read-out down to 1Hz resolution. In text mode a maximum of eight characters may be displayed for search bank and memory channel recognition. The frequency red-out is always followed by the legends kHz or MHz.

**Note:** frequencies below 3.0 MHz (3000 kHz) are always shown as kHz.

**20** "AMP" is displayed when the RF preamplifier is switched on. The amplifier is selected in the ATTENUATOR sub menu accessed by pressing **ATT**

**Note:** Above 230 MHz the RF preamplifier "AMP" legend is always displayed. Below 230 MHz the "AMP" is displayed in the "00" attenuator position.

**21** "STEP" is displayed during entry of STEP SIZE (tuning increment) for manual tuning or search operations. "STEP-ADJ" is displayed when the STEP-ADJUST facility is in use so that unusual bandplans may be correctly tracked.

**22** "AUTO" is displayed when the receive mode selection is set to AUTO. In this condition the AR5000 will select the appropriate receive mode, channel step (and many other parameters) for the frequency entered in VFO mode and during search programming. This simplifies operation and speeds up manual changes in frequency.

**23** "FR-OFS" is displayed when the FREQUENCY OFFSET facility is selected. This enables a fixed offset frequency to be stored in a special bank allowing quick frequency change and monitoring of duplex pairs such as inputs to amateur band repeaters or VHF marine traffic.

**24** "=" AGC OFF indication. When the AGC (Automatic Gain Control) is switched off, strong signals may sound distorted... however AGC off may be useful for DX'ing when the optional 500 Hz Collins mechanical CW filter is fitted. To ensure that the AGC is not switched off unintentionally, two parallel bars are displayed between

the MHz / kHz LCD legends. The available selection of AGC is: OFF, FAST, MIDDLE & SLOW.

**25** I.F. filter bandwidth is displayed on the LCD in kHz. The options are:

"220", "110", "30", "15", "8", "3", ("0.5" optional), i.e. "3K" for 3.0 kHz.

**26** "PASS" is displayed to indicate that a memory channel has been LOCKED OUT so that it will not be scanned, similarly with a frequency in search mode, it will be skipped.

**27** "AS-M" indicates that active frequencies found while in search mode will be automatically added to memory bank "0" (Auto Store to Memory). Auto-store is switched on.

**28** The two digit number ranging from 00 to 99 indicates that the AR5000 is in MEMORY RECALL or SCAN mode (if the scan legend is also displayed). The two digit number represents the memory channel number. The **UP** **DOWN** keys or *SUB DIAL* select bank, the *MAIN DIAL* selects memory channel number and the keypad allows direct access to the three digit bank/channel number i.e. **1** **2** **3** for bank 1 channel 23, there is no need to press enter.

In SEARCH mode the letters "5 R" are displayed in this lower right corner of the LCD with the bank number displayed above.

#### 5-4 Main rotary tuning control - *MAIN DIAL*

The large rotary tuning control is prominently located on the front of the cabinet. This control changes the received frequency up and down in whatever step increment has been selected between 1 Hz ~ 999.999 kHz. This control is often referred to as the *VFO* (Variable Frequency Oscillator), a rather historic name for a tuning mechanism. In this operating manual it is referred to as the *MAIN DIAL*.

#### 5-5 Sub rotary tuning control - *SUB DIAL*

This smaller control may be programmed in a number of different ways. It too is largely used to tune the receiver and is intended to make channel tuning easier where channelised bandplans are in force (such as 2m amateur band FM allocations etc). The control is extensively used during the input and changing of operational parameters such as attenuator, IFBW etc. In this operating manual the control is referred to as the *SUB DIAL*.

#### 5-6 Torque adjustment (*MAIN DIAL* brake)

This small slide control affects the *free movement* of the large rotary tuning control (*MAIN DIAL*), this is useful to help prevent unintentional frequency change due to accidental movement of the *MAIN DIAL*. When the lever is in the UPWARD position, the *MAIN DIAL* is FREE RUNNING, moving the lever downward adds friction to dampen the control.



**Note:** A microprocessor *reset* switch is hidden behind the upper section of the lever's slot. Reset can be useful if the receiver's operation has been upset due to static discharge or power supply transients. Details are given in section 18 of this operating manual.

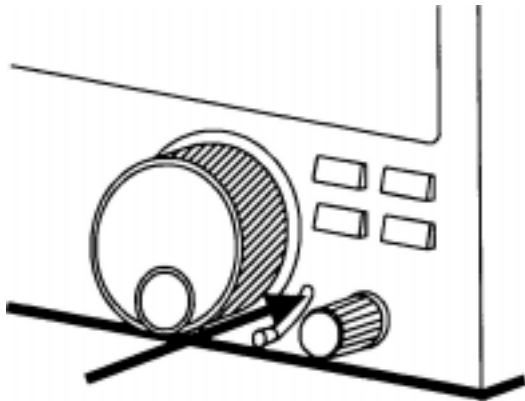

### 5-7 Removable feet

The front of the receiver is lifted up clear of the table top to allow easy access to the front panel controls and clear visibility of the LCD. The front feet may however be removed (unscrewing by hand in an anti-clockwise direction using the knurled disk) for mobile operation. Additional height may be added by fitting the two spacers provided with the receiver in the accessories bag.



### 5-8 Internal speaker

The AR5000 is fitted with a lower case mounted speaker. In order to provide best projection of audio from the receiver, a custom horn has been designed and fitted to the receiver's underside (visible from the front panel).

### 5-9 SQ - squelch control (plus RF control)

The squelch control is used to eliminate unwanted background noise when monitoring a normally inactive frequency and is also used by the AR5000 microprocessor to determine when a channel is *active* (busy). **The receiver cannot scan or search when the background noise is present.**



The squelch control requires careful setting to achieve optimum operating performance. Rotate the control

clockwise until the background noise just disappears (threshold), this is the most sensitive setting of the control. In practice the control is usually rotated a little further clockwise beyond the threshold point to prevent the receiver from stopping on noise or very weak and unreadable signals.

If the control is rotated too far clockwise then weaker signals will be totally lost and only local strong signals will be heard.

When the squelch control is rotated anticlockwise so that background noise is audible, the squelch is referred to as being **OPEN**. In a similar manner, when the squelch control is rotated clockwise so that the background noise is muted, the squelch is referred to as being **CLOSED**.

The squelch is not normally used when listening to short wave transmissions due to the relatively high short wave background noise, the usual setting for the control when listening to short wave is fully anticlockwise (squelch open).

When the squelch is OPEN (busy), a **"BUSY"** legend is displayed on the left of the LCD.

**Note:** Even when the squelch is fully CLOSED a very low level background noise may still be audible. This is because the receiver's audio amplifier circuit is permanently operational in order to provide fast search / scan rates and an efficient squelch opening characteristic. This phenomenon is common with other wide band receivers on the market today.

When the squelch is set up for normal operation, the legend **"N-SQL"** is displayed on the top line of the LCD slightly centre-right, this stands for Noise SQueLch.

### RF GAIN

It is possible to configure the squelch control to function as RF GAIN by selecting **FUNC** **6** on the keypad, the **"N-SQL"** legend is removed from the LCD to confirm operation. The RF GAIN control reduces the level of amplification applied to the receiver's I.F. circuits. This has the effect of reducing the sensitivity of the receiver in much the same way as the attenuator but is more controllable.

The usual position for the AR5000 RF GAIN control is fully anti-clockwise when the set is at its most sensitive. As the control is rotated clockwise the S-meter will advance to indicate what strength signal is required to produce solid and readable results.

The control is most useful on SSB where the RF GAIN should be adjusted so that the **peaks** of SSB signals just deflect the S-meter. This will greatly reduce the level of background noise especially during pauses in speech or inactivity.

When RF GAIN is used (squelch switched off), the word **"N-SQL"** is removed from the top line of the LCD.

## 5-10 Volume control (AF GAIN)

The volume control is located to the left of the front panel underneath the signal meter. It is used to set the required audio output through the loudspeaker or headphone. When turned fully clockwise the volume is at maximum, when rotated fully anti-clockwise the volume is reduced to minimum.

## 5-11 ACC 1 accessory number one socket

A front panel accessory socket is located to the lower left corner of the front panel which provides outputs for audio, tape motor switching and discriminator.

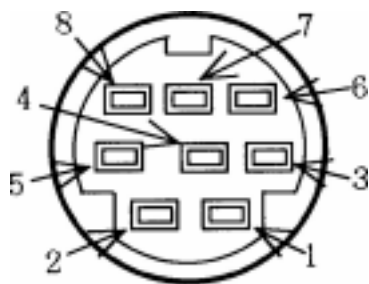

A standard 8-pin mini-din connector is used (which is widely available or the optional CR5000 tape lead may be used). The pin-outs for **ACC 1** are as follows:

**1** 12V d.c. output with a maximum available current of 30mA (useful for feeding electret microphones and other low power devices). The voltage will fluctuate depending upon supply voltage being fed to the AR5000.

**2** Detector output (without audio filtering), useful for improving performance of certain decoders such as pagers etc. The level output is 180mV RMS and impedance is 100k OHMS or greater.

**3** Audio input. The receiver's audio amplifier stage can be configured to use signal from an external device rather than from its own receive circuits. This permits **break-out** of signal for processing (DSP etc) which is then reapplied to the receiver for amplification. The input circuit is configured for a level of 180mV at a nominal impedance of 100k OHMS.

As the internal audio path needs to be **cut** as part of the **break-out** set-up, the microprocessor has to be configured accordingly. To select EXTERNAL AUDIO INPUT press **FUNC** **MODE** then press the **UP** key four times to display "AUDIO INT". Rotate the **SUB DIAL** to display "AUDIO EXT" then press **ENTER**. The usual sound from the receiver will be muted until an external audio signal is applied (fed back in).

Of course, the set's own audio may be fed out through the **ACC 1** socket and back in again which increases the receivers flexibility under certain professional monitoring applications.

**Note:** At high volume levels, a low level leakage of internal audio signal may still be heard from the receiver's speaker... this is normal and does not represent a fault (or problem).

**4 & 5** Tape record motor switching using a non-polarised photo-MOS relay. The switched output is designed for low voltage (12V) d.c. with a maximum current of 350mA, the insulating voltage is 40V. The **switch-on-impedance** is 1.2 OHMS.

**6** High level audio output. The AR5000 provides both high and low level audio output for feeding tape recorders and other remote devices, the output is independent of volume control level. Pin 6 provides a level of 700mV RMS @ 600 OHMS, ideal for line output.

**7** Low level audio output. Pin 7 provides a level of 2mV RMS @ 600 OHMS, ideal for microphone input of tape recorders.

**8** Ground.

## 5-12 Headphone socket

This quarter inch (6.3mm) socket is located on the left hand side of the front cabinet directly underneath the power and **FUNC** keys. A pair of headphones or earphone may be connected with an impedance of 8 OHMS or greater. When this headphone socket is used, the internal speaker and any external speaker will be automatically disconnected.

## 5-13 Front panel keys

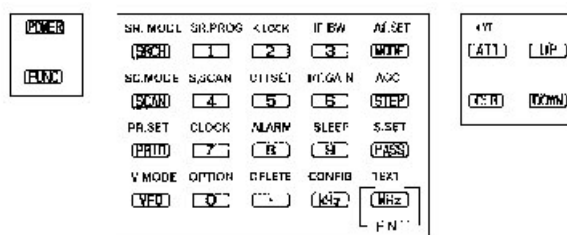

### **POWER** - POWER

This rectangular shaped plastic key located in the upper left corner of the front panel switches the set On/Off.

### **FUNC** - FUNCTION

This key is located to the upper left of the front panel and selects SECOND FUNCTION of the front panel keys. When pressed a reverse "FUNC" appears in the top left of the LCD. The FIRST function of the keys are printed on their faces (in orange for words and white for numbers), the SECOND functions are printed in white directly above the corresponding key.

For example, the select KEY LOCK, press **FUNC** followed by **2**

If you wish to cancel "FUNC" press **FUNC** a second time, or **CLR** or **ENTER** or tune the receiver using the **MAIN DIAL** or **SUB DIAL**.

## **SRCH** - SR.MODE

Pressing the **SRCH** key places the receiver into program search mode. There are twenty search banks in total numbered from 00 to 19. To change the bank number rotate the *SUB DIAL*, the bank number appears in the top right of the LCD. If the receiver stops on an unwanted busy channel during search, it can be forced onward using the **UP** **DOWN** keys or *MAIN DIAL*. To cancel search press **SRCH** again or press **VFO**

The key sequence **FUNC** **SRCH** activates a sub menu where bank link, pause, delay, level squelch, voice squelch and auto-store may be configured.

## **SCAN** - SC.MODE

Pressing the **SCAN** key briefly places the receiver into MEMORY RECALL MODE. The bank number may be selected using the *SUB DIAL*, channel number using the *MAIN DIAL* and three digit bank/channel number using the numeric keypad.

Pressing the **SCAN** a second time places the receiver into memory scan mode. There are ten scan banks in total numbered from 0 to 9. If the receiver stops on an unwanted busy channel during scan, it can be forced onward using the **UP** **DOWN** keys or *MAIN DIAL*. To cancel scan press **SCAN** again or press **VFO**

The key sequence **FUNC** **SCAN** activates a sub menu where bank link, pause, delay, level squelch, voice squelch and mode may be configured.

## **PRIQ** - PR.SET

The priority key **PRIQ** activates / deactivates receive PRIORITY as a toggle. The legend "**PRIQ**" appears on the centre-top row of the LCD to show that priority has been activated and the legend "*Pr*" on the right of the LCD signifies when the priority frequency is currently active (busy).

If the sequence **FUNC** **PRIQ** is keyed, the channel used for priority may be selected followed by the interval for sampling, which is 5 seconds as default.

## **VFO** - V.MODE

The AR5000 has a FIVE VFO system being identified "*V A*", "*V B*", "*V C*", "*V D*" & "*V E*" on the right of the LCD. The term VFO historically means **Variable Frequency Oscillator** and today refers to a tuneable data store which contains frequency, mode, step, attenuator and other relevant information.

The first time you enter a frequency via the numeric keypad, it is best to first press the **VFO** key until "*V A*" is displayed to place the receiver in a known state of operation. The condition of **VFO** (A-VFO), (B-VFO) etc is generally referred to as MANUAL MODE.

If the sequence **FUNC** **VFO** is keyed, additional parameters affecting VFO search operation may be configured: DELAY, L-SQ & VOICE.

## **1** - SR.PROG

Figure ONE for the numeric input of frequencies, bank, channel numbers etc.

The sequence **FUNC** **1** activates the SEARCH PROGRAM menu where bank number, lower frequency limit, upper frequency limit, mode, and text comment may be programmed.

## **2** - K.LOCK

Figure TWO for the numeric input of frequencies, bank, channel numbers etc.

The sequence **FUNC** **2** activates the KEY LOCK which disables all front panel keys except for **FUNC** and **POWER**, the rotary tuning controls (*MAIN DIAL* & *SUB DIAL*) are also locked to prevent accidental misoperation of the receiver when listening to an important frequency. The volume and squelch controls remain operative.

The legend "**KEY**" is displayed on the top row of the LCD left of centre to indicate when key lock is in operation. To unlock the keys press **FUNC** **2** which acts as a toggle.

## **3** - IF BW

Figure THREE for the numeric input of frequencies, bank, channel numbers etc.

The sequence **FUNC** **3** activates the I.F. bandwidth menu. In normal operation the word "**AUTO**" will be displayed toward the centre of the LCD to signify that automode is in operation and the I.F. bandwidth, receiver mode and channel step will be automatically selected by the receiver from its detailed pre-programmed bandplan data. Selecting a new bandwidth from the list of 220, 110, 30, 15, 6 and 3 kHz is accomplished using the *SUB DIAL*, 0.5 kHz is only available if the optional CW filter has been fitted.

Once automode has been cancelled, it may be reinstated from the MODE select menu using a short cut... select AUTO by pressing and holding the **MODE** key for more than one second.

## **4** - S.SCAN

Figure FOUR for the numeric input of frequencies, bank, channel numbers etc.

The sequence **FUNC** **4** initiates SELECT SCAN, a special form of scan where memory channels may be temporarily tagged in a form of notebook.

## 5 - OFFSET

Figure FIVE for the numeric input of frequencies, bank, channel numbers etc.

The sequence **FUNC** **5** initiates FREQUENCY OFFSET where the receiver will automatically jump to a pre-programmed frequency offset, this is very useful for checking the other side of duplex transmissions such as the input frequency of amateur radio repeaters or VHF marine traffic.

The sequence **FUNC** then hold the **5** key for more than one second activates the FREQUENCY OFFSET menu where new offsets may be specified and saved / recalled from one of 48 special locations for easy retrieval at any time.

## 6 - RF GAIN

Figure SIX for the numeric input of frequencies, bank, channel numbers etc.

The sequence **FUNC** **6** activates the RF GAIN control in place of the squelch control. The “*N-SQL*” legend is removed from the LCD to confirm operation. The RF GAIN control reduces the level of amplification applied to the receiver’s I.F. circuits. This has the effect of reducing the sensitivity of the receiver in much the same way as the attenuator but is more controllable.

The usual position for the AR5000 RF GAIN control is fully anti-clockwise when the set is at its most sensitive. As the control is rotated clockwise the S-meter will advance to indicate what strength signal is required to produce solid and readable results.

The control is most useful on SSB where the RF GAIN should be adjusted so that the *peaks* of SSB signals just deflect the S-meter. This will greatly reduce the level of background noise especially during pauses in speech or inactivity.

When the squelch control is switched off and RF GAIN used, the legend “*N-SQL*” is removed from the top line of the LCD slightly centre-right.

## 7 - CLOCK

Figure SEVEN for the numeric input of frequencies, bank, channel numbers etc.

If the sequence **FUNC** **7** is keyed, the clock is displayed on the LCD. The *SUB DIAL* may be used to select one of two clocks (a second clock is often useful to store world time of a regular DX site).

The sequence **FUNC** then hold the **7** key for more than one second activates the clock set menu where display of 12hr / 24hr may be selected, times set for both clocks and a three character text identifier added to each clock.

## 8 - ALARM

Figure EIGHT for the numeric input of frequencies, bank, channel numbers etc.

The sequence **FUNC** **8** activates the ALARM which can be programmed to switch the receiver on automatically as an alarm clock or for unattended recording with the provision to program the active period between 1 and 120 minutes.

The sequence **FUNC** then hold the **8** key for more than one second activates the alarm set menu.

## 9 - SLEEP

Figure NINE for the numeric input of frequencies, bank, channel numbers etc.

The sequence **FUNC** **9** activates the SLEEP facility which can be programmed to switch the receiver off automatically after a prescribed time period of 1 to 120 minutes... useful if you go to sleep with the AR5000 as a bedside radio.

The sequence **FUNC** then hold the **9** key for more than one second activates the sleep set menu.

## 0 - OPTION

Figure ZERO for the numeric input of frequencies, bank, channel numbers etc.

The sequence **FUNC** **0** activates the OPTION menu where the options of DTMF tone display and T-ELMT may be selected. If the optional boards are fitted, DE-SCR (descrambler, not available in all countries) and CTCSS tone selection may also be configured.

## • - DELETE

Used during the MHz input of frequency to separate the MHz to the left of the frequency input from the rest of the entry of kHz and Hz. For example the entry of 88.300000 MHz would be **8** **8** **•** **3** **ENTER**

**Note:** frequencies below 3.0 MHz (3000 kHz) are always displayed as kHz regardless of input format.

The sequence of **FUNC** **•** while in memory recall mode causes the displayed memory channel to be deleted.

The sequence **FUNC** then hold the **•** key for more than one second activates the DELETE menu where the item to be deleted may be selected:

<i>M E M - C H</i>	memory channel
<i>S E L - C H</i>	select scan channel
<i>M - P A S S</i>	memory channel pass
<i>S R C H</i>	search bank
<i>F - P A S S</i>	frequency pass

## **kHz** - CONFIG

This key is used to accept frequency input via the numeric keypad in kHz format. For example: To key in a frequency of 954 kHz key **9** **5** **4** **kHz** the LCD will display 954.000 kHz. This has the same effect as keying 0.954MHz or .954MHz

**Note:** keying a decimal **.** before the number causes a preceding zero to be added automatically.

The kHz method of frequency entry reduces the number of key presses required when working with low frequencies and simplifies operation as short wave listings are often stated in kHz. Example: Oceanic air traffic 5616kHz or short wave transmissions Radio Netherlands 5955kHz and 6045kHz.

The key sequence **FUNC** **kHz** activates the CONFIG menu where the lamp On/Off, keypad beep tone status OFF / volume, external IF output, remote baud rate, aerial (antenna) automatic switching and internal / external frequency reference may be configured.

## **MODE** - AF.SET

This key is used primarily to select receive mode. **To select AUTOMODE press and hold the **MODE** key for more than one second**, the receive mode, I.F. bandwidth and frequency step will be selected by the AR5000 automatically from its extensive pre-programmed bandplan listing.

When automode is in operation, the legend "**AUTO**" is displayed above the right hand digit (Hz position) of the frequency red-out.

To over-ride the receive mode, briefly press the **MODE** key. The options are: FM, AM, LSB, USB, CW and AUTO. WFM is supported as a product of the I.F. bandwidth selected (i.e. 110 or 220 kHz).

The key sequence **FUNC** **MODE** activates the AF.SET (audio frequency set-up) where the **AUDIO LOW PASS FILTER** (3.0 kHz, 4.0 kHz, 6.0 kHz or 12 kHz), **AUDIO HIGH PASS FILTER** (0.05 kHz, 0.2 kHz, 0.3 kHz or 0.4 kHz), **AUDIO DE-EMPHASIS** (25, 50, 75, 750 or THRU), **CW PITCH** (0.4 kHz, 0.5 kHz, 0.6 kHz, 0.7 kHz, 0.8 kHz, 0.9 kHz, 1.0 kHz or 1.1 kHz) and **AUDIO INPUT** (INTERNAL or EXTERNAL) may be configured.

## **STEP** - AGC

This key primarily selects the frequency step size for tuning the receiver. If the legend "**AUTO**" is displayed then the step size will automatically be determined from the automode bandplan data, as soon as another selection is made automode is cancelled.

The standard step sizes offered for the *MAIN DIAL* are: 0.001 kHz (1 Hz), 0.010 kHz (10 Hz), 0.050 kHz (50 Hz), 0.100 kHz (100 Hz), 0.500 kHz (500 Hz), 1.000 kHz, 5.000kHz, 6.250 kHz, 9.000 kHz, 10.000 kHz, 12.500 kHz, 20.000 kHz, 25.000 kHz, 30.000 kHz, 50.000 kHz, 100.000 kHz and 500.000 kHz.

In addition unusual step sizes may be entered using the numeric keypad (i.e. **2** **2** **ENTER** for 22 kHz or **0** **.** **2** **ENTER** for 200 Hz).

The *SUB DIAL* may also be configured for: MAIN (same as *MAIN DIAL*), x10 speed of *MAIN DIAL*, 0.1 kHz, 0.5 kHz, 1.0 kHz, 5.0 kHz, 10.0 kHz, 50.0 kHz, 100.0 kHz, 500 kHz or 1000.0 kHz (1 MHz).

## AGC

The key sequence **FUNC** **STEP** activates the AGC (Automatic Gain Control) menu.

In FM mode the options are AGC ON / OFF and in other modes are OFF, FAST, MIDDLE and SLOW. When AGC OFF has been selected, two horizontal bars are displayed on the LCD between the kHz and MHz legends.

**FM:**                    *AGC OFF*  
                             *AGC ON*

**Other modes:**        *AGC OFF*  
                             *AGC FAST*  
                             *AGC MIDDLE*  
                             *AGC SLOW*

**Note:** "*AUT*" for AUTO AGC will be displayed toward the top right of the LCD if AUTOMODE is in operation and the appropriate AGC selection will be made automatically by the AR5000.

## **PASS** - S.SET

This key is used to PASS (skip over) unwanted active frequencies in search and scan mode. In search mode, the unwanted frequencies are held in a special PASS LIST where they may be added to, deleted or reviewed. In scan mode the memory is locked out so is skipped.

The pass list is laid out in 20 banks for search mode (00 to 19) plus one extra for frequencies to be skipped while in VFO mode.

Pressing the **PASS** key while in memory recall mode or scan mode **locks out** the current channel so that it will be skipped over. The "**PASS**" legend is displayed to the left of the memory channel number (above the "**M**" legend) to signify that the channel is selected as PASS. The **PASS** key acts as a toggle, simply press it again to remove the PASS status.

When the key sequence **FUNC** **PASS** is keyed while in SCAN mode or MEMORY RECALL mode, the displayed channel is added to the SELECT SCAN list. This is a special temporary notepad memory bank. The legend "**5**" is added to the display above the channel number, to the left of the bank number to signify that the channel is selected for SELECT SCAN (see section 10 of this manual).

**Note:** If this key is accidentally pressed, it may give the impression that the AR5000 is not receiving certain frequencies... so make sure you are familiar with the PASS operations.

The **PASS** key also allows selection On/Off of certain options while in menus (such as step-adjust) and selects defaults in other menus.

### **ENTER** - [MHz] [ENT] - TXT (*Cyber Scan*)

This key has three main applications:

**MHz** - the key is used to enter frequencies as MHz while in VFO mode. For example to enter a frequency of 88.300 MHz follow the key sequence **8** **8** **.** **3** **ENTER**. There is no need to add the trailing zeros to the right, once the **.** key has been used, the AR5000 microprocessor will automatically add the additional trailing digits. The display will read "88.300000 MHz"

**Note:** Frequencies below 3.0 MHz (3000 kHz) will be displayed as kHz regardless of the entry format. It is usually more convenient to enter medium wave / long wave frequencies using the kHz format.

**ENT** - the key is used as ENTER in *many* operations and to complete sequences in most menus.

If the **ENTER** key is held for more than one second while in VFO mode, the receiver enters memory write mode. Use the *MAIN DIAL* to select **channel number** to be overwritten, the *SUB DIAL* to select the memory **bank number** or key in the three digit memory location using the numeric keypad. Pressing the **ENTER**, **UP** or **DOWN** key will enable text comments of up to eight characters to be added to each memory channel.

The key sequence **FUNC** then press and hold the **ENTER** key for more than one second activates *CYBER SCAN* where scan and search speeds are approximately doubled (the frequency display is blanked out during *CYBER SCAN* & *CYBER SEARCH*).

**TEXT** - The key sequence **FUNC** then a brief press of **ENTER** causes the TEXT COMMENTS to be displayed in memory recall, scan and search modes (in place of the frequency readout).

### **ATT** - ANT

This key activates the RF attenuator menu.

An aerial attenuator system allows selection of AUTO, 0dB, 10dB or 20dB. The attenuator control switches in / out of circuit the RF preamplifier and attenuator affecting the sensitivity of the receiver. 20dB may not be selected above 230 MHz. RF gain is also available in all modes via a front panel rotary control, this is especially useful in providing optimum audio quality for SSB operation.

The selection of attenuator is made using the *SUB DIAL*, the final selection is accepted by pressing the **ENTER** key.

The key sequence **FUNC** **ATT** activates the aerial selection menu. The *SUB DIAL* is used to select input via either of the two rear panel aerial sockets (**ANT 1** for the N-type input and **ANT 2** for the SO239). Additional aerials

may also be controlled via the optional AS5000 switching unit. AUTO may be selected where the aerial will be automatically switched based upon the programming of frequency / aerial data.

The sequence **FUNC** followed by the **ATT** key being held for more than one second activates the M.TUNE AUTO / MANU RF input preselection for frequencies up to 999.999999 MHz. The default is AUTO where the microprocessor controls the RF front end preselection. However if strong adjacent-channel interference is experienced, the preselection may manually moved *off frequency* reducing interference. Under this situation the *on channel* sensitivity will generally be reduced to some degree, for this reason do not manually tune the preselector too far away from the start point.

The **UP** **DOWN** keys toggle between AUTO and M.TUNE with preselection being controlled by the *SUB DIAL*. To accept changes press **ENTER**.

### **CLR** - CLEAR

The CLEAR key may be used to abort frequency entry during programming or to escape from a menu. If the **CLR** key is held depressed while the receiver is switched on using the **POWER** key, the AR5000 microprocessor will be *soft reset*.

### **UP** - UP

This key has three functions:

**UP** - if quickly pressed causes the displayed frequency in VFO mode to be incremented in an upward direction by one step. The key may be pressed to force the scan and search onward past a busy frequency or channel, it may also be used to reverse the direction of scan and search.

If held for more than one second while in VFO mode, *frequency search* is initiated. If held for more than one second while in memory recall mode, the *scan* process will start.

**INCREMENT** - the key will often increment menu options such as DTMF to T.ELMT etc. While in TEXT write mode, the **UP** key will move the cursor one space to the right.

**BACK SPACE** - if an error is made while keying in frequencies in VFO mode, the **UP** key may be used to back space delete the entry from the right hand side. If all digits are deleted, the display will return to the previous frequency.

### **DOWN** - DOWN

If this key is quickly pressed, the displayed frequency in VFO mode to be incremented in a downward direction by one step. The key may be pressed to force the scan and search onward past a busy frequency or channel, it may also be used to reverse the direction of scan and search.

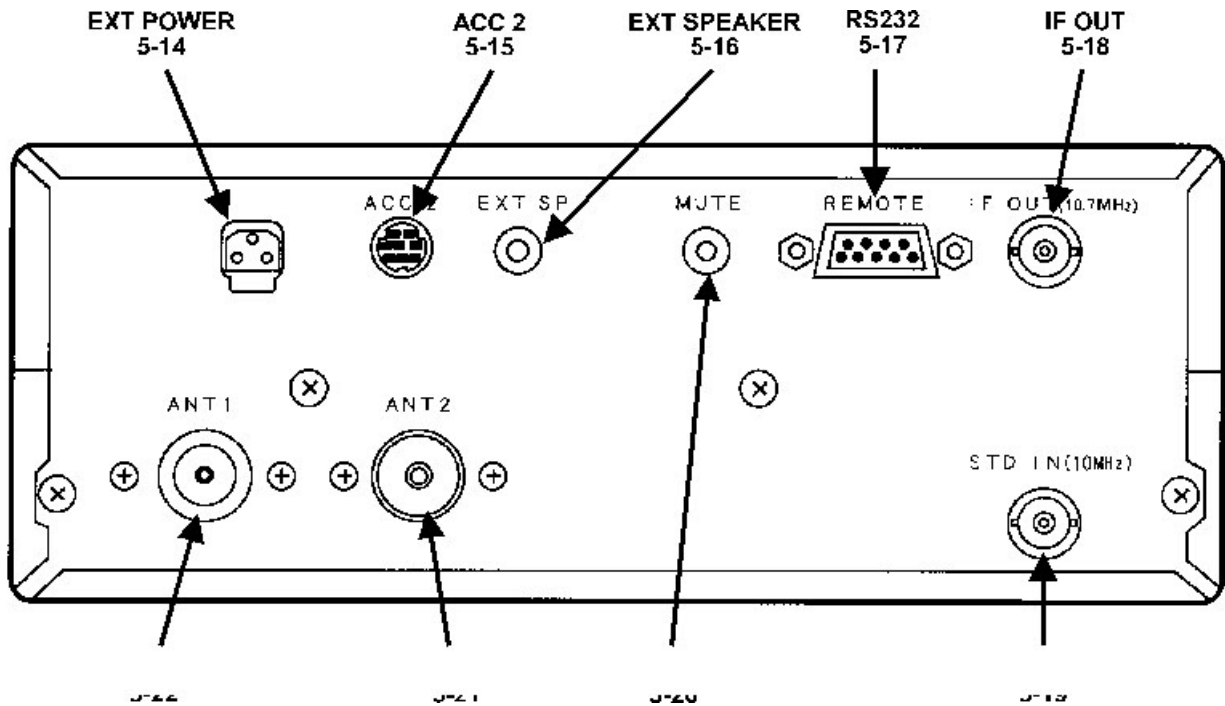

If held for more than one second while in VFO mode, a frequency search is initiated. If held for more than one second while in memory recall mode, the scan process will start.

**INCREMENT** - the key will often increment menu options such as DTMF to T.ELMT etc. While in TEXT write mode, the **DOWN** key will move the cursor one space to the left.

## Rear panel

### 5-14 DC 12V - external power connection

This is a special three pin socket designed to accept external d.c. input of a nominal 13.5V d.c. @ 1.0A negative ground. You may either connect the power supply provided or another suitable supply such as a 12V car battery using the optional DC3000 d.c. lead and observing the correct polarity:

**RED** = positive  
**WHITE** (black on some cables) = negative

Viewed from the rear of the receiver, the socket forms a pyramid of three terminals. The top is not used, the left is negative and the right positive. You need not worry about this in normal use as the special plugs are pre-wired and moulded onto the lead.

**Note: At no time must a.c. mains power (100/110/120/220/230/240V a.c.) be connected directly to this socket or serious damage may occur including the risk of personal injury and fire.**

### 5-15 ACC 2 (accessory 2 socket)

This 8-pin miniature socket is used for connection of an optional aerial (antenna) switching unit (AS5000) so that

more than two aerials (up to four) may be connected to the receiver and switched manually or automatically from the receivers front panel.

The optional AS5000 is connected to **ANT 1** and the control switching signal is taken from **ACC 2**. **ANT 2** is left unaffected and available for connection to an aerial leaving the AS5000 to provide access to **ANT 1**, **ANT 3** and **ANT 4**.

**Note: ACC 2** uses a different plug/socket to **ACC 1**. A typical example of the **ACC 2** plug is manufactured by Hoshiden type TCP6180-01-1120.

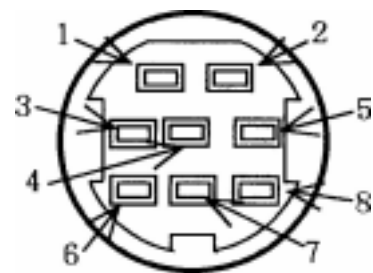

Pin out is as follows:

- 1 12V 50mA MAX
- 2 10V 50mA MAX
- 3 AGC 4.5 ~ 3.0V
- 4 No connection
- 5 ANT SW A (data line)
- 6 ANT SW B (data line)
- 7 No connection
- 8 Ground

Downloaded by   
**Amateur Radio Directory**   
  
[www.hamdirectory.info](http://www.hamdirectory.info)





## 5-21 ANT 2

This is the secondary aerial (antenna) input for the AR5000 receiver. It may be controlled from the front panel or programmed to switch automatically.

The socket is a 50 OHM SO239 type and the corresponding plug is the PL259. Many off the shelf inter-series adapters are available for connection to BNC, N-type or other types of aerial termination.

## 5-22 ANT 1

This is the primary aerial (antenna) input for the AR5000 receiver. It may be controlled from the front panel or programmed to switch automatically.

The socket is a high quality 50 OHM N-type. Many off the shelf inter-series adapters are available for connection to BNC, PL259/SO239 or other types of aerial termination.

---

---

## (6) Basic manual operation of the receiver

To achieve the maximum use of the receiver's performance and features, it is important to fully familiarise yourself with it's operation through the use of this handbook.

Connect and select an appropriate aerial (antenna) to the **ANT 1** input on the rear of the receiver. The selection of aerial depends upon your location and specific requirements but may include a dipole, discone, colinear or long wire. There is further aerial information in section 20 of this manual, if in doubt please consult your dealer.

Connect the AR5000 to an appropriate d.c. power source using either the supplied a.c. adapter or optional DC3000 d.c. lead.

**Note: Never connect the AR5000 directly to the a.c. mains supply.**

Before turning on the power switch, set the volume to the 10 o'clock position and squelch control to the 12 o'clock position.



## 6-1 Switching on for the first time

Press and release the **POWER** switch, the receiver will power up and the LCD back light will illuminate.

Press the **VFO** key a few times until the legend "V R" is displayed in the lower right corner of the LCD. Press and hold the **MODE** key for more than one second so that the "AUTO" legend is displayed in the centre of the LCD above

the last right hand digit of the frequency readout (Hz position) to ensure the receiver is in AUTO MODE. This places the receiver into a known state of operation ready to accept frequency input, change of mode etc. As with all modern microprocessor controlled equipment, the AR5000 has enormous potential and capabilities.

**Note:** The AR5000 uses an EEPROM (Electrically Erasable Programmable Read Only Memory) for storage of memories and other parameters. A permanent storage EEPROM has the advantage of not requiring a back-up battery to maintain data even when the receiver is disconnected from a power supply. The EEPROM may be over-written many thousands of times.

## 6-2 Changing VFO

The term VFO historically means **Variable Frequency Oscillator** and today refers to a tuneable data store which contains frequency, mode, step, and attenuator information.

The AR5000 has a total of FIVE VFOs which store frequency, mode, tuning step, I.F. bandwidth, attenuator setting etc. VFO mode is selected using the **VFO** key. The currently active VFO is displayed in the lower right corner of the LCD as "V R", "V B", "V E", "V D" and "V F". To cycle through the five VFOs, press the **VFO** key repeatedly until the desired VFO is displayed.

Each VFO can be used for tuning and keying frequencies, all can hold different parameters. This is useful for keeping one VFO on VHF airband (AM), one on VHF marine band (FM), one on 20m amateur band (USB) etc...

In addition, the five VFOs are assigned additional status:

### VFO-A

#### VFO-B Manual search between VFO-A and VFO-B displayed frequencies

*If an automatic frequency search is initiated with "V R" or "V B" displayed, the process will loop from the start frequency in VFO-A and search until it gets to VFO-B then loop back to the start frequency of VFO-A and repeat.*

*The key sequence **FUNC** **VFO** accesses a menu where the DELAY, L-SQ level squelch and VOICE options may be set up for search between VFO-A and VFO-B.*

### VFO-C

#### VFO-D Accept the frequency from the search mode

*If a frequency is keyed in to VFO-C or VFO-D and the **VFO** key held for more than one second the search process will commence from the displayed frequency.*

*If **ENTER** is pressed while in SEARCH MODE, the active frequency will be transferred to VFO-D, the AR5000 will switch to VFO-D automatically where you may monitor and tune from the selected frequency.*

### VFO-E Accept the frequency from the scan mode

If a frequency is keyed in to VFO-E and the **VFO** key held for more than one second the search process will commence from the displayed frequency.

If **ENTER** is pressed while in SCAN MODE, the active frequency will be transferred to VFO-E, the AR5000 will switch to VFO-E automatically where you may monitor and tune from the selected frequency.

**Note: If you press the VFO key for one second or longer, SEARCH will be activated.**

### 6-3 Tuning the receiver using the rotary controls

The receiver may be tuned using the rotary tuning controls (**MAIN DIAL** and **SUB DIAL**) which are used to select receive frequency and in memory mode for selection of memory channel etc.

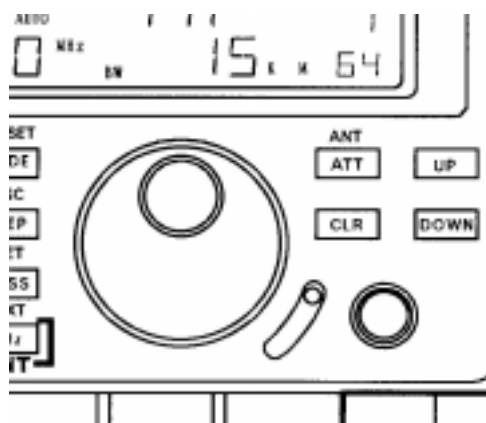

A tuning knob is by far the most **traditional** approach to tuning on short wave, the **MAIN DIAL** provides a smooth feel and the best method of user interface especially when listening on the SSB, FAX and CW modes. The **SUB DIAL** is indented so tunes in a number of clicks and is best suited for channelised tuning on the VHF/UHF bands.

It is possible to tune the receiver through it's entire range from 10 kHz to 2600 MHz. Rotating the **MAIN DIAL** & **SUB DIAL** clockwise increases the displayed frequency (and tunes the receiver upward), rotating the controls anti-clockwise decreases the displayed frequency (and tunes the receiver downward).

The **UP** **DOWN** keys may also be used to increase or decrease the receive frequency.

The AR5000 has an AUTOMODE capability where the receive mode, frequency step and I.F. filter selection is made automatically by the AR5000 microprocessor following detailed bandplan information (for each world market area). This very much simplifies and speeds up operation, particularly in the early stages of familiarisation.

When automode is active, the legend "**AUTO**" is displayed above the right hand digit (last one, Hz) of frequency readout. If it is not displayed, press and hold the **MODE**

key for more than one second, the "**AUTO**" legend will appear on the LCD to confirm selection.

### 6-4 Entering a frequency via the numeric keypad

Select VFO mode and the desired VFO out of the five available "**V A**", "**V B**", "**V C**", "**V D**" and "**V E**", this achieved by pressing the **VFO** key several times until the desired VFO is displayed on the lower right corner of the LCD (i.e. "**V A**").

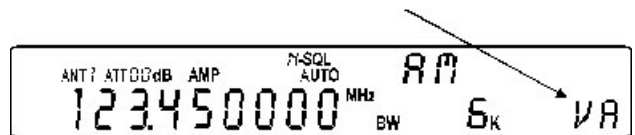

The AR5000 is now in a known state of operation ready for data input.

There are two methods of frequency entry, MHz & kHz:

#### MHz

The **ENTER** key is used to enter frequencies as MHz while in VFO mode. For example to enter a frequency of 88.300 MHz follow the key sequence **8** **8** **.** **3** **ENTER**. There is no need to add the trailing zeros to the right, once the **.** key has been used the AR5000 microprocessor will automatically add the additional trailing digits. The display will read "**88.300000 MHz**"



#### kHz

The **kHz** key is used to accept frequency input via the numeric keypad in kHz format. For example: To key in a frequency of 954 kHz, key **9** **5** **4** **kHz** the LCD will display "**954.000 kHz**". This has the same effect as keying 0.954MHz or .954MHz (**Note:** keying a decimal **.** before the number causes a preceding zero to be added automatically).



The kHz method of frequency entry reduces the number of key presses required when working with low frequencies and simplifies operation as short wave listings are often stated in kHz. Example: Oceanic air traffic 5616kHz or short wave transmissions Radio Netherlands 5955kHz and 6045kHz.

**Note:** Frequencies below 3.0 MHz (3000 kHz) will always be displayed as kHz regardless of the entry format. It is usually more convenient to enter medium wave / long wave frequencies using the kHz format.

Providing the AUTOMODE facility has been engaged (so that the "AUTO" legend is displayed above the right hand digit of frequency readout), you may monitor the frequency or tune the receiver using the *MAIN DIAL* or *SUB DIAL*. The AR5000 microprocessor will automatically select the appropriate tuning increment, mode and I.F. bandwidth from the detailed automode bandplan data pre-programmed into the receiver (specific to each world market area). If automode is not active, press and hold the **MODE** key for more than one second. The "AUTO" legend on the LCD will confirm operation.

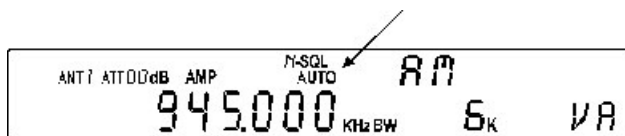

### 6-5 Correction of frequency during input via the numeric keypad

Should a mistake be made while entering frequency via the keypad in VFO mode, the **UP** key may be used to backspace delete the entry from the right hand side. If all digits are deleted, the display will return to the previous frequency.

### 6-6 Selecting tuning step (increment)

The specification for channel occupancy, step (separation) and mode are decided by and allocated by departments of Government following International discussions.

Not surprisingly the allocation of frequency bands are not the same all over the world and channel separation (step) varies from band to band. As an example, the channel separation (step) for the medium wave band in Europe is 9 kHz while in the U.S.A. it is 10 kHz.

For the above reason it is necessary to alter the STEP size according to local bandplan conventions. The AR5000 has been pre-programmed at the factory with all the bandplan data (specific to each market area) so that the AR5000 will automatically select the appropriate step size and mode for the frequency chosen. This greatly simplifies operation of the receiver while you are familiarising yourself with all the facilities.

The pre-programming of step size may be manually overridden so you may choose alternative settings at will or when bandplans are updated.

The tuning step (often referred to as the tuning rate or increment) is usually automatically set by the AR5000 using the automode bandplan information - WHEN AUTOMODE IS ENGAGED.

**To enable AUTOMODE, press and hold the **MODE** key for more than one second, the "AUTO" legend will appear on the LCD above the right hand (last) digit of the frequency readout to confirm selection.**

Most known step sizes are available with the exceptions such as TV channels which are allocated with 6MHz or 4MHz spacing. There will be occasions when you may wish to change the automode step selection so it is possible to customise the step size used by the *MAIN DIAL* and *SUB DIAL* (step size may also be programmed in search mode).

### MAIN DIAL

Only when the VFO mode is engaged may the *MAIN DIAL* be used to select the receive frequency. Rotate the *MAIN DIAL* to change the receive frequency, alternatively the **UP** and **DOWN** keys can be used. Frequency will step in the pre-programmed step size as dictated by the automode bandplan data.

The **STEP** key enables the step size for tuning the receiver to be customised.

Press the **STEP** key, the flashing legend "STEP" on the LCD confirms that the STEP SELECT MENU has been activated. If the legend "R U T" is displayed above-right, then the step will automatically be determined from the automode bandplan data. As soon as another selection is made automode is cancelled.



At this point the *SUB DIAL* may be rotated to select a new step size for the *MAIN DIAL* from the following list: 0.001 kHz (1 Hz), 0.010 kHz (10 Hz), 0.050 kHz (50 Hz), 0.100 kHz (100 Hz), 0.500 kHz (500 Hz), 1.000 kHz, 5.000kHz, 6.250 kHz, 9.000 kHz, 10.000 kHz, 12.500 kHz, 20.000 kHz, 25.000 kHz, 30.000 kHz, 50.000 kHz, 100.000 kHz and 500 kHz.

Once the selection has been made press **ENTER** to accept any changes. If you wish to abort step size selection press **CLR**.

In addition, unusual step sizes may be entered using the numeric keypad (i.e. **2 2 ENTER** for 22 kHz or **0 2 ENTER** for 200 Hz). Acceptable input range is 1 Hz to 999.999 kHz.

**Important:** The receive frequency must be divisible by the step size or the receiver will not receive the desired frequency or follow the bandplan.

Examples:

Receive frequency / Step size **must = round number**

433.200MHz/20kHz = Divisible (433200 / 20 = 21660 all okay)

152.010MHz/20kHz = Not divisible (152010 / 20 = 7600.5 so must use the special STEP-ADJUST FACILITY detailed section 6-7 of this manual).

**Note:** The *MAIN DIAL* is a mechanical encoder and as such small variations in tuning may be experienced or the frequency may move slightly after rotation, this is normal. To ensure the best life span and smoothest operation, rotate the control from time to time to ensure the encoder's track remains clean.

## SUB DIAL

The *SUB DIAL* can also be used to select the receive frequency in three different ways:

- Same step size as the *MAIN DIAL*
- 10 times faster than the *MAIN DIAL*
- One of the step sizes from 0.1 kHz (100 Hz), 0.5 kHz (500 Hz), 1.0 kHz, 5.0 kHz, 10.0 kHz, 50.0 kHz, 100.0 kHz, 500.0 kHz or 1000.0 kHz (1 MHz).

The **[STEP]** key enables the step size for the *SUB DIAL* to be selected.

Press the **[STEP]** key, the flashing legend "STEP" on the LCD confirms that the STEP SELECT MENU has been activated. The first menu is for the *MAIN DIAL* so press **[UP]** or **[DOWN]** to move on to the *SUB DIAL* configuration (if step adjust is in use the legend "\*" will be displayed and the **[UP]** **[DOWN]** keys will require two presses to increment to the *SUB DIAL* menu). The flashing legends on the LCD "STEP" and "SUB" indicate that the *SUB DIAL* step selection menu has been activated. Use the *SUB DIAL* to make selection:

```
SUB MAIN
SUB X 10
SUB 0.1 kHz
```

**MAIN** = tuning rate for the *SUB DIAL* will be the same as that of the *MAIN DIAL*.

**x10** = tuning rate of the *SUB DIAL* will be ten times faster than the *MAIN DIAL* (i.e. a tuning rate on the *MAIN DIAL* of 25 kHz will be 250 kHz on the *SUB DIAL*).

**0.1 kHz** (100 Hz), 0.5 kHz (500 Hz), 1.0 kHz, 5.0 kHz, 10.0 kHz, 50.0 kHz, 100.0 kHz, 500.0 kHz, 1000.0 kHz (1 MHz) = tuning rates for *SUB DIAL*.

When the selection has been made, press **[ENTER]** to accept the changes and return to VFO mode. If you wish to abort step size selection press **[CLR]**

## 6-7 Step-adjust

The AR5000 provides a powerful feature to enable accurate following of unusual bandplans. When active, the "STEP-ADJ" legend is displayed in the centre of the LCD.

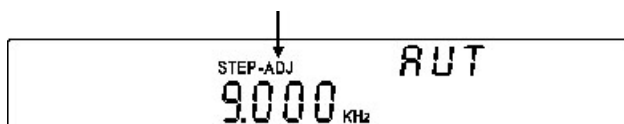

Step-adjust is used when the receiving frequency is not divisible by the step size in use (It is possible that step-adjust has been programmed into the automode bandplan data for some world market areas). Therefore step-adjust is useful for certain bandplans such as cellular which in some areas starts as 917.0125 MHz then increments in 25 kHz steps. Another example is the CB allocation in certain areas which starts at 27.60125 MHz then increments in 10 kHz steps.

## Example:

Tune through the UK CB frequencies of 27.60125 MHz in 10 kHz steps with mode set to FM, 15 kHz bandwidth.

**Select frequency:** Select the start frequency for tuning, in this example 27.60125 MHz **[2]** **[7]** **[.]** **[6]** **[0]**  
**[1]** **[2]** **[5]** **[ENTER]**



**Set up step:** Press the **[STEP]** key to access the tuning step menu. Select a step size of 10 kHz by pressing **[1]** **[0]** **[ENTER]**. Select STEP-ADJUST by pressing **[PASS]**, the "\*" legend is displayed on the left of the LCD to confirm operation. Complete the sequence by pressing **[ENTER]**.



You may review or change the **offset** value used by step-adjust via the STEP menu. Press **[STEP]** to access the tuning step menu. Initially the **step** size is displayed, press **[UP]** to view the **STEP-ADJUST** value.



**Note:** It is possible to enter a new value of step-adjust using the *SUB DIAL* and numeric keypad (i.e. **[7]** **[kHz]**) while viewing the step-adjust value, you can experiment with interesting results! If you intend **direct** programming please refer to the mathematical explanation at the end of this section 6-7.

**Half step:** If the original tuned frequency were a round number such as 145.000 MHz with a step size of say 25 kHz, the **default** step-adjust would be **half of the original step size (12.5 kHz)**.

Press **[ENTER]** to accept the data input and return to VFO mode. Alternatively press **[CLR]** to abort entry and return to VFO mode.

**Select receive mode:** Press the **[MODE]** key and use the *SUB DIAL* to select "FM". Press **[ENTER]** to accept the selection and return to VFO mode.



**Select receive bandwidth:** For point-to-point communications a bandwidth of 15 kHz usually provides best results, however if adjacent channel interference is experienced a bandwidth of 6 kHz may provide better results. Press **[FUNC]** **[3]** to access the I.F. bandwidth menu then use the *SUB DIAL* to make the selection (in this example select 15 kHz). Press **[ENTER]** to accept the selection and return to VFO mode.



If the *MAIN DIAL* is rotated the frequency will increment in 10 kHz steps but the trailing 1.25 kHz will remain in place... 27.60125 MHz, 27.61125 MHz, 27.62125 MHz etc. The trailing digits will not be set to zero enabling tracking of unusual band plans.

**The *MAIN DIAL* follows the adjusted frequency bandplan while the *SUB DIAL* kills the trailing digits and steps rigorously in round numbers.**

## To cancel step-adjust

The easiest way to cancel step-adjust is to return to AUTOMODE, press and hold the **[MODE]** key for more than one second. Step-adjust will be cancelled and the frequency will hop to the nearest whole increment as determined by the automode bandplan data.

You may also cancel step-adjust using the STEP MENU. Press **[STEP]** to activate the step menu. If step-adjust is active, the legend "\*" will be displayed on the left of the LCD. Press **[PASS]** to toggle the step-adjust facility On/Off. To accept the change to OFF, press **[ENTER]** to return to VFO mode.

### Another example:

If the frequencies you need to search are allocated as:

145.210 145.224 145.238 145.252 145.266 145.280  
145.294 145.308

Check the stepping size at first:

$$145.224 - 145.210 = 0.014 \text{ STEP SIZE}$$

To enter this step size and data using the **easiest** method!

First key in the start frequency while in VFO mode:

**[1]** **[4]** **[5]** **[.]** **[2]** **[1]** **[ENTER]**

Select the step menu by pressing **[STEP]**

Key in the required step size: **[1]** **[4]** **[ENTER]**

Select **step-adjust** by pressing the **[PASS]** key, the legend "\*" appears on the left of the LCD to confirm selection.

Complete the entry by pressing **[ENTER]**

The *MAIN DIAL* will now tune the receiver in 14 kHz steps with the trailing offset maintained. The *SUB DIAL* tunes the receiver in 14 kHz steps but clears the offset to a round number (i.e. zero).

**Note:** You may review the step-adjust value quite simply... While in VFO mode, press **[STEP]** followed by **[UP]** to access the step-adjust sub menu. In the above example the step-adjust value will be 2.0 kHz, refer to the following text for the mathematical explanation... **this is not essential but makes good bedtime reading!!!**

## Application of arithmetic for the step-adjust

*For those who wish further information on the mathematics involved... the AR5000 works this out for you automatically! The following examples should explain how the step-adjust works in theory.*

*If the frequencies you need to search are allocated as:*

145.210 145.224 145.238 145.252 145.266 145.280  
145.294 145.308 (MHz)

*Check the stepping size at first:*

$$145.224 - 145.210 = 0.014 \text{ STEP SIZE (MHz)}$$

*Now you have found that each frequency is allocated with a 0.014 MHz (14kHz) spacing you now have to calculate the value of the internal processing frequency:*

$$145.210 / 0.014 = 10372.14285$$

*This should be rounded as 10372 **INTERNAL PROCESSING VALUE***

*To obtain the internal processing frequency, multiply the STEP SIZE by the INTERNAL PROCESSING VALUE:*

$$0.014 \times 10372 = 145.208 \text{ INTERNAL PROCESSING FREQUENCY (in MHz)}$$

*Now calculate the STEP-ADJUST VALUE by subtracting the INTERNAL PROCESSING FREQUENCY from the DESIRED FREQUENCY:*

$$145.210 - 145.208 = 0.002 \text{ (MHz)} = 2 \text{ kHz STEP-ADJUST VALUE}$$

*It can be concluded that a step-adjust value of 2 kHz is required.*

***In order to step through the above frequency allocation you need to apply a STEP SIZE OF 14 kHz with a 2 kHz STEP-ADJUST.***

*To apply a step size of 14 kHz and step-adjust of 2kHz:*

*Select VFO mode by pressing **[VFO]**, select the desired VFO (displayed in the right hand lower corner of the LCD).*

*Press **[STEP]** to activate the STEP select menu.*

*Press **[PASS]** to select STEP-ADJUST. The legend "\*" will appear on the left of the display to confirm selection of step-adjust.*

*Key in the required step size for tuning (14 kHz in this example) by pressing **[1]** **[4]** **[ENTER]***

*Press the **[UP]** key to select the step-adjust entry menu. The "**STEP-ADJ**" legend will flash in the middle of the*

LCD inviting you to enter the value for step-adjust (2 kHz in the example). Press **2** **ENTER**

Press **ENTER** once more to return to VFO mode. You will note the static legend "STEP-ADJ" to confirm that step-adjust is in operation.

Key in the start frequency (145.210 MHz in this example) by pressing **1** **4** **5** **.** **2** **1** **0** **ENTER**.

Change frequency using the MAIN DIAL, **UP** or **DOWN** keys to confirm correct operation.

## 6-8 FREQUENCY OFFSET

This facility enables receive frequency to be quickly SHIFTED (two key presses) by pre-determined margin, which makes it easy to track duplex-transmissions or check repeater inputs / outputs.

Offset frequencies may be factory pre-programmed into the automode bandplan data for some world market areas. Frequency offset may also be programmed manually.

### Setting up an OFFSET FREQUENCY

Before the FREQUENCY OFFSET facility can be used, it first needs to be configured (unless factory programmed for certain bands).

1. To activate the frequency offset set-up menu press **FUNC** then press and hold the **5** key for more than one second.

Example of display:

```
OFF
+ 45.000000 02
+ 0.600000 01
```

Offset frequency can be selected between the ranges of 0 to 999.999999 MHz and OFF. Available offset frequencies can be allocated into special storage locations numbered from 01 to 47. Number 00 is always treated as OFF and cannot be overwritten.

Locations 20 to 47 are reserved for factory pre-programming. These locations may be recalled and the positive / negative frequency shift altered using the **PASS** key but new numeric frequency offsets may not be stored.

Locations 01 to 19 are available for the operator to store new frequency offsets.

00 OFF

01 ~ 19 Available for storage of new offsets

20 ~ 47 Reserved for factory pre-programming

Having a number of frequency offset set-ups programmed ready for retrieval makes the facility even more useful when changing between frequency bands which have different duplex or repeater frequency offsets.

2. While the "FR-OFS" legend is flashing on the display to indicate that the frequency offset menu has been selected, rotate the SUB DIAL to select a new (blank) location (i.e. 02).

3. Enter the offset frequency via the numeric keypad in MHz (i.e. for 600 kHz press **.** **6** **ENTER**). The LCD will return to VFO, MEMORY, SCAN or SEARCH mode, whichever was previously in use.

4. If editing a previously stored offset frequency it is possible to select whether the offset should be up (+) or down (-) from the displayed frequency. If the frequency entered was new, simply re-enter the setup mode by pressing **FUNC** then holding the **5** key for more than one second. Press **PASS** to toggle the direction of the offset either "+" or "-", confirmation will be displayed on the LCD. To accept any changes press **ENTER**

**Note:** The direction of frequency offset "+" or "-" selected using the **PASS** key has global effect on all OFFSET locations. The default is "+".

### Activating frequency offset

To activate frequency offset press **FUNC** **5**. The legend "FR-OFS" will be displayed on the LCD above the "MHz" legend to confirm operation. The displayed receive frequency will change to reflect the offset value and the receiver will monitor the new displayed frequency.

To deactivate frequency offset key **FUNC** **5** again, the "FR-OFS" legend will be removed from the LCD and the receiver will revert to the original frequency. See above (item 4) for selection of "+" or "-" offset.

**Note:** The use of frequency offset will take the AR5000 out of automode. To reactivate automode press and hold the **MODE** key for more than one second, the legend "AUTO" appears on the LCD to confirm that automode has been reactivated.

### Frequency offset with memory channels

All of the above may appear rather long-winded, however the facility comes into its own when the frequency offset is stored into memory along with other data such as receive frequency, mode etc during normal memory write (see section 7 of this manual), no special sequence is required. When written to memory both the **frequency offset and direction of offset** are stored for quick recall.

## 6-9 Changing receive mode (AUTOMODE)

As mentioned earlier in this manual, the specification for step and mode are allocated by departments of Government following International discussions. Like step size, the receive mode has been pre-programmed at the factory to simplify operation of the receiver while you familiarise yourself with all the facilities.

Should you wish, the defaults may be manually overridden at any time so that an alternative receive mode can be

used on any frequency within the set's range.

In normal operation AUTOMODE should be used. The legend "AUTO" is displayed above the right hand (last) digit of the frequency readout when automode is in operation.



### Activating AUTOMODE

To activate automode, press and hold the **MODE** key for more than one second. The receive mode, I.F. filter bandwidth, step, step-adjust and frequency offset will then be automatically read from the automode bandplan data pre-programmed at the factory for each specific world market area.

Manually changing any of the parameters held by the automode bandplan data will cancel automode operation. To reinstate automode press and hold the **MODE** key for more than one second again.

Selecting automode will cancel any user defined items from the following list and select them automatically from the AR5000 bandplan data:

- ◆ Receive mode
- ◆ Offset frequency
- ◆ IFBW
- ◆ LPF
- ◆ HPF
- ◆ De-emphasis
- ◆ Tuning step
- ◆ Step-adjust
- ◆ AGC

The automode bandplan information can only be programmed at the factory or via a specialised computer program.

### Manually changing receive mode

To change receive mode and override automode, briefly press the **MODE** key. The "MODE" legend will flash on the LCD to confirm that the mode select menu has been activated. The following modes are available from the MODE menu: "AUTO", "FM", "AM", "LSB", "USB" and "CW".



If automode is currently in use, the legend "AUTO" will be displayed on the LCD.

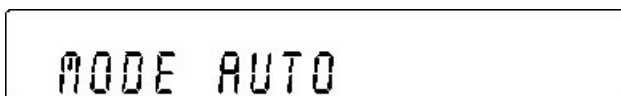

To escape from the menu press **CLR**

The **SUB DIAL** is used to change mode. When you have made your selection, press **ENTER** to accept the new mode. The display will revert to VFO mode and the AR5000 will receive in the selected receive mode. Automode will have been cancelled and the "AUTO" legend will not be displayed on the LCD.

Each of the five VFOs ("V A", "V B", "V C", "V D", "V E") can hold different modes, it is suggested that one be left on AUTOMODE for general tuning and others set to specific modes for specialist listening applications.

**Remember:** To reinstate automode press and hold the **MODE** key for more than one second.

Although any receive mode may be selected at any frequency within the receiver's frequency coverage, generally speaking the following modes will apply:

### AM

**Amplitude Modulation** - Used by broadcast services throughout the world on long wave, medium wave and short wave. AM is also used by VHF civil airband, UHF military airband and some PMR (Private Mobile Radio) and utility services.

### FM

There are two common types of FM (**F**requency **M**odulation), these are:

**NFM - Narrow Band Frequency Modulation** - this provides high quality communication for relatively short distance operation. FM uses a greater frequency bandwidth than other modes such as SSB so is less efficient.

NFM is the most common mode used above 30 MHz with the exception of the airbands. NFM is widely used on the VHF bands: VHF marine band, 2m amateur band (145MHz), 70cm amateur band (433 MHz), PMR (Private Mobile Radio) and utilities.

In the absence of a signal, the background white noise may appear quite loud. For ease of listening, the squelch control should be rotated clockwise until the background noise just disappears, this should be carried out while no signal is present. The point where the background noise is cancelled is known as **threshold point**. Do not advance the squelch control more than necessary or the receiver will appear to be desensitised and weaker signals will be missed.

**WFM** - The AR5000 does not list WFM (**W**ide **B**and **F**requency **M**odulation) as a separate mode, it is simply a product of the I.F. filter bandwidth selection. Select a wide filter such as 100 kHz or 220 kHz and the receiver will use WFM.

Wide Band Frequency Modulation - used by VHF and UHF broadcast stations as excellent audio quality is available due to the relatively wide frequency bandwidth employed. Used only for local services such as VHF Band-II stereo (received as mono on the AR5000) and UHF TV sound channels.

## LSB

**Lower Side Band** - is a form of Single Side Band (SSB). LSB tends *not* to be used commercially but is extensively used by Radio Amateurs on frequencies below 10 MHz. This assists the separation of Commercial and Amateur users on traditionally shared bands and prevents them from speaking to each other.

SSB is a very efficient method of transmission as the unwanted second sideband and carrier have been removed. This allows the full transmitter power to be employed in carrying useful information within the wanted sideband. As a result, greater distances are possible on SSB and a smaller frequency bandwidth is required than most other modes.

The AR5000 uses true carrier re-insertion and a dedicated SSB I.F. filter so that voice becomes intelligible. However due to the complexities of SSB, audio never sounds 100% natural and often listeners comment on it sounding a little like **Donald Duck** or **Micky Mouse** but this is normal and with practice you soon become used to this characteristic. *This is not a criticism of the AR5000 and is applicable to ALL SSB receivers in varying degrees... the AR5000 being very good.*

Small tuning steps of 10 Hz (or 100 Hz at most) should be used for tuning in LSB and other similar modes USB & CW.

The SSB frequency display is not offset (like some other units). However being such a compact wide band receiver, it will not be unusual for the SSB display to be very slightly off frequency when listening to known frequencies such as VOLMET (airband weather forecast service).

## USB

**Upper Side Band** - The same comments apply as for LSB. By convention, Radio Amateurs also use USB above 10MHz.

All long range shipping and oceanic air traffic (as well as long range military aircraft) use USB. DATA modes such as RTTY, SITOR, PACKET, FAX etc may be resolved using USB.

## CW

**Continuous Wave** - Often referred to as Carrier Wave or Morse code (**dots and dashes**). Commonly used on the short wave bands by radio amateurs toward the lower end of each band allocation. Some commercial use is still made by shipping etc although its use is being phased out due to the introduction of automated stations. The AR5000 has the provision for the operator to select the frequency offset used by the receiver in CW mode using the AF.SET menu.

### Note about AGC (Automatic Gain Control)

If the AGC is not set appropriately, audio will sound distorted. The key sequence **[FUNC]** **[STEP]** activates the AGC menu.

In FM mode the options are AGC ON / OFF and in other modes are OFF, FAST, MIDDLE and SLOW. When AGC OFF has been selected, two horizontal bars “=” are displayed on the LCD between the kHz and MHz legends.

FM:                   AGC OFF  
                          AGC ON

Other modes:       AGC OFF  
                          AGC FAST  
                          AGC MIDDLE  
                          AGC SLOW

**Note:** “AUT” for AUTO AGC will be displayed toward the top right of the LCD if AUTOMODE is in operation, the appropriate AGC selection will be made automatically by the AR5000.

## 6-10 IF BANDWIDTH

The I.F. bandwidth selects how SELECTIVE the receiver will be when monitoring signals off air. However it is not simply a case of using the narrowest filter at all times, particular modes require differing amounts of bandwidth in order to operate otherwise the receive system simply will not produce intelligible sound!

Correct receive mode and IF bandwidth must always be selected for optimum reception. If the bandwidth selection is too narrow, distortion or signal break-up may occur. If the bandwidth selection is too wide, adjacent interference may be encountered.

For this reason, a selection of I.F. filter bandwidths are fitted as standard. Typical examples of receive mode and IF bandwidth are:

**FM 220kHz** VHF FM broadcast (110k may also be used - mono only)

**FM 110kHz** TV audio (also VHF FM broadcast - in mono only)

**FM 100 or 30kHz** Wireless mic, etc (30kHz for satellite FAX too)

**FM 15kHz** PMR, amateur band etc FM 6 kHz may also be used

**AM 6kHz** VHF / UHF airband, short wave broadcast, medium & long wave, PMR etc

**USB/LSB 3kHz** Short wave amateur band, short wave utility such as oceanic airband etc

**CW 3kHz** (0.5kHz with optional filter fitted). Morse code used by radio amateurs and some marine traffic on short wave

An appropriate IF filter is automatically selected when automode is engaged. However any combination of IF filter and receive mode is possible in the MANUAL MODE. When you have manually selected an IF filter bandwidth, AUTOMODE will be disengaged, but the receive mode, stepping size, etc will be retained until they are changed manually.



## Manually selecting I.F. bandwidth.

The sequence **FUNC** **3** activates the I.F. bandwidth menu.



In normal operation the word "AUT" will be displayed in the upper right of the LCD to signify that automode is in operation and the I.F. bandwidth, receive mode and channel step will be automatically selected by the AR5000 from its detailed pre-programmed bandplan data.

Selecting a new bandwidth from the list of 220, 110, 30, 15, 6 and 3 kHz is accomplished using the **SUB DIAL**, 0.5 kHz is only available if the optional CW filter has been fitted. To accept the new bandwidth selection press **ENTER**.

Once automode has been cancelled, it may be reinstated from the **MODE** select menu or by pressing and holding the **MODE** key for more than one second.

I.F. filter bandwidth table:

Filter kHz	Total nose (b'width kHz / dB)		Total skirt	
0.5 (500Hz) opt	0.5	-3	2.0	-60
2.5 opt	2.5	-3	5.2	-60
3	2.4	-6	4.5	-60
5.5 opt	5.5	-3	11.0	-60
6	9.0	-6	20	-50
15	15	-6	30	-50
30	30	-6	70	-50
110	140	-3	350	-20
220	260	-3	520	-20

## 6-11 AF SET - (Audio characteristics)

It is possible to optimise the audio settings of the AR5000, there are a total of 5 different settings relating to the audio characteristics:

- 1) Low pass filter     *R-LPF 3.0 kHz*
- 2) High pass filter    *R-HPF 0.3 kHz*
- 3) De-emphasis        *DE.EMP 750*
- 4) CW pitch            *CW.PITCH 0.7 kHz*
- 5) Input switching     *AUDIO INT*

## 1 Audio Low Pass Filter

The audio low pass filter is useful to cut off high tones (allowing low tones to pass) to improve intelligibility of weak signals in close proximity to adjacent interference and to remove *hiss* making listening for extended periods easier on the ears.

There are four available cut off frequencies: 3.0 kHz, 4.0kHz, 6.0kHz & 12.0 kHz. The lower the frequency the more limited the audio bandwidth... for highest fidelity for Band-II listening select 12.0 kHz. If the filter selection has been left to automode, the legend "AUT" will be displayed.

The audio low pass filter will initially be automatically selected according to the IF bandwidth:

Bandwidth	Audio Low Pass Filter
0.5 kHz to 15 kHz	3.0 kHz
Above 30 kHz	12.0 kHz

The audio low pass filter selection is accessed via a sub menu.

```
R-LPF 3.0 kHz <<<
R-HPF 0.05 kHz
DE.EMP 750
CW.PITCH 0.7 kHz
AUDIO INT
```

1. Press **FUNC** **MODE**. The LCD will show, for example, "R-LPF 3.0 kHz".
2. Rotate the **SUB DIAL** to make selection: 3.0 kHz, 4.0kHz, 6.0kHz or 12.0kHz.
3. Press **ENTER** to accept the changes, **CLR** to abort or **UP** to move on to the audio high pass filter selection.

## 2 Audio High Pass Filter

The audio high pass filter is useful for limiting the audio bass response (allowing higher tones to pass) improving intelligibility in certain circumstances (such as low frequency whistles on AM, SSB & CW).

There are four available high pass frequencies: 0.05 kHz (50 Hz), 0.02 kHz (200 Hz), 0.3kHz (300 Hz) & 0.4 kHz (400 Hz). The higher the frequency the more limited the audio bandwidth... for highest fidelity for Band-II VFO listening select 0.05 kHz. If the filter selection has been set to automode, the legend "AUT" will be displayed.

The audio high pass filter will initially be automatically selected according to the IF bandwidth:

Bandwidth	Audio High Pass Filter
0.5 kHz to 15 kHz	0.3 kHz (300 Hz)
Above 30 kHz	0.05 kHz (50 Hz)

The audio high pass filter selection is accessed via a sub menu.

```
R-LPF 3.0 kHz
R-HPF 0.05 kHz <<<
DE.EMP 750
CW.PITCH 0.7 kHz
AUDIO INT
```

1. Press **FUNC** **MODE**. The LCD will first display the low pass filter selection, press the **UP** key to access the high pass filter sub menu.
2. Rotate the **SUB DIAL** to make selection: 0.05 kHz, 0.2 kHz, 0.3 kHz or 0.4 kHz.
3. Press **ENTER** to accept the changes, **CLR** to abort or **UP** to move on to the audio de-emphasis selection.

### 3 Audio De-emphasis

This is really only applicable to FM mode and affects the **sharpness** of recovered audio. Band-II transmissions in different world areas have different defaults for de-emphasis, if for instance a value of 750 is selected in Europe the recovered audio will sound very **muffled**.

The available range is as follows:

THRU, 25uS, 50uS, 75uS & 750uS

The audio de-emphasis will initially be automatically selected according to the IF bandwidth:

Bandwidth	Receive Mode	De-emphasis
0.5k to 15 kHz	FM	750uS
Above 30 kHz	FM	75uS
	AM,LSB,USB,CW	THRU

The audio de-emphasis selection is accessed from a sub menu.

```
R-LPF 3.0 kHz
R-HPF 0.05 kHz
DE.EMP 750 <<<
CW.PITCH 0.7 kHz
AUDIO INT
```

1. Press **FUNC** **MODE**. The LCD will first display the low pass filter selection, press the **UP** key to access the high pass filter sub menu then press **UP** again to access the de-emphasis menu.
2. Rotate the **SUB DIAL** to make selection: THRU, 25uS, 50uS, 75uS & 750uS.
3. Press **ENTER** to accept the changes, **CLR** to abort or **UP** to move on to the audio CW pitch selection.

### 4 CW Pitch

Comfortable listening to CW (Continuous Wave, often referred to as Morse code) is usually centred around a **tone** of 700 to 800 Hz. The audio stage of the AR5000 is configured to emphasise this **window**, however the centre frequency may be changed to suit personal preferences or specific requirements. This function is valid only when CW mode is used for reception.

The selectable range (pitch) is as follows:

0.4 kHz (400 Hz), 0.5 kHz (500 Hz), 0.6 kHz (600 Hz), 0.7 kHz (700 Hz) default, 0.8 kHz (800 Hz), 0.9 kHz (900 Hz), 1.0 kHz (1000 Hz) & 1.1 kHz (1100 Hz).

1. Press **FUNC** **MODE**. The LCD will first display the low pass filter selection, press the **UP** key to access the high pass filter sub menu, press **UP** again to access the de-emphasis menu then press **UP** again to access the CW PITCH sub menu. (Alternatively press **FUNC** **MODE** **DOWN** **DOWN**).

```
R-LPF 3.0 kHz
R-HPF 0.05 kHz
DE.EMP 750
CW.PITCH 0.7 kHz <<<
AUDIO INT
```

2. Rotate the **SUB DIAL** to make selection:

0.4 kHz, 0.5 kHz, 0.6 kHz, 0.7 kHz, 0.8 kHz, 0.9 kHz, 1.0 kHz or 1.1 kHz.

3. Press **ENTER** to accept the changes, **CLR** to abort or **UP** to move on to the audio internal / external selection.

### 5 Input Switching

The audio path is switchable either directly to the audio amplifier or via the front panel accessory socket (**ACC 1**) where it may be looped back into the receiver for passage to the audio amplifier after some form of external processing has taken place (tone unit, DSP filter etc). The default is INT for INTERNAL.

To access the audio switching menu:

```
R-LPF 3.0 kHz
R-HPF 0.05 kHz
DE.EMP 750
CW.PITCH 0.7 kHz
AUDIO INT <<<
```

1. Press **FUNC** **MODE**. The LCD will first display the low pass filter selection, press the **UP** key to access the high pass filter sub menu, press **UP** again to access the de-emphasis menu, press **UP** again to access the CW PITCH sub menu then **UP** again to access the audio switching menu. (Or use the **DOWN** key once !)
2. Rotate the **SUB DIAL** to make selection: INT or EXT

3. Press **ENTER** to accept the changes, **CLR** to abort or **UP** to move on to the audio internal / external selection.

## 6-12 Audio tone eliminator (T-ELMT)

Various utility radio users are permitted to transmit their signals with an accompanying continuous tone (pilot tone) which is over ridden by the operator's audio (voice). This type of tone is transmitted continuously in order to provide advanced security for radio communication system and to ensure that important radio links are in working order.

The AR5000 tone eliminator is used to eliminate many of these tones to enable the squelch to close when in scan & search modes preventing the AR5000 locking up on unwanted busy channels.

### VFO, memory, scan & search

The tone eliminator may be programmed independently into each VFO, memory channel and search bank for greatest flexibility, this prevents the scan and search process from halting on unwanted signals... when the tone eliminator is registered with a memory channel or search bank, the scan & search process will ignore (skip) busy frequencies which carry the specified tone frequency.

### Selecting the required tone eliminator frequency

1 The tone eliminator is selected from the OPTION menu. Press **FUNC** **0** to access the menu then use the **UP** and **DOWN** keys until the display shows "T-E L E M O F F" (one press on the **DOWN** key, the sequence will change if the DESCRAMBLER or CTCSS options have been installed).

```
DE-SCR OFF (if DS8000 option is fitted)
CTCSS OFF (if CT5000 option is fitted)
DTMF OFF
T-ELMT OFF <<<
```

2 Rotate the **MAIN DIAL** or **SUB DIAL** while listening to the received audio (which contains the unwanted tone) until the "BUSY" legend has disappeared, this indicates that the tone has been eliminated and will be ignored by the receiver. It is sometimes best to rotate the DIAL so that the "BUSY" legend flutters half way between the signal disappearing and reappearing. The **PASS** key is used as a short cut to OFF. The acceptable range is 1 ~ 255 and OFF.

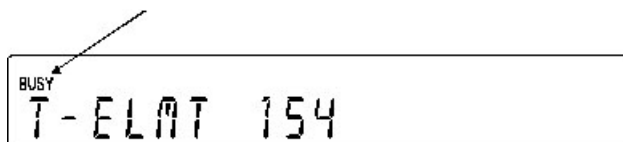

Signal processing is carried out by an analogue system so some variation should be allowed from set to set. The following tones may be eliminated (approximate range is 0.4 kHz (400 Hz) to 4.4 kHz):

Unwanted tone	Suggested setting
0.4 (kHz)	0 ~ 31
0.5	50 ~ 81
0.6	88 ~ 113
0.8	136 ~ 155
1.0	165 ~ 179
1.2	184 ~ 196
1.4	198 ~ 208
1.6	208 ~ 217
1.8	216 ~ 223
2.0	223 ~ 228
2.2	228 ~ 233
2.4	232 ~ 236
2.6	235 ~ 239
2.8	142 ~ 245
3.0	244 ~ 247
3.2	247 ~ 249
3.4	249 ~ 251
3.6	247 ~ 250
3.8	249 ~ 251
4.0	251 ~ 252
4.2	252 ~ 253
4.4	253 ~ 254

3 To complete the sequence and accept the input press **ENTER**

**Note:** There is no on-screen indicator to show that the tone eliminator has been programmed (when outside of the tone eliminator selection menu).

The tone eliminator only effects the way in which the squelch interprets activity, **tones are NOT removed from the received audio presented to the operator...** i.e. you will still here the tone but the "BUSY" indicator can be programmed to extinguish as if the squelch has closed.

**Tone alone** = treated as channel unoccupied

**Tone & voice** = channel busy

## 6-13 DTMF decoder

DTMF (Dual Tone Multi Frequency) tones are used by many VHF/UHF communications services and amateur radio operators to control switching devices and to enable selective calling. The AR5000 has the capability to decode all 16 DTMF tones.

All 16 characters can be displayed including "1" to "0", "A B C D", "#" and "\*". The decoded DTMF characters will automatically be displayed when the facility has been enabled and will be removed from the display after approximately 60 seconds (providing a transmission is encountered using DTMF!). (**Note:** Telephone services do not normally use ABCD).

Frequency	1209	1336	1447	1633
697	1	2	3	A
770	4	5	6	B
852	7	8	9	C
941	*	0	# (=)	D

**Note:** The # symbol is displayed as "=" on the AR5000 LCD. If the DTMF tone consists of more than 10 characters, the LCD will scroll up the entire DTMF tone set, overflowed characters will vanish and are not retrievable unless an external display is used via the remote RS232C port.

### Selecting DTMF display

The operation of DTMF is **global** and affects VFO, memory, scan & search operations and may be selected ON or OFF.

1 DTMF ON/OFF is set & reviewed from the OPTION menu. Press **FUNC** **0** to access the menu then use the **UP** and **DOWN** keys until the display shows "DTMF OFF". The sequence will change if the DESCRAMBLER (DS8000) or CTCSS (CT5000) options have been installed.

```
DE-SCR OFF (if DS8000 option is fitted)
CTCSS OFF (if CT5000 option is fitted)
DTMF OFF <<<
T-ELMT OFF
```

2 Rotate the **SUB DIAL** to toggle the setting between ON and OFF, the **PASS** key can also be used to select the OFF position.

The image shows a rectangular LCD display with the text "DTMF ON" in a simple, blocky font.

3 To complete the sequence and accept the input press **ENTER**

## 6-14 RF Attenuator & preamplifier

The AR5000 features an RF stepped attenuator and preamplifier. LCD legends "ATT 00 dB" and "AMP" are used to display the settings in use.

**Below 230 MHz** A switchable RF preamplifier is utilised making the available selection of 0dB, -10dB & -20dB with 0dB being the most sensitive selection with the preamplifier on. The following provides a simple picture:

<b>0dB Preamp ON</b>	(most sensitive), "AMP" legend displayed
<b>10dB Preamp OFF</b>	(10dB less sensitive)
<b>20dB Preamp OFF</b>	10dB of attenuation added and preamp off (least sensitive)

**230 to 999.999999 MHz** As the preamplifier is not used above 230 MHz (a higher gain front end being used as standard), the available settings are 0dB and 10dB. The "AMP" legend is always displayed.

**Above 1,000 MHz (1 GHz)** The attenuator is disabled to minimise signal loss through the switching unit... always set to 0dB. The "AMP" legend is always displayed.

The receivers RF front end is automatically preselected up to 999.999999 MHz so that performance is peaked for maximum sensitivity and minimal interference. However, should interference be encountered from very strong local transmissions, increase the level of attenuation to minimise the effects of unwanted signals. Some level of experimentation will be required to find the best combination depending upon particular circumstances. The RF GAIN adjustment may also be useful in reducing interference especially in USB, LSB and CW modes.

The selection of RF attenuator and preamplifier is made from the ATTENUATOR menu. To activate the attenuator menu press **ATT**. The **SUB DIAL** is used to change value and the sequence is completed using the **ENTER** key.

The attenuator value is stored into each memory channel if this sequence has taken place in MEMORY RECALL mode or SCAN mode (while scanning has stopped). The attenuator status can also be stored into each search bank and VFO.

## 6-15 CONFIG menu outline of facilities

The CONFIG menu is used to make many changes to operations of the receiver, the less frequently accessed items are held here to minimise the number of second function keys thereby simplifying operation. Those facilities required most frequently are placed first and second on the list (lamp and beep).

The **UP** **DOWN** keys may be used to scroll through the CONFIG menu and the **SUB DIAL** is used to make selection (along with the **MAIN DIAL** and **PASS** key in some circumstances).

The CONFIG menu provides access to: lamp, keypad beep tone, external IF output, remote RS232 baud rate, aerial automatic switching and internal / external frequency reference.

## 6-16 CONFIG - LAMP

To switch the LCD backlight ON and OFF, the CONFIG menu is used. To access the CONFIG menu press

**FUNC** **kHz**. The first item on the CONFIG menu is "LAMP ON".

```
LAMP ON <<<
BEEP 4
EXT-IF OFF
BPS 9600
ANT 1
STD.INT 12.8 MHz
```

Rotate the *SUB DIAL* to switch the LCD & S-meter back-light ON/OFF, the status is obvious but still displayed on the LCD as "LAMP ON" and "LAMP OFF".

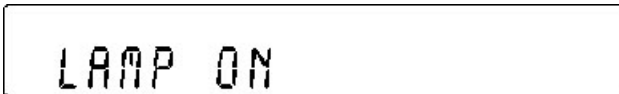

To accept the selection press **ENTER** to return to VFO, memory recall, scan or search, whatever was previously in use.

To abort entry press **CLR**

## 6-17 CONFIG menu - BEEP

To alter the volume of the keypad BEEP and to switch it OFF totally, the CONFIG menu is used. To access the CONFIG menu press **FUNC** **kHz**. Use the **UP** **DOWN** keys to scroll through the menu until the BEEP menu is displayed "BEEP 4" (where "4" is the current setting).

```
LAMP ON
BEEP 4 <<<
EXT-IF OFF
BPS 9600
ANT 1
STD.INT 12.8 MHz
```

The *SUB DIAL* is used to make selection from 1 (quietest) to 255 (loudest) and OFF. The **PASS** key may be used as a short cut toggling between 100 and OFF.

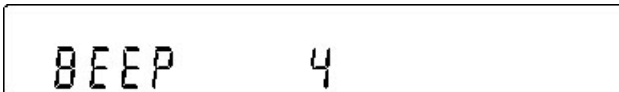

To accept the selection press **ENTER** to return to VFO, memory recall, scan or search, whatever was previously in use.

To abort entry press **CLR**

## 6-18 CONFIG - EXTERNAL I.F. output (SDU5000)

The AR5000 is capable of providing a 10.7 MHz I.F. output suitably wide enough to drive the optional SDU5000 spectrum display unit with a bandwidth of up to  $\pm 5$  MHz. The I.F. output is default to OFF so must be activated before the SDU5000 (or any other similar peripheral) may be used.

To enable the I.F. output, the CONFIG menu is used. To access the CONFIG menu press **FUNC** **kHz**. Use the **UP** **DOWN** keys to scroll through the menu until the "EXT-IF OFF" menu is displayed (where "OFF" is the current setting).

```
LAMP ON
BEEP 4
EXT-IF OFF <<<
BPS 9600
ANT 1
STD.INT 12.8 MHz
```

The *SUB DIAL* is used to select the required parameter from those available:

1 I.F. taken from **before** the selective filtering (least selective) and suitable for use with the optional SDU5000 spectrum display unit. Should this selection not be made, the SDU5000 will not display a spectrum trace.

2 I.F. taken from **after** the selective filtering (most selective) and is **not** suitable for use with the optional SDU5000.

OFF I.F. output deactivated (default)



To accept the selection press **ENTER** to return to VFO, memory recall, scan or search, whatever was previously in use.

To abort entry press **CLR**

## 6-19 CONFIG - Computer control BPS

The AR5000 has a standard RS232 REMOTE port for connection to a computer (such as a PC) and other equipment such as the SDU5000 spectrum display unit to enable remote control operation of the receiver.

The **speed** as which the AR5000 communicates with an external device may be controlled using the CONFIG menu. If the speed does not match EXACTLY that of an external device, communication will not be established.

To select the remote control speed (BPS Bits Per Second), the CONFIG menu is used. To access the CONFIG menu press **FUNC** **kHz**.

Use the **UP** **DOWN** keys to scroll through the menu until the **REMOTE BPS** menu is displayed.

```
LAMP ON
BEEP 4
EXT-IF OFF
BPS 9600 <<<
ANT 1
STD.INT 12.8 MHz
```

The **SUB DIAL** is used to make selection between: 4800, 9600 & 19200 BPS with 9600 being the default.



To accept the selection press **ENTER** to return to VFO, memory recall, scan or search, whatever was previously in use.

To abort entry press **CLR**

## 6-20 CONFIG - Advanced aerial switching

The aerial input selection is made via a menu activated by the key sequence **FUNC** **ATT**. Be careful when selecting this menu, if you hold the **ATT** key for more than one second the AUTO/MANUAL RF preselection menu will be activated instead, in which case press **CLR**.

The **SUB DIAL** is used to select input via either of the two rear panel aerial sockets (**ANT 1** for the N-type input and **ANT 2** for the SO239). Additional aerials (**ANT 3** & **ANT 4**) may also be controlled providing the optional AS5000 switching unit is in use. AUTO may be selected where the aerial will be automatically switched based upon the programming of frequency / aerial data.

### Auto aerial switching outline

It is possible to program the AR5000 to automatically switch the aerial input used (aerials 1 & 2 at default or aerial 1, 2, 3 & 4 with the optional AS5000 aerial switching unit) depending upon receive frequency. This allows the operator to optimise the listening setup by programming the AR5000 to automatically select the most appropriate aerial out of a choice of several which may be available. The CONFIG menu is used to enter programming with the **MAIN DIAL**, **SUB DIAL** and **PASS** key being used during data input.

Automatic aerial switching (depending upon whether manual or automatic aerial switching have been selected) may be used in VFO, memory recall & scan modes, program search may also be configured to use automatic aerial switching.

First determine the required aerial switching bandplan, automatic aerial selection may be specified down to hundreds of kHz (i.e. 145.100 MHz, 7.1 MHz etc). If the required switching is simply **ANT 2** for 10 kHz ~ 30 MHz (the SO239 socket for HF) the process is very easy, if more complex then it is suggested that a table be written

onto paper (see later in this section 6-20) to form a clear picture of what is required. Each aerial may be programmed for 10 separate frequency ranges (each being referred to as a channel, **ANT 1** channel 0 ~ 9, **ANT 2** channel 0 ~ 9 etc).

**Note:** If you overlap frequency ranges for different aerials, the lowest aerial number will take precedence. If no specific frequency programming has been made, **ANT 1** will be chosen as default.

### Basic programming (setting defaults)

1 First ensure that AUTO aerial switching has been selected. To review and change the selection press **FUNC** **ATT** to access the aerial selection menu. Press the **PASS** key to select "AUTO" (or use the **SUB DIAL**). To accept the selection press **ENTER**.

```
ANT AUTO <<<
ANT 1
ANT 2
ANT 3
ANT 4
```

2 Ensure that no programming exists so that you (and the AR5000 !) don't get confused. Press **FUNC** **kHz** to access the CONFIG menu. Use the **UP** **DOWN** keys to locate the aerial selection menu, the legend "**ANT**" flashes on the left of the LCD (two presses of **DOWN** or four presses of **UP**).

```
LAMP ON
BEEP 4
EXT-IF OFF
BPS 9600
ANT 1 <<<
STD.INT 12.8 MHz
```

3 Use the **MAIN DIAL** to select each aerial in turn "**ANT 1**", "**ANT 2**", "**ANT 3**" and "**ANT 4**".



For each aerial press **PASS** to delete the current programming until the legend "-----" is displayed to signify that the data relating to each aerial has been deleted.

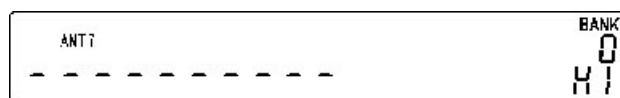

**Note:** When no programmed data exists, aerial 1 "**ANT 1**" is selected for all frequencies (10 kHz ~ 2600 MHz). If the optional aerial switching unit AS5000 is not in use, selection of aerial 3 & 4 ("**ANT 3**" & "**ANT 4**") will simply result in aerial 1 being used.

### Entering simple aerial switching data

In this example aerial 2 (“ANT 2”) will be programmed for the frequency range of 10 kHz ~ 30 MHz so that aerial 1 (“ANT 1”) will operate by default on frequencies between 30 MHz and 2600 MHz.

1 Press **FUNC** **kHz** to access the CONFIG menu. Use the **UP** **DOWN** keys to locate the aerial selection menu, the legend “ANT” flashes on the left of the LCD (two presses of **DOWN** or four presses of **UP**).

2 Use the **MAIN DIAL** to select aerial 2 “ANT 2”. The display will show that no data is currently present “-----”.

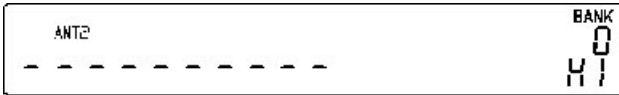

Key in the lowest frequency limit (in this example this is 10 kHz) **1** **0** **kHz** then key in the upper frequency limit (in this example 30 MHz) **3** **0** **ENTER**

3 To accept the data input press **ENTER**. The display will return to VFO (or memory, scan or search mode, whichever was previously in use).

If the set is not already in VFO mode press **VFO**. Try keying in a few test frequencies... i.e. 5.505 MHz **5** **.** **5** **0** **5** **ENTER** (or **5** **5** **0** **5** **kHz**). The display should confirm selection of aerial 2 “ANT 2”, if it does not, ensure that AUTO aerial switching has been selected. To review and change the selection press **FUNC** **ATT** to access the aerial selection menu. Press the **PASS** key to select “AUTO” (or use the **SUB DIAL**). To accept the selection press **ENTER**.

Key in another test frequency, this time 145.5 MHz **1** **4** **5** **.** **5** **ENTER**. The display should confirm selection of aerial 1 “ANT 1”.

**Note:** Automatic aerial selection works independently of AUTOMODE selection.

### Entering complex aerial switching data

It is suggested that complex aerial switching arrangements be written down first so that a clear picture of the required programming can be established, for example:

Aerial selection	1	2	3	4
Channel				
0 lower freq limit	190MHz	10kHz	50MHz	75.5MHz
0 upper freq limit	2600MHz	30MHz	90MHz	120MHz
1 lower freq limit		140MHz		
1 upper freq limit		150MHz		
2 lower freq limit		170MHz		
2 upper freq limit		200MHz		
3 lower freq limit				
3 upper freq limit				
and so on....				
9 lower freq limit				
9 upper freq limit				

In this example all four aerials have been used as if the optional AS5000 were in use, complex programming is still possible using the standard two aerial inputs “ANT 1” and “ANT 2”. Two anomalies have been used in the above table to further promote the flexibility of programming... can you spot them?... read on...

**Note:** If the AS5000 optional switching unit is not in use, programming of ANT 3 & ANT 4 will result in ANT 1 being used in their place. In no specific programming is made or *gaps exist*, ANT 1 will be defaulted from 10 kHz to 2600 MHz.

1 Press **FUNC** **kHz** to access the CONFIG menu. Use the **UP** **DOWN** keys to locate the aerial selection menu, the legend “ANT” flashes on the left of the LCD (two presses of **DOWN** or four presses of **UP**).

2 Use the **MAIN DIAL** to select aerial 1 “ANT 1”. Delete any data already programmed using the **PASS** key until the legend “-----” is displayed.

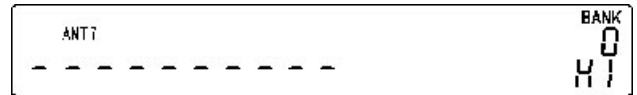

Starting at **AERIAL 1 channel 0** (refer to the chart) key in the lowest frequency limit **1** **9** **0** **ENTER** then key in the upper frequency limit **2** **6** **0** **0** **ENTER**

3 Rotate the **MAIN DIAL** to select “ANT 2”. Delete any data already programmed using the **PASS** key until the legend “-----” is displayed.

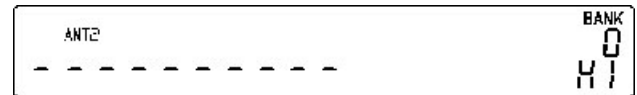

Starting at **AERIAL 2 channel 0** (refer to the chart) key in the lowest frequency limit **1** **0** **kHz** then key in the upper frequency limit **3** **0** **ENTER**

4 Rotate the **SUB DIAL** to select **AERIAL 2 channel 1**. Key in the lowest frequency limit **1** **4** **0** **ENTER** then key in the upper frequency limit **1** **5** **0** **ENTER**

5 Rotate the **SUB DIAL** to select **AERIAL 2 channel 2**. Key in the lowest frequency limit **1** **7** **0** **ENTER** then key in the upper frequency limit **2** **0** **0** **ENTER**

6 Rotate the **MAIN DIAL** to select “ANT 3”. Delete any data already programmed using the **PASS** key until the legend “-----” is displayed.



Starting at **AERIAL 3 channel 0** key in the lowest frequency limit **5** **0** **ENTER** then key in the upper frequency limit **9** **0** **ENTER**

7 Rotate the *MAIN DIAL* to select “ANT 4”. Delete any data already programmed using the **PASS** key until the legend “-----” is displayed.

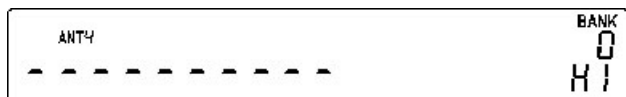

Starting at **AERIAL 4 channel 0** key in the lowest frequency limit **7 5 . 5** **ENTER** then key in the upper frequency limit **1 2 0** **ENTER**

8 To accept the data input press **ENTER**. The display will return to VFO (or memory, scan or search mode, whichever was previously in use).

If the set is not already in VFO mode press **VFO**. Try keying in a few test frequencies to confirm correct aerial selection depending upon frequency, if automatic switching does not take place, ensure that AUTO aerial switching has been selected. To review and change the selection press **FUNC** **ATT** to access the aerial selection menu. Press the **PASS** key to select “R U T O” (or use the *SUB DIAL*). To accept the selection press **ENTER**

### Exceptions & anomalies

As mentioned earlier in this section 6-20 there are a couple of exceptions...

1 AERIAL 1 “ANT 1” need only be programmed *if* you wish to **chop holes** in the programming of other aerial selections... for example the programming of **AERIAL 1 channel 0** OVERRIDES the programming of **AERIAL 2 channel 2** (as the lowest aerial number takes precedence) causing frequencies above 190 MHz to use aerial 1. As aerial 1 “ANT 1” is the default for all frequencies not specified, there is no reason to program it as standard. **Creative thinking** makes programming of aerial 1 useful for short cut overriding of detailed automatic aerial switching. For example select 10 kHz ~ 2600 MHz for aerial 1 and the automatic program will be defeated!!!

2 In a similar way to the above exception, the programming of **AERIAL 3** in the above example overrides the programming of **AERIAL 4** causing **AERIAL 4** to be used for frequencies between 90 and 120 MHz only.

### Auto aerial switching with program search mode

To enable the *fastest* rates of search while in program search mode, automatic aerial switching is not selected as default when programming the search parameters. However you may still manually change the aerial selection when in program search mode. Simply initiate whatever search bank is required (refer to sections 12-4 & 12-5 of this manual covering program search mode) then override the current aerial selection by pressing **FUNC** **ATT** **PASS** **ENTER** to select automatic aerial switching... of course **ANT 1**, **ANT 2**, **ANT 3** or **ANT 4** may be selected using this menu (don't use **PASS**, use the *SUB DIAL* instead).

## 6-21 CONFIG - Frequency standard

The AR5000 is fitted with a 12.8 MHz internal TCXO (Temperature Compensated Crystal Oscillator) as standard to ensure the ultimate in frequency precision. However where a *piped 10 MHz external frequency standard* exists (which is usually referenced to an atomic signal) such as high quality workshops or professional monitoring centres, a high quality external 10 MHz reference may be coupled to the STD IN BNC socket on the rear of the AR5000. Before an external reference can be used, the *STD.INT/EXT* menu must be configured using the CONFIG menu, **it is default to Internal**.

To enable the EXTERNAL 10 MHz input, access the CONFIG menu by pressing **FUNC** **kHz**. Use the **UP** **DOWN** keys to scroll through the menu until the “STD.INT” menu is displayed. (*The easiest way is to use the DOWN key once*).

```
LAMP ON
BEEP 4
EXT-IF OFF
BPS 9600
ANT 1
STD.INT 12.8 MHz <<<
```

The *SUB DIAL* is used to make selection between “STD.EXT 10.0 MHz” (external) and “STD.INT 12.8 MHz” (internal).



To accept the selection press **ENTER** to return to VFO, memory recall, scan or search, whatever was previously in use.

To abort entry press **CLR**

**Note:** If “EXT” (external) is selected without a valid 10 MHz reference present, the AR5000 will not receive, there will be no audio output (not even white noise) and eventually the “PLL - ERR” (PLL error) message will be displayed.



## (7) Memory banks & channels

It is very convenient to store commonly used frequencies into a memory bank along with mode and attenuator status, this saves having to key the data in over and over again. Memory recall is very straightforward and quick when compared to retyping all data.

Think of memory channels as pages in a notebook each of which is numbered to identify it. Data may be written to each new page (memory channel) and each page may be overwritten with new data, they can be used over and over again.

Each memory channel may hold:

- ♦ 1 One receive frequency
- ♦ 2 Receive mode
- ♦ 3 IFBW
- ♦ 4 LPF
- ♦ 5 HPF
- ♦ 6 De-emphasis
- ♦ 7 Tuning step
- ♦ 8 Step-adjust
- ♦ 9 Frequency offset
- ♦ 10 AGC
- ♦ 11 Attenuator
- ♦ 12 CTCSS tone
- ♦ 13 Aerial selection
- ♦ 14 Eight character TEXT comment
- ♦ 15 Pass (lockout) & select scan list status

The TEXT comment assists ease of identification at a latter date and the other parameters provide great convenience and minimise the need for extensive reprogramming.

A total of 1000 memory channels are provided which are divided into 10 banks, each having 100 channels. The memory banks are identified by the first BANK number 0, 1, 2, 3, 4, 5, 6, 7, 8 & 9 and the individual channels are numbered from 00 to 99.

Examples are "000" for the first channel location in memory bank "0" and "099" for the last memory channel in memory bank "0".

"415" is the location: memory bank "4" channel "15".

Memory bank "0" may be used as any other bank but also has a special facility of auto-store where active frequencies found in search mode may be automatically entered into the 100 memory channels 000 to 099 for later review, recall and scanning. Please refer to section 12-19 of this manual for further information regarding AUTO-STORE.

The data contents of memory and search banks are held in an EEPROM so that no backup battery or capacitor is required for memory retention.

The stored data may be quickly and easily recalled, changed or deleted using the memory recall and delete facilities.

**Note:** When the receiver is switched OFF using the front panel **POWER** key, all VFO data will be automatically stored into EEPROM memory storage. However, should the power be removed while the receiver is switched on (power cut or flat vehicle battery etc), the last stored memory channel or last VFO data **may** be lost.

During the manufacture and testing of the receiver, various test frequencies are entered into the receiver's memory banks so the memory locations are unlikely to be completely blank.

**Note:** Where memory banks etc are empty during memory storage, the indication "- - - - -" is displayed. If an attempt is made to recall an empty memory channel, an error bleep is sounded and the receiver increments to the first memory channel containing data either above or below the keyed memory location depending upon the current direction determined by the **UP** and **DOWN** keys.

### 7-1 Storing receive data into memory - memory input in VFO mode

Let's assume that you wish to store the frequency of 88.3 MHz with AUTOMODE set into memory bank "1" location "00" (100) while in VFO mode (in this example VFO-A is used).

Start by selecting VFO mode (by pressing the **VFO** key until "V R" is displayed in the lower right corner of the LCD) then key in the frequency of 88.3 MHz, **mode and step size** are set to the default AUTO.

i.e. **VFO** to place the receiver into VFO mode

**8 8 . 3** **ENTER** to select the desired frequency, the mode and step size will be automatically set by the AR5000 microprocessor.

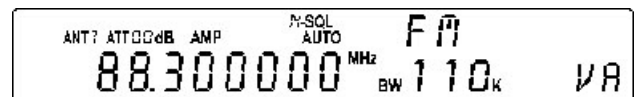

Press and hold the **ENTER** key for more than one second to enter memory input mode.

The keyed frequency starts to FLASH on the LCD. To the right of this frequency the legend "-->" will be displayed pointing at the first available empty memory location.



The memory location is alternatively displayed as a group of three numbers on the right of the LCD under the flashing "BANK" legend... the top number is the BANK and the lower two digits the CHANNEL.



The flashing legend "M" for **memory** also indicates that a memory location is being displayed (rather than a search

bank, select scan channel, pass frequency etc).

The “< - -” legend then reverses to point back to where the frequency was displayed. If the legend “- - - - -” is displayed then the current memory channel is confirmed as currently being empty. If data is already present in the memory location, the previously stored frequency will be displayed as a warning that the stored data is about to be over-written.

The microprocessor will automatically select the youngest free memory location. You may change the memory location at this time by rotating the *MAIN DIAL* (which selects all 1000 memory channels in sequence) or keying in a three digit number comprising of BANK+CHANNEL (x.xx). The *SUB DIAL* selects the next EMPTY memory location.

**Note:** The **UP** **DOWN** keys are used for selecting alpha-numeric text in the context of memory operation and should not be used at this point.

**Remember**, if you take too long entering data (about 90 seconds) the display will revert to its original VFO condition.

Assuming that you wish to store 88.3 MHz in memory channel 100 irrespective of what may already be stored there, press **1** to select the bank 1 then press **0 0** to select the first channel. Finally type **ENTER** to accept the memory location.



The TEXT menu will now be displayed. The flashing legend “TX T” is displayed to the right of centre of the LCD, the memory location is displayed in static form on the right of the LCD. Even if data is being over-written, any previously stored text will be erased and a blank field provided for TEXT addition.



**Note:** If you do not wish to add an alpha-numeric text comment press **ENTER** to complete the process and commit new data to memory. It is possible to add text at a later time.

To aid text entry, a decimal “.” is displayed to the right of the text entry point (initially close to the left of the LCD). The *SUB DIAL* is used to make selection of text in the form of upper case letters, numbers and symbols. The **UP** and **DOWN** keys move the text entry point to the right and left respectively. If a mistake is made during entry, use the **DOWN** key to move back to the required position and simply over-write it.

You will note that each time the entry point is moved and text selected, the next letter offered is not “0” or “R” but continues from the character, number or symbol last used. A few short cuts are provided via the numeric keypad:

- 1 = Display a blank “ ”, cancel whatever letter is currently displayed
- 2 = Start at number “ 1”
- 3 = Start at letter “ R”
- 4 = Start at letter “ M”
- 5 = Start at letter “ Z”
- 6 = Start at number “ 9”
- 0 = Start at symbol “ - -”

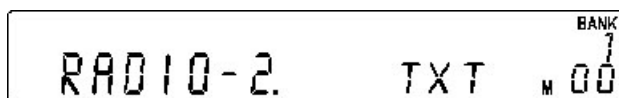

If you are happy with the alphanumeric description press **ENTER**, the display will return to VFO mode.

At any time you may abort memory input by pressing the **CLR** key, the display will return to VFO mode.

To toggle the FREQUENCY / TEXT display while in memory recall, scan and search modes press **FUNC** followed by a brief press of the **ENTER** key.

## 7-2 Memory recall - Recalling receive data from memory

Once receive frequency and mode data have been stored into a memory location, its retrieval is quick and simple.

Let’s assume that you wish to retrieve the frequency of 88.3 MHz which has been programmed into to memory “100” (bank 1 channel 00) during the example in the preceding section 7-1 of this manual.

Press **SCAN** to place the receiver into memory recall mode. The bank legend appears on the top right of the LCD with bank and channel numbers underneath to confirm operation, note that the word “SCAN” is **not** present at this time.

*The AR5000 will monitor whatever memory channel first appears when you enter memory recall mode.*

The AR5000 displays memory location (bank & channel number), mode, I.F. bandwidth, attenuator status, automode status, “N-SQL” noise squelch status, “BUSY” indicator (if the channel is occupied with a busy transmission causing the squelch to open) frequency or text depending upon the setting of **FUNC** **ENTER**. If TEXT mode has been selected but no TEXT stored in memory, the frequency readout will appear blank!



If the desired memory channel is not immediately displayed it may be RECALLED by keying in the required location. To recall memory channel "100" type **1 0 0** there is no need to press **ENTER**.

### Memory channel review / hunt

The *MAIN DIAL* or **UP** **DOWN** keys may be used to review, hunt for and select memory channels which contain data (even those which have been assigned PASS so that they will be skipped during SCAN)... channels which contain no data will be skipped. The *SUB DIAL* changes the BANK NUMBER selecting the first or last channel number in each bank (depending on the direction the control is rotated), again any empty memory channels will be skipped.

**Summary:** From VFO mode press **SCAN** to enter memory recall (the "BANK" legend in the top right of the LCD without the legend "SCAN" confirms operation). Rotate the *MAIN DIAL* or key in the three digit memory location (using the numeric keypad) to select the required memory channel.

This is a useful tool for reviewing memory contents and hunting for a specific channel when you forget what you stored where! Should you know the number of the required memory channel, the keypad method of memory recall will be much faster.

The receiver will monitor whatever memory channel is displayed while in memory recall mode.

### 7-3 Transfer of memory channel to VFO

Should you wish to tune away from the memory channel and benefit from not having to re-enter the frequency, mode, attenuator setting, channel step and step-adjust, the data may be quickly transferred from memory to VFO-E which has been assigned this task.

**Transfer to VFO-E:** To transfer the displayed memory data to VFO-E simply press **ENTER**. The legend "VE" will be displayed on the right of the LCD to confirm operation, all data will be transferred. You may now tune using the *MAIN DIAL*, *SUB DIAL* or **UP** **DOWN** keys.

### 7-4 Changing and deleting memory data

There will come a time when you have entered many frequencies into the memory banks and may wish to change the data contained (change frequencies, comments or modes etc).

#### Memory over-write

The easiest way to change the memory channel contents is simply to key new data over the top as shown in section 7-1 of this manual.

For example, let's assume that you wish to store a new frequency of 92.7 MHz into memory bank "1" location "00" (100) which has been previously used to store 88.3 MHz.

Start by selecting VFO mode then key in the frequency of 92.7 MHz, mode and step size are set to their defaults by AUTOMODE.

**VFO** to place the receiver into VFO mode.

**9 2 . 7** **ENTER** to select the desired frequency.

Press and hold the **ENTER** key for more than one second to enter memory input mode.

Press **1 0 0** **ENTER** **ENTER** to over-write the previous data.



At any time you may abort memory input by pressing the **CLR** key, the display will return to VFO mode.

#### Editing memory data

To edit memory data (frequency, mode, attenuator, text comment etc) it is necessary to transfer the data to VFO-E where it may be edited then saved back to the original or new memory location.

For example: Let's assume that memory channel "123" has the frequency of 119.65 MHz stored, all operational data has been taken care of by automode (mode, step size etc) and the text comment is "TEST 123" but you wish to change the text comment.

From VFO mode press **SCAN** to enter memory recall mode.

Select memory location 123 by typing **1 2 3**

Transfer the data to VFO-E by pressing the **ENTER** key. VFO-E now contains the data from memory location "123".



Press and hold the **ENTER** key for more than one second to enter memory write mode.

The frequency readout will alternate between the displayed frequency you wish to store and a memory location (not memory location "123" but the first available empty memory).

Key in **1 2 3** to select memory location 123 for storage. As the stored frequency and frequency to be stored are the same, the frequency readout will stop flashing. The legend "- - >" and "< - -" confirms that memory location 123 is to be over-written with data.

Press **ENTER** to over-write memory location 123. The "TX T" legend will be displayed inviting you to select new text for storage in location 123.

To aid text entry, a decimal "." is displayed to the right of the text entry point (initially close to the left of the LCD). The *SUB DIAL* is used to make selection of text in the form of upper case letters, numbers and symbols. The **UP** and **DOWN** keys move the text entry point to the right and left respectively. If a mistake is made during entry, use the **DOWN** key to move back to the required position and simply over-write it.

Select new text to be saved... such as "X Y Z" Remember, a few short cuts are provided by the numeric keypad. When you are happy with the alphanumeric description press **ENTER** to complete the data storage. The display will return to VFO mode.

At any time you may abort the memory input by pressing the **CLR** key, the display will return to VFO mode.

To toggle the FREQUENCY / TEXT display while in memory recall, scan and search modes press **FUNC** followed by a brief press of the **ENTER** key.

**Note: This method may be used to change any memory content (frequency, mode etc) although in reality you may find it just as easy to enter the required frequency etc afresh in VFO mode and write to the required memory location.**

## 7-5 Deleting memory channels and banks

It is possible to delete memory channels on an individual basis or delete a whole memory bank in one go. In fact, the delete key has many operations depending upon what operating mode (VFO, SCAN or SEARCH) the receiver was in prior to the selection of delete using the key sequence **FUNC** **•**

The deletion of memory data presumes that you have previously programmed memory channels which you now wish to delete! **Once you have deleted memory data it cannot be restored so follow the key sequence carefully.**

### Deleting individual memory channels

First place the AR5000 into memory recall mode. Switch on the receiver and press the **SCAN** key once (unless it is in SCAN mode in which case you should press **VFO** followed by **SCAN** ).

Select the memory location which you wish to delete by rotating the *MAIN DIAL* or by using the **UP** **DOWN** keys. The *SUB DIAL* may be used to change the memory bank identifier. The **UP** **DOWN** keys may also be used to select the memory channel. Alternatively you may enter the memory location in full via the numeric keypad. For example, to recall memory channel "123" press **1** **2** **3** **ENTER** while in memory recall mode.

Once a channel has been recalled, to delete data from memory channel "123" press **FUNC** **•**. The legend "DEL MEM-CH" is displayed on the left of the LCD with the memory location on the right, the word "DEL" flashes to heighten your attention to help prevent accidental erasure of data

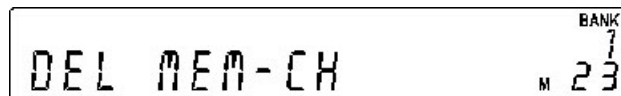

To confirm deletion press **ENTER**. The AR5000 will increment to and display the next memory channel containing data (the display will move upward or downward depending upon whether the **UP** or **DOWN** keys had been previously used or direction of rotation of the *MAIN DIAL* or *SUB DIAL*).

### Deleting complete memory banks

It is often convenient to delete a whole memory bank in one operation. While this may be accomplished by deleting each and every memory channel individually, a faster method is available especially if you have previously stored data into all 100 memory channels of a particular bank.

Ensure the receiver is in VFO or memory recall mode, if in doubt press **VFO**

To access the "DEL MEM-CH" menu press **FUNC** then press and hold the **•** key for more than one second. Use the **UP** **DOWN** keys until the legend "DEL MEM-CH" is displayed.

**Note:** The legend "M" is not displayed to indicate that memory BANK delete rather than memory CHANNEL delete has been accessed.

```
DEL MEM-CH <<<
DEL SEL-CH
DEL M-PASS
DEL SRCH
DEL F-PASS
```

Use the *SUB DIAL* to select the bank you wish to delete. The legend "\*" "\*" displayed under the bank number shows that the bank contains data and all channels have been selected for delete.

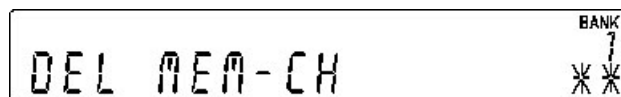

The legend "- -" indicates that the memory bank does not contain data.

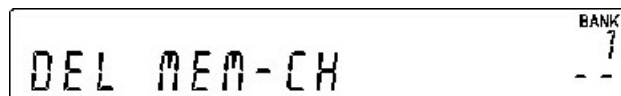

To erase the selected bank press **PASS**, after about two seconds the "\*" "\*" legend will change to "- -" to indicate that the contents have been deleted.

Press **ENTER** or **CLR** to return to SCAN or VFO mode depending on which was previously in use.

## (8) SCAN - scanning memory channels & banks

The AR5000 has a **SCAN MODE** whereby the contents stored in the MEMORY CHANNELS ARE AUTOMATICALLY RECALLED AND MONITORED very quickly for activity - **scanned**. High speed scanning is possible using *Cyber Scan* (a special form of scan where the display is blanked, see section 8-9 of this manual).

### ***It is important that you do not confuse SCAN and SEARCH modes***

SEARCH mode (covered later in this manual) automatically TUNES THE RECEIVER THROUGH ALL FREQUENCIES between two specified frequency limits looking for active frequencies while SCAN is related to memory channels.

## 8-1 SCAN - outline introduction to facilities available

During SCAN the AR5000 automatically recalls each memory channel which contains data in numeric order and monitors them for activity. When an **active** memory channel is located (when a signal is found and the squelch is open) the receiver will temporarily stop scanning.

At default when shipped from the factory, the receiver will remain on the active memory channels until the received signal disappears and the squelch closes. The AR5000 will then wait a further 2 seconds in case a reply is audible (such as aircraft and air traffic communications) then will resume scanning the memory channels again.

If the **UP** **DOWN** keys are pressed during scan or the **MAIN DIAL** rotated, the receiver resumes scanning in the direction of the key or **MAIN DIAL** rotation. This is particularly useful for taking a second look at channels which have just been scanned or for forcing the SCAN process passed unwanted busy channels.

### **Additional facilities available in SCAN mode include:**

Memory banks may be **LINKED** and **UNLINKED** to effectively make larger or smaller groups of memories which may be scanned together.

**CHANNEL PASS** may be used whereby memory channels can be skipped when not required (such as when permanently busy), and may be easily reinstated at a later time.

Another special form of scanning is **PRIORITY** where a special channel (selected from one of the 1000 memory channels) is scanned for activity every five seconds.

**SELECT SCAN** enables you to make a single short list of interesting memory channels from all memory banks to be scanned as a separate function. This reduces the need to PASS, LINK and UNLINK banks and channels.

**AUTO-STORE** reserves memory bank "0" so that active frequencies found while conducting a SEARCH may be automatically written to memory (see SEARCH at section 12 with auto-store at section 12-19). This is a useful tool for compiling an activity list of rarely used frequencies especially when unattended.

**Additional programming:** It is possible to alter the sequence of scanning events depending upon the SCAN CONFIGURATION as defined in the

scan sub menu. There are 5 scanning parameters which may be changed to suit your preferences and requirements PAUSE, DELAY, L-SQ, VOICE & MODE (see section 9 of this manual). It is possible to mix combinations of all five parameters.

## 8-2 Starting to SCAN, considerations

It is presumed that you have already stored your favourite and commonly used frequencies into the memory banks (as per section 7 of this manual).

A total of 1000 memory channels are provided which are divided into 10 banks, each having 100 channels. The memory banks are identified by numbers 0, 1, 2, 3, 4, 5, 6, 7, 8 & 9 and numbered from 00 to 99.

When in SCAN MODE, the memory banks are referred to as **SCAN BANK 0**, **SCAN BANK 1**, **SCAN BANK 8** etc rather than using the full title **SCAN MEMORY BANK 0**, **SCAN MEMORY BANK 1** etc. This terminology has been employed to make the explanation of, and referral to SCAN MEMORY BANKS (SCAN BANKS) less long-winded.

When shipped from the factory memory bank "0" is reserved for auto-store of memory channels from search mode so may already have frequencies stored (refer to section 12-19 of this manual relating to AUTO-STORE).

### **Keep your memory banks tidy - for best scan speed**

In order to achieve the maximum scanning speed, it is advisable to keep all similar frequencies and modes grouped together within the memory banks.

The greater the frequency change between memory channels, then the further the receiver's VCO (Voltage Controlled Oscillator) has to travel and the slower the scan rates. Similarly, when many changes of mode are required, the extra switching which has to be accomplished will reduce the speed of scan.

**Tip:** Memory channel data may be entered in duplicate into several channels, this will ensure the channel data is scanned more frequently to increase the chances of activity being detected.

**Limitations of SCAN mode**

Should a number of different modes and wide range of frequencies be used, then the SCAN process may be affected by noise or differences in squelch characteristic on some frequencies and modes.

To help provide the best operation of SCAN, additional facilities have been provided should you listen to noisy frequencies or bands containing carriers, make liberal use of the AUDIO and PAUSE scan parameters.

**8-3 SCANNING a memory bank**

Let's assume that you wish to SCAN the contents of memory bank "1" (channels 00 ~ 99) which you have been previously stored with memory data.

There are two ways to start scanning:

- 1) From **VFO** or **SEARCH** modes press **SCAN** to enter **MEMORY RECALL** mode then press **SCAN** again to start scanning.
- 2) From **MEMORY RECALL** mode press **SCAN** once only to start scanning. Alternatively press and hold either the **UP** or **DOWN** key for more than one second to start scanning while in MEMORY RECALL mode.



The "SCAN" legend appears on the LCD to confirm selection and the AR5000 will start scanning through memory channels providing they contain data, are not locked out (PASS), the squelch control is **CLOSED** and the channel is not busy. ALL MEMORY CHANNELS WHICH CONTAIN DATA in the current memory bank will be SCANNED irrespective of mode and frequency. ANY BLANK (empty) MEMORY CHANNELS which contain no data will be ignored (skipped).

The memory bank identifier (such as "1") will be displayed on the top right of the LCD under the legend "BANK" and the memory channels displayed

When an **active** channel has been located (busy so the squelch opens) the scan process will temporarily halt on the active channel and the full memory location (such as "103") will become static on the right of the LCD with the active frequency displayed to the left.

It is possible to swap between FREQUENCY display and TEXT display by pressing **FUNC** **ENTER** (providing text has been stored in the memory channels).

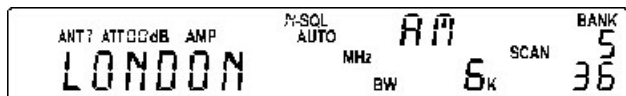

**Note:** If text has not been stored in the memory channels and TEXT DISPLAY has been selected, the AR5000 will halt on busy channels but no frequency or text will be displayed... this can be confusing at first. To restore the frequency display under this condition simply press **FUNC** **ENTER**

Finally when the channel becomes clear again (the signal disappears and squelch closes), the receiver will wait for an additional two seconds (initial default) to allow for a reply on the channel before resuming the scanning process.

**Transfer of memory channel to VFO-E**

When stopped on an active channel, press **ENTER** to transfer the memory data (frequency, mode, step, attenuator etc) to VFO-E where you may tune away from the channel or listen to it indefinitely until you decide otherwise.



**8-4 Selecting a single memory bank to scan**

The memory bank which is currently being scanned will be displayed in the top right of the LCD under the legend "BANK" (for example "2") and channel number will be changing underneath.



Should you wish to scan a different memory bank rotate the **SUB DIAL**.



For example, to select memory bank "5" while currently scanning bank "3" rotate the **SUB DIAL** clockwise until the bank legend "5" is displayed... empty memory banks will be skipped.



Memory bank "5" will be scanned with channel numbers changing.

**Note:** As a short cut it *is* possible to change bank number using the numeric keypad, however if an empty memory bank is selected, the SCAN process will be terminated and MEMORY RECALL mode will be entered. Only use the keypad short cut if you **know** the bank contains memory data.

**Alternatively** to activate SCAN of a specific bank, you may FIRST select the desired bank in memory recall mode then activate SCAN by pressing the **SCAN** key or pressing the **UP** or **DOWN** key for more than one second.

## 8-5 Memory bank linking to scan ALL memory banks

When shipped from the factory using default settings all memory banks are UNLINKED so may only be scanned on an individual basis by selecting the scan bank identifier as per section 8-4 using the *SUB DIAL* or numeric keypad (“1”, “2”, “3” etc).

It is possible to quickly link ALL memory banks together so they will be scanned as one group. In fact it is possible to select any number of banks to be scanned as a group such as 1, 3, 4, 7, 8, 9.

To LINK ALL memory banks for scanning the SCAN BANK LINK MENU is used. To access this menu press **FUNC** **SCAN**, this can be carried out in memory recall, SCAN mode, SEARCH mode or VFO mode.

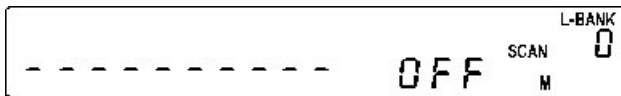

The legends “L-BANK”, “SCAN” and “M” confirm selection of the scan bank link menu. At default the dominant legend will be “OFF” to indicate that SCAN BANK LINK is not active. There are ten possible PROFILES for BANK LINK which may be saved for later (fast) retrieval to minimise the required reprogramming, these are identified by number 0, 1, 2, 3, 4, 5, 6, 7, 8 & 9. The *SUB DIAL* is used to make selection of favourite profiles.

To link ALL banks first use the *SUB DIAL* to choose a **profile number** (0 being displayed as default). To select the scan banks to link press each numeric key 0, 1, 2, 3, 4, 5, 6, 7, 8 & 9... the corresponding bank identifiers will be displayed on the LCD (where frequency is normally displayed). To switch BANK LINK ON press the **PASS** key, the legend changes from “OFF” to “ON”.

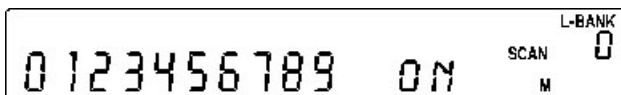

To accept the displayed bank link data press **ENTER**.

Next time the receiver is set to SCAN MODE, ALL banks and channels containing data will be scanned.

**Note:** The SCAN BANK LINK / SETUP menu also provides access to five parameters to customise the way in which scan operates. Please refer to section 9 of this manual for further information.

### Selecting different favourite bank link identifiers (profiles)

The AR5000 will use the settings of whichever bank link identifier (profile number) is displayed when the bank link menu is accessed by pressing **FUNC** **SCAN**, this equates to whichever was last set. Use the *SUB DIAL* to select the required identifier followed by the **ENTER** to accept the changes.

## Deselecting linked banks

It is not necessary to deselect bank link identifiers if you wish to scan a single scan bank, simply access the bank link menu and use the **PASS** key to switch the bank link OFF followed by **ENTER** to accept the change.

## 8-6 Specifying memory bank linking for certain memory banks only

When The BANK LINK option has been selected “ON” (as per section 8-5 of this manual) ALL memory banks are linked. However, it is possible to de-select and re-select memory banks for scanning and select just those you particularly wish to scan through the **BANK LINK** menu.

To LINK just three scan banks... access the menu by keying **FUNC** **SCAN**, this can be carried out in memory recall, SCAN mode, SEARCH mode or VFO mode.

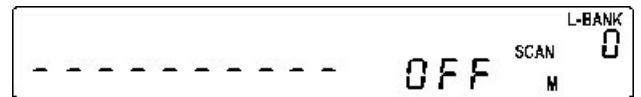

The legends “L-BANK” and “SCAN” confirm selection of the scan bank link menu. At default the dominant legend will be “OFF” to indicate that SCAN LINK is not active.

### Example, link banks 0, 1 & 2.

Select the bank link PROFILE you wish to using the *SUB DIAL*, in this example use number 1.

To select the desired banks to link press each corresponding numeric key **0** **1** **2**, the corresponding bank identifiers will be displayed on the LCD (where frequency is normally displayed).



To switch BANK LINK ON press the **PASS** key, the legend changes from “OFF” to “ON”. To accept the displayed bank link data press **ENTER**.

Next time the receiver is set to SCAN MODE, banks 0, 1 & 2 will be scanned (where channels contain data).

## 8-7 Scanning a memory bank which is not selected in BANK LINK

It is still possible to SCAN a single deselected bank by manually bypassing the BANK LINK programming. To SCAN **any** deselected bank simply rotate the *SUB DIAL* while scanning until the desired scan bank number is displayed in the top right of the LCD.

The AR5000 will scan only the selected single unlinked bank over and over and will not attempt to scan the group of banks as specified in BANK LINK.

Alternatively you could switch bank link OFF or select a bank link **profile** where group programming has not been selected.

To return to the GROUP selection, rotate the **SUB DIAL** until one of the *linked* scan bank numbers is displayed.

## 8-8 SCAN channel PASS (lockout)

Should the AR5000 stop on an active channel while scanning and for some reason you do not wish to monitor it any longer, simply press the **UP** **DOWN** keys or rotate the **MAIN DIAL** to force the SCAN process to resume in the direction selected.

However, should the receiver continually stop on the same channel you may wish to PASS (lockout) the channel so that it will be *skipped over* when the bank is next scanned.

Memory scan channels may be PASSED (locked out) either when the receiver stops in scan mode (when they are active and the receiver has stopped scanning) or by recalling them in memory recall mode.

### Memory scan PASS while scanning

To PASS a channel when scanning, wait for the channel to become active then press **PASS**. The AR5000 will appear to move immediately onward from the passed (locked out) channel.

The microprocessor will have quickly tagged the channel with the legend **"PASS"** on the LCD above the letter **"M"** (for memory) positioned to the left of the bank and channel identifier. This process will happen so quickly that you will not see the legend **"PASS"** being added. However, should the memory channel subsequently be recalled, the **"PASS"** legend will be displayed to signify channel PASS.

### Memory scan PASS & review using memory recall mode

Memory scan channels may be *tagged* for **"PASS"**, un-tagged or reviewed using memory recall mode.

If the receiver is in VFO, SEARCH or SCAN mode press **SCAN** to place the receiver into MEMORY RECALL mode. The legend **"M"** appears on the LCD to confirm operation.

The AR5000 will display a memory channel, mode, frequency, text and scan PASS status etc...

If the desired memory channel to be PASSED (locked out) is not immediately displayed, the **MAIN DIAL** may be rotated to review specific memory channels. Alternatively the memory channel location may be quickly recalled by keying in the required location via the numeric keypad.

For example, to recall memory channel "100" type **1** **0** **0** there is no need to press enter.

When the memory channel has been selected, the legend **"PASS"** to the left of the bank/channel number indicates the current status of SCAN MEMORY CHANNEL PASS.

Pressing **PASS** when in memory recall mode toggles the status of the displayed memory channel scan pass (lockout)...

**"PASS"** = PASS (lockout)  
**NO LEGEND** = will be scanned

The AR5000 will monitor whatever memory channel is displayed while in memory recall mode whether the **"PASS"** indicator is shown or not.

### Deleting memory pass channels

It is often convenient to remove the pass status of all channels in a memory bank instead of reviewing and unlocking them one-by-one. While this may be accomplished by unlocking each and every memory channel individually, a faster method is available especially if you have previously locked out (PASSED) nearly all of the 100 memory channels of a particular bank.

Ensure the receiver is in VFO or memory recall mode, if in doubt press **VFO**.

To access the **"DEL M-PASS"** menu press **FUNC** then press and hold the **•** key for more than one second. Use the **UP** **DOWN** keys until the legend **"DEL M-PASS"** is displayed.

```
DEL MEM-CH
DEL SEL-CH
DEL M-PASS <<<
DEL SRCH
DEL F-PASS
```

Use the **SUB DIAL** to select the bank you wish to fully unlock. The legend **"\* \*"** displayed under the bank number shows that the bank contains passed channels which may be unlocked.

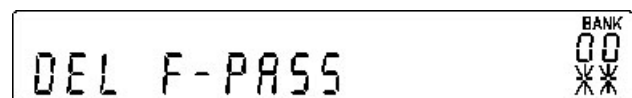

The legend **"- -"** indicates that the memory bank does not contain any locked out memory channels.

To unlock all passed channels of the selected memory bank press **PASS**. After about two seconds the **"\* \*"** legend will change to **"- -"** to indicate that all the memory channels have been unlocked.

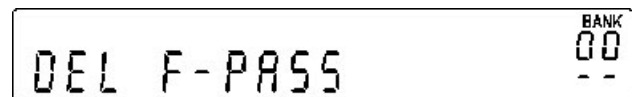

Press **ENTER** or **CLR** to return to SCAN or VFO mode depending on which was previously in use.





## 8-9 Cyber Scan in SCAN mode

A special facility has been provided to speed up the scanning process (which is capable of scanning about 25 memory channels per second), typically the speed increases to about 45 channels per second.

When *Cyber Scan* has been selected the frequency and text are blanked out from the display while scanning, the words "CYBER SCAN" are displayed in their place. While scanning the legend "SCAN" flashes to indicate that SCAN is in progress.

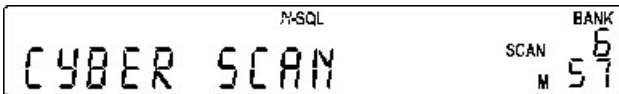

When a busy channel is located, the FREQUENCY or TEXT will be displayed (taking the place of the *Cyber Scan* legend), the "SCAN" legend stops flashing when a busy channel has been located.

To enable *Cyber Scan* press **FUNC** then press and hold the **ENTER** key for more than one second... a bleep will then sound and the "FUNC" legend will be removed from the LCD to confirm operation. This key sequence acts as a toggle to switch *Cyber Scan* on and off.

**Note:** If no text has been saved in memory and TEXT mode has been selected rather than FREQUENCY, the display will be void of information when *Cyber Scan* locates a busy channel !!

## (9) Additional SCAN facilities

It is possible to alter the sequence of scanning events when in SCAN mode

depending upon the SCAN CONFIGURATION as defined in the **BANK LINK / SETUP** sub menu. As with BANK LINK, 10 PROFILES of the additional facilities may be used along side BANK LINK.

There are 5 parameters (in addition to BANK LINK and PASS) which may be changed to suit your preferences and requirements. The list of scanning defaults is shown below:

Scan type	Default	Comment
PAUSE	OFF	OFF and 1 ~ 60 seconds
DELAY	2.0s	OFF and 0.1 ~ 9.9 seconds
L-SQ	OFF	OFF and 1 ~ 255
VOICE	OFF	OFF and 1 ~ 255 (*)
MODE	ALL	ALL/FM/AM/LSB/USB/CW

**It is possible to mix combinations of all five parameters.**

To access the additional facilities of **BANK LINK / SETUP** press **FUNC** **SCAN**. Initially the BANK LINK menu is displayed, the **UP** and **DOWN** keys allow selection of the additional facilities operating as a carousel.

The **MAIN DIAL** and **SUB DIAL** may be rotated to change values on each menu. The **PASS** key selects OFF (and sometimes default such as 2.0s as in the DELAY menu). When you are happy with the changes press **ENTER** to accept the entry and the AR5000 will revert to SCAN, SEARCH or VFO mode depending upon which was previously in use.

**Note:** Make *small* changes and assess the effect as incorrect setting may degrade the effectiveness of SCAN capabilities. If things appear to go wrong, return the settings to their defaults as listed earlier in this section.

*In extreme cases, reset the microprocessor (by switching the receiver on while holding the **CLR** key), this action will revert the scan options back to defaults (by deleting all bank link / setup programming).*

## 9-1 SCAN - PAUSE

The scan PAUSE parameter determines how long the receiver will remain on an **active** channel before resuming scanning channels even if the channel is still busy.

This is useful if you wish to gain a picture of what is happening on the memory channels without the AR5000 being tied to a busy channel for long periods (such as active amateur band repeaters etc). PAUSE scan saves you having to manually intervene to force the scan to continue or use channel PASS (lockout). The limits are OFF and 01 to 60 seconds (default OFF).

Press **FUNC** **SCAN** to access the BANK LINK menu. Use the **UP** **DOWN** keys to locate the "PAUSE OFF" selection.

```

PAUSE OFF <<<
DELAY 2.0
L-SQ OFF
VOICE OFF
MODE ALL
  
```

Either use the **MAIN DIAL** or **SUB DIAL** to change the value. The **PASS** key may be used as a short cut to OFF.

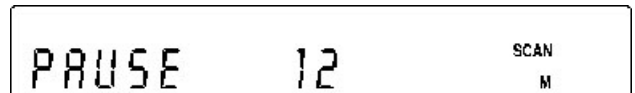

To accept the changes to PAUSE scan press **ENTER** to return to normal display (SCAN, SEARCH or VFO mode). Alternatively you may move to the next option (DELAY SCAN) by pressing the **UP** key. While in SCAN mode the legend "PAUSE" will be displayed toward the right hand side of the LCD to indicate that PAUSE is in operation.



## 9-2 SCAN - DELAY

The scan DELAY parameter affects the time the AR5000 will remain on an active channel in scan mode once the received signal has disappeared and the squelch closed.

This is particularly useful for customising how long the receiver will wait for a reply before continuing to scan. For example, when communications are passed back and forth between a control tower / aircraft which may take a few seconds. If you are scanning duplex channels then a small delay or no delay at all may be preferable.

The limits are OFF and 0.1 to 9.9 seconds (default 2.0 seconds).

Press **FUNC** **SCAN** to access the BANK LINK menu. Use the **UP** **DOWN** keys to locate the "DELAY 2.0" selection.

```

PAUSE OFF
DELAY 2.0 <<<
L-SQ OFF
VOICE OFF
MODE ALL
    
```

Either use the *MAIN DIAL* or *SUB DIAL* to change the value. The **PASS** key may be used as a short cut toggle between OFF and the default of 2.0 seconds.



To accept the changes to DELAY scan press **ENTER** to return to normal display (SCAN, SEARCH or VFO mode). Alternatively you may move to the next option (LEVEL SQUELCH SCAN) by pressing the **UP** key.

## 9-3 SCAN - LEVEL SQUELCH

The scan LEVEL SQUELCH parameter causes the receiver to check the signal strength of **active** channels and to only stop when the signal strength is above a predetermined level which is programmable in 256 steps.

The limits are OFF and 1 to 255 levels (default OFF).

Press **FUNC** **SCAN** to access the BANK LINK menu. Use the **UP** **DOWN** keys to locate the "L-SQ OFF" selection.

```

PAUSE OFF
DELAY 2.0
L-SQ OFF <<<
VOICE OFF
MODE ALL
    
```

Either use the *MAIN DIAL* or *SUB DIAL* to change the value. The **PASS** key may be used as a short cut to OFF.

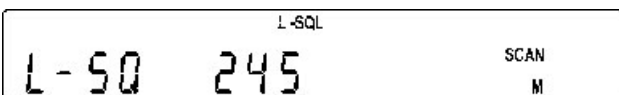

If the **PASS** is used to select OFF, use of the *MAIN DIAL* and *SUB DIAL* afterwards will result in the value continuing from whatever was last selected, this speeds up the selection process. In fact the **PASS** key may be used as a toggle between OFF and the new setting.

While in memory recall or scan mode, the LCD legend "N-SQL" for noise squelch (normal operation) is replaced by the legend "L-SQL" to indicate that level squelch is in operation.

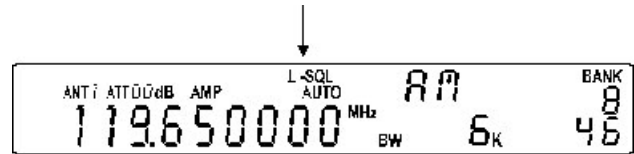

To accept the changes to scan LEVEL SQUELCH press **ENTER** to return to normal display (SCAN, SEARCH or VFO mode). Alternatively you may move to the next option (VOICE SCAN) by pressing the **UP** key.

**Note:** It is possible that false signal levels may upset the operation of scan LEVEL SQUELCH due to local noise or the close proximity of computer systems. Number 1 instructs the AR5000 to react to very weak signals while a higher number of 255 instructs the system to react ONLY to strong signals. Experimentation will be necessary with different types of signal to find the best setting for specific requirements... the lower level settings may not be usable when high noise is present.

## 9-4 SCAN - VOICE

The scan VOICE parameter determines the way in which an **active** channel is determined by sampling the audio modulation. When the VOICE scan facility is enabled, the scan process will only stop on active channels which have modulation (such as voice) present. The AR5000 will not remain on unmodulated channels (such as blank carriers).

You may find this facility useful for skipping over STRONG signals but WEAKER noisy signals may **fool** the receiver into thinking that modulation is present as will signals with pilot tones or heterodynes present. Experimentation will certainly be required with different types of signal. The limits are OFF and 1 to 255 (default OFF).

Press **FUNC** **SCAN** to access the BANK LINK menu. Use the **UP** **DOWN** keys to locate the "VOICE OFF" selection.

```

PAUSE OFF
DELAY 2.0
L-SQ OFF
VOICE OFF <<<
MODE ALL
    
```

Either use the *MAIN DIAL* or *SUB DIAL* to change the value. The **PASS** key may be used as a short cut to OFF.

If the **PASS** is used to select OFF, use of the *MAIN DIAL* and *SUB DIAL* afterwards will result in the value continuing from whatever was last selected, this speeds up the

selection process. In fact the **PASS** key may be used as a toggle between OFF and the new setting.

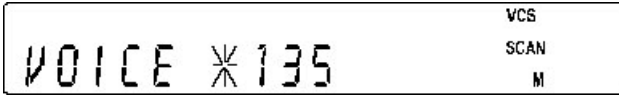

The legend "\*" positioned to the right of the word "VOICE" indicates that the current audio will open the squelch, use the **SUB DIAL** to increase the value until the "\*" legend disappears, you can then be sure that the scan voice setting will ignore and skip over the current frequency.

While in memory recall or scan mode, the LCD legend "VCS" for voice squelch is displayed toward the top right hand side of the LCD to indicate that voice squelch is in operation.



To accept the changes to scan VOICE SQUELCH press **ENTER** to return to normal display (SCAN, SEARCH or VFO mode). Alternatively you may move to the next option (MODE SCAN) by pressing the **UP** key.

### 9-5 SCAN - MODE (receive mode AM, FM etc)

The scan MODE parameter determines whether ALL specified memory channels will be scanned or only those of a certain receive mode.

This can be very useful if for example you have a mixture of VHF AM civil airband frequencies in a memory bank along with VHF NFM marine. Rather than having to scan ALL channels or PASS (lock out) certain channels, a SPECIFIC receive mode ONLY can be quickly selected and scanned.

The options are: ALL, FM, AM, LSB, USB & CW (default ALL).

Setting the option to "ALL" will cause the scan process to stop on all active channels regardless of mode.

Press **FUNC** **SCAN** to access the BANK LINK menu. Use the **UP** **DOWN** keys to locate the "MODE ALL" selection.

```

PRUSE OFF
DELAY 2.0
L-SQ OFF
VOICE OFF
MODE ALL <<<

```

Rotate the **SUB DIAL** to change the option, the **PASS** key acts as a short cut to "ALL".

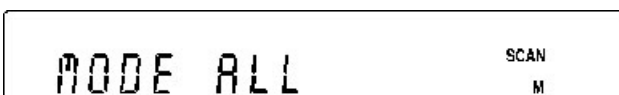

To accept the changes to MODE scan press **ENTER** to return to normal display (SCAN, SEARCH or VFO mode). Alternatively you may move to previous options using the **UP** or **DOWN** keys.

**Note:** If no channels have been programmed into memory using the selected receive mode the receiver will not be able to scan, use this facility carefully and thoughtfully. If the receiver is unable to scan (and the bleep tone is enabled) the error tone will be sounded when scan is selected.

### (10) SELECT SCAN - special select scan list overview

While scanning memory banks, you may decide that some memory channels are MORE INTERESTING than others and become frustrated at having to manually force the SCAN passed uninteresting, but active channels. Of

course it is possible to PASS (lockout) these uninteresting channels but you will need to reinstate them at a later time.

A better method is to use SELECT SCAN which is made up of a specially selected list of tagged memory channels which may be scanned as a group. This is a very useful facility which allows rapid selection of memory channels from any memory bank regardless of frequency, mode or pass status.

Up to 100 memory channels may be tagged for SELECT SCAN and drawn from any of the ten memory banks.

The great advantage is that the contents of the SELECT SCAN list may be deleted in one simple sequence making the list blank and ready for use over and over again.

#### 10-1 Tagging scan select channels

There are two ways in which memory channels may be tagged for SELECT SCAN.

1. SELECT SCAN channels may be tagged while in SCAN MODE and stopped on an active channel by pressing **FUNC** **PASS**. The legend "5" is added before the memory bank number to show that the channel has been added to the select scan list.



2. SELECT SCAN channels may be tagged while in MEMORY RECALL MODE by first selecting the desired memory channel then press **FUNC** **PASS**. The legend "5" is added before the memory bank number to show that the channel has been added to the select scan list.

## 10-2 SELECT SCAN - while in SCAN mode (tagging and un-tagging)

While the receiver is scanning, the AR5000 will stop on active frequencies and you will soon realize that some are **interesting** and some **uninteresting**.

To build up **your** select scan list of interesting channels, start to **tag** the interesting channels while the scan sequence pauses on active memory channels by pressing

**FUNC** **PASS**

The legend "5" will be displayed next to the bank number of the memory channel to confirm selection.



Each time the sequence **FUNC** **PASS** is keyed, the SELECT SCAN status "5" is toggled so that the channel may be **tagged** (chosen / registered) and **un-tagged** at will.



**Tagging** a memory for SELECT SCAN will not force the scan to continue nor affect the way in which the memory channel or SCAN mode operates. When the signal disappears normal SCAN mode is resumed.

## 10-3 SELECT SCAN while in MEMORY RECALL mode (tagging and un-tagging)

SELECT SCAN channels may be **tagged** or **un-tagged** while in memory recall mode by first selecting the desired memory channel then keying

**FUNC** **PASS**

If not already in memory recall mode, press **SCAN**. The legends "M" and "BANK" are displayed on the LCD to confirm selection of memory recall.



The AR5000 will display a memory channel, mode, frequency (or TEXT if text mode is selected). You may now select and **tag** interesting memory channels to add to the SELECT SCAN list from any of the ten memory banks.

If the desired memory channel is not immediately displayed it may be RECALLED by keying in the required location. To recall memory channel "100" type **1** **0** **0** there is no need to press enter.



Alternatively the **MAIN DIAL**, **UP** or **DOWN** keys may be used to review, hunt for and select memory channels

to be **tagged** or **un-tagged**, the **SUB DIAL** is used to change bank number.

When the memory channel has been **tagged** using the sequence **FUNC** **PASS**, the legend "5" will be displayed next to the bank number of the chosen memory channel to confirm selection.



Each time the sequence **FUNC** **PASS** is keyed, the SELECT SCAN status "5" is toggled so that the channel may be **tagged** (chosen / registered) and **un-tagged** at will.



## 10-4 Starting SELECT SCAN

To initiate SELECT SCAN once a selection of channels has been made press

**FUNC** **4**

SELECT SCAN will scan only the memory channels which have been chosen (**tagged**) and will adopt the current PARAMETERS which have been saved in the currently selected BANK LINK configuration. In the default state, the scan will remain on an active channel then wait a further two seconds after the signal has disappeared before resuming SCAN. If you have altered the BANK LINK / SETUP parameters (section 9 of this manual), the new parameters will be employed.

If no memory channels have been **tagged** for SELECT SCAN, the error beep will sound (if the beep tone has been enabled).

## 10-5 Deleting all SELECT SCAN channels in one go

It is convenient to delete ALL the SELECT SCAN channels in a single operation. This makes the list ready for a fresh start, perhaps using a totally different selection of SELECT SCAN channels.

While this may be accomplished by untagging each and every SCAN SELECT channel individually, a faster method is available especially if you have previously selected all 100 select scan channels.

Access the DELETE menu by pressing **FUNC** then press and hold the **•** key for more than one second. Use the **UP** **DOWN** keys until "DEL SEL-CH" appears on the LCD.

```
DEL MEM-CH
DEL SEL-CH <<<
DEL M-PASS
DEL SRCH
DEL F-PASS
```

The right of the LCD will display the legend “\* \*” if select scan channels exist and “- -” if there are none to delete.

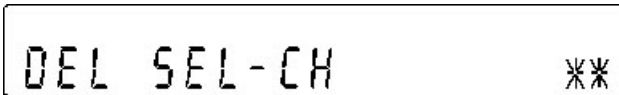

To delete all select scan channels (un-tag them all) press **PASS**, the legend will change to “- -” to confirm operation.

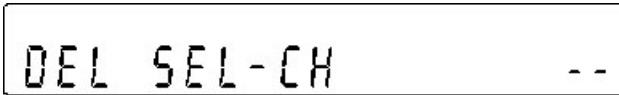

The memory channels themselves will not be deleted, **only the select scan tags will be removed**. Press **ENTER** to return to VFO, SCAN or SEARCH, whichever was previously used.

### (11) Priority operation

The PRIORITY feature enables you to carry on scanning, searching or monitoring while the AR5000 checks a selected frequency for activity (taken from one of the 1000 memory channels - default 000 every 5 seconds).

The priority checking is accomplished by **momentarily** tuning the receive circuit to the priority frequency to see if it is **active**. If activity is found, the AR5000 will remain on the active frequency until the signal disappears. If no activity is detected, the receiver returns to the VFO frequency, scan channel or search bank from where it originated.

The priority facility has a large number of applications and is particularly useful for keeping an eye on a distress frequency while scanning or searching another frequency band.

**Note:** Depending upon the frequency and mode stored as priority, an audible **click** may be heard when the priority facility is in operation. This is quite normal and is caused by the internal switching of circuitry necessary to accomplish the frequency change (as two frequencies cannot simultaneously be monitored).

The priority mode is automatically suspended during entry of frequencies via the numeric keypad, this prevents the AR5000 from changing frequency while you are busy programming.

#### 11-1 Engaging PRIORITY channel

Once engaged, the default channel used for PRIORITY is “000” and the frequency is checked for activity every 5 seconds.

First ensure that there is data stored in memory channel “000”.

To engage the priority facility press **PRIO**, this may be carried out while in SCAN, SEARCH or VFO modes. The legend “**PRIO**” appears toward the centre of the top line of the LCD to indicate that PRIORITY IS ENGAGED (switched on).



Once priority has been activated, the contents of the memory channel used (default 000) may be altered without affecting the data used for PRIORITY operation which is stored separately and assumes an identity of its own irrespective of the data contents of memory 000.

When the priority channel becomes active (signal present and squelch open), the legend “Pr” will be displayed on the right of the LCD. The active priority frequency will be monitored until it clears, this will temporarily halt any scan and search process.



Should you subsequently wish to alter the priority data, you will have to use the PRIORITY SETUP menu.

To cancel priority operation press **PRIO**, the legend “**PRIO**” will be removed from the top line of the LCD to confirm de-selection.

#### 11-2 Changing PRIORITY channel parameters

The default channel used for PRIORITY is “000” and the frequency copied from this channel is checked for activity every 5 seconds.

You may select a different memory channel from which the priority data will be taken or may vary the sampling time for priority activity checking. This is accomplished by using the PRIORITY SETUP menu accessed by pressing

**FUNC** **PRIO**. The flashing legend “**PRIO**” appears on the top line of the LCD to confirm selection.

The legend “Pr” also alternates with the bank/channel number on the right of the LCD inviting a new memory location to be chosen.



Use the **MAIN DIAL**, **SUB DIAL** or enter a three digit memory location via the numeric keypad. To transfer the data to PRIORITY press **ENTER**.

Alternatively press the **UP** **DOWN** keys to select the priority sampling interval (how often priority is checked for activity).

When the interval menu is selected the legend "P-INTER 05" is displayed (with 05 being the default of 5 seconds).

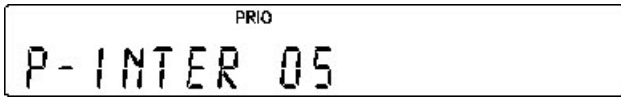

This numeric value in seconds determines how long the AR5000 will wait between checking cycles before re-sampling the priority frequency for activity (once the priority facility has been activated). The default is "05" (5 seconds) and the acceptable range is 01 ~ 60 seconds.

Rotate the *MAIN DIAL* or *SUB DIAL* until the desired value is displayed. Once you are happy with the new selection press **ENTER** to accept the changes. The display will return to SCAN, SEARCH, or VFO mode from wherever it originated.

**Note:** If you should attempt to select a blank memory channel, a low pitch *beep* error will sound when you press **ENTER** (if the *beep* is on) and the display will return to SEARCH, SCAN or VFO mode, from wherever it originated.

## (12) SEARCH

The AR5000 is equipped with various SEARCH modes whereby an upper and lower frequency limit may be defined and the AR5000 instructed to look for activity on all frequencies in predetermined step size in an upward or downward direction. The mode and channel step will change automatically when set to the default of AUTOMODE but data may be specified specifically if preferred.

*It is important that you do not confuse SEARCH and SCAN modes.*

SEARCH mode automatically TUNES THE RECEIVER THROUGH ALL FREQUENCIES between two specified frequency limits looking for active frequencies. SCAN mode is uses SPECIFIC SPOT FREQUENCIES which have been stored into memory.

The great advantage of SEARCH over manual tuning is that it is so fast! There are many different facilities available for SEARCH mode which will be explained in this section.

The search instructions may be programmed into banks. There are a total of 20 programmable search banks so that data entry and recall is simple and efficient.

Continuously active or busy frequencies such as amateur band repeaters may be PASSED (skipped) and active frequencies stored into memory. There is even an AUTO-STORE facility where active channels are automatically written to memory bank "0".

When the AR5000 stops on a genuine active frequency during search, the **ENTER** key may be pressed to transfer the displayed frequency to VFO-D where it may be monitored for long periods of time or tuned.

Pressing **ENTER** for more than 1 second will initiate the process of storing the frequency into a memory channel.

### Limitations of SEARCH mode

SEARCH mode is extremely effective for AM & NFM use in the VHF and UHF bands. Searching the short wave bands is usually ineffective due to the relatively high background noise especially when propagation conditions are good and bands open.

Searching using the modes of USB, LSB and CW will produce mixed results depending upon frequency band and whether any strong signals are encountered which will affect the receiver's AGC (Automatic Gain Control) circuitry.

Usually, short wave band and SSB monitoring is carried out with the squelch control *open* (fully anticlockwise) and manual tuning by rotating the *MAIN DIAL* - not by scanning or searching. Searching using the mode of WFM may not be possible in certain frequency bands due to the level of background noise and adjacent channel activity.

**Fundamentally there are three types of search:**

**Manual search (VFO search) - VFO-A, VFO-B**

**Simple search (VFO search) - VFO-C, VFO-D, VFO-E**

**Program search (bank search) - Search banks 00 ~ 19**

### 12-1 Manual SEARCH between two VFO frequencies (VA, VB)

The simplest form of **controlled** SEARCH is achieved by programming different frequencies into VFO-A and VFO-B.

1 Press the **VFO** key a few times until the legend "VA" is displayed on the lower right corner of the LCD. Press and hold the **MODE** key for more than one second so that the "AUTO" legend is displayed to ensure the AR5000 is in AUTOMODE.



In this example let's assume that the required search range is 118.000 MHz to 136.000 MHz, the step size, mode etc will be taken care of automatically as AUTOMODE is engaged.

While the legend "VA" is displayed on the lower right corner of the LCD (signifying that VFO-A is selected) key in the lower frequency limit of 118.000 MHz

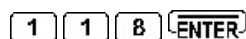

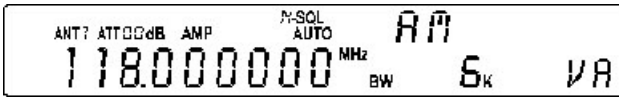

2 Select VFO-B. Press the **VFO**, the legend “V B” is displayed on the lower right corner of the LCD. Press and hold the **MODE** key for more than one second so that the “AUTO” legend is displayed to ensure the AR5000 is in AUTOMODE (as each VFO can retain different mode information).



Key the upper frequency limit into VFO-B. In this example 136.000 MHz (the step size, mode etc will be taken care of automatically as AUTOMODE is engaged).

**1 3 6** **ENTER**

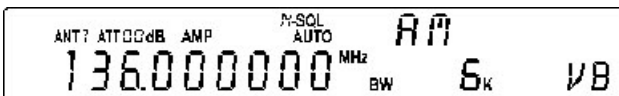

3 To initiate manual frequency search (while “V R” or “V B” are displayed) press and hold the **VFO** key for more than one second (the **UP** or **DOWN** keys may also be held for more than one second to initiate manual search).

The squelch MUST be closed for the search process to operate.



The manual search process will start from the frequency in VFO-A and search until it gets to frequency of VFO-B then loop back to the frequency of VFO-A and start again. The legend “S R” (SeaRch) will be added above the VFO indication to show that SEARCH is in progress.



If the mode (and other receive parameters) are different in VFO-A and VFO-B, the mode data will be taken from the currently displayed VFO.

The **MAIN DIAL**, **SUB DIAL**, **UP** or **DOWN** keys may be used to reverse the direction of search and force the search process onward when stopped on a busy frequency. The process will halt when a busy frequency is located, (at default will wait for two seconds after the transmission clears) then resume searching again when the frequency is clear.

### Cancelling manual search

Manual search may be cancelled by pressing **VFO**. The display will either revert to VFO-A or VFO-B depending upon which was being used when manual search was selected. As a result VFO-A will display the lower frequency and VFO-B the upper. This can also be useful if you wish to quickly change the band edges of manual search and restart the process.

### Accept the frequency from manual search mode

If you wish to stop the manual search and monitor an interesting busy frequency, it is necessary to transfer the frequency to **VFO-D** where it may be monitored without the search process resuming as the frequency clears.

To transfer the frequency press **ENTER** while the frequency is busy. The frequency will be transferred to VFO-D and the legend “V D” will be displayed on the lower right of the LCD to confirm operation.

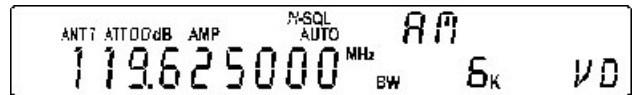

### Saving busy frequencies into memory

It is possible to save interesting frequencies into memory. While stopped on an active frequency press and hold the **ENTER** key for more than one second, the MEMORY INPUT menu will appear. Select the desired memory location for storage (refer to section 7-1 of this manual if you are unsure of the required key strokes). Press the **ENTER** key to accept input, the manual search process will resume.

## 12-2 Simple search (VC, VD, VE)

The quickest form of SEARCH is achieved by keying a start frequency into VFO-C or VFO-D or VFO-E then pressing the **VFO** key for more than one second.

1 Press the **VFO** key a few times until the legend “V C” (or “V D” or “V E”) is displayed on the lower right corner of the LCD.

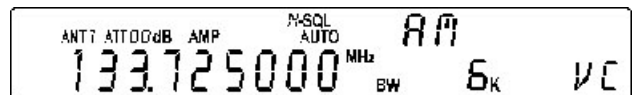

Press and hold the **MODE** key for more than one second so the “AUTO” legend is displayed to ensure the AR5000 is in AUTOMODE.

In this example let’s assume that the required starting point is 145.2 MHz, the step size, mode etc will be taken care of automatically as AUTOMODE is engaged. Key the lower start frequency.

**1 4 5** **MODE** **2** **ENTER**

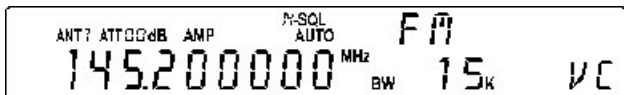

2 To initiate simple frequency search (while “V C” or “V D” or “V E” is displayed) press and hold the **VFO** key for more than one second (the **UP** or **DOWN** keys may also be held for more than one second to initiate simple search).

The squelch MUST be closed for the search process to operate.



The simple search process will start from the displayed frequency, the legend “SR” (SeaRch) will be added above the VFO indication to show that SEARCH is in progress.



The **MAIN DIAL**, **SUB DIAL**, **UP** or **DOWN** keys may be used to reverse the direction of search and force the search process onward when stopped on a busy frequency. The process will halt when a busy frequency is located, (at default the delay is two seconds after the transmission clears) then resume searching again when the frequency is clear. When simple search reaches the top frequency range of the receiver (2600 MHz), the search process will reverse in direction.

### Cancelling simple search

Simple search may be cancelled by pressing **VFO**. The display will either revert to VFO-C or VFO-D or VFO-E depending upon which was being used when simple search was selected. The VFO will display the original start frequency.

### Accept the frequency from manual search mode

If you wish to stop the simple search and monitor an interesting busy frequency, it is necessary to transfer the frequency to **VFO-D** where it may be monitored without the search process resuming as the frequency clears.

To transfer the frequency press **ENTER** while busy. The frequency will be transferred to VFO-D and the legend “V D” displayed on the lower right of the LCD to confirm operation.



### Saving busy frequencies into memory

It is possible to save interesting frequencies into memory. While stopped on an active frequency press and hold the **ENTER** key for more than one second, the MEMORY INPUT menu will appear. Select the desired memory location for storage (refer to section 7-1 of this manual if you are unsure of the required key strokes). Press the **ENTER** key to accept input, the manual search process will resume.

### 12-3 Optimising VFO search parameters

The key sequence **FUNC** **VFO** accesses a menu where the DELAY, L-SQ level squelch and VOICE options may be set up for VFO search (MANUAL and SIMPLE search). The legend “V-” indicates that the VFO search setup menu has been selected.

Search	Comment	
DELAY	2.0s	OFF and 0.1 ~ 9.9 seconds
L-SQ	OFF	OFF and 1 ~ 255
VOICE	OFF	OFF and 1 ~ 255 (*)

**It is possible to mix combinations of all three parameters.**

### VFO SEARCH - DELAY

The DELAY parameter affects the time the AR5000 will remain on an active frequency in VFO search once the received signal has disappeared and the squelch closed.

This is particularly useful for customising how long the receiver will wait for a reply before continuing to search. For example, when communications are passed back and forth between a control tower / aircraft which may take a few seconds. If you are scanning duplex channels then a small delay or no delay at all may be preferable.

The limits are OFF and 0.1 to 9.9 seconds (default 2.0 seconds).

Key **FUNC** **VFO** to access the menu.

```
DELAY 2.0 <<<
L-SQ OFF
VOICE OFF
```

Either use the **MAIN DIAL** or **SUB DIAL** to change the value. The **PASS** key may be used as a short cut toggle between OFF and the default of 2.0 seconds.



To accept the changes to DELAY, press **ENTER** to return to normal display (SCAN, SEARCH or VFO mode). Alternatively you may move to the next option (LEVEL SQUELCH) by pressing the **UP** key.



## VFO SEARCH - LEVEL SQUELCH

The LEVEL SQUELCH parameter causes the receiver to check the signal strength of **active** frequencies and to **only** stop when the signal strength is above a predetermined level which is programmable in 256 steps.

The limits are OFF and 1 to 255 (default OFF).

**Note:** It is possible that false signal levels may upset the operation of LEVEL SQUELCH due to local noise or the close proximity of computer systems... the lower level settings may not be usable when high noise is present.

A value of **1** instructs the AR5000 to react to very weak signal while a value of **255** instructs the AR5000 to react ONLY to strong signals. Experimentation will be necessary with different types of signal to find the best setting for specific requirements.

Key **[FUNC]** **[VFO]** to access the menu.

```
DELAY 2.0
L-SQ OFF <<<
VOICE OFF
```

Either use the **MAIN DIAL** or **SUB DIAL** to change the value. The **[PASS]** key may be used as a short cut to OFF.

The LCD display shows "L-SQ" at the top, "L-SQ 132" in the center, and "V-" on the right side.

If the **[PASS]** key is used to select OFF, use of the **MAIN DIAL** and **SUB DIAL** afterwards will result in the value continuing from whatever was last selected, this speeds up the selection process. In fact the **[PASS]** key may be used as a toggle between OFF and the new setting.

While in VFO search mode (MANUAL or SIMPLE search) the LCD legend "**N-SQL**" for **noise** squelch (normal operation) is replaced by the legend "**L-SQL**" to indicate that **level** squelch is in operation.

The LCD display shows "L-SQL" at the top, "465.300000 MHz" in the center, "15k" for bandwidth, and "SR VE" on the right side. An arrow points to the "L-SQL" legend.

To accept the changes to LEVEL SQUELCH, press **[ENTER]** to return to a normal display (SCAN, SEARCH or VFO mode). Alternatively you may move to the next option (VOICE SCAN) by pressing the **[UP]** key.

## VFO SEARCH - VOICE

The VOICE parameter determines the way in which an **active** frequency is determined by sampling the audio modulation. When the VOICE facility is enabled, VFO search will only stop on active frequencies which have modulation (such as voice) present. The AR5000 will not remain on unmodulated frequencies (such as blank carriers).

You may find this facility useful for skipping over STRONG signals but WEAKER noisy signals may **fool** the AR5000 into thinking that modulation is present as will signals which have pilot tones or heterodynes present. Experimentation will **certainly** be required with different types of signal.

The limits are OFF and 1 to 255 (default OFF).

Key **[FUNC]** **[VFO]** to access the menu.

```
DELAY 2.0
L-SQ OFF
VOICE OFF <<<
```

Either use the **MAIN DIAL** or **SUB DIAL** to change the value. The **[PASS]** key may be used as a short cut to OFF.

The LCD display shows "VOICE \*134" in the center, "VCS" at the top right, and "V-" on the right side.

If the **[PASS]** is used to select OFF, use of the **MAIN DIAL** and **SUB DIAL** afterwards will result in the value continuing from whatever was last selected, this speeds up the selection process. In fact the **[PASS]** key may be used as a toggle between OFF and the new setting. The "\*" legend extinguishes when the current audio has been defeated by increasing the selected value.

While in VFO search, the LCD legend "**VCS**" for voice squelch is displayed toward the top right hand side of the LCD to indicate that **voice** squelch is in operation.

The LCD display shows "VCS" at the top right, "2188.300000 MHz" in the center, "110k" for bandwidth, and "VA" on the right side. An arrow points to the "VCS" legend.

To accept the changes to VOICE SQUELCH, press **[ENTER]** to return to a normal display (SCAN, SEARCH or VFO mode).

## 12-4 Program search banks

It is possible to save parameters of frequency, mode, tuning step, step-adjust, comment etc into any of the 20 program search banks for easy access at any time.

The program search banks (referred to simply as search banks) are identified by two digit numeric legends on the right of the LCD under the legend "**BANK**". They can be easily distinguished from scan banks as the legend "5 R" for SeaRch is displayed directly underneath.

The LCD display shows "BANK 10" at the top right, "118.000000 MHz" in the center, "6k" for bandwidth, and "SR" on the right side. An arrow points to the "BANK 10" legend.

For your convenience the microprocessor (depending on world market area) may have been pre-programmed (possibly with 10 or so search banks) at the factory, these being specifically chosen for each market area.

An example of possible programming is as follows (in these examples the mode, step etc are taken from the AUTOMODE bandplan data):

10	118.000	to	137.000	MHz	CIV AIR
11	225.000	to	410.000	MHz	MIL AIR
12	410.000	to	425.000	MHz	USAF
13	156.000	to	163.000	MHz	MARINE
14	88.000	to	118.000	MHz	BAND 2
15	145.200	to	145.775	MHz	2M HAM
16	433.000	to	433.600	MHz	70C HAM
17	1297.000	to	1298.000	MHz	23C HAM
18	71.000	to	87.000	MHz	LO PAR
19	163.400	to	225.000	MHz	VHF PAR

### 12-5 Starting program search

Assuming that the AR5000 is pre-programmed with similar data to that shown, initiate PROGRAM SEARCH by pressing **[SRCH]**. The legends "BANK" and "5 R" appear on the right of the LCD to confirm selection.



To select a specific search bank rotate the *SUB DIAL* or key in the two digit bank identifier via the numeric keypad. The bank number is displayed underneath the legend "BANK". The numeric keypad may also be used while in search mode to change bank.

For example, to search bank "15" press **[1]** **[5]** while in search mode, there is no need to press enter.



The lowest frequency in the bank will first appear on the LCD and will change in an upward direction. Use the **[UP]** **[DOWN]** keys or *MAIN DIAL* to reverse the direction of search.

Should the receiver stop on an unwanted active frequency, press the **[UP]** or **[DOWN]** keys or rotate the *MAIN DIAL* to force the search process to continue.

**Note:** Bank numbers "00" and "01" require preceding zeros. Banks "02" to "09" just need the last digit keyed, the preceding "0" is automatically added by the AR5000 microprocessor. Banks "10" to "19" require the entry of both (two) digits.

Example:

- To select bank 0 (00) press **[0]** **[0]**
- To select bank 1 (01) press **[0]** **[1]**
- To select bank 5 (05) press **[5]**
- To select bank 9 (09) press **[9]**
- To select bank 10 press **[1]** **[0]**
- To select bank 19 press **[1]** **[9]**

The key **[3]** has the effect of a TEN key, i.e. bank 13 may also be selected as **[3]** in a similar way to the action of some TV & video remote controls.

### 12-6 Cancelling, re-starting program search saving active frequencies

It is possible to cancel program search, resume, save frequency to VFO where it may be tuned, save frequencies to memory and more...

#### Cancelling search

To cancel program search press **[VFO]**, the display will return to whichever VFO was last used (V A, V B, V C, V D, V E). If you resume program search (by pressing **[SRCH]**), the process will continue from the frequency in use when cancelled.

#### Restarting search

If you resume program search by pressing **[SRCH]**, the process will continue from the frequency in use when cancelled. If however you wish to restart program search process from the original frequency it is necessary to re-select the bank. This can be done by clicking the *SUB DIAL* one step then back or by keying in the bank number again.

#### Accept the frequency from program search mode

If you wish to stop the program search and monitor an interesting busy frequency, it is necessary to transfer the desired frequency to VFO-D where it may be monitored without the search process starting as the frequency clears.

To transfer the frequency press **[ENTER]** while the frequency is busy. The frequency will be transferred to VFO-D and the legend "V D" will be displayed on the lower right of the LCD to confirm operation.



#### Saving busy frequencies into memory

It is possible to save interesting frequencies into memory. While stopped on an active frequency press and hold the **[ENTER]** key for more than one second. The MEMORY INPUT menu will appear. Select the desired memory location for storage (refer to section 7-1 of this manual if you are unsure of the required key strokes). When the **[ENTER]** is pressed to accept input, the program search process will resume.

Downloaded by   
**Amateur Radio Directory**   
  
[www.hamdirectory.info](http://www.hamdirectory.info)

## 12-7 Programming and reprogramming PROGRAM SEARCH BANKS

You may wish to specify your own frequency limits or modes for program search banks. There are 20 program search banks in total 00, 01, 02, 03, 04, 05, 06, 07, 08, 09, 10, 11, 12, 13, 14, 15, 16, 17, 18 & 19.

Example of reprogramming a search bank - "05"

Let's assume that you wish to reprogram the data contents of search bank "5": 433.000 to 433.6000 MHz, mode to NFM, 15kHz I.F. bandwidth, 25 kHz tuning steps, step-adjust off and comment to 70CM.

**Note:** The attenuator and aerial selection is made while program search is in operation and is not programmed into the stored data, this greatly increases the versatility when in live use!

To make things easier for this example, **first delete the existing data.**

Press **[VFO]** to place the receiver in a known state of operation.

Press **[FUNC]** then press the **[•]** key for more than one second to access the DELETE menu. Press the **[UP]** key three times to access the "DEL SRCH" menu (or you could press the **[DOWN]** key twice to get to the same place).

Rotate the *SUB DIAL* until "BANK 05" is displayed on the right of the LCD.

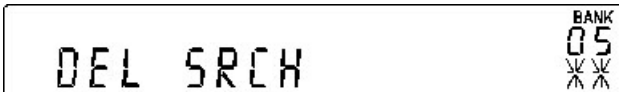

If data is already programmed into this bank the legend "\*" will be displayed, if no data is present the legend "--" will be displayed.

Assuming that data *is* present, press the **[PASS]** key to delete the contents, after about one or two seconds delay the legend will change to "--" to confirm deletion.



Press **[ENTER]** to complete the sequence and return to VFO mode.



To start programming select the data input menu by pressing **[FUNC]** **[1]**

**Select the required bank** by rotating the *SUB DIAL*, until "BANK 05" is displayed on the right of the LCD (for this example). As no data exists the legend "-----" will be displayed, if data was present the upper ("HI") and lower ("LO") frequency limits would alternatively be displayed to warn that data was about to be over-written.

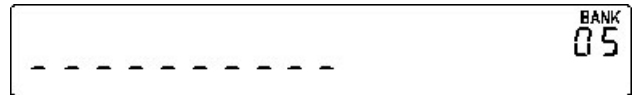

To accept the bank location of "05" and initiate the programming process press **[ENTER]**

**Input the lower frequency limit:** The legend "LO" will flash on the right of the LCD inviting entry of the LOWER frequency limit.

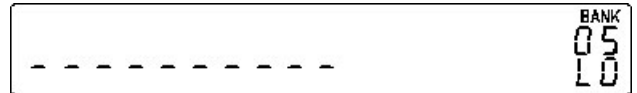

```
LO <<<
HI
MODE FM (set to AUTO if AUTOMODE is used)
IFBW 0.5 (skipped if AUTOMODE is used)
STEP 1.000 (skipped if AUTOMODE is used)
TXT
```

In this example key in **[4]** **[3]** **[3]** **[ENTER]**, the key strokes are echoed onto the LCD.

**Note:** If a mistake was made keying in previous data, you may move backward (or forward) through the data input selection process by holding the **[UP]** or **[DOWN]** key for more than one second depending upon which way you wish to move.

**Input the upper frequency limit:** The legend "HI" will now flash on the right of the LCD confirming entry of the previous data and inviting entry of the UPPER frequency limit.

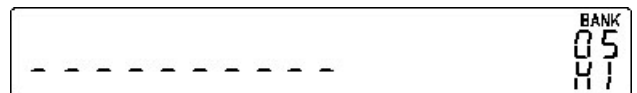

```
LO
HI <<<
MODE FM (set to AUTO if AUTOMODE is used)
IFBW 0.5 (skipped if AUTOMODE is used)
STEP 1.000 (skipped if AUTOMODE is used)
TXT
```

In this example key in **[4]** **[3]** **[3]** **[•]** **[6]** **[ENTER]**



**Select the receive mode:** The legend "MODE" will flash on the display (along with the legend "SR" on the right of the LCD) inviting the receive mode to be entered. The current receive mode is displayed to the right of the "MODE" legend. For example, if the receiver is currently in AUTOMODE the legend "MODE AUTO" will be displayed. Rotate the *SUB DIAL* to select the receive mode, the choice is: *AUTO*, *FM*, *AM*, *LSB*, *USB & CW*. **Note:** the **[PASS]** key acts as a short cut to AUTOMODE.

```

LO
HI
MODE FM <<<
IFBW 0.5 (skipped if AUTOMODE is used)
STEP 1.000 (skipped if AUTOMODE is used)
TXT

```

In this example select "F M" and press **ENTER** to accept the input.

The LCD display shows "MODE FM" on the left and "05 SR" on the right.

**Select I.F. bandwidth:** Providing AUTOMODE has not been selected, the I.F. bandwidth input menu will be displayed "IFBW". The numbers to the right of this legend followed by the legend "kHz" represent the I.F. bandwidth selection.

```

LO
HI
MODE FM
IFBW 15.0 <<<
STEP 1.000 (skipped if AUTOMODE is used)
TXT

```

In this example rotate the *SUB DIAL* to select "15 kHz" then press **ENTER** to accept the input.

The LCD display shows "IFBW 15.0 kHz" on the left and "05 SR" on the right.

**Input the tuning step size:** Providing AUTOMODE has not been previously selected, the legend "STEP" will be displayed flashing toward the centre-top of the LCD inviting input of tuning step size. Either select the required tuning step size using the *SUB DIAL* (from the selection offered) or key in the required step size in kHz using the numeric keypad.

If *step-adjust* is required press **PASS**, the legend "\*" will then be displayed on the extreme left of the LCD to confirm selection.

```

LO
HI
MODE FM
IFBW 15.0
STEP 25.000 <<<
TXT

```

In this example select 25 kHz. Press **ENTER** to accept the data input.

The LCD display shows "STEP 25.000 kHz" on the left and "05 SR" on the right.

**Alphanumeric text input (not mandatory):** The "TXT" legend will be displayed inviting you to select new text for storage in search bank 05. This can be useful to assist identification of banks when the AR5000 is used in TEXT display mode but the input of text is not mandatory. Should you wish to ignore the entry of text press **ENTER** now.

```

LO
HI
MODE FM
IFBW 15.0
STEP 25.000
TXT <<<

```

To aid text entry, a decimal "." is displayed to the right of the text entry point (initially close to the left of the LCD).

The LCD display shows "." on the left and "TXT 05 SR" on the right.

The *SUB DIAL* is used to make selection of text in the form of upper case letters, numbers and symbols. The **UP** and **DOWN** keys move the text entry point to the right and left respectively. If a mistake is made during entry, use the **DOWN** key to move back to the required position and simply over-write it.

You will note that each time the entry point is moved and text selected, the first letter offered is not "0" or "A" but continues from the character, number or symbol last used. A few short cuts are provided via the numeric keypad:

- 1 = Display a blank " ", cancel whatever letter is currently displayed
- 2 = Start at number "1"
- 3 = Start at letter "A"
- 4 = Start at letter "M"
- 5 = Start at letter "Z"
- 6 = Start at number "9"
- 0 = Start at symbol "-"

In this example select the text 70CM then press **ENTER** to accept input and complete the programming of program search bank 05.

The LCD display shows "70CM" on the left and "TXT 05 SR" on the right.

## Notes on program search bank programming

**Aborting input:** At any time you may abort input by pressing the **CLR** key, the display will return to VFO mode.

**Deleting data:** There is no need to delete program search bank data before programming. If data is already present, it may simply be over-written. In this instance the **UP** key must be used to view and move through the options, pressing the **ENTER** key will simply cause the current setup to be saved.

**Auto aerial switching:** To enable the *fastest* search rates, automatic aerial switching is not selected as default, however you may still manually change the aerial selection when in program search mode. Simply initiate whatever

search bank is desired then override the current aerial selection by pressing **FUNC** **ATT** **PASS** **ENTER** to select automatic aerial switching... of course **ANT 1**, **ANT 2**, **ANT 3** or **ANT 4** may be selected using this menu (don't use **PASS**, use the *SUB DIAL* instead).

**Text display:** To toggle the FREQUENCY / TEXT display while in memory recall, scan and search modes press **FUNC** followed by a brief press of the **ENTER** key.

**To start searching** program search bank 05 (or whatever bank was last selected) simply press **SRCH** (providing you haven't set up the search bank link in any specific way to prevent searching of bank 05). To change search bank, rotate the *SUB DIAL* or key in the two digit search bank number if known (providing it contains data).

## 12-8 Deleting PROGRAM SEARCH BANKS

Although you may overwrite program search banks and omit them from search groups through the use of BANK-LINK, it is also possible to DELETE all the data from a specific bank. This may make reprogramming new data into the bank more straight forward and may be useful should a corruption occur.

Example of deleting program search bank - "08"

Press **VFO** to place the receiver into a known state of operation.

Press **FUNC** then press the **•** key for more than one second to access the DELETE menu. Press the **UP** key three times to access the "DEL SRCH" menu (or you could press the **DOWN** key twice to get to the same place).

```
DEL MEM-CH
DEL SEL-CH
DEL M-PASS
DEL SRCH <<<
DEL F-PASS
```

Rotate the *SUB DIAL* until "BANK 08" is displayed on the right of the LCD.

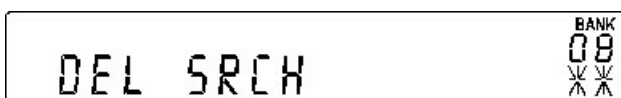

If data is already programmed into this bank the legend "\*" will be displayed, if no data is present the legend "-" will be displayed.

Assuming that data is present, press **PASS** to delete the contents, after about one or two seconds delay the legend will change to "-" to confirm deletion. Press **ENTER** to complete the sequence and return to VFO mode.

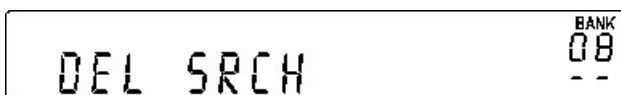

## 12-9 SEARCH - outline introduction to additional facilities available

During program search, the AR5000 tunes to every frequency between two specified frequency limits looking for **active** interesting frequencies. When an **active** frequency is located (when a signal is found and the squelch is open) the receiver will temporarily stop searching.

At default when shipped from the factory, the AR5000 will remain on an active frequency until the received signal disappears and the squelch closes. The AR5000 will then wait an additional 2 seconds in case a reply is audible (such as aircraft and air traffic communications) then will resume searching.

If the **UP** **DOWN** keys are pressed during search or the *MAIN DIAL* rotated, the direction of search may be reversed. This is particularly useful for taking a second look at frequencies which have just been searched and for forcing the search process onward passed unwanted frequencies.

### Additional facilities are available in PROGRAM SEARCH mode:

Program search banks may be **LINKED** and **UNLINKED** to effectively make larger or smaller groups of program search banks which may be searched in succession.

**FREQUENCY PASS** may be used so that constantly active frequencies can be skipped when not required, they may be reinstated at a later time.

**AUTO-MEMORY** makes special use of memory bank "0" so that active frequencies found while conducting a SEARCH may be automatically written to memory (refer to section 12-19 of this manual for further information).

This is a useful tool for compiling an activity list of rarely used frequencies especially when unattended.

There are further parameters (in addition to BANK LINK, PASS and AUTO-STORE) which may be changed to suit your preferences and requirements. The list of search defaults is shown below:

Search type	Comment	
PAUSE	OFF	OFF and 1 ~ 60 seconds
DELAY	2.0s	OFF and 0.1 ~ 9.9 seconds
L-SQ	OFF	OFF and 1 ~ 255
VOICE	OFF	OFF and 1 ~ 255 (*)

For further information refer to the detailed information starting at section 12-13 of this manual.

## 12-10 Linking program search banks

When shipped from the factory (using default settings) all program search banks are UNLINKED so may only be searched on an individual basis by selecting the search bank identifier by rotating the *SUB DIAL* or keying in the two digit bank identifier via the numeric keypad ("00", "08", "15" etc). This is the usual way in which program search banks would be used.

When in PROGRAM SEARCH MODE, the program search banks are referred to as **SEARCH BANK 00**, **SEARCH BANK 08**, **SEARCH BANK 15** etc rather than using the full title **PROGRAM SEARCH BANK 00**, **PROGRAM SEARCH BANK 01** etc. In fact program search banks below 10 may simply be referred to as **1**, **2**, **3** etc (missing out the preceding zero). This terminology has been employed to make the explanation of and referral to PROGRAM SEARCH BANKS (SEARCH BANKS) less long-winded.

It is possible to quickly link a number of search banks together so they will be searched as one group, this can be useful for dividing large bands (such as UHF military airband 220 ~ 410 MHz) into smaller, more manageable sizes. It is possible to select any number from the 20 banks to be searched as a group such as 01, 03, 04, 07, 12, 19.

To LINK search banks, the SEARCH SETUP MENU is used. To access this menu press **FUNC** **SRCH** (this may be carried out in SCAN mode, SEARCH mode or VFO mode).

The flashing legend "5R" confirms selection of the search bank link menu. At default the dominant legend will be "OFF" to indicate that SEARCH LINK is not active.

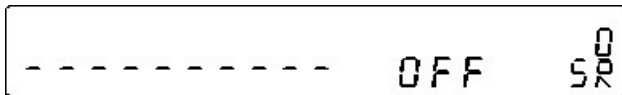

There are ten possible PROFILES for BANK LINK which may be saved for later (fast) retrieval to minimise the required reprogramming, these are identified by number 0, 1, 2, 3, 4, 5, 6, 7, 8 & 9. The *SUB DIAL* is used to make selection of favourite setup.

To link ALL banks, first use the *SUB DIAL* to choose a bank link identifier (0 being displayed as default), then to link ALL search banks press all the identifying numeric keys for the twenty banks 00 ~ 19:

- 0** = search bank 00
- 1** = search bank 01
- 2** = search bank 02
- 3** = search bank 03
- 4** = search bank 04
- 5** = search bank 05
- 6** = search bank 06
- 7** = search bank 07
- 8** = search bank 08
- 9** = search bank 09
- 0** = search bank 10

- 1** = search bank 11
- 2** = search bank 12
- 3** = search bank 13
- 4** = search bank 14
- 5** = search bank 15
- 6** = search bank 16
- 7** = search bank 17
- 8** = search bank 18
- 9** = search bank 19

To select search banks 10 to 19, the preceding "." is used as the figure TEN, i.e. **• 5** = 15

The corresponding bank identifiers will be displayed on the LCD (where frequency is normally displayed). In the case of banks 10 to 19, **bank link** will be indicated by the display of a decimal point.

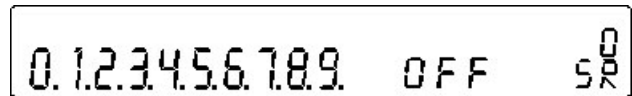

To switch BANK LINK ON press the **PASS** key, the legend changes from "OFF" to "ON". To accept the displayed bank link data press **ENTER**.

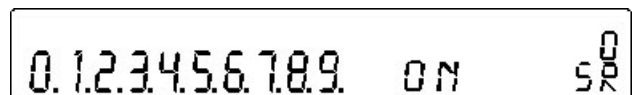

Next time the receiver is returned to PROGRAM SEARCH MODE, ALL banks containing data will be searched.

**Note:** The SEARCH BANK LINK / SETUP menu also provides access to four further parameters to customise the way in which program search operates. Please refer to section 12-13 of this manual for further information.

### Selecting different favourite bank link identifiers

The AR5000 will use the settings of whichever bank link identifier is displayed when the bank link menu is accessed by pressing **FUNC** **SRCH**, this equates to whichever was last set. Use the *SUB DIAL* to select the required identifier followed by the **ENTER** key to accept the changes.



### Deselecting linked banks

It is not necessary to deselect bank link identifiers if you wish to scan a single search bank, simply access the bank link menu and use the **PASS** key to switch **bank link** OFF followed by the **ENTER** key to accept the change.

## 12-11 Linking only a few search banks

When the BANK LINK menu has been selected “*0 N*” (as per section 12-10 of this manual), ALL search banks are linked. However, it is possible to de-select and re-select search banks and select just those you particularly wish to group together and search.

To LINK just three search banks, access the bank link menu by pressing **[FUNC]** **[SRCH]**, this may be carried out in SCAN mode, SEARCH mode or VFO mode.

The flashing legend “*5 R*” confirm selection of the search bank link menu. At default the dominant legend will be “*0 F F*” to indicate that SEARCH LINK is not active. Select the bank link PROFILE you require using the *SUB DIAL*.

Example, link banks 00, 03 & 12.

To select the desired banks to link press each corresponding numeric key

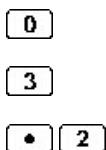

The corresponding bank identifiers will be displayed on the LCD (where frequency is normally displayed).

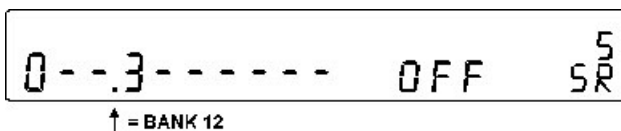

To switch BANK LINK ON press the **[PASS]** key, the legend changes from “*0 F F*” to “*0 N*”. To accept the displayed bank link data press **[ENTER]**



Next time the AR5000 is returned to SEARCH MODE, banks 00, 03 & 12 will be searched as a group (as long as they contain data).

## 12-12 Searching a bank which is *not* selected in BANK LINK

It is still possible to SEARCH a single deselected bank by manually bypassing the BANK LINK programming. To SEARCH *any* deselected bank simply rotate the *SUB DIAL* while searching until the desired search bank number is displayed on the top right of the LCD, alternatively key in the two digit bank identifier via the numeric keypad.

The AR5000 will search only the selected single unlinked bank over and over and will not attempt to search the group of banks as specified in BANK LINK.

*Alternatively you could switch bank link OFF or select a bank link profile where group programming has not been selected.*

To return to the GROUP selection, rotate the *SUB DIAL* until one of the desired search bank numbers is displayed.

## 12-13 Additional PROGRAM SEARCH facilities (introduction)

It is possible to alter the sequence of search events when in PROGRAM SEARCH mode depending upon the SEARCH CONFIGURATION as defined in the **BANK LINK / SETUP** sub menu. As with BANK LINK, 10 PROFILES of the additional facilities may be used (along side BANK LINK).

There are five parameters (in addition to BANK LINK) which may be changed to suit your preferences and requirements. The list of search defaults are:

Search type		Comment
PAUSE	OFF	OFF and 1 ~ 60 seconds
DELAY	2.0	OFF and 0.1 ~ 9.9 seconds
L-SQ	OFF	OFF and 1 ~ 255
VOICE	OFF	OFF and 1 ~ 255 (*)
A-STORE	OFF	OFF and ON

***It is possible to mix combinations of all five parameters.***

To access the additional facilities of **BANK LINK / SETUP** press **[FUNC]** **[SRCH]**. Initially the BANK LINK menu will be displayed, the **[UP]** and **[DOWN]** keys allow selection of the additional facilities as a carousel.

The *MAIN DIAL* and *SUB DIAL* may be rotated to change values on each menu. The **[PASS]** key selects OFF (and sometimes the default such as 2.0s, as in the DELAY menu). When you are happy with the changes press **[ENTER]** to accept the changes and the AR5000 will revert to SCAN, SEARCH or VFO mode depending upon which was previously in use.

**Note:** Make *small* changes and assess the effect as incorrect setting may degrade the effectiveness of SEARCH. If things appear to go wrong, return the settings to their defaults as listed earlier in this section.

*In extreme cases, reset the microprocessor (by switching the receiver on while holding the **[CLR]** key), this operation will revert the search options back to defaults (by deleting all bank link / setup programming).*

## 12-14 PROGRAM SEARCH - PAUSE

The search PAUSE parameter determines how long the AR5000 will remain on an **active** channel before resuming search.

This is useful if you wish to gain a picture of what is happening on a band without the receiver being tied to a busy frequency for long periods of time (such as when monitoring active amateur band repeaters etc).

PAUSE saves you having to manually intervene to force the search process to resume or the need to lockout frequencies using the FREQUENCY PASS facility.

The limits are OFF and 01 to 60 seconds (default OFF).

Press **[FUNC]** **[SRCH]** to access the BANK LINK menu. Use the **[UP]** **[DOWN]** keys to locate the "PAUSE OFF" selection.

```
PAUSE OFF <<<
DELAY 2.0
L-SQ OFF
VOICE OFF
R.STORE OFF
```

Either use the *MAIN DIAL* or *SUB DIAL* to change the value. The **[PASS]** key may be used as a short cut to OFF.



To accept the changes to PAUSE, press **[ENTER]** to return to a normal display (SCAN, SEARCH or VFO mode). Alternatively you may move to the next option (DELAY) by pressing the **[UP]** key.

While in PROGRAM SEARCH, the legend "PAUSE" will be displayed toward the right hand side of the LCD to indicate that PAUSE is in operation.



## 12-15 PROGRAM SEARCH - DELAY

The search DELAY parameter affects the time the AR5000 will remain on an active frequency in search mode once the received signal has disappeared and the squelch closed.

This is particularly useful for customising how long the receiver will wait for a reply before resuming search. For example, when communications are passed back and forth between a control tower / aircraft which may take a few seconds.

The limits are OFF and 0.1 to 9.9 seconds (default 2.0 seconds).

Press **[FUNC]** **[SRCH]** to access the BANK LINK menu. Use the **[UP]** **[DOWN]** keys to locate the "DELAY 2.0" selection.

```
PAUSE OFF
DELAY 2.0
L-SQ OFF
VOICE OFF
R.STORE OFF
```

Either use the *MAIN DIAL* or *SUB DIAL* to change the value. The **[PASS]** key may be used as a short cut toggle between OFF and the default of 2.0 seconds.



To accept the changes to DELAY, press **[ENTER]** to return to a normal display (SCAN, SEARCH or VFO mode). Alternatively you may move to the next option (LEVEL SQUELCH) by pressing the **[UP]** key.

## 12-16 PROGRAM SEARCH - LEVEL SQUELCH

The search LEVEL SQUELCH parameter causes the AR5000 to check the signal strength of **active** frequencies and to only stop when the signal strength is above a predetermined level (which is programmable in 256 steps).

The limits are OFF and 1 to 255 (default OFF).

Press **[FUNC]** **[SRCH]** to access the BANK LINK menu. Use the **[UP]** **[DOWN]** keys to locate the "L-SQ OFF" selection.

```
PAUSE OFF
DELAY 2.0
L-SQ OFF <<<
VOICE OFF
R.STORE OFF
```

Either use the *MAIN DIAL* or *SUB DIAL* to change the value. The **[PASS]** key may be used as a short cut to OFF. If the **[PASS]** is used to select OFF, use of the *MAIN DIAL* and *SUB DIAL* afterwards will result in the value continuing from whatever was last selected, this speeds up the selection process. In fact the **[PASS]** key may be used as a toggle between OFF and the new setting.

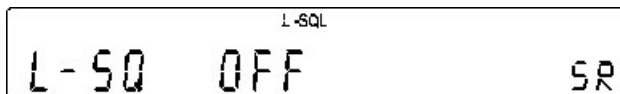

While in program search mode, the LCD legend "N-SQL" for noise squelch (normal operation) is replaced by the legend "L-SQL" to indicate that level squelch is in operation.



To accept the changes to LEVEL SQUELCH, press **[ENTER]** to return to a normal display (SCAN, SEARCH or VFO mode). Alternatively you may move to the next option (VOICE) by pressing the **[UP]** key.

**Note:** It is possible that false signal levels may upset the operation of search LEVEL SQUELCH due to local noise or the close proximity of computer systems.

A value of **1** instructs the AR5000 to react to very weak signal while a value of **255** instructs the receiver to react ONLY to strong signals. Experimentation will be necessary with different types of signal to find the best setting for



specific requirements... the lower level settings may not be usable when high noise is present.

## 12-17 PROGRAM SEARCH - VOICE

The search VOICE parameter determines the way in which an **active** frequency is determined by sampling the audio modulation. When the VOICE search facility is enabled, the search process will only stop on active channels which have modulation (such as voice) present. The AR5000 will not remain on unmodulated frequencies (such as blank carriers).

You may find this facility useful for skipping over STRONG signals but WEAKER noisy signals and transmissions with pilot tones or heterodynes present may **fool** the receiver into thinking that modulation is present. Experimentation will **certainly** be required with different types of signal.

The limits are OFF and 1 to 255 (default OFF).

Press **FUNC** **SRCH** to access the BANK LINK menu. Use the **UP** **DOWN** keys to locate the "VOICE OFF" selection.

```

PAUSE OFF
DELAY 2.0
L-SQ OFF
VOICE OFF <<<
A.STORE OFF
  
```

Either use the *MAIN DIAL* or *SUB DIAL* to change the value. The **PASS** key may be used as a short cut to OFF. If the **PASS** is used to select OFF, use of the *MAIN DIAL* and *SUB DIAL* afterwards will result in the value continuing from whatever was last selected, this speeds up the selection process. In fact the **PASS** key may be used as a toggle between OFF and the new setting.

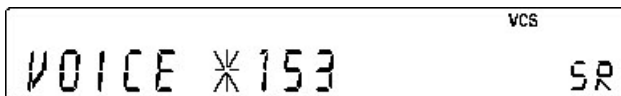

The LCD display shows "VOICE \* 153" with "VCS" at the top right and "SR" at the bottom right.

The legend "\*" positioned to the right of the word "VOICE" (to the left of the numeric value) indicates that the current audio will open the squelch, use the *SUB DIAL* to increase the value until the "\*" legend disappears, you can then be sure that the search voice setting will ignore and skip over the current frequency.

While in program search mode, the LCD legend "VCS" for voice squelch is displayed toward the top right hand side of the LCD to indicate that voice squelch is in operation.



The LCD display shows "134.750000 MHz" with "ANT? ATTD dB AMP" above it, "N-SQL AUTO" above "888", "VCS" above "SR", and "BANK" above "05".

To accept the changes to VOICE SQUELCH, press **ENTER** to return to a normal display (SCAN, SEARCH or VFO mode). Alternatively you may move to the next option (AUTO-STORE) by pressing the **UP** key.



## 12-18 Cyber Search

A special facility has been provided to speed up the search process (which is capable of searching about 25 frequencies per second), typically the speed increases to about 45 frequencies per second as long as the step size is set to 100 kHz or less.

When *Cyber Search* has been selected, both the frequency and text are blanked out from the display while searching, the words "CYBER SRCH" being displayed in their place. While searching, the legend "SR" is displayed on the extreme right of the display to indicate that search is in progress (exact position dependant on whether PROGRAM SEARCH, SIMPLE SEARCH or MANUAL SEARCH has been selected).



The LCD display shows "CYBER SRCH" with "N-SQL" above "888" and "BANK" above "05 SR".

When a busy channel is located, the FREQUENCY or TEXT will be displayed (taking the place of the *Cyber Search* legend), the "BUSY" legend indicates when an active frequency has been located.



The LCD display shows "BUSY" above "ANT? ATTD dB AMP", "134.750000 MHz" with "N-SQL AUTO" above "888", "BW" above "6K", and "BANK" above "05 SR".

A group of three digit numbers counting from "000" to "999" is displayed in the centre-right of the top row to indicate that the *Cyber Search* process is proceeding... the rolling numbers do not have any specific meaning, they are like the rolling drums of a fruit machine! If nothing were displayed to show that *Cyber Search* was in operation and no transmissions were encountered, the AR5000 may otherwise look like it was doing nothing.

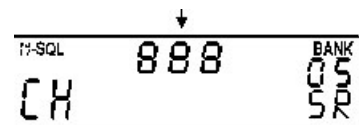

The LCD display shows "CH" with "N-SQL" above "888" and "BANK" above "05 SR".

To enable *Cyber Search* press **FUNC** then press and hold the **ENTER** key for more than one second... a bleep will then sound and the "FUNC" legend will be removed from the LCD to confirm operation. This key sequence acts as a toggle to switch *Cyber Search* on and off.

*Cyber Scan* and *Cyber Search* are selected using the same key sequence, the command being **global**, if *CYBER* status is changed in search mode, it will affect scan mode as well.

**Note:** If no text has been saved in the program search bank and TEXT mode has been selected rather than FREQUENCY, the display will be void of information when *Cyber Search* locates a busy channel !!

## 12-19 AUTO-STORE

The auto-store (A.STORE) facility enables the first 100 busy frequencies located during search to be automatically saved in memory bank "0" for later review and scanning. When shipped from the factory auto-store is switched OFF.

The first 100 **active** frequencies will be automatically stored into memory in ascending memory channel order from 000 ~ 099 until all 100 channels have been used. Active frequencies located after the 100th channel has been used will not be stored, this limitation is to prevent unnecessary writing to the EEPROM data store. Active frequencies located within 10 kHz of a previously stored frequency will not be stored... this is to prevent the same frequency from being saved over and over again.

When you first wish to use auto-store, it is best to delete the contents of memory bank "0" (where the search frequencies will be automatically saved to memory), in order to provide meaningful information.

### Deleting ALL channels from memory bank "0" before using AUTO-STORE

Ensure the AR5000 is in VFO or memory recall mode, if in doubt press **VFO**

To access the "DEL MEM-CH" menu, press **FUNC** then press and hold the **•** key for more than one second. Use the **UP** **DOWN** keys until the legend "DEL MEM-CH" is displayed.

```
DEL MEM-CH <<<
DEL SEL-CH
DEL M-PASS
DEL SRCH
DEL F-PASS
```

Use the **SUB DIAL** to select bank "0". The legend "\* \*" displayed under the bank number shows that this bank contains data and all channels have been selected for delete (the legend "- ." indicates that the memory bank does not contain data).

To erase the selected bank press **PASS**, after about two seconds the "\* \*" legend will change to "- ." to indicate that the contents have been deleted.

Press **ENTER** or **CLR** to return to SCAN or VFO mode depending on which one was previously in use.

### Starting AUTO-STORE

First turn the auto-store facility ON (default is OFF).

To access the auto-store On/Off menu, the **BANK LINK/SETUP** menu has to be used. Press **FUNC** **SRCH**, initially the BANK LINK menu is displayed. Use the **DOWN** key to locate the menu "A . S T O R E".



```
PAUSE OFF
DELAY 2.0
L-SQ OFF
VOICE OFF
A.STORE OFF <<<
```

The **PASS** key toggles between OFF and ON. Press **PASS** to select ON then press **ENTER** to accept the changes. The AR5000 will revert to SCAN, SEARCH or VFO mode depending upon which was previously in use.

Place the receiver into program search mode by pressing **SRCH** (manual search or simple search may also be used). Select any search bank containing data and allow the set to search and find **active** channels. Active frequencies will now be automatically written to memory bank "0" channels 000 ~ 099 in ascending order until all 100 have been used.

### Reviewing automatically stored memory channels

You may review the frequencies which have been written automatically to memory bank "0" by entering MEMORY RECALL MODE.

First place the AR5000 into memory recall mode by pressing the **SCAN** key once (unless it is in SCAN mode in which case you should press **VFO** followed by **SCAN**).

Select memory bank "0" by rotating the **SUB DIAL** or keying in the first memory location of bank "0" via the numeric keypad **0 0 0**. The **UP** **DOWN** keys or **MAIN DIAL** may be used to review the memory channel data.



### What to do with the automatically stored data

Once data has been stored, it may be deleted (as described earlier in this section), scanned by placing the AR5000 into scan mode then selecting bank "0" or MOVED to another memory location by recalling it to VFO-E (by pressing **ENTER**) and entering the data into another channel to form the basis of a useful data bank.

## (13) Frequency Pass

Frequency pass is different to channel pass (used to temporarily lock out unwanted memory channels) because frequency pass allows individual FREQUENCIES to be passed so they will be skipped over when in program search mode. This can be useful to remove blank carriers or unwanted signals from continually stopping the search process.

Each of the twenty search banks have 100 PASS frequencies plus 100 further for use in VFO mode (manual & simple search) making a total of 2100 pass frequencies.

Frequencies which have been registered as a pass frequency will not be received during a subsequent search.

All search banks are independent from each other. For this reason a frequency selected as PASS in one bank will not automatically be passed in another bank, it will only be skipped over in the bank in which it is registered.

**Note:** Any active frequency within  $\pm 10$  kHz of the passed frequency will be ignored so that all the pass channels do not have to be used up in one particular noisy part of a band, this must be noted when small steps sizes such as 50 Hz or 100 Hz are used for SSB and CW monitoring.

### 13-1 Register PASS Frequency

You can register any frequency as a PASS frequency when program search has stopped.

While search has stopped on a busy frequency press **PASS**, the displayed frequency will be instantly registered as a PASS frequency and the search will immediately resume.

If in VFO mode (or manual search or simple search) frequencies may also be registered as PASS by pressing the **PASS** key. In this instance the frequency will be added to the **VFO** pass list (as opposed to banks 00 ~ 19).

A beep will sound if all 100 PASS frequencies have already been registered on the bank in use indicating that no more frequencies may be passed.

### 13-2 Manually adding a PASS frequency using the PASS menu

It is possible to register pass frequencies using the pass menu. This is particularly useful for eliminating **known** troublesome blank carriers even before you start to search!

To access the pass menu, press and hold the **PASS** key for more than one second.

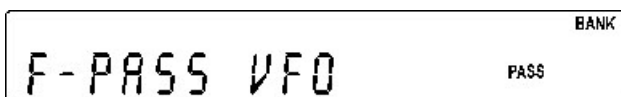

The legend "F-PASS" will be displayed with an identifying bank number or legend "VFO" to the right depending whether the receiver is currently in program search mode (in which case the current bank number will be displayed) or VFO (or manual search or simple search) mode.

Rotate the **SUB DIAL** to select the required bank number (00 ~ 19 or VFO).

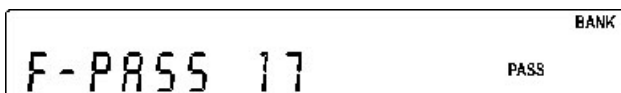

Press the **UP** key to enter **add/edit/delete** mode. The selected bank number will be displayed under the legend "BANK", if in VFO mode the bank number will be replaced by the letter "V".



If no pass channels are currently allocated for the selected bank, the legend "-----" will be displayed.



If pass frequencies have already been registered, pass channel numbers will have been automatically allocated starting at 00 through 99. The first pass channel will be displayed (with the legend "00" being displayed under the bank number).



Rotate the **SUB DIAL** to review the pass channels, the first available empty channel may be displayed ready to accept data input, the legend "-----" identifies the empty channel.

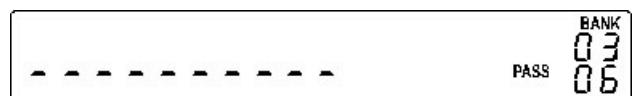

To register a new pass frequency, key in the desired frequency finishing in **kHz** or **ENTER**. i.e. **1** **2** **3** **ENTER** for 123 MHz.



Rotate the **SUB DIAL** to select the next empty pass channel and continue to build up the list of frequencies to be skipped.

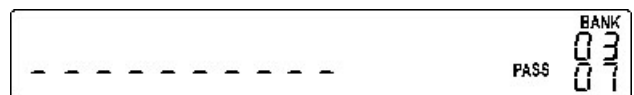

To select another bank press the **DOWN** key to return to the first menu and repeat the above process for another bank.



To accept the input and complete the process, press **ENTER** in either of the two menus.

**Notes:** You can enter a PASS frequency down to the 100kHz order only (as a PASS frequency is valid within a range of  $\pm 10$ kHz). The PASS frequency can be entered anywhere within The AR5000's receive range but it must be noted that the search rate will slow down if the pass frequency is entered outside of the selected program search range as the AR5000 microprocessor will need to check pass frequencies even if they are outside of the program search range. It is advisable not to enter pass frequencies outside of the selected program search range for this reason.

### 13-3 Editing pass frequencies

It is also possible edit the contents of the pass list once frequencies have been registered. This can be useful when reviewing the contents of the pass list, to allow changing of frequencies slightly or over-writing those not required when you have used all 100 and want to add another!

To access the pass menu, press and hold the **PASS** key for more than one second. The legend "F - P R S S" will be displayed with an identifying bank number or legend "V F O" to the right depending on whether the AR5000 is currently in program search mode (in which case the current bank number will be displayed) or VFO (or manual search or simple search) mode.

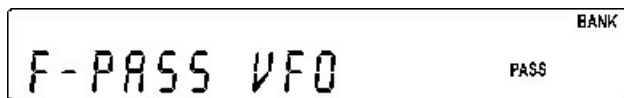

Rotate the *SUB DIAL* to select the required bank number (00 ~ 19 or VFO).

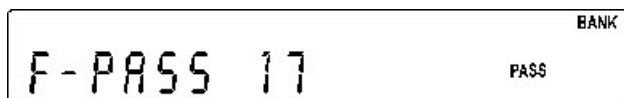

Press the **UP** key to enter *add/edit/delete* mode. The selected bank number will be displayed under the legend "BANK", if in VFO mode the bank number will be replaced by the letter "V".



If no pass channels are currently allocated for the selected bank, the legend "-----" will be displayed.



If pass frequencies have already been registered, pass channel numbers will have been automatically allocated starting at 00 through 99. The first pass channel will be

displayed with the legend "00" being displayed under the bank number.



Rotate the *SUB DIAL* to review the pass channels, the first available empty channel may also be displayed ready to accept data input, the legend "-----" identifies the empty channel.



To edit the frequency of a displayed pass channel simply key in a new frequency finishing in **kHz** or **ENTER**



i.e. **1 1 8 ENTER** for 118 MHz.



Rotate the *SUB DIAL* to continue the review / selection process. To select another bank press the **DOWN** key to return to the first menu and repeat the above process for another bank.



To accept the input and complete the process, press **ENTER** in either of the two menus.

### 13-4 Deleting individual pass frequencies

It is possible to delete individual pass channels as well as whole banks in one go. Individual pass channels are selected and deleted using the frequency pass menu.

To access the pass menu, press and hold the **PASS** key for more than one second. The legend "F - P R S S" will be displayed with an identifying bank number or legend "V F O" to the right depending on whether the receiver is currently in program search mode (in which case the current bank number will be displayed) or VFO (or manual search or simple search) mode.

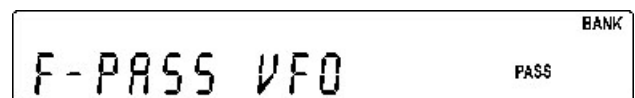
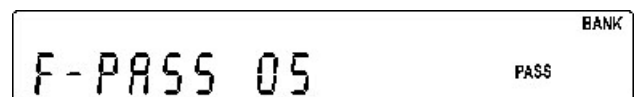

Rotate the *SUB DIAL* to select the required bank number (00 ~ 19 or VFO).

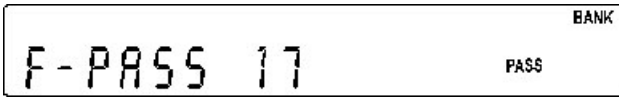

Press the **UP** key to enter *add/edit/delete mode*. The selected bank number will be displayed under the legend “**BANK**”, if in VFO mode the bank number will be replaced by the letter “**V**”. Rotate the *SUB DIAL* to review the pass channels.



To delete the frequency of a displayed pass channel press **PASS**. The pass channel will be deleted and the pass list will *shuffle down* to fill the gap created (unless the last channel is deleted in which case the “- - -” legend will be displayed to indicate that the channel (and bank) no longer contains data.

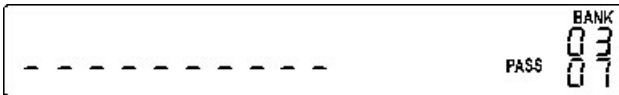

Rotate the *SUB DIAL* to continue the review / selection process. To select another bank press the **DOWN** key to return to the first menu and repeat the above process for another bank.

To accept the input and complete the process, press **ENTER** in either of the two menus.

### 13-5 Deleting complete banks of pass frequencies

Sometimes it is convenient to remove the frequency pass status of all channels in a search bank instead of reviewing and deleting them one-by-one (as described in section 13-4 of this manual)... especially if you have previously registered 100 pass frequencies in a bank.

Ensure the AR5000 is in VFO or memory recall mode, if in doubt press **VFO**.

To access the “**DEL F-PASS**” menu, press **FUNC** then press and hold the **•** key for more than one second. Use the **UP** **DOWN** keys until the legend “**DEL F-PASS**” is displayed.

```
DEL MEM-CH
DEL SEL-CH
DEL M-PASS
DEL SRCH
DEL F-PASS <<<
```

Use the *SUB DIAL* to select the bank containing the frequency pass channels you wish to delete (00 ~ 19 and “**V**”). The legend “\*\*” displayed under the bank identifier shows that the bank contains frequency pass channels which may be deleted, the legend “- -” indicates that the

search bank does not contain any frequency pass channels.

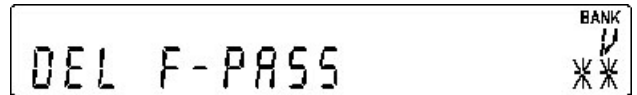

To delete all frequency pass channels of the selected bank press **PASS**, after about two seconds the “\*\*” legend will change to “- -” to indicate that all the pass frequencies have been deleted.

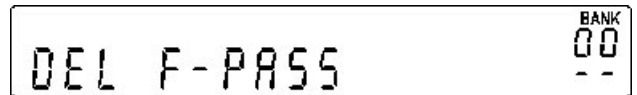

Press **ENTER** or **CLR** to return to SCAN or VFO mode depending on which one was previously in use.

## (14) Real time clock

The AR5000 is equipped with two independent real time clocks capable of either 12hr or 24hr format displaying hours, minutes and seconds. Each clock can also display a three character text comment which is useful for identification... UTC, EST, JST etc.

When the AR5000 is switched off but power still connected, the clock is displayed on the LCD (but without rear illumination).

The real time clocks are maintained by a SUPER CAPACITOR while power is disconnected from the receiver, this will maintain the correct time for up to approximately 50 hours. It will take a while for the capacitor to charge up so if only connected to power for a few minutes, the clocks will not be maintained for long. If the capacitor has depleted causing the clocks to stop, all display segments will momentarily illuminate during power-on of the AR5000 and the clocks will start counting from 00-00-00 hrs.

### 14-1 Displaying the clock

To display the real time clock, press **FUNC** **7**. The AR5000 will continue to monitor while the clock is displayed making it ideal for log keeping. The *SUB DIAL* is used to select **CLOCK 1** or **CLOCK 2**, the selection being identified by the legend “1” or “2” on the right hand side of the LCD.

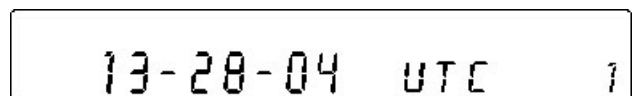

Pressing any key other than **POWER**, **CLR**, **FUNC** or using any control other than the *SUB DIAL* will result in removal of the clock from display and return to a conventional frequency / text readout.

## 14-2 Setting time

**Clock 1** and **clock 2** may display different hours and text but the minutes and seconds will be common to both clocks.

To set the initial real time, press **[FUNC]** then press and hold the **[7]** key for more than one second then follow the prompts.

### Initial Set

1 To access the clock set menu, press **[FUNC]** then press and hold the **[7]** key for more than one second. The settings for **Clock 1** are first displayed / entered followed by those for **clock 2**.

SELECT 24H

SELECT 12H

2 The menu prompts "SELECT 24H", rotate the **SUB DIAL** to select between 24hr "SELECT 24H" and 12hr "SELECT 12H" display. The selection of 12/24hrs affects BOTH clocks.

```
SELECT 24H / SELECT 12H <<<
6-23-16 1 / AM.6-23-16 1
TXT 1
4-23-30 2 / PM.4-23-30 2
TXT 2
```

3 Press the **[UP]** key to move on to time input (the **[DOWN]** key may be used during initial set to scroll backwards, press and hold for more than one second).

```
SELECT 24H / SELECT 12H
6-23-16 1 / AM.6-23-16 1 <<<
TXT 1
4-23-30 2 / PM.4-23-30 2
TXT 2
```

6-23-16 1

The legend "1" is displayed on the right hand side of the LCD to indicate that the setting of **clock 1** is in progress.

The **hours may be adjusted using the MAIN DIAL** and **minutes using the SUB DIAL**. As soon as the **MAIN DIAL** or **SUB DIAL** are used, the **seconds are frozen** to allow accurate time setting from a TIME STANDARD, the legend "- -" is displayed between hours, minutes and seconds to indicate that initial set is in progress.

4 Press the **[UP]** key to move on to TEXT.

```
SELECT 24H / SELECT 12H
6-23-16 1 / AM.6-23-16 1
TXT 1 <<<
4-23-30 2 / PM.4-23-30 2
TXT 2
```

. TXT 1

Use the **SUB DIAL** (and numeric keypad if you wish) to select the required three character text comment for **clock 1...** such as "UTC".

UTC. TXT 1

This is carried out in the same way as text input to memory or search banks, the **SUB DIAL** is rotated to select the required character and quick presses of the **[UP]** **[DOWN]** keys are used to change the text input position left / right.

5 Press and hold the **[UP]** key for more than one second to move onto the input selection for **clock 2**.

```
SELECT 24H / SELECT 12H
6-23-16 1 / AM.6-23-16 1
TXT 1
4-23-30 2 / PM.4-23-30 2 <<<
TXT 2
```

4-23-30 2

6 The legend "2" is displayed on the right hand side of the LCD to indicate that the setting of **clock 2** is in progress. The **hours may be adjusted using the MAIN DIAL or SUB DIAL** as the minutes and seconds are taken from **clock 1**. At this point the seconds are frozen to allow accurate time setting, the legend "- -" is displayed between hours, minutes and seconds to indicate that initial set is still in progress.

7 Press the **[UP]** key to move on to TEXT.

```
SELECT 24H / SELECT 12H
6-23-16 1 / AM.6-23-16 1
TXT 1
4-23-30 2 / PM.4-23-30 2
TXT 2 <<<
```

Use the **SUB DIAL** (and numeric keypad if you wish) to select the required three character text comment for **clock 2...** such as "EST".

EST. TXT 2

8 Pressing **[ENTER]** at this time will commit the input data and start the seconds counting. However for accurate setting, display **clock 1** again. Press and hold the **[UP]** key for more than one second to scroll passed "SELECT 24H" then press the **[UP]** key again for more than one second to display **clock 1**.

```

SELECT 24H / SELECT 12H
6-25-00 1 / AM.6-25-00 1 <<<
TXT 1
4-23-30 2 / PM.4-23-30 2
TXT 2

```

6-25-00 1

9 When referring to a time standard (or accurate watch!), press the **ENTER** key to accept input and start the seconds counting.

6-25-01 1

To check the settings, have a look at the clocks by pressing **FUNC** **7** as in section 14-1 of this manual.

**Note:** At any point when you feel the data input is complete (perhaps you only wish to set one clock) press **ENTER** to accept the data changes and start the seconds counting. At any time you may abort input by pressing **CLR**

### Daylight saving (clock 2 only)

On occasion you may not wish to completely change the clock data but only adjust the HOURS, perhaps in areas where daylight saving is used where one or two hours are added to / removed from the local clock time once per year... on the other hand you may move between time zones while travelling.

As only the hours of **clock 2** may be set (minutes & seconds cannot be adjusted), it is ideal for use as the daylight saving clock.

1 Press **ENTER** then press and hold the **7** key for more than one second to access the clock initial set menu.

2 Press the **DOWN** key to move to the TEXT input of **clock 2** then press and hold the **DOWN** key for more than one second to access the time set menu for **clock 2**.

3 Use the **MAIN DIAL** or **SUB DIAL** to alter the hours as required, the minutes and seconds will continue to increment so will not be affected by changes to the hours.

4 Press the **ENTER** key to accept the changes and return to a conventional frequency / text display.

### 14-3 Alarm clock

The AR5000 provides an alarm facility based on **CLOCK 1**. The receiver may be programmed to switch-on at a specific time on a daily basis in either BEEP or RADIO modes.

### Alarm BEEP

During ALARM BEEP mode, the AR5000 will power-up at the pre-set time causing the beep sounder to activate (repeated three beeps) at the pre-set volume level. This is useful as an (*expensive!*) alarm clock when you don't want to miss an important broadcast or event.

### Alarm RADIO

In ALARM RADIO mode, the **last used frequency** will be present at automatic switch-on and the LENGTH of activity may be programmed before the AR5000 switches off again. This is useful for making unattended recordings off-air.

### 14-4 ALARM programming

Before the alarm can be used, the parameters have to be specified. An ALARM SETUP menu is provided for input of data. You may escape from the menu at any time by pressing the **CLR** key.

1 To access the alarm menu, press **FUNC** then press and hold the **B** key for more than one second. The menu "ALARM 0-00" or "ALARM AM. 12-00" will be displayed depending upon whether 24hr or 12hr format has been set in **CLOCK 1**.

```

>>> ALARM 0-00
ALARM LENGTH 15
ALARM ALM RADIO/ALARM ALM BEEP
ALARM VOLUME 80

```

ALARM  
0-00

2 Rotate the **MAIN DIAL** to set the HOUR for automatic switch-on, the **SUB DIAL** is used to select the MINUTES. Switch-on will occur (if the ALARM facility is activated) when **CLOCK 1** reaches the time set here.

```

>>> ALARM 0-00
ALARM LENGTH 15
ALARM ALM RADIO/ALARM ALM BEEP
ALARM VOLUME 80

```

ALARM  
6-45

If you have simply selected a new switch-on time with all other parameters remaining the same press **ENTER** to skip the rest of the menu.

3 Press the **UP** key to move onto the selection of LENGTH, the legend "LENGTH" will flash on the LCD.

```

ALARM 0-00
>>> ALARM LENGTH 15
ALARM ALM RADIO/ALARM ALM BEEP
ALARM VOLUME 80

```

Rotate the *MAIN DIAL* or *SUB DIAL* to select how long (in minutes) the ALARM or RADIO will stay powered-on once the alarm has activated. The available time period is 1 to 120 minutes and default is 15.

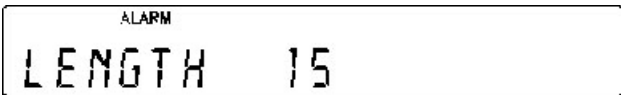

If you have selected a new LENGTH period with all other parameters remaining the same press **ENTER** to skip the rest of the menu.

4 Press the **UP** key to move onto the selection of BEEP/RADIO, the legend "ALM" will flash on the LCD.

```
ALARM 0-00
ALARM LENGTH 15
>>> ALARM ALM RADIO/ALARM ALM BEEP
ALARM VOLUME 80
```

Rotate the *SUB DIAL* to select between "BEEP" and "RADIO".



If you have selected a new parameter here with all other parameters remaining the same press **ENTER** to skip the rest of the menu.

5 Press the **UP** key to move onto the VOLUME setting, the legend "VOLUME" will flash on the LCD.

```
ALARM 0-00
ALARM LENGTH 15
ALARM ALM RADIO/ALARM ALM BEEP
>>> ALARM VOLUME 80
```

Rotate the *SUB DIAL* to select the volume level for BEEP and RADIO during alarm activation. The available range is 0 to 255 with 0 being the quietest and 255 the loudest, the default is 80.



The value zero "0" is provided so that *silent* automatic tape recording may be accomplished by use of the alarm facility.

It is a good idea to set the volume for this menu while listening to an active transmission as the front panel volume control is by-passed allowing assessment of the switch-on level... this prevents loud surprises during the early hours of the morning! During automatic switch-on the front panel volume control setting will be ignored and the level set here used.

**Note:** An audible low level noise may be heard while rotating the *SUB DIAL* in this menu with a *click* while passing 0, this is normal.

6 After selecting appropriate parameters press **ENTER** to complete data entry and return to the normal frequency / text display.

The "ALARM" legend will be displayed to the left of centre on the top line of the LCD to indicate that ALARM has been set.

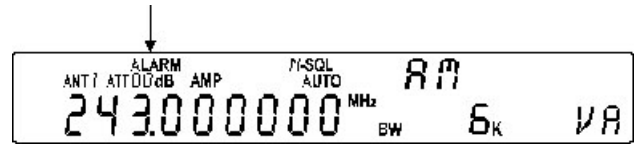

The alarm is always activated when exiting the alarm programming menu using the **ENTER** key. If you do not wish the alarm to be activated press **FUNC B**.

### 14-5 ALARM activation

Once the alarm has been activated the "ALARM" legend will be displayed on the top line of the LCD. The AR5000 will switch-on automatically once per day (presuming the receiver had been switched off) on a daily basis at the defined volume level and for the programmed length of time before automatically switching off again until the same time following day.

- 1 To toggle the alarm facility On/Off press **FUNC B**. The legend "ALARM" indicates when the facility is active. Note that the **FUNC B** key must only be momentarily pressed or the alarm programming menu will be activated.
- 2 Switch the AR5000 off by pressing the **POWER** key.
- 3 When the pre-set time has arrived, either the BEEP will sound or the RADIO will automatically switch-on (on whatever receive frequency was last used).
- 4 Press *any key* to stop the alarm when automatic switch-on has occurred. The receiver will remain active and normal control returned to the receiver's front panel.
- 5 To switch the alarm facility off press **FUNC B**. The legend "ALARM" will be removed from the LCD.

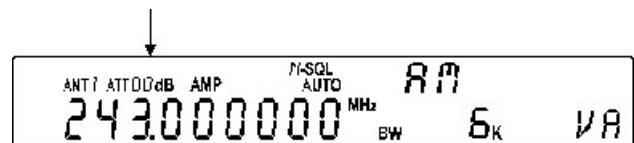

### 14-6 SLEEP timer

The AR5000 has a sleep facility where the receiver may be programmed to switch off after a pre-set time. This is useful if the AR5000 is used as a bedside receiver at night time or when left recording a broadcast when you have to urgently leave the building and don't want to miss something important.



## SLEEP Programming

To set how long the AR5000 will remain active before automatic switch off (you may abort entry by pressing the **CLR** key):

- 1 Press the **FUNC** key then press and hold the **9** key for more than one second.

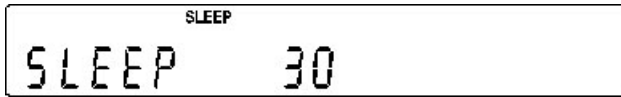

2 "S L E E P" legends flash on the LCD prompting for input of sleep time. The *MAIN DIAL* or *SUB DIAL* may be rotated to make selection between 1 and 120 minutes, the default being 30 minutes.

- 3 Press **ENTER** key to complete data entry and return to the normal frequency / text display.

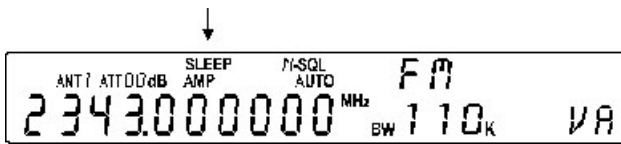

4 The "SLEEP" legend will be displayed in the centre top of the LCD to indicate that SLEEP has been set. The sleep facility is always activated when exiting the sleep programming menu using the **ENTER** key. If you do not wish the sleep timer to activate now press **FUNC** **9**

If left active, the AR5000 will automatically switch off after the sleep time duration has expired.

## SLEEP activation On/Off

To toggle the SLEEP facility On/Off press **FUNC** **9**. The "SLEEP" legend will be displayed on the top line of the LCD when sleep facility is active. Note that the **9** key must only be momentarily pressed or the sleep setup menu will be activated.

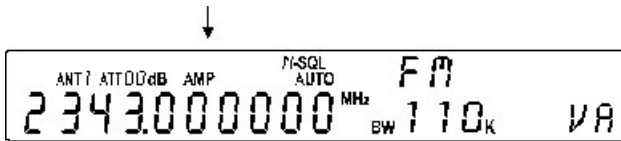

When the sleep time has elapsed the AR5000 will automatically switch off.

Downloaded by   
Amateur Radio Directory   
  
[www.hamdirectory.info](http://www.hamdirectory.info)

## (15) Option - Descrambler (voice inverter) - DS8000

An optional voice inversion unit may be fitted to the AR5000 to enable decoding of certain types of analogue scrambling (such as some cordless phones). Such a board is not produced by AOR but the receiver has been designed to accept the DS8000 - available from dealers in some countries.

### 15-1 Descrambler installation

Only the upper case of the AR5000 needs to be removed when installing the optional DS8000 board. Switch the receiver off and unplug the power cord.

- 1 In order to lift the upper case, *carefully* (with the correct fitting posi-drive screwdriver) remove the 4 screws from the top cabinet and the 3 screws from each side panel (the screws on the side of the unit toward the front are larger than the rest). The rear edge of the top cabinet has a flange and the sides have two unused holes (for mobile mounting).

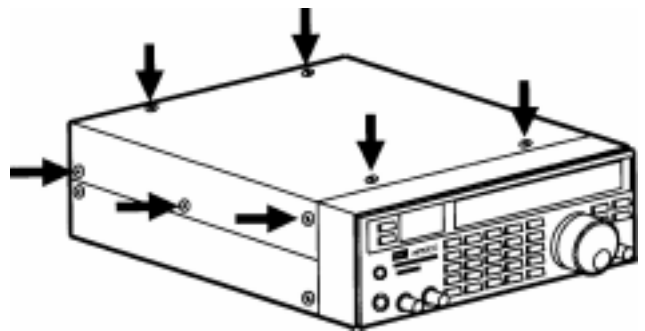

- 2 Locate connector J10 in the middle of the IF printed circuit board (see illustration) and insert the DS8000 making sure the pins mate correctly.

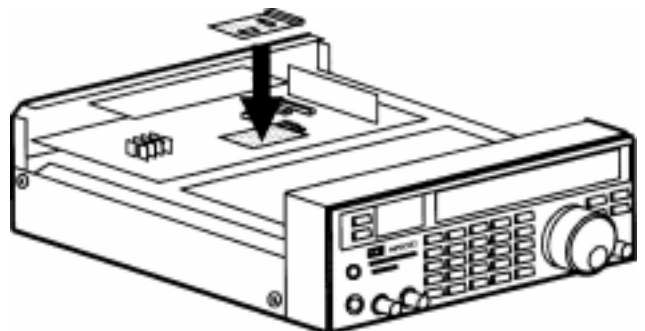

- 3 Refit the upper case... you may wish to do this once you have established that the board is operating correctly!
- 4 The DS8000 must be REGISTERED in the receiver's configuration before it will appear on the OPTION MENU and be used. Plug in the power cord and ensure that the supply is connected and active.

Assuming that power is connected to the AR5000 and the power switch is currently OFF, **press and hold** **[1]** **key then power up the receiver by pressing and releasing the** **[POWER]** **switch while still holding the** **[1]** **key.** Now release the **[1]** key. The “**D E - 5 C R**” descrambler will now be added to the **OPTION** menu as the first item accessed by pressing **[FUNC] [0]**

## 15-2 Descrambler operation

Of course you first need to find a transmission which has been scrambled by frequency inversion! Assuming that you have located such a transmission, optimum intelligibility is obtained through an LCD indication which varies between 0 and 127.

**1** To access the descrambler menu press **[FUNC] [0]**. The LCD legend “**D E - 5 C R**” confirms selection.

```

DE-SCR OFF <<<
CTCSS OFF (if CT5000 option is fitted)
DTMF OFF
T-ELMT OFF

```

The **MAIN DIAL** or **SUB DIAL** are used to make selection for optimum reception through the range 1 to 127 and OFF. The **[PASS]** key may be used to short cut the selection between current value and OFF.

**2** Rotate the **MAIN DIAL** or **SUB DIAL** until the audio (voice) becomes intelligible. Press **[PASS]** to increment OFF and ON (at the previously selected level).

**3** Press **[ENTER]** to accept the displayed value.

**4** To toggle the current selection ON/OFF press **[FUNC] [0]** (select the **DESCRAMBLE** menu) **[PASS] [ENTER]**

**Note:** If the optional DS8000 is not fitted, the above procedure will result in no audio being produced. Not all decrambler units are designed to work with the AR5000. Consult with your dealer if you have any doubts regarding suitability.

## (16) Option - CTCSS tone squelch - CT5000

The optional CT5000 tone squelch unit will enable the AR5000 to selectively receive only specifically modulated CTCSS signals or to verify the CTCSS frequency used. Operation is split into two sections **SEARCH** (16-3) and **SQUELCH** (16-4).

CTCSS tones use very low audio frequencies so cannot easily be heard, they are designed to fall below the audio bandwidth of the receiver so do not cause an annoyance to the recipient. If you want any chance of hearing the tones, use a large external speaker or headphones and carefully set the (AF.SET) audio settings... refer to section 6-11 of this manual.

**To increase versatility different CTCSS tones may be programmed into each memory and VFO.**

Available CTCSS frequencies are (Hz):

First group	Second group	Third group
	67.0 *	69.4 **
	71.9 *	
	74.4 *	
	77.0 *	
	79.7 *	
	82.5 *	
	85.4 *	
	88.5 *	
	91.5 *	
94.8	97.4 *	
100.0		
103.5		
107.2		
110.9		
114.8		
118.8		
123.0		
127.3		
131.9		
136.5		
141.3		
146.2		
151.4		
156.7		
162.2		159.8 **
167.9		165.5 **
173.8		171.3 **
179.9		177.3 **
186.2		183.5 **
192.8		189.9 **
203.5		196.6 **
210.7		199.5 **
218.1		
225.7		
233.7		206.5 **
241.8		
250.3		
		229.1 **
		254.1 **

## 16-1 Installation of the CT5000

Only the upper case of the AR5000 needs to be removed when installing the optional CT5000 board. Switch the receiver off and unplug the power cord.

1 In order to lift the upper case, **carefully** (with the correct fitting posi-drive screwdriver) remove the 4 screws from the top cabinet and the 3 screws from each side panel (the screws on the side of the unit toward the front are larger than the rest). The rear edge of the top cabinet has a flange and the sides have two unused holes (for mobile mounting).

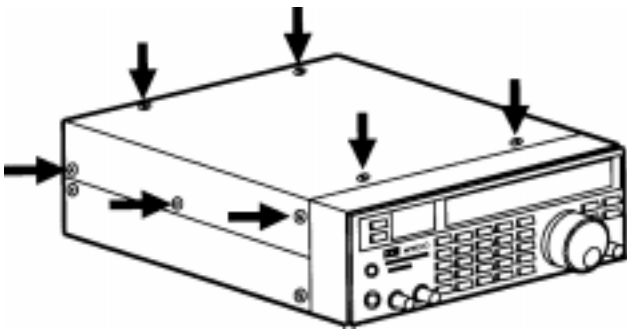

2 Locate connector IC31 on the rear-right hand side of the printed circuit board (see illustration) and insert the CT5000 making sure the pins mate correctly. Ensure that the board is inserted with the crystal resonator and electrolytic capacitor facing the right hand edge of the unit and the surface mount components facing IC27.

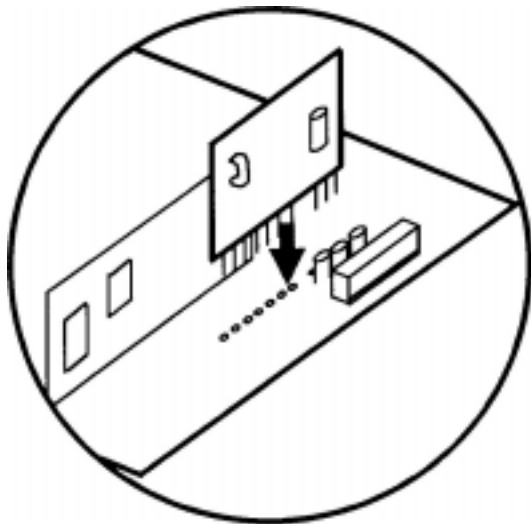

3 Refit the upper case... you may wish to do this once you have established that the board is operating correctly!

4 The CT5000 must be REGISTERED in the receiver's configuration before it will appear on the OPTION MENU and be used. Plug in the power cord and ensure that the supply is connected and active.

Assuming that power is connected to the AR5000 and the power switch is currently OFF, **press and hold** **[2]**

**key then power up the receiver by pressing and releasing the** **[POWER]** **switch while still holding the** **[2]** **key.** Now release the **[2]** key. The "CTC55" tone squelch will now be added to the OPTION menu as the first item accessed by pressing **[FUNC]** **[0]** (unless the descrambler option is fitted in which case it will be the second item in the list).

## 16-2 Operation of the CT5000 - overview

Of course you first need to find a transmission which is using CTCSS tones! Assuming that you have located such a transmission... there are two ways in which CTCSS may be used, **SEARCH** and **SQUELCH**.

**SEARCH:** Hunt for the CTCSS tones being used. The **flashing** LCD legend "TONE" indicates that CTCSS frequency search is in operation.

**SQUELCH:** Selectively monitor only those transmissions using specific CTCSS tones. The **static** legend "TONE" on the top line of the LCD indicates that CTCSS tone squelch is in operation.

## 16-3 CTCSS SEARCH

This facility enables you to automatically search and locate any signals which carry the particular CTCSS frequency of your interest.

1 To access the CTCSS menu press **[FUNC]** **[0]**. Use the **[UP]** **[DOWN]** keys to access the CTCSS menu, the LCD legend "CTC55" confirms selection.

```
DE-SCR OFF (if DS8000 option is fitted)
CTCSS OFF <<<
DTMF OFF
T-ELMT OFF
```

2 The **SUB DIAL** is used to make selection of CTCSS operation "OFF", "ON" or "SEARCH". Rotate the **SUB DIAL** to **select** "SEARCH" for CTCSS SEARCH.

3 Press **[ENTER]** to accept the displayed input and initiate CTCSS SEARCH (or to abort entry press **[CLR]**). The **flashing** legend "TONE" on the top line of the LCD confirms selection of CTCSS SEARCH.

4 To toggle the current selection ON/OFF press **[FUNC]** **[0]** (select the CTCSS menu) **[PASS]** **[ENTER]**

It may take up to 15 seconds to locate the CTCSS tone of a received signal. Short burst of transmission (less than 15 seconds) may not allow sufficient time for the CTCSS frequency to be identified.

When a CTCSS frequency is located, the receive frequency is replaced by the word "CTC55" with the CTCSS frequency displayed to the right. Press **[FUNC]** **[ENTER]** to return to the normal frequency/text display.

**Note:** When the CTCSS search is active it is not possible to toggle the frequency display and text display. If the optional CT5000 board is not fitted the above procedure will result in no audio being produced.

## 16-4 CTCSS SQUELCH

The CTCSS tone squelch facility assumes that you either know the frequency required or you have already used the CTCSS SEARCH facility to identify the required tones for specific transmissions.

**When this facility is engaged only the selected CTCSS modulated signals can be received.** No audio will be heard from other transmissions even if the radio has received a strong signal (which does not carry the selected CTCSS frequency).

1 To access the CTCSS menu press **FUNC** **0**. Use the **UP** **DOWN** keys to access the CTCSS menu, the LCD legend "CTC5" confirms selection.

```
DE-SCR OFF (if DS8000 option is fitted)
CTCSS OFF <<<
DTMF OFF
T-ELMT OFF
```

2 The **SUB DIAL** is used to make selection of CTCSS operation "OFF", "ON" or "SRCH". Rotate the **SUB DIAL** to select "ON".

3 Press the **UP** key to advance to the **tone select menu**.

4 The **MAIN DIAL** or **SUB DIAL** may be used to select the required CTCSS frequency, frequencies ascend in three popular groupings then loop back to the beginning (refer to the CTCSS frequency table at the beginning of this section).

5 Press **ENTER** to accept the displayed value (or to abort entry press **CLR**). The legend "TONE" on the top line of the LCD confirms selection of CTCSS tone squelch.

When transmissions are encountered containing the selected CTCSS frequency, normal reception will be established with the squelch opening and closing in the normal manner.

6 To toggle the current selection ON/OFF press **FUNC** **0** (select the CTCSS menu) **PASS** **ENTER**

**Note:** If the optional CT5000 board is not fitted the above procedure will result in no audio being produced.

## (17) Optional I.F. filters (500 Hz, 2.5 kHz & 5.5 kHz)

It is possible to add an additional (optional) high quality 500 Hz seven resonator Collins mechanical filter for improved selectivity when monitoring CW and other data modes. Optional eight resonator Collins mechanical filters may also be used in place of the standard fitted 2.4 kHz (3.0 kHz) and 9.0 kHz (5.5 kHz) filters.

500 Hz	MF500	Collins 526-8693-010
2.5 kHz	MF2.5	Collins 526-8694-010
5.5 kHz	MF6.0	Collins 526-8695-010

### 17-1 Fitting the optional 500 Hz filter

Only the upper case of the AR5000 needs to be removed when installing optional filters. Switch the receiver off and unplug the power cord.

1 In order to lift the upper case, **carefully** (with the correct fitting posi-drive screwdriver) remove the 4 screws from the top cabinet and the 3 screws from each side panel (the screws on the side of the unit toward the front are larger than the rest). The rear edge of the top cabinet has a flange and the sides have two unused holes (for mobile mounting).

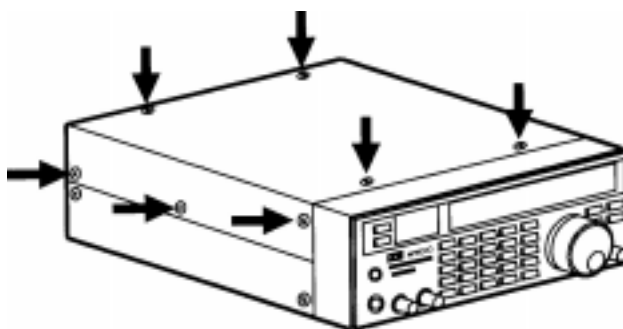

2 On the top-rear-most PCB (I.F. board), disconnect the IF OUT connector J8 (PCB side) from the socket on the rear-left of this board and remove the six board fixing screws.

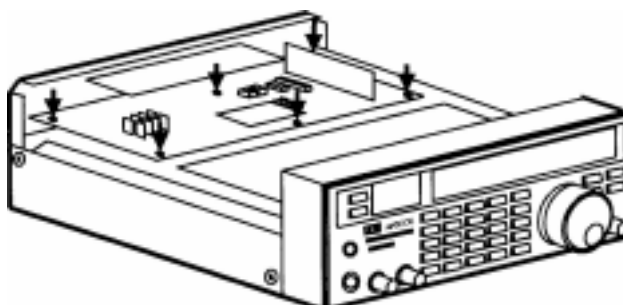

3 Pull the PCB towards the front panel and lift it as shown in the diagram.

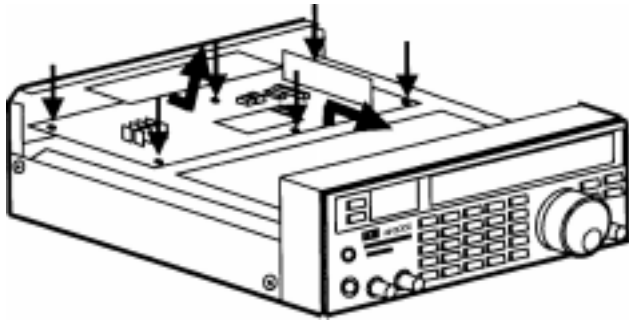

4 Locate position **MF1** on the I.F. PCB (refer to illustration). The position is currently unoccupied ready for the optional 500 Hz Collins mechanical filter. Use a desoldering pump to remove any excess solder from the respective pin positions. Insert the CW filter into the cleared holes of the PCB and securely solder its pins - don't overheat the filter!

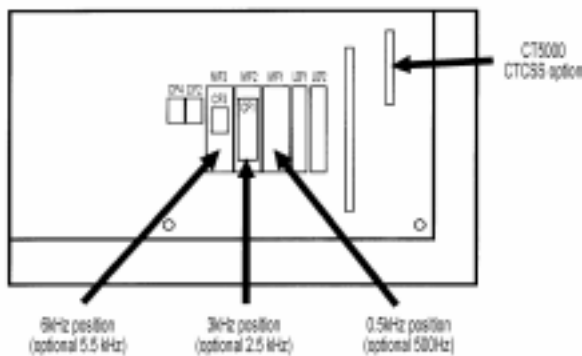

5 Refit the I.F. PCB making sure that all six screws have been refitted.

6 Refit the upper case... you may wish to do this once you have established that the filter is operating correctly!

7 The optional 500 Hz filter must be REGISTERED in the receiver's configuration before it will appear on the IF bandwidth display and be used. Plug in the power cord and ensure that the supply is connected and active.

Assuming that power is connected to the AR5000 and the power switch is currently OFF, **press and hold** **[3]** **key then power up the receiver by pressing and releasing the** **[POWER]** **switch while still holding the** **[3]** **key.** Now release the **[3]** key. The 0.5 kHz (500 Hz) bandwidth will now be available for use.

## 17-2 Installation of other filters

Consult your AOR dealer if you wish to install other filters such as 2.5 kHz and 5.5 kHz. To add these substitute filters, the standard ceramic filters must be replaced, this requires good quality tools and technical skill. *Use of an electric desoldering pump and professional grade soldering iron is highly recommended.*

Never try to remove the **standard fitted** ceramic filters by force, such an attempt may damage the printed circuit board (high quality multiple layers) invalidating the warranty.

**Note:** The LCD legends will still display 3.0 kHz and 6.0 kHz even when substitute 2.5 kHz and 5.5 kHz Collins optional filters have been fitted.

1 In order to lift the upper case, **carefully** (with the correct fitting posi-drive screwdriver) remove the 4 screws from the top cabinet and the 3 screws from each side panel (the screws on the side of the unit toward the front are larger than the rest). The rear edge of the top cabinet has a flange and the sides have two unused holes (for mobile mounting).

2 On the top-rear-most PCB (I.F. board), disconnect the IF OUT connector J8 (PCB side) from the socket on the rear-left of this board and remove the six board fixing screws.

3 Pull the PCB towards the front panel and lift it as shown in the diagram.

4 Remove the standard fitted filter:

**CF1** 2.4 kHz ceramic filter (front panel legend 3.0 kHz) from position **MF2** to fit the 2.5 kHz optional Collins mechanical filter.

**CF3** 9.0 kHz ceramic filter (front panel legend 6.0 kHz) from position **MF3** to fit the 5.5 kHz optional Collins mechanical filter.

**Note:** CF2 & CF4 cannot be replaced.

5 Locate the pin holes designed to accept the Collins Mechanical filter, and remove excess solder contents from the holes by using a desoldering pump.

6 Insert the optional filter into the cleared holes of the PCB and securely solder its pins - don't overheat the filter!

7 Locate the unused component pads close to the newly soldered filter pins (on the underside of the PCB). Two ZERO OHM resistors (or wire jump leads) have to be soldered to form a bridge linking the pads together (resistors not supplied).

8 Refit the upper case... you may wish to do this once you have established that the filter is operating correctly!

Nothing further is required.

## (18) Trouble shooting - microprocessor reset

Should the AR5000 fail to operate correctly, refer to the following instructions before contacting your AOR dealer for support.

- **Memory / search bank corruption**  
18-1, 18-2, 18-3
- **Set will not respond**  
18-1, 18-2, 18-3
- **PLL ERROR displayed**  
18-1, 18-2, 18-3
- **POWER switch does not respond**  
18-1, 18-2, 18-3
- **No audio output**  
18-1, 18-4, 18-2, 18-3

The AR5000 may become inoperative on one or two specific memory, scan or search banks if the data within the EEPROM (memory storage) becomes corrupted (power supply transients, static discharge etc). If this happens, erase the affected memory channel or search bank contents and rewrite the correct data. Usually this will clear any minor corruption of this kind.

### 18-1 Power Off / On

The first thing to try is switching the set off and disconnecting the power cord for about one minute. Reconnect the power cord, switch the set on and assess the results. If possible check the power lead for output of 12 - 16V d.c.

Press and hold the **MODE** key for more than one second to ensure that automode has been selected, check that the volume control has been advanced (12 o'clock position), the squelch is set correctly (if in doubt rotate the squelch control fully anti-clockwise) and that an appropriate aerial is connected to the displayed aerial connector "ANT 1" or "ANT 2". Ensure that LEVEL squelch, VOICE squelch, CTCSS squelch etc are not inappropriately set.

Ensure that the DESCRAMBLER, CTCSS and 500 Hz filter options have not been selected if the boards and filter have not been fitted.

If you have activated the MUTE connector, ensure that there is a shorting plug in place.

### 18-2 CPU reset switch

If switching the set off / on does not help, the next action should be to reset the receiver using the hidden reset switch provided.

The reset switch is located behind the torque lever to the right of the **MAIN DIAL**.

1 Move the lever to the downward position, a black cloth material covers the slot. The reset switch is located at the top of the slot about 10mm behind the front panel.

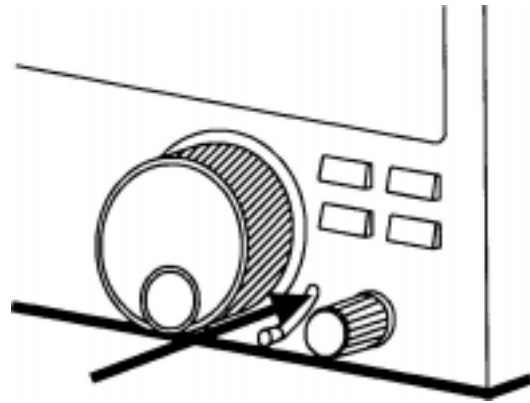

2 Using a match stick or similar **tool**, press and release the reset switch (with the AR5000 switched on and powered in the normal manner).

3 The back light will extinguish then all LCD characters will be displayed, the set will then power up and resume normal operation (if it has not automatically switched on again press the **POWER** switch).

This will re-boot the CPU without erasing the search/memory contents or going back to the default setting. The last entered frequency in VFO may be lost.

### 18-3 CPU soft reset

If the reset switch does not help, it is possible to SOFT RESET the AR5000 CPU. This will clear all bank link information and reset the VFO to default parameters including frequency display of 128.900 MHz.

1 Switch the receiver off (unplug the power cord if necessary to power-down the receiver).

2 Press and hold the **CLR** key while switching on the receiver once again, keep hold of the **CLR** key.

3 The clock will be displayed, wait for the default frequency / text display to appear then release the **CLR** key.

The defaults are:

Frequency	128.900 MHz
Receive mode	AM
Tuning step	25 kHz
IFBW	6.0 kHz
Attenuator	00 dB

## 18-4 AF.SET INT/EXT

The AR5000 may have become confused about the status of AUDIO INTERNAL / EXTERNAL. Reaffirm the setup.

1 Press **FUNC** **MODE** to access the audio setup menu.

```
R-LPF 3.0 kHz
R-HPF 0.05 kHz
DEEMP 750
CW.PITCH 0.7 kHz
AUDIO INT <<<
```

2 Press the **DOWN** key to access the INT/EXT menu.

3 Rotate the *SUB DIAL* so that "EX T" is displayed then rotate it again so that "I N T" is displayed again... do this even if "I N T" is displayed when the menu is accessed... YOU know it is set to INT, the LCD knows that it is set to INT but the heart of the CPU may not!

4 Press **ENTER** to reaffirm the data input.

## 18-5 What next - dealer support

If any apparent fault symptom repeatedly occurs contact your AOR dealer for advice, have the serial number and date of purchase to hand. Ensure that you can provide a detailed description of the fault condition.

**Note:** The AR5000 is equipped with a Super Capacitor (large capacity capacitor) to back up the clock. This enables the built-in clock to be kept running even when the set is disconnected from power, all other memory data is stored within the EEPROM which is not affected by depletion of the back-up capacitor. The clock should be maintained for approximately 50 hours without supply, if the set is left disconnected for longer than 50 hours make sure the clock is keeping the correct time, this can be noted as the LCD segments will light up momentarily when the set is connected to the mains.

## 18-6 Power-up special key sequences

There are several power-on key sequences referred to in this manual. A list is presented here. To activate, switch the receiver off, press and hold the specified key then switch the receiver back on. Release the specified key.

**Power-On** **ENTER**

LCD test. All LCD segments will be displayed. Press the **POWER** key to restore normal operation.

**Power-On** **kHz**

LCD test. Same as power-on **ENTER**

**Power-On** **1**

Add descrambler entry to the option menu after fitting the optional DS8000 board.

**Power-On** **2**

Add CTCSS entry to the option menu after fitting the optional CT5000 board.

**Power-On** **3**

Add 0.5 kHz (500 Hz) IFBW entry to the IFBW menu after fitting the optional 500 Hz Collins mechanical CW filter.

**Power-On** **SRCH**

EEPROM bank 0 selection. A decimal point at the 1 Hz position extinguishes. Not used on current unit.

**Power-On** **SCAN**

EEPROM bank 1 selection. A decimal point is added at the 1 Hz position. Not used on current unit.

## (19) Optional accessories

### DA3000 VHF-UHF discone aerial

16 element VHF - UHF discone aerial with usable coverage of 25 MHz to 2000 MHz. Supplied with cable and connectors etc.



### WA7000 wide band active whip aerial

Compact aerial designed for installation where space is a problem. The WA7000 is active in the lower frequency band 30kHz to 30MHz and passive on the higher band between 30MHz to 2000MHz. Supplied with cable and connectors etc.

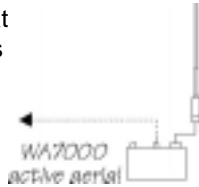

### MA500 mobile aerial

Compact VHF/UHF loaded whip on a magnetic mount with coaxial cable.

### LA320 loop aerial

Desktop active loop aerial for portable operation away from a base aerial such as when while travelling on business or holiday. Frequency coverage is 1.6 to 15MHz with optional elements to cover 0.2 to 0.54MHz and 0.54 to 1.6MHz.



### ABF125 RF filter

VHF civil airband filter to reduce the chances of breakthrough especially from powerful VHF band-II transmitters.

### CR5000 tape record cable

Cable and connector suitable for use with motor-controlled tape recorders.

### Collins IF filters

- MF500 Optional 500 Hz mechanical CW filter
- MF2.5 Substitute 2.5 kHz mechanical SSB filter
- MF6.0 Substitute 5.5 kHz mechanical AM filter

### CT5000 board

CTCSS plug in board for CTCSS search and squelch operations.

### AS5000 aerial switch

Automatic aerial switching unit designed to control four aerials (automatic and front panel aerial switching with the AR5000).

### DS8000 speech inverter

Speech inverter board (non AOR product). **Not available in all countries.**

### RS232 command set

Programmers RS232 command listing with information on configuring Windows terminal. *A separate serial connecting lead will also be required to connect to your computer.*

### Computer control software

A hands off IBM-PC WINDOWS computer program is planned to control the AR5000 via the rear panel remote connector. *A separate serial connecting lead will also be required to connect to your computer.*

## (20) Aerials (Antennas) and earth systems

The subject of aerial choice and earth can be quite complex. There are many advantages and disadvantages to consider before connecting an external aerial to your receiver.

### Theory and practice

One interesting phenomena is that aerial theory and practice can be

surprisingly different. Keeping common sense in mind it is one of the few remaining areas for listeners to easily experiment and often achieve fantastic results.

### Whip aerial

Whip aerials can give fair results for casual listening to the VHF/UHF bands. For best results external aerials in clear space are recommended.

### Mounting location

It is important to mount any external aerial as high as possible and in clear space although this is more important



at VHF/UHF frequencies than for short wave. If possible the aerial should have a clear path to the horizon. Results are usually disappointing when an installation is in a loft space.

### Long wire aerials

For short wave reception, a random length of long wire approximately 10 to 20 metres in length forms a good compromise. The wire should be connected to the centre pin of **ANT 1** (N-plug) or **ANT 2** (SO239). If possible try to locate the receiver close to a window so that the wire has the shortest and most direct run from the rear of the receiver to the outside world.

Never attach the wire aerial directly to a support or wall. Instead attach a short length (one metre) of insulating material such as nylon to each support (house or tree for example) and then onto the aerial wire. Allow the wire aerial to drop diagonally into the window and receiver rather than straight down the wall.

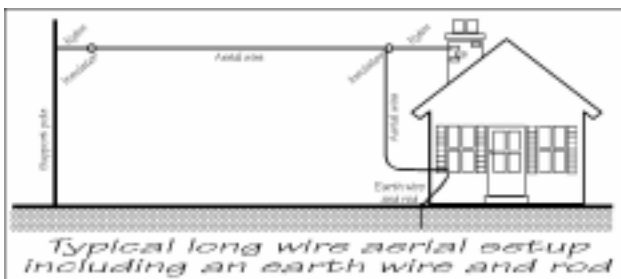

Keeping the aerial away from supports and building will reduce the loss of signal from the wire aerial and prevent unwanted noise from entering the aerial system.

Magnetic balun long wire aerials are becoming very popular as they allow coaxial cable to be used as the down-lead from the wire aerial to the receiver. The balun transforms the impedance to a low level suitable for 50 OHM coaxial cable. In this instance the path of feeder is unimportant and chances of noise entering the aerial system reduced. The 50 OHM aerial input of the AR5000 is ideally suited for connection to a magnetic balun.

### Dipoles

For the very best results you should consider a dedicated aerial such as a single or multi-band dipole or similar aerial. The problem with a wide coverage receiver like the AR5000 is that for the ultimate results, many dedicated aerials are required to cover the whole spectrum. This may involve complex aerial switching and reduces the ability to quickly monitor many bands unless the automatic aerial switching system is carefully planned using the optional AS5000 aerial switch.

As a compromise it may be worth making up a dipole aerial for one band of particular interest and have a VHF-UHF discone plus second random wire for general listening.

It is quite easy to make a dipole for short wave, for that matter one can be easily made up for VHF or UHF too. If being made for VHF-UHF, the centre connection of the coaxial cable feeds the upper element set vertically. Short wave dipoles on the other hand are usually mounted horizontally.

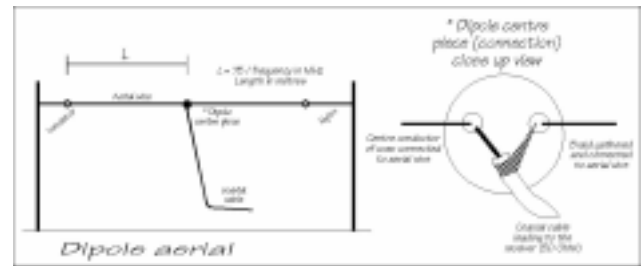

It is worth noting that dipoles are also quite effective on two and three times their design frequency so you can cover a few bands at once. Reception using a half wave dipole is best at 90 degrees to the direction the aerial is laying, however if used at two or three times it's fundamental design frequency, reception is best closer to the direction the aerial is lying.

A dipole has two legs running in opposite directions and can be mounted vertically or horizontally (most VHF-UHF activity is vertical). One leg is connected to the centre conductor of the coaxial feeder cable while the other leg is connected to the outer screen of the coaxial feeder cable. If mounted vertically, the centre of the coaxial feeder should be connected to the leg facing upward.

A simple formula can be used to calculate the required length of each leg for a half wave dipole:

$$\frac{75}{\text{Frequency in MHz}} = \text{Length of each leg in metres}$$

i.e. For 14.2 MHz

$$\frac{75}{14.2} = 5.28 \text{ metres (i.e. the total length of the aerial is twice 5.28m.)}$$

For increased performance and directivity, additional *elements* may be added to the front and rear of the dipole. *Directors* - shorter than the dipole element and placed to the front and a *reflector* - longer element to the rear. Many designs have been published for such aerials and mathematical formulae may be used to calculate the required length and spacing between elements. This type of aerial is usually referred to as a yagi or beam.

### Coaxial cables

When constructing dipole aerials or connecting VHF-UHF aerials 50 OHM coaxial cable should be used. For short wave or short runs of VHF URM43, URM76 or RG58U are ideal, for longer runs of VHF-UHF feeder it may be worth considering a heavier URM67 or RG213 (or better!).

## ATU & preselectors

Aerial tuning units (ATU) may improve the short wave section of a wide

range receiver (such as the AR5000) by rejecting unwanted signals and only allowing a specific band of frequencies through. These ATUs are normally constructed in small boxes with about 3 controls on the front. The disadvantage is the need to constantly retune the ATU when changing frequency. An ATU of this nature is **passive**, this means that no power is required to operate the ATU and no extra circuit-noise is introduced into the receiver.

## Loop Aerials

Short wave desktop loop aerials have the advantage of small size (such as the AOR LA320). They too have tuning controls to reject unwanted signals. As the loop is within easy reach of the operator it can be rotated to provide directivity. Loops can be particularly useful for DX'ing the lower bands.

Generally speaking they offer excellent portability but cannot compare on the higher bands with a well sited long wire aerial.

## Active aerials

Active aerials are normally quite compact (AOR WA7000) and combine a wide coverage aerial (30 kHz - 2 GHz) with a preamplifier mounted within the aerial its-self. They require power to enable them to operate. Not all designs allow you to switch the preamplifier off although some have a gain control.

As with loop aerials they tend to provide good results on the lower bands when compared to poorly sited short'ish wire aerials. Overload can be a problem on the busy 7 and 9 MHz bands. If you have a small garden space, an active aerial may be worth considering.

## Discone

For wide coverage in the VHF-UHF bands a compromise has to be met and the most popular aerial is a discone (AOR DA3000). Their appearance is like a large spider or umbrella without the covering material, the better models have about 16 elements.

Typical usable coverage starts from about 25 MHz and extends continuously to 500 MHz, 1300 MHz or even 2000 MHz. The coverage peaks and dips throughout its range as the elements interact to provide the widest possible coverage. Due to their necessary construction discone aerials are a little prone to **wind noise** due to vibration and possible damage in severe gales.

## Stub filters

Should you encounter **breakthrough** when using an external aerial (and the attenuator does not help) a simple stub-filter placed in the coaxial cable may help. This comprises of a 'T' connector with an open circuit 50 OHM cable length (the stub) attached to the 'T' piece. A rough calculation for the stub length is as follows:

$$(75 / \text{Freq in MHz}) \times 0.67 = \text{Stub length in metres}$$

i.e. To reduce the strength of 88.3 MHz on VHF Band-II:

$$(75 / 88.3) \times 0.67 = 0.57\text{m or } 57\text{cm}$$

## Commercial filters - ABF125

A VHF civil AIRBAND FILTER is available from AOR called the ABF125. This will help minimise the possible effects of breakthrough when listening to VHF airband in BAND-II VHF high signal areas or when connected to external aerials.

Other manufacturers are providing tunable filters to notch out unwanted signals typically in the range of 75 to 175 MHz.

## Earth systems

A separate EARTH connection made to the outer (braid) connector of the **ANT 1** or **ANT 2** plug may improve aerial efficiency and reduce noise.

Suitable earth points include connection to a water pipe, central heating radiator or external earth rod. If fitting a separate external earth rod when your a.c. mains supply uses a **Protective Multiple Earth (PME)** system, **consider the implications carefully**. If in doubt consult an experienced electrician.

Connecting an external earth wire may greatly reduce the local noise encountered when listening on the short wave bands. It is very important to provide a good earth should you use an aerial tuning unit.

A short length of thick gauge earth wire may be connected to a nearby central heating radiator or water pipe but **never use a gas pipe for earthing**. Ideally a separate earth rod should be used but the length between the receiver and rod becomes restrictive, if too long the earth system may well **pick up** noise rather than remove it.

If a long run of earth wire is necessary, it may be worth considering a **screened earth system**. This simply comprises a coaxial cable (such as URM43 or URM76 for short runs with URM67 or RG213 being used for longer runs) shorted inner to outer at the earth rod end with only the centre core connected to the outer of the AR5000 aerial plug, the outer braid being cut back and insulated.

This provides a screen for potential incoming interference and passes any noise down the cable away from the receiver and toward the earth rod.

## (21) Propagation - short wave bands

VHF and UHF transmissions generally only propagate relatively short distances when compared to short wave signals. For all intensive purposes they may be considered as line-of-sight *plus a bit*.

Where as point-to-point communication between mobile users or when in built up areas may only be a couple of kilometres, aircraft at heights of 9,000 metres may be heard at a much greater distance (50 to 300 kilometres or more with the right conditions).

Occasionally **tropospheric** weather conditions or **sporadic E** layer ionisation enable VHF-UHF signals to travel many hundreds of kilometres.

Unlike VHF and UHF transmissions which generally propagate only on a localised basis (to the horizon plus a small amount), short wave transmissions may travel for many thousands of kilometres. Depending upon the frequency in use, time of day, season of the year and sun spot activity, transmissions may propagate completely around the world.

Radio signals are electromagnetic waves very similar to light beams. As such they do not readily follow the curvature of the Earth but attempt to travel out into space.

### The ionosphere

Luckily the frequency spectrum of short wave is often reflected back down to Earth by the upper layer of the Earth's atmosphere called the **ionosphere**.

When the reflected signals reach the Earth again they may either be received or reflected back up into space. If lucky, they will be reflected by the ionosphere yet again down toward the Earth providing reception into another and possibly more distant location.

The ionosphere is constructed of many layers of ionised gas. Of particular interest to short wave listeners' are the lower **E** and upper **F1 & F2** layers although a lower **D** layer exists during day time.

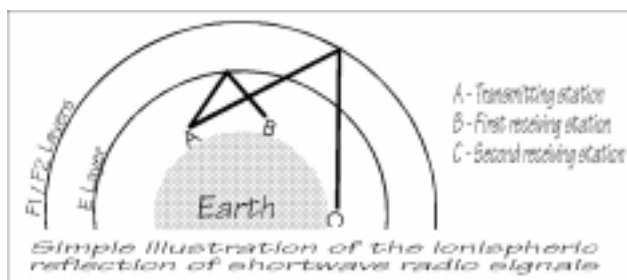

### D layer

During day time the lower **D** layer *forms* around 60 to 80 kilometres above the Earth's surface. This **D** layer tends to absorb low frequencies reducing the distance covered by medium wave transmissions. In the night time when the **D** layer dissipates, medium and low frequency transmissions may propagate over much greater distances.

If the transmitted frequency is too high to be reflected by the ionosphere,

or the angle too steep, transmissions will simply pass straight through the ionosphere without being reflected and will travel upward to the next ionosphere layer.

### E layer

Above the **D** layer is the **E** layer located at a height of about 100 kilometres. The **E** layer tends not to absorb signals as much as the **D** layer but refracts some signal back to Earth where it may be received some distance from the original point of transmission.

Usually in Spring and Autumn, **SPORADIC E** propagation consisting of dense pockets of **E** layer ionosphere, reflect even the higher VHF and UHF transmissions causing patterning on television sets. This is to the delight of Radio Amateurs who are then able to communicate for many hundreds and even thousands of kilometres on frequency bands usually capable of only local reception.

Occasionally a similar effect can be caused by temperature inversion layers creating **tropospheric propagation** selectively **ducting** transmissions between two points. Tropospheric propagation is usually applicable to the higher VHF and UHF bands.

### F1 & F2 layers

During the day time there are two upper layers of the ionosphere, these being the **F1** layer at about 200 kilometres and the **F2** layer at about 400 kilometres. As evening falls, these layers combine to form a single **F** layer. It is **F** layer propagation that is largely responsible for short wave propagation over great distances.

The density of the ionosphere layers varies depending upon season, time of day and sunspot activity which is believed to follow an eleven year cycle of good and bad propagation conditions.

You will note that large areas of the Earth's surface lays between the point of transmission and reflection, in this area there will be little or no reception. For this reason **F** layer propagation is often referred to as **SKIP** and the reflected signal as **SKY WAVE**.

Generally speaking only frequencies below 30MHz are reflected by the ionosphere. Higher frequencies pass straight through even the **F** layers and will continue outward into space for ever.

### Choice of frequency

Depending upon the time of day and desired skip distance, different frequencies will be selected by Radio Amateurs and Commercial users such as Oceanic Air Traffic, short wave broadcast...

For instance the **MUF (Maximum Usable Frequency)** is often stated for a path between two locations. Choosing a frequency above the **MUF** will not produce results as

transmissions will pass straight into space. MINimum usable frequency is also stated for similar reasons.

Many propagation predictions and statistics are published and usually available from most country's National Amateur Radio and short wave listeners representatives.

Various publications are produced giving transmission and contact details for world-wide reception. These titles include:

World Radio TV Handbook (WRTH), BPI Communications, 1515 Broadway, New York 10036, NY USA.

Passport To World Band Radio, IBS North America, Box 300, Penn's Park PA 18943, USA.

Listings for utility services are also widely published and available.

## (22) Specification

Model	AR5000
Frequency range	10kHz ~ 2600MHz (minimum accepted frequency input 5 kHz)
Tuning	NCO 1Hz ~ 999.999999kHz
Modes	AM, FM, USB, LSB & CW
I.F frequencies	1st I.F. 622.0 MHz 2nd I.F. 10.7 MHz 3rd I.F. 455 kHz
Standard fitted filters	3kHz, 6kHz, 15kHz, 30kHz, 110kHz & 220kHz (provision for 500Hz option)
Memory channels	1000 (100 ch x 10 banks)
Search banks	20 banks
Memory scan speed	25 channels per second in standard mode, 45 channels per second (max) in <i>Cyber Scan</i>
Search speed	25 increments per second in standard mode, 45 increments per second (with step size of 100kHz or less) in <i>Cyber Search</i>
PASS frequencies	2100 total (21 banks x 100 ch inc VFO)
Priority	1 channel
I.F. output	10.7 MHz with maximum $\pm 5$ MHz bandwidth
External reference	10.0 MHz input
Mute	Phono/RCA socket CMOS input pull-up to 5V @ 100k OHMS
Operating temp.	0° to +50° C

Aerial input	50 OHM unbalanced. N-TYPE & SO239
Audio output (13.5V)	1.7 WATT into 8 OHMS @ 10% THD
Power requirements	nominal 13.5V d.c. (12 ~ 16V) @ 1A or less
Size	217(W) x 100(H) x 260mm(D) mm approx excluding projections
Weight	3.5kg
CPU 8bit	ROM 32,768 Byte RAM 1,024 Byte
EEPROM	131,072 Byte (1M Bit)
Selectivity	

I.F. filter bandwidth table:

Filter kHz	Total nose (b'width kHz / dB)		Total skirt	
0.5 (500Hz)opt	0.5	-3	2.0	-60
2.5 opt	2.5	-3	5.2	-60
3	2.4	-6	4.5	-60
5.5 opt	5.5	-3	11.0	-60
6	9.0	-6	20	-50
15	15	-6	30	-50
30	30	-6	70	-50
110	140	-3	350	-20
220	260	-3	520	-20

Sensitivity

Receive frequency	10dB S/N AM 6kHz	12dB SINAD SSB/CW 3kHz	12dB SINAD FM 15kHz	12dB SINAD FM 220kHz
10kHz - 40kHz	63.00uV	17.70uV	-	-
40kHz - 100kHz	4.46	1.25	-	-
100kHz - 2MHz	2.23	0.40	-	-
2MHz - 40MHz	1.25	0.40	0.56	1.58
40MHz - 1,000 MHz	0.63	0.3	0.4	1.25
1,000MHz -2.6 GHz	0.63	0.3	0.36	0.89

**\* Specification is typical but not guaranteed, subject to change without notice due to continuous development of the product E&OE. Manual version 1.0.**



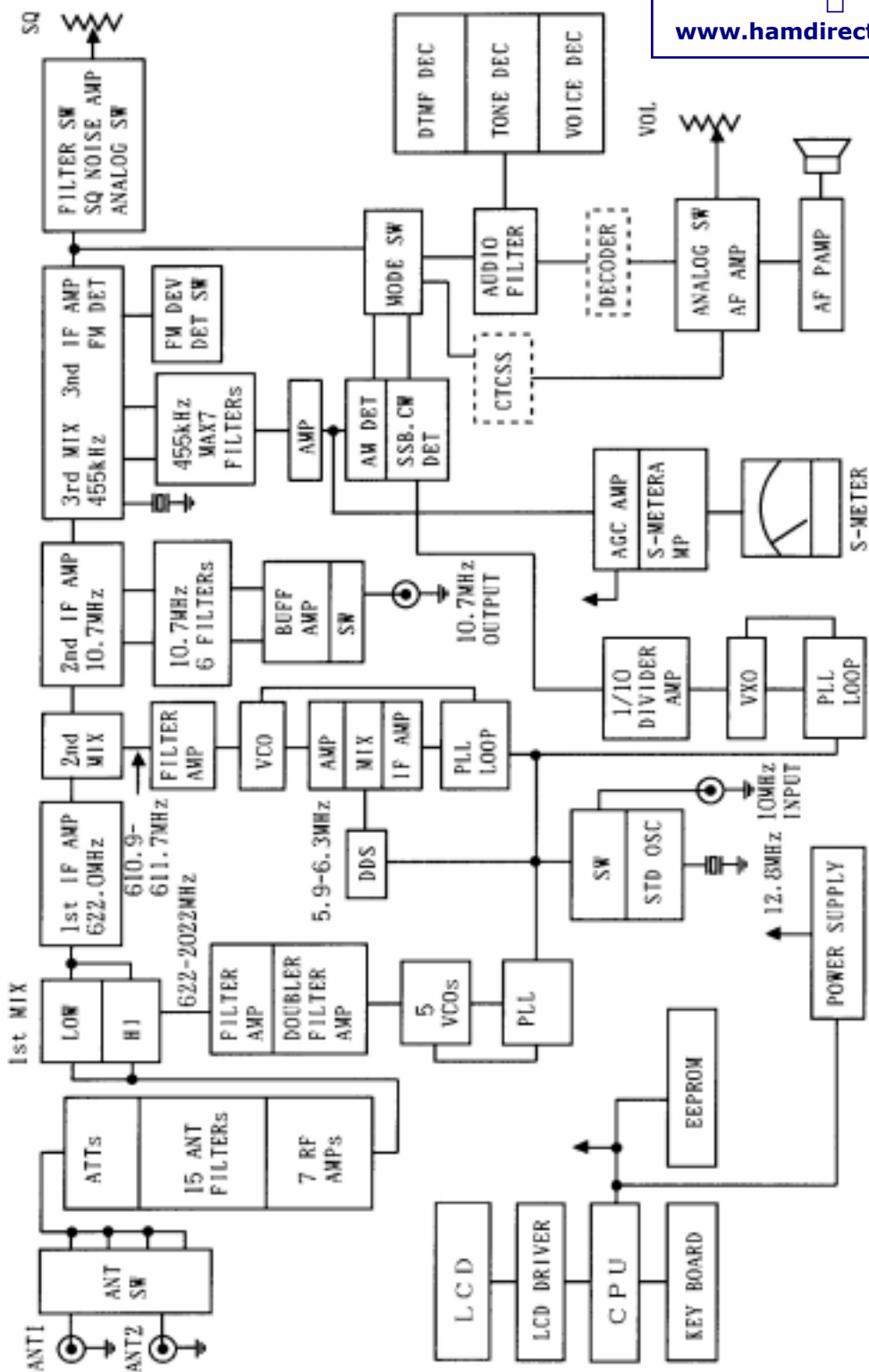

The AR5000+3 is a 'feature loaded' version of the AR5000 receiver with three enhanced facilities which can only be fitted in the factory during manufacture:

- Synchronous AM
- Automatic Frequency Control
- Noise blanker

**1. Synchronous AM**

Synchronous AM is a useful tool to help reduce distortion due to selective fading, in particular on the short wave bands (long & medium wave bands too). In synchronous AM, the original carrier is phase locked to a stable internally generated synthetic reference which is used to replace the (variable) original carrier resulting in more stable reception with greater recovered audio, especially during deep fades. A wide lock range is provided by this detector to enable simple, quick & efficient operation (unlike some other synchronous units on the market which require extremely accurate tuning).

- SAM** Synchronous AM double side band
- SAL** Synchronous AM lower side band
- SAH** Synchronous AM upper (higher) side band

AM transmissions are constructed of a carrier and both upper & lower sidebands. Usually both side bands carry the same information so both or either may be selected with the same recovered resulting audio, however when adjacent interference is present, selecting synchronous single side band (SAL or SAH) can provide improved results.

The **MODE** key is used to select synchronous AM in the same manner as other receive modes via the *SUB DIAL*, the list of mode has simply become longer: *AUTO FM AM LSB USB CW SAM SAL SAH*

**2. Automatic Frequency Control (A.F.C.)**

Automatic frequency control is a 'global' facility, either OFF or ON (default is off). When A.F.C. is used in AM, FM and synchronous AM modes, the receiver is automatically tuned on to the centre frequency to provide the best signal strength and recovered audio. When used in synchronous AM modes, A.F.C. ensures that the signal is pulled within lock range for no-fuss operation. A.F.C. is particularly useful on the VHF-UHF bands to ensure that the AR5000 is receiving spot on frequency, especially when searching through unusual band plans or when the exact band plan is not known.

*Restrictions:*

- a. A.F.C. does not operate on USB, LSB or CW modes
- b. If you are tuned many kHz off frequency (so that there is little recovered audio), you may be outside of A.F.C. range.
- c. A.F.C. may not exactly centre FM reception when using a wide filter such as 110 kHz or 220 kHz.
- d. The last three right hand digits of frequency readout (Hz, tens of Hz and hundreds of Hz) will be removed and replaced with the letters "AF" to indicate that A.F.C. is in operation.

A.F.C. is switched ON/OFF using the OPTION menu while in VFO, SEARCH or SCAN modes.

Press **FUNC** then **0** to access the options menu. "AFC" is the first option on the list:

```
AFC OFF      <<<<
NB OFF
DTMF OFF
T-ELMT OFF
```

Downloaded by   
**Amateur Radio Directory**   
  
[www.hamdirectory.info](http://www.hamdirectory.info)

Use the *SUB DIAL* to toggle the A.F.C. OFF/ON. Press **ENTER** to accept any changes or press **CLR** to abort selection. When A.F.C. is switched on, a typical display may look like:

```
ANT? ATTD dB AMP  N-SQL AUTO  AM  BANK
134.750  AF MHz  6K  05
                    BW
```

Depending upon how far the A.F.C. has to correct centre frequency, the process may take a few seconds.

**3. Noise blanker**

The noise blanker is another a 'global' facility, either OFF or ON (default is off). This facility is particularly useful to help reduce impulse noise and interference from vehicles ignition systems, whether from passing traffic or while the AR5000 is fitted into a mobile installation.

The noise blanker is switched ON/OFF using the OPTION menu while in VFO, SEARCH or SCAN modes.

Press **FUNC** then **0** to access the options menu. "NB" is the second option on the list:

```
AFC OFF      <<<<
NB OFF
DTMF OFF
T-ELMT OFF
```

Use the *SUB DIAL* to toggle the noise blanker OFF/ON. Press **ENTER** to accept any changes or press **CLR** to abort selection. There is no visual indication to show the status of the noise blanker, however it is fairly obvious when switched off/on as ignition noise will be heard!

Section 7-5 page 36 DELETING INDIVIDUAL MEMORY CHANNELS, 2<sup>nd</sup> paragraph:

**Replace**

"For example, to recall memory channel "123" press **1** **2** **3** **ENTER** while in memory recall mode".

**With**

"For example, to recall memory channel "123" press **1** **2** **3** while in memory recall mode".

In other words, omit the **ENTER** key then continue with the procedure stated in the operating manual.

Section 12-19 page 58 STARTING AUTO STORE, top of the second column:

**Replace**

"The **PASS** key toggles between OFF and ON. Press **PASS** to select ON..."

**With**

"The *SUB DIAL* is used to toggle between OFF and ON. Rotate the *SUB DIAL* to select ON..."

In other words, use the *SUB DIAL* to toggle auto store ON / OFF instead of using the **PASS** key.

**Step-adjust in program search mode using the AR5000**

When inputting program search data, there is no entry point for step-adjust, however it is still possible to enter step-adjust data following the programming sequence.

Enter program search data as per section 12-7 (pages 51, 52, 53) of the English language operating manual. Activate the program search in the usual manner by pressing **SRCH** then select the required bank as directed at the end of section 12-7 (page 53).

1. While searching, press the **STEP** key, press **PASS** to engage step-adjust (the "\*\*\*\*" legend will be displayed).
2. Press **UP** to display the current step-adjust value, such as 5kHz. Select the required step-adjust value by rotating the *SUB DIAL* or via the keypad (if using the keypad finish the entry with a quick press of **ENTER**).
3. To complete the data entry press **ENTER** for more than one second. The data will be accepted and display will revert to search with the "STEP-ADJ" legend displayed.

**Note:** if you did not complete the sequence by holding the **ENTER** key for more than one second, an error beep will sound (if the beep is enabled) and the data will not be saved. Remember, there is no entry point for step-adjust data during search program entry.

**Program search of the new 8.33kHz airband step using the AR5000**

The new airband channel step comes into effect in 1999 and 2000 for most of Europe and is to be further extend after that time. There is much confusion over the issue of 8.33 kHz, in reality it is not 8.33 but eight-and-one-third. As a third cannot be expressed in a decimal fashion, a small compound frequency error will occur every third increment. Ideally the end digits should read '00' '33' '66' '00' but will be display as '00' '33' '66' '99'. In reality, the AR5000 may be programmed in 8.333 kHz steps to further minimise the compound error, the error is then very small indeed, especially when considering the sub band is only expected to occupy 132.000 - 134.500 MHz (one Hz every third tuning increment!).

**Work around:**

If you do not wish to live with a small compound error, it is possible to program three program search banks as a GROUP (refer to section 12-4 Page 49 onward of the English language operating manual). It is assumed in this addendum that you understand how to program basic functions.

1. Program three program search banks with the limits 132.000 - 134.500 MHz in AUTO mode (AM 25kHz steps). Link all three search banks to form a single group... so all three are searched together. The operating manual does not specifically deal with step-adjust during program search, so ignore it at this time. Let's assume you have used banks 1, 2 & 3.
2. Bank 1 is left 'as is'.
3. Start searching bank 2. Press **STEP** then press **PASS** to engage step-adjust (the "\*\*\*\*" legend will be displayed).

Press **UP** to access the sub-menu to allow the step-adjust value to be entered. Key in **8** **.** **3** **3** **ENTER**

Now press and hold the **ENTER** key for more than one second for the data to be accepted (do not simply press ENT momentarily).

As there is no step-adjust entry point during the data input of program search, this LONG HOLD of the **ENTER** key must be used to enter step-adjust while searching in the above fashion. The AR5000 will continue to search but will add 8.33 kHz to every 25 kHz increment.

4. Repeat the process outlined in (3) for the third search bank, in this example (bank 3) but use a step adjust value of 16.66 kHz.

The AR5000 will continue to search but will add 16.66 kHz to every 25 kHz increment.

**Outcome:**

By searching all three search banks as a group, the exact frequencies will be searched for the new airband allocation without a compound error creeping in. As the AR5000 has 20 search banks (twice), using three banks in this way is no great loss.

**SWITCHED EPROM BANKS - more memories!!!**

The facility of switching EPROM banks is now supported by the AR5000+3 (see the main operating manual section 18-6, page 71, last two items).

This virtually means that the AR5000 now has 2000 memory channels, 40 search banks, 10 VFOs etc... two sets in one!

Downloaded by   
**Amateur Radio Directory**   
  
[www.hamdirectory.info](http://www.hamdirectory.info)

	<b>AOR Ltd</b> 2-6-4 Misuji, Taito-ku, Tokyo 111-0055, Japan. Tel: +81 3 3865 1695 Fax: +81 3 3865 1697 post@aojia.com www.aojia.com <b>AOR (UK) Ltd</b> 4E East Mill, Bridgefoot, Belper, Derbys DE56 2UA, England Tel: +44 1773 880788 Fax: +44 1773 880780 info@aoruk.com www.aoruk.com <b>AOR USA, INC.</b> 20655 S. Western Avenue, Suite # 112 Torrance, CA. 90501, USA Tel: (310) 787 8615 Fax: (310) 787 8619 info@aorusa.com www.aorusa.com
---	--