



# AR-ALPHA

PROFESSIONAL GRADE  
Communications Receiver



Welcome  
to the  
Future!

Now you can  
monitor radio  
frequencies from  
10 KHz - 3.5 GHz  
with no  
interruptions.

# AOR proudly presents the AR-ALPHA, the monitoring receivers featuring AO

Covering 10KHz to 3.5GHz with no interruptions, this desktop or rack mount receiver sets new standards for signal monitoring, signal searching, spectrum display, and signal recording. Featuring wideband receive and advanced DSP technology with a high speed DDS local oscillator, innovative **ZERO-IF** from the 10.7MHz digital processing, versatile spectrum scope with FFT technology, stable OCXO, and I/Q output. In addition to a wide variety of AM and FM modes, the AR-ALPHA also receives and displays analog TV signals in NTSC, PAL and SECAM formats, APCO-25 digital reception and a Digital Voice Recorder that can capture up to 25 minutes of audio and six channels. Monitoring professionals will appreciate the world class engineering and attention to detail that makes the AR-ALPHA a breakthrough in monitoring capability.

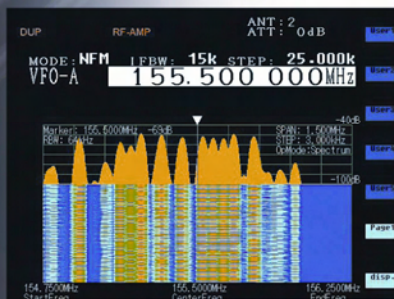

VHF digital communication screen (center freq. 155.5 MHz)

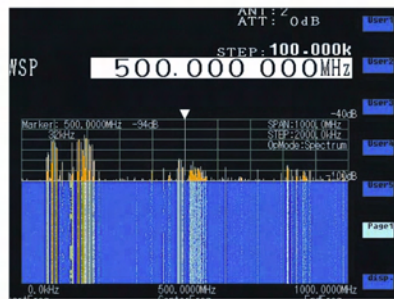

1GHz full span display (center freq. 500 MHz)

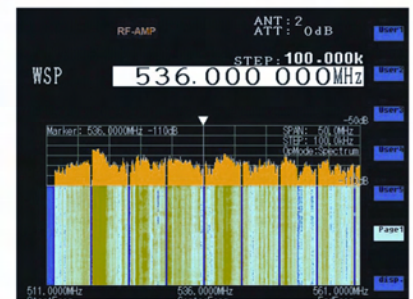

Digital TV broadcast signal (in Japan, center freq. 536MHz)



# first in a new class of professional grade R's compressed digital technology!

**R**ear panel connections include 12 VDC power, RS-232C, USB 2.0, I/Q output with 1 MHz bandwidth, two antenna ports (one SO-239 and one Type N) and up to four antennas may be selected through the receiver's controls with the optional AS5000 antenna selector.

No wonder so many monitoring professionals including government agencies, newsrooms, laboratories, military users and more, rely on AOR, the Authority On Radio.



# The AR-ALPHA redefines excellence in

## Large LCD Color Display Panel

The 6.4 inch TFT LCD color display utilizes 640 x 480 pixel high resolution to display received video signals as well as spectrum activity over a wide range of bandwidths. It also displays received TV signals in NTSC, PAL and SECAM formats.



Analog TV reception



Surveillance camera reception

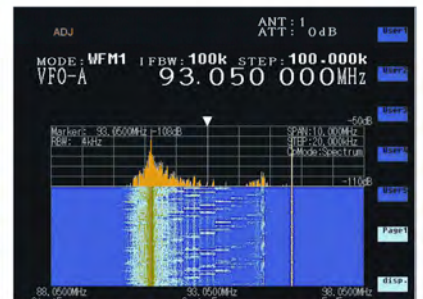

AOR original FFT algorithm enables display of up to 1 GHz bandwidth. Frequency resolutions are: 1 KHz, 4KHz, 32KHz, 64KHz, 128KHz.



## **+/- 0.1ppm frequency stability (built-in standard)**

The AR-ALPHA features a stable OCXO (Oven Controlled Crystal Oscillator) as standard equipment. This premium OCXO delivers +/- 0.1 ppm stability which is similar to performance found in test instruments. An external 10MHz standard signal can be also used.



Oven Controlled Crystal Oscillator

## **Digital IF Filter enables custom filter selections**

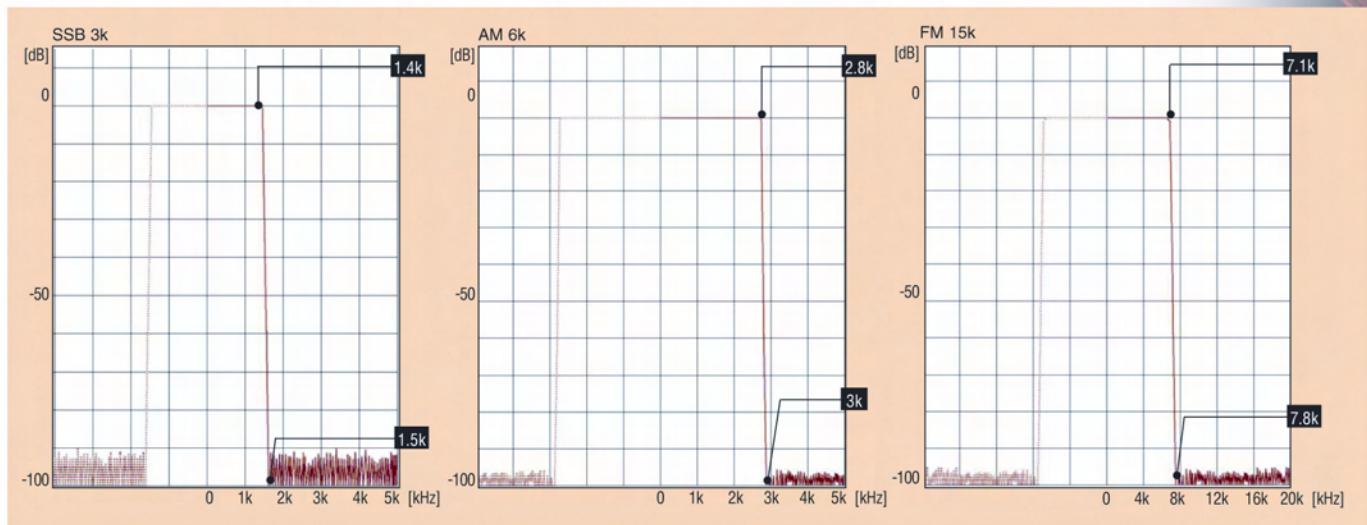

## **Digital Demodulator responds to a wide range of special modes and operations**

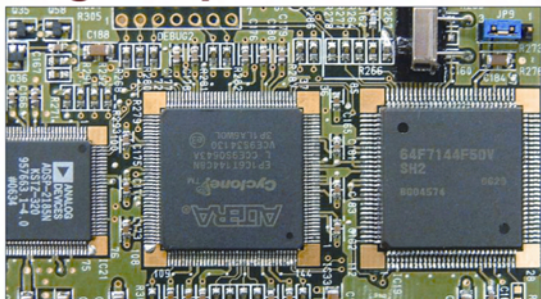

The AR-ALPHA features a versatile digital demodulator that includes APCO-25, a digital filter, auto notch filter, IF shift, noise reduction, analog voice descrambler, tone eliminator, DCS, CTCSS, level squelch, and voice squelch. An audio output with 12 KHz BW is also available for DRM, SDR.

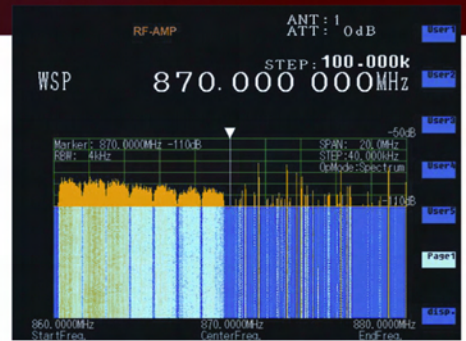

WSP 870.000000 MHz  
(displays 1GHz of BW on the LCD)

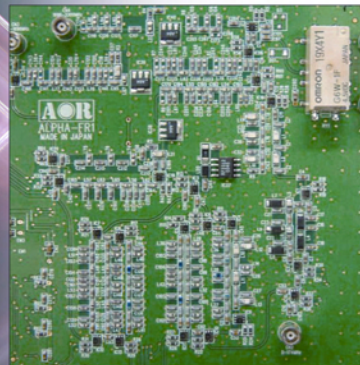

New high definition RF front end circuit

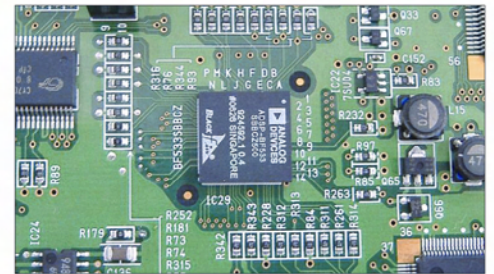

Circuit board with ANALOG DEVICES A/D converter chip

## High Definition Front End with Innovative Zero Frequency 3rd IF Stage

New high definition RF front end was designed without compromise and includes 17 separate bandpass filters, high grade RF amplifier, and high quality attenuator. The RF section with superior high linearity generates a 10.7MHz 2nd IF signal and feeds the DSP circuit, for a 3rd IF frequency of Zero.



# professional monitoring receivers!

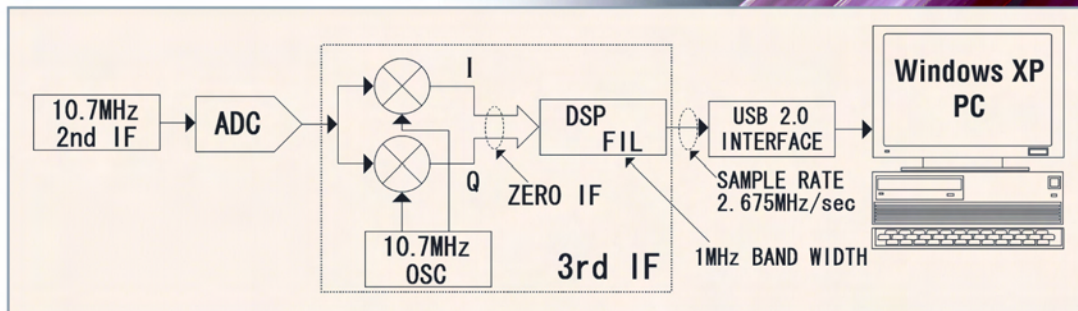

**IQ output block diagram**

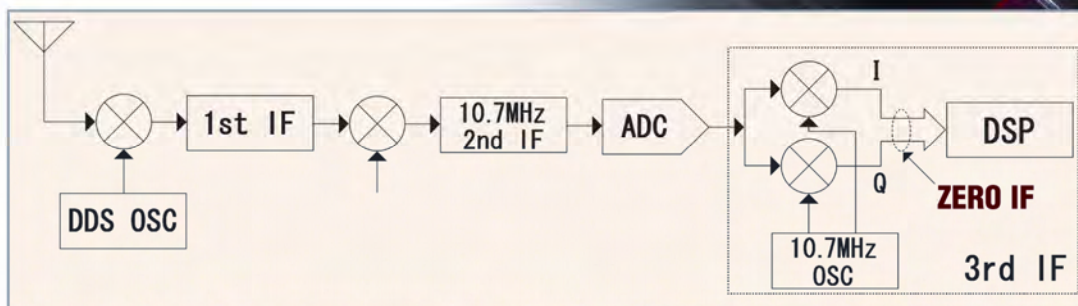

**AR-ALPHA frequency configuration**

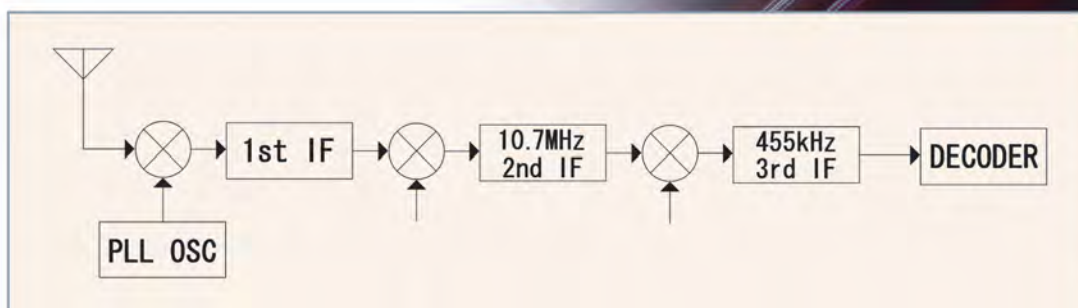

**Ordinal analog receiver**

- Multi-mode unit capable of receiving AM (synchronous), ISB, RZ-SSB, USB, LSB, CW, WFM including FM stereo, NFM, APCO-25 digital, and TV in NTSC, PAL and SECAM formats
- 6-inch TFT color panel can display received video signals or depict spectrum activity over a wide choice of bandwidths including a "waterfall" function to show signal activity over a specified time period
- Composite video output on the rear panel of the unit
- Selectable IF bandwidths: 200 Hz, 500 Hz, 1 KHz, 3 KHz, 6 KHz, 15 KHz, 30 KHz, 100 KHz, 200 KHz and 300 KHz along with the ability to shift the IF.
- CTCSS and DCS selectable squelch functions
- Five VFOs
- 2000 alphanumeric memories that can be computer programmed as 40 banks of 50 channels
- 40 search banks
- a "select memory" bank of 100 frequencies, and a user designated priority channel
- DTMF tone decode
- Built-in voice-inversion descrambling\*
- CW pitch control, AGC, AFC
- Auto-notch feature
- User selectable spectrum display function from 250 KHz through 10 MHz in 1 KHz increments. Above 10 MHz bandwidth, it can display 20 MHz, 50 MHz, 100 MHz or 1 GHz, but above 20 MHz bandwidth, no audio is available
- Resolution bandwidth is also user-selectable in increments of 1 KHz, 4 KHz, 32 KHz, 64 KHz, and 128 KHz.
- Fast Fourier Transform (FFT) Spectrum Display

# AR-ALPHA

## SPECIFICATIONS

Frequency coverage:	10KHz ~ 3.5GHz (Cellular Blocked for US consumer version)
Receive mode:	WFM, FM-ST (FM Stereo), AM, SAM, USB, LSB, CW, ISB (Independent Sideband), SBD (Sideband Diversity), RZ-SSB (Real Zero SSB), AIQ (Analog I/Q (---F.Y.I. Can be used as an analog output for DRM reception, 3rd party decoding software required), APCO-25 (P25, conventional mode), Video (NTSC, PAL, SECAM)
Memory channels:	2000
Search banks:	40
Antenna inputs:	N, SO239
Antenna impedance:	50 ohms nominal
Scan speed:	70 channels per second
Search speed:	70 steps per second
Operating temperature range:	0 ~ 50 degrees (C), 32 ~ 144 degrees (F)
Frequency stability:	Less than +/- 0.1ppm (after 5 minutes of power on time, at 0 ~ 50 degrees (C), 32 ~ 144 degrees (F)
Frequency resolution:	1 Hz minimum
Communication port:	RS-232C, USB
USB output:	2.0 compatible
I/Q output:	1MHz B/W maximum through USB port
Power requirement:	11 ~ 16 V DC (13.8 V DC nominal) Negative ground
Current drain:	In standby mode: approx. 650mA (at 13.8 V DC)
Maximum drain:	approx. 2.2 A
Dimensions;	16-1/2 (w) x 5-1/8 (h) x 10-1/8 (d) (inch), projections not included.
	Suitable for rack mounting.
Weight:	17 lbs

## SPECIFICATIONS

Receiver configuration:	Triple conversion Super Heterodyne (Zero - IF)
Intermediate frequency:	1st: 755MHz/ 265 MHz 2nd: 10.7MHz 3rd: Zero
Dynamic Range:	More than 90dB
IP3:	More than +2dBm (across the entire receive range)
Spurious Sensitivity:	More than 60dB
Speaker impedance:	8 ohms
Sensitivity (w/ RF amplifier ON):	AM (BW=6KHz: 10dB S/N) 0.1 ~ 1.699MHz: 5 uV 1.699 ~ 24.99 MHz: 5uV 25 ~ 479.99 MHz: 2.3 uV 480 ~ 1029.99 MHz: 2.3 uV 1030 ~ 1695.99 MHz: 1.3uV 1696 ~ 3300 MHz: 1.5 uV FM (BW= 15 KHz: 12 dB SINAD) 25 ~ 479.99 MHz: 2.5 uV 480 ~ 1029.99 MHz: 0.8 uV 1030 ~ 1695.99 MHz: 0.8 uV 1696 ~ 3300 MHz: 1.5 uV WFM: (BW=200 KHz: 12 dB SINAD) 25 ~ 479.99 MHz: 1.3 uV 480 ~ 1029.99 MHz: 1.3 uV 1030 ~ 1695.99 MHz: 1.3 uV 1696 ~ 3300 MHz: 1.5 uV
Selectivity:	SSB (BW = 3 KHz) more than 3 KHz at -3dB, less than 3.6 KHz at -90 dB CW (BW = 500 Hz) more than 500 Hz at -3dB, less than 700 Hz at -90dB AM (BW = 6 KHz) more than 6 KHz at -3dB, less than 15 KHz at -90dB FM (BW = 15 KHz) more than 15 KHz at -3 dB, less than 25 KHz at -90 dB

Specifications are subject to change without notice or obligation.  
Specifications are guaranteed up to 3.3 GHz operating frequency.

\*Documentation required for qualified purchasers in the USA.



**AOR, LTD.**  
2-6-4 Misuji, Taito-ku, Tokyo 111-0055, Japan  
Tel: +81 3 3865 1695 Fax: +81 3 3865 1697  
post@ajorja.com www.ajorja.com

**AOR U.S.A., Inc.**  
20655 S. Western Ave., Suite 112, Torrance, CA 90501, USA  
Tel: 310-787-8615 Fax: 310-787-8619  
info@ajorusa.com www.ajorusa.com