

GRUNDIG

Service Manual



3/79

**Satellit 3400
professional**

Removal of Chassis

1. Pull out the mains cable connector and remove any dry or rechargeable batteries which may be in the receiver.
2. Loosen 9 screws (b) and remove back plate (Fig. 1).
3. Pull out the telescopic aerial connector.
4. Unscrew tuner switching knob on the spindle inside the receiver.
5. Unscrew 2 screws in the bottom cover and remove the cover.
6. Pull off 9 rotary and switching knobs.
7. Loosen the 4 screws marked in Fig. 2.
8. Carefully remove chassis and unplug the connector.

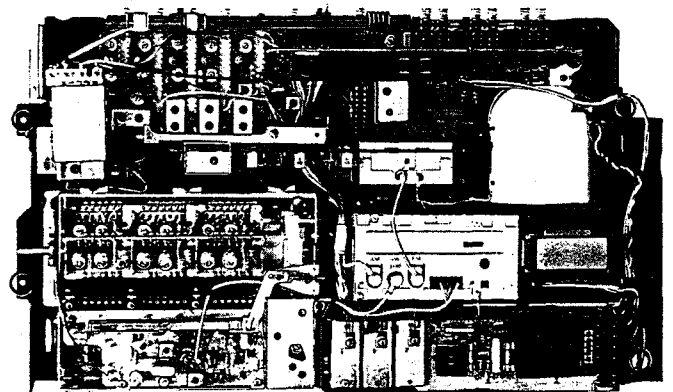
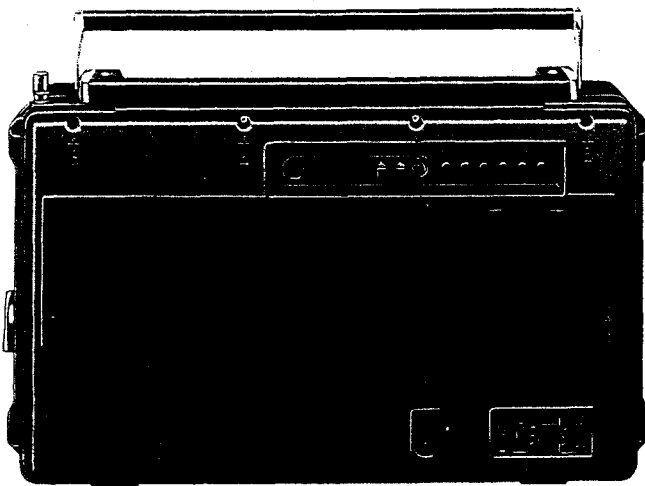

Alignment Instructions

All the voltages must be adjusted with the aid of a sufficiently accurate instrument (eg: Grundig DM44) and the given voltages should be kept certainly within the stated tolerances.

I Adjustment of the Operating Points

No signal: $V_C = 9V$: MW button depressed.

1. With control R 636 ($2k\Omega$), adjust the quiescent current of the output stage T 606 (GD 363), T 607 (GD 364) to $6mA \pm 1mA$ (instead of the bridge, connect milliampmeter to collector of the GD 364). During this adjustment, the loudspeaker connection must be terminated with an impedance of 4Ω and the volume control must be turned fully anti-clockwise.
2. Adjust the emitter current of T 502 with R 507 ($100k\Omega$) so that the voltage drop across R 508 (680Ω) is $1.4V$.
3. With the BFO/SSB section switched in circuit, adjust the trimmer resistor R 703 ($5k\Omega$) so that the voltage drop across R 704 ($2.7k\Omega$) is $5V$.

II Adjusting the Charging Voltage V_C

With a mains supply of 240V AC and the receiver switched off, adjust R 658 ($1k\Omega$) so that the charging voltage V_C into an equivalent resistance of $1k\Omega$ and an elco of $1000\mu F$ is $9.1V \pm 50mV$.

Important: The power supply unit should have been "on" for approx. 2 minutes prior to this adjustment being carried out.

III Frequency Counter

1. With a supply voltage of 9V and the AM reset figure of 99.540 in the counter display (no button depressed) adjust R 876 ($5k\Omega$) to give an output voltage from the converter at test point MP 802 (STV 801 (4)) of $5.15V \pm 50mV$. (As an alternative, the output voltage may be set outside the receiver with a 39Ω (1W) resistor across the 5V converter).
2. Adjust the trimmer capacitor C 354 so that the reference frequency at test point MP 801 is $320kHz \pm 1Hz$.

IV AM Alignment

Bandwidth switch to setting "schmal" (= narrow), mod. freq. \leq 1000Hz.

1. AM-IF

a) AM-IF Alignment 460kHz

Alignment sequence	Wobulator output connected to	Indicator connection	Alignment
IF-filter XVII	MP 502	Probe loose on collector T502 (MP 503)	(I) For maximum
IF-filter XVII and XVI	MP 501		(II) and (III) for maximum
IF-filter XV and XIII ("K3-10" depressed)	MP 202		(IV) For symmetry (V) For maximum and symmetry
IF-filter XIV (MW depressed)	MP 401		(V) For maximum and symmetry

b) 2.46MHz-Oscillator

Alignment sequence	Signal generator coupled to	Alignment indication	Alignment
2. Oscillator 2.46MHz	VP 202	Output meter	(VIII) Visually to centre of C 259 (VII) For maximum (VIII) Fine adjustment C 259

c) AM-IF Alignment 2MHz

Alignment sequence	Wobulator output connected via isolating capacitor to	Indicator connection	Alignment
IF-filter XI	MP 201	to MP 202	At an input of 50mV (X) for min. dip
IF-filter XII			(IX) for maximum
C 214			At 500mV input, the IF curve must be adjusted with (XI), without raising the base of the curve, for max. steepness

2. AM-Oscillator, Filter and Aerial Circuit Alignment

Range Frequency Pointer Setting	Oscillator	Filter Circuit	Aerial circuit	Ferrite aerial circuit	Input sensitivity at 30% modulation 400Hz				Image Rejection db	Oscill. voltage		
					6db	26db	1 W			At oscillator emitter	At mixer emitter	
					Narrow	Wide						
LW	160 kHz	① Maximum	③ Maximum	⑥ Maximum	⑧ Maximum	6 μ V	65 μ V	32 μ V	24 μ V	67	115 ... 100 mV	90 ... 80 mV
	370 kHz 240 kHz	② Maximum	④ Maximum ⑤ Maximum	⑦ Maximum	⑨ Maximum	6.8 μ V	75 μ V	22 μ V	16 μ V	67		
MW	560 kHz	⑩ Maximum	⑫ Maximum	⑮ Maximum	⑰ Maximum	3.3 μ V	40 μ V	16 μ V	12 μ V	72	65 ... 75 mV	60 ... 70 mV
	1450 kHz 1000 kHz	⑪ Maximum	⑬ Maximum ⑭ Maximum	⑯ Maximum	⑱ Maximum	3.6 μ V	44 μ V	20 μ V	15 μ V	64		
K1	1,7 MHz	⑲ Maximum	⑳ Maximum	㉔ Maximum		3,7 μ V	45 μ V	13 μ V	9 μ V	70	65 ... 85 mV	60 ... 80 mV
	3,4 MHz 2,5 MHz	㉚ Maximum	㉗ Maximum ㉛ Maximum	㉝ Maximum		1,5 μ V	20 μ V	10 μ V	7 μ V	57		
K2	3,4 MHz	㉞ Maximum	㉘ Maximum	㉟ Maximum		2 μ V	28 μ V	12 μ V	8 μ V	61	60 ... 80 mV	60 ... 80 mV
	5,0 MHz	㉟ Maximum	㉙ Maximum	㊱ Maximum		1,5 μ V	20 μ V	11 μ V	7 μ V	52		

Remarks: The oscillator can be aligned in any sequence; for the filter circuit, first K1, then K2 must be aligned. Note the basic coil positions. The ferrite aerial circuit is aligned in the sequence LW, MW. To tune the LW and MW aerial circuits when an external aerial is used; the signal generator is connected via a 68pF capacitor to the external aerial socket (Y button depressed); to tune the SW aerial circuits (Y button not depressed), the signal generator is connected to the rod aerial connection.

3. SW-Tuner (K3-K10) sliding switch set to "Bereich" (=Range) or "Band" (=Tape)

Range/Band.	Alignment Point	Input sensitivity at 30% Modulation 400Hz:				Image Rejection db	Osc. voltage At oscillator emitter	At mixer emitter
		6dB	26dB	1W narrow	1W wide			
K3 5,0 - 6,65 MHz	5,2 MHz	0,65 μ V	10 μ V	1,9 μ V	1,3 μ V	76	90 ... 110 mV	85 ... 105 mV
	6,5 MHz	0,5 μ V	8 μ V	1,9 μ V	1,3 μ V	69		
49 m 5,93 - 6,25 MHz	6,1 MHz	0,5 μ V	8 μ V	1,8 μ V	1,2 μ V	70	100 mV	95 mV
K4 6,6 - 8,4 MHz	6,7 MHz	0,55 μ V	10 μ V	2 μ V	1,4 μ V	72	100 ... 115 mV	95 ... 110 mV
	8,3 MHz	0,5 μ V	8 μ V	2 μ V	1,5 μ V	66		
41 m 7,0 - 7,31 MHz	7,2 MHz	0,5 μ V	8 μ V	1,9 μ V	1,3 μ V	69	105 mV	100 mV
K5 8,2 - 10,55 MHz	8,3 MHz	0,5 μ V	8 μ V	1,7 μ V	1,2 μ V	70	90 ... 105 mV	85 ... 100 mV
	10,2 MHz	0,45 μ V	7 μ V	1,7 μ V	1,2 μ V	63		
31 m 9,45 - 9,85 MHz	9,7 MHz	0,45 μ V	7 μ V	1,6 μ V	1,1 μ V	64	95 mV	90 mV
K6 10,5 - 13,2 MHz	10,8 MHz	0,45 μ V	7 μ V	1,6 μ V	1,1 μ V	65	110 ... 125 mV	105 ... 115 mV
	13,0 MHz	0,4 μ V	6,5 μ V	1,7 μ V	1,2 μ V	59		
25 m 11,65 - 12,05 MHz	11,8 MHz	0,4 μ V	6,5 μ V	1,5 μ V	1 μ V	62	115 mV	105 mV
K7 12,9 - 16,3 MHz	13,0 MHz	0,4 μ V	7 μ V	1,7 μ V	1,2 μ V	63	95 ... 105 mV	90 ... 100 mV
	16,0 MHz	0,35 μ V	6 μ V	1,8 μ V	1,3 μ V	54		
19 m 15,05 - 15,65 MHz	15,3 MHz	0,35 μ V	6 μ V	1,7 μ V	1,2 μ V	57	100 mV	90 mV
K8 15,8 - 19,8 MHz	16,0 MHz	0,35 μ V	6 μ V	1,5 μ V	1 μ V	57	80 ... 90 mV	75 ... 85 mV
	19,5 MHz	0,35 μ V	6 μ V	1,7 μ V	1,2 μ V	47		
16 m 17,45 - 18,05 MHz	17,8 MHz	0,35 μ V	6 μ V	1,5 μ V	1 μ V	52	80 mV	75 mV
K9 18,35 - 23,5 MHz	18,7 MHz	0,4 μ V	6,5 μ V	1,7 μ V	1,2 μ V	54	85 ... 95 mV	75 ... 85 mV
	23,0 MHz	0,4 μ V	7 μ V	2,2 μ V	1,6 μ V	44		
13 m 20,95 - 21,85 MHz	21,6 MHz	0,4 μ V	6,5 μ V	1,9 μ V	1,3 μ V	46	85 mV	75 mV
K10 23,4 - 30 MHz	24,0 MHz	0,4 μ V	7 μ V	2,2 μ V	1,6 μ V	50	100 ... 110 mV	75 ... 80 mV
	29,5 MHz	0,4 μ V	7 μ V	2,8 μ V	2 μ V	38		
11 m 25,5 - 26,4 MHz	25,8 MHz	0,4 μ V	7 μ V	2,2 μ V	1,6 μ V	45	100 mV	75 mV

Remarks: The tuner must be aligned very carefully. As the screening cover and the tuner scale affect the tuning, this should be borne in mind when the circuit is being aligned. Alignment may be carried out in any sequence, except that the band must not be aligned until the range alignment has been completed.

For the aerial circuit alignment, the signal generator is connected via 20pF to the base of the telescopic aerial.

Oscillating voltage at the second oscillator: Oscillator emitter 60mV
Mixer emitter 55mV

4. Adjustment of Field Strength Meter on AM

With the AM-alignment completed, adjust the reading on the meter at $f = 1.7\text{MHz}$ (K 1) and an input of $30\mu\text{V}$ to "1", using R 519 ($25\text{k}\Omega$) and at an input of 100mV to "9" using R 514 ($500\text{k}\Omega$). This adjustment should be repeated at least once.

5. Alignment of the SSB Section

Oscillator Alignment

Set the BFO/SSB switch to "Aus" (=off). In the K3-10 mode, eg: in the 49 metre band at 6.1MHz , and with a modulation frequency of about 400MHz , adjust the receiver very accurately for maximum reading either on the output meter at low level or on the field-strength meter at higher level.

Set trimmer C 711 $\text{\textcircled{26}}$ visually to mid-position.

Set BFO/SSB switch to "Ein" (=on). With the trimmer C 709 $\text{\textcircled{28}}$ not connected in circuit (USB/LSB switch to the left) and the core of the SSB coil 19415-010.00 $\text{\textcircled{27}}$ turned to the right-hand stop, adjust filter 07220-510.00 $\text{\textcircled{29}}$ with unmodulated signal to zero beat. After locking the core, adjust accurately with C 711 $\text{\textcircled{26}}$. Switch trimmer C 709 ($3\ 15\ \text{pF}$) $\text{\textcircled{28}}$ into circuit (USL/LSB switch), turn fine tuning to left-hand stop and adjust for zero beat again with C 709 $\text{\textcircled{28}}$. The frequency deviation of the SSB section is now approx. $\pm 1\text{kHz}$. Because of the ceramic oscillator and the ceramic filter, the SSB section may be aligned only when fitted in the complete chassis. The oscillating voltage at the emitter of transistor T 703 is approx. $65\ \text{mV}$.

V. FM Alignment ("Fm" depressed, "AFC" off)

1. FM IF Alignment 10.7MHz

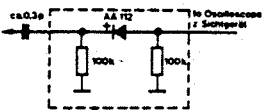
Alignment Sequence	Wobbulator output connected to	Oscilloscope connected to	Alignment
IF-filter IX	MP 304	Via clip-on probe with built-in diode (see Fig.) to MP 305 (near collector T 308)	(b) Detune (a) for maximum
IF-filter VIII and VII	MP 303		(c) and (d) for maximum
IF-filter VI and V	MP 302		(e) and (f) for maximum
IF-filter IV and III	MP 301		(g) and (h) for maximum
IF-filter II and I	FM-counter connecting cable		(i) and (k) for maximum
IF-filter X	MP 304		to MP 306
AM-suppression			The AM suppression is adjusted with control R 381 (2.5kΩ)

2. FM-RF Alignment

a) Adjustment of the tuning voltages:

At slider S of the tuning resistor 19703-036.00, with the FM button depressed and with the FM pointer at the r.h. end of the scale, adjust the voltage with R 341 (10kΩ) in the 30V converter to 30V±

100mV and with the FM pointer at the l.h. end of the scale; with R473 (15kΩ) to 2.1V ± 10mV.

b) FM Oscillator, filter and aerial circuit alignment

Generator freq. pointer setting	Oscillator	Filter circ.	Aerial circ.	Input sensitivity 15 kHz dev 1000 Hz			Image Rejection	Oscill. voltage	
				6dB	26dB	1W		At oscillator emitter	At mixer emitter
88 MHz	(A) Maximum	(C) Maximum	(E) Maximum	0,50 µV	1,5 µV	1,1 µV	55 dB	80 ... 90 mV	45 ... 55 mV
106 MHz	(B) Maximum	(D) Maximum	(F) Maximum	0,55 µV	1,6 µV	1 µV	53 dB		

Note: Connect the signal generator straight to the connection for the telescopic aerial.

c) Adjustment of the field-strength meter in the case of FM

When the FM alignment has been completed, adjust the deflection of field-strength meter to "1" by means of R 356 (50kΩ) at 88MHz and an input voltage of 3µV, and to "9" by means of R 361 (50kΩ) at a signal of ≥ 1mV.

The control F 652 is located either in the AF section (19310-469.00) or in the coil assembly 19415-007.00.

NOTES:

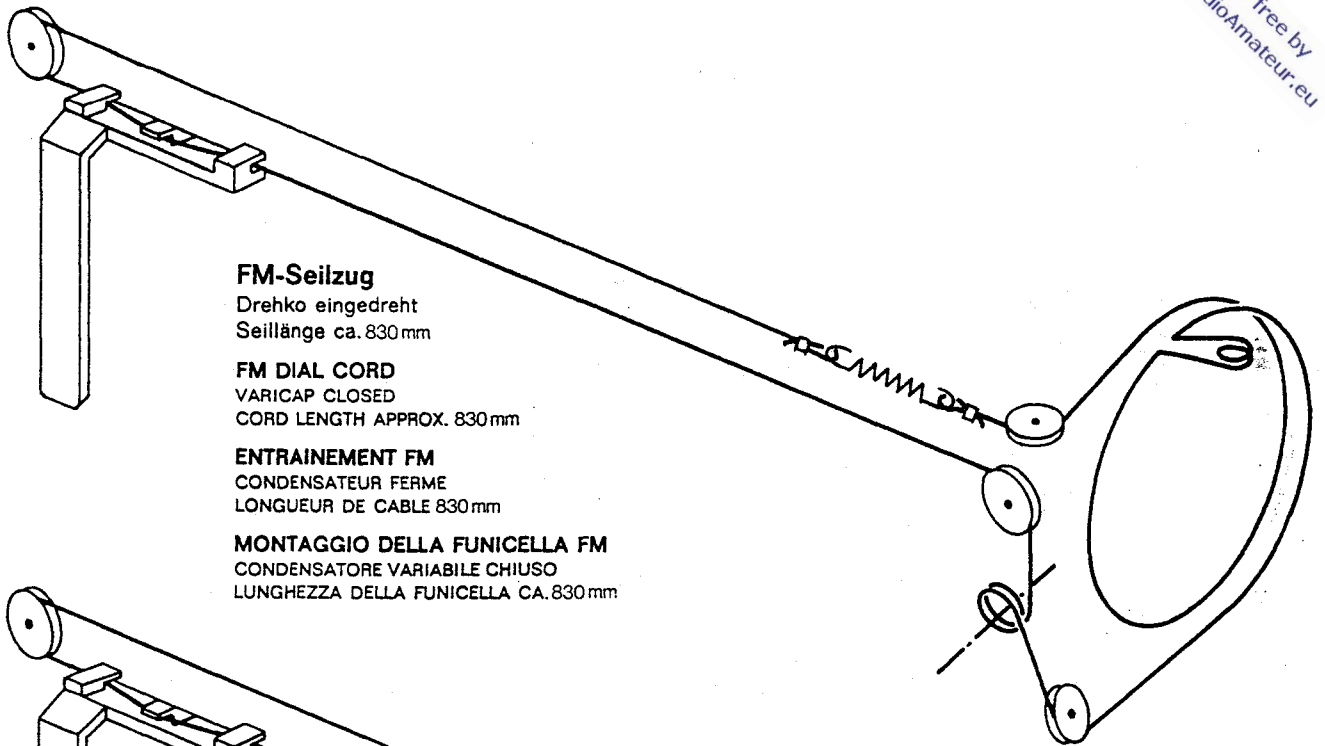

FM-Seilzug

Drehko eingedreht
Seillänge ca. 830 mm

FM DIAL CORD

VARICAP CLOSED
CORD LENGTH APPROX. 830 mm

ENTRAINEMENT FM

CONDENSATEUR FERME
LONGUEUR DE CABLE 830 mm

MONTAGGIO DELLA FUNICELLA FM

CONDENSATORE VARIABILE CHIUSO
LUNGHEZZA DELLA FUNICELLA CA. 830 mm

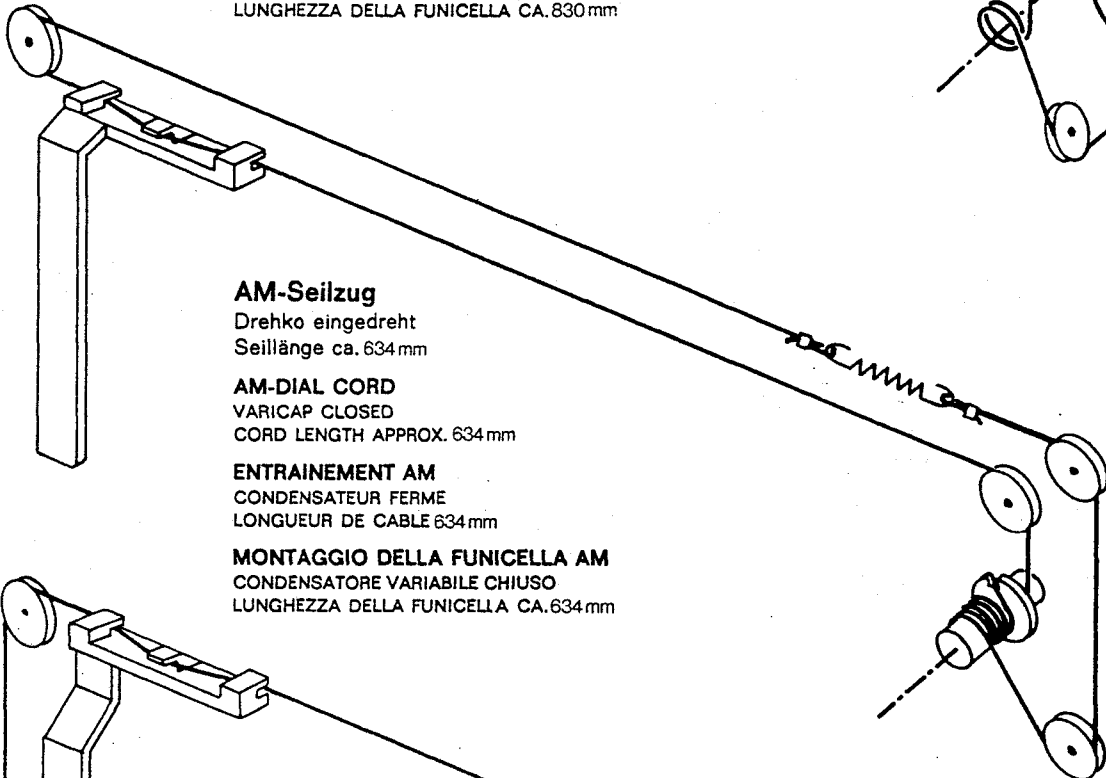

AM-Seilzug

Drehko eingedreht
Seillänge ca. 634 mm

AM-DIAL CORD

VARICAP CLOSED
CORD LENGTH APPROX. 634 mm

ENTRAINEMENT AM

CONDENSATEUR FERME
LONGUEUR DE CABLE 634 mm

MONTAGGIO DELLA FUNICELLA AM

CONDENSATORE VARIABILE CHIUSO
LUNGHEZZA DELLA FUNICELLA CA. 634 mm

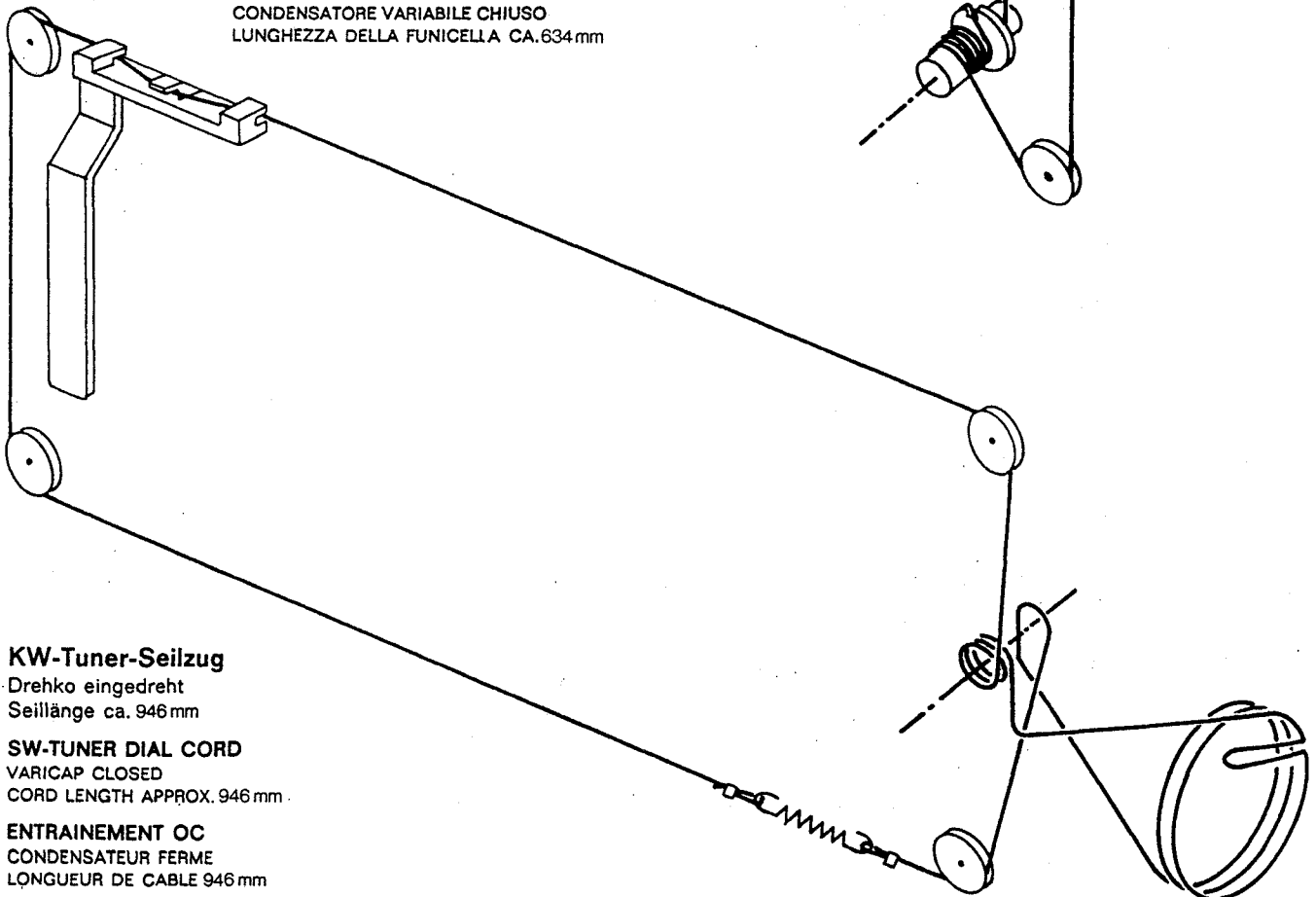

KW-Tuner-Seilzug

Drehko eingedreht
Seillänge ca. 946 mm

SW-TUNER DIAL CORD

VARICAP CLOSED
CORD LENGTH APPROX. 946 mm

ENTRAINEMENT OC

CONDENSATEUR FERME
LONGUEUR DE CABLE 946 mm

MONTAGGIO DELLA FUNICELLA OC

CONDENSATORE VARIABILE CHIUSO
LUNGHEZZA DELLA FUNICELLA CA. 946 mm

19311-206.00
AM-ZF-Platte, Lötseite
AM-IF BOARD, SOLDER SIDE
PLAQUE AM-FI, COTE SOUDURES
PIASTRA AM-FI, LATO SALDATURE

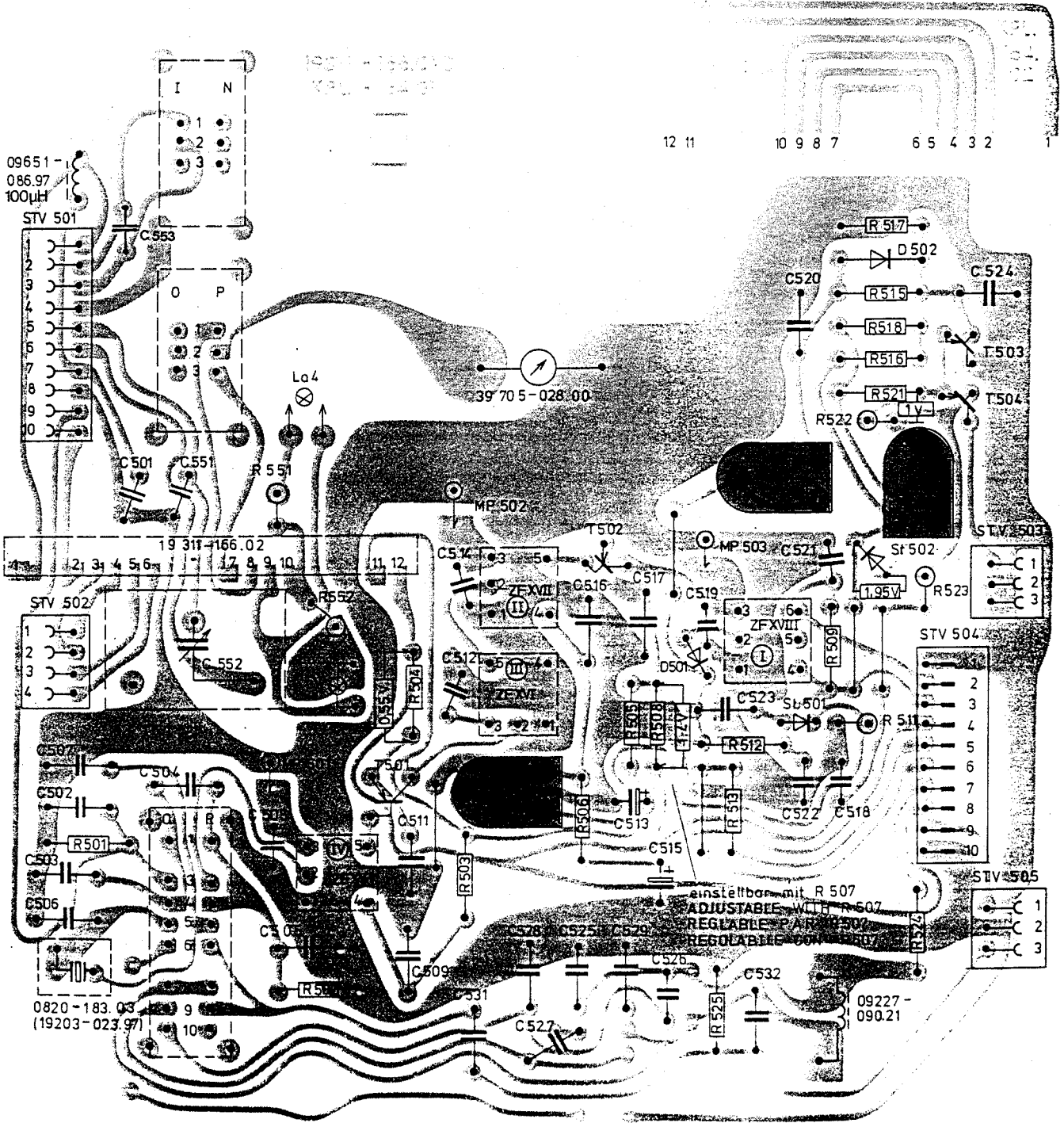

Pos. No.	Fig. No.	Part No.	Description	Pos. No.	Fig. No.	Part No.	Description
1		15038-007.01	Cabinet, black (SL)	57		09666-360.00	Bearing bush
1.1		15038-051.01	Cabinet front compl.	58		09631-314.00	3x Rubber grommet
1.11	1	09663-902.01	Decorative fabric com.	59		09630-697.00	3x Spacer
1.2	1	15038-177.01	GRUNDIG Emblem	60	2	15035-042.00	Spindle compl.
1.3	1	15038-179.01	Scale cover compl.	61	2	19703-036.00	Tuning resistor
1.4	1	15038-181.01	Scale cover compl.	62	2	8138-007-021	2x Drive cord TE 50 P (black)
1.5	1	15035-183.01	Indicator cover	63	2	09619-113.00	2x Tension spring
			Cabinet, black	64	2	15035-070.02	Pointer compl. (FM)
1		15038-008.01	Cabinet front compl.	65	2	15035-049.00	Drive drum
1.1		15038-014.01	Ornamental plate compl.	66		09619-767.00	Coil spring
1.11	1	09663-902.01	GRUNDIG Emblem	67	2	15035-067.02	Pointer compl. (AM)
1.2	1	15038-177.01	Scale cover compl.	68	2	15035-073.02	Pointer compl. (SW)
1.3	1	15038-179.01	Scale cover compl.	69		39601-682.00	2x Connector
1.4	1	15038-181.01	Scale cover compl.	70		39601-683.00	Connector
1.5	1	15035-183.01	Indicator cover	71		39601-689.00	Connector
			from Pos. 2, both versions are identical:	72	3	09004-002.01	Mains transformer
2		29608-226.01	4x Washer	73	3	15035-112.00	2x Shim
3	1	15035-032.01	Handle recess	74	3	15009-021.00	2x Transformer clamp
4	1	15035-033.01	Cap R.H.	75	1	15038-043.01	Lever compl.
5	1	15035-034.01	Cap L.H.	76	2	8138-003-005	2x Polyamide cord 0.3 Ø
6		01475-142.00	2x Handle brake	77	3	19076-001.01	Loudspeaker
7		09619-625.00	2x Coil spring	78	1	09621-119.02	Earphone socket w. nut
8	1	09661-266.01	Handle	80	1/3	15015-080.01	Telescopic aerial compl.
9	1	15038-028.01	6x Pushbutton	81		8132-015-139	Flat plug-in sleeve
10	1	15038-030.01	8x Pushbutton	82		09690-352.97	Mains lead w. plug and centre connector
11		15038-026.01	Cabinet back	82		09690-376.97	Mains lead w. plug and centre connector (for GB)
12		15035-036.01	Cable comp. lid	83		8316-453-002	3x Pilot bulb 7V/80mA/230V
13		15038-037.01	Battery compart. cover	84	3	15035-047.00	2x Ferrite aerial rod clamp
14		15035-038.01	Contact bridge	86		19426-032.00	Ferrite aerial compl.
15	1	15038-035.01	Switch lever compl.	86.1	3	09648-901.97	Aerial rod
16	1	15035-228.01	5x Switch lever compl.	86.2	3	09234-302.02	MW-ferrite aerial coil
17	1	15038-036.01	2x Switch lever compl.	86.3	3	09234-301.02	MW-ferrite aerial coil
18	1	15035-228.02	Switch lever compl.	86.4	3	09234-442.02	LW-ferrite aerial coil
19	1	09670-906.01	Wave change knob	86.5		09666-384.97	Wire clamp
20		09603-566.00	Clamping ring				Tuning coil set
21	1	09670-855.02	3x Control knob				19415-008.00
22	1	09670-856.05	5x Control knob	101		19416-002.00	Mounting plate compl.
23	1	09670-856.06	Control knob	102		07422-940.00	Slider
24	1	15038-039.01	Preset cap. knob	103		09619-763.00	Spring
25		09619-767.00	9x Coil spring	104		09216-943.01	SW-RF tuning coil set
26	1	09661-332.01	2x Bracket	105		09216-941.01	LW-RF tuning coil set
27	1	09661-342.01	4x Ornamental ring	106		09216-942.01	MW-RF tuning coil set
28		15038-083.01	Scale compl. (49 M)	107		09647-623.97	3x Ferrite tuning slug
29		15038-085.01	Scale compl. (41 M)	108		09647-036.25	3x Tuning coil compl.
30		15038-087.01	Scale compl. (31 M)	109		09647-803.97	3x Ferrite sleeve
31		15038-089.01	Scale compl. (25 M)	110		19701-027.08	Tuning capacitor compl.
32		15038-091.01	Scale compl. (19 M)	110.1		09666-634.00	Pinion
33		15038-093.01	Scale compl. (16 M)				FM Unit
34		15038-095.01	Scale compl. (13 M)				FM unit compl.
35		15038-097.01	Scale compl. (11 M)	120	4	19420-010.00	FM-RF coil pack
36	2	15038-075.01	Scale compl. (AM)	122	4	09226-125.01	FM-filter circuit coil
37	2	15038-077.01	Scale compl. (FM)	123	4	09226-193.01	FM-oscillator coil pack
38		15035-101.00	Mask	124	4	09226-234.01	FM-tuning slug
39		15035-102.00	Mask	125		09647-681.97	2x Tuning slug
40		15015-162.00	8x Scale retainer	126		09647-663.97	Tuning slug
41	2	15035-103.00	Cover disc	127	4	07202-001.97	2x IF filter ZF 1/111
			Chassis	128	4	07202-067.97	IF filter ZF 11
51		09618-083.02	4x Contact spring	129	4	07202-066.97	2x IF filter ZF IV/VI
52		09618-103.00	2x Contact spring	130	4	07202-065.97	2x IF filter ZF V/VII
53		05113-223.00	Contact spring	131	4	07202-016.97	IF filter ZF VIII
54	2	09612-309.02	6x Drive pulley	132	4	07202-044.97	IF filter ZF IX
55	2	09612-316.00	2x Drive pulley	133	4	07202-045.97	IF filter ZF X
56		09604-658.00	6x Washer	134	4	8140-525-007	Choke
				135	4	09239-029.01	VHF choke (wound on R 311)

Pos. No.	Fig. No.	Part No.	Description	Pos. No.	Fig. No.	Part No.	Description
			FM Unit contd.	213.1	3	09626-144.00	Female connector
136		09218-191.97	Ferrite choke	213.2	3	19703-024.01	Tuning control
137		09647-020.97	2x Ferrite bead	213.3		09238-650.97	RF-transformer
138		09647-022.97	Ferrite bead	213.4		09238-171.00	RF-choke
139		09622-469.00	Coaxial plug	219.5		8316-216-001	Neon bulb 76 120
140		09622-470.00	Screen cap				
141		07248-336.00	Sleeve				SW Tuner
142		8302-222-901	(T301)	229	3	19415-009.00	SW tuner compl.
143		8302-220-441	(T302...308)	230		15035-144.00	Coil drum
144		8302-200-233	(T309)	231		15035-148.00	Locating piece
145		8302-200-231	(T310)	232		15035-272.00	Bearing bush
146		8309-510-197	(D301/302)	233		09603-585.00	Clamping ring
147		8309-510-198	(D303)	234		15035-140.00	2x Roller
148		8309-201-018	(D304)	235		15035-149.00	2x Rest Lever
149		8309-001-002	(D305...308)	236		09619-119.00	Tension spring
150		8309-701-102	(St.301/302)	237		09603-701.00	4x Drive pulley spindle
151		8309-215-050	(D309)	238		15035-105.00	Spring
152	4	19799-311.91	(C318) trimmer cap.	239		15035-147.00	Bearing
153	4	19799-313.91	(C302) trimmer cap.	240		15035-133.00	Drive spindle
154	4	19799-314.91	(C306) trimmer cap.	241	2	8138-003-005	Cord 0.3 Ø
155	4	8790-294-042	(R381— preset pot.	241a		15035-270.00	Spring
156	4	8790-209-008	(R356/361) preset pot.	242		09631-314.00	3x Rubber grommet
			Coil set	243		19701-026.97	Tuning capacitor
			(19415-007.00)	244		15035-142.00	Rejector
160	3	19400-041.03	Push button unit	245		15035-050.00	Drive wheel
161	3	19400-043.03	Touch button	246		09603-566.00	Clamping ring
162	3	19400-044.03	Touch button	247	2	09612-309.02	4x Drive pulley
163	3	19400-050.03	Touch button	248		09604-658.00	4x Washer
165		39600-210.00	Female connector compl.	249	2	8138-007-021	Drive cord TE50 P (black) 0.5 Ø
166		39600-204.00	Female connector compl.	250	2	09619-113.00	Tension spring
167		39600-203.00	2x Female connector compl.	252		15015-154.00	Lever
168		39600-109.00	Female connector compl.	253		15015-143.00	Lever spring
178		09223-406.21	LW-coupling coil pack	255		09622-079.00	Socket compl.
179		09223-407.21	LW-RF coil pack	258	6	19311-168.00	Tuner board compl.
180		09223-409.21	MW-RF coil pack	258.1		15015-132.00	18x Spring
181		09647-648.97	Ferrite tuning slug (for No. 178)	258.2		19706-031.00	Slider switch
181a		09647-649.97	Ferrite tuning slug (f. No. 179/180)	258.3	6	19202-340.97	IF filter ZF XI
182	5	09223-408.21	MW-coupling coil pack	258.4	6	19202-341.97	IF filter ZF XII
183	5	09223-516.21	SW1-RF coil pack	258.5	6	19202-314.97	IF filter ZF XIII
184	5	09223-517.21	SW2-RF coil pack	258.6		8382-241-097	Quartz-filter
185	5	09223-678.21	LW-oscillator coil	258.8	6	8140-525-018	Choke
186	5	09223-679.21	MW-oscillator coil	258.9	6	09202-235.21	SW-oscillator coil
187	5	09223-479.21	SW1-oscillator coil pack	258.91	6	09647-616.97	Tuning slug
188		09647-684.97	Tuning slug (f. No. 183-187)	258.10	6	09218-025.01	HF-choke
189	5	19202-323.97	SW2-filter circuit coil	258.12		09647-022.95	2x Ferrite bead
190		8140-525-018	Choke	258.13		09647-022.97	Ferrite bead
191	5	09223-480.21	SW2-oscillator coil	258.14		09647-020.97	Ferrite bead
191.1		09647-663.97	Tuning slug	258.16		09622-469.00	Coaxial plug
192	5	19202-314.97	IF transformer	258.17		09622-470-00	Screen cap
193		09647-020.97	Ferrite bead	258.18		07248-336.00	Sleeve
194		09622-469.00	Coaxial plug	258.20		8302-200-041	(T201/202/205)
195		09622-470.00	Screen cap	258.21		8302-200-233	(T203)
196		07248-336.00	Sleeve	258.22		8302-222-040	(T204/206/207)
197		15035-045.00	2x Board carrier	258.24		8309-214-114	(D201/202)
199		8302-200-041	(T401/404)	258.25		8309-701-081	(St.201)
200		8302-222-040	(T402/403)	258.26	6	19799-321.91	(C259) Trimmer cap.
201		8309-214-114	(D401/402)	258.27	6	19799-301.13	(C214) Trimmer cap
202		8309-701-081	(St.401)	260		19415-121.00	Coil set SW 3/49m
203	5	19799-323.91	(C444) Trimmer cap.	261		19415-122.00	Coil set SW 4/41m
204	5	19799-324.91	4x Trimmer cap.	262		19415-123.00	Coil set SW 5/31m
205	5	19799-325.91	5x Trimmer cap.	263		19415-124.00	Coil set SW 6/25m
206	5	19799-326.91	4x Trimmer cap.	264		19415-125.00	Coil set SW 7/19m
207	5	8790-009-047	(R472) Preset pot	265		19415-126.00	Coil set SW 8/16m
208	5	8790-009-152	(R473) Preset pot	266		19415-127.00	Coil set SW 9/13m
209	5	8790-009-025	(R652) Preset pot	267		19415-128.00	Coil set SW10/11m
211	5	19310-528.00	Transducer compl. 30V	275	7	19311-163.00	AM-IF Board
211.1		8140-525-118	Ferrite choke	276		19706-019.00	AM-IF board compl.
211.2		8309-215-050	(D311)	277		19706-020.00	Toggle switch (tuning/batt.)
211.3		8305-302-720	(IC301) Integr. circuit	278		19706-021.00	Toggle switch (AFC)
211.4		8790-209-005	(R341) Preset pot	279	2	15035-125.00	Toggle switch (Bandwidth)
213		19311-153.00	Socket board compl.	281	2	39601-670.01	Trimmer bearing
							Pin contact — lower part (flat)

Pos. No.	Fig. No.	Part No.	Description	Pos. No.	Fig. No.	Part No.	Description
			FM Unit contd.	369		8309-707-110	(St.602)
282		39600-203.00	Female connector compl.	370		8309-215-021	(D602)
283		39600-204.00	Female connector compl.	371		8309-215-050	(D603)
284		39600-210.00	Female connector compl.	372	9	8446-797-109	(C656) Elco
289	2	39705-028.00	Meter	373	9	8410-810-005	(C658) Elco
290		09622-079.00	Socket compl.	374	9	8410-820-020	(C627) Elco
291	7	19202-316.97	IF filter ZF XV	375	9	8713-065-035	(R653) Metallised resistor
292	7	19202-317.97	IF filter ZF XVI	376	9	8713-080-057	(R639) Metallised resistor
293	7	19202-318.97	IF filter ZF XVII	377	9	8700-229-053	(R658) Resistor
294	7	19202-336.97	IF filter ZF XVIII	379	9	8790-290-038	(R636) Preset pot
294a		8602-099-001	Ceramic oscillator	380	2/9	19703-029.97	(R622) Potentiometer (volume)
295	7	09227-090.21	AF choke				
296	7	8140-525-132	Ferrite choke	381	2/9	19703-030.97	(R612) Potentiometer (Bass)
297		8316-113-102	2x Pilot bulb				
298		8302-200-041	(T501)	382	2/9	19703-031.97	(R611) Potentiometer (Treble)
299		8302-222-040	(T502)				
300		8302-200-220	(T503/504)				
301		8309-002-002	(D501)				PCB with Switches
302		8309-207-008	(D502)	390		19310-480.00	PCB with switches compl.
303		8309-701-102	(St.501/502)	391		19706-019.00	Tip switch (bulb)
304	7	19701-028.00	(C552) Trimmer cap 100pF	392		19706-020.00	Tip switch (loudspeaker)
305	7	8790-009-021	(R519) Preset pot	393		19706-025.00	Tip switch (counter)
306	7	8790-009-027	(R514) Preset pot	394		19706-026.00	Tip switch (mains)
307	7	8790-009-024	(R507) Preset pot				Power supply unit PCB
				400	3	19310-474.00	P.S.U. board compl.
310	8	19311-174.00	SSB Board	401	3	15035-164.00	Voltage selector compl.
311	8	19706-020.00	2x SSB board compl.	402	3	09623-084.00	6x Speaker socket
312	2	19703-038.97	Toggle switch	403		09621-113.02	Fuse holder
314	8	09227-974.21	Rotary switch	404	3	39601-872.01	Pin contact-lower section
315		09647-020.97	2x AF choke				Rectifier
316		07220-510.00	Ferrite bead	408		8309-215-021	(D601)
317		8302-200-041	IF oscillator coil				Frequency-counter
318		8302-222-040	(T701/702)				(15035-200.00)
319		8302-202-543	(T703)				Amplifier Board
320		8302-200-233	(T704)				Amplifier board compl.
321		8302-200-230	(T705)	419	10	19311-129.00	Coaxial socket 3-fold
322		8309-001-106	(D701/702)	420	10	15035-155.00	Pin contact-lower section
323		8309-215-050	(D703/704)	421	10	39601-667.01	(flat)
324	8	19799-323.04	(C709) Trimmer cap.				Choke
325	8	8790-009-017	(R703) Preset pot	422	10	8140-525-024	(T802)
326	2/8	19703-037.97	(R716) Potentiometer	423		8302-220-414	(T801/803)
327	8	19799-321.91	(C711) Trimmer cap.	424		8302-220-034	(T806)
				425		8302-202-558	(T804/807)
			Tuning coil set	426		8302-202-538	(T805)
335	2	19415-010.00	Tuning coil set compl.	427		8302-200-559	(D801)
335.1		15035-172.00	Tuning coil set-housing	429		8309-215-050	(IC801) Integr. circuit
335.2		09216-194.01	Oscillator coil	430	10	8305-190-112	(IC802/803) Integr. circuit
			(fine adjustment)	431	10	8305-199-093	(IC807) Integr. circuit
335.3		15035-173.00	Spindle	432	10	8305-200-598	(Th. 801...805)
335.4		09647-049.97	Tuning coil core	434	10	8309-505-044	
335.5		15035-174.00	Toothed rack				Indicator Board
335.6		09619-763.00	Spring	440		19311-134.00	Indicator board compl.
				441	2	8309-909-941	5x LED display HA 1141 R
			AF-unit				Parts for 5V converter
			(19310-469.00)				5V converter compl.
350		15035-116.00	Spacer	445	11	19311-196.00	Converter coil
351		09647-020.97	4x Ferrite bead	447	11	09227-050.21	2x Choke
352		09647-022.97	3x Ferrite bead	448	11	09238-191.01	Ferrite rod core
353		09647-021.97	Ferrite bead	448.1		09647-009.97	(T808)
355		50002-052.00	Fuse spring	449		8302-202-538	(T809)
356		8302-200-551	(T601)	450		8302-200-233	(T810)
357		8302-200-309	(T602)	451		8302-210-136	(St.801)
358		8302-202-538	(T603)	452		8309-701-081	(St.802)
359		8302-200-427	(T604)	453		8309-715-008	(D803)
360		8302-400-108	(T605)	454		8309-703-016	(D802)
361		8302-202-127	(T609)	455		8309-204-050	(IC808) Integr. circuit
362		8302-410-363	(T606)	456	11	8305-301-761	(R876) Preset pot
363		8302-410-364	(T607)	457	11	8790-209-048	
364		8302-210-018	(T608)				MOS-IC-Board
365		8302-210-132	(T610)				IC board compl.
366		8309-701-102	(St.601)	470		19311-179.00	(IC 806) Integr. circuit
367		8309-001-017	(St.603)	471		8305-307-578	
368		8309-650-003	(St.604/605)				

Pos. No.	Fig. No.	Part No.	Description	Pos. No.	Fig. No.	Part No.	Description
			Oscillator board	491.1	1	15038-106.00	Window
480		19311-139.00	Oscillator board compl.	492		15035-267.00	Contact bridge
482		8382-241-197	Crystal 5.12MHz	493		15038-112.00	Lid
483		8305-199-093	(IC805) Integr. circuit	494		15038-114.00	Contact
484		8305-199-000	(IC804) Integr. circuit	495		15038-115.00	Contact
485		19799-336.94	(C854) Trimmer cap.	497		15038-251.51	Clock module compl.
			Quartz clock	497.1	1	15038-122.01	2x Button
			(15038-250.51)				
491	1	15038-101.01	Clock housing compl.				

NOTES:

19310-474.00
Netzteil-Platte, Bestückungsseite
POWER-SUPPLY BOARD, COMPONENT SIDE
PLAQUE D'ALIMENTATION, COTE COMPOSANTS
PIASTRA DI ALIMENTAZIONE, LATO COMPONENTI

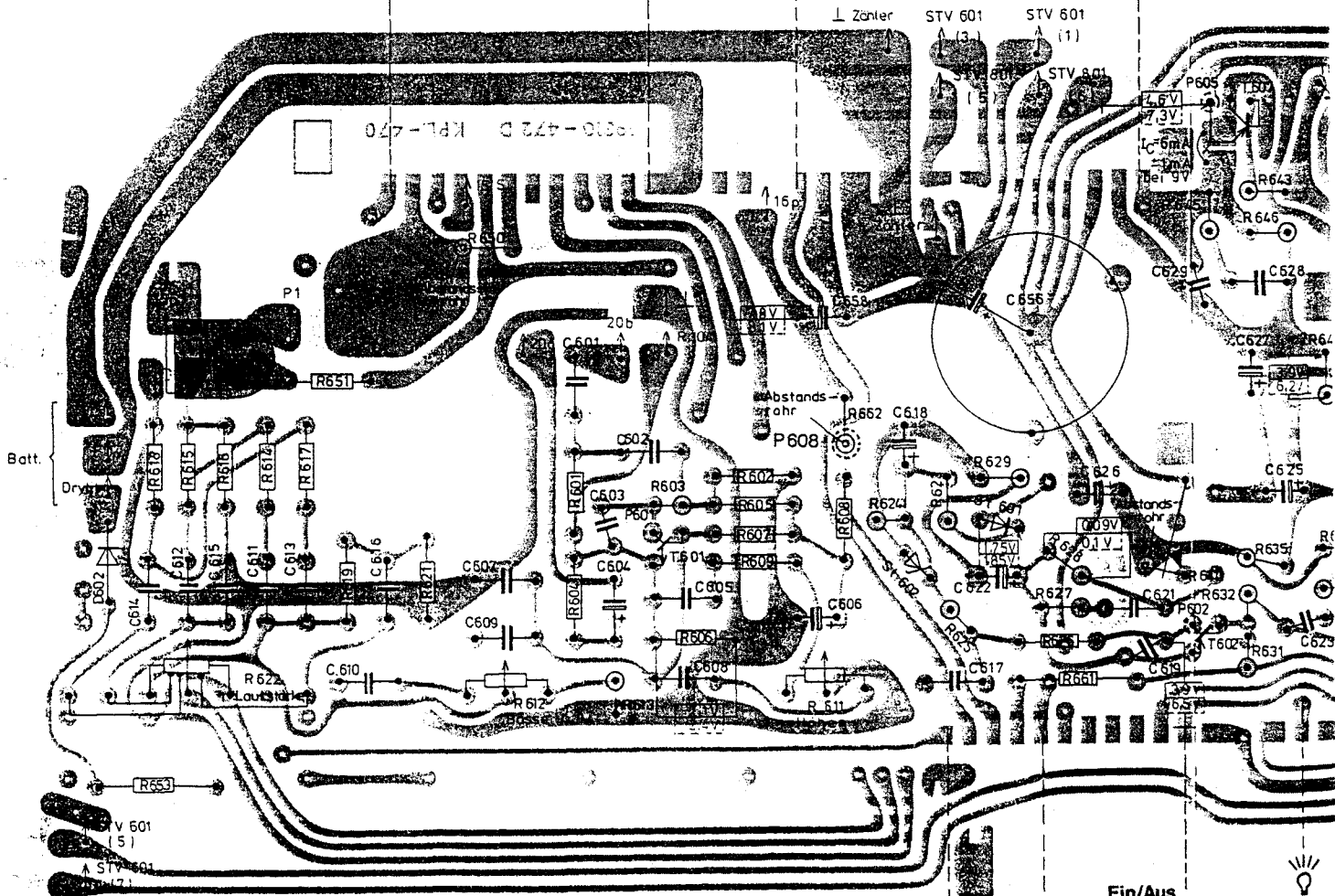
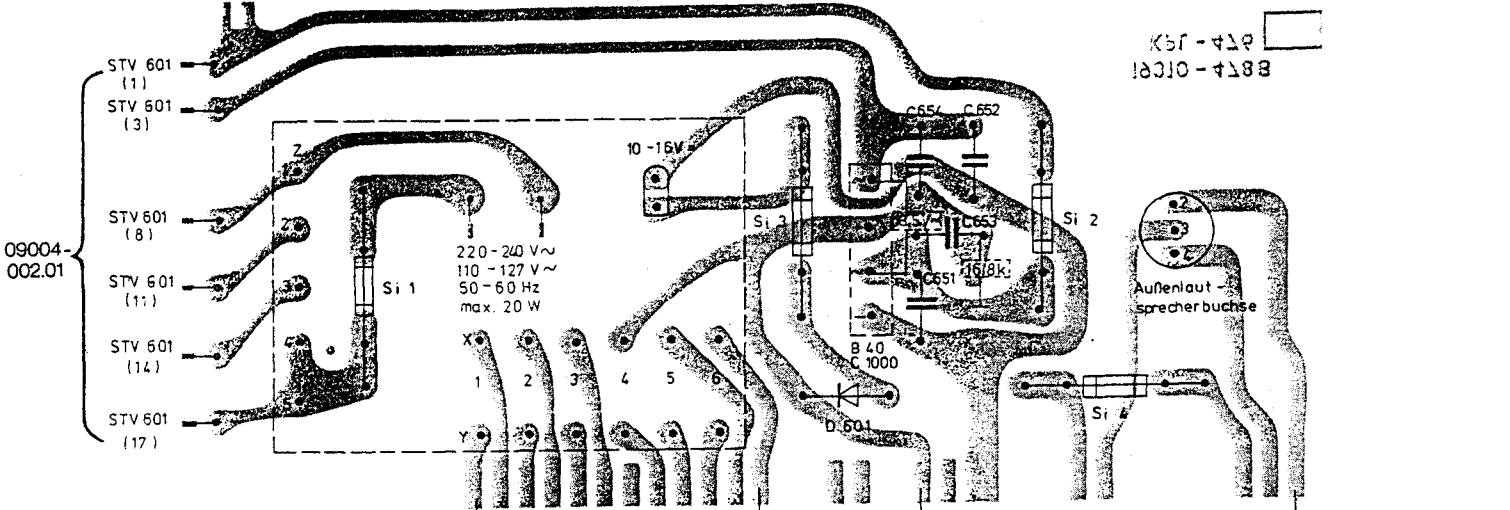

19310-480.00
Schalterplatte, Bestückungsseite
SWITCH BOARD, COMPONENT SIDE
PLAQUE COMMULATEURS, COTE COMPOSANTS
PIASTRA DI COMMUTATORE, LATO COMPONENTI

komponentenseite
COMPONENT SIDE
VUE DU COTE DES COMPOSANTS
LATO COMPONENTI

Lötseite
SOLDER SIDE
COTE DES SOUDURES
LATO SALDATURE

Bestückungsseite
COMPONENT SIDE
VUE DU COTE DES COMPOSANTS
LATO COMPONENTI

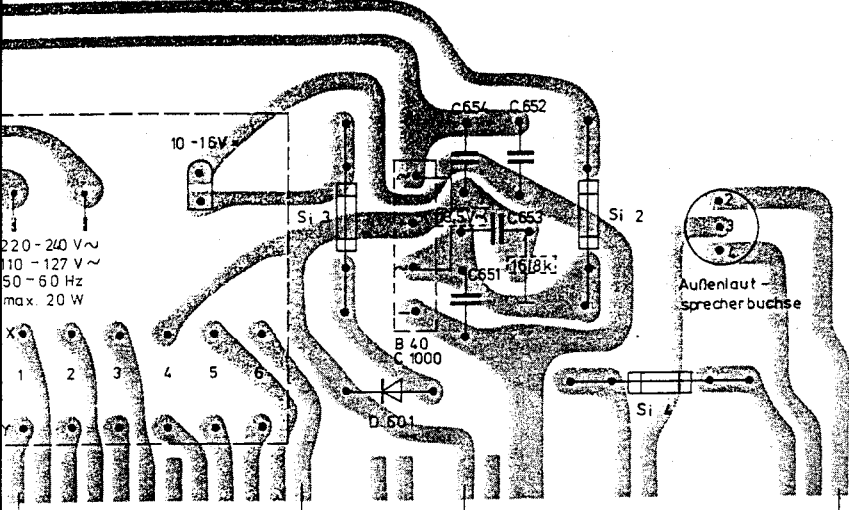

19310-469.00
NF-Teil, Lötseite
AF-UNIT, SOLDER SIDE
PARTIE-FA, COTE SOUDURES
PARTE-BF, LATO SALDATURE

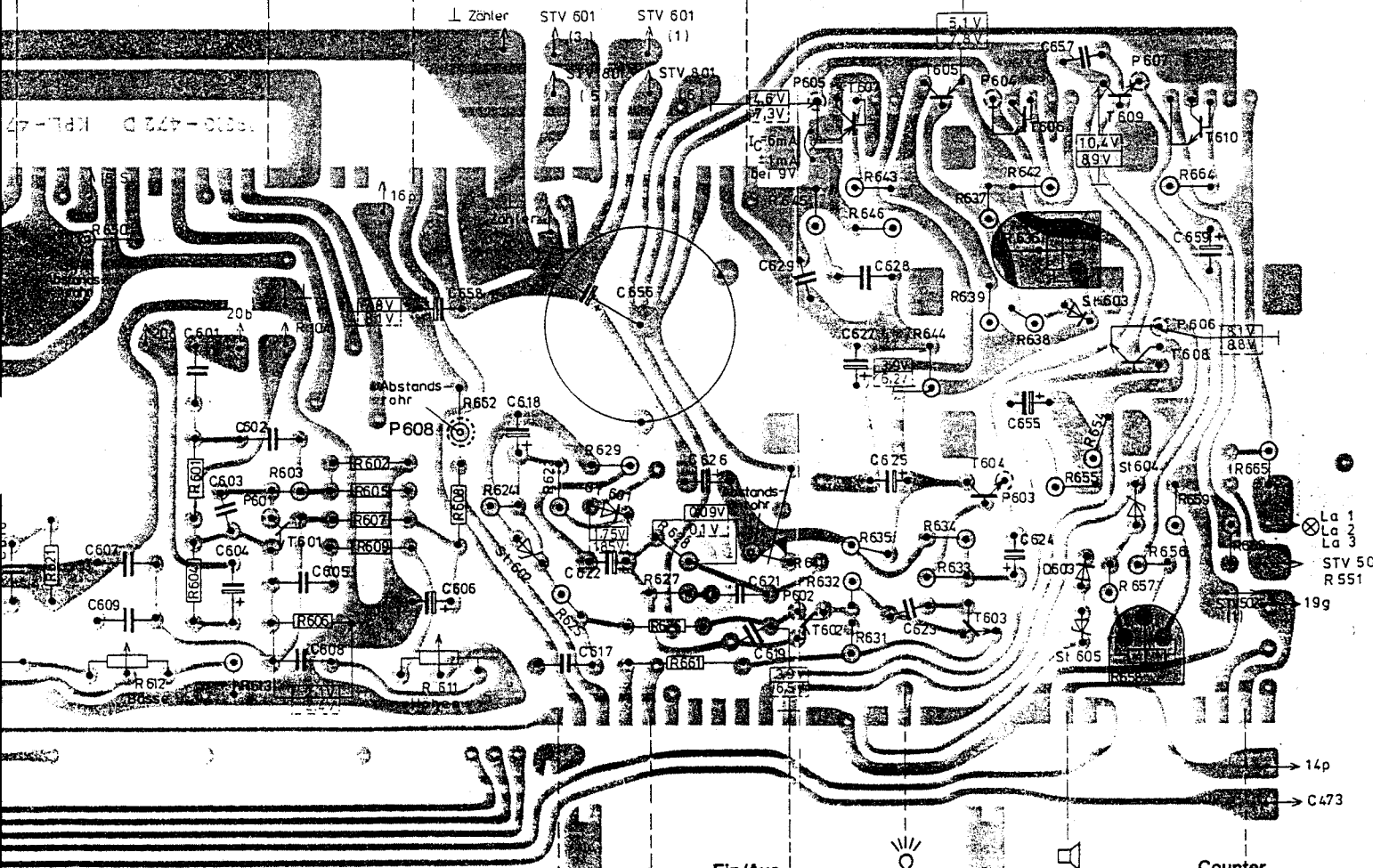

komponentenseite
COMPONENT SIDE
VUE DU COTE DES COMPOSANTS
LATO COMPONENTI

Ein/Aus Counter

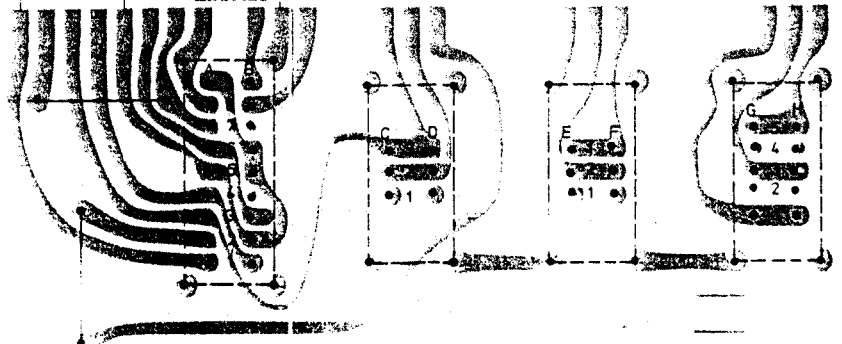

Lötseite
SOLDER SIDE
COTE DES SOUDURES
LATO SALDATURE

Bestückungsseite
COMPONENT SIDE
VUE DU COTE DES COMPOSANTS
LATO COMPONENTI

19310-469.00
NF-Teil, Lötseite
AF-UNIT, SOLDER SIDE
PARTIE-FA, COTE SOUDURES
PARTE-BF, LATO SALDATURE

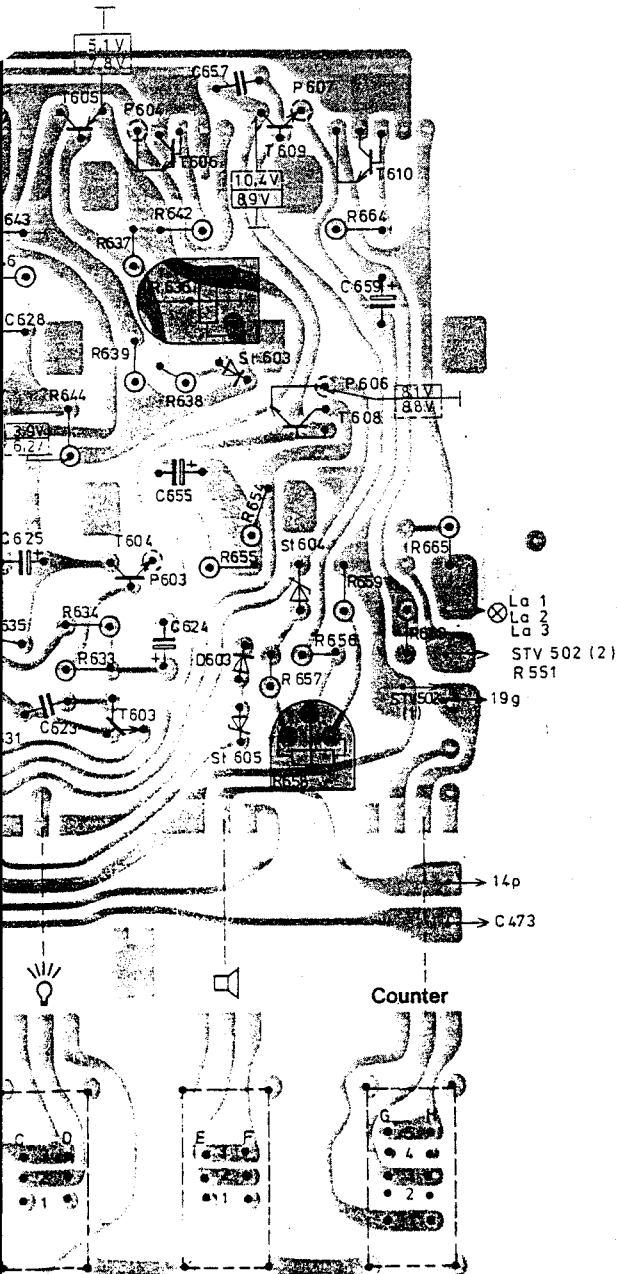

19311-168.00
Tuner-Platte, Lötseite
TUNER-BOARD, SOLDER SIDE
PLAQUE-TUNER, COTE SOUDURES
PIASTRA-TUNER, LATO SALDATURE

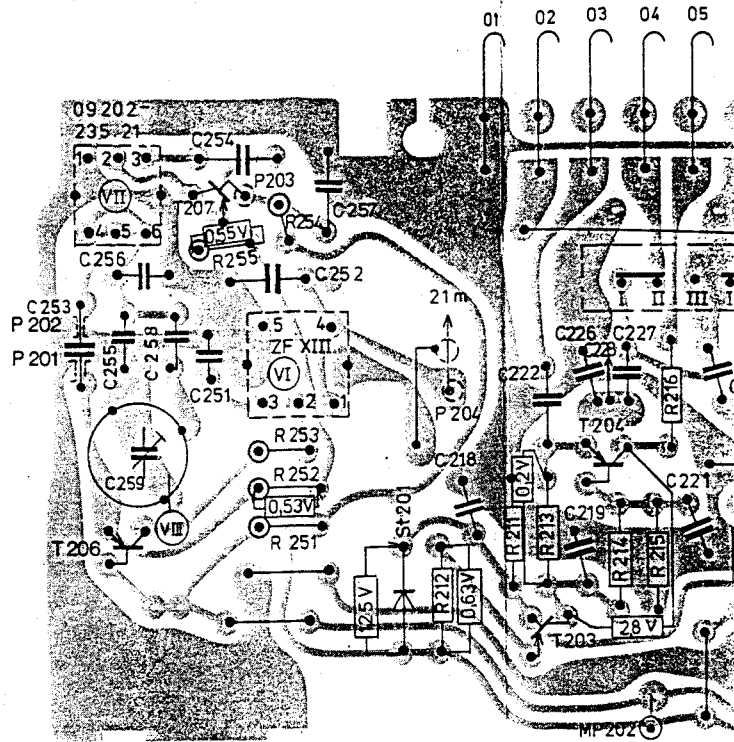

19310-528.00
30V-Wandler, Lötseite
30V-TRANSFORMER, SOLDER SIDE
TRANSDUCTEUR 30V, COTE SOUDURES
CONVERTITTORE 30V, LATO SALDATURE

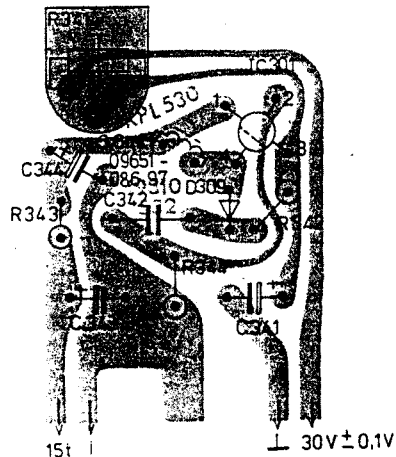

1-168.00
 er-Platte, Lötseite
 ER-BOARD, SOLDER SIDE
 QUE-TUNER, COTE SOUDURES
 TRA-TUNER, LATO SALDATURE

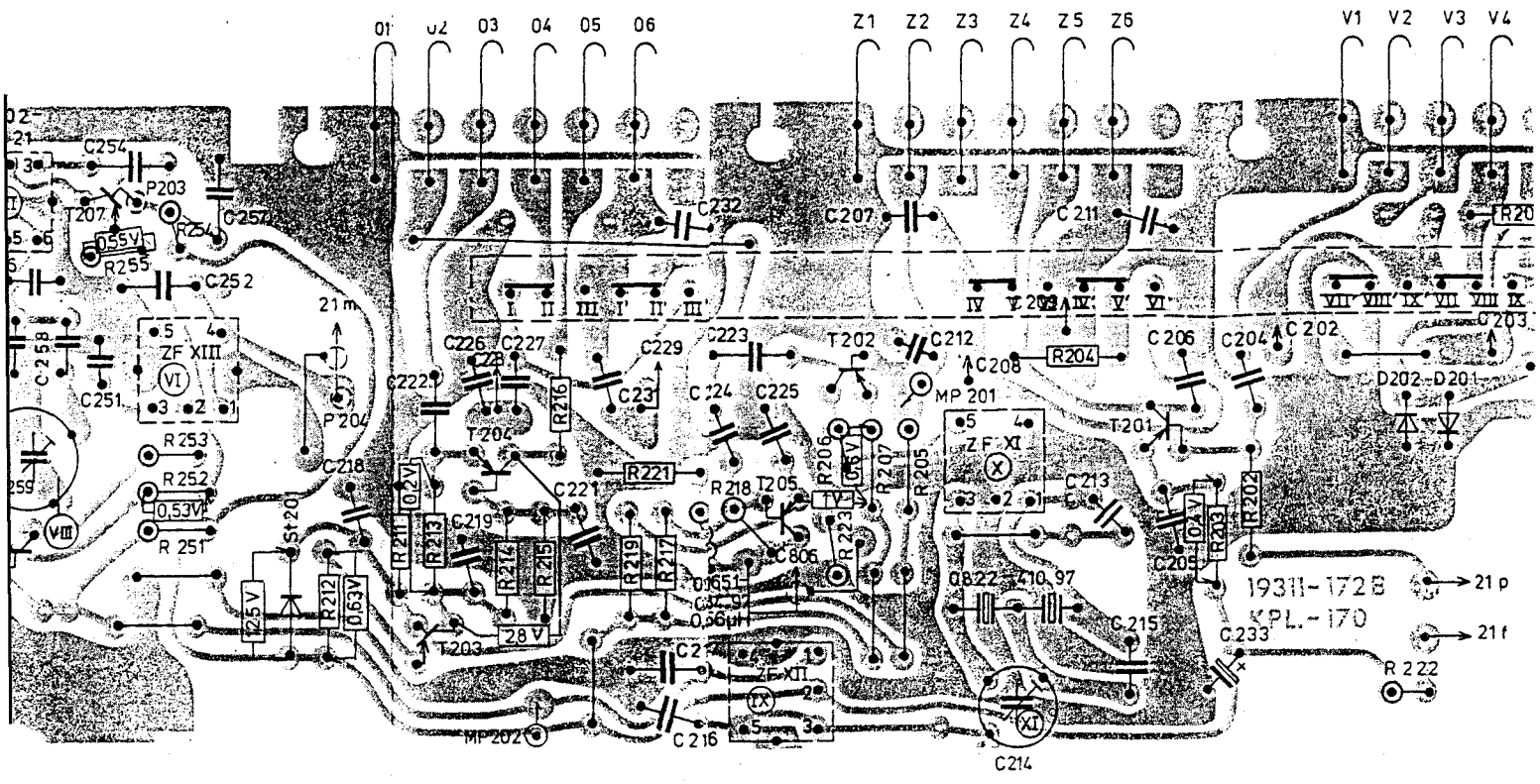

0-528.00
 Wandler, Lötseite
 TRANSFORMER, SOLDER SIDE
 ISDUCTEUR 30 V, COTE SOUDURES
 VERTITORE 30 V, LATO SALDATURE

Kontaktplatte, Lötseite
 CONTACT PLATE, SOLDER SIDE
 PLAQUE DE CONTACT, COTE SOUDURES
 PIASTRA DI CONTATTO, LATO SALDATURE

Oszillatorkreis
 OSCILLATOR CIRCUIT
 CIRCUIT D'OSCILLATEUR
 CIRCUITO OSCILLATORE

Zwischenkreis
 INTERMEDIATE CIRCUIT
 CIRCUIT INTERMEDIAIRE
 CIRCUITO INTERMEDIO

Vorkreis
 INPUT CIRC
 CIRCUIT D'
 PRESTADIO

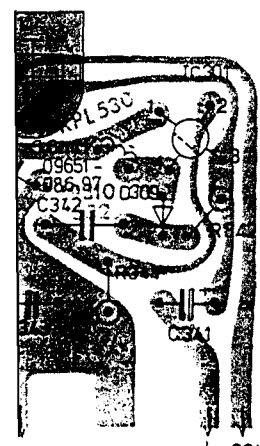

30V ± 0.1V

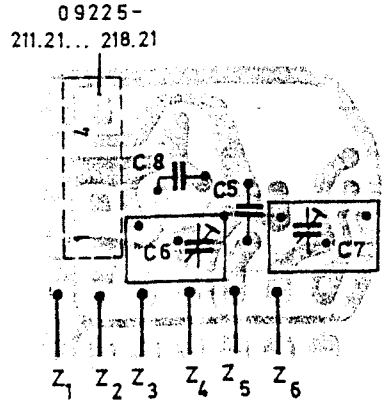
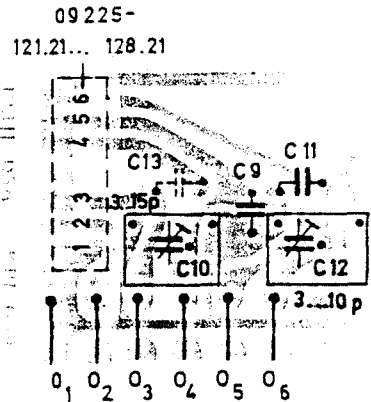

19415 - 121.00... -128.00

19311-179.00
MOS JC - Platte, Lötseite
MOS JC-BOARD, SOLDER SIDE
PLAQUE-MOS JC, COTE SOUDURES
PIASTRA-MOS JC, LATO SALDATURE

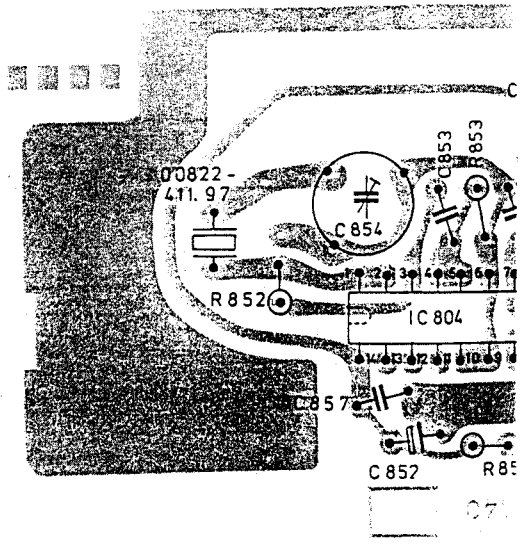
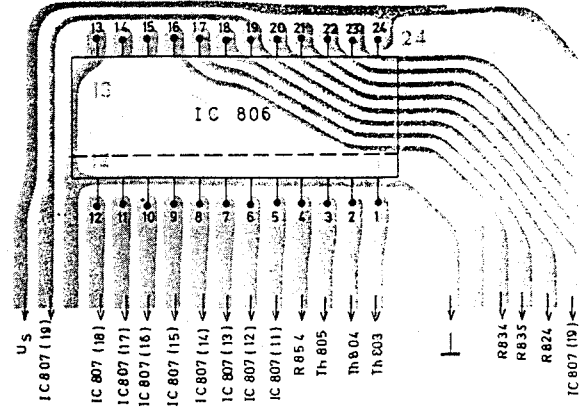
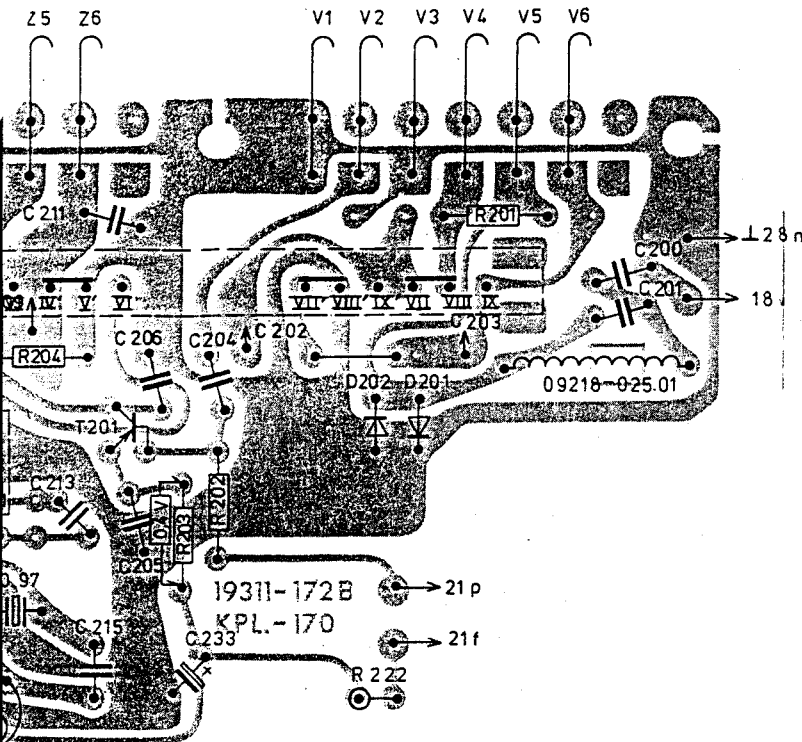

Wochenkreis
 INTERMEDIATE CIRCUIT
 CIRCUIT INTERMEDIAIRE
 CIRCUITO INTERMEDIO

Vorkreis
 INPUT CIRCUIT
 CIRCUIT D'ENTREE
 PRESTADIO

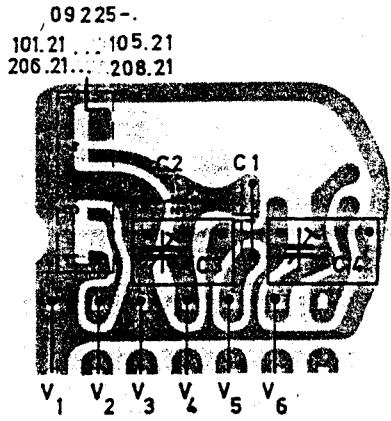
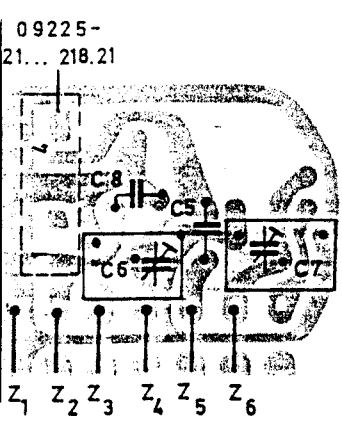

19311-139.00
Oszillator-Platte, Lötseite
OSCILLATOR-BOARD, SOLDER SIDE
PLAQUE-OSCILLATEUR, COTE SOUDURE
PIASTRA OSCILLATORE, LATO SALDATURE

19415 - 121.00... -128.00

Lötseite
SOLDER SIDE
COTE DES SOUDURES
LATO SALDATURE

9311-179.00
OS JC- Platte, Lötseite
OS JC-BOARD, SOLDER SIDE
LAQUE-MOS JC, COTE SOUDURES
ASTRA-MOS JC, LATO SALDATURE

19311-203.00
Anzeige-Platte, Bestückungsseite
DISPLAY-BOARD, COMPONENT SIDE
PLAQUE D'AFFICHAGE, COTE COMPOSANTS
PIASTRA INDICATORE, LATO COMPONENTI

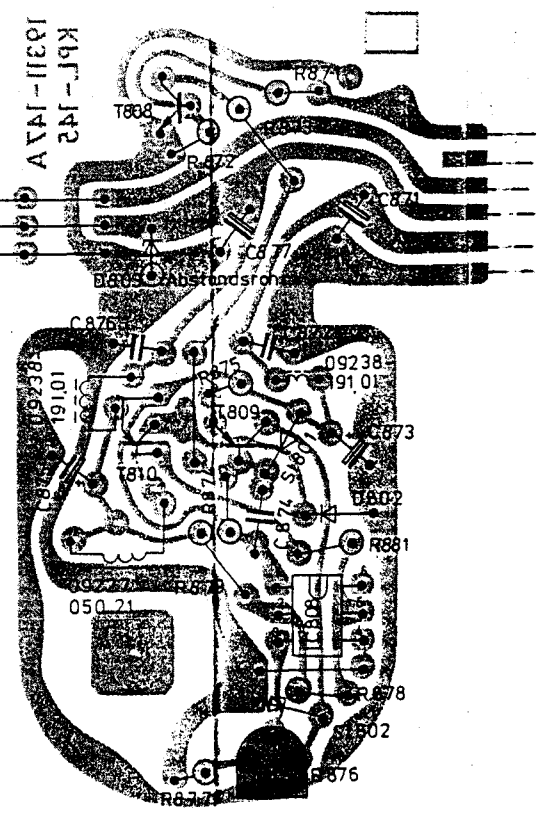
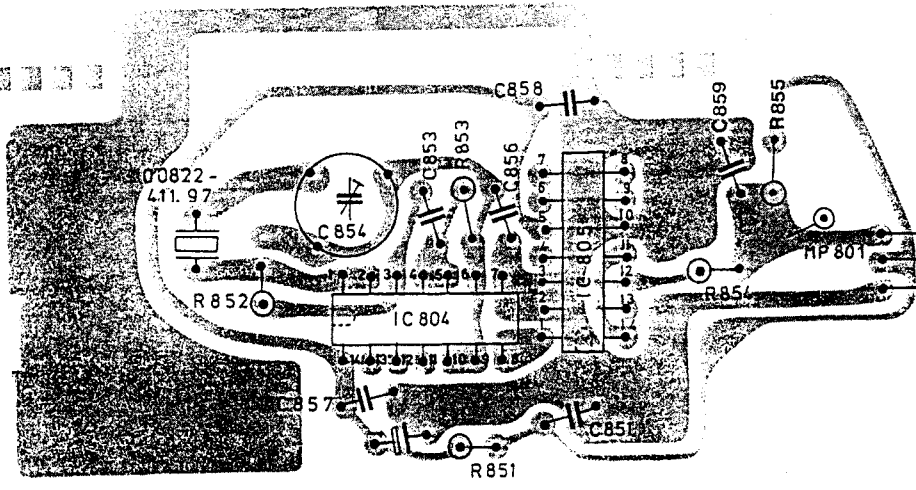
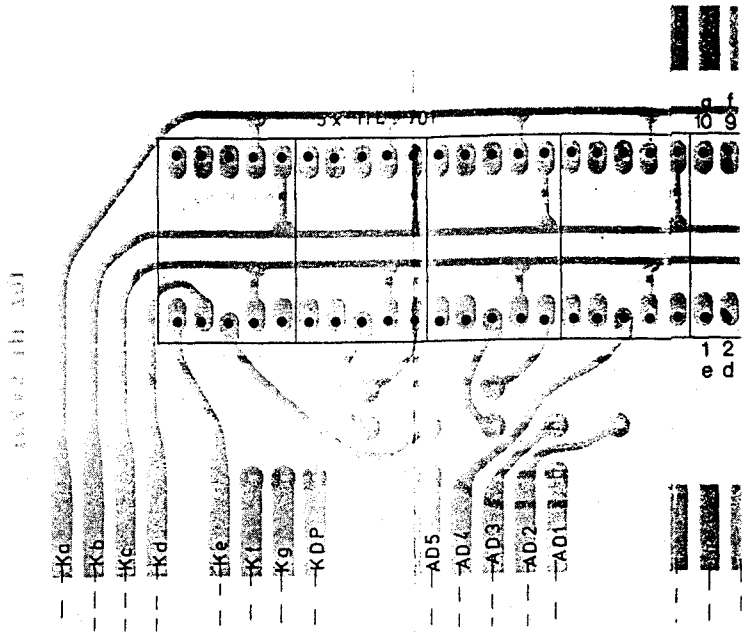
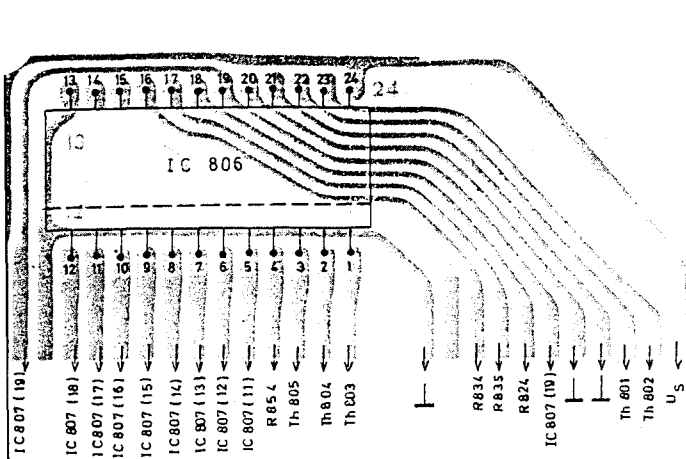

19311-139.00
Oszillator-Platte, Lötseite
OSCILLATOR-BOARD, SOLDER SIDE
PLAQUE-OSCILLATEUR, COTE SOUDURES
PIASTRA OSCILLATORE, LATO SALDATURE

19311-196.00
5V-Wandler, Bestückungsseite
5V-TRANSFORMER, COMPONENT SIDE
TRANSDUCTEUR-5V, COTE COMPOSANTS
CONVERTITTORE-5V, LATO COMPONENTI

Lötseite
SOLDER SIDE
COTE DES SOUDURES
LATO SALDATURE

Bestückungsseite
COMPONENT SIDE
VUE DU COTE DES COMPOSANTS
LATO COMPONENTI

19311 - 134.00
Anzeige-Platte, Bestückungsseite
DISPLAY-BOARD, COMPONENT SIDE
PLAQUE D'AFFICHAGE, COTE COMPOSANTS
PIASTRA INDICATORE, LATO COMPONENTI

Seite
IT SIDE
COMPONENTS
COMPONENTI

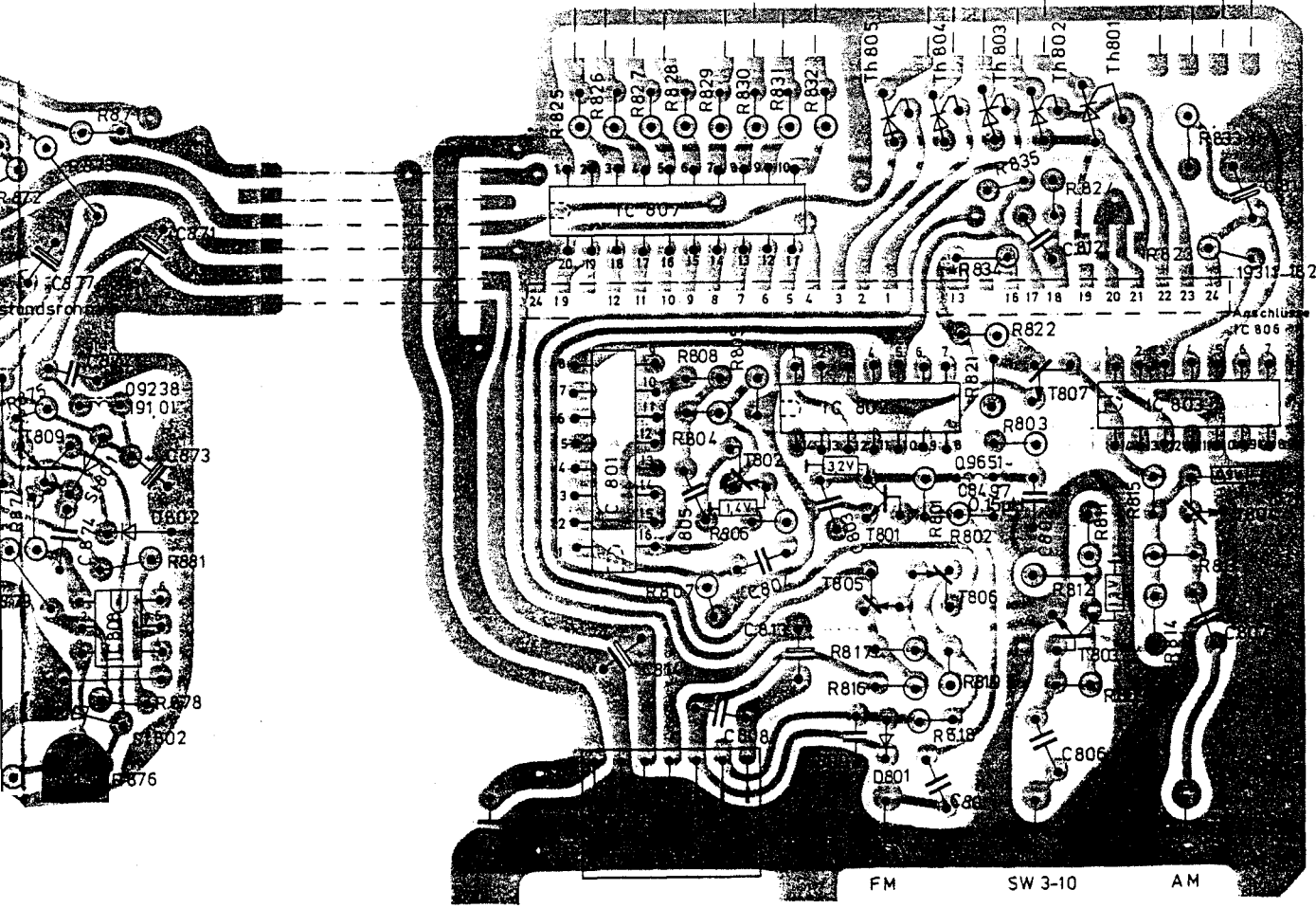
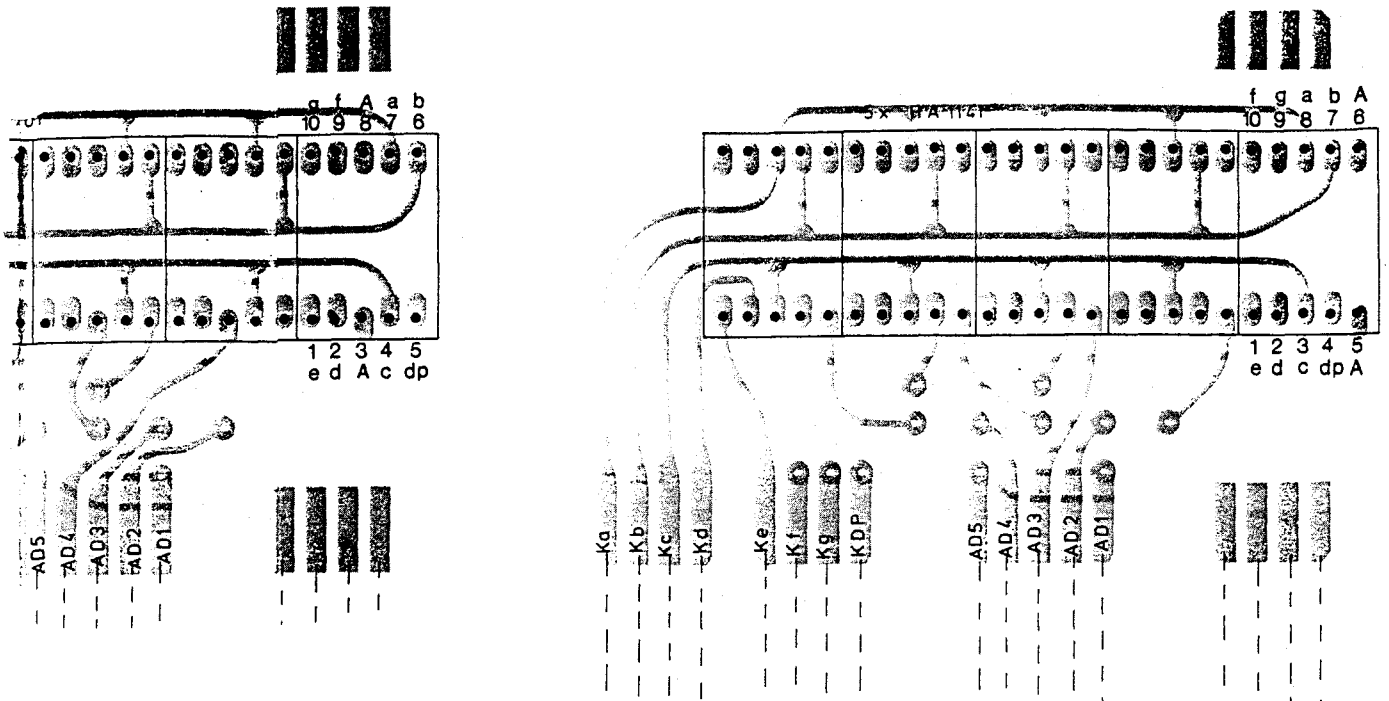

FM SW 3-10 AM

Bestückungsseite
COMPONENT SIDE
R-5V, COTE COMPOSANTS
R-5V, LATO COMPONENTI

19311 - 129.00
Verstärkerplatte, Lötseite
AMPLIFIER BOARD, SOLDER SIDE
PLAQUE AMPLIFICATEUR, COTE SOUDURES
PIASTRA AMPLIFICATORE, LATO SALDATURE

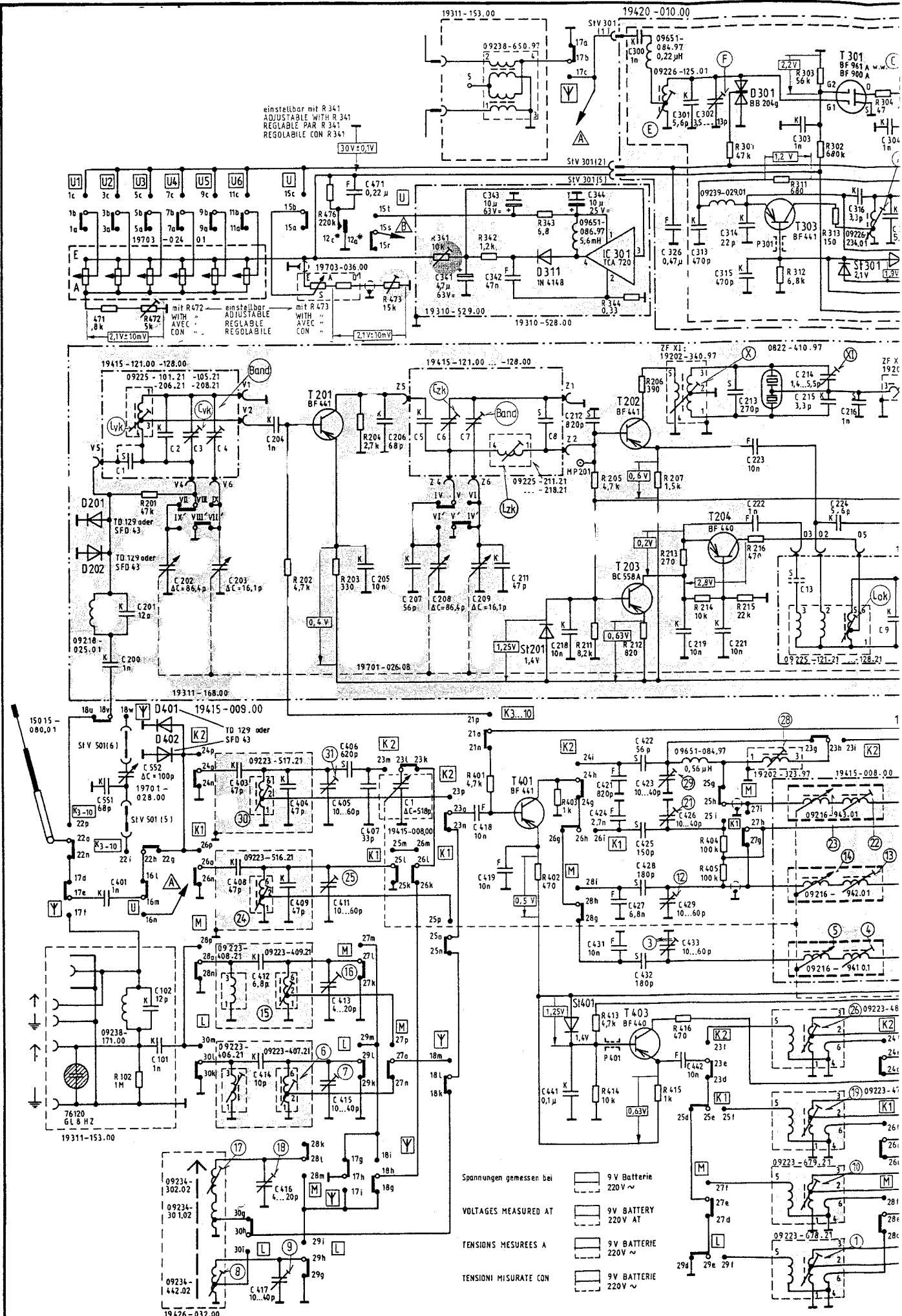

C :	200, 201, 1, 202, 2.3, 203, 204, 405, 406, 407, 411, 205, 206, 207, 208, 5, 6, 7, 361, 209, 211, 342, 343, 218, 344, 212, 300, 326, 301, 219, 313, 302, 221, 213, 314, 315, 222, 223, 303, 214, 215, 224, 216, 316, 31, 401, 551, 552, 102, 101, 403, 408, 412, 414, 416, 417, 404, 409, 411, 413, 415, 418, 419, 8, 441, 421, 424, 427, 431, 422, 425, 428, 432, 423, 426, 433, 429, 442, 13, 438, 434, 44
R :	471, 201, 472, 102, 476, 203, 204, 473, 341, 342, 343, 402, 403, 211, 205, 344, 206, 207, 21, 213, 301, 216, 311, 312, 302, 303, 313, 304, 471, 472, 473, 474, 475, 476, 477, 478, 479, 480, 481, 482, 483, 484, 485, 486, 487, 488, 489, 490, 491, 492, 493, 494, 495, 496, 497, 498, 499, 500, 501, 502, 503, 504, 505, 506, 507, 508, 509, 510, 511, 512, 513, 514, 515, 516, 517, 518, 519, 520, 521, 522, 523, 524, 525, 526, 527, 528, 529, 530, 531, 532, 533, 534, 535, 536, 537, 538, 539, 540, 541, 542, 543, 544, 545, 546, 547, 548, 549, 550, 551, 552, 553, 554, 555, 556, 557, 558, 559, 560, 561, 562, 563, 564, 565, 566, 567, 568, 569, 570, 571, 572, 573, 574, 575, 576, 577, 578, 579, 580, 581, 582, 583, 584, 585, 586, 587, 588, 589, 590, 591, 592, 593, 594, 595, 596, 597, 598, 599, 600, 601, 602, 603, 604, 605, 606, 607, 608, 609, 610, 611, 612, 613, 614, 615, 616, 617, 618, 619, 620, 621, 622, 623, 624, 625, 626, 627, 628, 629, 630, 631, 632, 633, 634, 635, 636, 637, 638, 639, 640, 641, 642, 643, 644, 645, 646, 647, 648, 649, 650, 651, 652, 653, 654, 655, 656, 657, 658, 659, 660, 661, 662, 663, 664, 665, 666, 667, 668, 669, 670, 671, 672, 673, 674, 675, 676, 677, 678, 679, 680, 681, 682, 683, 684, 685, 686, 687, 688, 689, 690, 691, 692, 693, 694, 695, 696, 697, 698, 699, 700, 701, 702, 703, 704, 705, 706, 707, 708, 709, 710, 711, 712, 713, 714, 715, 716, 717, 718, 719, 720, 721, 722, 723, 724, 725, 726, 727, 728, 729, 730, 731, 732, 733, 734, 735, 736, 737, 738, 739, 740, 741, 742, 743, 744, 745, 746, 747, 748, 749, 750, 751, 752, 753, 754, 755, 756, 757, 758, 759, 760, 761, 762, 763, 764, 765, 766, 767, 768, 769, 770, 771, 772, 773, 774, 775, 776, 777, 778, 779, 780, 781, 782, 783, 784, 785, 786, 787, 788, 789, 790, 791, 792, 793, 794, 795, 796, 797, 798, 799, 800, 801, 802, 803, 804, 805, 806, 807, 808, 809, 810, 811, 812, 813, 814, 815, 816, 817, 818, 819, 820, 821, 822, 823, 824, 825, 826, 827, 828, 829, 830, 831, 832, 833, 834, 835, 836, 837, 838, 839, 840, 841, 842, 843, 844, 845, 846, 847, 848, 849, 850, 851, 852, 853, 854, 855, 856, 857, 858, 859, 860, 861, 862, 863, 864, 865, 866, 867, 868, 869, 870, 871, 872, 873, 874, 875, 876, 877, 878, 879, 880, 881, 882, 883, 884, 885, 886, 887, 888, 889, 890, 891, 892, 893, 894, 895, 896, 897, 898, 899, 900, 901, 902, 903, 904, 905, 906, 907, 908, 909, 910, 911, 912, 913, 914, 915, 916, 917, 918, 919, 920, 921, 922, 923, 924, 925, 926, 927, 928, 929, 930, 931, 932, 933, 934, 935, 936, 937, 938, 939, 940, 941, 942, 943, 944, 945, 946, 947, 948, 949, 950, 951, 952, 953, 954, 955, 956, 957, 958, 959, 960, 961, 962, 963, 964, 965, 966, 967, 968, 969, 970, 971, 972, 973, 974, 975, 976, 977, 978, 979, 980, 981, 982, 983, 984, 985, 986, 987, 988, 989, 990, 991, 992, 993, 994, 995, 996, 997, 998, 999, 1000

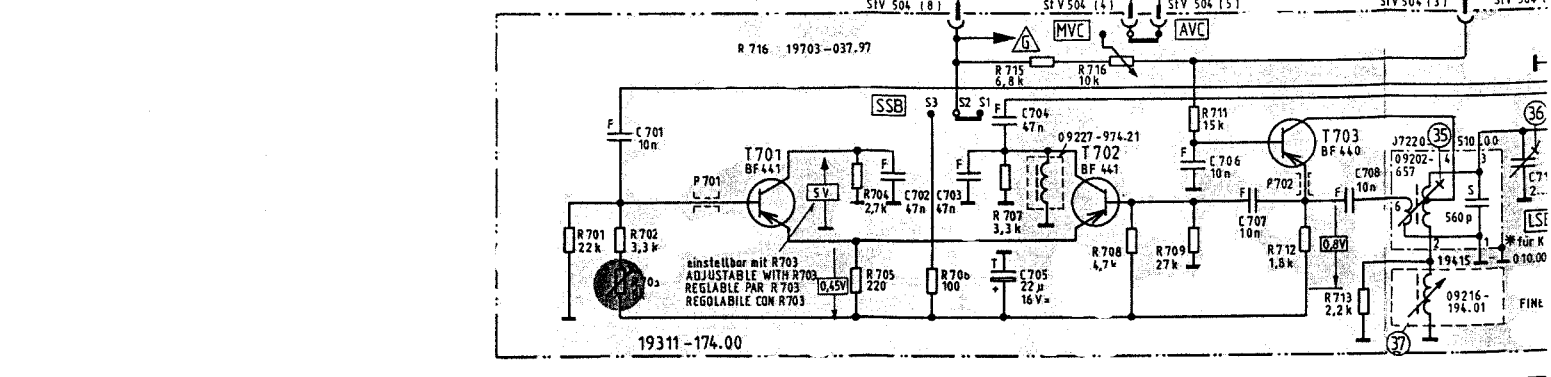
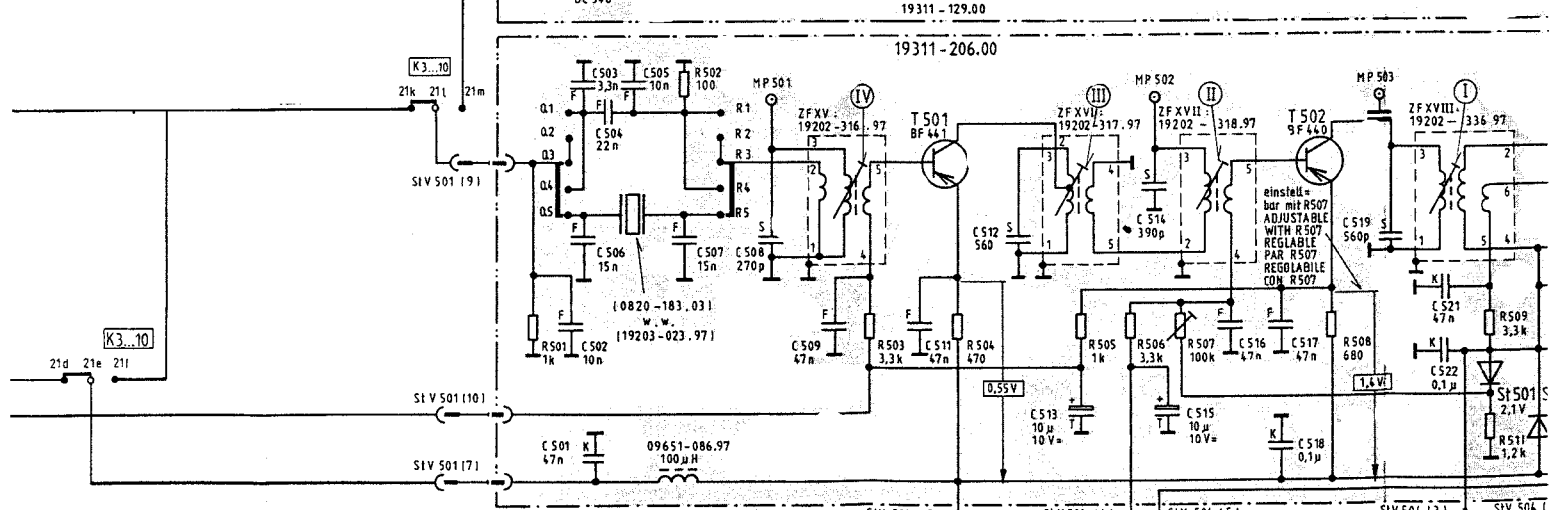
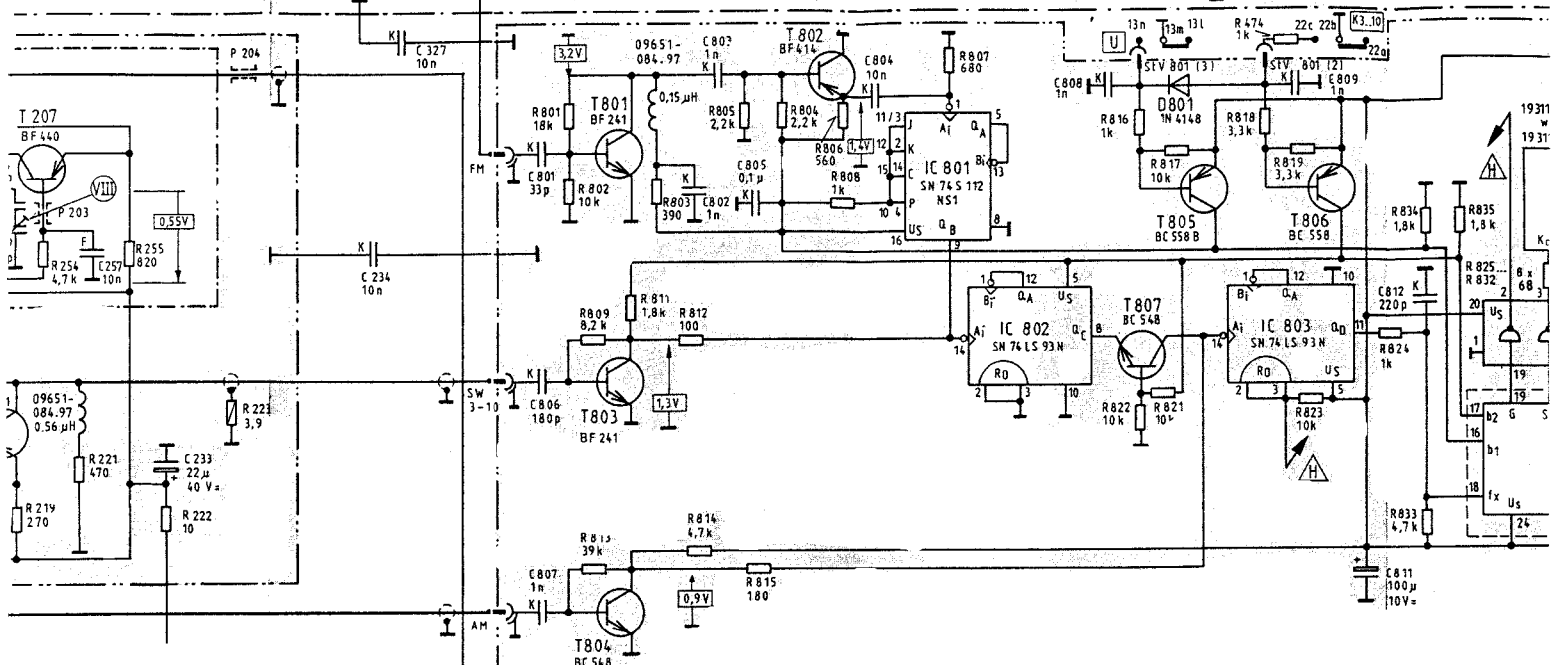
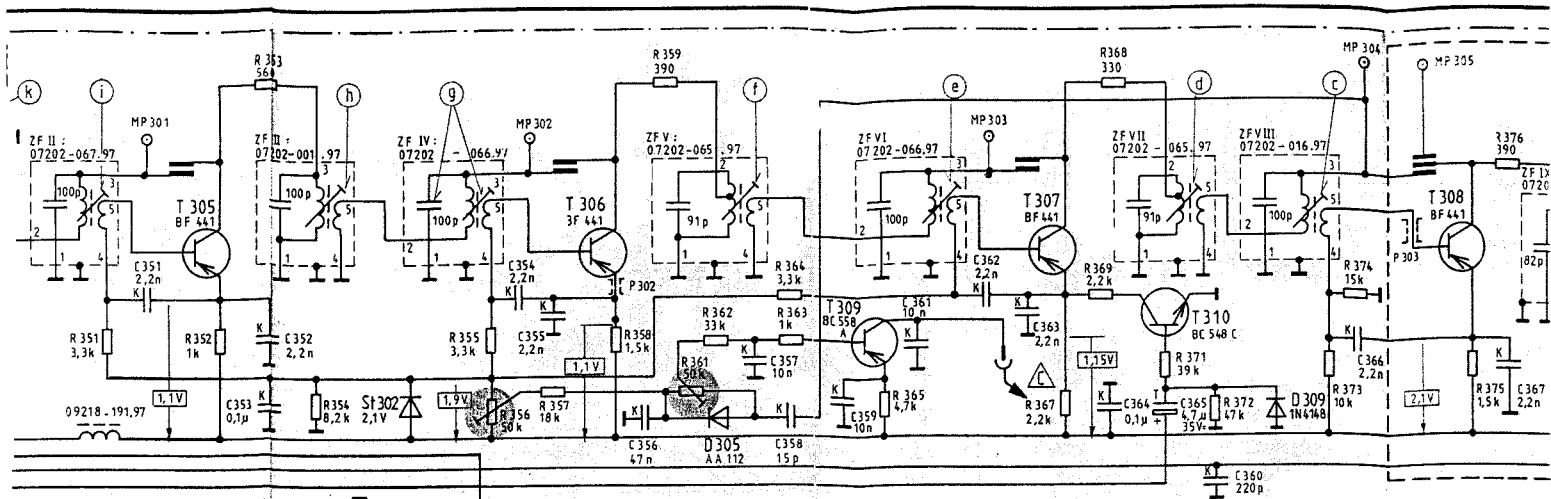

255, 256, 258, 225, 259	257, 351, 233	352, 353	234, 327	354, 801, 355, 806, 807, 701, 356, 802, 803, 357, 358, 805, 502, 501, 503, 506, 504, 505, 701, 507, 508, 509	359, 804, 361, 362, 511, 703, 704, 705, 363, 808, 364, 365, 360, 512, 513, 514, 515, 706, 516, 707, 517, 518, 708, 519, 521, 522	809, 366, 811, 812, 367, 8
19, 254	51, 255, 221, 222	352, 353, 223	354	354, 356, 801, 802, 357, 358, 803, 814, 361, 362, 804, 815, 363, 364, 805, 806, 365, 807, 501, 701, 702, 703, 809, 813, 812, 502	716, 367, 368, 369, 822, 371, 816, 821, 372, 818, 19, 823, 474, 373, 774, 824, 834, 833, 375, 376, 8	377, 8

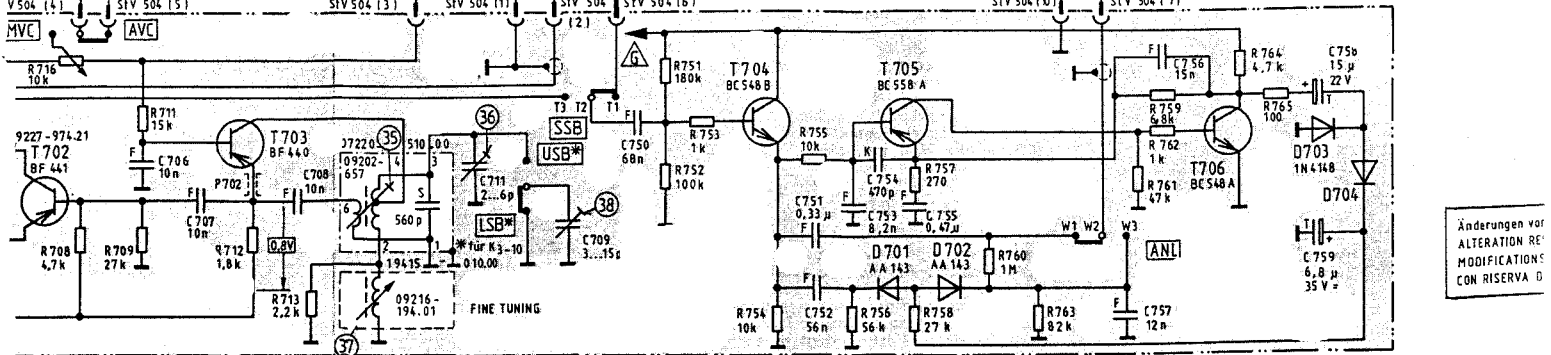
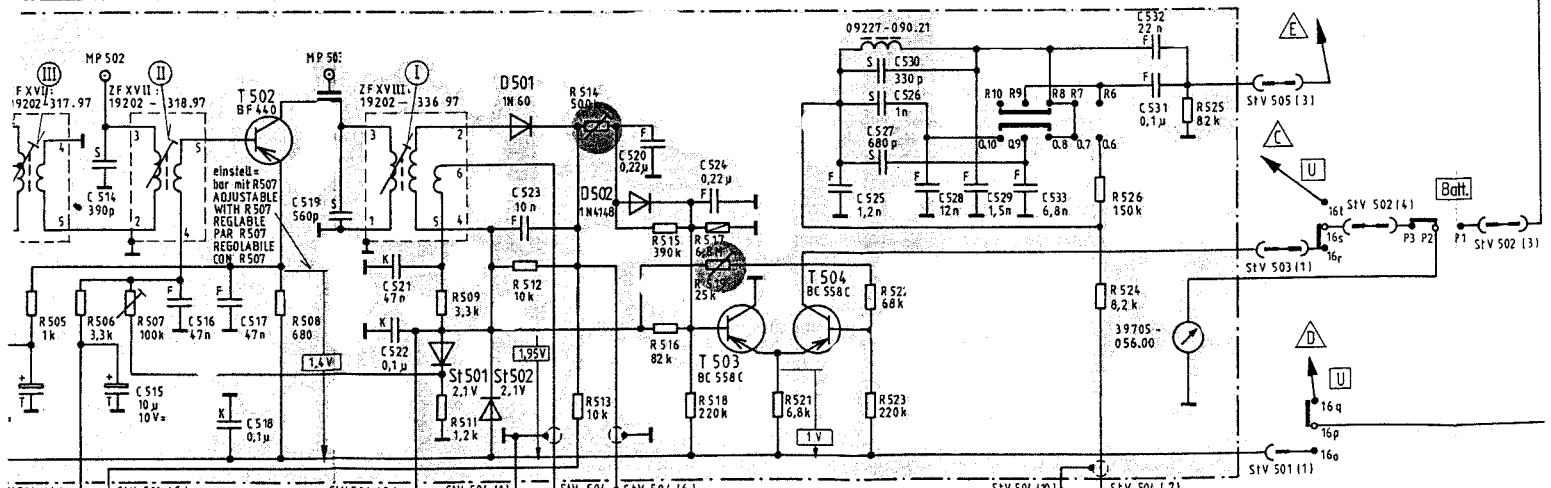
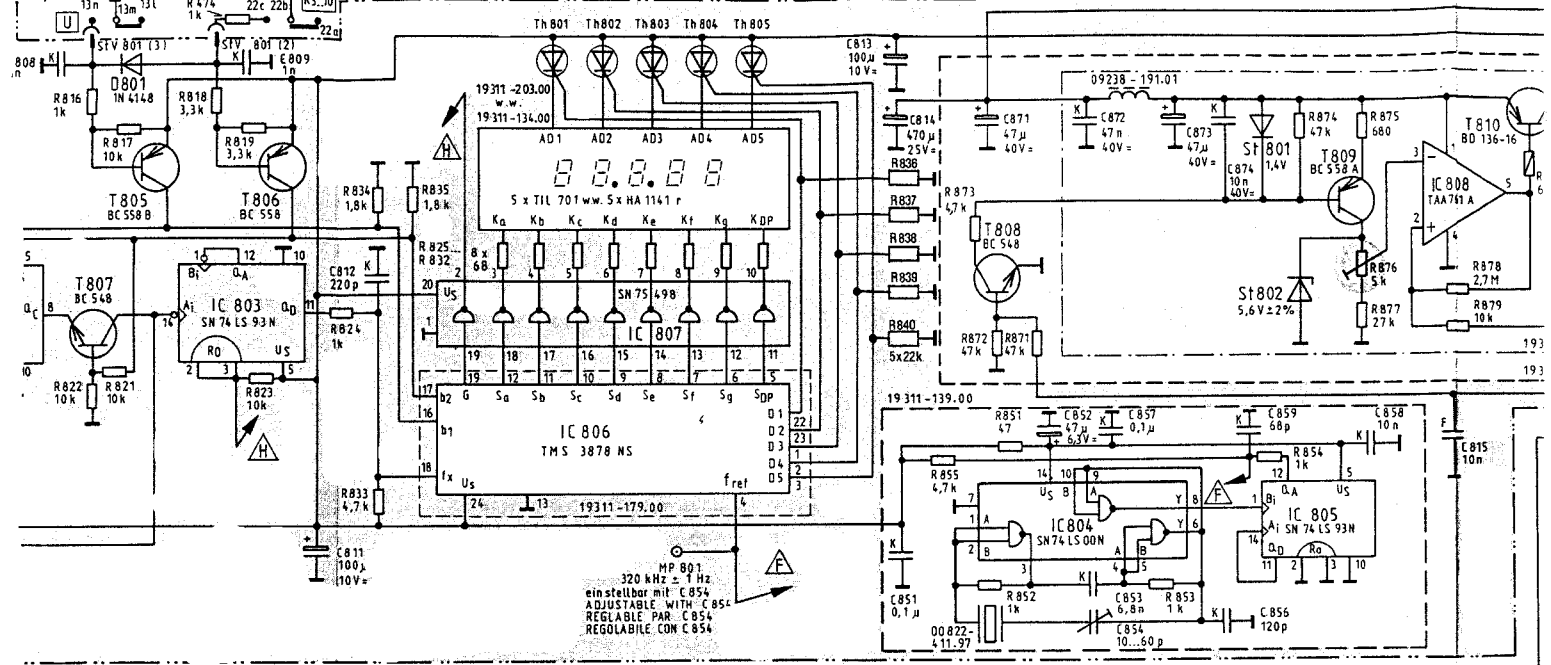
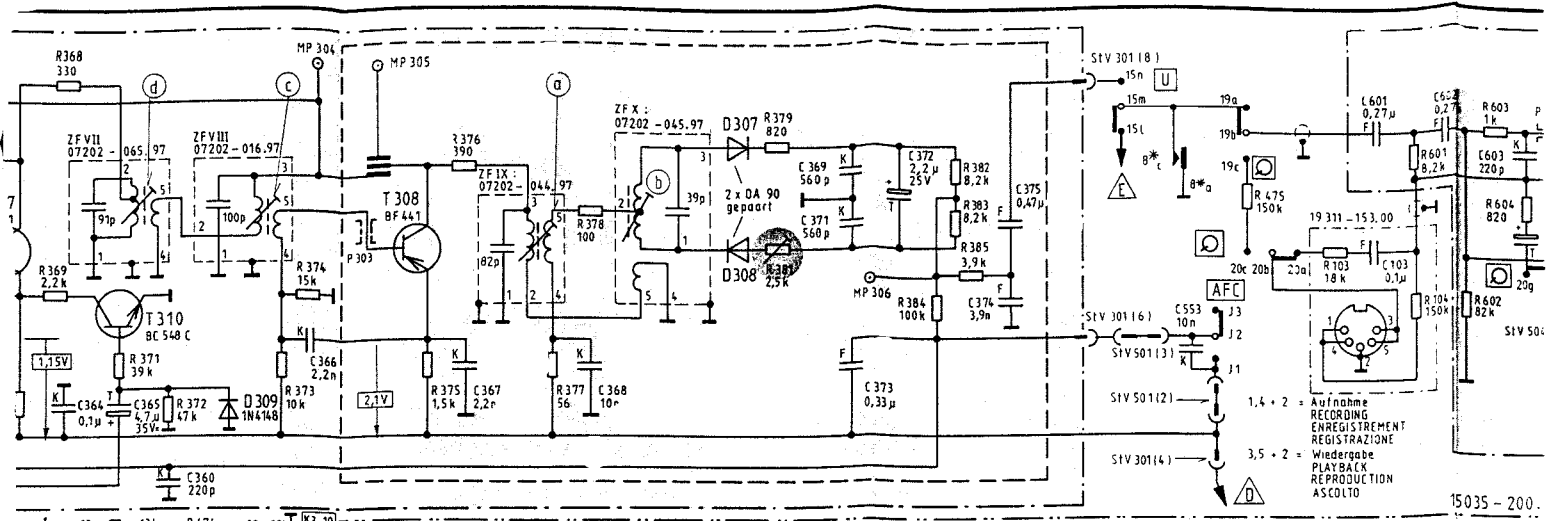

808, 364,	365, 360,	809,	366, 811, 812,	367, 711,	368,	851, 369,	371, 373,	372, 813, 814, 374, 375,	871, 852, 872, 853, 854, 857, 873,	856, 874, 859, 858, 601,	103,	602, 815,	60
513,	514, 515, 706, 516,	707, 517, 518, 708,	519, 521, 522,	523,	709,	750, 520,	524,	751, 752, 525, 753, 754, 526, 527, 755, 528, 529, 533,	553, 757, 531, 532,	756,	758, 759,		
7, 366, 369, 822, 371, 816, 821, 372, 818, 819, 823, 673, 373, 824,	834, 833, 375,	376, 825, ... 832, 377,	378,	515, 751, 518, 517,	379, 381, 808, 840,	522,	384, 383, 382, 385, 873, 872, 871, 526,	853,	854, 475, 874, 875, 103, 876, 877,	104, 601, 878, 602, 603, 881	879,		
5,	708, 506, 507, 709, 711, 817,	712,	508, 713,	835,	509, 511,	512,	513, 514, 516,	752, 753, 519, 754, 521, 755,	756, 523, 757, 758, 855, 760, 851, 763, 852,	524, 761, 759,	762, 525, 764, 765,		

Änderungen vor
 ALTERATION RE
 MODIFICATIONS
 CON RISERVA D

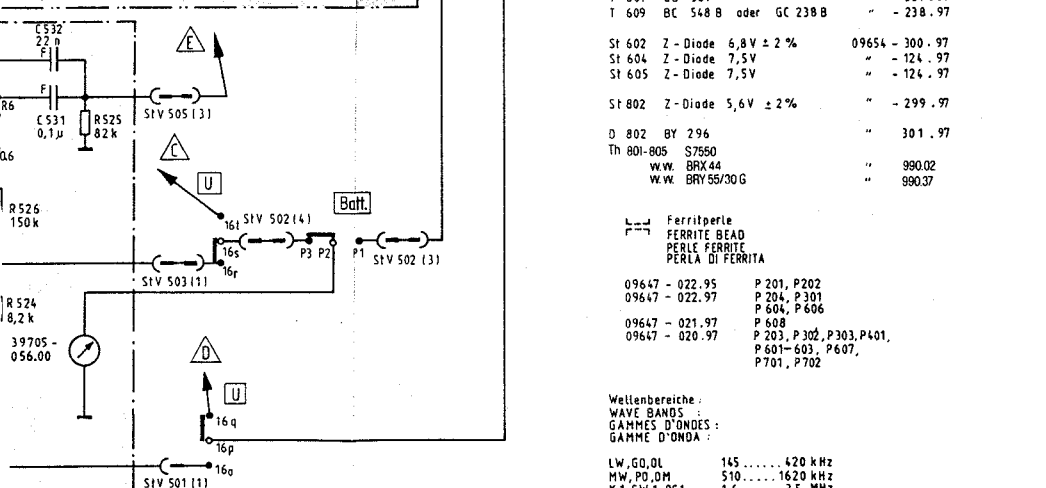
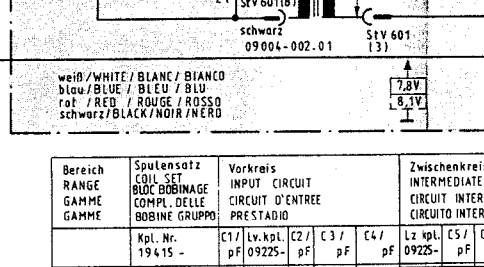
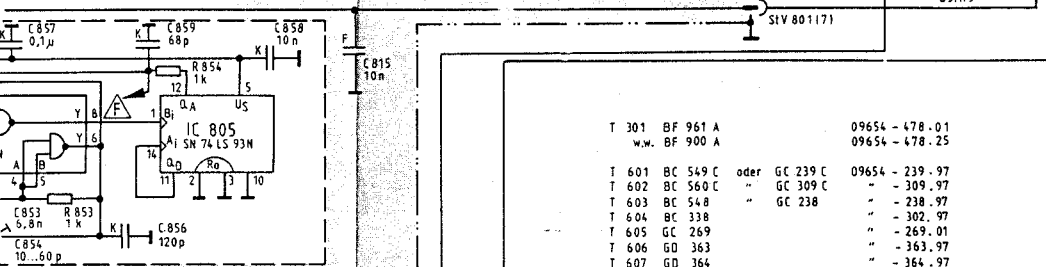
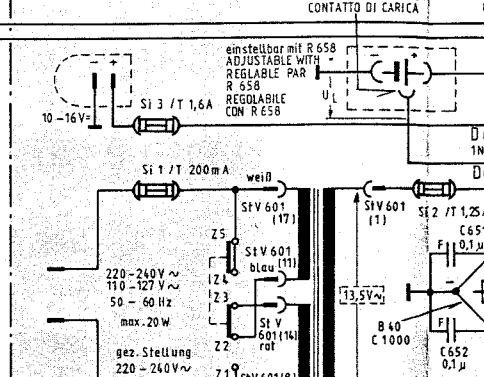
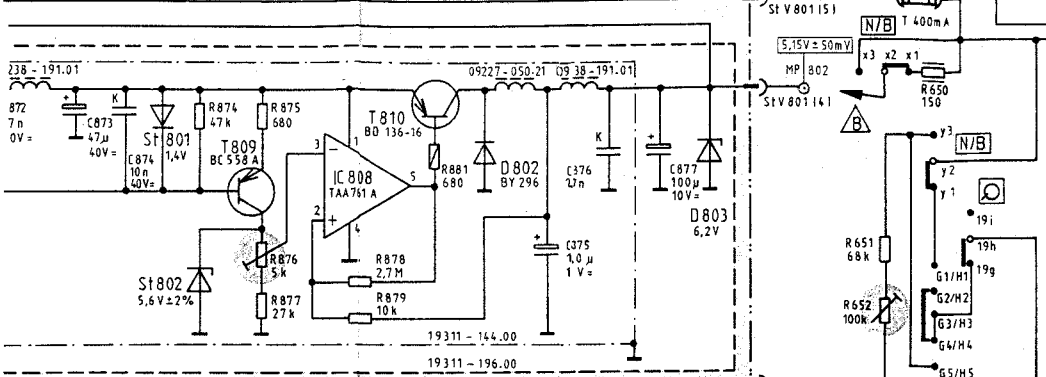
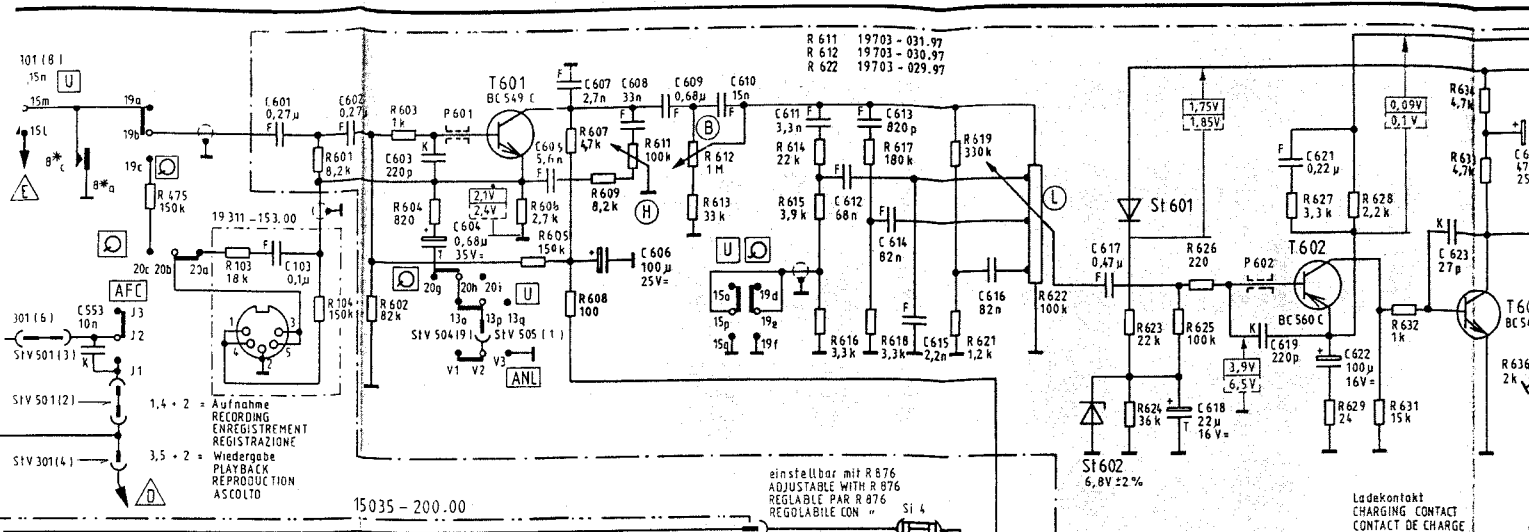

Bereich RANGE GAMME GAMME	Sputensatz COIL SET COMPL. DELLE BOBINE GRUPPO	Vorkreis INPUT CIRCUIT CIRCUIT D'ENTREE PRESTADIO	Zwischenkreis INTERMEDIATE CIRCUIT INTERI CIRCUIT INTERI					
	Kpl. Nr. 19415 -	C1/1 pF	C2/2 pF	C3/3 pF	C4/4 pF	Lz xpl. 09225 -	C5/5 pF	C6/6
K 3	49m	-	101.21	-	10...60	10...40	211.21	4,7 10
K 4	41m	-	102.21	22	10...60	10...60	212.21	4,7 10
K 5	31m	-	103.21	18	10...60	10...40	213.21	5,6 10
K 6	25m	-	104.21	22	10...60	10...60	214.21	6,8 10
K 7	19m	-	105.21	18	10...60	10...40	215.21	8,2 10
K 8	16m	-	126.00	-	10...60	10...60	216.21	8,2 10
K 9	13m	-	127.00	470	207.21	-	10...60	10...40
K 10	11m	-	128.00	82	208.21	-	10...60	10...60

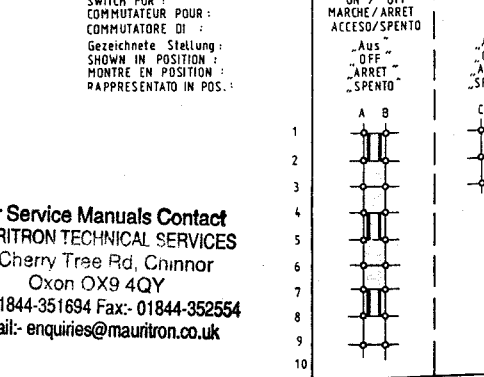
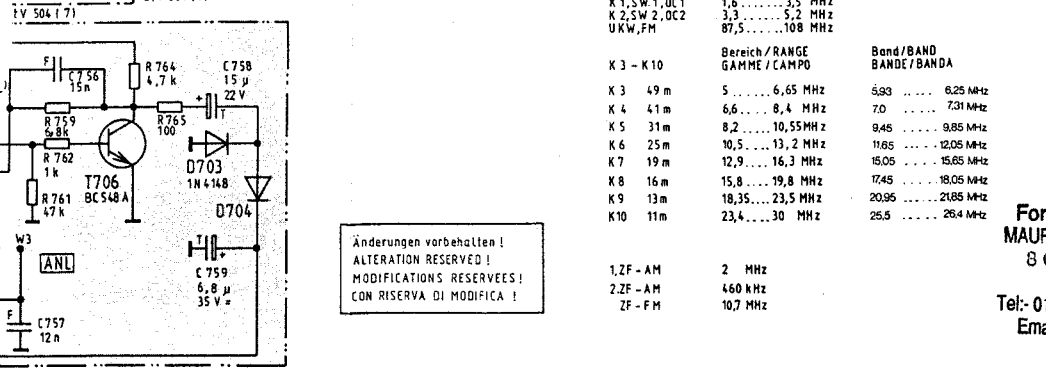

Wellenbereiche WAVE BANDS GAMMES D'ONDES GAMME D'ONDA	Bereich / RANGE GAMME / CAMPO	Band / BANDA BANDA / BAND
LW, GO, DL	145 ... 420 kHz	5,83 ... 6,25 MHz
MW, PD, DM	510 ... 1620 kHz	7,0 ... 7,31 MHz
K 1, SW, 1, OC1	1,6 ... 3,5 MHz	9,45 ... 9,85 MHz
K 2, SW, 2, OC2	3,3 ... 5,2 MHz	11,68 ... 12,05 MHz
UKW, FM	87,5 ... 108 MHz	15,05 ... 15,65 MHz
		17,45 ... 18,05 MHz
		20,95 ... 21,85 MHz
		25,5 ... 26,4 MHz

For Service Manuals Contact
MAURITRON TECHNICAL SERVICES
 8 Cherry Tree Rd, Chinnor
 Oxon OX9 4QY
 Tel: 01844-351694 Fax: 01844-352554
 Email: enquiries@maurtron.co.uk

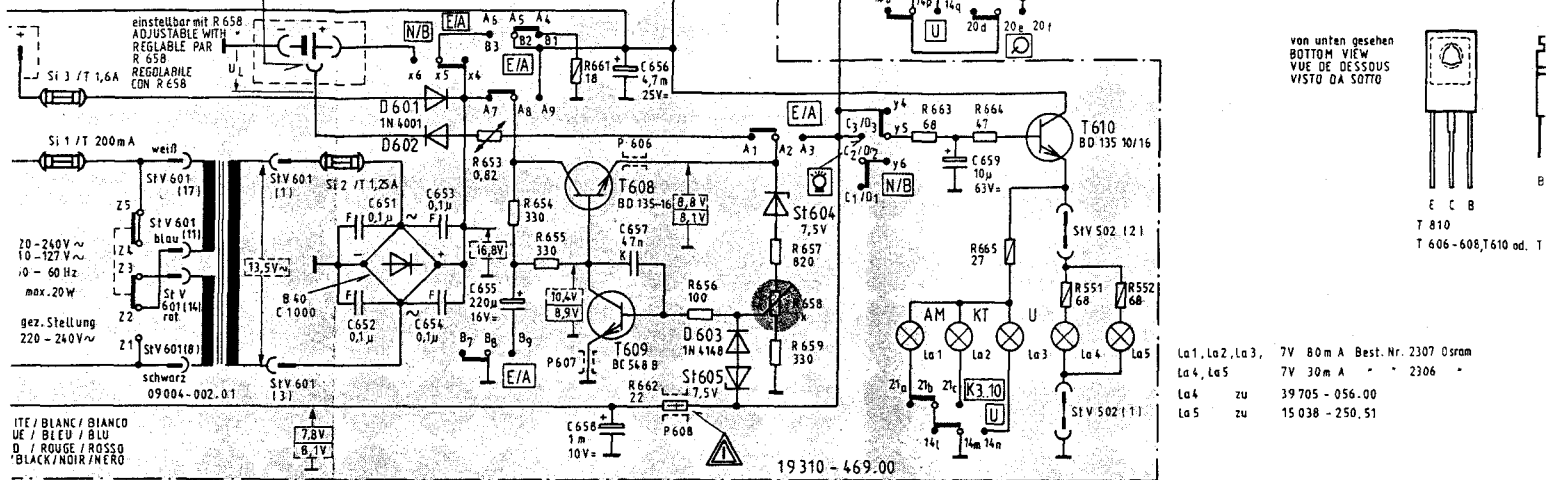
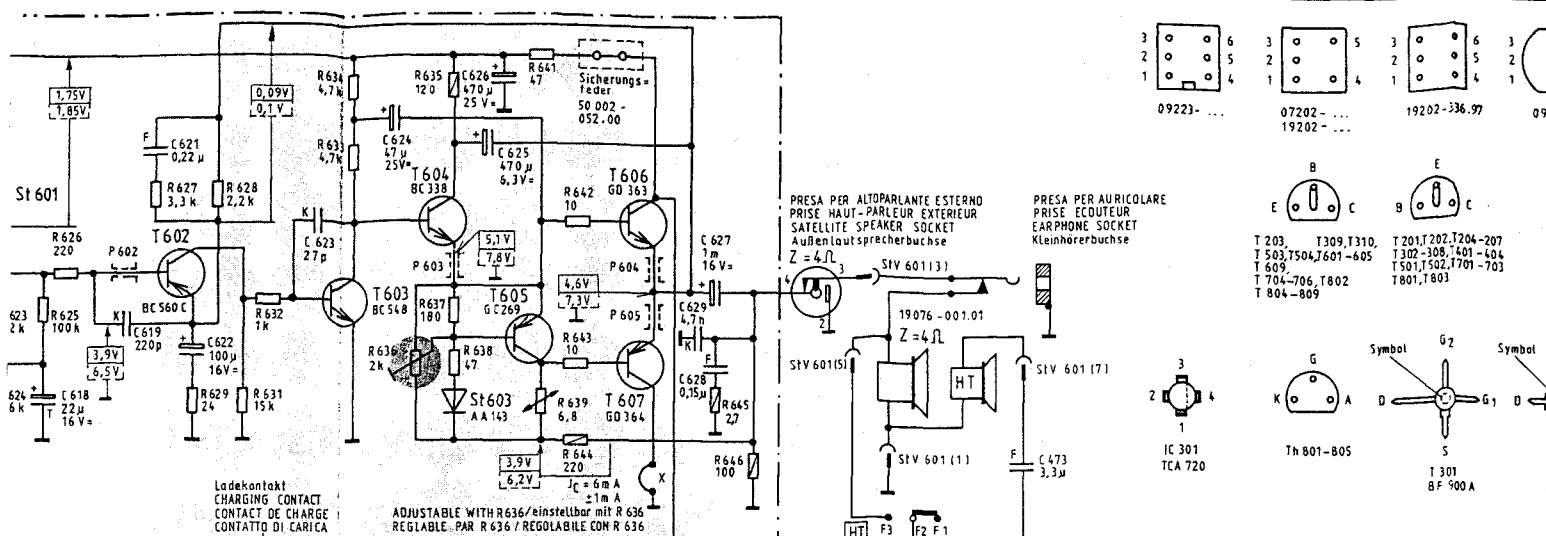

Spulensatz COIL SET BOUC BOINAGE COMPL. DELLE BOBINE GRUPPO	Vorkreis INPUT CIRCUIT CIRCUIT D'ENTREE PRESTADIO	Zwischenkreis INTERMEDIATE CIRCUIT CIRCUIT INTERMEDIARE CIRCUITO INTERMEDIARE						Oszillatorkreis OSCILLATOR CIRCUIT CIRCUIT D'OSCILLATEUR CIRCUITO OSCILLATORE									
		C1	Lv. kpl.	C2	C3	C4	C7	Lz kpl.	C5	C6	C7	C8	Lp kpl.	C9	C10	C11	C12
19415 -	09225- pF	101.21	10...	10...	10...	10...	211.21	4,7	10...	10...	10...	121.21	33	12	-	-	-
1m	102.21	22	10...	10...	10...	10...	212.21	4,7	10...	10...	10...	122.21	43	33	-	-	-
1m	123.00	-	103.21	16	10...	10...	213.21	5,6	10...	10...	10...	123.21	36	15	-	-	-
1m	124.00	-	104.21	22	10...	10...	214.21	6,8	10...	10...	10...	124.21	43	24	-	-	-
1m	125.00	-	105.21	18	10...	10...	215.21	8,2	10...	10...	10...	125.21	39	15	-	-	-
1m	126.00	-	206.21	27	10...	10...	216.21	8,2	10...	10...	10...	126.21	43	27	-	-	-
1m	127.00	470	207.21	-	10...	10...	217.21	10	10...	10...	10...	127.21	33	22	-	-	-
1m	128.00	82	208.21	-	10...	10...	218.21	12	10...	10...	10...	128.21	36	36	180	-	-

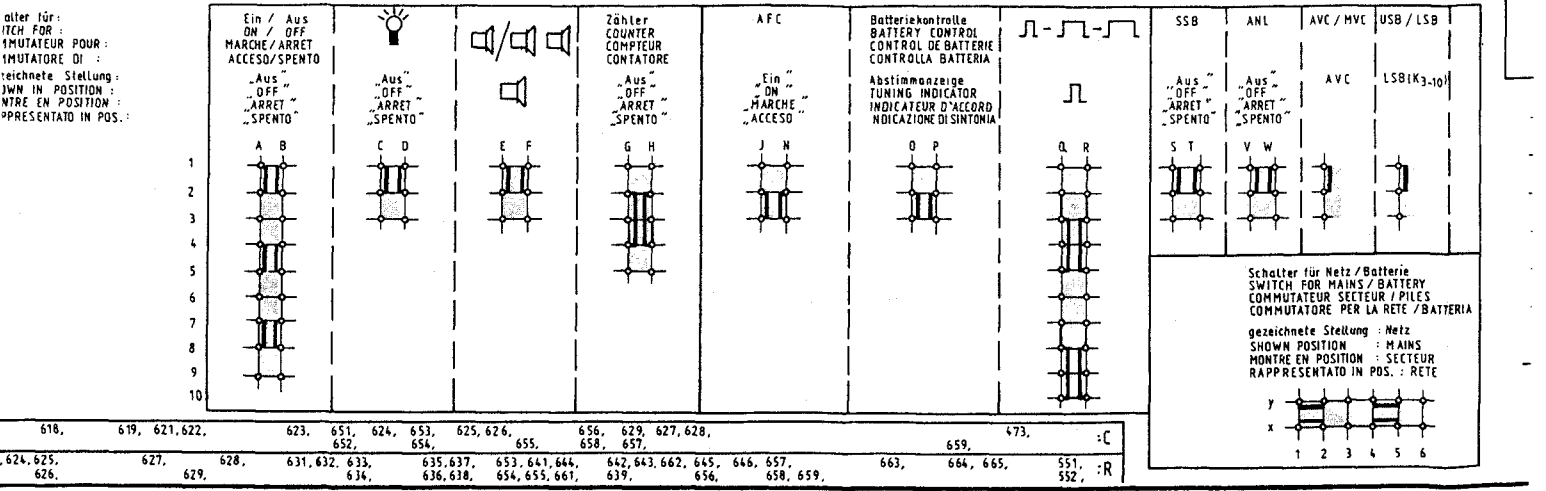
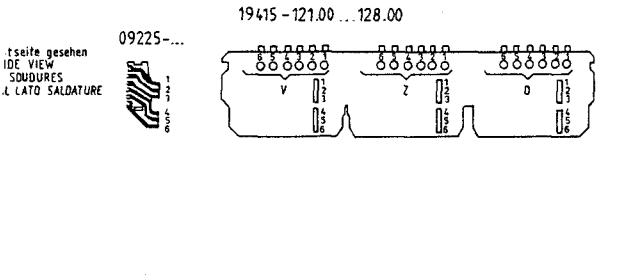
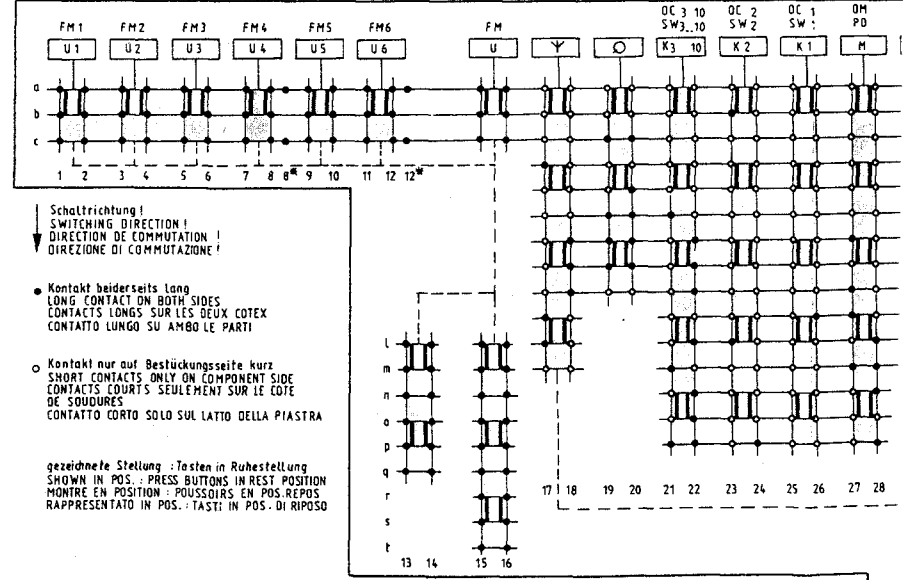

618,	619,	621,622,	623,	651,	624,	653,	625,626,	654,	655,	656,	629,	627,628,	657,	659,	473,	:C
3,624,625,	627,	628,	631,632,633,	634,	635,637,	636,638,	654,655,661,	639,	656,	642,643,662,645,	646,657,	663,	664,665,	666,	551,	:R

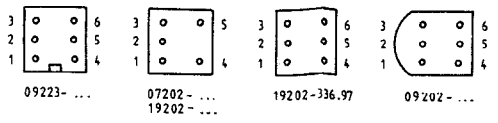

PRESA PER AURICOLARE
PRISE ECOUTEUR
EARPHONE SOCKET
Kteinhörerbuchse

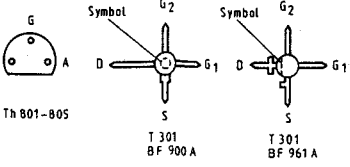
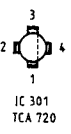
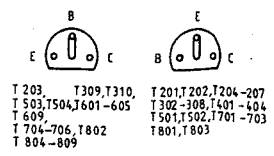
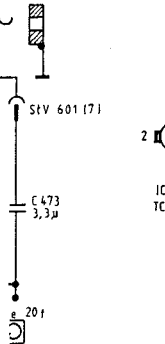

von unten gesehen
BOTTOM VIEW
VUE DE DESSOUS
VISTO DA SOTTO

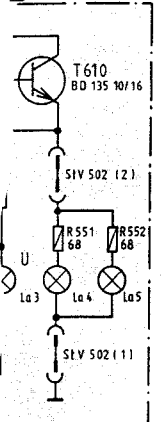
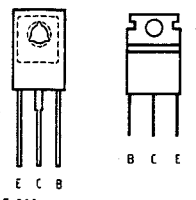

La1, La2, La3, 7V 80m A Best.-Nr. 2307 Osrnm
La4, La5 7V 30m A " 2306 "
La4 zu 39 705 - 056.00
La5 zu 15 038 - 250.51

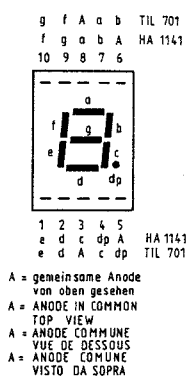
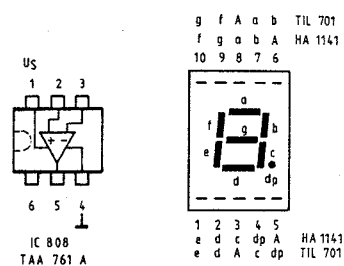
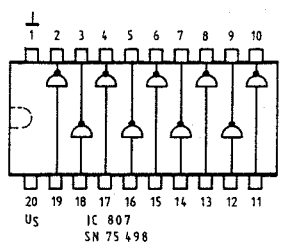
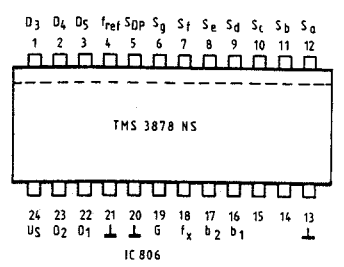
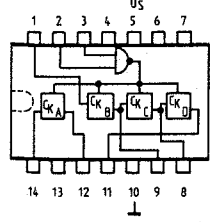
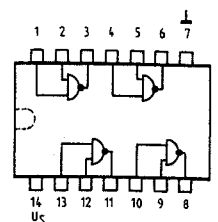
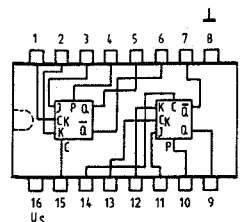

A = gemeinsame Anode von oben gesehen
A = ANODE IN COMMON TOP VIEW
A = ANODE COMMUNE VUE DE DESSOUS
A = ANODE COMUNE VISTO DA SOPRA

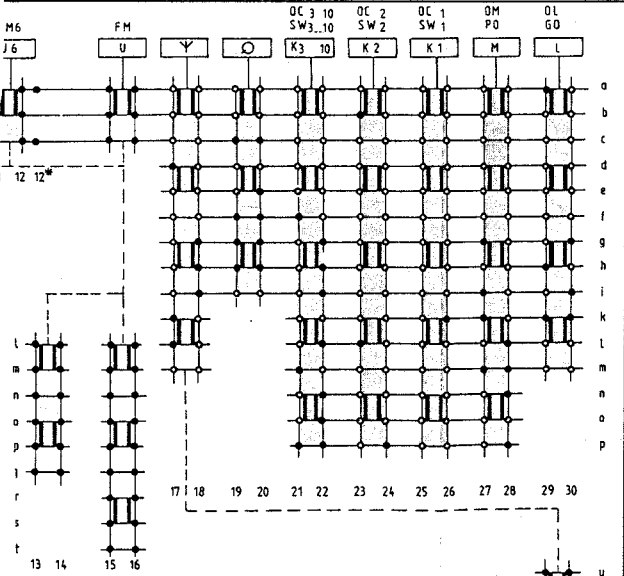

FM-Teil FM-UNIT PARTIE - FM PARTE - FM	19420 - 010.00	Frequenzzähler FREQUENCY COUNTER COMPTEUR DE FREQUENCE FREQUENZIMETRO	15035 - 200.00
Ferritstabantenne kpl. FERRIT AERIAL ANTENNE FERRITE ANTENNA DI FERRITE COMPL.	19426 - 032.00	Verstärkerplatte AMPLIFIER BOARD PLAQUE AMPLIFICATEUR PIASTRA AMPLIFICATORE	19311 - 129.00
Spulensatz COIL SET BLOC BOBINAGE COMPLESSO DELLE BOBINE - GRUPPO - AF	19415 - 007.00	MOS IC-Platte MOS IC-BOARD PLAQUE-MOS IC PIASTRA-MOS IC	19311 - 179.00
Buchsenplatte SOCKET BOARD PLAQUE DE PRISES PIASTRA PRESE	19311 - 153.00	Oszillator-Platte OSCILLATOR-BOARD PLAQUE-OSCILLATEUR PIASTRA OSCILLATORE	19311 - 139.00
30V-Wandler 30V-TRANSFORMER TRANSUCTEUR-30V CONVERTITORE-30V	19310 - 528.00	Anzeige-Platte INDICATOR-BOARD PLAQUE INDICATEURS PIASTRA INDICATORE	19311 - 134.00 ww.19311 - 203.00
AM-Variometer AM-VARIOMETER VARIOMETRE - AM VARIOMETRO - AM	19415 - 008.00	5V-Wandler 5V-TRANSFORMER TRANSUCTEUR-5V CONVERTITORE-5V	19311 - 196.00
KW-Tuner SW-TUNER TUNER-OC TUNER-OC	19415 - 009.00	NF-Teil AF-UNIT PARTIE - FA PARTE - BF	19310 - 469.00
Tuner-Platte TUNER-BOARD PLAQUE-TUNER PIASTRA-TUNER	19311 - 168.00	Netzteil-Platte POWER-SUPPLY BOARD PLAQUE D'ALIMENTATION PIASTRA DI ALIMENTAZIONE	19310 - 474.00
AM-ZF-Platte AM-IF-BOARD PLAQUE-AM-FI PIASTRA-AM-FI	19311 - 206.00	Schalterplatte SWITCH BOARD PLAQUE DE COMMUTATION PIASTRA DI COMMUTATORE	19310 - 480.00
SSB-Platte SSB-BOARD PLAQUE-SSB PIASTRA-SSB	19311 - 174.00	Quarz-Uhr QUARTZ-CLOCK HORLOGE A QUARTZ OROLOGIO QUARTZO	15038 - 250.51

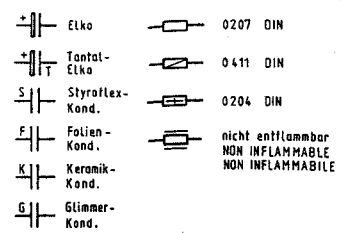
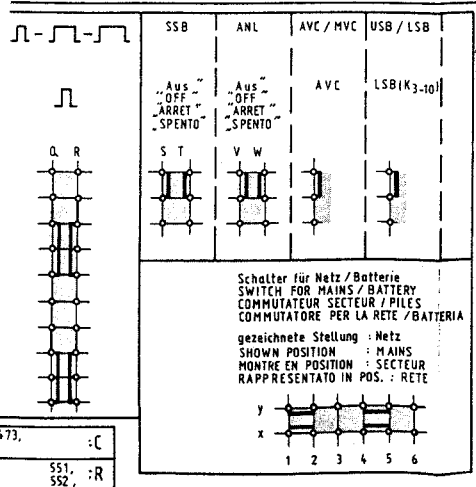

Schalter für Netz/Batterie
SWITCH FOR MAINS/BATTERY
COMMUTATEUR SECTEUR / PILES
COMMUTATORE PER LA RETE / BATTERIA
gezeichnete Stellung : Netz
SHOWN POSITION : MAINS
MONTRE EN POSITION : SECTEUR
RAPPRESENTATO IN POS. : RETE

gedruckter Kondensator
PRINTED CAPACITOR
CONDENSATEUR IMPRIME
CONDENSATORE STAMPATO



Satellit 3400 professional
(15038-906.01)

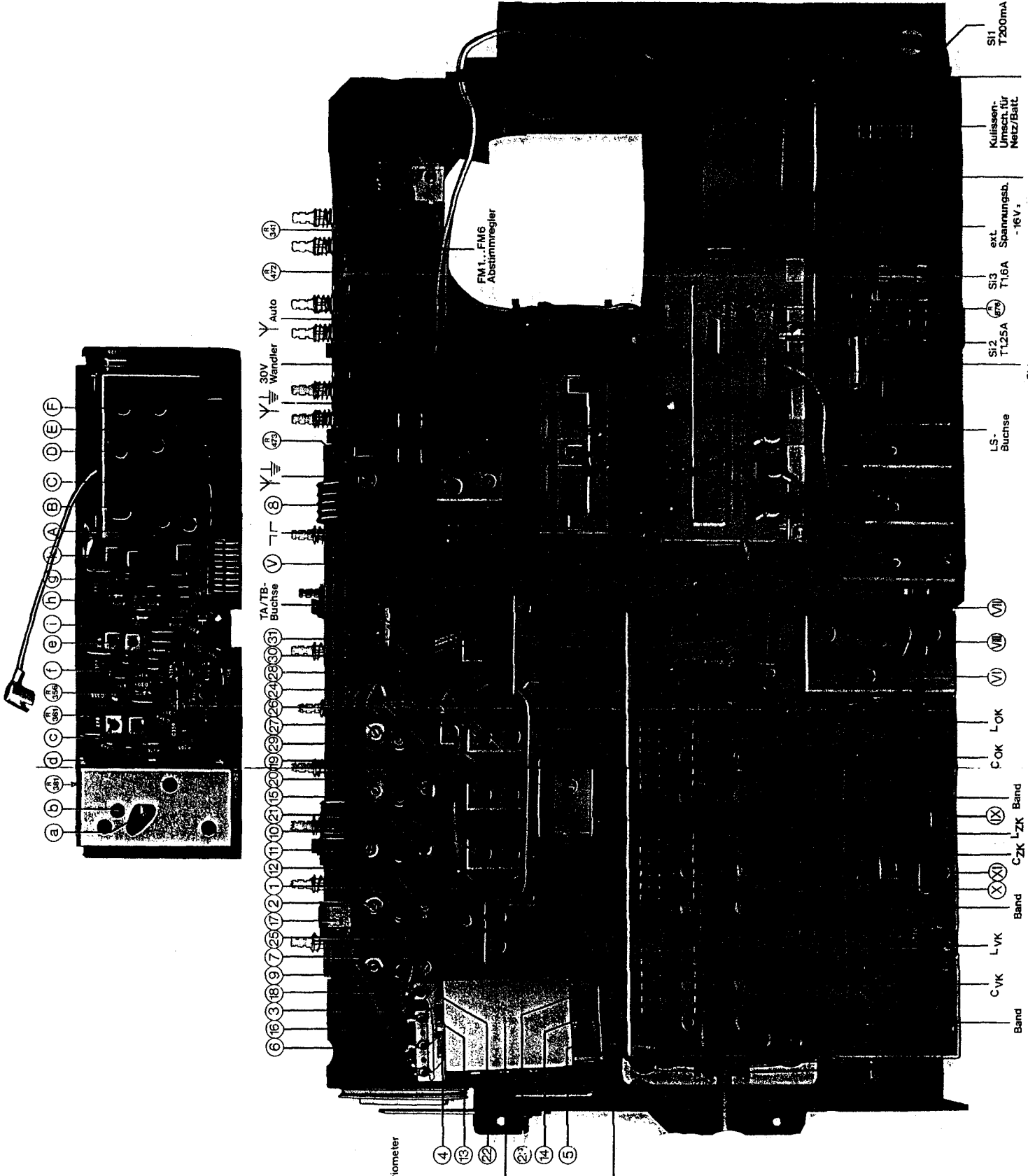

AM-Varionometer

Wichtig!

Vor Neueinstellung des Varionometers ist der Drehknochen in der richtigen Position einzustellen. Die eigentliche Einstellung erfolgt durch seitliches Wegschieben des Varionometergehäuses. Die Oberkante des Schiebers muß innerhalb des Einstellbereichs im Rahmen stehen. (Siehe Profil)

Important!

Before readjusting the varionometer, the variable capacitor must be set out by pressing sideways the touch ed rack and displacing the varionometer housing. The upper edge of the slider must be situated inside the notching in the frame. See arrow!

Important!

Avant le réajustage du varionomètre, fermer le condensateur variable. Le réajustage est fait en pressant de côté le rack et en déplaçant le varionomètre. Le bord supérieur du tiroir doit être situé au dedans de la rainure dans le cadre. Voir la flèche!

Importante!

Prima della nuova regolazione del varionometro è necessario chiudere il condensatore variabile. La regolazione vera e propria avviene premendo lateralmente il rack e spostando il varionometro. Il bordo superiore del supporto deve trovarsi entro la rientranza del telaio. Vedi freccia.

Abgleich-Lagediagramm
 ALIGNMENT SCHEMATIC
 PLAN DE REGLAGE
 PIANO DI TARATURA

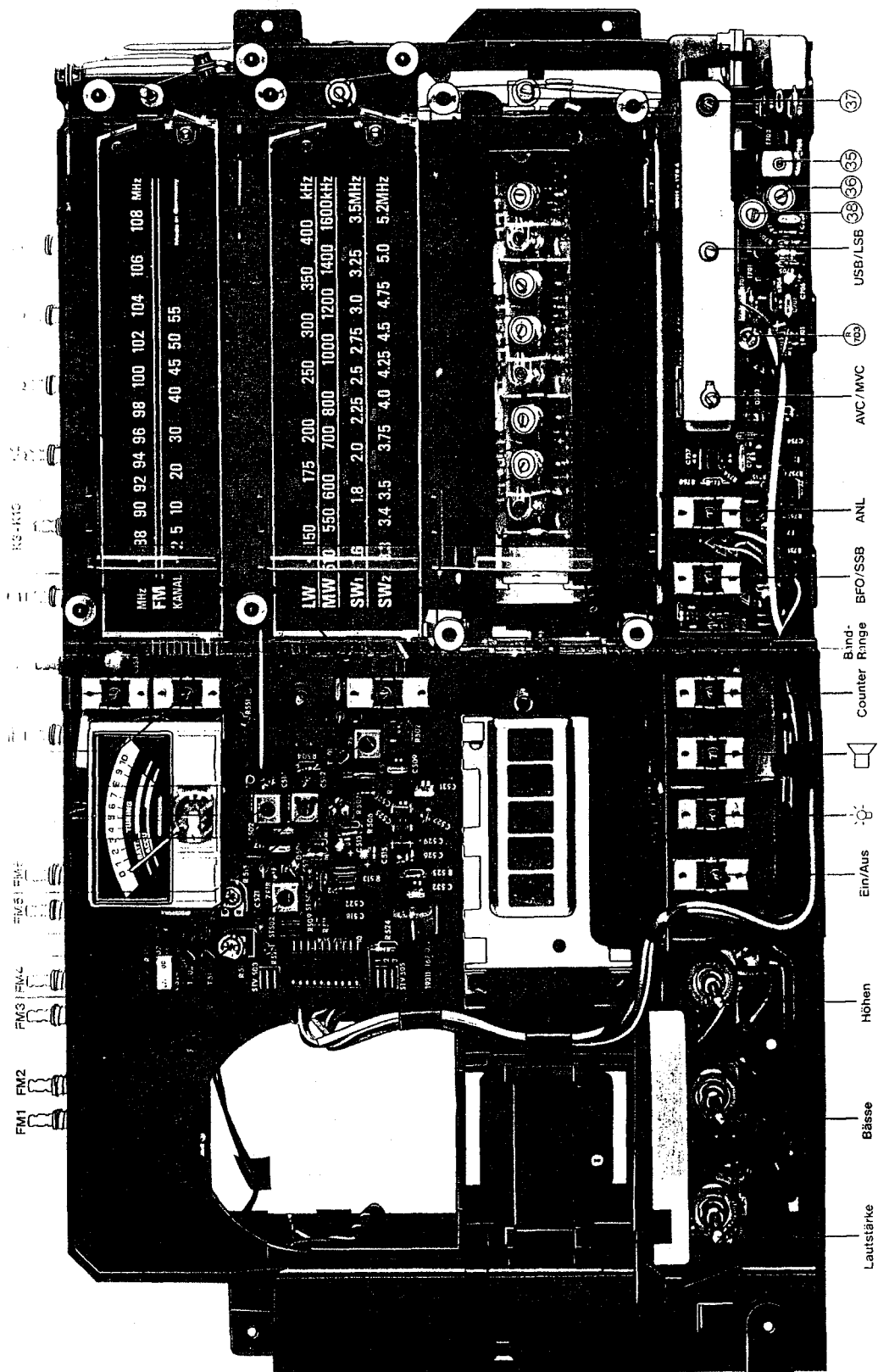

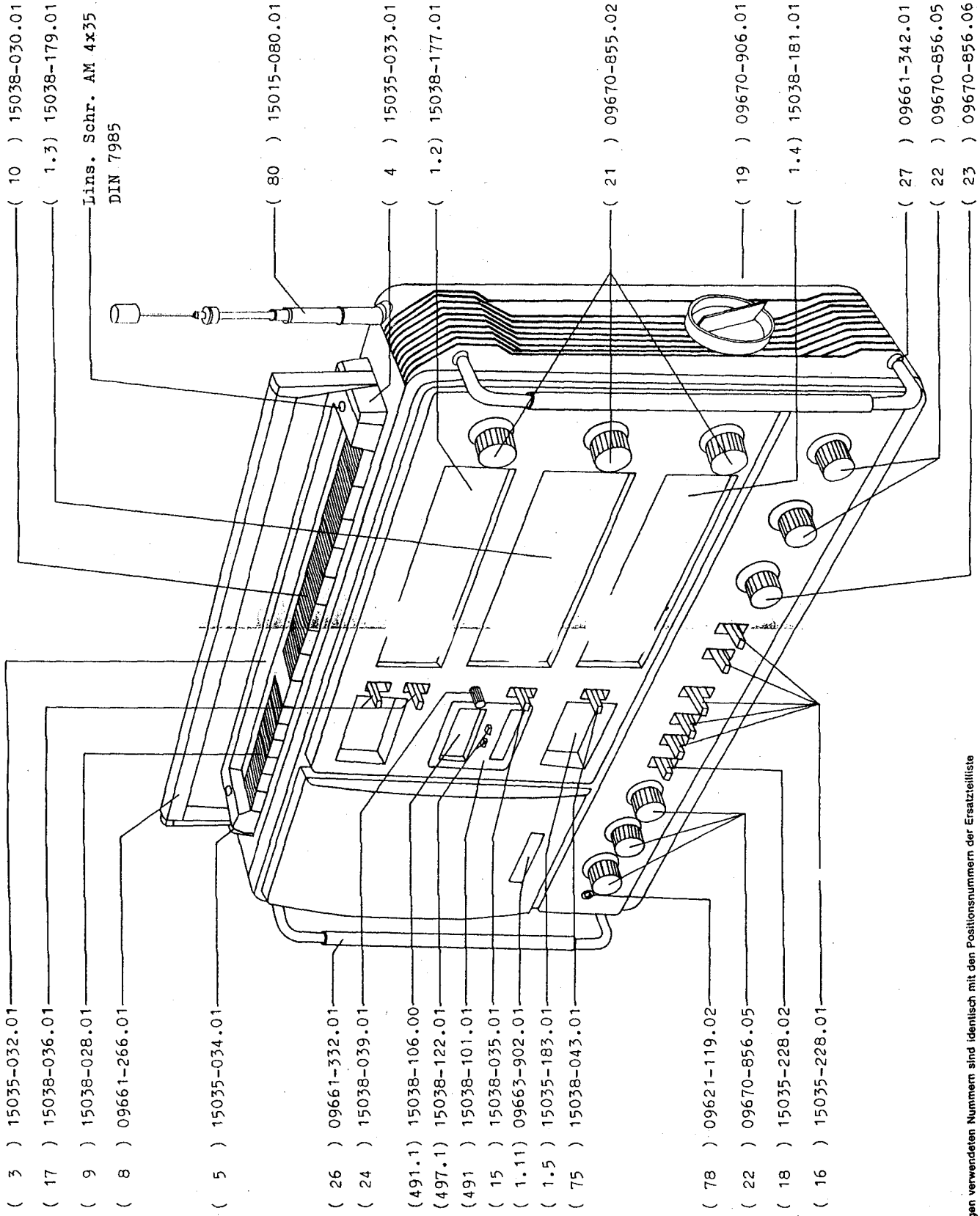

Die bei den Abbildungen verwendeten Nummern sind identisch mit den Positionsnummern der Ersatzteilliste
 THE INDICATED NUMBERS ARE IDENTICAL WITH THE SPARE PARTS LIST
 LES NUMEROS DE POSITION SONT IDENTIQUES A CEUX UTILISES SUR LES FIGURES
 I NUMERI INDICATI NELLE ILLUSTRAZIONI CORRISPONDONO AI NUMERI DI POSIZIONE NELLA LISTA RICAMBI

2

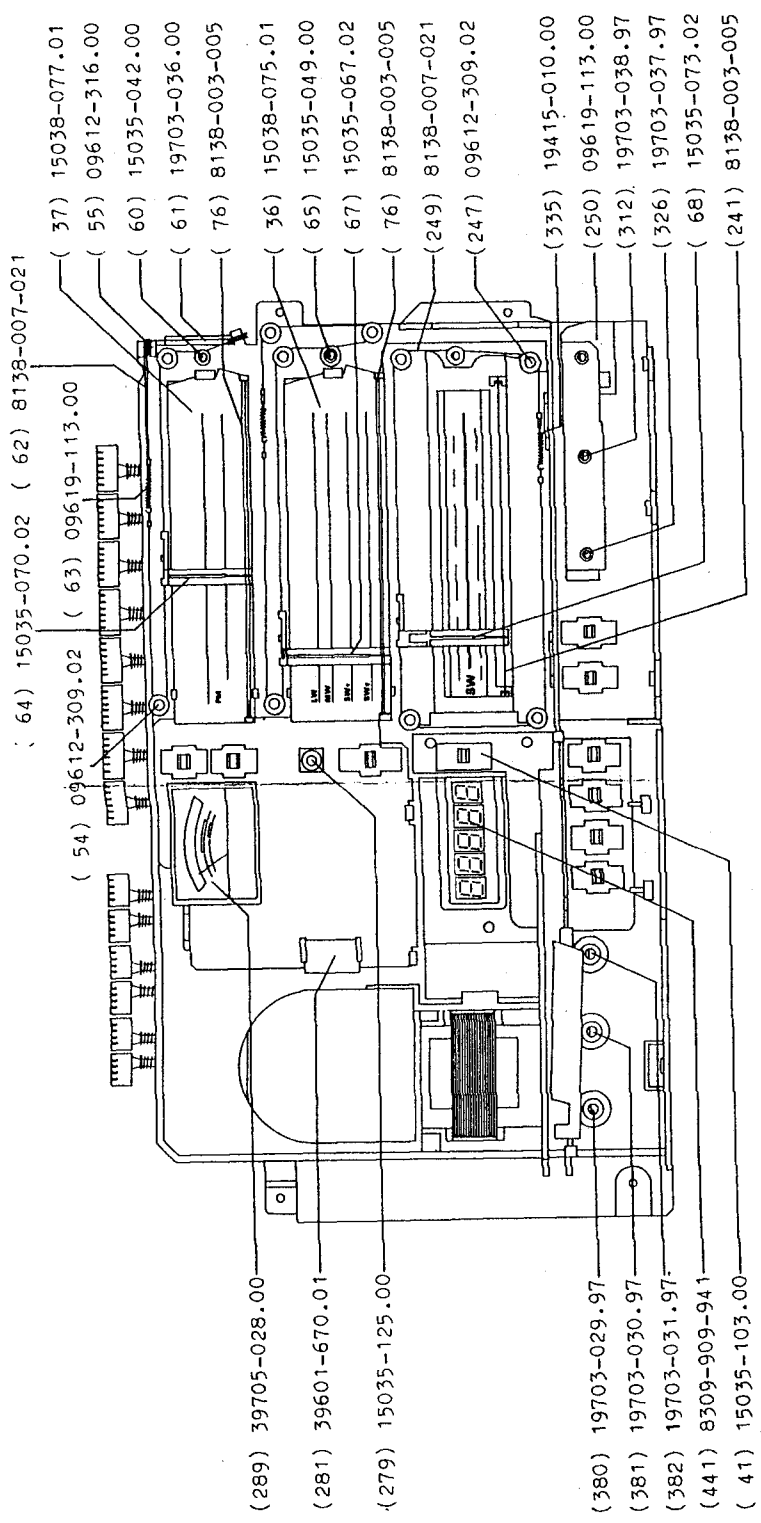

3

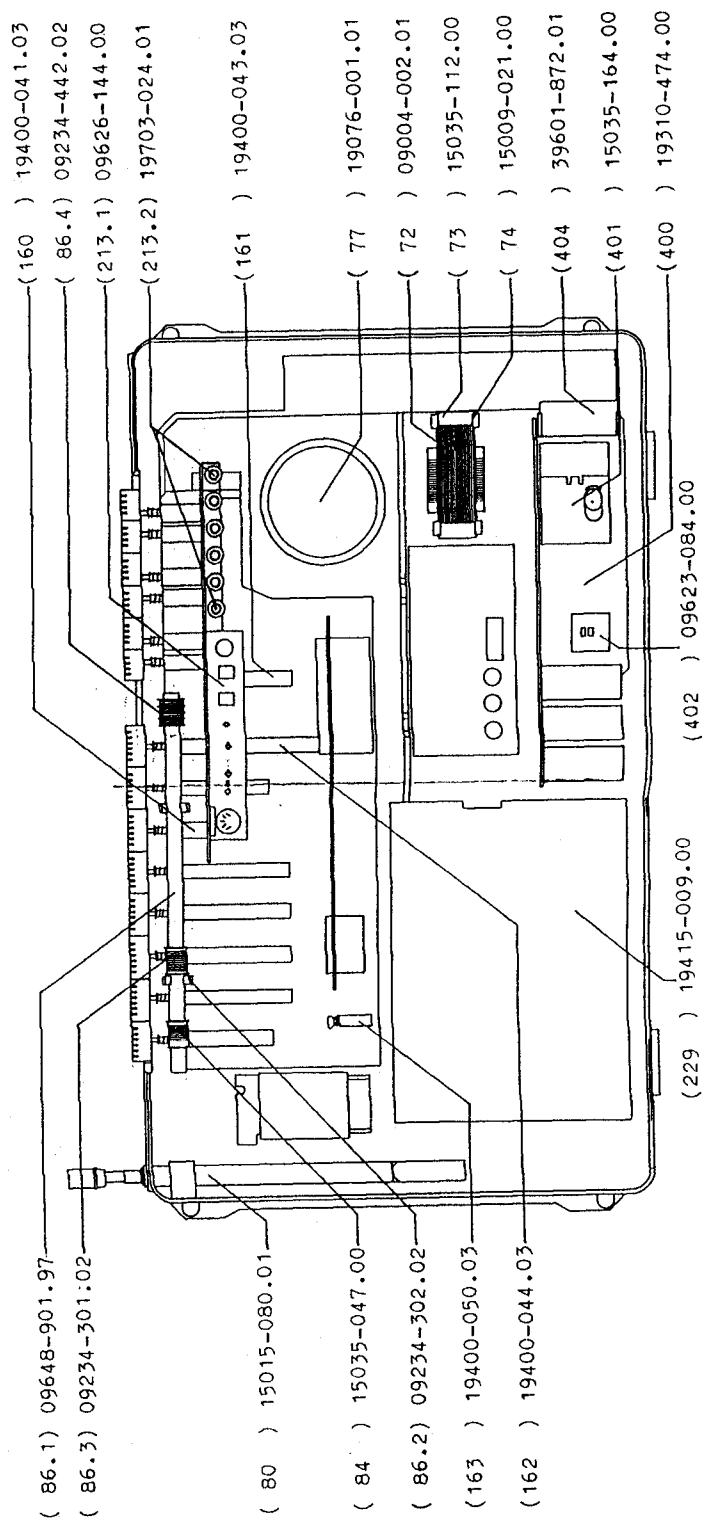

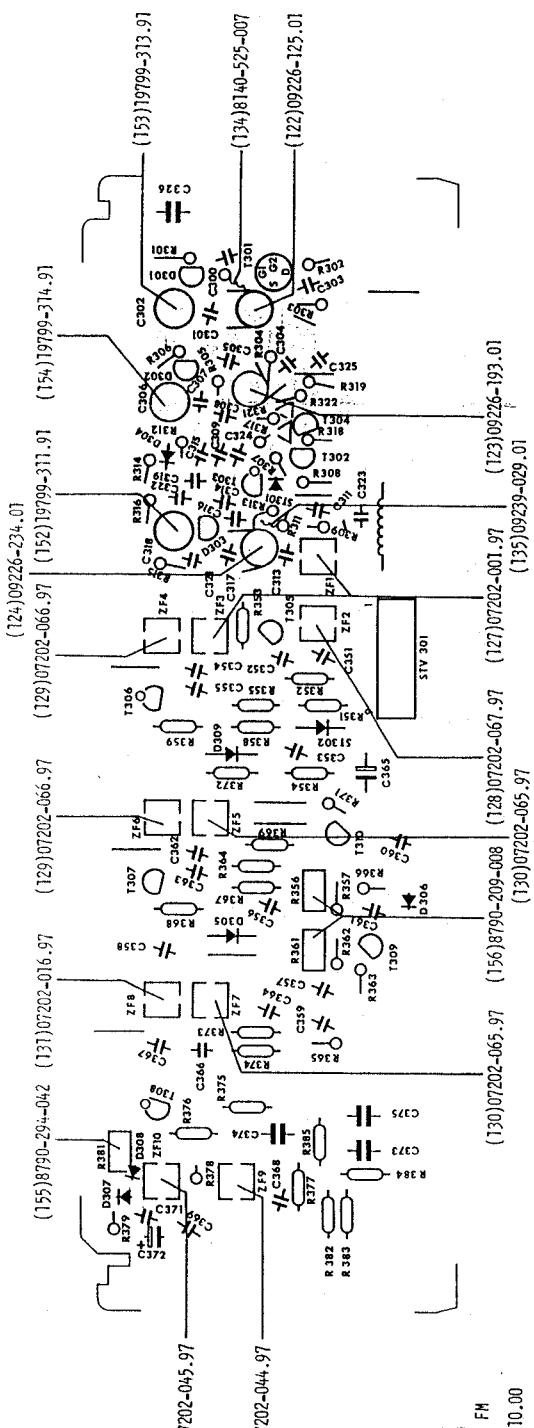

-teil
 -unit
 ic fm
 -ione FM
 -20-010.00

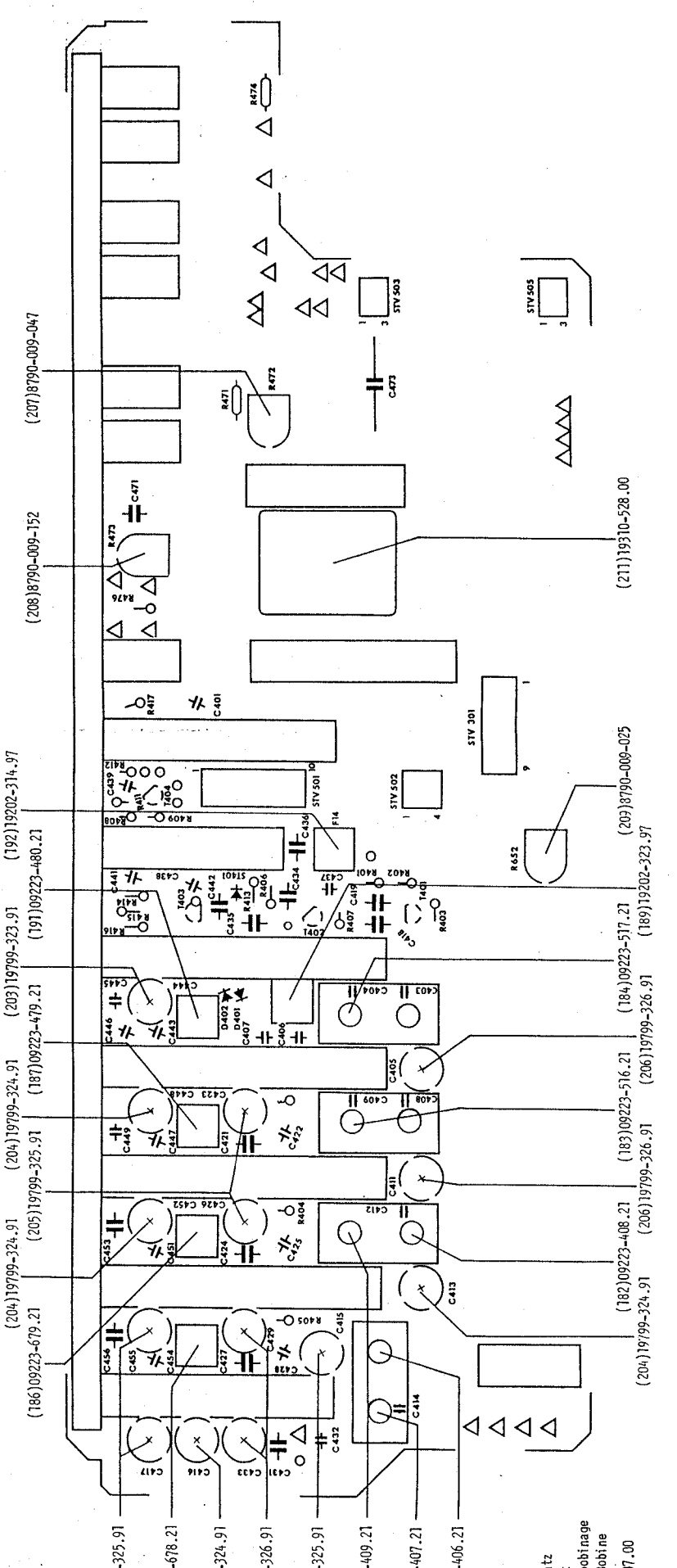

lensatz
 set
 de bobinage
 apo Bobine
 15-007.00

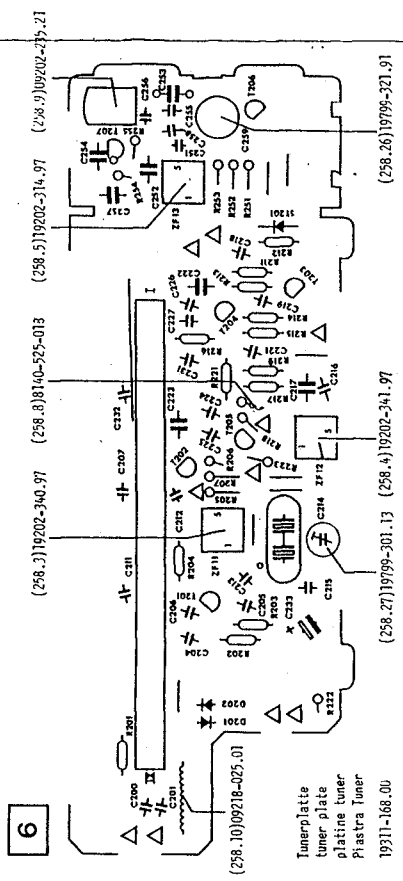

6

Tunerplatte
tuner plate
platine sbb
Plastra tuner
19311-168.00

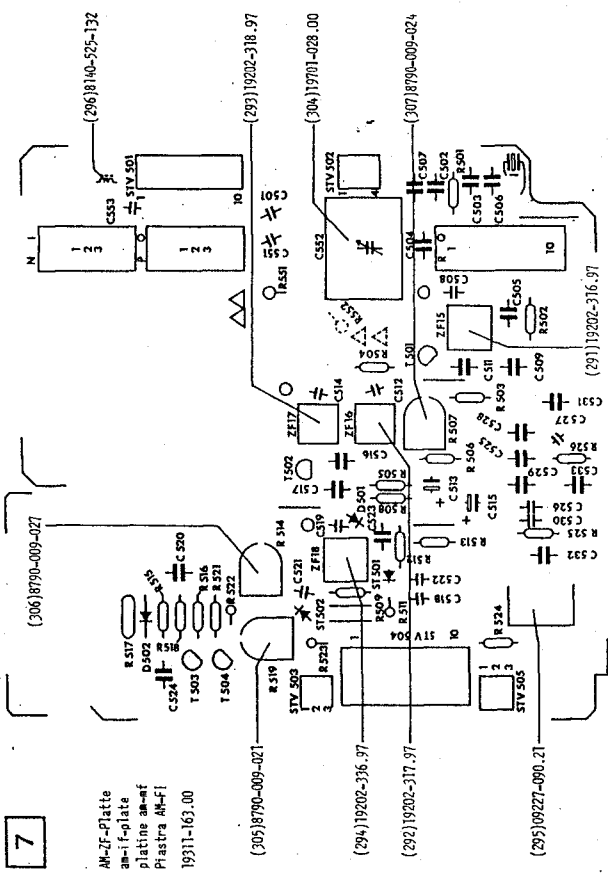

7

AM-FI-Platte
am-f-plate
platine am-f
Plastra AM-FI
19311-163.00

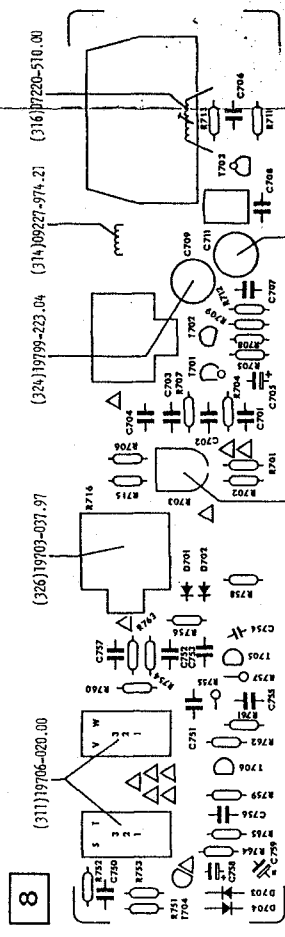

8

SSB-Platte
ssb-plate
platine sbb
Plastra SSB
19311-174.00

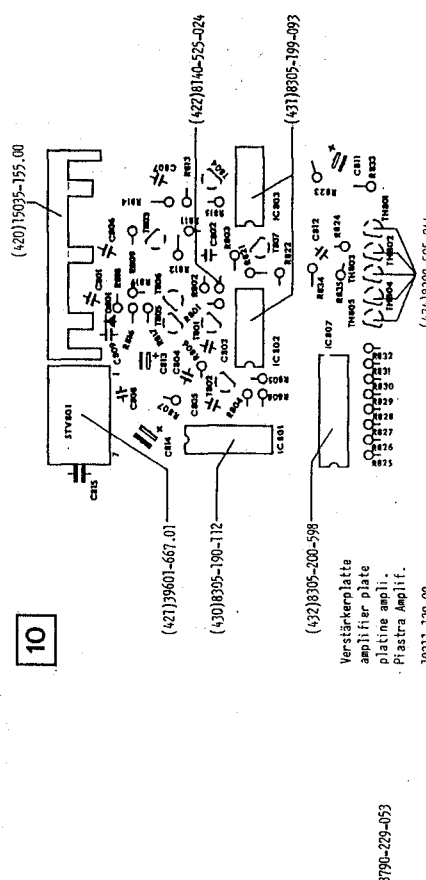

10

Verstärkerplatte
amplifier plate
platine ampl.
Plastra Amplif.
19311-129.00

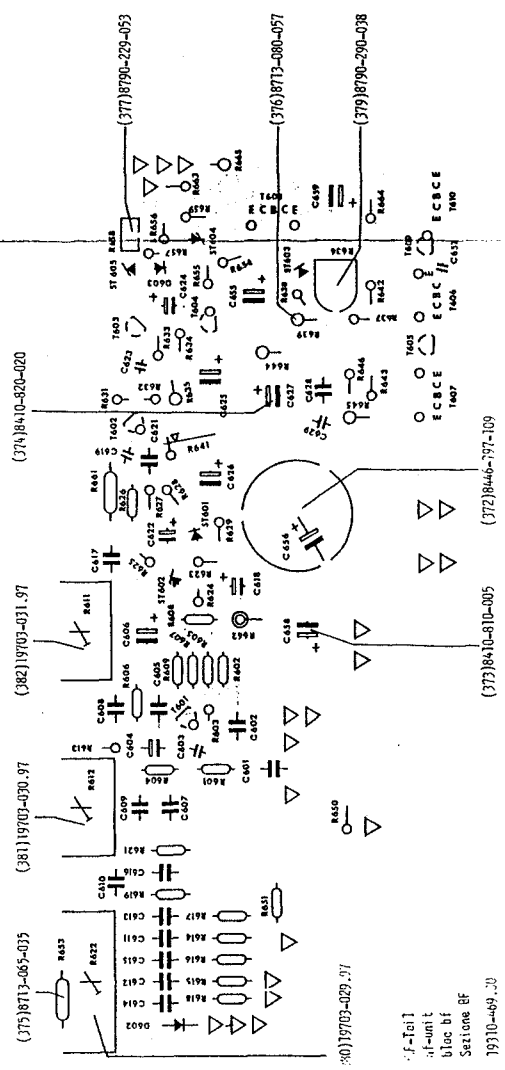

9

-Tail
-unit
blue bf
Section BF
19710-049.20

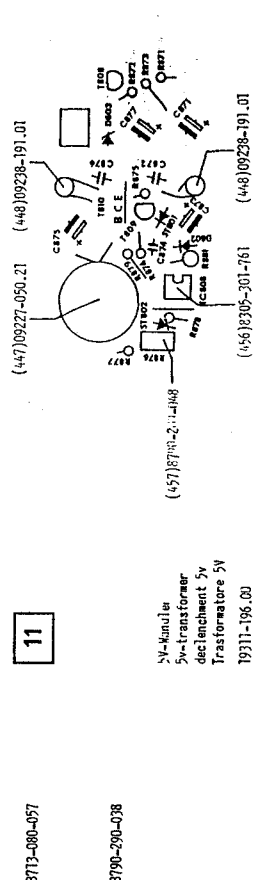

11

5V-Transformler
5v-transformer
detection 5v
Trasformatore 5V
19311-195.00

19420-010.00
 FM-Teil, Lötseite
 FM-UNIT, SOLDER SIDE
 PARTIE-FM, COTE SOUDURES
 PARTE-FM, LATO SALDATURE

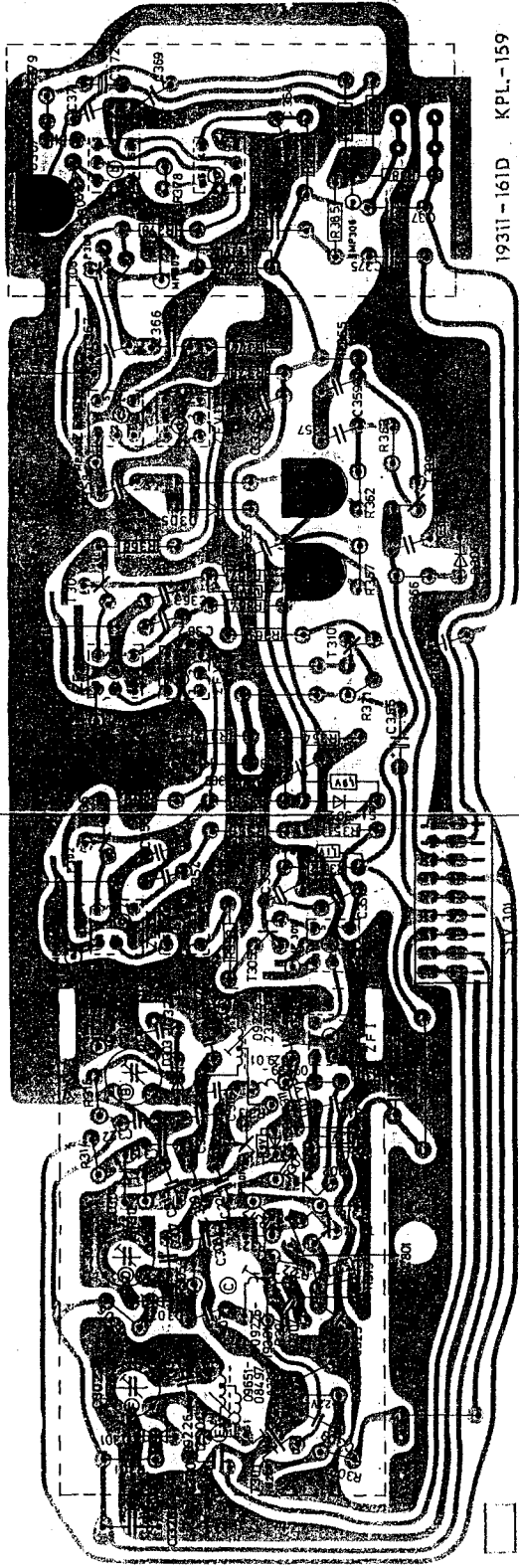

19311-161D KPL-159

19311-174.00
 SSB-Platte, Lötseite
 SSB-BOARD, SOLDER SIDE
 PLAGUE-SSB, COTE SOUDURES
 PIASTRA-SSB, LATO SALDATURE

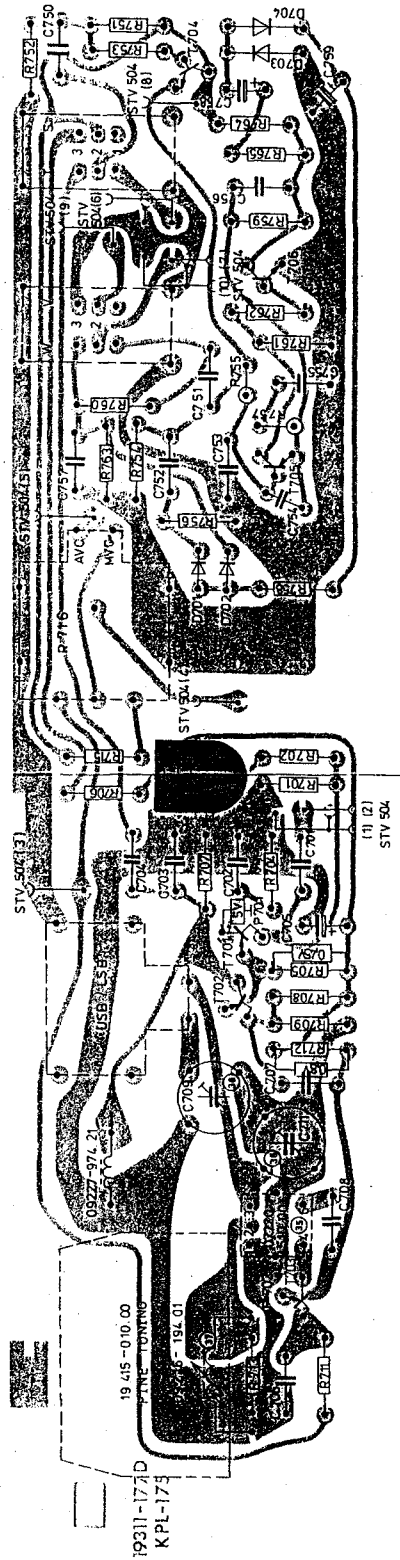

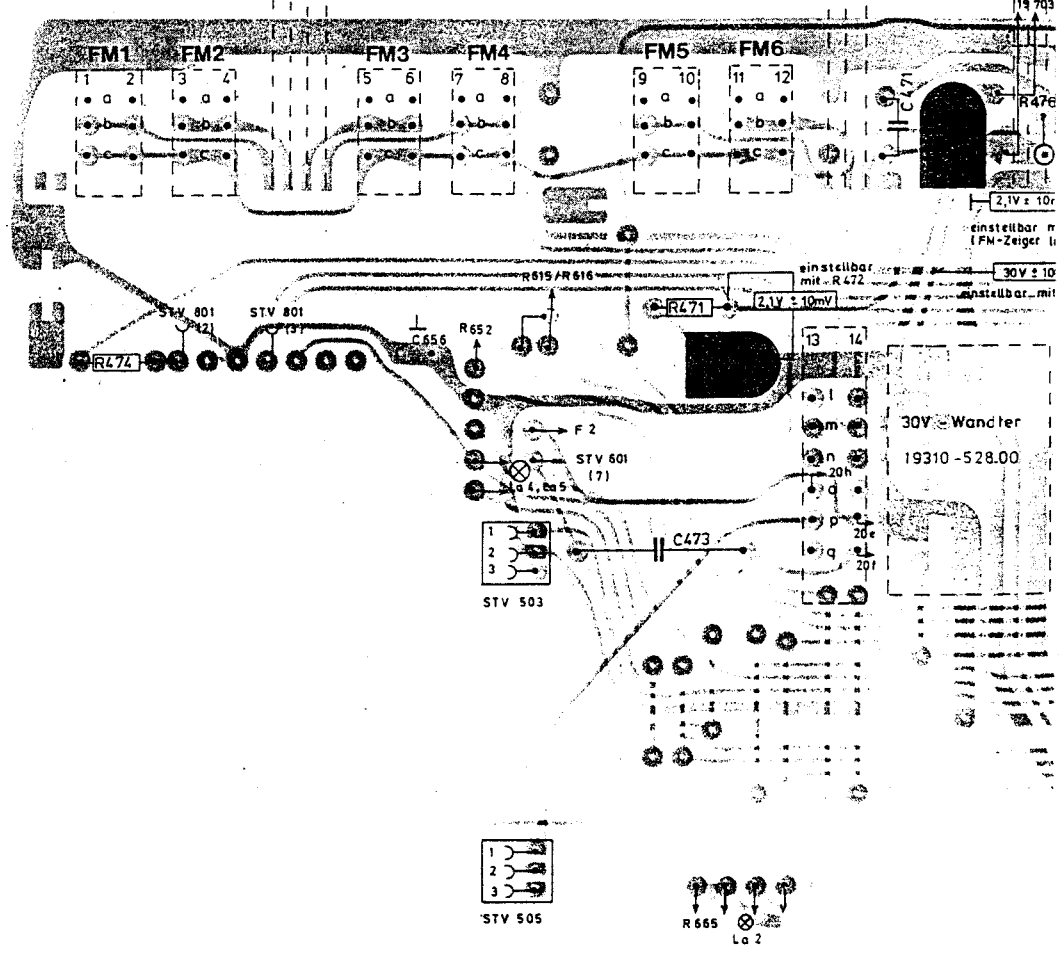
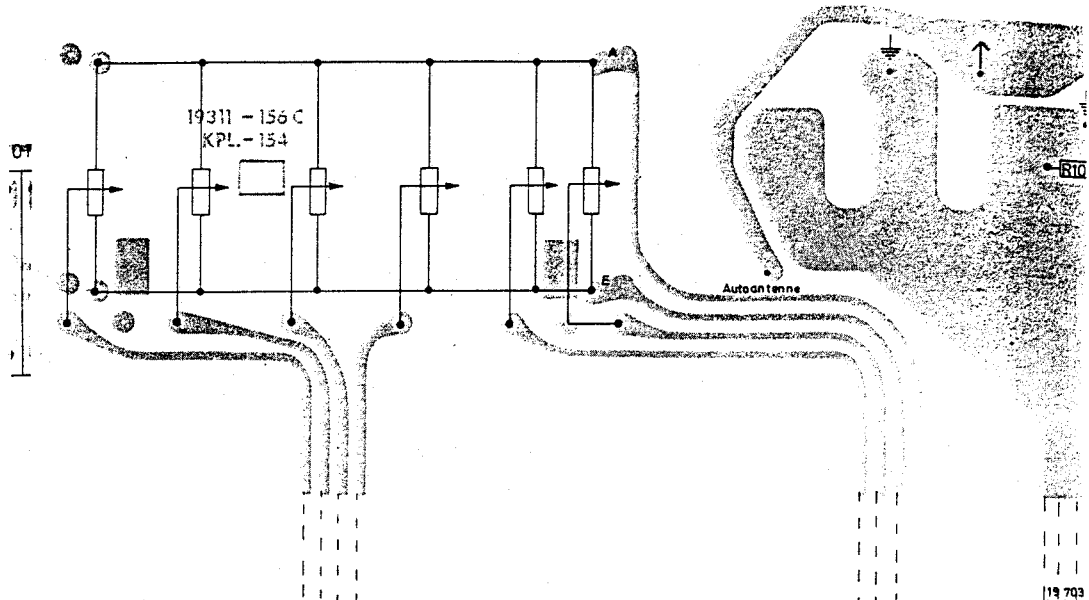

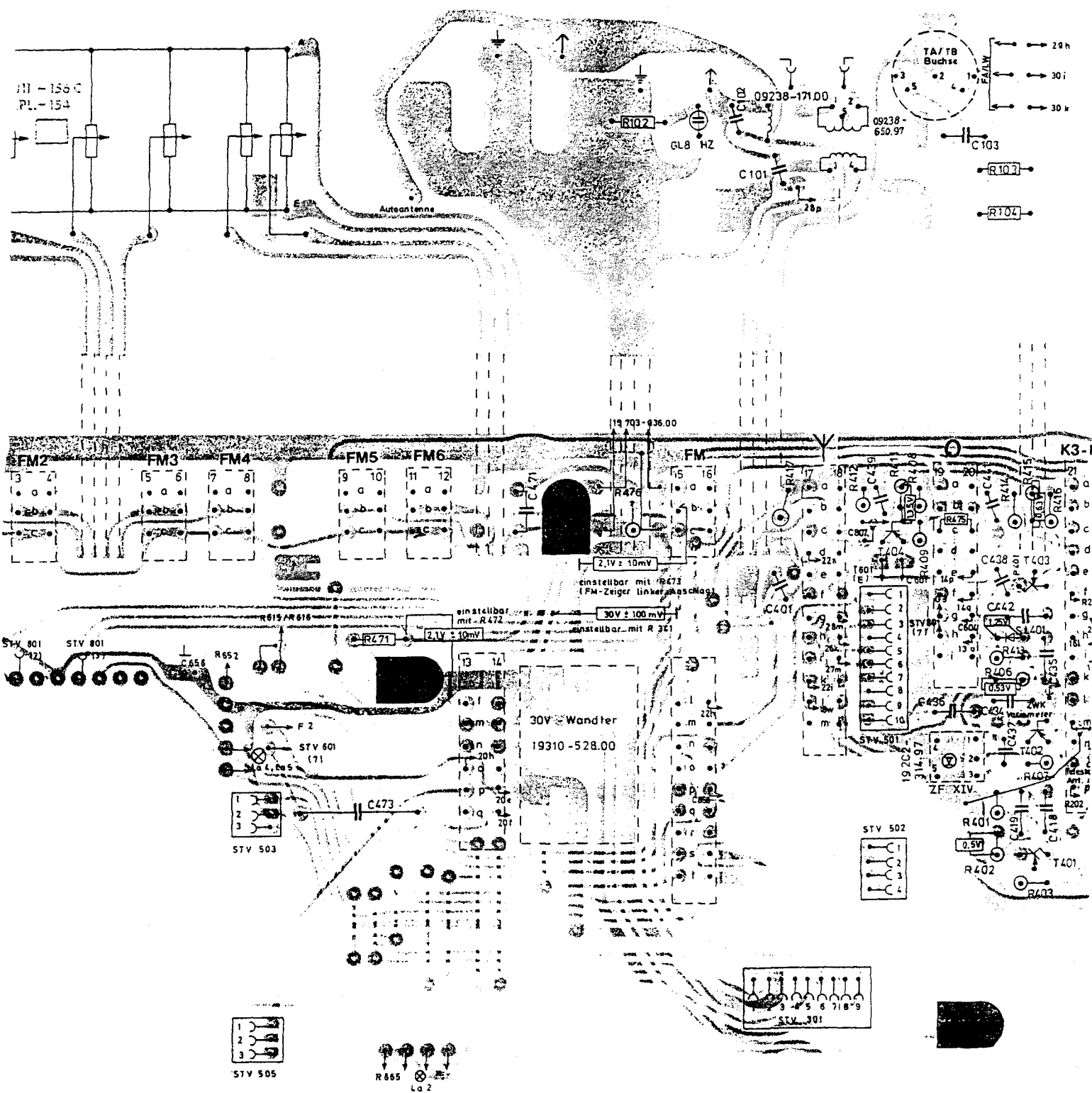

111 - 156 C
PL - 154

Autoantenne

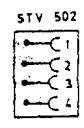
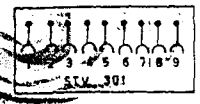
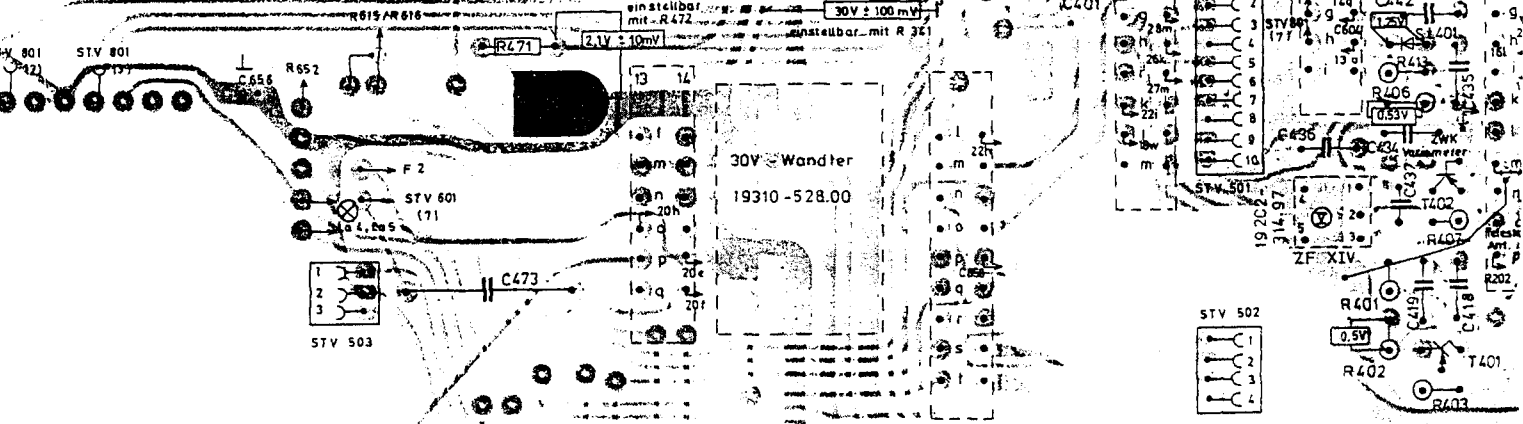
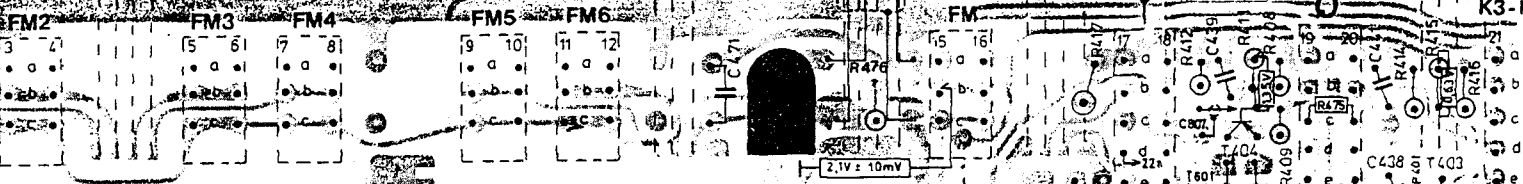
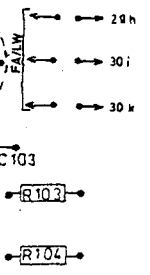
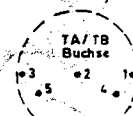

19311-153.00
Buchsenplatte, Lötseite
SOCKET BOARD, SOLDER SIDE
PLAQUE DE PRISES, COTE SOUDURES
PIASTRA PRESE, LATO SALDATURE

19415-007.00
Spulensatz, Lötseite
COIL SET, SOLDER SIDE
BLOC BOBINAGE, COTE SOUDURES
COMPLESSO DELLE BOBINE-
GRUPPO-AF, LATO SALDATURE

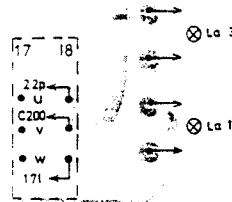
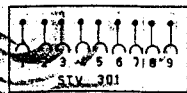
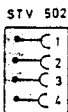
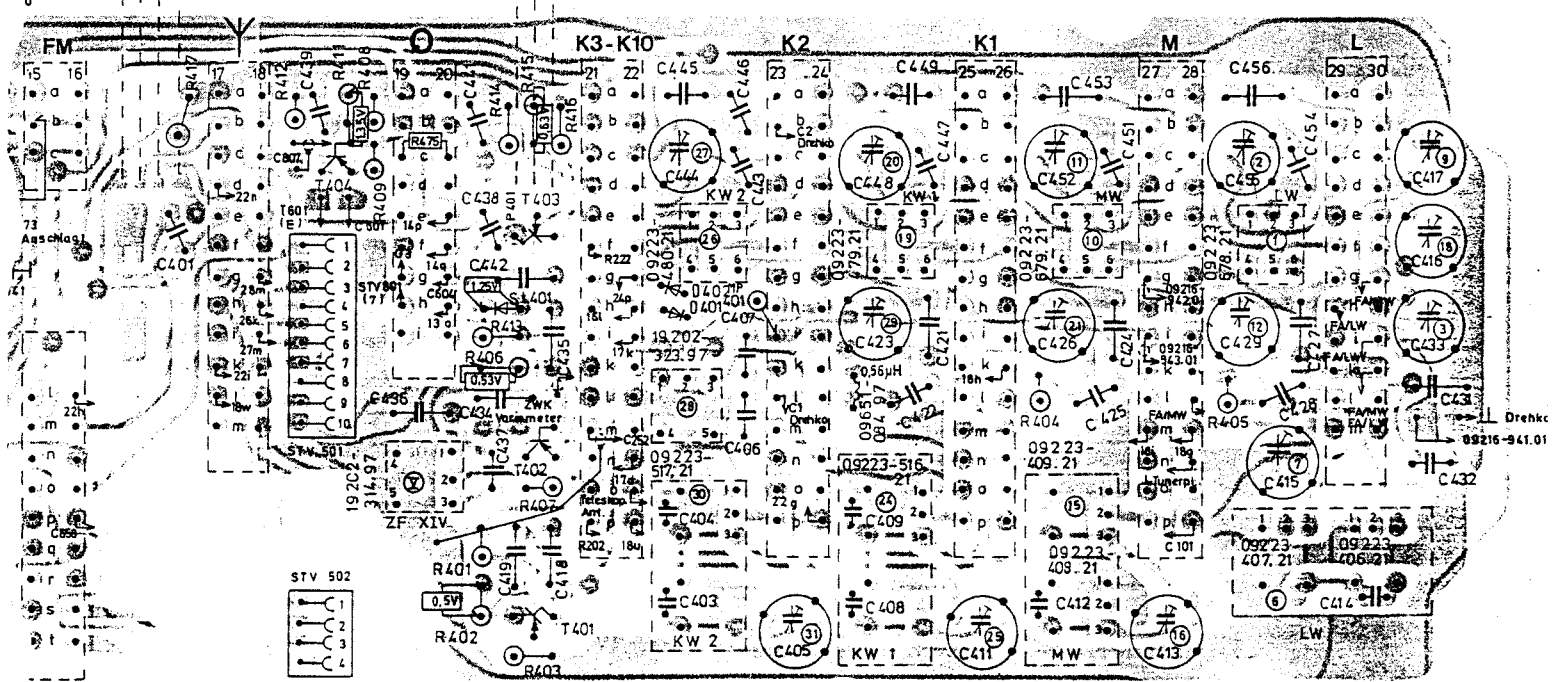
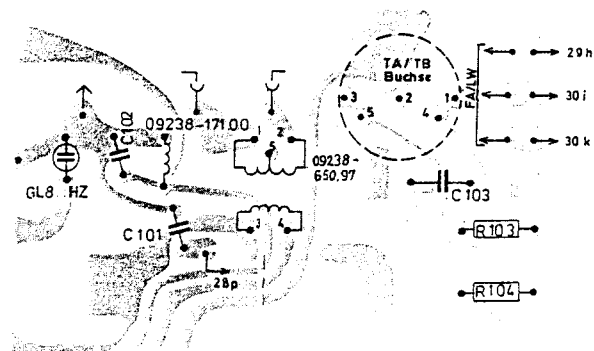

Bestückungsseite
COMPONENT SIDE
VUE DU COTE DES COMPOSANTS
LATO COMPONENTI

Lötseite
SOLDER SIDE
COTE DES SOUDURES
LATO SALDATURE