



INSPIRE VLF-3 Receiver Kit

Assembly Instructions

The following assembly instructions should be followed carefully. The INSPIRE VLF-3 receiver kit is NOT a simple electronic assembly. If you follow the instructions carefully you should be successful in building a receiver that works. If you are not careful, you run the risk of having a problem that is very difficult to locate and fix. Be careful, take your time, and GOOD LUCK!

TOOLS NEEDED:

Philips head screwdriver
Small standard screwdriver
Wire cutters
Wire stripper
Soldering iron (15-25 watt, small tip)
Light duty resin core solder (60/40)
Sponge
Magnifying glass
Solder sucker or solder wick

KIT CONTENTS:

1. Black plastic enclosure
2. Face Plate
3. Printed Circuit Board (PCB)
4. Four bags of components:
 - Bag 1 resistors, inductors
 - Bag 2 capacitors
 - Bag 3 ICs, diodes, sockets
 - Bag 4 switches, jacks, knobs, antenna terminal, wires, misc. hardware

VLF-3 Assembly Instructions

Faceplate

Front Control Panel



Printed Circuit Board (PCB):

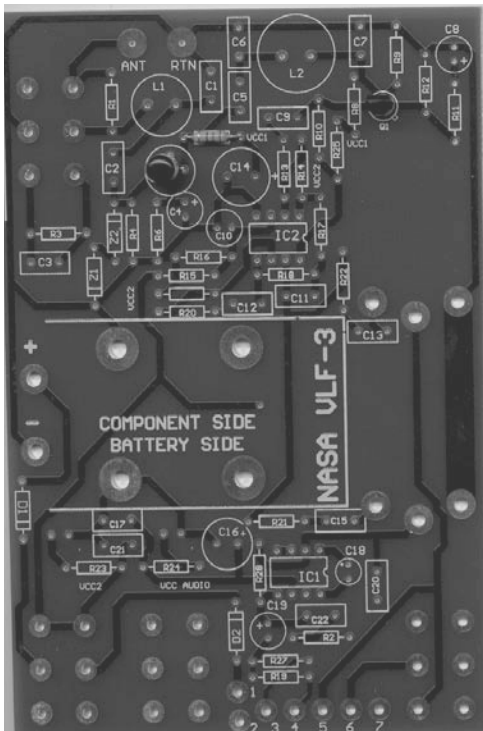

Component Side / Battery Side

All electronic components are inserted from this side and soldered on the other side. The battery holder is inserted from this side also.

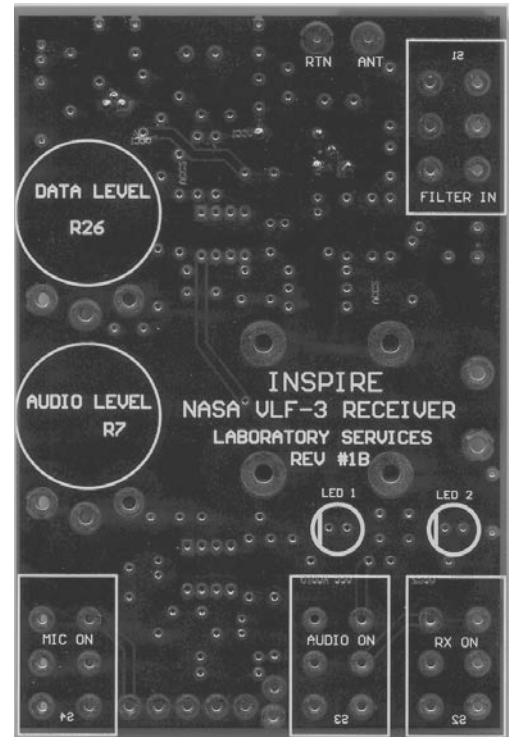

Switch Side

The four DPDT slide switches, the two 10k pots and the two LEDs are inserted from this side and soldered on the other side.

VLF-3 Assembly Instructions

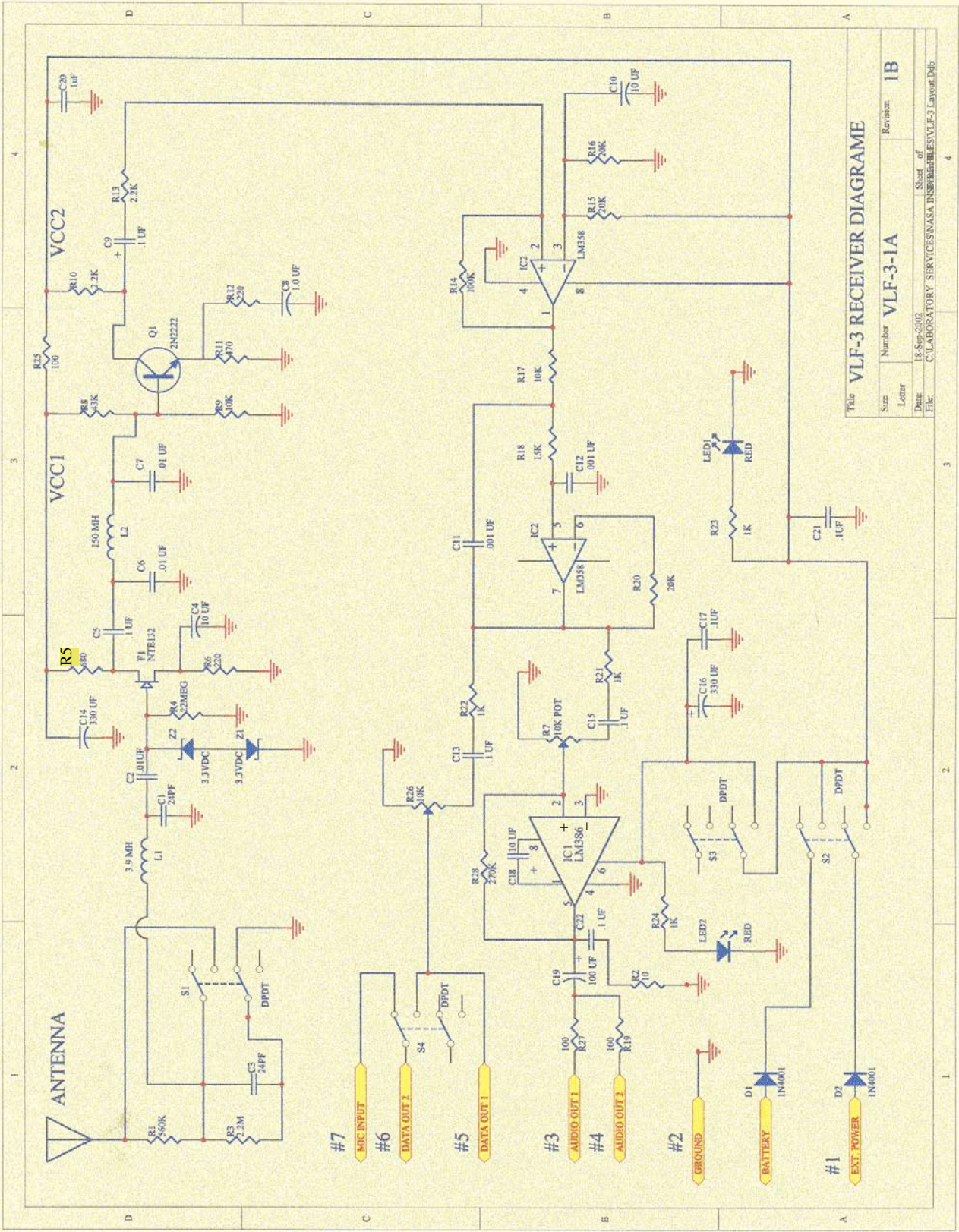

VLF-3 Assembly Instructions

ASSEMBLY SEQUENCE

1. Solder components to PCB.
2. Assemble jacks subassembly, connect wires to antenna terminal.
3. Connect wires to PCB.
4. Final assembly of receiver.
5. Test receiver.

(Check off boxes as each step is completed.)

1. Solder components to PCB.

(NOTE: The transistor (Q1) and the field effect transistor (J-FET with ferrite bead) have been preinstalled.)

- 1a. Sort and install resistors.

Remove the resistors from Bag 1. Leave the inductors for later installation.

The colored bands on the resistors indicate the resistance using a color code. This table indicates how to convert each color to its numerical equivalent.

0	black
1	brown
2	red
3	orange
4	yellow
5	green
6	blue
7	violet
8	gray
9	white

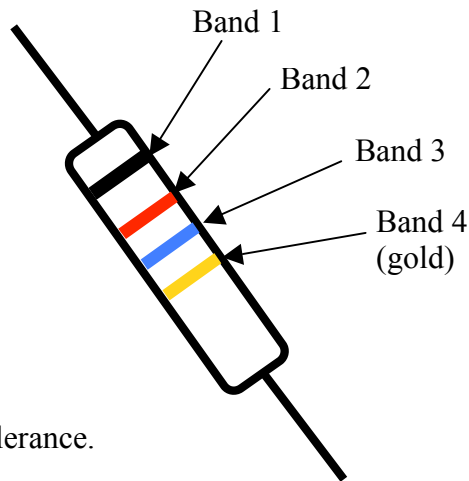

gold: 5% tolerance.

To read a resistor code, first locate the gold band and read the colors in order from the other end. (All resistors in this kit have a gold band indicating 5% tolerance.) The first two bands indicate digits in the resistance, the third band (called the multiplier) indicates the number of zeroes to be added to the digits to obtain the resistance.

(NOTE: 1000 = kilo = k ; 1,000,000 = mega = Meg)

Bag 1 Contents

Resistors:

R1	560 k Ω
R2	10 Ω
R3	2.2 Meg Ω
R4	22 Meg Ω
R5	680 Ω
R6, R12	220 Ω
(R7, R26	10k pots in Bag #4)
R8	43 k Ω
R9, R17	10 k Ω
R10, R13	2.2 k Ω
R11	470 Ω
R14	100 k Ω
R15, R16, R20	20 k Ω
R18	15 k Ω
R19, R25, R27	100 Ω
R21, R22, R23, R24	1 k Ω
R28	270 k Ω

Inductors

L1	3.9 mH
L2	150 mH

VLF-3 Assembly Instructions

What is the resistance for each of the following?

	Example 1	Example 2	Example 3	Example 4
Band 1	brown	yellow	red	orange
Band 2	black	violet	black	orange
Band 3	brown	orange	green	orange
Band 1	1	4	2	3
Band 2	0	7	0	3
Band 3	1	3	5	3
Resistance	100 100 Ω	47000 47 k Ω	2000000 2 Meg Ω	33000 33 k Ω

Use the resistor code to identify and sort all of the resistors. One good way to keep them sorted is to tape one end to a piece of paper and write the resistance and component number (R1, R2, etc.). Once you have identified and sorted all of the resistors, you are ready to solder them to the PCB.

To prepare a resistor for insertion into the board, bend the two leads so that they form a right angle to the resistor body.

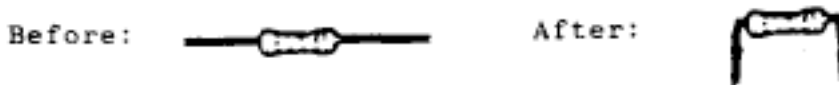

Resistor locations on the component side of the PCB are indicated with the “R” number from the parts list between the two holes for insertion of the leads.

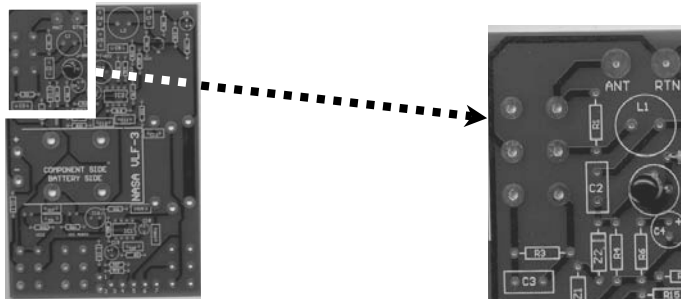

Part of the PCB showing location of R1, R3, R4 and R6.

To install, place the leads of the resistor through the appropriate holes and press the resistor down against the component side of the PCB. (There is no required orientation for resistors. Either lead may be inserted in either hole.) Turn the board over while holding the resistor in position and bend the leads slightly outward to hold the resistor in place and solder the leads to the circuit side. (NOTE: There will be an empty resistor symbol on the PCB between R15 and R20. No part will be installed in this location.)

STEPS FOR SOLDERING RESISTORS, CAPACITORS AND WIRES:

IMPORTANT:
DO NOT leave a soldering iron plugged in for a long time without using it.
NEVER leave a hot soldering iron unattended.

1. Clean the tip of the iron by wiping it on the wet sponge.

2. Place a small amount of solder on the tip.

3. Press the tip down against the circuit contact and against the resistor lead and hold for 5 seconds.

4. After the lead and the contact have heated for 5 seconds, apply the solder to the lead and contact (NOT directly to the iron) until the solder melts and flows around the lead and into the contact.

5. Apply enough solder to allow it to run down along the lead. Do not apply so much solder that it runs across the PCB surface.

6. After enough solder has been applied (1-2 seconds), remove the solder wire but hold the iron in place for another 2-3 seconds.

7. Remove the iron, allow the joint to cool and inspect the joint.

8. Trim the excess lead wire just above the solder joint.

Repeat this process for the remaining resistors.

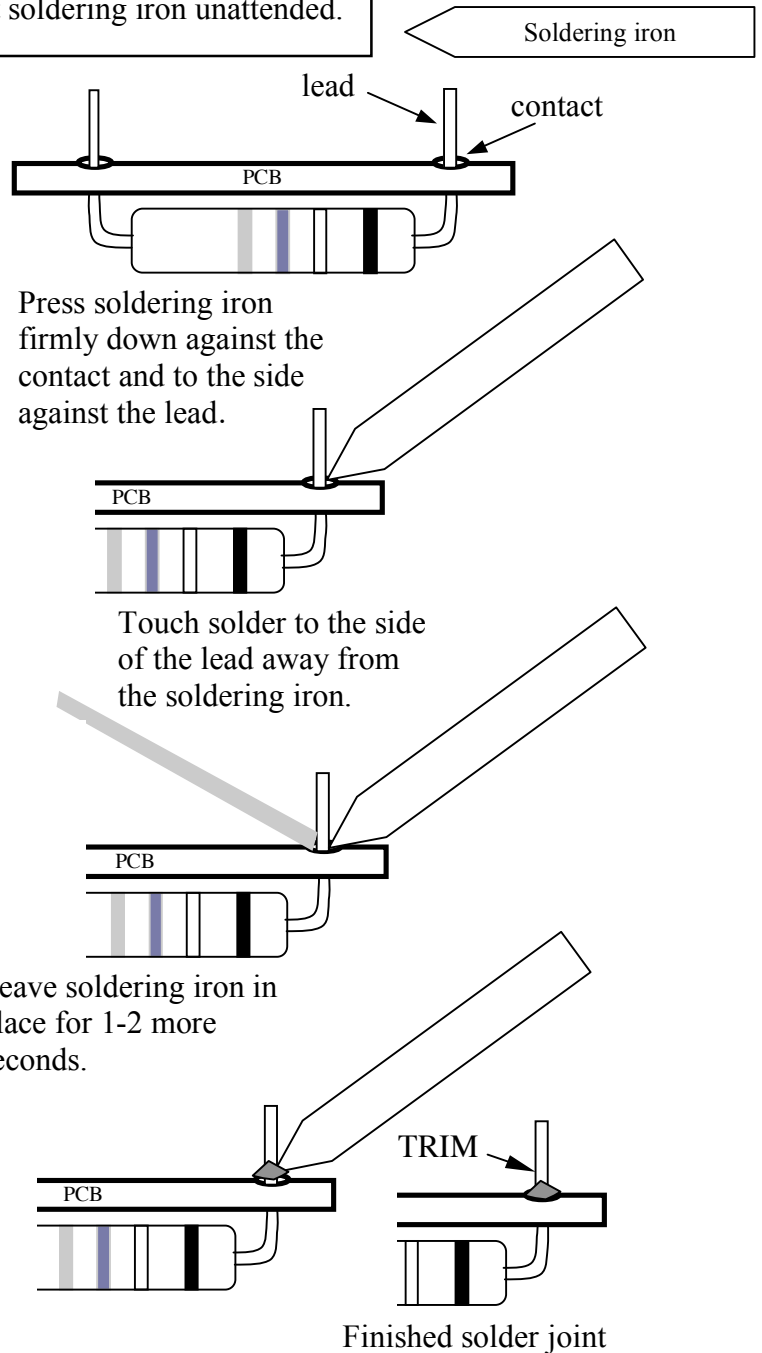

VLF-3 Assembly Instructions

IMPORTANT Note for New Soldering Irons:

A new soldering iron must be “tinned” in order to work well. Follow these steps:

1. Plug in the iron.
2. When it first heats up, apply solder liberally to the tip.
3. Wipe off the excess solder and you are ready to go!

1b. Install the IC sockets.

Remove the IC sockets and IC1 (LM386) and IC2 (LM358) from Bag #3. When installing IC sockets and ICs, alignment is very important. One end of the IC symbol on the PCB has a half-hole at one end of the symbol. One end of the socket has a half-hole. The IC itself has a circular dot near one end.

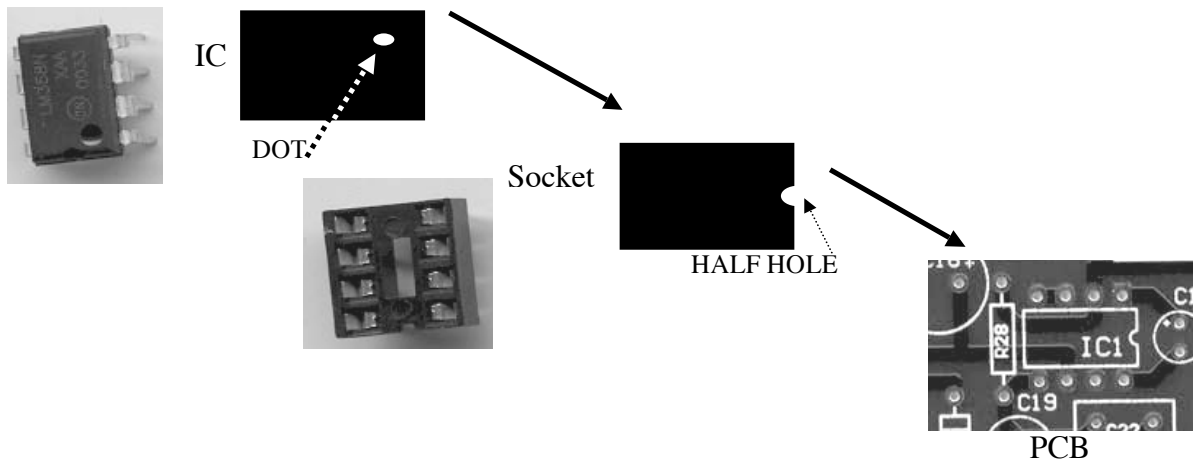

Install the sockets so that the half-hole end coincides with the half-hole on the PCB. Press the sockets firmly against the component side of the PCB. Solder the 8 pins on the other side of the PCB taking care not to create any solder “bridges” between the pins.

Install the IC so that the end with the dot is at the end of the socket with the half-hole. Carefully fit the 8 pins in the socket holes and press the IC firmly into the socket.

VLF-3 Assembly Instructions

- 1c. Solder capacitors to the PCB.

Capacitor Identification Guide

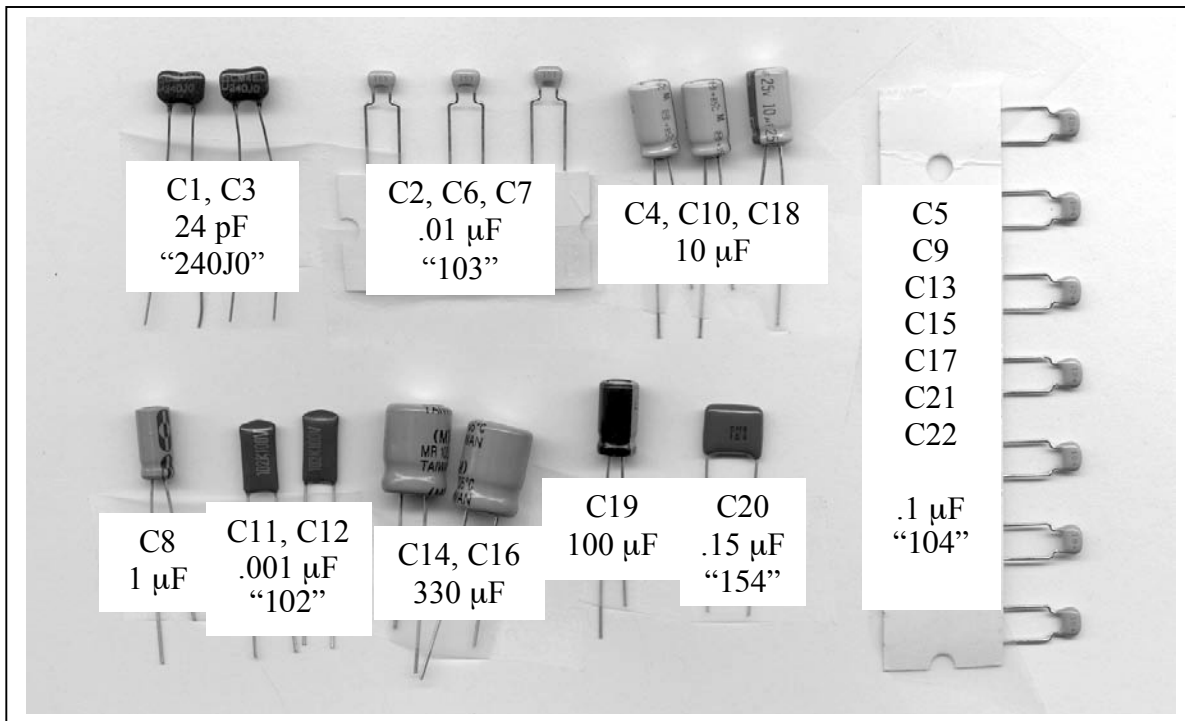

The small-value ceramic capacitors may be installed in either orientation, but the larger-value cylindrical capacitors (C4, C8, C10, C14, C16, C18, C19) must be installed with the proper polarity.

The polarity is indicated on the PCB by a “+” sign near one end of the capacitor location.

The polarity is indicated on the body of the capacitor with a stripe with a minus (-) sign located on the negative side of the capacitor. Also, the shorter lead is the negative lead.

To install a capacitor, insert the leads in the appropriate holes and press the capacitor down near the PCB. Solder using the same technique as used for resistors.

Bag #2 Contents

Capacitors:

C1, C3	24 pF
C2, C6, C7	.01 μF
C4, C10, C18	10 μF
C5, C9, C13, C15, C17, C21, C22	.1 μF
C8	1 μF
C11, C12	.001 μF
C14, C16	330 μF
C19	100 μF
C20	.15 μF

The polarity is not marked on capacitor C 10.
The proper polarity is indicated here:

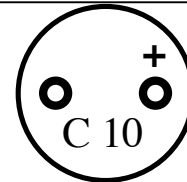

NOTE: There may be some variation in capacitor markings due to using different suppliers.

VLF-3 Assembly Instructions

- 1d. Install the inductors (L1 and L2)

The inductors are the two remaining parts in Bag #1. Inductor L1 is marked “LH 239”.. Inductor L2 is marked “LJ 415”. From the component side, press the inductor firmly down against the PCB and solder the other side. There is no required polarity for the inductors.

- 1e. Install the diodes from Bag #3.

Polarity is very important in the installation of diodes.

D1 and D2 are black cylinders with a silver stripe near one end.



On the PCB, the D1 and D2 locations are shown as a rectangle with a stripe near one end.



Align the striped end of the diode with the striped end of the PCB symbol. Press the diode firmly against the component side of the PCB and solder the other side.

Z1 and Z2 are small components with a black stripe near one end. The symbol on the PCB is the same as for D1 and D2. As with D1 and D2, align the black stripe end with the striped end on the PCB. Press the diodes firmly against the PCB and solder the other side.

Return the LEDs to Bag #3. They will be installed later.

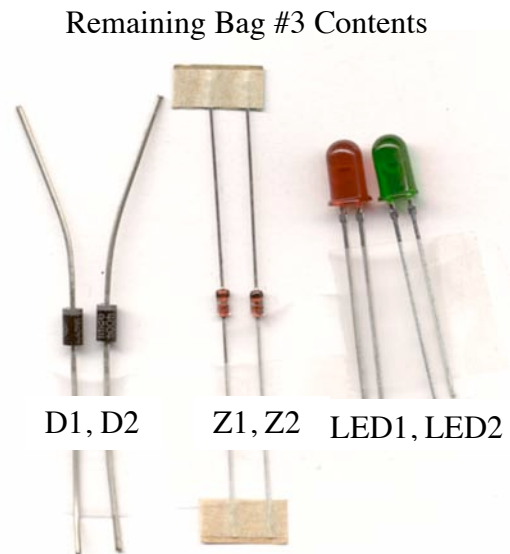

VLF-3 Assembly Instructions

- 1f. Install the battery holder.

From Bag #4, take the following parts:

1. Battery holder
2. PCB standoff post
2. 4-40 3/8" screw
4. 4-40 1/4" screw
2. 4-40 nuts
2. nylon washers
2. #4 washers

The following diagram shows the assembly of the battery holder to the PCB:

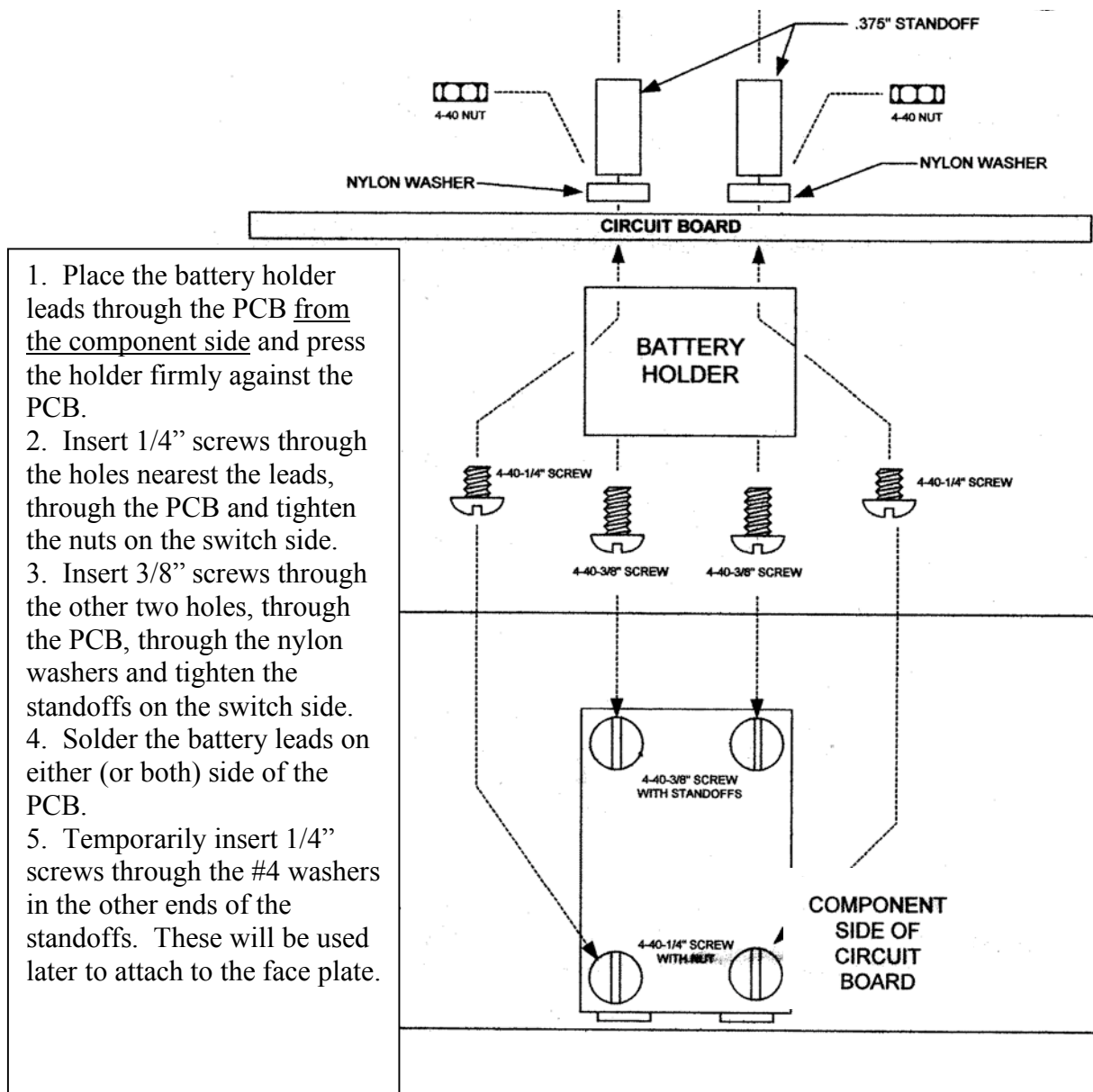

VLF-3 Assembly Instructions

- 1f. Install the potentiometer and switches.

From Bag #4, remove the two 10k pots (R7 and R26) and the four DPDT slide switches.

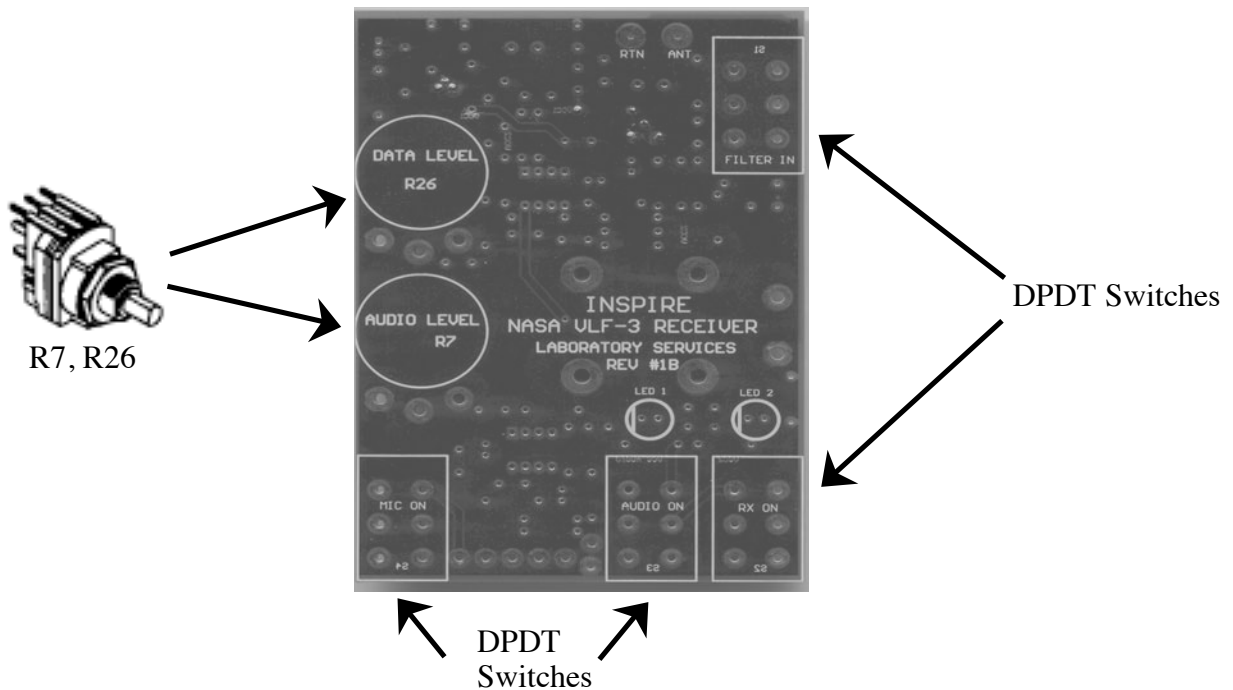

Slide the three contacts for the pots through the holes provided from the switch side of the PCB. Push the switch firmly against the PCB and solder either (or both) sides.

Insert the six contacts for each DPDT slide switch into position and press the switch firmly against the switch side of the PCB. Solder each contact on the component side.

- 1g. Install the LEDs.

Align the LED leads as shown with the shorter lead closest to the line in the PCB symbol.

Carefully work the LED down as far as it will go toward the PCB. When in the proper position, the top of the LED will be even with the tab on the adjacent power switch.

Solder the LED leads to either side of the PCB. Carefully trim the excess leads.

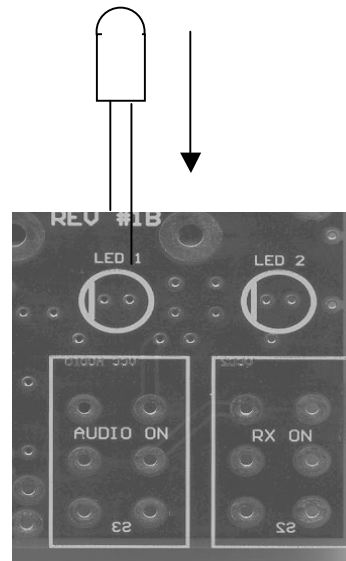

THIS COMPLETES THE INSTALLATION OF ALL PARTS ON THE PCB!

VLF-3 Assembly Instructions

2. Attach wires to the PCB.

Bag #4 contains the following wires:

3" red
4" orange
4" yellow
3" blue
3" black
5" white

Make the following cuts on the wires:

1 red: 1", 2"
1 orange: 2", 2"
1 yellow: 2", 2"
1 blue: 3"
1 black: 1", 2"
1 white: 2", 1.5", 1.5"

To prepare a wire for soldering, strip about 1/8" of insulation from each end. To solder a wire to the PCB:

1. insert the wire into the component side,
2. press the soldering iron to the wire and to the metal pad on the PCB for about 5 seconds to heat both the wire and the pad,
3. apply solder to the side away from the soldering iron making sure that the wire and pad melt the solder, not the soldering iron.

Solder the 1" red wire to the ANT connection on the PCB.
Solder the 1" black wire to the RTN connection on the PCB

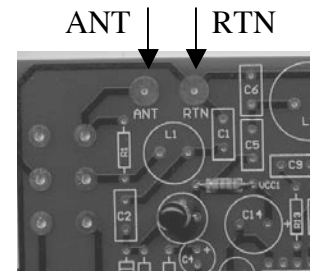

The wire connections to the PCB are numbered 1-7.

Connect the following wires to the appropriate locations:

- Connection 1: 2" red wire
- Connection 2: 2" black wire and 2" white wire twisted together
- Connection 3: 2" orange wire
- Connection 4: 2" orange wire
- Connection 5: 2" yellow wire
- Connection 6: 2" yellow wire
- Connection 7: 3" blue wire

See also the photos on the following page.

VLF-3 Assembly Instructions

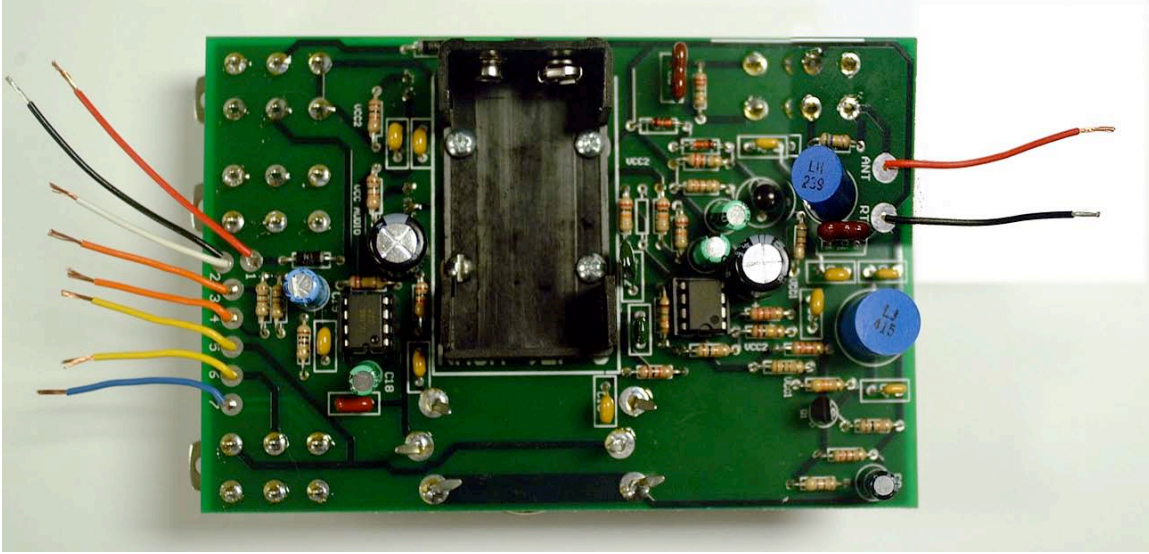

Wires installed (component-side view)

Close up of white and black wire twisted together prior to being soldered to location #2 on the PCB.

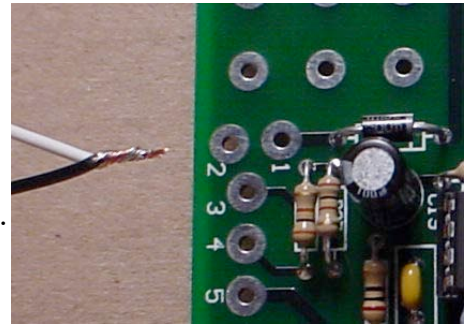

Wires installed (switch-side view)

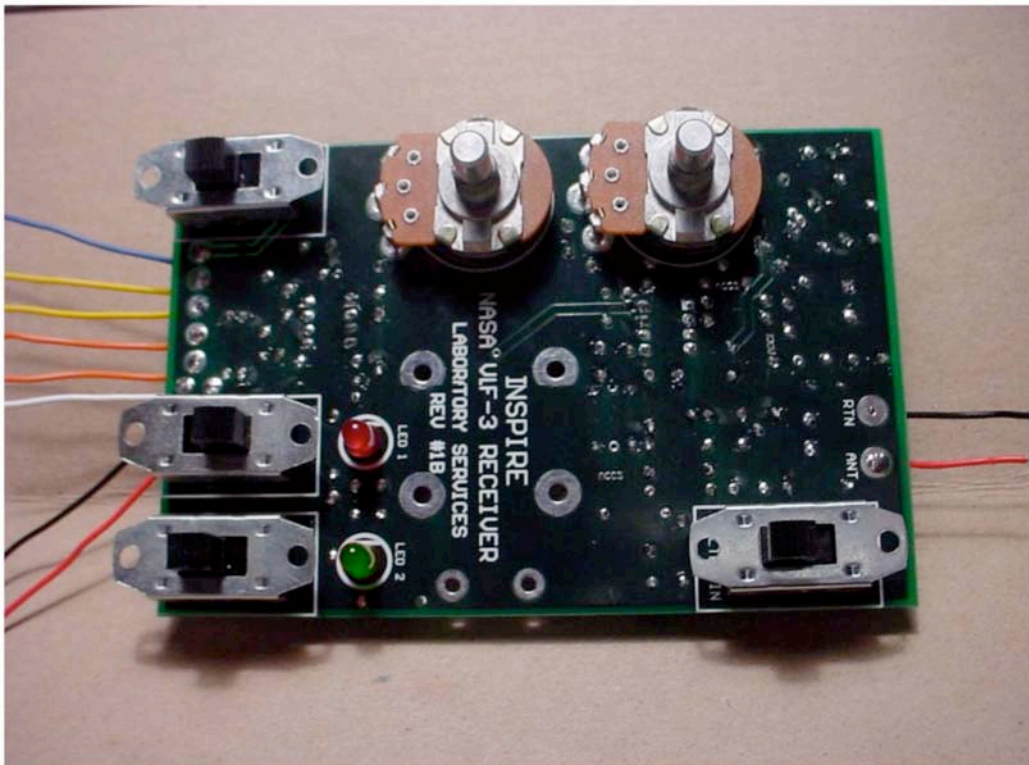

VLF-3 Assembly Instructions

3. Install the jacks and connectors to the faceplate.

Install the jacks and the external power connector to the faceplate by inserting them from the back side and tightening the knurled nut on the front side. Mount the 2-screw antenna terminal to the faceplate by placing the terminal in front of the faceplate and using the two remaining 4-40 1/4" screws and nuts. Mount the BNC connector by removing the nut and washer, inserting the connector from the front of the panel and tightening the nut over the washer.

4. Attach the PCB to the faceplate.

Remove the nuts and washers from the standoffs and the nuts from the shafts of the 10k pots. Attach the faceplate to the PCB by fitting the faceplate over the switches and LEDs. Tighten the screws and washers to the standoffs. Tighten the nuts on the 10k pot shafts.

5. Solder wires to jacks and connectors.

To solder the wire to a jack contact:

1. insert the wire through the hole in the tab,
2. press the soldering iron to both the wire and the tab and heat for 5 seconds,
3. apply the solder to the side away from the soldering iron, making sure that the wire and tab melt the solder, not the iron.

Use the following figure as a guide for wiring connections to the jacks and the external power connector. See also the photo on the next page.

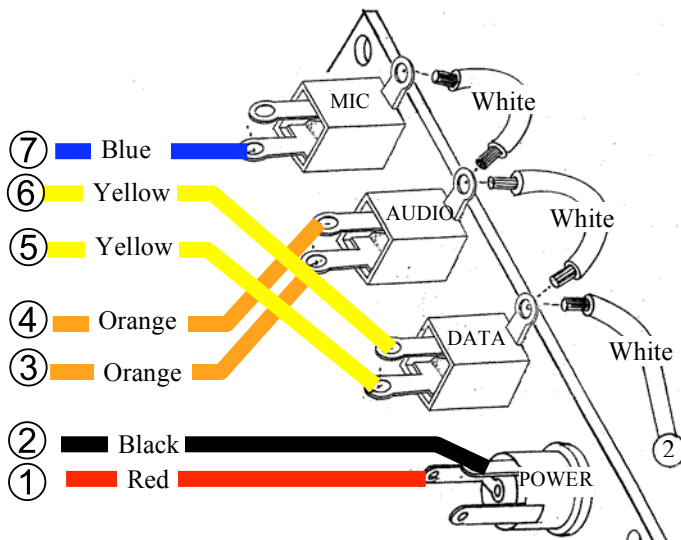

NOTES:

1. The yellow and orange wires must cross to reach the correct jacks.
2. The white ground wire and the black wire both connect to Location 2.

The monaural jack (white body) is the MIC jack. The blue wire connects to this jack.

The center two are the Audio and Data jacks and are the black body stereo type.

The round one is the external power connector.

VLF-3 Assembly Instructions

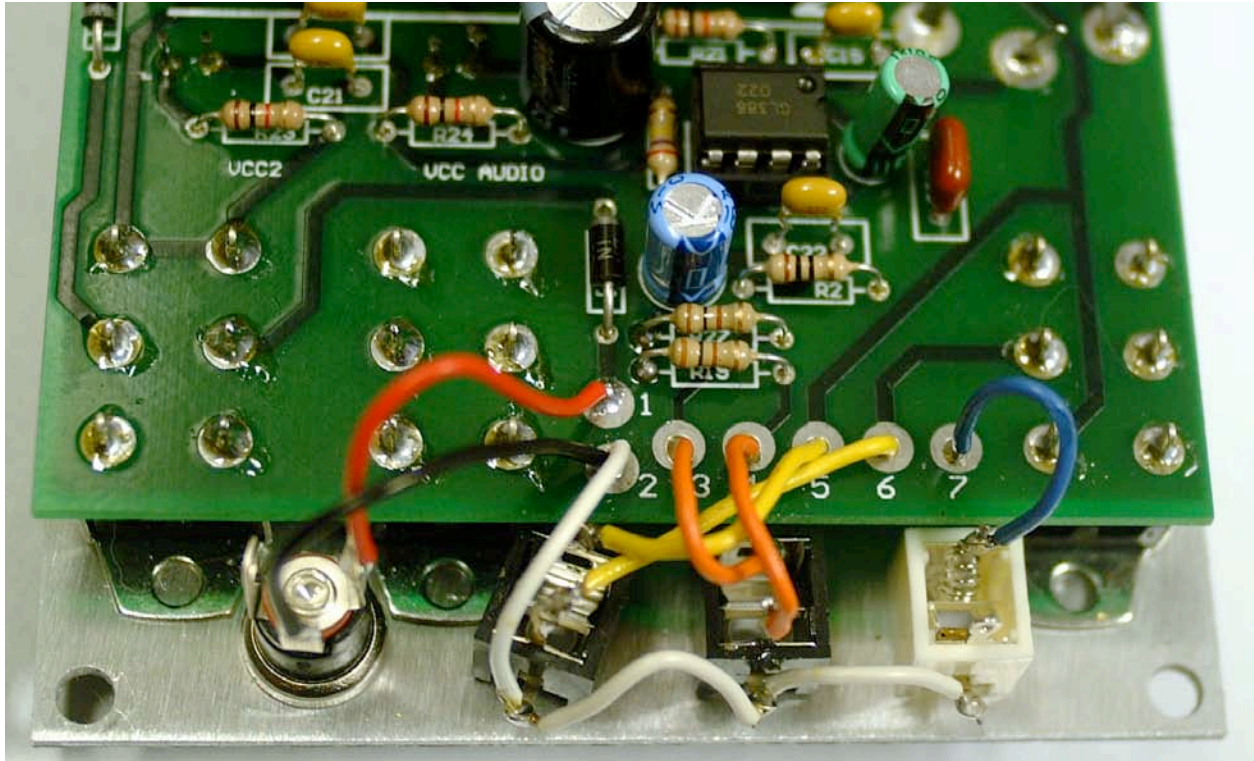

Close-up showing wires soldered to the jack tabs.

NOTE: The orange and yellow wires must cross to connect to the appropriate jacks.
The microphone connector may be either white (as pictured) or black



Front view of completed
VLF-3 receiver

VLF-3 Assembly Instructions

Solder the black “RTN” wire to the RTN side of the antenna terminal.

Insert the red wire into the BNC connector and solder in place. Solder both red wires to the “ANT+” side of the antenna terminal.

Use the set screws to attach the knobs to the 10k pot shafts.

Install a 9-volt battery in the battery holder.

Use the 4 6/32 1/4 inch screws to attach the faceplate to the enclosure

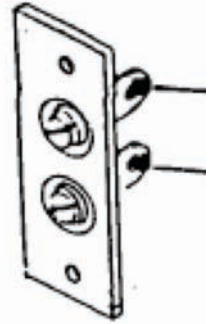

Antenna Terminal

THIS COMPLETES THE ASSEMBLY OF YOUR VLF-3 RECEIVER!

6. Test your receiver.

Attach an antenna to the ANT+ terminal. A 1-2 meter piece of wire will do.

Attach a ground to the RTN terminal. A short wire that you hold in your hand will do.

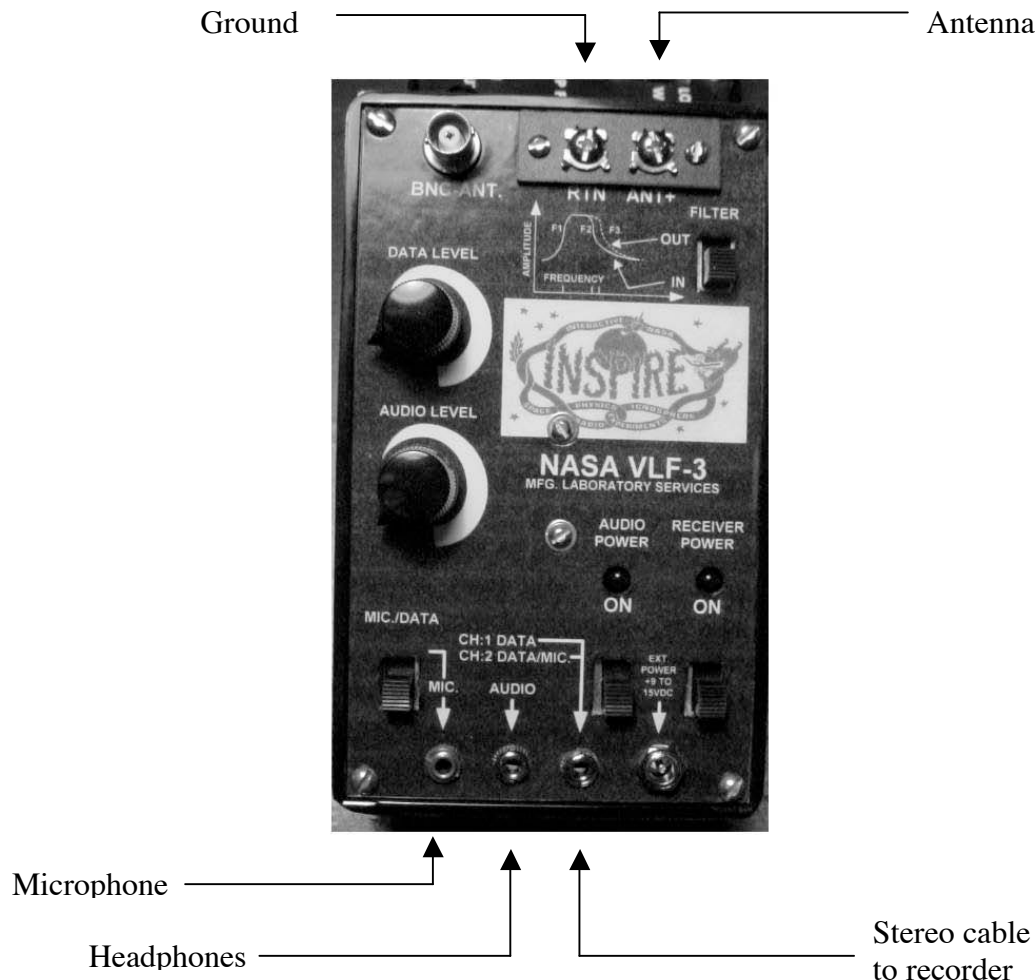

VLF-3 Assembly Instructions



6a. Test the audio output.

Plug some headphones in the audio output jack.

Turn on the “RECEIVER POWER” switch (main power switch).

Turn on the “AUDIO POWER” switch and slowly turn the “AUDIO LEVEL” up.

You should hear a loud hum as you pick up the 60 hertz signal given off by building wiring.



6b. Test the data output.

Connect the “DATA” output jack with the microphone input of the cassette recorder using a stereo cable.

Connect headphones to the recorder.

Put a tape in the recorder and press “RECORD”. (Put the recorder on “PAUSE” if you do not want tape running during this test.)

Turn on the “RECEIVER POWER” switch and slowly turn the “DATA LEVEL” up. You should hear the same signal as you did through the audio output.

Plug a microphone into the MIC IN jack. Slide the switch to the MIC. position. You should hear the 60 hertz hum in one ear and the microphone input in the other ear.



6c. Field test your receiver.

To ready your receiver for field testing, you will need a better antenna and a better ground.

A good antenna is a 72-inch collapsible antenna available from Pacific Antenna for \$10 plus shipping. (<http://www.pacificantenna.com/Ordering.htm>)

A 2 meter length of sturdy wire will work almost as well but is slightly less easy to transport.

A good ground is a metal stake or pipe driven into the ground. Attaching a wire from the ground terminal to the stake will provide a good ground. Attaching a wire from the ground terminal to the body of a car (a counterpoise) will work also. In a pinch, you can touch the ground terminal and use your body as a ground.

If you hear a loud squeal as the output, check the output level and the ground connections.

NOTE:

Caution should be used in identifying R3 (2.2 Meg Ω) and R4 (22 Meg Ω). The green band and the blue band can look similar. For best results, identify both components together so differences can be noted.

Loose connection joints are often the cause of the receiver not functioning properly. Checking to make sure there is a firm connection and adding a good solder joint on both sides of the board will help eliminate this problem.

Any part shortages or discrepancies should be reported to the inspire project:

president@TheINSPIREProject.org

Any corrections, suggestions or recommendations for improvement of the assembly instructions would also be appreciated.

Thank you for your participation and support of The INSPIRE Project!