

Service
Service
Service

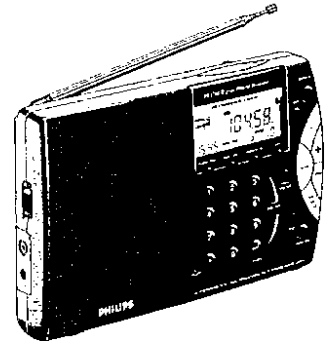

Service Manual

CONTENT	PAGE
Safety	1
Connections and Controls	2-3
Specifications	3
Radio Alignment	4
Main Board - Layout diagram	5
- Circuit diagram	6
Control Board - Layout diagram	7
- Circuit diagram	8
Exploded View Diagram	9
Electrical Partslist	10-11



HANDLING CHIP COMPONENTS

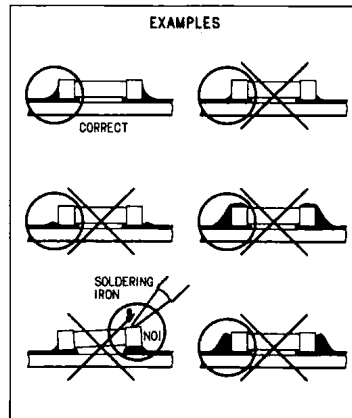
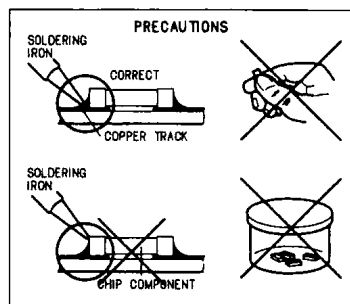
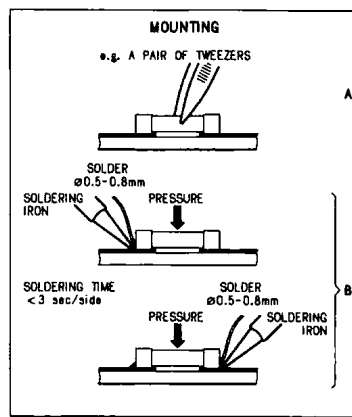
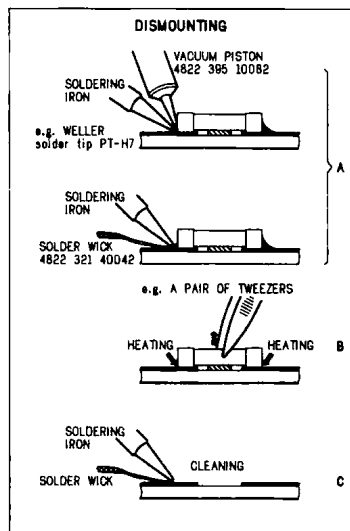
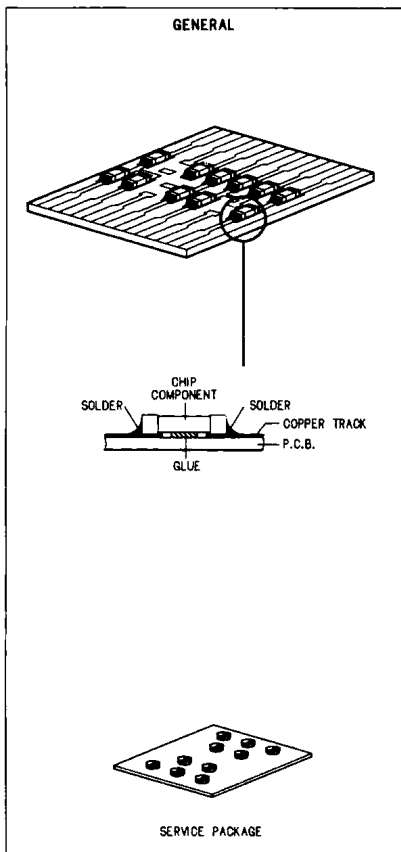

GB WARNING

All ICs and many other semiconductors are susceptible to electrostatic discharges (ESD). Careless handling during repair can reduce life drastically.

When repairing, make sure that you are connected with the same potential as the mass of the set via a wrist wrap with resistance. Keep components and tools at this potential.

F ATTENTION

Tous les IC et beaucoup d'autres semi-conducteurs sont sensibles aux décharges statiques (ESD). Leur longévité pourrait être considérablement écourtée par le fait qu'aucune précaution n'est prise à leur manipulation.

Lors de réparations, s'assurer de bien être relié au même potentiel que la masse de l'appareil et enfilez le bracelet sorti d'une résistance de sécurité.

Veiller à ce que les composants ainsi que les outils que l'on utilise soient également à ce potentiel.

Anti-static table mat large 1200x650x1.25mm
small 600x650x1.25mm

Anti-static wrist band
Connection box (1MΩ)
Extendible cable (to connect wrist band to conn. box)
Connecting cable (to connect table mat to conn. box)
Earth cable (to connect any product to mat or box)
Complete kit ESD3 (combining all above products)
Wristband tester

D WARNUNG

Alle ICs und viele andere Halbleiter sind empfindlich gegenüber elektrostatischen Entladungen (ESD). Unvorsichtige Behandlung im Reparaturfall kann die Lebensdauer drastisch reduzieren.

Sorgen Sie dafür, daß sie im Reparaturfall über ein Pulsarmband mit Widerstand mit dem Massepotential des Gerätes verbunden sind.

Halten Sie Bauteile und Hilfsmittel ebenfalls auf diesem Potential.

4822 466 10953
4822 466 10958
4822 395 10223
4822 320 11307
4822 320 11305
4822 320 11306
4822 320 11308
4822 310 10671
4822 344 13999

GB

Safety regulations require that the set be restored to its original condition and that parts which are identical with those specified be used.

Safety components are marked by those symbol. ⚠

S Varning !

Osynlig laserstrålning när apparaten är öppnad och spärren är urkopplad. Betrakta ej strålen.

DK Advarsel !

Usynlig laserstrålning ved åbning når sikkerhedsafbrydere er ude af funktion. Undgå udsættelse for stråling.

SF Varoitus !

Avatussa laitteessa ja suojalukituksen ohitettaessa olet alttiina näkymättömälle laserisäteilylle. Älä katso säteeseen!

ESD



NL WAARSCHUWING

Alle IC's en vele andere halfgeleiders zijn gevoelig voor electrostatische ontladingen (ESD).

Onzorgvuldig behandelen tijdens reparatie kan de levensduur drastisch doen verminderen. Zorg ervoor dat u tijdens reparatie via een polsband met weerstand verbonden bent met hetzelfde potentiaal als de massa van het apparaat.

Houd componenten en hulpmiddelen ook op ditzelfde potentiaal.

I AVVERTIMENTO

Tutti IC e parecchi semi-conduttori sono sensibili alle scariche statiche (ESD).

La loro longevità potrebbe essere fortemente ridotta in caso di non osservazione della più grande cautela alla loro manipolazione. Durante le riparazioni occorre quindi essere collegato allo stesso potenziale che quello della massa dell'apparecchio tramite un braccialetto a resistenza.

Assicurarsi che i componenti e anche gli utensili con quali si lavora siano anche a questo potenziale.

GB WARNING

Safety regulations require that the set be restored to its original condition and that parts which are identical with those specified be used.

F ATTENTION

Les normes de sécurité exigent que l'appareil soit remis à l'état d'origine et que soient utilisées les pièces de rechange identiques à celles spécifiées.

D WARNUNG

Bei jeder Reparatur sind die geltenden Sicherheitsvorschriften zu beachten. Der Originalzustand des Gerätes darf nicht verändert werden. Für Reparaturen sind Original-Ersatzteile zu verwenden.

NL WAARSCHUWING

Veiligheidsbepalingen vereisen, dat het apparaat in zijn oorspronkelijke toestand wordt teruggebracht en dat onderdelen, identiek aan de gespecificeerde, worden toegepast.

I AVVERTIMENTO

Le norme di sicurezza estigono che l'apparecchio venga rimesso nelle condizioni originali e che siano utilizzati i pezzi di ricambio identici a quelli specificati.

TOP AND FRONT PANEL

General

- 1 **POWER** - for switching the radio on and off
- 2 **LOCK** - for locking all controls apart from POWER off and the REPEAT ALARM controls
- 3 - to switch the display light on and off
- 4 **DISPLAY** - provides information about the functioning of the world receiver
- 5 **ENTER** - to confirm an entry
- 6 **0-9** - for numeric entries
 - frequencies and meter bands
 - time settings
 - stored stations positions
- 7 **.** - decimal point
 - to clear incorrect numeric entries
- 8 **RESET** - to clear all stored data, and to start up the set again

Clock functions

- 9 **REPEAT ALARM** - to switch off the wake up call temporarily or for 24 hours during the alarm call.
- 10 **ALARM FUNCTIONS**
 - **ALARM TIME**
 - to set the alarm time
 - to check the set alarm time when the radio is on
 - **DUAL TIME**
 - to set/review the two different clock times
 - to select the time display for time 1 or DUAL TIME (time 2)

- **RADIO/BUZZ** - to activate/deactivate the different alarm modes:
 - : wake up with radio
 - : wake up with buzz sound signal
 - (no symbol): alarm deactivated
- **SLEEP** - for switching on the sleep function and setting the sleep time

Radio

- 11 **RADIO FUNCTIONS**
 - **PRESET** - to search and select stored radio stations
 - **PROGRAM** - to store up to 40 radio stations in the memory
 - **STEP** - to select the tuning steps:
 - MW - 1 kHz or 9 kHz
 - SW - 1 kHz or 5 kHz
 - LW - 1 kHz or 9 kHz

MW-SW-LW

- to select MW, SW or LW bands
- to clear incorrect numeric entries
- **TUNING +/-** - to manually tune up or down
- **SCAN** - for automatic tuning to stations of higher/lower frequencies
- **FM**
 - to select the FM band
 - to clear incorrect numeric entries
- **FREE PRESET**
 - to show free memory positions for radio stations
 - to clear an occupied memory position
- **ENTER** - to enter frequencies/meter bands

- 12 **Telescopic aerial** - to improve FM and SW reception

SIDE PANELS

- 13 **9V DC IN**, - socket for 9 volt mains adaptor
- 14 - 3.5 mm headphone socket
(The speakers are automatically muted when the headphones are inserted.)
- 15 **MONO/STEREO** - to select FM reception in mono/stereo sound .
Note: The sound heard in speaker mode will always be MONO. Selection of FM STEREO sound can be heard when using headphones
- 16 **VOLUME** - to adjust the level of sound
- 17 **TONE** - to select **HIGH** (treble)/**LOW** (bass) tones

BACK PANEL

- 18 **STAND** - to support the set in tilted position (with illustration of the time zones to help set dual time clock setting)

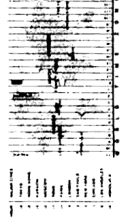
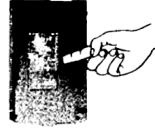

- 19 **Battery compartment**

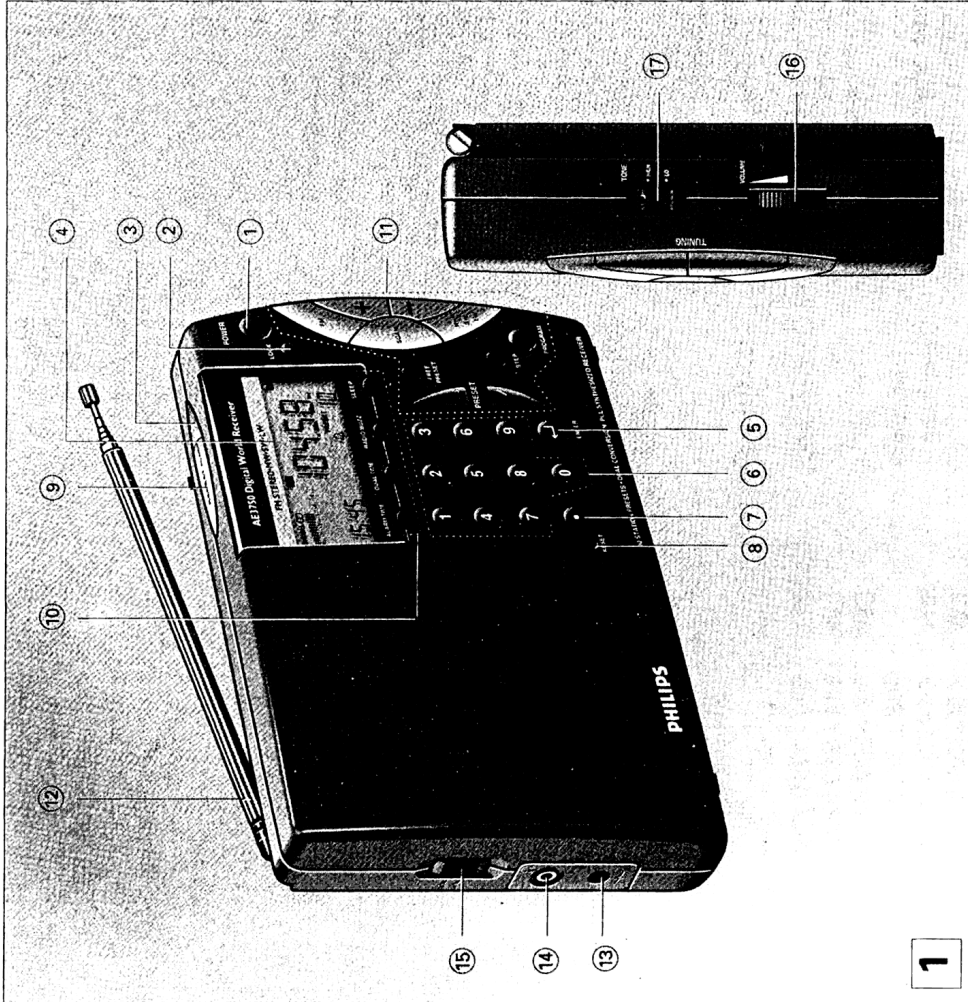

1

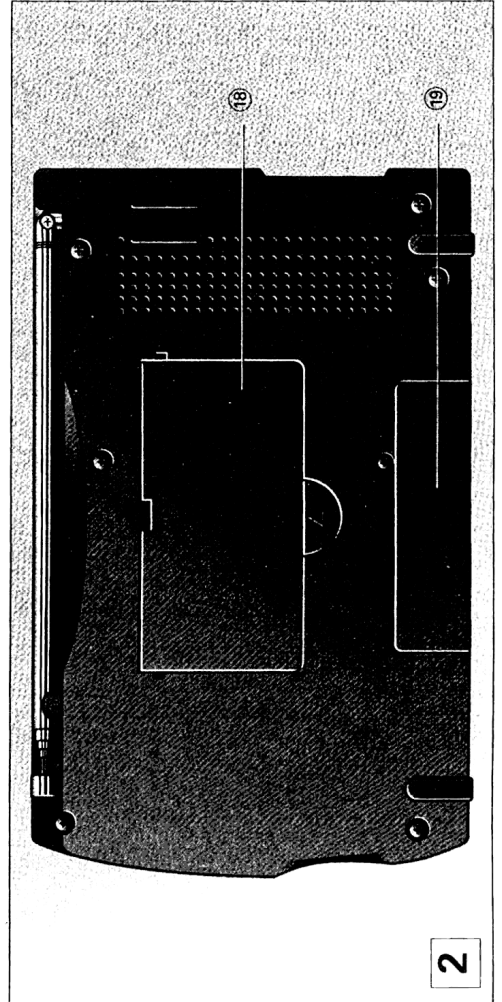

2

MAINS ADAPTOR (not included)

You can connect the set to the MAINS, using a mains adaptor.

- Make sure that the local voltage corresponds to the voltage of the 9V adaptor.

Important!

- The 2.1 mm centre pin of the 5.5 mm adaptor plug must be set to the minus pole ⊖, as indicated under the 9V DC IN socket ⊕-⊖.
- Connect the mains adaptor to the 9V DC socket of the set and plug the mains adaptor into the wall socket. The battery supply will now be disconnected.
- Always disconnect the mains adaptor if you are not using it.

Note: Remove the batteries if you intend to operate the set permanently on the mains supply.

BATTERIES (not included)

- Open and lift up the battery door and insert as indicated six 1.5 volt batteries (preferably alkaline), type R6, UM 3 or AA. Make sure the battery polarity is correct.
- Remove the batteries from the set if they are exhausted or not to be used for a long time.
- When the batteries are running low, the radio will start flashing on the display. If the radio is on, it will automatically switch off.
- Do not dispose of exhausted batteries with your household waste. Please inquire about how to dispose of batteries according to local regulations.



GENERAL FEATURES

Reset hole

Should you receive external interference e.g. static electricity from carpets, which affects the display and electronic functions of your set, the RESET hole allows you to clear all data from the set and to start up again.

- Use a bent-up paper clip to press RESET.

Lock

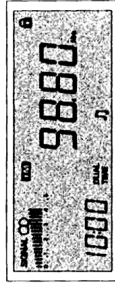

The LOCK button helps to prevent any of the front panel controls from accidentally being pressed when you are using the set (POWER ON) or in POWER OFF position.

1. If you wish to lock the functions of your set, press the LOCK button.
 -  appears on the display when LOCK is activated.



2. To deactivate the LOCK function, press LOCK again.
 -  disappears from the display.

Display light

1. Press  on the top panel.
 - The display will light up for about 10 seconds.
2. If you wish to switch off the light within 10 seconds, press  again.
3. If you wish to extend the lighting time, press any other control on the set.

MEMORY PROTECTION

The memory protection acts as a backup, should there be a power failure or interruption. When changing batteries or the power supply, the time settings, the stored radio stations and the last station listened to remain in the memory for approximately 30 minutes.

ACCESSORIES (included)

- SW compact wire in winder for improving SW radio reception.



To set and safeguard the MW waveband tuning step: selecting 9 kHz or 10 kHz

1. With the POWER off, press MW-SW-LW.
2. Press STEP until the desired tuning step is shown.
 - The selected step will be shown on the display for 5 seconds.

Note: 10 kHz – in general use in North and South America
9 kHz – in general use in all other countries

Tuning to a station

There are three possibilities for tuning in to a radio station:

- **Automatically** - the stations are sought automatically
- **Manually** - for more gradual tuning control or if the frequency of the station is already known.
- **Direct frequency entry** - the frequency of the station you wish to tune to must be known from e.g. station tables or your TV/radio guide.

The display indicates the frequency tuned to:

- FM in MHz
- MW in kHz
- SW in kHz and meters
- LW in kHz

Automatic tuning

- Press SCAN: if you press SCAN briefly the higher frequencies will be searched. If you press for more than 1 second, the lower frequencies will be searched.

– Tuning stops when a strong signal has been found.

– The display

shows the

strength of the

signal by the

SIGNAL gradient,

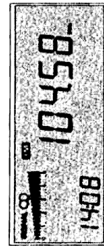

shown as a 'bar code' scale from 0 (weak) to 5 (optimum reception).



Note:

- During SCAN tuning, if a lower tuning step has been selected, the set automatically switches to the higher tuning step, with the exception of SW. The selected tuning steps, however, are unaffected using manual tuning.
- To safeguard the MW band tuning step, 9 kHz or 10 kHz from accidentally switching during scanning, see 'To set and safeguard the MW waveband'.

RADIO RECEPTION

1. Press the POWER button to switch on the radio.
2. You may connect headphones to the  socket.
3. To select the waveband, press FM or MW-SW-LW.
 - The wavebands located on MW-SW-LW are ordered in the following sequence: MW-SW-LW.
 - Press the MW-SW-LW button once or more until the desired waveband appears on the display.
 - For FM, further set and select the FM MONO/STEREO setting.
 - The STEREO setting is indicated by  in the display.
4. Select a station either **automatically**, **manually** or by **direct frequency entry** (see 'Tuning').

TUNING

Choosing the tuning step

During tuning, the radio frequency in the display can be changed in steps of 1, 5, 9 or 10 according to the waveband and tuning step selected. The tuning steps are used to help you pick up the maximum number of stations for the MW-SW-LW wavebands only and can be adjusted with the STEP button:

MW - 1 kHz or 9 kHz; 1 kHz or 10 kHz.

SW - 1 kHz or 5 kHz;

LW - 1 kHz or 9 kHz;

1. With POWER on, press the MW-SW-LW button to select the waveband.

2. Press STEP repeatedly until the desired tuning step is shown.

Manual tuning

1. Keep TUNING +/- (up or down) pressed. This enables you to search at high speed.
2. Release TUNING +/- when you approach the desired frequency.
3. Press TUNING +/- as often as required to reach the desired frequency.

Direct frequency entry

1. Type in the numbers of the desired frequency or meter band.

Note: For FM (MHz) stations, you must enter the decimal point, even if no further figures follow. Without the decimal point, the entry is interpreted as a kHz entry.

- If you have made an incorrect entry, **Error** will appear on the display. You can clear the entry by either pressing the MW-SW-LW or FM controls or by pressing decimal point \bullet twice.
2. Press ENTER \blacktriangledown to confirm the entry.

Improving radio reception

The radio station reception is indicated by the SIGNAL gradient, showing a scale from 0 (weak) to 5 (optimum reception).

To improve radio reception:

- For **FM**, pull out the telescopic aerial. Incline and turn the aerial. Reduce its length if the signal is too strong (very close to a transmitter). If the FM stereo signal is weak and distorted, set MONO/STEREO to the MONO position. The programmes will now be in mono sound but the noise distortion will be suppressed.



- For **MW/LW**, the set is provided with a built-in aerial, so the telescopic aerial is not needed. Direct the aerial by turning the whole set.



- For **SW**, pull out the telescopic aerial and place in vertical position. Vary the length of the aerial to improve reception. If SW reception still needs to be improved, use the **SW compact wire**:

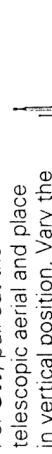

- a. Extend the wire, lightly pressing the centre of the wire winder.
- b. Gently push the clip of the SW wire onto the telescopic aerial. Use the other clip (attached to the cord) to mount the compact winder to e.g. a curtain near a window, to obtain optimum reception.
- c. After use, wind the wire in the direction as shown on the winder.

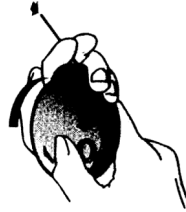
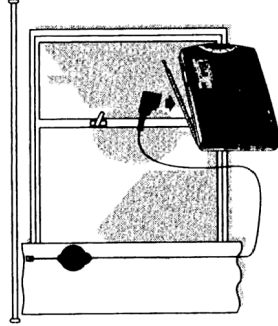

PROGRAMMING PRESET STATIONS

You can store the frequencies/meter bands of up to 40 radio stations in the memory.

1. Select a waveband and tune to the desired radio station.
 2. Type in a number (1-40) to choose a preset position.
 3. Press PROGRAM (within 5 seconds) to store the selected radio station.
 - If the selected preset position is already occupied, the preset frequency or station will flash briefly on the display.
 - If you wish to overwrite the current preset, press PROGRAM (within 5 seconds) a second time. Your new selection will now replace the previously stored station.
- Repeat steps 1-3 to store all preset stations in this way.

Calling up a preset station

1. Type in the number of the preset position.
2. Press the PRESET Δ/∇ button briefly.
 - If occupied, the set will automatically tune to the selected preset position.
 - If, however, the preset position is free, the display will only show **PRESET**, the preset position and **FREE** for 5 seconds.

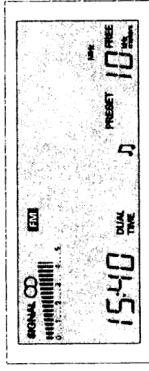

Searching or reviewing preset positions

1. Keep PRESET Δ or ∇ pressed until the preset number starts to flash on the display.
 - Each preset station will be heard for 5 seconds.
2. At the desired preset, press either PRESET Δ or ∇ and the set will now be tuned to the selected preset station.

Checking stations stored

1. If you wish to check whether a station has already been stored on one of the preset positions, tune to the desired radio station.
2. Keep PROGRAM pressed.
 - **PRESET** appears on the display. If the station is already stored, the preset position number will appear next to PRESET.
 - If the radio station is not stored, no preset position will be shown and **PRESET** will disappear from the display.

Checking free preset positions

The **FREE PRESET** button can be used to check the availability of free preset positions.

1. Press **FREE PRESET** once.
 - **PRESET**, the first free preset number and **FREE** appears on the display.
2. Press **FREE PRESET** repeatedly to view other free preset positions.

Clearing a preset position

1. To clear an occupied preset position, type in the preset number, using the numeric buttons.
 - The frequency located on the selected preset position will start flashing on the display.
2. Press **FREE PRESET**.
 - The frequency located on the selected preset position will start flashing on the display.
3. Press the **FREE PRESET** button (within 5 seconds) a second time to clear the preset position.



ALARM FUNCTION

General

You can use the world receiver as an alarm clock. To use this function, you first have to set the alarm time. You can set the alarm for time 1 and for DUAL TIME (time 2), provided that you press DUAL TIME to switch between the two times.

1. Press the DUAL TIME button to select time 1 or DUAL TIME.
2. To set the time, type in the alarm time, using the numeric buttons (0-9) and the decimal point •.
3. Press the ALARM TIME button to confirm the alarm time setting.
4. To select the alarm mode you wish to be awoken by, press RADIO/BUZZ until the desired mode appears on the display.

RADIO Δ

- If you have selected the radio mode, the alarm sound will be the last radio station tuned to.
- The alarm will automatically switch off after one hour.

Note: Make sure you adjust the volume loud enough to wake you.

BUZZ Δ

- The buzz signal is set at a certain level, which cannot be adjusted.
- If the radio is on, it will be muted just before the buzz signal will sound.
- The buzz signal is automatically switched off after 5 minutes.

SWITCHING OFF THE ALARM

During the alarm signal, you can switch off the alarm for either the radio or buzz in a number of ways:

- 5 **minute REPEAT ALARM**
 - Press the REPEAT ALARM button briefly.
 - The alarm signal stops and your selected alarm mode flashes on the display. The alarm will be repeated after five minutes.
 - Press REPEAT ALARM again during the next call if you wish to repeat the alarm call.
 - Repeat as often as desired.

24 hour alarm reset

- During the alarm signal, press the REPEAT ALARM control until the selected alarm mode stops flashing.
 - The set alarm is now switched off and reset to call again at the same time the next day.

SETTING THE TIME

Setting the clock

Your world receiver is equipped with a dual time clock. You can set a second time in addition to the current time. The second time is handy, if, for example, you want to know the time in another zone of the world. You can set the two different clock times with the POWER on or off.

Important: If you wish to set two different times, you need to complete the following steps within 5 seconds.

1. Press DUAL TIME once or more to select the first time, which is unmarked, or DUAL TIME (shown on the display).
2. To set the time, type in the time using the numeric buttons (0-9) and the decimal point to differentiate between the hours and the minutes.
3. Press the DUAL TIME button again to confirm the time setting.

Note: If you have made an incorrect entry, the display will show **Error**. You can clear the entry by pressing the MW-SW-LW or FM buttons or by pressing decimal point • twice.

Examples of possible clock time entries

6.30

Press 6 • 3, and DUAL TIME or press 6 • 3 • 0, and DUAL TIME

15.00

Press 1 • 5 • 0, and DUAL TIME or press 1 • 5 • 0 • 0, and DUAL TIME

Viewing the different times

- Press the DUAL TIME button to switch between the two clock time indications.
- Press again if you wish to return to the original time one or DUAL TIME display.

SPECIFICATIONS

GENERAL

Battery	: 9V (R6G x 6)
Current Consumption	: 50mA
Battery lifetime	: < 0.1mA (radio off)
	: > 8 hours
Output power (10% THD)	: > 180 days (clock back up)
Speaker impedance	: > 180mW
Headphone impedance	: 32 Ohm
Clock accuracy	: 2 x 32 Ohm
	: < 2 sec/day

TUNER - FM section

Tuning range	: 87.5 - 108 MHz
IF frequency	: 10.7 MHz
Sensitivity	: < 5 μ V at 26dB S/N
IF rejection	: > 50dB
Image rejection	: > 20dB
MPX separation	: > 23dB
S/N ratio	: > 48dB
Auto search stop sens.	: < 15 μ V

TUNER - AM section

Tuning range	MW/AM	: 520 - 1710 KHz
	LW	: 144 - 353 KHz
	SW	: 1.7 - 30MHz
IF frequency		: 468 \pm 3KHz
Sensitivity	MW	: < 1400 μ V/m at 26dB
	LW	: < 5000 μ V/m at 26dB
	SW	: 160 - 250 μ V
Selectivity	MW	: > 35dB
	LW	: > 35dB
	SW	: > 18dB
IF rejection	MW	: > 45dB
	LW	: > 45dB
	SW	: > 76dB
Image rejection	MW	: > 50dB
	LW	: > 50dB
	SW	: > 40 - 50dB

Canceling the alarm completely

- Before the set alarm time or during the alarm goes off, press the RADIO/BUZZ button until both the Δ and the Δ symbols and the set alarm time no longer show on the display. Δ now appears on the display.

Note: The alarm time remains stored in the memory and can be reactivated by pressing the RADIO/BUZZ button.

SLEEP FUNCTION

Your world receiver is equipped with a sleep function. This function enables you to listen to the radio while you fall asleep. After a specified period of time (60 minutes maximum) the radio will be switched off automatically.

Setting and switching on the sleep function

1. In the POWER on or off position, press SLEEP.
 - The radio will switch on, and the number 60 appears under SLEEP in the display.

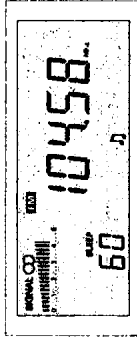

2. Set the sleep time by pressing the SLEEP button. Each time you press SLEEP the length of time will change in steps of 10 minutes.

60>50>40>30>20>10>radio off>60>50...







3. To check the remaining minutes of the sleep time during the sleep function, press SLEEP.
 - The remaining sleep time appears briefly in the display.

Switching off the sleep function

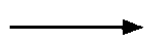
The sleep function can be switched off before the set time has elapsed:

- Press the REPEAT ALARM control or the POWER button.
 - The set is now switched off.

RADIO ALIGNMENT

							
AM IF							
1st AM IF	55.850MHz	TP1	T5,T6 T4	TP10		max.	
2nd AM IF	455KHz	TP5	T8,T11	TP7		max.	
AM OSC							
1st AM OSC	LW 144KHz		L13	TP4		1.45V+/-0.15V 8.5V+/-0.3V	
	SW 30MHz						
2nd AM OSC	MW 1000KHz	TP1	T7	TP6		455KHz	
	MW 1001KHz		SFR1				
FM IF							
FM #	10.7MHz	TP3	T3, T9, T10	TP8		symm. max. lin.	
FM RF							
FM #	87.5MHz		L11	TP4		2.6+/-0.15V 8+/-0.3V	
	108MHz						
	88MHz	TP1	L10	TP10		max.	
	106MHz		TC1				
FM MPX							
FM #	98MHz		SFR2	TP9		76+/-0.05KHz	
PLL REF.							
PLL	SW 30MHz		TC3	TP2		85.85+/-0.00005MHz	

* Mod. 1KHz 30%
10nF + 15E

Repeat

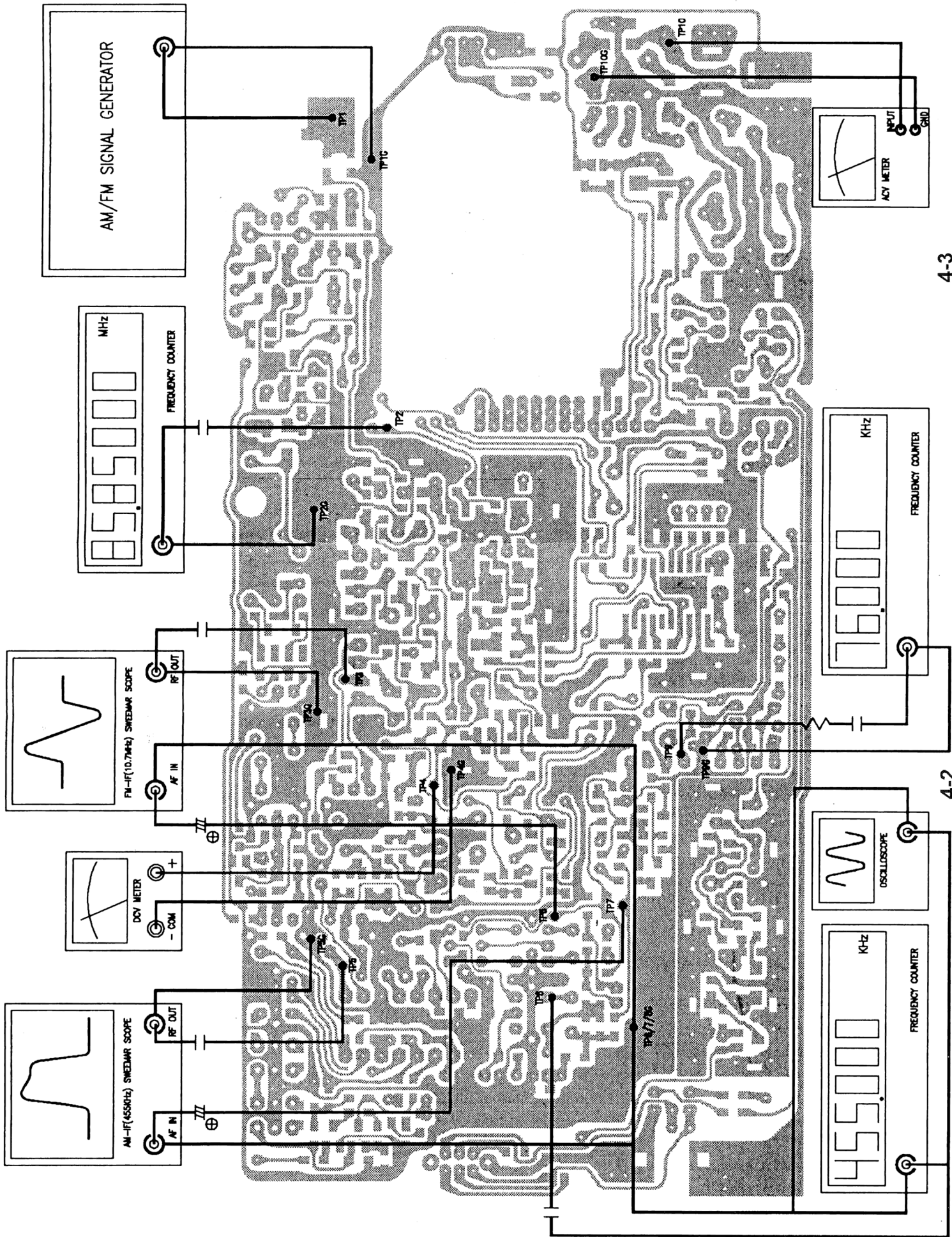

MAIN BOARD - LAYOUT DIAGRAM (TOP)

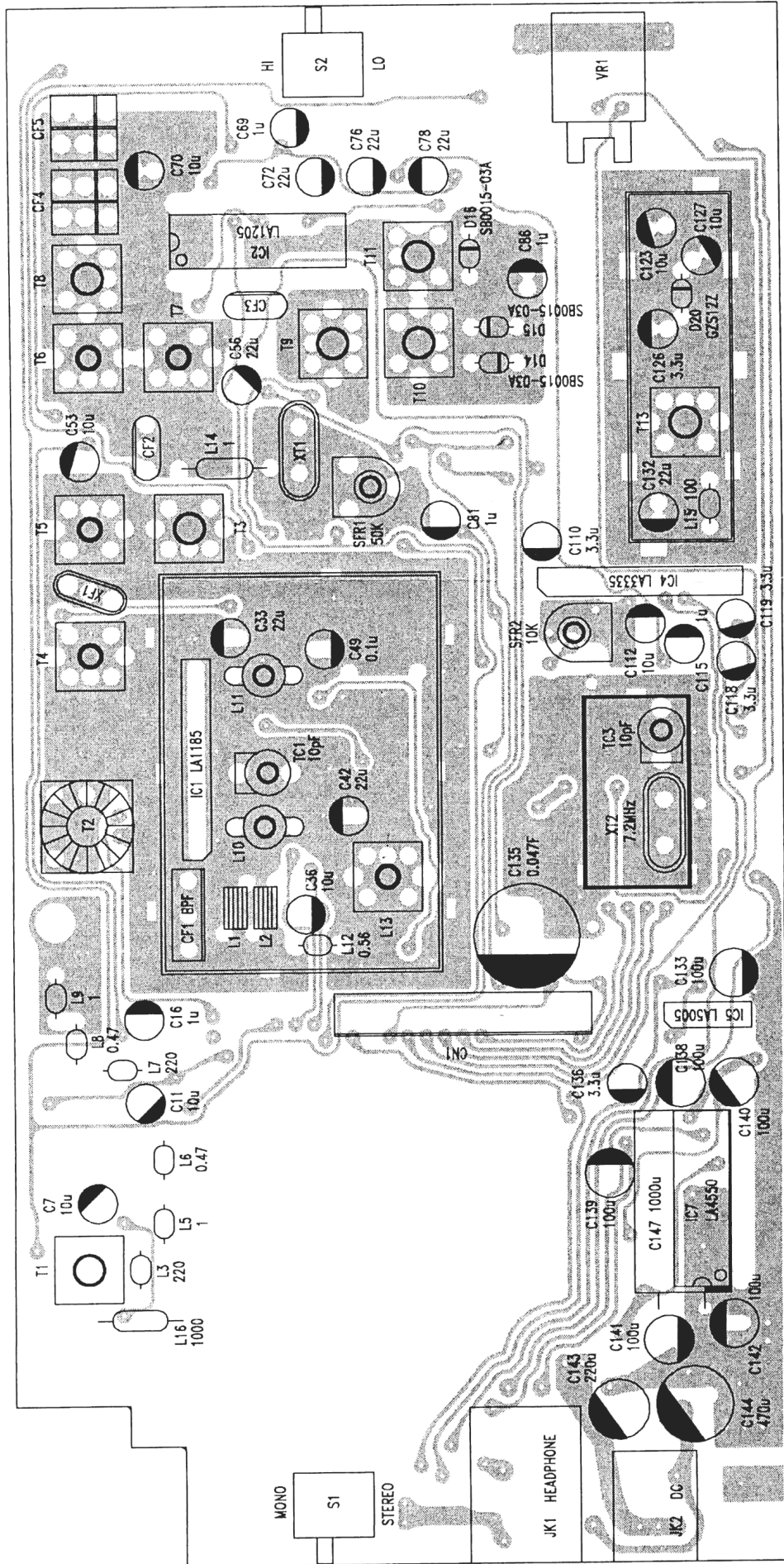

MAIN BOARD - LAYOUT DIAGRAM (BOTTOM)

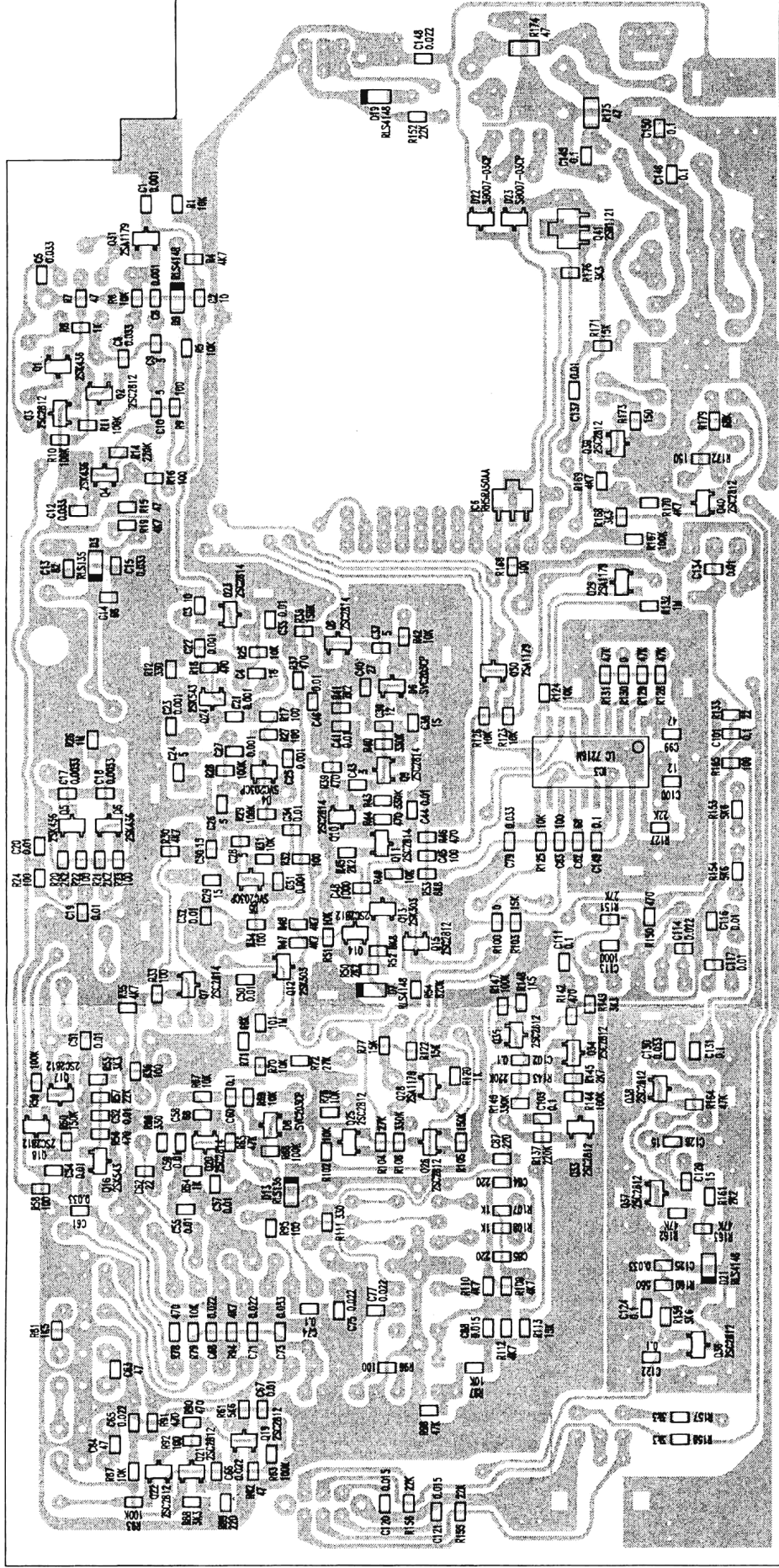

MAIN BOARD - CIRCUIT DIAGRAM

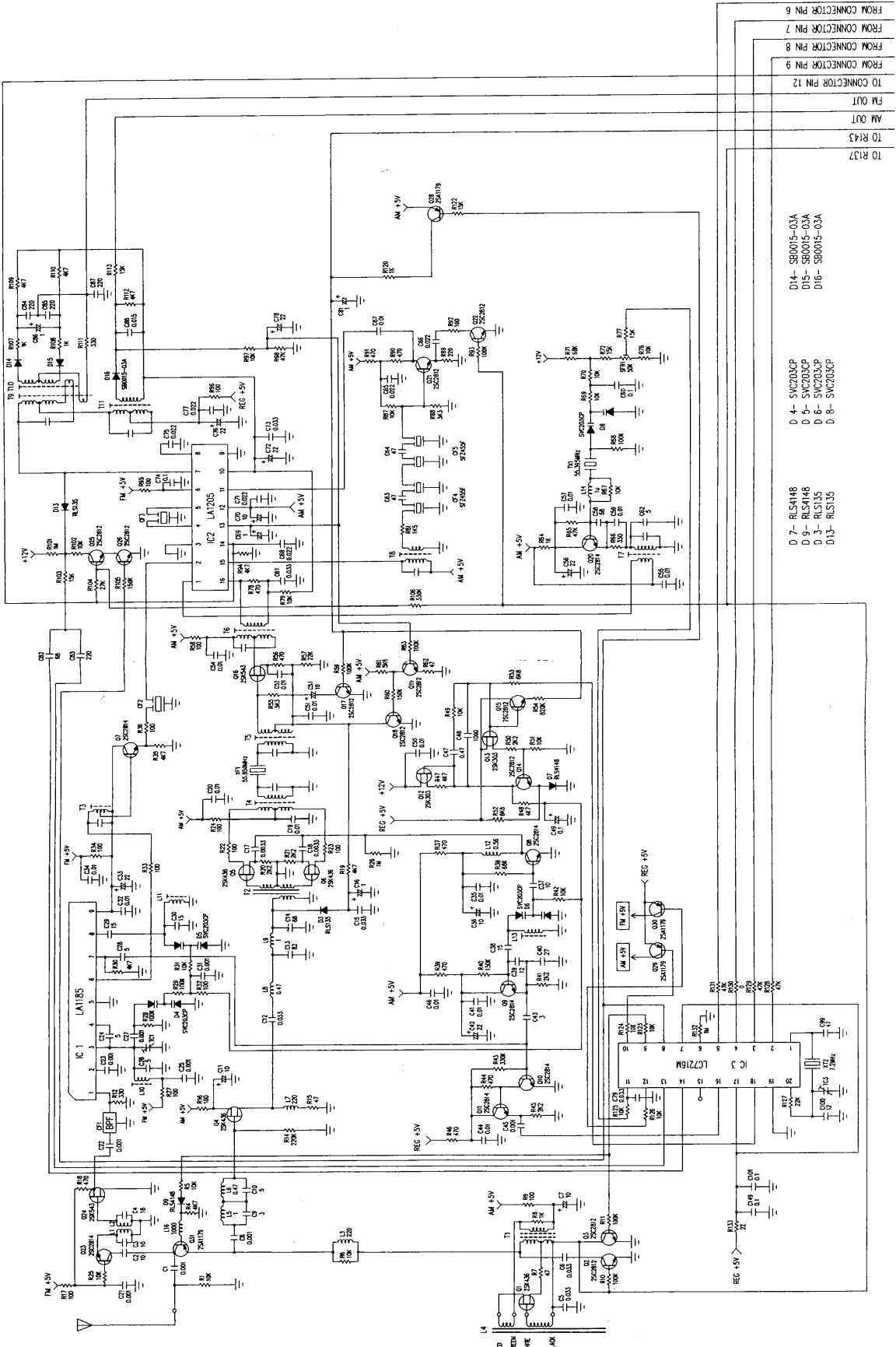

- TO R137
 - TO R143
 - AM OUT
 - FM OUT
 - TO CONNECTOR PIN 12
 - FROM CONNECTOR PIN 8
 - FROM CONNECTOR PIN 7
 - FROM CONNECTOR PIN 6
-
- D 4- SVC203CP
 - D 5- SVC203CP
 - D 6- SVC203P
 - D 8- SVC203CP
-
- D 7- RLS4H8
 - D 9- RLS4H8
 - D 3- RLS135
 - D 13- RLS135
-
- D14- SR0015-03A
 - D15- SR0015-03A
 - D16- SR0015-03A

CONTROL BOARD - LAYOUT DIAGRAM (TOP)

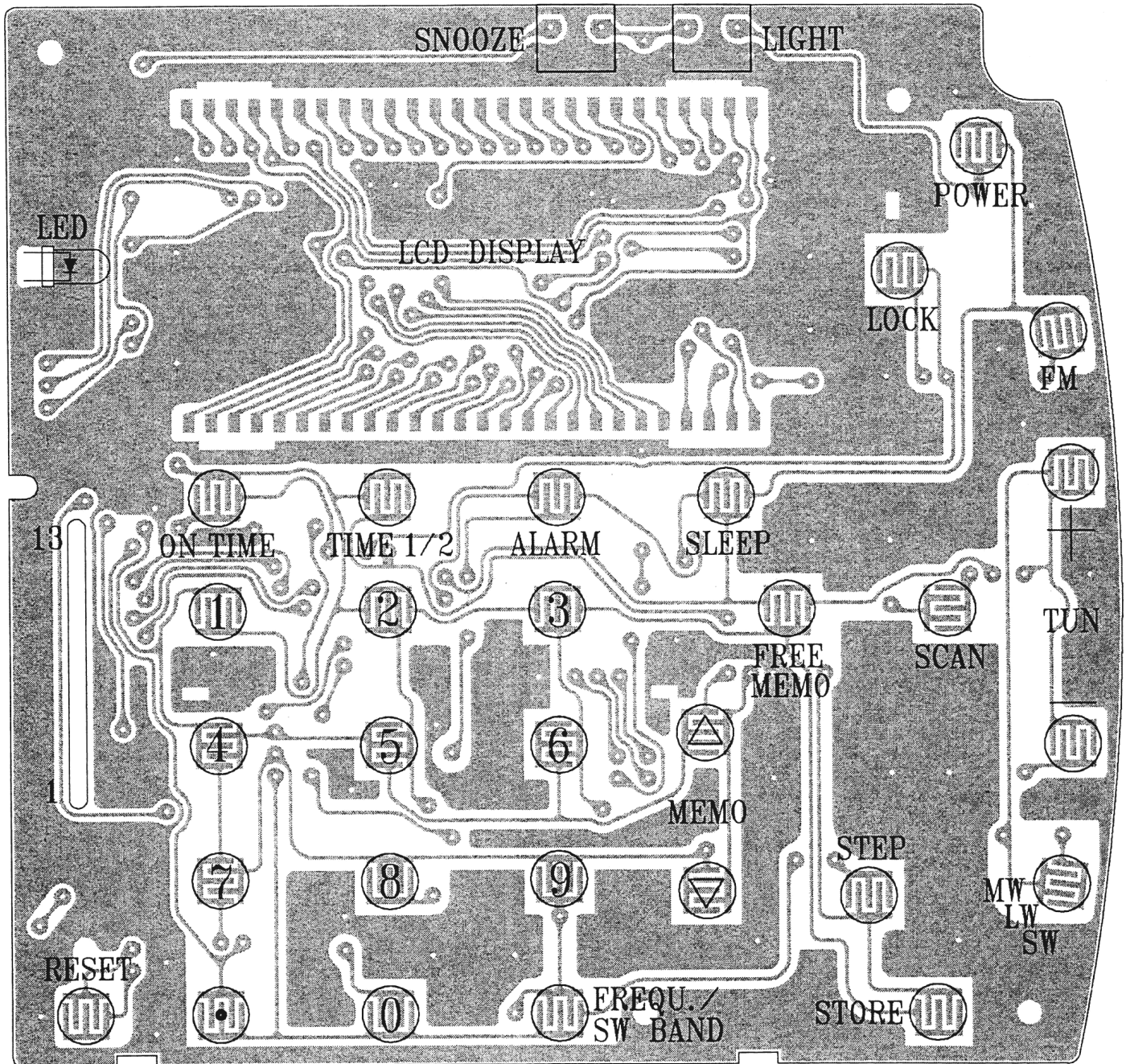

CONTROL BOARD - LAYOUT DIAGRAM (BOTTOM)

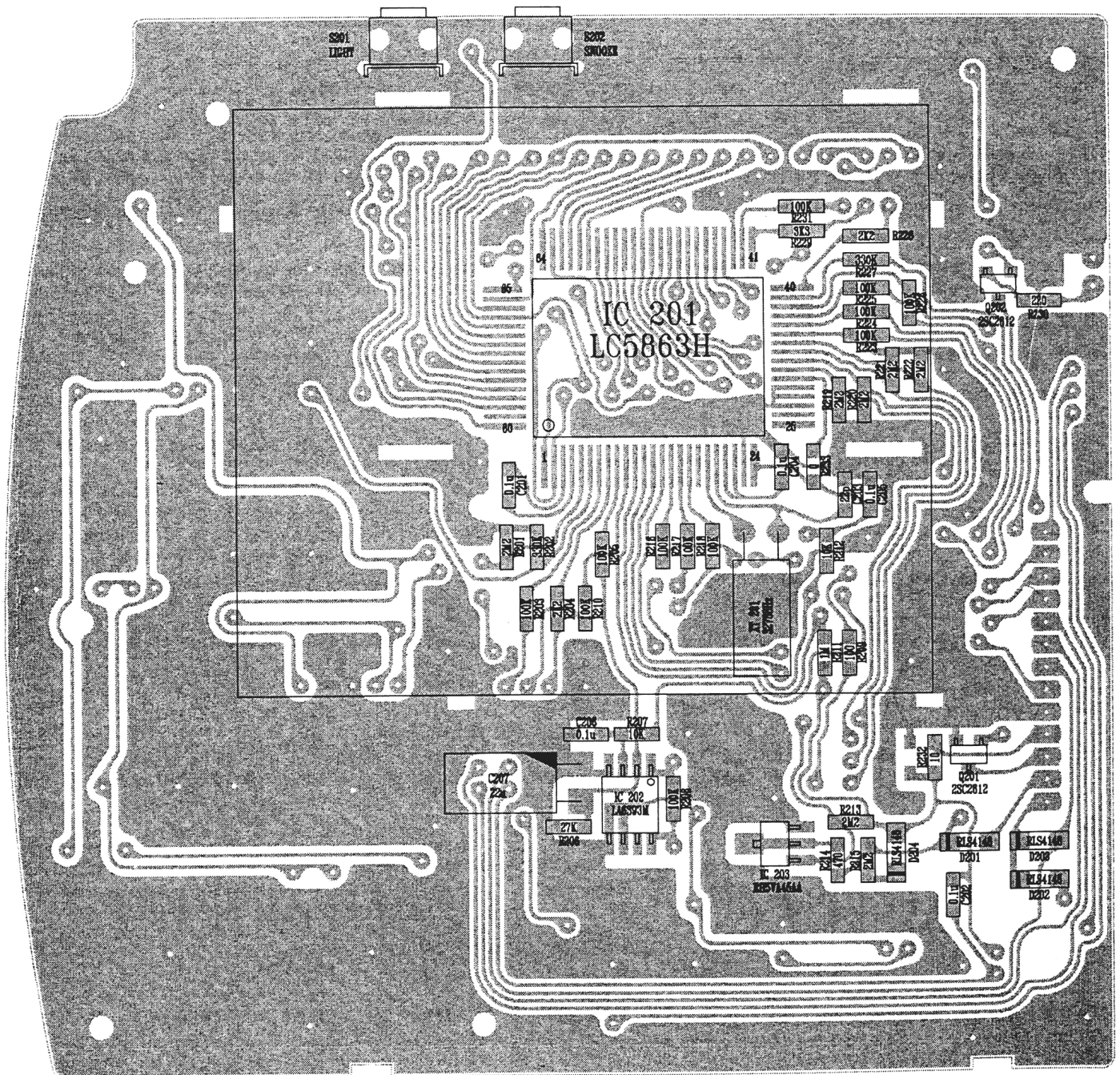

CONTROL BOARD - CIRCUIT DIAGRAM

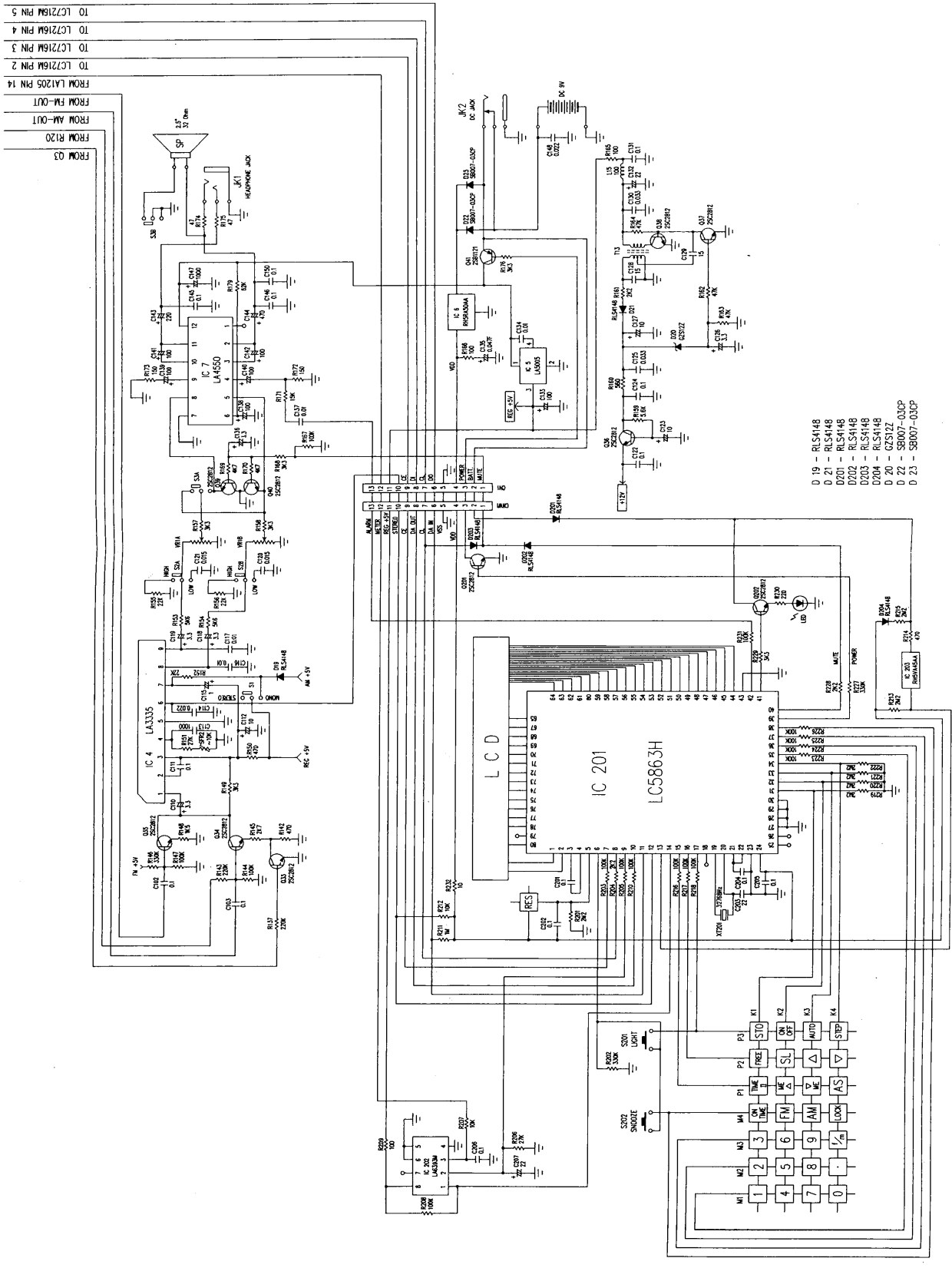

- D 19 - RLS4148
- D 21 - RLS4148
- D201 - RLS4148
- D202 - RLS4148
- D203 - RLS4148
- D204 - RLS4148
- D 20 - GZ512Z
- D 22 - SB007-03CP
- D 23 - SB007-03CP

FROM R120
FROM FM-OUT
FROM FM-OUT
FROM LA1205 PIN 14
TO LC7216M PIN 2
TO LC7216M PIN 3
TO LC7216M PIN 4
TO LC7216M PIN 5

MECHANICAL PARTSLIST

1	4822 459 04412	Front Cabinet	41	4822 492 11351	Battery Spring (+-)
2	4822 426 10333	Rear Cover	46	4822 410 10897	Button Cluster
4	4822 410 10899	Key Pad	47	4822 410 10893	Tuning Knob
8	4822 442 00673	Battery Cover	48	4822 410 10896	Power Knob
10	4822 410 10894	Tone Knob	49	4822 410 10895	FM Mode Knob
11	4822 410 10891	Volume Knob		4822 303 14037	Compact Antenna
12	4822 404 10917	Support		4822 736 14799	Instruction Manual
15	4822 463 11122	Rod Ant Slider			
18	4822 450 10236	LCD Window			
25	4822 410 10898	Key Pad Rubber			
26	4822 265 10807	LCD Connector			
27	4822 410 10892	Snooze Button			
36	4822 492 11352	Rod Ant Contact			
38	4822 303 14036	Rod Antenna			
40	4822 492 11349	Battery Spring (-)			

Note : Only those parts mentioned in the list are normal service parts.

EXPLODED VIEW DIAGRAM

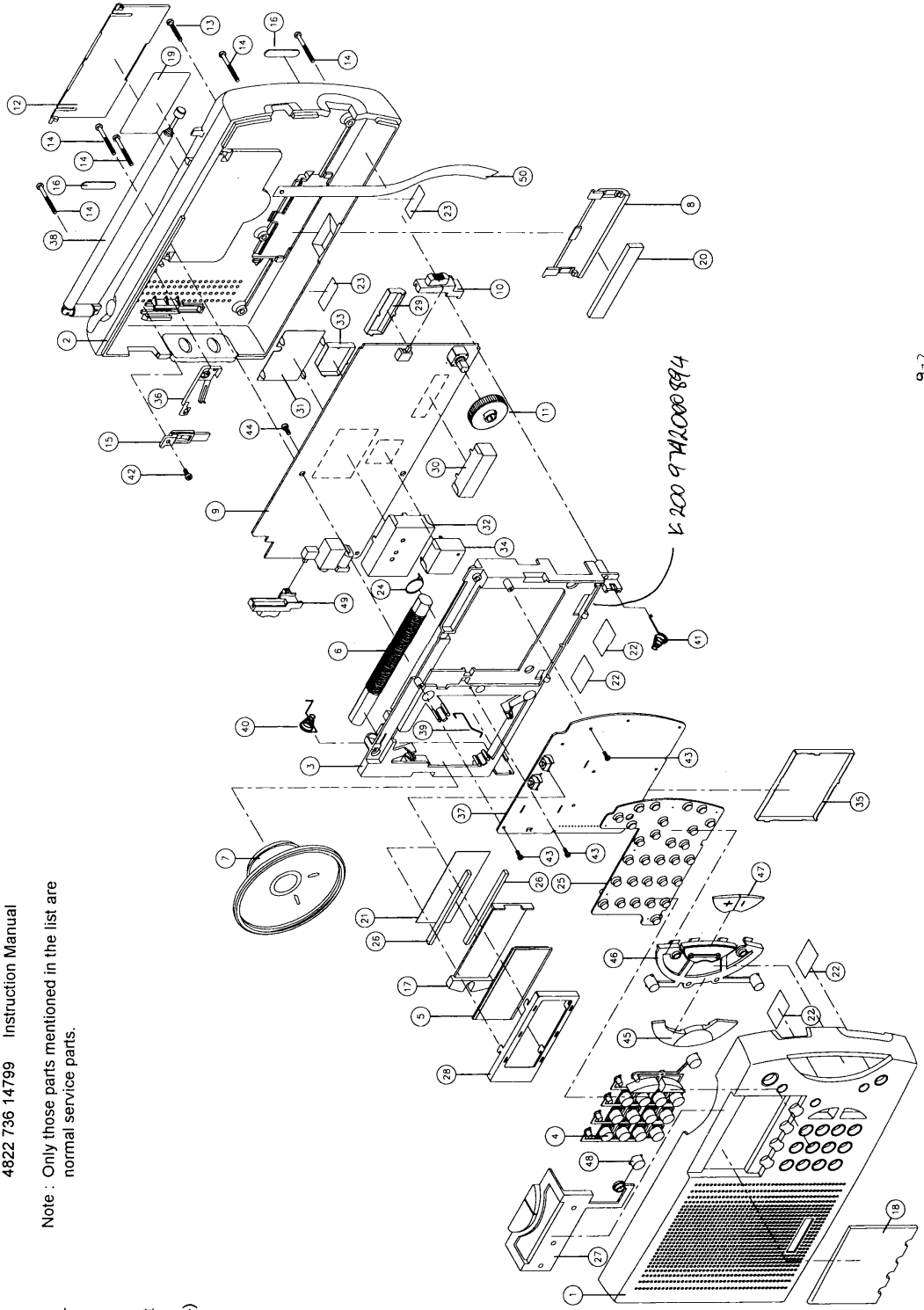

ELECTRICAL PARTSLIST

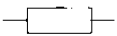

SFR1	4822 101 11703	Semi-fixed VR 50KB
SFR2	4822 101 11702	Semi-fixed VR 10KB
VR1A/B	4822 101 11704	Rotary VR 50KAX2



C135	4822 123 14017	Sup Cap 0.047F 5.5V
TC1	4822 125 11092	Trimmer Cap 10pF
TC2	4822 125 11092	Trimmer Cap 10pF

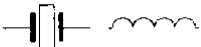

CF1	4822 242 10631	Filter BPMB-6A
CF2	4822 242 82165	Filter SK107M2-AO
CF3	4822 242 82165	Filter SK107M2-AO
CF4	4822 242 10632	Filter SFZ455F
CF5	4822 242 10632	Filter SFZ455F
L3	4822 157 11093	Fixed Coil 220μH
L4	4822 157 11094	Bar Ant Coil
L5	4822 157 11095	Fixed Coil 1μH
L6	4822 157 11096	Fixed Coil 47μH
L7	4822 157 11093	Fixed Coil 220μH
L8	4822 157 11096	Fixed Coil 47μH
L9	4822 157 11095	Fixed Coil 1μH
L10	4822 157 11097	FM RF Coil
L11	4822 157 11098	FM Osc Coil
L12	4822 157 11099	Fixed Coil 56μH
L13	4822 157 11101	AM VCO Coil
L14	4822 157 11102	Fixed Coil 1μH
L15	4822 157 11103	Fixed Coil 100μH
L16	4822 157 11104	Fixed Coil 1mH
T1	4822 157 11105	LW/FM RF Coil
T2	4822 157 11106	Toroidal Trans Coil
T3	4822 157 71759	FM IFT
T4	4822 157 11107	AM (1) IFT
T5	4822 157 11107	AM (1) IFT
T6	4822 157 11108	AM (1) IFT
T7	4822 157 11109	AM (1) Osc Coil
T8	4822 157 11111	AM (2) IFT
T9	4822 157 11112	FM DET Coil (A)
T10	4822 157 11113	FM DET Coil (B)
T11	4822 157 11114	AM DET Coil

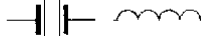

T13	4822 157 11115	DC-DC Conv Coil
XF1	4822 242 10633	Crystal DFM-558-20A10
XT1	4822 242 10627	Crystal 55.396MHz
XT2	4822 242 10628	Crystal 7.2MHz
XT201	4822 242 10629	Crystal 32.768KHz



D3	4822 130 10769	Diode RLS-135
D4	4822 130 82919	Diode VC SVC203CP
D5	4822 130 82919	Diode VC SVC203CP
D6	4822 130 82919	Diode VC SVC203CP
D7	4822 130 83991	Diode RLS-4148
D8	4822 130 82919	Diode VC SVC203CP
D9	4822 130 83991	Diode RLS-4148
D13	4822 130 10769	Diode RLS-135
D14	4822 130 10771	Diode SB0015-03A
D15	4822 130 10771	Diode SB0015-03A
D16	4822 130 10771	Diode SB0015-03A
D19	4822 130 83991	Diode RLS-4148
D20	4822 130 10772	Zener GZS12Z
D21	4822 130 83991	Diode RLS-4148
D22	4822 130 83992	Diode SB007-03CP
D23	4822 130 83992	Diode SB007-03CP
D201	4822 130 83991	Diode RLS-4148
D202	4822 130 83991	Diode RLS-4148
D203	4822 130 83991	Diode RLS-4148
D204	4822 130 83991	Diode RLS-4148
LED	4822 130 83993	LED LLP-204YGU-2



IC1	4822 209 71362	IC LA1185
IC2	4822 209 15149	IC LA1205
IC3	4822 209 15155	IC LC7216M-TP
IC4	4822 209 15151	IC LA3335
IC5	4822 209 15152	IC LA5005
IC6	4822 209 15159	IC RH5RA50AA
IC7	4822 209 15153	IC LA4550
IC201	4822 209 15156	IC LC5863-1C37
IC202	4822 209 15154	IC LA6393M-TP
IC203	4822 209 15157	IC RH5VA45AA

ELECTRICAL PARTSLIST

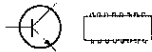

Q1	4822 130 10764	FET 2SK436A21
Q2	4822 130 10768	TR 2SC2812L7
Q3	4822 130 60753	TR 2SC2812L6
Q4	4822 130 10764	FET 2SK436A21
Q5	4822 130 10764	FET 2SK436A21
Q6	4822 130 10764	FET 2SK436A21
Q7	4822 130 63865	Trans 2SC2814F4
Q8	4822 130 63865	Trans 2SC2814F4
Q9	4822 130 63865	Trans 2SC2814F4
Q10	4822 130 63865	Trans 2SC2814F4
Q11	4822 130 63865	Trans 2SC2814F4
Q12	4822 130 10765	FET 2SK303V3
Q13	4822 130 10765	FET 2SK303V3
Q14	4822 130 60753	Trans 2SC2812L6
Q15	4822 130 60753	Trans 2SC2812L6
Q16	4822 130 10766	FET 2SK543CJ4
Q17	4822 130 10768	Trans 2SC2812L7
Q18	4822 130 60753	Trans 2SC2812L6
Q19	4822 130 60753	Trans 2SC2812L6
Q20	4822 130 63865	Trans 2SC2814F4
Q21	4822 130 60753	Trans 2SC2812L6
Q22	4822 130 10768	Trans 2SC2812L7
Q23	4822 130 63865	Trans 2SC2814F4
Q24	4822 130 10766	FET 2SK543CJ4
Q25	4822 130 60753	Trans 2SC2812L6
Q26	4822 130 60753	Trans 2SC2812L6
Q28	4822 130 63863	Trans 2SA1179M6
Q29	4822 130 10767	Trans 2SA1179M7
Q30	4822 130 10767	Trans 2SA1179M7
Q31	4822 130 10767	Trans 2SA1179M7
Q33	4822 130 60753	Trans 2SC2812L6
Q34	4822 130 60753	Trans 2SC2812L6
Q35	4822 130 60753	Trans 2SC2812L6
Q36	4822 130 60753	Trans 2SC2812L6
Q37	4822 130 60753	Trans 2SC2812L6
Q38	4822 130 60753	Trans 2SC2812L6
Q39	4822 130 10768	Trans 2SC2812L7
Q40	4822 130 10768	Trans 2SC2812L7
Q41	4822 130 10315	Trans 2SB1121T
Q201	4822 130 10768	Trans 2SC2812L7
Q202	4822 130 10768	Trans 2SC2812L7

- MISCELLANEOUS -

S1	4822 277 11658	Slide Switch
S2A/B	4822 277 11658	Slide Switch
S201	4822 276 13821	Tact Switch
S202	4822 276 13821	Tact Switch
SP	4822 240 10175	Speaker 2.5" 32 OHM
JK2	4822 267 31966	DC Jack
JK1	4822 267 31967	Headphone Jack
LCD	4822 135 00089	LCD AE-9648

Note : Only those parts mentioned in the list are normal service parts.

ELECTRIACL PARTSLIST

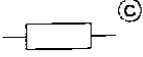

0R00	4822 051 20008
1R00	4822 051 20108
1R10	4822 051 20118
1R20	4822 051 20128
1R30	4822 051 20138
1R50	4822 051 20158
1R60	4822 051 20168
1R80	4822 051 20188
2R00	4822 051 20208
2R20	4822 051 20228
2R40	4822 051 20248
2R70	4822 051 20278
3R00	4822 051 20308
3R30	4822 051 20338
3R60	4822 051 20368
3R90	4822 051 20398
4R30	4822 051 20438
4R70	4822 051 20478
5R10	4822 051 20518
5R60	4822 051 20568
6R20	4822 051 20628
6R80	4822 051 20688
7R50	4822 051 20758
8R20	4822 051 20828
9R10	4822 051 20918
10R00	4822 051 20109
11R00	4822 051 20119
12R00	4822 051 20129
13R00	4822 051 20139
15R00	4822 051 20159
16R00	4822 051 20169
18R00	4822 051 20189
20R00	4822 051 20209
22R00	4822 051 20229
24R00	4822 051 20249
27R00	4822 051 20279
30R00	4822 051 20309
33R00	4822 051 20339
36R00	4822 051 20369
39R00	4822 051 20399
43R00	4822 051 20439
47R00	4822 051 20479
51R00	4822 051 20519
56R00	4822 051 20569
62R00	4822 051 20629

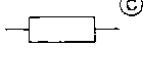

68R00	4822 051 20689
75R00	4822 051 20759
82R00	4822 051 20829
91R00	4822 051 20919
100R00	4822 051 20101
110R00	4822 051 20111
120R00	4822 051 20121
130R00	4822 051 20131
150R00	4822 051 20151
160R00	4822 051 20161
180R00	4822 051 20181
200R00	4822 051 20201
220R00	4822 051 20221
240R00	4822 051 20241
270R00	4822 051 20271
300R00	4822 051 20301
330R00	4822 051 20331
360R00	4822 051 20361
390R00	4822 051 20391
430R00	4822 051 20431
470R00	4822 051 20471
510R00	4822 051 20511
560R00	4822 051 20561
620R00	4822 051 20621
680R00	4822 051 20681
750R00	4822 051 20751
820R00	4822 051 20821
910R00	4822 051 20911
1K00	4822 051 20102
1K10	4822 051 20112
1K20	4822 051 20122
1K30	4822 051 20132
1K50	4822 051 20152
1K60	4822 051 20162
1K80	4822 051 20182
2K00	4822 051 20202
2K20	4822 051 20222
2K40	4822 051 20242
2K70	4822 051 20272
3K00	4822 051 20302
3K30	4822 051 20332
3K60	4822 051 20362
3K90	4822 051 20392
4K30	4822 051 20432
4K70	4822 051 20472



5K10	4822 051 20512
5K60	4822 051 20562
6K20	4822 051 20622
6K80	4822 051 20682
7K50	4822 051 20752
8K20	4822 051 20822
9K10	4822 051 20912
10K00	4822 051 20103
11K00	4822 051 20113
12K00	4822 051 20123
13K00	4822 051 20133
15K00	4822 051 20153
16K00	4822 051 20163
18K00	4822 051 20183
20K00	4822 051 20203
22K00	4822 051 20223
24K00	4822 051 20243
27K00	4822 051 20273
30K00	4822 051 20303
33K00	4822 051 20333
36K00	4822 051 20363
39K00	4822 051 20393
43K00	4822 051 20433
47K00	4822 051 20473
51K00	4822 051 20513
56K00	4822 051 20563
62K00	4822 051 20623
68K00	4822 051 20683
75K00	4822 051 20753
82K00	4822 051 20823
91K00	4822 051 20913
100K00	4822 051 20104
110K00	4822 051 20114
120K00	4822 051 20124
130K00	4822 051 20134
150K00	4822 051 20154
160K00	4822 051 20164
180K00	4822 051 20184
200K00	4822 051 20204
220K00	4822 051 20224
240K00	4822 051 20244
270K00	4822 051 20274
300K00	4822 051 20304
330K00	4822 051 20334
360K00	4822 051 20364

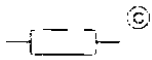

390K00	4822 051 20394
430K00	4822 051 20434
470K00	4822 051 20474
510K00	4822 051 20514
560K00	4822 051 20564
620K00	4822 051 20624
680K00	4822 051 20684
750K00	4822 051 20754
820K00	4822 051 20824
910K00	4822 051 20914
1M00	4822 051 20105
1M10	4822 051 20115
1M20	4822 051 20125
1M30	4822 051 20135
1M50	4822 051 20155
1M60	4822 051 20165
1M80	4822 051 20185
2M00	4822 051 20205
2M20	4822 051 20225
2M40	4822 051 20245
2M70	4822 051 20275
3M00	4822 051 20305
3M30	4822 051 20335
3M60	4822 051 20365
3M90	4822 051 20395
4M30	4822 051 20435
4M70	4822 051 20475
5M10	4822 051 20515
5M60	4822 051 20565
6M20	4822 051 20625
6M80	4822 051 20685
7M50	4822 051 20755
8M20	4822 051 20825
9M10	4822 051 20915
10M00	4822 051 20106

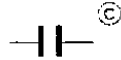

1p	5322 122 32447
1.5p	5322 126 13135
2.2p	5322 122 33063
2.7p	5322 122 31873
3.3p	5322 122 32286
3.9p	5322 122 31944
4.7p	5322 122 32287
5.6p	5322 122 32967
6.8p	5322 122 32269
8.2p	5322 122 33244
10p	5322 122 32448
12p	4822 122 32139
15p	4822 122 32481
18p	5322 122 32965
22p	5322 122 32658
27p	5322 122 31946
33p	5322 122 32659
39p	5322 122 32966
47p	5322 122 32452
56p	5322 122 32661
68p	4822 122 33514
82p	4822 122 33515
100p	5322 122 32531
120p	5322 122 33861
150p	5322 122 33538
180p	4822 126 10326
220p	5322 126 10794
270p	4822 126 13452
330p	4822 122 33805
390p	4822 126 10702
470p	5322 122 34099
560p	4822 122 33173
680p	4822 122 32535
820p	4822 122 33806
1n	5322 122 34123
1.5n	5322 122 31865
2.2n	4822 122 33175
3.3n	4822 122 33891
4.7n	4822 126 10223
6.8n	5322 122 31866
10n	4822 122 33177
15n	4822 122 33128
22n	5322 122 32654