

**MADE IN
USA**

TEN-TEC

**AMATEUR
RADIO
EQUIPMENT**

America's Best!





The Paragon, Performance Plus Model 585

All mode versatility and a transmitted signal you will be proud of. A receiver that has set new standards for sensitivity and quietness. Receives from 100 kHz to 29,999.99 MHz. Transmits on all bands from 1.8 MHz to 29,999.99 MHz with 100 watts output. SSB, CW, real FSK and optional FM. Standard equipment includes speech processor, noise blanker, dual VFOs, TX split, RX split and QSK with a changeover time of 30 ms or less. Five I-F filter positions with the 6 kHz AM filter and 2.4 kHz SSB filter, standard. Optional 1.8 kHz, 500 Hz and 250 Hz filters are selectable independent of mode. Two selectable tuning rates. Passband tuning, notch filter, audio bandpass filter, tone control, squelch and more!

Sixty-two programmable memories that store frequency, mode, filter selected, channel number and a 7 character alpha-numeric "tag" for entering channel I.D., tuner or amplifier settings, etc. Scan rate is selectable and as each memory is scanned all of the stored information is displayed (what a light show!). Alternately, the memories can be tuned with the main tuning knob.

Frequency selection is with the main tuning knob, direct keypad entry or up/down buttons that will shift in one kHz or one MHz increments or to the next ham band. DISPLAY button selects 24 hour clock or date or tag. VOICE button causes a voice frequency announcement with optional synthesized voice board installed.

Rear panel controls are provided to adjust the VOX, CW monitor level and tone, and SSB sidetone monitor level. Switching is provided to control conventional linear amplifiers and of course, high speed switching for QSK linears, such as the Titan. Other rear panel inputs and outputs for transverters, FSK (170 Hz shift), fixed level audio out, audio in, external speaker, aux dc jack and provision for the optional RS-232 control interface. An absolute delight for the all mode operator.

The Paragon is the result of a three year engineering effort. We are proud of the Paragon and we think it has set new standards of excellence in synthesized rigs. Check it out yourself. We think that you will share our pride in the Paragon.

GENERAL SPECIFICATIONS

Frequency Range: Receive: 100 kHz to 29,999.99 MHz. Transmit: 1.6 to 29,999.99 MHz.

Frequency Control and Readout: Microprocessor controlled digital PLL synthesizer. 10 Hz resolution.

Frequency Stability: Worst case, 1 PPM per degree C at 29,999 MHz.

Frequency Accuracy: ± 100 Hz @ 25 degrees C.

Antenna Impedance: 50 ohm unbalanced.

PC Boards: 14 double-sided, 9 single-sided .062" glass-epoxy.

Power Required: Receive = 1.5A. Transmit = 20A. 12 - 14 VDC.

Dimensions: HWD 5 $\frac{3}{4}$ " x 14 $\frac{3}{4}$ " x 17". (14.6 x 27.3 x 43.2 cm).

Net Weight: 16 lbs. (7.25 kg).

TRANSMITTER

Modes: USB & LSB (J3E), CW (A1A), FSK (F1A); FM (F3E) optional (Model 256).

DC Power Input: Maximum 200 watts.

RF Power Output: ALC stabilized, adjustable, 25 to 100 watts (into 50 ohms) with front panel RF OUT control.

Microphone Input: Low impedance, bias voltage for electret provided.

CW Sidetone: Internally generated, adjustable tone and volume independent of AF GAIN control.

SSB Generation: 9 MHz, 8-pole crystal ladder filter. Balanced modulator.

Carrier Suppression: Greater than 60 dB.

Unwanted Sideband Suppression: Greater than 60 dB at 1.5 kHz AF input.

Harmonic Emissions: Greater than 45 dB below peak power output.

Spurious Output: Greater than 50 dB below peak power output.

Third Order Intermod Products: -30 dB from two-tone at 100 watts PEP.

Metering: Switchable forward power, SWR, collector current or audio processing level on SSB.

CW Offset: 750 Hz automatic.

FSK Shift: 170 Hz.

Transmit Offset Tuning Range: ± 99.9 kHz.

RECEIVER

Modes: USB, LSB, CW, FSK, AM, (FM optional).

Sensitivity:

	1-1.6 MHz	1.6-29,999 MHz	
SSB/CW/RTTY	.5 μ V	.15 μ V	10 dB S/N @ 2.4 kHz
AM	3.5 μ V	1.0 μ V	10 dB S/N @ 6.0 kHz
FM	1.0 μ V	.3 μ V	12 dB SINAD @ 15 kHz

Selectivity:

	-6 dB BW	-60 dB BW	Shape Factor
Standard AM	6.0 kHz	11.24 kHz	1.875:1
Standard SSB	2.4 kHz	3.36 kHz	1.87:1
Opt. 1.8 kHz SSB (Model 288)	1.8 kHz	2.9 kHz	1.60:1
Opt. 500 Hz CW (Model 285)	500 Hz	1.4 kHz	2.80:1
Opt. 250 Hz CW (Model 282)	250 Hz	.85 kHz	3.40:1
Standard FM	15 kHz	30 kHz	2.00:1

Attenuator: -20 dB for 1.6 to 29,999 MHz, -10 dB for .1 to 1.6 MHz.

I-F Frequencies: 1st = 75 MHz, 2nd = 9.0 MHz, 3rd = 6.3 MHz (FM 3rd = 455 kHz).

Image Rejection: Greater than 80 dB.

I-F Rejection: Greater than 70 dB.

Noise Blanker: Switchable on/off with adjustable width.

Dynamic Range: 100 dB.

Blocking Dynamic Range: ± 16 dBm for 1 dB compression of an S9 signal, frequency offset = 50 kHz. -2 dBm for 1 dB compression of an S3 signal, frequency offset = 50 kHz.

Third Order Intercept: +18 dBm.

Noise Floor: -132 dBm @ 2.4 kHz BW.

Squelch Sensitivity: Less than .6 μ V.

Receiver Recovery Time: Less than 27 ms.

Receiver Offset Tuning Range: ± 99.9 kHz.

Pass Band Tuning I-F Shift: ± 1.2 kHz.

Audio Output: 1.5 watts @ 8 ohms.

Notch Filter: 250 to 2.2 kHz, greater than 50 dB notch depth.

Audio Bandpass Filter: 4 pole, variable center frequency 220 to 1.7 kHz, 35% bandwidth @ -6 dB.

Tone Control: Variable 15 dB rolloff @ 5 kHz.

PARAGON/OMNI V ACCESSORIES

SPEAKER/POWER SUPPLY

Designed for use with any Ten-Tec 100 watt rig. This highly regulated and very well filtered power supply uses 105 to 125 or 210 to 250 Vac 50/60 Hz, primary power, fuse protected. The output voltage is adjustable from 11.5 to 15 Vdc, factory adjusted to 13.8 Vdc and "over-voltage" protection is incorporated. Regulation is better than 3%, from "no load" to "full load." A re-setting, electronic latching circuit breaker limits current for the protection

of the power amplifier and is adjustable. Maximum load is 22 A. Ripple is less than 20 mV peak-to-peak at 20 A. The front panel mounted speaker is a ceramic magnet dynamic, 8 Ohm. The dc output cable is terminated into a 4 pin AMP MATE-N-LOC[®] which connects to any Ten-Tec transceiver. Two rear panel phono jacks may be used to supply dc to low power accessories.
Size: HWD 5.25" x 7.5" x 13.5" (13.3 x 19 x 34.3 cm).
Weight: 18 lbs. (8.2 Kg).



Model 961, Speaker/Power Supply

Model 256, FM Board.

This easily installed module adds FM transmit and receive capability. System bandwidth is 5 kHz.

Model 257, Voice Synthesizer Board.

This plug-in board announces the frequency displayed when the VOICE button is pressed.

Model 259, Universal ALC Annunciator.

This is great for the vision impaired operators and can be installed in any transceiver with ALC. When the mic gain is advanced to the proper level, a beep sounds.



The OMNI V Model 562

The OMNI V is a Paragon with a 12 band crystal mixed local oscillator in place of the general coverage synthesized oscillator. The result is receiver cleanliness like the legendary Corsair and Omni series. The OMNI V local oscillator is a new ultra low noise 5.0 to 5.5 MHz PLL design. Phase noise is simply eliminated as a significant variable. Dynamic range is maintained right up to the edges of the crystal filters, even under the most adverse conditions.

Many of the nifty features made possible by digital technology are included. Dual VFO's with A-B-split select, the frequency stability of a PLL, 25 tuneable memories, VFO to MEM, MEM to VFO and the SCRATCHPAD feature. RS-232 interface is standard and includes remote band switching for the HERCULES II amplifier. The memories are nonvolatile RAM and are retained until you change them. The status registers and clock are backed with a lithium battery (2 year life) so that when the rig is powered up, the status is the same as when you turned it off.

The OMNI V operates USB, LSB, fast or slow QSK CW and real FSK. FM is optional. All bands from 160 through 10 meters are push button selectable. Each band position covers 500 kHz plus 30 kHz over-shoot at the band edges. The four 500 kHz segments of the 10 meter band are switched automatically as you tune through the segment limits. Tuning is in your choice of 10 Hz or 50 Hz increments on SSB, CW and FSK. With the FM option, tuning is in 100 Hz or 500 Hz increments. Up/Down buttons tune in 10 kHz or 50 kHz increments.

An auxiliary frequency tuning system is available and plugs into the rear panel. This allows you to remotely tune the frequency from the most convenient and comfortable position. It takes about 10 ms to fall in love with this option.

A noise blanker and audio speech processor are standard equipment as is the cw sidetone and speech monitor. The rear panel has a full complement of inputs, outputs and controls for the convenience of the all-mode operator, including an auxiliary RX antenna input. High speed key lines are provided for QSK control of a fast switching amplifier, such as the TITAN or HERCULES II. Changeover in fast QSK is less than 30 ms, great for CW and the digital modes.

The front panel is spacious and friendly. The vacuum fluorescent display uses large, bright, easy to read elements. The frequency display doubles as the 24 hour clock display when the CLOCK button is pressed. Other elements indicate VFO status and warn when the memories are full.

All four of the 6.3 MHz I-F crystal filter positions are push-button selectable, independent of mode. A second filter socket is also provided, in series, behind the standard 2.4 kHz filter in the 9 MHz I-F. This may be used for an optional 2.4 kHz, 1.8 kHz, 500 Hz or 250 Hz filter which is selected with the "NARROW" button. This adds six or eight poles into the crystal filter network and even further reduces the impact of adjacent strong signals. Most impressive!

If you do not need a general coverage receiver in your HF rig, the elegant OMNI V is a great choice. If you are also a serious DX'er and/or contest, the OMNI V is the best choice.

GENERAL SPECIFICATIONS

Frequency Range: Transmit and receive on all ham bands from 160 through 10 meters in their entirety. Twelve 500 kHz segments plus 30 kHz over-shoot at the upper and lower edges of the segments.

Frequency Control: LO generated from a crystal oscillator mixed with a low noise 5.0 - 5.5 MHz phase locked loop.

Frequency Stability: Worst case, 1 PPM per degree C at 29.999 MHz.

Frequency Accuracy: + -100 Hz @ 25 degrees C.

Antenna Impedance: 50 Ohms, unbalanced.

Printed Circuit Boards: G-10 epoxy glass.

Power Required: Receive = 1.5 A. Transmit =

20 A. 12 - 14 Vdc.

Dimensions: HWD 5 $\frac{3}{4}$ " x 14 $\frac{3}{4}$ " x 17". (14.6 x 27.3 x 43.2 cm).

Net Weight: 16 lbs. (7.25 kg).

TRANSMITTER

Modes: USB and LSB (J3E), CW (A1A), FSK (F1A). Optional FM (F3E).

DC Power Input: 200 watts maximum.

RF Power Output: ALC stabilized, adjustable from 20 watts to 100 watts (50 Ohm load) with front panel RF OUT control.

Microphone Impedance: 200 Ohms to 50k Ohms. Bias voltage for electret mic is provided in front panel connector.

CW Sidetone: Internally generated with rear panel level and tone adjustments, independent of front panel audio level control.

SSB Generation: 9 MHz, 8 pole crystal ladder filter, balanced modulator.

Carrier Suppression: Greater than 60 dB.

Unwanted Sideband Suppression: Greater than 60 dB at 1.5 kHz AF input.

Harmonic Emissions: Greater than 45 dB below peak power output.

Third Order Intermod Products: -30 dB from two tone at 100 watts PEP.

Metering: Switchable forward power, SWR, collector current or audio processing level on SSB.

CW Offset: 600 Hz.

FSK Shift: 170 Hz.

RECEIVER

Modes: LSB, USB, CW and FSK. FM with optional board.

Sensitivity: .15 uV for 10 dB signal to noise ratio at 2.4 kHz bandwidth. With FM option, .3 uV for 12 dB SINAD at 15 kHz bandwidth.

Selectivity:

	-6 dB BW	-60 dB	Shape Factor
Standard 2.4 kHz	2.4 kHz	3.36 kHz	1.87:1
Opt. 1.8 kHz	1.8 kHz	2.90 kHz	1.60:1
Opt. 500 Hz	500 Hz	1.40 kHz	2.80:1
Opt. 250 Hz	250 Hz	.85 kHz	3.40:1
Opt. FM	15 kHz	30.00 kHz	2.00:1

Attenuator: -20 dB.

I-F Frequencies: 1st I-F 9 MHz, passband tuning I-F 6.3 MHz.

Image Rejection: >100 dB.

I-F Rejection: >60 dB average.

Noise Blanker: Switchable on/off with width adjustment.

Dynamic Range: 97 dB, measured with standard 2.4 kHz filter at 20 kHz spacing. 100 dB + with cw filters.

Third Order Intercept: +10 dBm.

Noise Floor: -133 dBm @ 2.4 kHz bandwidth.

Squelch Sensitivity: Less than .6 uV.

Receiver Recovery Time: Less than 30 ms.

Pass Band Tuning I-F Shift: + -2.3 kHz.

Audio Output: Speaker, 1.5 watts @ 8 Ohms. Fixed level 1 mw @ 600 Ohms.

Notch Filter: 250 Hz to 2.2 kHz, greater than 50 dB notch depth.

Audio Bandpass Filter: 4 pole, variable center frequency 220 Hz to 1.7 kHz, 35% band width @ -6 dB.

Tone Control: Variable 15 dB roll-off @ 5 kHz.

Phase Noise Performance of the OMNI V: -127 dBc/Hz @ 250 Hz offset from carrier. -146 dBc/Hz @ 5 kHz offset from carrier.

9 MHz I-F FILTERS FOR OMNI V

MODEL 216.

Special 500 Hz, 6 pole crystal ladder filter centered for operation on the digital modes. (RRTY, packet and AMTOR.)

MODEL 217.

500 Hz, 8 pole crystal ladder cw filter.

MODEL 218.

1.8 kHz, 8 pole crystal ladder ssb filter.

MODEL 219.

250 Hz, 6 pole crystal ladder cw filter.

MODEL 220.

2.4 kHz 8 pole crystal ladder ssb filter.



6.3 MHz I-F FILTERS FOR OMNI V AND PARAGON.

MODEL 282.

250 Hz, 6 pole crystal ladder filter for cw or the digital modes.

MODEL 285.

500 Hz, 6 pole crystal ladder filter for cw or the digital modes, for Paragon. (Built into OMNI V.)

MODEL 288.

1.8 kHz, 8 pole crystal ladder ssb filter.

Model 258, RS-232 Interface Board.

Provides remote computer control of frequency, mode, filter selection, VFO selection, all memory and scan features including memory programming and the other functions controlled from the push-button panel on the face of the Paragon. Supplied with command data for writing the program. Program discs are available from Ten-Tec for some of the more popular computers.



The DELTA II Model 536

The Delta II is a full featured transceiver designed for base, mobile or portable operation. Simplified all mode operation without compromising performance! Synthesized PLL design provides general coverage from 100 kHz to 30 MHz. Our unique new Jones I-F filter system (patent pending) is standard equipment. This is an eight pole crystal ladder filter design with a continuously variable bandwidth from 500 Hz to 2.4 kHz. Outstanding selectivity that is operator optimized for ssb, cw or the digital modes. Passband tuning is digitally controlled, variable ± 2.5 kHz. Standard AM and FM filters are mode selected. The Delta II delivers outstanding receiver performance, in the ham bands or anywhere in between.

The transmitter power is continuously variable from 100 watts to less than 20 watts output. Superb ssb performance with front panel adjustment of the "set and forget" VOX gain, delay and anti-VOX controls using our new "soft touch" control system. Noise blanker, speech processor and the FM transceive mode are all standard features.

QSK cw performance and a keyed wave from that will embarrass some big rigs (not ours) costing several times more. Independent, ± 1.27 kHz, offset tuning that tracks when using the main frequency tuning control. CW sidetone with variable pitch and volume. Push-button activated reference tone is used to net another cw signal, exactly.

Rear panel connections are provided for amplifier control, audio in and out, cw key, PTT, band information and remote control interface.

Dual VFOs with A = B, A/B and SPLIT. In SPLIT, use the momentary REVERSE button to receive on the transmit VFO to "pick and set" your transmit frequency. This feature allows strategic positioning in a pile-up. Frequency is entered with the numeric key pad or tuned with UP/DOWN buttons in 100 kHz or 1MHz steps. Use the FUNCTION-UP/DOWN buttons to scroll through the 9 ham bands.

Other features include variable tuning rates from 10 Hz to 500 Hz, selected with FAST button and mode. Thirty-one memories. Ten of the memories can be programmed for split frequencies. Scratch pad for temporary storage of frequency and mode, with single button recall. Memory recall by channel number or using memory tune.

The LCD display panel holds contrast, even in direct sunlight. Frequency, VFO status, mode, memory channel, 24 hour clock, receive offset frequency and multi-function bar-graph meter are all

an integral part of the display. Back lighting is provided with an electro-luminescent panel which may be turned on/off.

The Delta II is built to travel. At the same time, modern technology has been applied to deliver "big rig" performance and reliability. All you need to add is a source of 12 Vdc and an antenna.

GENERAL SPECIFICATIONS

Frequency Coverage: Transmit all ham bands, 160 through 10 meters. Receive 100 kHz to 29.999.99 MHz.

Frequency Control and Read-Out: Microprocessor controlled, digital phase locked loop synthesizer. 10 Hz resolution.

Frequency Accuracy: ± 100 Hz @ 25 degrees C.

Frequency Stability: Worst case, 1 PPM per degree, 0-50 C.

Dual VFO Control System: A/B selects A or B VFO. A = B nets both VFOs to mode and frequency. SPLIT allows independent transmit/receive frequency control. REVERSE momentarily switches to opposite VFO to listen to or set transmit frequency when operating SPLIT. Can operate cross band and mode.

VFO Tuning Rates: 10 Hz or 50 Hz selectable with FAST button in ssb or cw. 100 Hz or 500 Hz in FM or AM modes.

Memory System: Non-volatile RAM. 31 total. 10 may be programmed for split frequency combinations. Store by channel number or random to an available channel. Recall by channel number or select using memory tune function.

Display: Liquid crystal. Electro-luminescent back lighted panel with on/off switch.

Dial Lock: Adjustable drag.

RS-232 via 1/8" mini jack.

Rear Panel Connections: DIN connector A; band information. DIN connector B; fixed level audio in/out, PTT, TX EN/TX OUT, QSK amplifier control, mic mute (use with AFSK), amplifier control line (non-QSK), foot switch (mutes speaker and activates "T" line) and ground. Separate jacks for external speaker, cw key, AUX 13.5 Vdc and a thermostatically controlled dc line for external cooling for "key-down" modes.

Primary Power: 11 to 14.5 Vdc @ 20 A.

Antenna Impedance: G-10 Ohms, unbalanced.

Printed Circuit Boards: 5-10 epoxy glass.

Dimensions: HWD 3.75" x 9.75" x 14.0" overall. (9.53 x 24.8 x 35.6 cm).

Net Weight: 10 lbs, 10 oz. (4.82 kg).

TRANSMITTER

Modes: LSB, USB, CW, FM. Digital modes using externally generated AFSK. **AM transmit not provided.**

RF Output: Continuously variable, using front panel control, from 100 watts to less than 20 watts.

Microphone Input: 250 to 50,000 Ohms, dc bias voltage for electret element provided.

CW Sidetone: Internally generated, adjustable volume, using front panel "soft touch" system, independent of receiver

volume control. Tone frequency internally adjustable.

SSB Generation: Double sideband modulator. 8 pole crystal ladder filter.

Carrier Suppression: Greater than 60 dB.

Unwanted Sideband Suppression: Greater than 50 dB @ 1.5 kHz AF input.

Harmonic Emissions: Greater than 45 dB below peak power output.

Spurious Output: Greater than 50 dB below peak power output.

Third Order Intermod Products: -30 dB from two tone at 100 watts output.

Metering: Forward power, SWR in transmit. S-meter in receive. Indicates control settings in "soft touch" adjust mode.

CW Offset: Factory preset 500 Hz, field programmable.

VOX System: VOX gain, delay and anti-VOX are front panel adjustable using our "soft touch" control system.

RECEIVER

Modes: USB, LSB, CW, FM, AM and digital modes.

Sensitivity:

Mode	.1 to 1.6 MHz	1.6 to 29.999.99 MHz
SSB/CW/AFSK	.5 μ V	.25 μ V
AM	3.5 μ V	1.00 μ V
FM	1.0 μ V	.30 μ V

SSB/CW/AFSK .5 μ V

AM 3.5 μ V

FM 1.0 μ V

Selectivity: 8 pole, crystal ladder I-F filter with continuously variable band-width, from 500 Hz to 2.4 kHz, used in cw, ssb and digital modes. FM and AM modes automatically select built-in filters.

Attenuator: -20 dB, .1 to 29.999 MHz.

I-F Frequencies: 1st = 45 MHz, 2nd = 6.144 MHz. (FM mode 3rd = 455 kHz).

Image Rejection: Greater than 80 dB.

I-F Rejection: Greater than 70 dB.

Noise Blanker: Switchable, ON/OFF.

Dynamic Range: 95 dB, typical.

Noise Floor: -129 dBm. (.25 μ V for +10 dB s/n in ssb)

Squelch Sensitivity: Less than .6 μ V.

Receiver Recovery Time: Less than 27 ms.

Receiver Offset w/RXO Control: ± 1.27 kHz with digital display.

Passband Tuning: Digitally controlled, ± 2.5 kHz.

BFO: Digitally controlled, phase locked loop.

Audio Output: 1.5 watts @ 8 Ohms, less than 2% THD.

Notch Filter: 250 to 2.2 kHz, greater than 50 dB notch depth.

Specifications subject to change.

AVAILABLE NOVEMBER 1990

DELTA II/ARGONAUT II ACCESSORIES

Model 936.

Portable power supply for the Delta II. Output is adjustable from 11.5 to 15 Vdc, factory set for 13.8 Vdc. Adjustable electronic current trip circuit, 22 amps max. Primary power switchable for 105/125 Vac or 210/250 Vac, 50 - 60 Hz, fused. DC output into a 5 foot, 2 conductor #14 cable terminated in a 2 conductor AMP Mate-N-Lock connector which mates with the Delta II dc input connector. Two AUX dc outputs through RCA phono jacks for low power accessories. Size: HWD 3 3/4" x 5 1/2" x 12". Weight: 18 lbs.

MODEL 290, STEP ATTENUATOR.

Reduces pass-through power in six, switch selected, calibrated steps from five watts to 10 mw. A great accessory for the Argonaut II and the true QRP experimenter.



UNIVERSAL ACCESSORIES



CIRCUIT BREAKER

1140 DC Models 546/560/561/562/580/585.



TEN-TEC

The ARGONAUT II Model 535

The Argonaut II adds a new dimension to QRP transceiver operation—world class receiver performance! The fully synthesized PLL design provides general coverage from 100 kHz to 30 MHz. Our unique new Jones I-F filter system (patent pending) is standard equipment. This is an eight pole crystal ladder filter design with a continuously variable band-width, from 500 Hz to 2.4 kHz. Outstanding selectivity that is operator optimized for ssb, cw or the digital modes. Passband tuning is digitally controlled, variable ± 2.5 kHz. Standard filters for AM or FM reception are mode selected. The Argonaut II delivers outstanding receiver performance, in the ham bands or anywhere in between.

The transmitter power is continuously variable from one-half watt to 5 watts output. Accessory attenuator provides accurate output power control to a fraction of one watt. Superb ssb performance with front panel adjustment of the "set and forget" VOX gain, delay and anti-VOX controls using our new "soft touch" control system. Noise blanker, speech processor and the FM transceive mode are all standard equipment.

QSK cw performance and a keyed wave form that will embarrass some big rigs (not ours) costing several times as much. Independent, ± 1.27 kHz, offset tuning that tracks when using the main frequency tuning control. Cw sidetone with variable pitch and volume. A reference tone can be keyed for "zeroing" a cw signal exactly.

Dual VFO's with A=B, A/B and SPLIT. In SPLIT, use the momentary REVERSE button to listen to the transmit VFO to "pick and set" your transmit frequency. This feature allows strategic positioning in a pile-up. Frequency is entered with the numeric key pad or tuned with UP/DOWN buttons in 100 kHz or 1 MHz steps. Use the FUNCTION-UP/DOWN buttons to scroll through the ham bands.

Other features include variable tuning rates from 10 Hz to 500 Hz, selected with FAST/SLOW button and/or mode. Thirty-one memories. Ten of the memories can be programmed for split frequencies. Scratch pad for temporary storage of frequency and mode, with single button recall. Memory recall by channel number or using memory tune.

The Argonaut II is designed for base station, mobile or portable use. Energy efficient for practical battery operation. Operates on 12/14 Vdc or 12/14 Vac using a wall transformer. The LCD display panel shows frequency, VFO status, mode, memory channel, 24 hour clock and multi-function bar-graph

meter. Back lighting is provided with an electro-luminescent panel which may be turned on/off.

The Argonaut II is the result of research within the QRP community. Many of the features are the direct result of feedback from the QRP "Gurus," worldwide. All of the transceiver features are standard equipment. We are proud of our QRP heritage and we think this pride shows in the Argonaut II.

GENERAL SPECIFICATIONS

Frequency Coverage: Transmit all ham bands, 160 through 10 meters. Receive 100 kHz to 29,999.99 MHz.

Frequency Control and Read-Out: Microprocessor controlled, digital phase locked loop synthesizer. 10 Hz resolution.

Frequency Accuracy: ± 100 Hz @ 25 degrees C.

Dual VFO Control System: A/B selects A or B VFO. A=B nets both VFOs to mode and frequency. SPLIT allows independent transmit/receive frequency control. REVERSE momentarily switches to opposite VFO to listen to or set transmit frequency when operating SPLIT. Can operate cross band and mode.

VFO Tuning Rates: 10 Hz or 50 Hz selectable with FAST button in ssb or cw. 100 Hz or 500 Hz in FM or AM (receive only) modes.

Memory System: Non-volatile RAM. 31 total. 10 may be programmed for split frequency combinations. Store by channel number or random to an available channel. Recall by channel number or select using memory tune function.

Frequency Stability: Worst case, 1 PPM per degree C @ 25 degrees C.

Display: Liquid crystal. Electro-luminescent back lighted panel with on/off switch.

Primary Power: 12/14 Vdc or Vac. Filter, rectifier and current regulator, built-in. Can be operated with a 12/14 Vac transformer.

Antenna Impedance: 50 Ohms, unbalanced.

Printed Circuit Boards: G-10 epoxy glass.

Dimensions: HWD 3.75" x 9.75" x 12.5" overall. (9.5 x 24.8 x 31.7 cm).

Net Weight: 8 lbs, 10 oz. (3.91 kg).

TRANSMITTER

Modes: LSB, USB, CW, FM. Digital modes using externally generated AFSK. AM transmit not provided.

RF Output: Continuously variable, using front panel control, from 5 watts to approximately .5 watt.

Microphone Input: 250 to 50,000 Ohms, dc bias voltage for electret element provided.

CW Sidetone: Internally generated, adjustable volume independent of receiver volume control. Tone frequency internally adjustable.

SSB Generation: Double sideband modulator. 8 pole crystal ladder filter.

Carrier Suppression: Greater than 60 dB.

Unwanted Sideband Suppression: Greater than 50 dB @ 1.5 kHz AF input.

Harmonic Emissions: Greater than 45 dB below peak power output.

Spurious Output: Greater than 50 dB below peak power output.

Third Order Intermod Products: -30 dB from two tone at 5 watts output.

Metering: Forward power, SWR in transmit. S-meter in receive. In the "soft touch" adjust mode, the meter scale is used to display VOX gain, anti-VOX and other control settings.

CW Offset: Factory preset 500 Hz, field programmable.

VOX System: VOX gain, delay and anti-VOX are front panel adjustable using our "soft touch" control system.

RECEIVER

Modes: USB, LSB, CW, FM, AM and digital modes.

Sensitivity:

Mode	.1 to 1.6 MHz	1.6 to 29,999.99 MHz
SSB/CW/AFSK	.5 μ V	.25 μ V
AM	3.5 μ V	1.00 μ V
FM	1.0 μ V	.30 μ V

Selectivity: 8 pole, crystal ladder I-F filter with continuously variable band-width, from 500 Hz to 2.4 kHz, used in cw and ssb (also digital) modes. FM and AM modes automatically select built-in fixed band-width filters.

Attenuator: -20 dB, .1 to 29,999 MHz.

I-F Frequencies: 1st = 45 MHz, 2nd = 6.144 MHz. (FM mode 3rd = 455 kHz).

Image Rejection: Greater than 80 dB.

I-F Rejection: Greater than 70 dB.

Noise Blanker: Switchable, ON/OFF.

Dynamic Range: 95 dB, typical.

Noise Floor: -129 dBm. (.25 μ V for + 10 dB s/n in ssb)

Squelch Sensitivity: Less than .6 μ V.

Receiver Recovery Time: Less than 27 ms.

Receiver Offset w/RXO Control: ± 1.27 kHz with digital display.

Passband Tuning: Digitally controlled, ± 2.5 kHz.

BFO: Digitally controlled, phase locked loop.

Audio Output: 1.5 watts @ 8 Ohms, less than 2% THD.

Notch Filter: .250 to 2.2 kHz, greater than 50 dB notch depth.

Specifications subject to change.

AVAILABLE OCTOBER 1990



Model 604 Electronic Iambic Keyer.

Unique torque driven paddles and adjustable magnetic tensioning system for the ultimate "touch" control. Front panel adjustment of speed and weighting. A cw operator's delight.

Model 605 Single Paddle Electronic Keyer.

Operation is just like a "bug" except the dashes are also keyed automatically. Adjustable paddle tension, speed and weighting. Also great for mobile use.

Model 606.

Single paddle electronic keyer designed for battery power, using a Curtis chip. Adjustable paddle travel and tension. Speed and weighting front panel adjustable. Small size, energy efficiency and rugged paddle construction make this model the ideal traveller.



MICROPHONES FOR USE WITH ANY MODEL WITH A 4-PIN MIC CONNECTOR

700C Hand mic, electret w/coiled cord and connector.

705 Desk mic, electret with cord and connector.



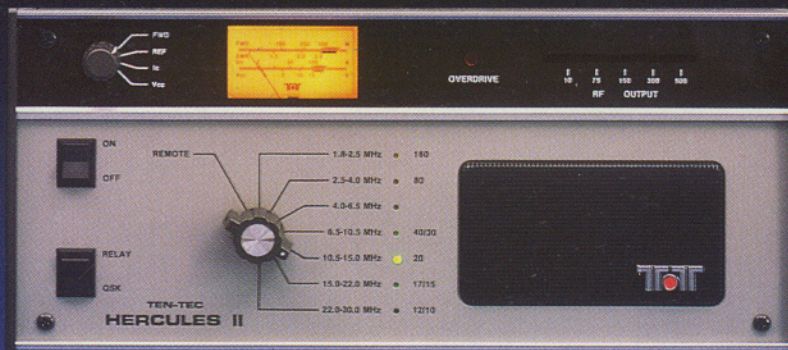

The HERCULES II, Solid State Kw Linear Amplifier Model 420

High tech simplicity, base or mobile. A compact, lightweight HF amplifier that offers a unique combination of virtues that can only be achieved using modern, solid state technology. Instant on, 12 - 14 Vdc operation, general coverage from 160 through 10 meters, no-tune operation and compact size. Add to that, lightning fast QSK cw, remote control, superb linearity and a low drive requirement. Outstanding!

The Hercules II is attractively styled to match our HF base station transceivers and will interface nicely with virtually all transceivers. The front panel includes an analog multi-meter for collector current, voltage, forward power and SWR. A ten element LED bargraph instantaneously displays peak power output. Band selection is either with the front panel switch or remotely via a rear panel connector. A front panel

speaker is built in.

The internal heat sinks are air cooled by a temperature controlled tube axial fan. Whisper quiet in ssb operation, yet enough air capacity for cool operation in the key-down modes. The Hercules II is compact, good looking and generates a signal that is within one S-unit of the mighty Titan.

MODEL 9420 115/230 VAC POWER SUPPLY

Housed in a separate utility enclosure and remotely controlled through the 6 foot power cable. 100 amperes at 13.7 Vdc is provided. 80 amperes for the amplifier and 20 amps for the exciter. An alternate power supply can be a heavy duty, deep cycle, lead acid battery and an automatic 10 amp charger. This low cost alternative power source will support the Hercules II during sustained amateur service.

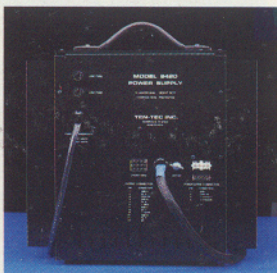

REMOTE CONTROL HEAD MODEL 9423.

For mobile installations with the Hercules II remotely mounted. Compact size (HWD 1.5" x 6.25" x 4") allows the remote head to be installed at the transceiver. Functions include ON/OFF, QSK or VOX/PTT control, band select with band indicator LEDs, 10 element LED peak power display and "FAULT" indicator. Unit includes mounting bracket and 12 ft. cable, terminated to plug into the Hercules II rear panel remote control connector. For longer cable runs, order Model 300, 12 ft. extension cable.



MODEL 9422 DC CABLE.

Model 9422 DC power adaptor cable for mobile or fixed station battery power. 14" length with 12 pin Molex that connects to the amplifier and heavy terminal lugs for positive and negative battery connection.

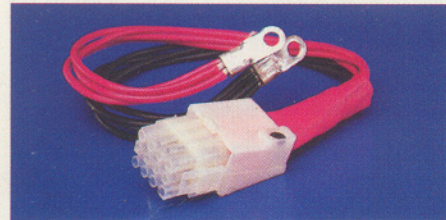

EXTENSION CABLE FOR REMOTE CONTROL, MODEL 300.

Twelve foot extension cable for use with the Model 9423 remote control. Terminated at both ends for quick installation.

MODEL 264.

A combination "Y" (Molex connectors) and 4 ft. extension cable for adding a second device to the automatic band select information line. This cable required, in addition to the Model 236, if both the Hercules II and Model 253 automatic tuner are used.

MODEL 236.

A combination "Y" (25 pin "D" connectors) and 4 ft. extension cable for connecting the Hercules II for remote control from a Paragon or Omni V transceiver. Provides a second 25 pin "D" connector for connection of second device such as a computer or the Model 301 remote frequency tuning encoder (Omni V only) to the transceiver.

Titan, HF Linear Amplifier, Model 425



The Titan has it all! Maximum legal power with ease, all full power bands 160 through 15 meters (10 and 12 meters after authorized modification), lightning fast QSK for break-in cw and the digital modes and a two speed blower for quiet operation. This awesome performance from a desk top amplifier is made possible by the remote power supply and a pair of Eimac® 3CX800A7 ceramic triodes. The heart of the power supply is our own four core, tape wound Hypersil® transformer. This 41 lb behemoth is conservatively rated at 2.5 kVa CCS (9.2 kVa IVS) and is nearly noiseless, even at 1500 watts output!

Other features include a front panel, peak reading wattmeter using an instantaneous ten element LED bargraph display. PTT/VOX or QSK control line select switch, built-in SWR meter and an "over-drive" warning LED. 3:1 vernier TUNE and LOAD controls in combination with an outstanding RF deck design, make the Titan a real "pussy cat" to load and operate.

The Titan is styled to match our transceivers but it interfaces beautifully, no matter what exciter you are using. If you are ready to choose your dream amplifier, the Titan has it all! Check it out.



The CENTURION, HF Linear Amplifier Model 422

The Model 422 Centurion uses the classic pair of Eimac® 3-500Z tubes. The RF deck and power supply are combined into a single, attractively styled, desk top cabinet. The power output is rated at 1300 watts on ssb, 1000 watts cw and 650 watts using "key-down" modes. Drive required for full power ssb operation is 100 watts. The duty cycle is 50%.

QSK cw is achieved using relay switching and the proven T/R circuit from the Hercules II. This circuit also makes the Centurion ideal for fast switching digital modes. VOX ssb is silky smooth and virtually noiseless. This versatile control system assures compatibility with all exciters with amplifier control provisions.

A tube-axial fan is used for forced air cooling. Air flow is routed through the power supply as well as the upper and lower sections of the RF compartment. Air inlets and outlets are in the sides and top of the cabinet to optimize low pressure, low noise, air movement.

A dedicated meter for plate current, a multi-meter for plate voltage, grid current and forward or reflected power. A full time 10 element LED bargraph instantly displays peak power output.

The Centurion operates on all bands from 1.8 to 21.5 MHz. 21.5 to 29.7 MHz is enabled with the installation of an expansion board, supplied no-charge upon proof of licensed authority.

A tough, easy to handle, amplifier that doesn't really mind a little abuse. The Centurion is a great value.

SPECIFICATIONS

Band Coverage: 1.8-2.0, 3.2-4.7, 6.5-10.3, 13.4-19.6, 17.6-21.5 MHz. 21.5-29.7 MHz after authorized modification.

Input Power: 2000 watts, maximum.

Power Output: 1300 watts ssb, 1000 watts cw. RTTY and SSTV 650 watts, 50% duty cycle.

Drive Power: 100 watts for full rated output.

Efficiency: 50-65%, depending on frequency and load impedance.

Input/Output Impedances: 50 Ohms, unbalanced. SWR $\leq 2:1$.

Distortion: -35 dB from 1 kw rf output level.

Harmonics: -50 dB typical.

CW Break-In: QSK capable. Relay switching.

Tube Complement: Two Eimac® 3-500Z.

Power Amplifier Circuit: Class AB2, grounded grid.

Plate Voltage: 3100 volts, no load. 2600 volts, full load.

Cooling: Forced air with full chassis air flow.

Metering: Dedicated plate current meter. Selectable multi-meter for plate voltage, grid current, forward or reflected power. Ten element LED bargraph display for peak power indication.

Front Panel Status Indicators: Standby, operate, transmit.

Primary Power: 220-250 Vac @ 15 A. 110-125 Vac @ 30 A, 50/60 Hz. For full power operation, 220-250 Vac is strongly recommended.

Circuit Protection: Primary line fuses. Plate transformer primary interlock and high voltage shorting bar.

Front Panel Controls: Power on/off, standby/operate, control mode select (QSK - PTT/VOX), plate TUNE and LOAD, band switch, meter switch.

Tune and Load Controls: 6:1 vernier drives with calibrated dial skirts.

Construction: Aluminum chassis, front and rear panels, interior partitions and top and bottom covers.

Size: HWS 8.25" x 15.25" x 18.5". (20.3 x 38.7 x 46.9 cm).

Weight: 47 lbs (21.3 kg).

OUR BEST FEATURE

is one you may never use. Our service and product support are legendary. Proven, not just claimed! All of our products are designed for field service to the board level. When you call us with a service need, you typically talk to one of the techs who services the model you own. Many times service can be accomplished with a "painless" mail order board exchange. If factory service is required, the work is thorough, fast and at a fair charge.

SPECIFICATIONS

Frequency Coverage: 1.8-2.0, 3.2-4.7, 6.5-8.5, 13.4-19.6, 17.6-23.0. With 10 meter modification, 17.6-26.5, 20.6-31 MHz.

Drive Power: 65 to 80 watts typical for 1500 watts output.

Efficiency: 50-65% depending on frequency, drive level and load.

Distortion: -35 dB from 1 KW RF output level.

Harmonics: -50 dB typical.

Input and Output Impedance: 50 Ohms.

Transmit/Receive Control: Provision for PTT or QSK control lines, front panel selectable. T/R switching uses a Jennings® vacuum relay. RF sensing circuit prevents keying or un-keying if 10 mW of RF present on the RF drive line. Switching time less than 8 ms.

Tube Complement: Two Eimac® 3CX800A7 ceramic, external anode triodes in a grounded grid circuit. Total plate dissipation, 1600 watts.

Plate Voltage: 2400 Vdc, no load.

Over-Drive Protection: A front panel warning light turns on when grid current reaches the allowable limit. At the same time, the grid current limiting circuit takes over to protect the PA tubes.

Cooling: Ducted forced air, vertical exhaust, using a two speed centrifugal blower.

Metering: Full time plate current. Switch selected plate voltage, grid current, forward power or reflected power. Peak power is indicated on a 10 element LED bargraph display. The first nine elements are green—the tenth LED is red and indicates 1500 watts output.

ALC: Negative-going, adjustable threshold.

LED Status Indicators: Overdrive, Standby, Wait, Operate.

Primary Power: 220-250 Vac at 20 A, maximum. 117 Vac operation is possible but not recommended.

Protection: Primary line fuses, plate current fuse, ac line and high voltage interlocks.

Front Panel Controls: Power ON-OFF, STANDBY-OPERATE, selectable control lines VOX/PTT or QSK, Plate TUNE and LOAD controls, BAND Switch, METER Switch.

Size: RF deck, HWD 5.25" x 15.25" x 15". (13.3 x 38.7 x 76.8 cm). Power supply, HWD 8.25" x 13.4" x 10.25". (21 x 34 x 60 cm).

Weight: RF deck, 17 lbs, (7.7 kg). Power supply, 50 lbs, (20.5 kg).

UPS shippable, factory packaged in three cartons; RF deck, power supply w/o power transformer, power transformer.

The Titan is backed by a 3-year limited warranty.

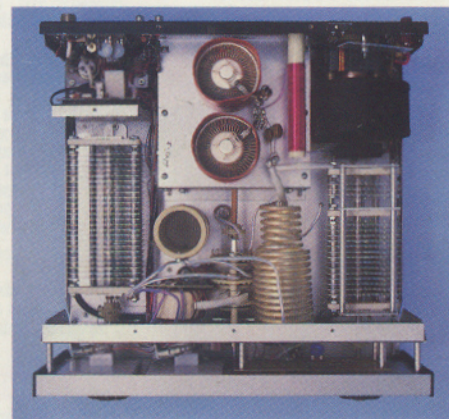

RF Deck

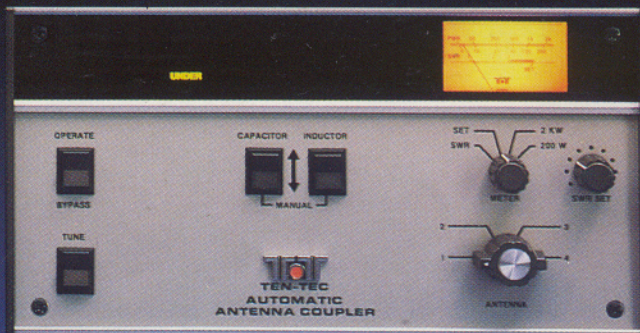

Two Kw, Automatic HF Antenna Coupler Model 253

The ultimate convenience for the station that does not have a world class antenna system, or for the all mode operator who doesn't have the antenna bandwidth required to cover the bands from top to bottom. All you do is provide the Model 253 with 50 watts of tune signal, press the TUNE button, and within seconds your antenna is matched to the transmitter and ready for full power operation. Pretty neat, eh!

The Model 253 also functions as a desk top antenna management system. Provision is made to connect four separate antennas which are selectable from the front panel of the coupler. The fourth antenna position can be configured for a long-wire, balanced feeders using the built-in hi-power balun, or another coaxially fed antenna.

The same silver plated high power roller inductor used in our reliable, time proven, manual tuners is incorporated into the 253. The inductor is driven by a 12 vdc stepping motor. Fixed capacitor values are quickly evaluated and selected with long life, enclosed, relays. Two high speed, high voltage and low loss, vacuum relays are used to switch the tuner into and out of the circuit.

The tuning routine is controlled by an on-board computer. A memory is provided for each of the four antenna positions that recalls the computer derived

settings last used with that antenna switch position. If band switching information is provided by the transceiver, (like the Ten-Tec Paragon, with the optional RS-232 board, and Omni V) one memory is available for each of seven bands at each antenna switch position. If the Ten-Tec Hercules II amplifier is used, the entire station is automatically controlled by the Ten-Tec transceiver. When the memories are used, tune-up is almost instantaneous. Front panel switches are provided for manual over-ride of the automatic system, in case you think you are "smarter" than the on-board computer.

The Model 253 is performance competitive with commercial and military antenna couplers costing many times more. We think that this new product is an example of American ingenuity at its best.

Tuning Accuracy: 1.5:1 VSWR maximum after tuning, 2.5:1 VSWR maximum during tuning.

Automatic Tuning Time: 5 seconds typical, 30 seconds maximum (from home position).

Manual Tuning: Full range manual tuning available via front panel up/down switches.

Memory Tuning: Tuner automatically returns to settings last used for each antenna switch position. Separate settings are stored for each band if remote band connector is used. Retuning (auto or manual) updates memory.

Tune Power: 50 Watts minimum, 150 Watts maximum. Radiated power at least 6dB below input during tuning.

Antenna Switch: 4 position. Position 4 configurable for coax, single wire, or balanced line feed. Internal balun standard.

Output Matching Range: At least 10:1 VSWR, any phase angle, 1.8 to 30 MHz. 1300 Ohms maximum parallel equivalent resistance at 1500 Watts output (2 KV peak, >26:1 VSWR). 5000 Ohms maximum parallel equivalent resistance across balanced line at 1500 Watts output (4 KV peak).

Minimum Full Power Longwire Length: Single wire feed: 180/F (MHz) feet at 1500 watts out.

Arcing Protection: "ARC" indicator illuminates when RF voltage exceeds 2 KV. Tuner is reset to bypass mode if arc indication remains for 1 second.

SPECIFICATIONS

Circuit Type: Reversible "L" network.

RF Power Rating: 2 KW maximum.

Frequency Range: 1.8 to 30 MHz.

Input Impedance: 50 Ohms, nominal.

DC Power Input: 12-14 volts, 2 amps maximum.

Size: HWD 5.5 x 14 x 10.5" (138 x 356 x 267mm).

Weight: 9 lbs 9 oz (4.34 Kg).

ANTENNA TUNER, MODEL 254 RATED AT 200 WATTS

The Model 254 antenna tuner is a compact, lightweight design that will match a variety of balanced or unbalanced antenna feedlines to the 50 Ohm output of an HF transceiver. A unique, Ten-Tec designed, tapped inductor is wound on a 2 inch diameter powdered iron core with provisions for 47 positions on the inductor selection control. Two open air variable capacitors match the input and output of the "T" network. This tuner is ideal for base or portable operation. It also is very effective as a mobile tuner for extending the useable frequency range of a resonant mobile antenna. An SWR metering system is incorporated with meter scales of 0-20 and 0-200 watts.

The meter can be illuminated with an external 12 - 14 Vdc source.

SPECIFICATIONS

- 200 watts continuous power input.
- Silver plated 18 gauge inductor, wound on a 2 inch diameter powdered iron "donut." Forty seven position rotary tap selects inductance value.
- Two variable capacitors tune input and output. Rated at 1000 volts each.
- Frequency range 1.8 to 30 MHz.
- Powdered iron core balun is built in for balanced feeders.
- Rear panel input and outputs through SO-239 UHF connectors for coaxial lines. Terminal posts for long wire or balanced feedline type antennas and

for ground. Front panel switch selects any of four antennas or the "by-pass" position.

- Meter scales for 0-20 and 0-200 watts. External 12 - 14 Vdc required for meter light. Rear panel connector provided.
- Size: HWD 3.5" x 8.75" x 8.5" (8.9 x 22 x 21.6 cm).
- Weight: 4 lbs 3 oz (1.9 kg).



MODEL 291 PORTABLE/MOBILE 200 WATT TUNER

The same "T" match circuit as the Model 254. Rear panel post for connecting a long wire and a SO-239 connector for a coax fed antenna. Uses the metering in your transceiver for tuning. Small, rugged, lightweight and easy to operate. Ideal for the "knock-about" world of portable or mobile operation.



KW DRY DUMMY LOAD MODEL 240KW

This forced air cooled dummy load is designed to operate at 1500 watts "key down" for up to two minutes, in the 1.5 to 150 MHz frequency range. It is ideal for tuning and testing high power transmitting equipment without radiating significant signal levels. A built-in probe provides a signal sample for evaluation, at the panel mounted MONITOR jack. An alarm sounds if load temperature exceeds the allowable limit. The load is provided by two, 100 Ohm 750 watt, ceramic resistors,

connected in parallel. These specially designed resistors are chemically inert and temperature stable.

SPECIFICATIONS

Impedance: 50 Ohms.

Typical VSWR: 1.5 to 30 MHz =

1.2:1. 30 to 150 MHz = 1.5:1.

Power Ratings:

1500 watts	2:00 minutes
1000 watts	2:45 minutes
750 watts	4:30 minutes
500 watts	7:30 minutes
300 watts	continuous

RF Input Connector: SO-239, UHF type.

Fan and Alarm Power: 10 - 14 Vdc. **Size:** HWD 4.5" x 6" x 13" (11.5 x 15.25 x 33 cm).

Weight: 6 lbs 6 oz (3 kg).



BROADBAND DUMMY LOAD MODEL 239

160 through 2 meters with 1:1 SWR. Through 70 cm below 2:1 SWR. 300 watts intermittent duty.



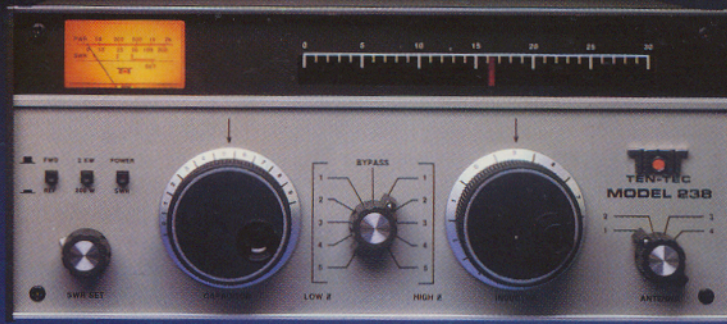

Full Power, Full Featured Manual Tuners Model 238

Model 238. The latest version of our tried and true "L" match design. This circuit is preferred among experts in the field because of its ability to match a broad range of impedances without the risk of self-resonance. All adjustments use calibrated scales for logging and a quick return to the same frequency and antenna. Rear panel fittings for four antennas. Three are dedicated for coax feedlines. The fourth can be coax, single wire or balanced feeders using the built-in high power balun. All are front panel selectable. Multi-meter (illuminated with external 12

Vdc) displays forward power in 0 - 200 and 0 - 2000 watt scales and SWR. The Model 238 is a great way to match broad operating interests to narrow-band or non-resonant antennas.

SPECIFICATIONS

Circuit: Modified "L" network.
Maximum RF Power: 2 kw with a load impedance of 3000 Ohms.
Frequency Range: 1.8 to 20 MHz.

Output Matching Range: At least 10:1 SWR, any phase angle.
Maximum Impedance, Balanced Feedline: 500 Ohms.
Input Impedance: 50 Ohms.
Input/Output Connectors: Input and four antenna coax connectors are SO-239, UHF type. Studs with wing nuts for single wire and balanced feeders.
Variable Capacitor Voltage Rating: 3.5 kv.
Inductance: 28 uH silver plated roller inductor.
Size: HWD 5.5" x 13" x 11". (13.9 x 33 x 27.9 cm).
Weight: 9 lbs (4.1 kg).

For the Builder...

HARD TO FIND TUNER/AMPLIFIER COMPONENTS

Roller inductor, as used in our Model 238 antenna coupler, kilowatt rated with silver plated wire wound on solid coil form. Excellent roller and rotary inductor mechanical design for years of trouble free service. Inductance variable from .1 to 19 uH. Part number 81040.

Kilowatt variable capacitor, as used in the Titan amplifier and Model 238 antenna coupler. Variable from 40 to 500 pF at 3.5 kv. Part number 80858-1.

Tapped inductor wound on a powdered iron core, as used in our Model 254, 200 watt antenna coupler. Variable in 47 steps from .1 to 20 uH. Part number 80402.

Variable capacitor, as used in our Model 254, 200 watt antenna coupler. Tuning range is 1 to 207 pF @ 1 kv. Part number 23227.

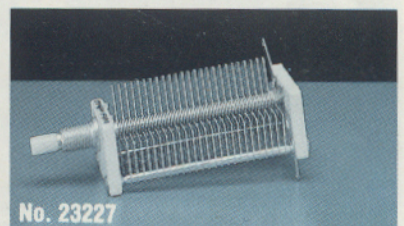
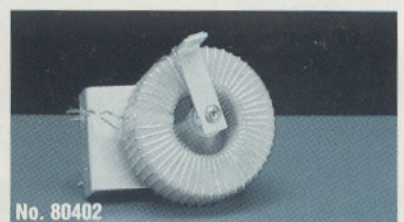
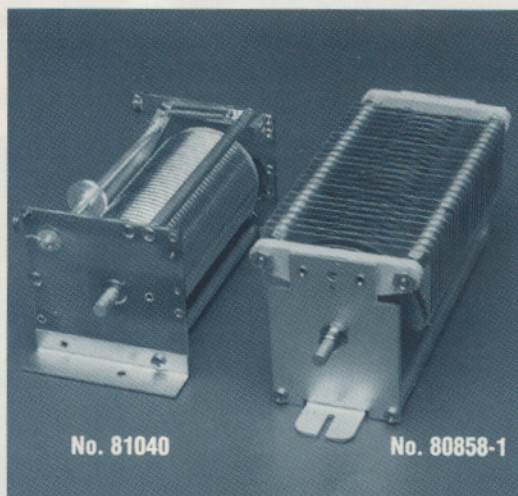

Consumer Electronics Interference Filters

Nothing focuses attention on amateur radio quite like a ripped up TV picture or hi-fi audio that is being substantially destroyed by a single-sideband signal. Finding the cause of the interference can be a challenge that ranks right up there with convincing your family or neighbors that reading a book is more fun than watching TV. The successful approach is to eliminate possibilities one at a time. The first step is a quality low pass filter in your transmission line. The second step is to install an effective high pass filter at the TV/FM receiver.

LOW PASS, 2 KW COAXIAL LINE FILTER MODEL 5061.

This is a 9th order, Chebyshev circuit, with less than 0.2 dB of loss within the passband. 50 dB attenuation at 50 MHz, with 70 dB ultimate, attenuation in the stopband. Unlimited operation at 1500 watts at up to 2:1 SWR. Rugged extruded aluminum housing with SO-239 UHF input/output connectors.

HIGH PASS TV/FM FILTER MODEL 5060.

Forty dB of attenuation below 30 MHz. Insertion loss 2 dB or less. Extruded aluminum case with a female type F chassis connector at one end and a male type F connector on a 4" RG-59 extension at the other end.

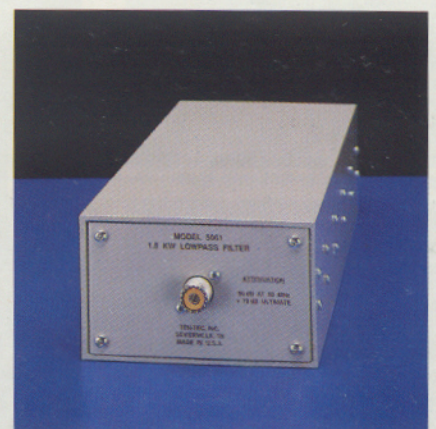
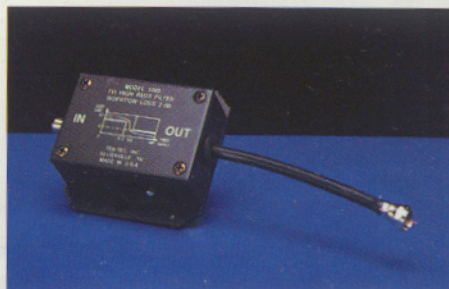

The "Closet Kilowatt" ...

The ultimate XYL pleaser. The entire station enclosed in a handsome, color matched, cabinet measuring 19" high x 21" wide x 18" deep. With only the antenna, power and ground as external connections, the station almost even looks like "wireless." The cabinet is all aluminum with sturdy internal reinforcing members and all welded assembly. Light grey baked enamel finish. Recessed hand-holds. This idea may change the entire image of ham radio, at least in the eyes of those that see your shack.

Rack Mount Kits

RM-420 RACK MOUNT KIT

For the Model 420 Hercules II.

RM-425 RACK MOUNT KIT

For the Model 425 Titan.

RM-500 RACK MOUNT KIT

For the Omni V or Paragon.

RM-253 RACK MOUNT KIT

For the Model 253 automatic tuner.

RM-238 RACK MOUNT KIT

For the Model 238 manual tuner.

RM-P0175-19

1.75" x 19" blank panel. Use when three Ten-Tec units are mounted.

RM-P0700-19

7" x 19" blank panel. Use when Ten-Tec units are mounted.

RM-19-1750 CABINET

With panel opening 19" wide x 17.5" high.



The Ultimate HF Mobile Antennas

HF mobile operation is a world of compromise under the best conditions. Give yourself a "break" and start with a good antenna system. Our 200 watt, linear loaded design is the best compromise between radiation efficiency and mechanical reality. The loading coil is precision wound on a most durable PVC tube and then weather-protected with a heat shrink jacket. All fittings are chrome plated brass. The taper ground, stainless steel whip is vertically adjustable at the center fitting for "no-tears" tuning. The over-all height of 78" or less, combined with the low profile design, results in minimum wind load and eliminates the need for a spring, and it clears most over-head obstacles. The no-spring installation results in less tilting and de-tuning. Band identification is permanently stamped into the base fitting. May be used with any mount that accepts a 3/8" x 24" stud.

MODEL 3101. 42" REPLACEMENT WHIP. USE WITH ALL MODELS. (SUPPLIED WITH EACH ANTENNA.)

- | | |
|---------------------------------|----------------------------------|
| MODEL 4010.
10 meters | MODEL 4040.
40 meters |
| MODEL 4012.
12 meters | MODEL 4075.
75 meters. |
| MODEL 4015.
15 meters | MODEL 4080.
80 meters. |
| MODEL 4017.
17 meters | |
| MODEL 4020.
20 meters | |
| MODEL 4030.
30 meters | |

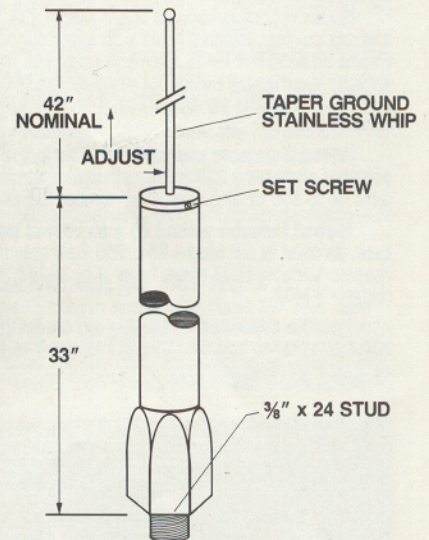
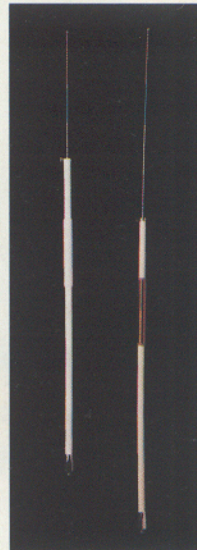

MODEL 293.
Mobile mount. Can be floor or under-dash mounted. Quick-release lever lock-in system.



MODEL 3001. MOBILE MATCHER

Mounts at feed point of the antenna mount. Switch selectable fixed value capacitors plus a "bypass" position. Recommended for minimum SWR on 20, 30, 40, 75 and 80 meters.



TEN-TEC

Equipment Enclosures And Project Boxes

Since Ten-Tec was founded in 1968, we have been a designer and producer of metal and plastic enclosures. The cabinetry for our own electronic equipment is produced in-house and we are a major supplier of custom enclosures for other equipment manufacturers throughout the United States. Shown below, is a

cross section of our catalog line of enclosures. Quality material, quality designs and quality workmanship. The finishing touch for your building efforts.

CONSTRUCTO SERIES B.

Unique in all the world. Variable chassis deck height for design flexibility. Aluminum chassis and panels with steel top and bottom cabinet. Sizes from HWD 2.5" x 6" x 5" to 5.5" x 12" x 9". Blue or Black.

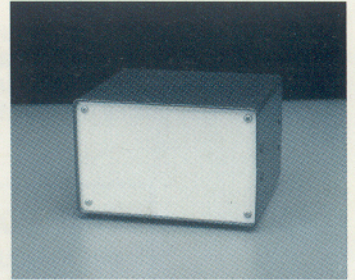
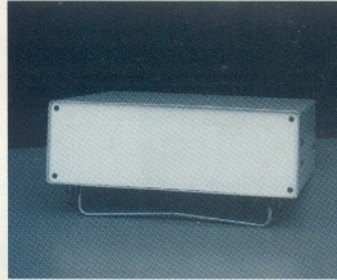

PORTABLE AND DESK TOP, PANEL MOUNT "RACKS."

Handsome, rugged and all aluminum. 19 inch widths with vertical panel openings from 3.5" to 17.5". 9 inch widths with vertical panel openings from 5.25" to 10.5". Optional top mounted carrying handles or side mounted recessed grips. Available unfinished or "Ten-Tec" light grey.

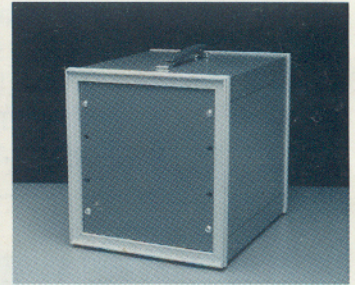
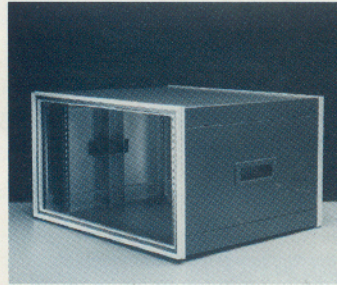

"T" SERIES PROJECT BOXES.

Inexpensive and easy working aluminum. Six standard sizes from HWD 1.96" x 4.27" x 3.9" to 3.09" x 8.27" x 5.76". "TP" models unpainted. "TG" models painted grey with black top cover. "TW" models painted beige with vinyl clad walnut top cover.

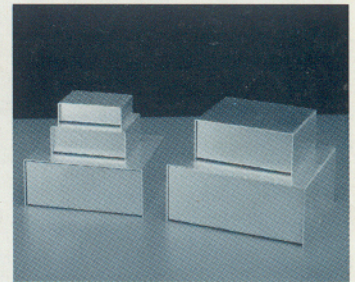
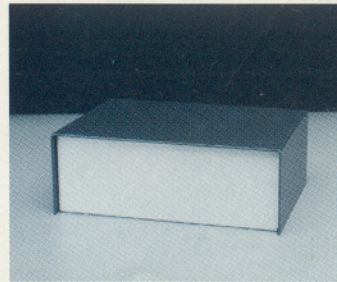

"D/M/J/L/F" SERIES.

Four piece design with molded Cylolac® end caps. Wrap around front/bottom and top/rear covers. Sizes from HWD 2.25" x 3.8" x 5.68" to 4.3" x 14" x 10.3". Grey with black end panels or, beige with vinyl clad walnut trim.

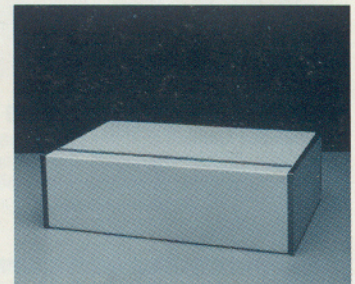
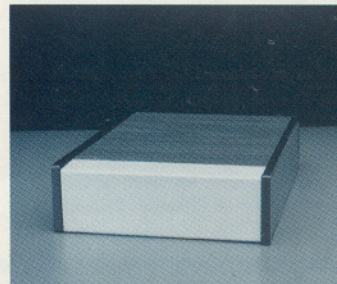

"S/H/V" SERIES.

Five and six plane designs for special applications which require a keypad or keyboard. Vertical styles for applications with active displays and/or speakers. Broad range of sizes. Easy to use metal and plastic construction for that professional, finished look. Available in several finishes and colors.

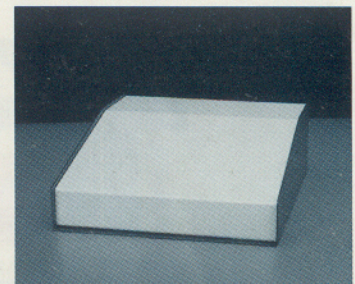
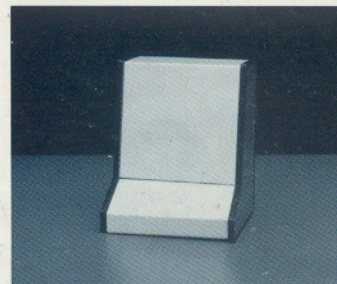

The Ten-Tec Story

All Ten-Tec products are produced in our 40,000 square foot plant located in the foothills of the Great Smoky Mountains. The basic processes are done in-house including the design and manufacture of printed circuit boards, plastic molding, sheet metal fabrication and finishing, and of course electronic assembly and testing. We produce our own tooling in our well equipped tool and die shop. Our development lab and quality control department are exceptionally well staffed and supported by the latest in instrumentation.

We produce custom enclosures for other equipment manufacturers and a standard catalog line of metal enclosures. We produce custom tools and dies for many manufacturers in the region. This unique combination of in-house processes

ensures our ability to produce equipment of the highest quality, reliability and value.

We are proud of our reputation for customer service and product support. Our philosophy is that a sale is the beginning of a happy relationship. We provide service on our products that have been discontinued for many years, and we do so promptly and at an honest charge. Ten-Tec solves communications problems. If you have a special need, try us. We may have a cost effective solution. Your inquiry will be most welcome.

Ten-Tec manufactures communications electronics for non-amateur radio applications too. Some are custom designs for special applications and some are treated as catalog products.

PRECISION TOOL AND DIE SHOP. Almost in the "secret weapon" category is our in-house tool and die shop. For 20 years, we have been a supplier of superbly designed and crafted molds, forming dies and production jigs and fixtures for our own use as well as many other manufacturers throughout the region. Our well-equipped shop is staffed with toolmakers with many years of experience. You are not likely to be a customer for tools and dies but if your employer is, they may profit from discussing their needs with us. You do benefit from the design flexibility and "bottom line" economics resulting from this in-house capability.



HF-SSB TRANSCEIVER, MODEL 150 SERIES.

This is a 100 watt PEP transceiver that operates in the 2 to 12 MHz range. "No-tune" solid state design is ideal for non-technical operators. All modes. Primary power is 12/14 Vdc. Ideal for mobile or base operation. Excellent receive and transmit performance, channelized for simplicity, highly reliable, compact and weighs only 10 lbs.



HF-SSB MANPACK TRANSCEIVER, MODEL 120 SERIES.

The 120 Series is available in three models that operate in the 3 to 5 MHz, 5 to 8 MHz or 8 to 12 MHz bands, 20 watts PEP. The unit is powered by a self-contained re-chargeable ni-cad battery. Completely portable, small, lightweight (10 lbs including battery pack), all solid state, built-in antenna and channelized to customer specifications.

...America's Best!

TEN-TEC

Highway 411 East
Sevierville, TN 37862, U.S.A.
(615) 453-7172
Fax: 615-428-4483
Customer Service: 615-428-0364

**MADE IN
USA**