



**DATA MANAGEMENT UNIT**

**DMU-2000**

**OPERATING MANUAL**



Provided by   
YAESU museum   
  
Downloaded by   
RadioAmateur.EU

**VERTEX STANDARD CO., LTD.**  
4-8-8 Nakameguro, Meguro-Ku, Tokyo 153-8644, Japan

**VERTEX STANDARD**  
**US Headquarters**  
10900 Walker Street, Cypress, CA 90630, U.S.A.

**YAESU EUROPE B.V.**  
P.O. Box 75525, 1118 ZN Schiphol, The Netherlands

**YAESU UK LTD.**  
Unit 12, Sun Valley Business Park, Winnall Close  
Winchester, Hampshire, SO23 0LB, U.K.

**VERTEX STANDARD HK LTD.**  
Unit 5, 20/F., Seaview Centre, 139-141 Hoi Bun Road,  
Kwun Tong, Kowloon, Hong Kong

**VERTEX STANDARD (AUSTRALIA) PTY., LTD.**  
Normanby Business Park, Unit 14/45 Normanby Road  
Notting Hill 3168, Victoria, Australia

# TABLE OF CONTENTS

<b>Installation and Connection</b> .....	<b>1</b>
<b>Switches and Connectors</b> .....	<b>2</b>
<b>Please Read This First</b> .....	<b>4</b>
<b>Before Using an External Monitor</b> .....	<b>6</b>
About the DMU-2000 Data Management Operation .....	6
About Menu Mode Operation .....	8
About the Monitor Display .....	10
<b>How to Use the World Clock function</b> .....	<b>12</b>
About the World Clock .....	12
Explanation of the Function Keys on the World Map Screen .....	12
SET (LOCAL-TIME1) Setup .....	13
FORMAT (TIME FORMAT) Setup .....	13
City Selection .....	14
Miscellaneous World Clock Setup Options .....	15
OFF Timer and Alarm Setup .....	16
<b>Spectrum Scope</b> .....	<b>18</b>
About the Spectrum Scope .....	18
Explanation of the Function Keys on the Spectrum Scope Screen .....	18
Using the CTR (Center) Display Mode .....	20
Using the LBWS (Limited Band Width Sweep) Function .....	22
Using the FIX (Fixed) Mode .....	23
<b>Audio Scope and Oscilloscope</b> .....	<b>24</b>
About the Audio Scope and Oscilloscope .....	24
Explanation of the Function Keys on the Audio Scope and Oscilloscope Screen .....	24
Using the Audio Scope .....	25
Audio Scope Specifications .....	25
Using the Oscilloscope .....	26
Oscilloscope Specifications .....	26
<b>Log Book Function</b> .....	<b>28</b>
About the Log Book .....	28
Explanation of the Function Keys on the Log Book Screen .....	28
Log Book Example .....	29
CONFIG Setting .....	30
CONFIG SETTING Mode Setup .....	31
Log Book Data Input .....	32
Log Book Previous-QSO Check (CHECK) .....	33
Editing Log Book Entries .....	33
Saving Log Data .....	34
Loading Log Data (LOAD) .....	34
Summary Check .....	35
<b>Temperature / SWR Indication</b> .....	<b>36</b>
About the Temperature / SWR Indication .....	36
Explanation of the Function Keys on the Temperature / SWR Indication Screen .....	36
Graphic Meter Displays .....	37
Swept SWR Display .....	38
Using the Marker on the SWR Graph .....	39
<b>Great Circle Map / Rotator Control Function</b> .....	<b>40</b>
About the Great Circle Map / Rotator Control Function Screen .....	40
Explanation of the Function Keys on the Great Circle Map / Rotator Control Function Screen .....	40
Manual Mode .....	42
Preset Mode .....	43
Memory Mode .....	44
<b>Using the Memory Channel List</b> .....	<b>45</b>
About the Memory Channel List .....	45
Explanation of the Function Keys on the Memory Channel List Screen .....	45
Erasing a Memory Channel/Restoring an Erased Memory Channel .....	46
Saving Memory Data .....	46
Loading Memory Data .....	47
<b>Using the MENU Mode</b> .....	<b>48</b>
About the MENU Mode .....	48
Explanation of the Function Keys on the Menu Mode Screen .....	49
Menu Mode Configuration Changes .....	50
Menu Mode Reset .....	50
Saving Menu Configuration Data .....	51
Loading Menu Data .....	52

# INSTALLATION AND CONNECTION

1. Make certain that all cables are disconnected from the transceiver.
2. Referring to Figure 1, remove the three screws from each side of the transceiver, and three screws from the top edge of the rear panel. Slide the top cover toward to the rear about 1/2 inch (1 cm), then remove the top cover.
3. Refer to Figure 2 for the mounting location for the SCOPE Unit. Locate the 14-pin plug taped on the chassis. Remove the tape and remove the 14-pin plug from the chassis.
4. Mount the SCOPE Unit using the supplied four screws (Figure 3).
5. Referring to Figure 4, plug the 14-pin plug which was removed from the chassis in the previous step into the J7002 connector on the SCOPE Unit.
6. Locate the Coaxial plugs (labeled ⊙ and ⊕) installed in jacks (J4508 and J4507) on the RX-2 Unit. Unplug the Coaxial plug (⊙) from the RX-2 Unit and plug it into the J7003 on the SCOPE Unit. Unplug the Coaxial plug (⊕) from the RX-2 Unit and plug it into the J7001 on the SCOPE Unit (Figure 4).
7. Replace the top cover and its nine screws.
8. Assemble the transceiver, Data Management Unit, after-market Display, and after-market Keyboard (if used) pursuant to Figure 5.

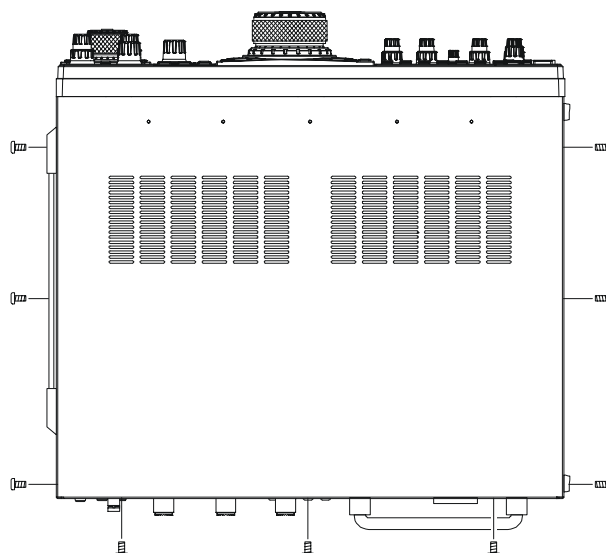

Figure 1

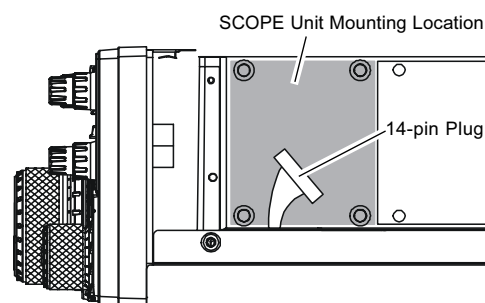

Figure 2

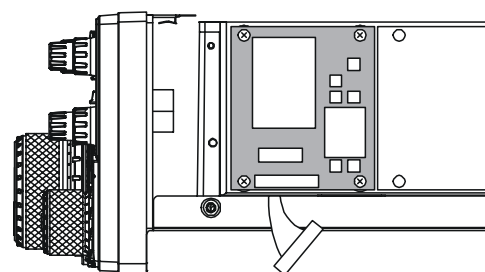

Figure 3

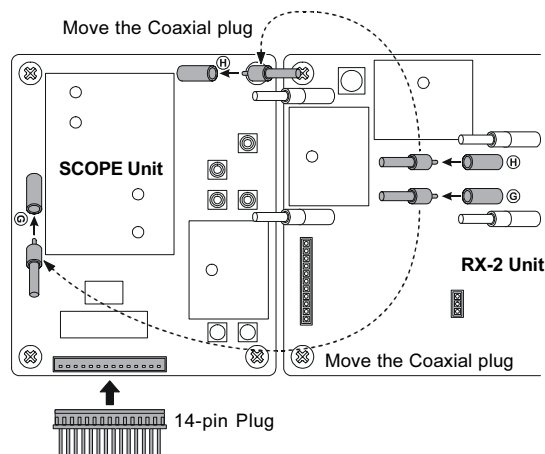

Figure 4

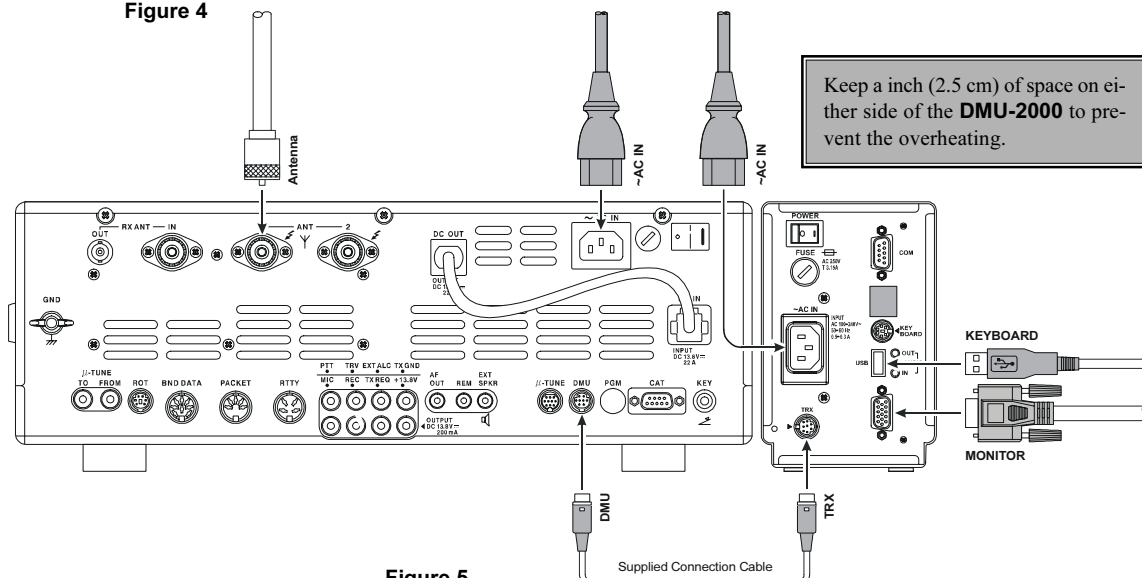
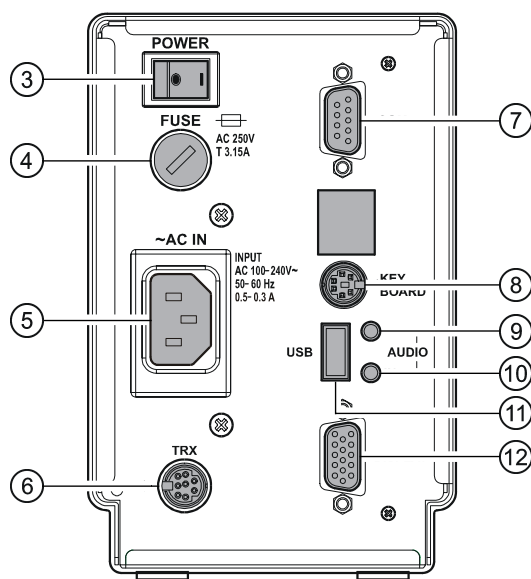
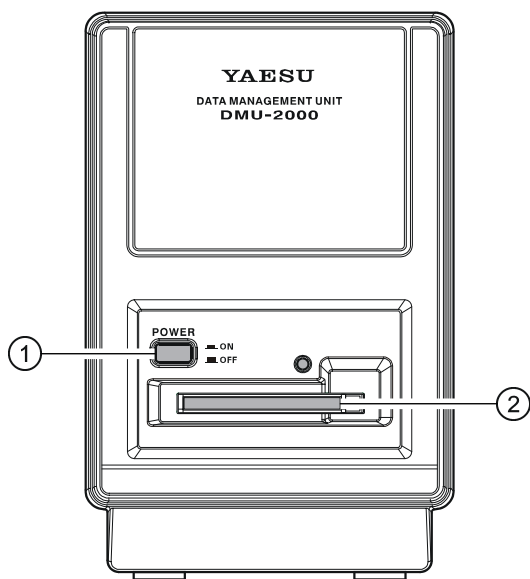

Figure 5

# SWITCHES AND CONNECTORS



## ① POWER Switch

Press this switch to turn the Data Management Unit on, after first setting the rear panel **POWER** switch to the “I” position. Press this switch again to turn the Data Management Unit off. If the rear panel’s **POWER** switch is set to the “O” position, the front panel **POWER** switch will not function.

## ② CF Card Slot

This slot accepts the supplied Compact Flash (CF) Card, which allows storage, transfer, and recall of transceiver configuration data and operator preferences, along with Log Book data, etc. When the CF Card is successfully inserted, the red LED by the slot will light up.

To remove the card out from slot, press the small push-button at the right hand side of the slot.

**Advice:** If you get the “CF CARD IS NOT READY” error message on the after-market monitor, check the position of the CF Card in the slot for proper alignment.

## ③ Main POWER Switch

This is main power On (I)/Off (O) switch of the Data Management Unit. Always turn this switch on before turning on the front panel’s [POWER] button.

If this switch is not turned On, the front panel [POWER] switch will not function.

## ④ FUSE

This holder requires a 3.15-A fuse. Always use the 3.15 Amp fuse, whether operating on 100 - 120 VAC or 200 - 240 VAC.

Provided by  [YAESU museum](#)   
  
 Downloaded by  [RadioAmateur.EU](#)

## ⑤ ~AC IN Jack

Connect the supplied 3-wire AC line cord to this socket after ensuring that your AC mains voltage matches that on the label. See the Installation section for instructions on how to change the internal switching power supply AC mains voltage, if necessary.

## ⑥ TRX Jack

Connect this 8-pin MINI-DIN jack to the **DMU** jack on the **FT-2000** transceiver, using the supplied control cable.

## ⑦ COM Jack

Connect a after-market GPS receiver capable of supplying NMEA data to this jack. The data line connects to Pin 2, and the ground shield connects to Pin 5.

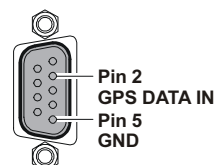

When you connect the GPS receiver to this jack, the “Rotator” page on the after-market monitor will automatically include a Great Circle map centered on your location. The **DMU-2000** can support the GGA, GLL, and RMC Data Sentences from the GPS receiver.

## ⑧ KEY BOARD Jack

Connect your keyboard (not supplied) to one of these jacks in accordance with your keyboard type (“USB” or “PS/2”) to use the Smart Memory Card for storage of logbook data, and for input of your location when setting up the World Clock.

## ⑨ AUDIO OUT Jack

This jack is for future expansion of the Data Management Unit’s capabilities, but at this time it is not supported.

# SWITCHES AND CONNECTORS

## ⑩ AUDIO IN Jack

This jack is audio signal input for the Audio Scope display of the **DMU-2000**.

You can observe the audio wave of a signal provided by equipment connected to this jack.

## ⑪ USB Jack

This jack supports the USB 1.1 protocol, for connection of a USB keyboard.

**Note:** Other types of USB-related accessories (other than a keyboard) are not supported by this jack, and must not be connected here.

## ⑫ DISPLAY Jack

Connect an external monitor (not supplied) to this jack.

### SPECIFICATIONS

<b>Supply Voltage:</b>	100 VAC ~ 240 VAC, 50/60 Hz (Universal)
<b>Power Consumption (Approx.):</b>	50 VA
<b>Dimensions (WxHxD):</b>	3.9" x 5.3" x 13.8" (100 x 135 x 350 mm)
<b>Weight (Approx.):</b>	6.8 lbs (3.1 kg)

### PACKAGING LIST

DMU-2000	1 pc	Connection Cable	1 pc	T9101560	
SCOPE Unit	1 pc	Spare Fuse	1 pc	Q00000096 (3.15A)	
CF Card	1 pc	Q9000855 (128 MB)	Screws	4 pcs	U03306002 (ASM3X6NI)
AC Power Cord	1 pc	T9017882: USA	Operation Manual	1 pc	
		T9013285: Europe	Warranty Card	1 pc	
		T9013283A: Australia			

# PLEASE READ THIS FIRST



When turning on the transceiver for the first time, please set the local time as soon as possible. If this is not done, the various functions of the World Clock and Great Circle Map will not function correctly.

**Note:** If you wish to add a city to the City List that was programmed at the factory, you will need to supply your own USB or PS/2 Keyboard. If you utilize one of the pre-loaded cities, a keyboard is not necessary.

You may also set up the local time for other locations, without a keyboard, using the cities that have been pre-loaded at the factory.

Please note that there are four power switches that must be turned on in order for the operation. They are (1) main power switch of the transceiver, (2) actual power switch of the transceiver, (3) main power switch of the Data Management Unit, and (4) actual power switch of the Data Management Unit. This Data Management Unit must be turned on before pressing the power switch on the front panel of the transceiver.

## 1. TURNING THE TRANSCEIVER ON

- To turn the transceiver on, first press the main [POWER] switch (so that the “I” side is pressed downward). In the **FT-2000** (100 W version), the main [POWER] switch is on the right side of the rear panel. For the **FT-2000D** (200 W version), the Main [POWER] switch is located on the front panel of the **FP-2000**.  

- Hold in the front panel [POWER] switch to turn the transceiver on.  

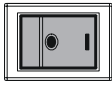
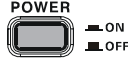
## 2. TURNING THE DMU-2000 ON

- To turn the Data Management Unit on, first press the main [POWER] switch (so that the “I” side is pressed downward) on the rear panel, then press the front panel [POWER] switch to turn the Data Management Unit on.  
  

**Note:** The opening screen will appear on the after-market monitor and the self-check function of the CPU inside the Data Management Unit will begin. When the Data Management Unit is turned on for the first time, it takes about 50 seconds (for self-checking) until the Data Management Unit becomes ready to use; however, from the next time you turn it on, it will take around 10 seconds until the Data Management Unit is ready for full operation.

### Note

In the discussion to follow, reference will be made to various “Function” keys (for example, [F1(MAP)]). This nomenclature refers to the [F1(CH-1)] ~ [DISPLAY] keys located along the bottom left edge of the front panel of the **FT-2000**. The exact function of each key will depend upon the “Page” of the display being viewed on the monitor; therefore, when using the World Map page, [F1(MAP)] represents the pressing of the [F1(CH-1)] key, with “MAP” being the function appearing in the “F1” position at the bottom edge of the monitor screen.

## 3. LOCAL TIME SETUP

- If you press and hold in the [DISPLAY] key for more than two seconds, white letters will appear at the bottom of the screen to indicate various functions, and the **FT-2000**'s [F1(CH-1)] ~ [F7(P.BACK)] and [DISPLAY] keys will act as “Function” keys.
- On the monitor, there should be a World Map displayed; if the World Map does not appear, find the [F1(MAP)] key on the front panel of the **FT-2000**; press this key to get the World Map to display on the monitor.

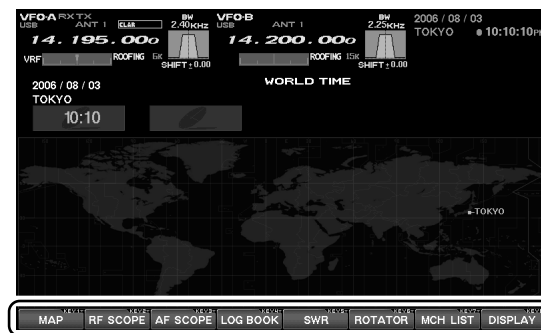

FUNCTION TABS

- Press the [DISPLAY] key to change the action of the “Function” keys, then press the [F1(SET)] key; the monitor should now show “LOCAL TIME-1;” this setting has been pre-set for Japanese time at the factory.



## 4. CHANGING THE LOCATION

### (1) Using the World Map

- Choose (highlight) the “ZONE” using the [F1(▼)] ~ [F4(▶)] keys, then press the [F7(SELECT)] key.
- The name of the country associated with the highlighted Time Zone may now be selected using the [F1(▼)] ~ [F4(▶)] keys. Press the [F7(SELECT)] key when you have made your selection.
- You may now choose one of the cities displayed in the same way. When you have made your choice, press the [F7(SELECT)] key.

**Advice:** Depending on the country, there may be only one city (or no cities) listed. In these instances, to modify the setting, please first select the city name on the list, even if you do not see the city you want on the list; you may modify the city name later.

### (2) Using the Longitude/Latitude Data

If you know a Longitude/Latitude of the your location, you may set the location from the Longitude/Latitude data.

- Press the [F6(LON/LAT)] key. The display changes as follows.



- Press the [F7(SELECT)] key, then enter the Longitude using the [F1(▼)] ~ [F4(▶)] keys. Use the [F3(◀)] and [F4(▶)] keys to navigate to each column, then use the [F1(▼)] and [F2(▲)] keys to select the desired numbers in each column.

**Note:** The Longitude data is input in decimal form. The seconds may also be input in sexagenary form. For example, if you want to input 138 degree 28 minutes 15 seconds,

1. Input “13828.00” by using [F1(▼)] ~ [F4(▶)] keys.
  2. Press [F4(▶)] key and move the cursor to the right side of the column.
  3. Input “15.”
  4. Press [F7(SELECT)] key, and the numeric (second) will be converted to the decimal number and the Longitude input is completed.
- When entry is complete, press the [F7(SELECT)] key again.
  - Choose (highlight) “LAT” using the [F1(▼)] ~ [F4(▶)] keys, then press the [F7(SELECT)] key.
  - Enter the Latitude in the same manner as described above.
  - When entry is complete, press the [F7(SELECT)] key again.

### (2) Using the GPS Receiver

If you connect the GPS receiver (not supplied) to the COM jack on the rear panel, your location (Longitude/Latitude) is set automatically.

- Press the [F6(LON/LAT)] key. The display will indicate the Longitude/Latitude of your location.
- Press the [F5(GPS)] key to re-read the GPS data.



## 5. CHANGING THE CITY NAME

*(Please connect a PS/2 or USB Keyboard (not supplied) to do manual entry of a city name. If you are not entering a new city name, please skip to step (6) below.)*

- Use the [F1(▼)] and [F2(▲)] keys to highlight the “CITY,” then press the the [F7(SELECT)] key. Enter the name of the desired city.



- When you have completed your input, press the [F7(SELECT)] key once more.

# PLEASE READ THIS FIRST

## 6. CORRECTING THE DATE

- ❑ Use the [F1(▼)] and [F2(▲)] keys to highlight “DATA,” then press the [F7(SELECT)] key.
- ❑ Use the [F3(◀)] and [F4(▶)] keys to navigate to each column of the date, then use the [F1(▼)] and [F2(▲)] keys to select the desired numbers in each column. Repeat for each column, to complete the date.



- ❑ When entry is complete, press the [F7(SELECT)] key.

## 7. TIME SETTING

- ❑ Press the [F1(▼)] and [F2(▲)] keys to highlight “TIME,” then press the [F7(SELECT)] key to enter the time entry mode.
- ❑ Use the [F3(◀)] and [F4(▶)] keys to navigate to the desired column in the date, then use the [F1(▼)] and [F2(▲)] keys to select the desired number in each column. Time is entered in 24-hour format.



- ❑ When entry is complete, press the [F7(SELECT)] key.

## 8. SETTING UP DAYLIGHT SAVING TIME

- ❑ Once you have selected the city to be utilized, use the [F1(▼)] and [F2(▲)] keys to highlight “DST” (DAYLIGHT SAVING TIME).
- ❑ Use the [F3(◀)] and [F4(▶)] keys to choose “ON” or “OFF.”

## 9. SAVING AND CLOSING

- ❑ When you have completed all the above entries to your satisfaction, press and hold in the [F7(SELECT)] key for two seconds to save all the new settings. The chosen city and time zone will appear on the World Map page.

*Note:* The [F1(SET)] key is only used when setting the city name and local time. If you make a mistake, press the [F7(SELECT)] key for 2 seconds. Pressing the [F7(SELECT)] key for two seconds will return you to the World Map screen.





# BEFORE USING AN EXTERNAL MONITOR

## ABOUT DMU-2000 DATA MANAGEMENT UNIT OPERATION

A number of informative and useful displays will appear on the after-market monitor which is connected to the DISPLAY terminal on the DMU-2000 rear panel. These include the World Clock, Spectrum Scope, Audio Scope and Oscilloscope, Log Book, Temperature and SWR indications, Rotator Control with a Great Circle Map, and Memory Channel List. These various “pages” may be selected by pressing the [F1(MAP)] ~ [F7(MCH LIST)] keys. Please see Page three.

1. Press and hold in the [DISPLAY] key for at least two seconds.

White letters will appear at the bottom of the screen to indicate various functions, and the [F1(CH-1)] ~ [F7(P.BACK)] and [DISPLAY] keys will act as “Function” keys.

If you once more press and hold in the [DISPLAY] key for at least two seconds, the white-lettered tabs will disappear, and control of the various functions will be cut off; the [F1(CH-1)] ~ [F7(P.BACK)] and [DISPLAY] keys will no longer act as “Function” keys.

2. If you press the one of the [F1(MAP)] ~ [F7(MCH LIST)] keys momentarily, each press will bring up a new display page.

If you do not want to change the setting, or if you wish to suspend the setting procedure, press the [DISPLAY] key. Any changes you started will not be saved, and the screen will move forward to the next display.

On each screen, the action of the function key may vary. At the bottom area of the screen, the function is indicated; please confirm the function displayed as you read along.

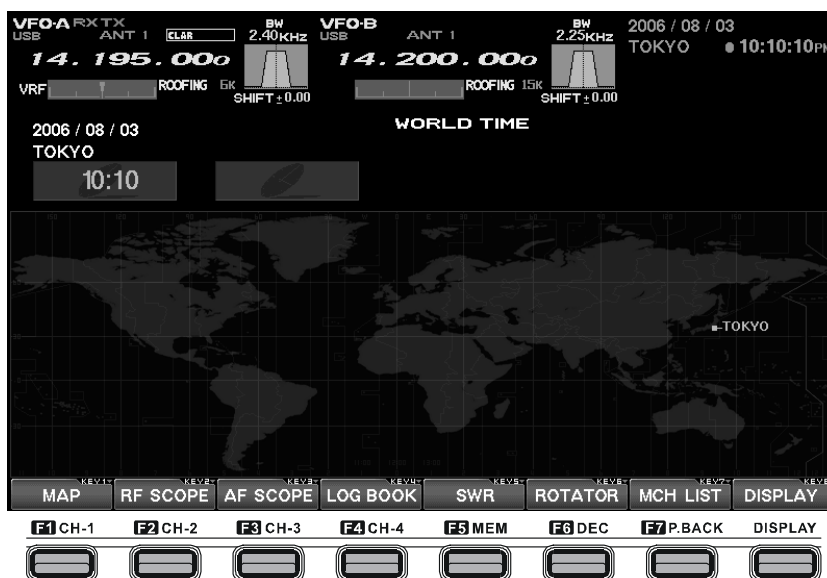
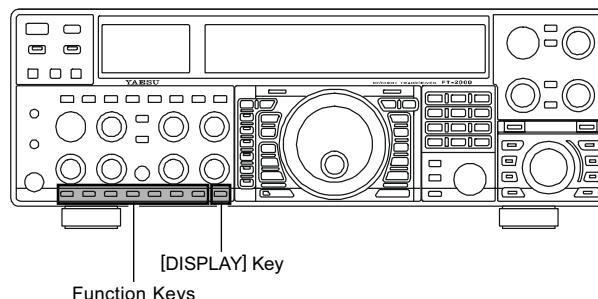

# BEFORE USING AN EXTERNAL MONITOR

## ABOUT DMU-2000 DATA MANAGEMENT UNIT OPERATION



Press and hold in the [DISPLAY] key (2 sec.)

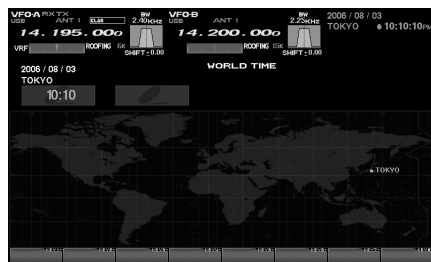

The white-lettered tabs are disappear

Press the [F1(MAP)] key

Press the [F2(RF SCOPE)] key

Press the [F3(AF SCOPE)] key

Press the [F4(LOG BOOK)] key

Press the [F5(SWR)] key

Press the [F6(ROTATOR)] key

Press the [F7(MCH LIST)] key

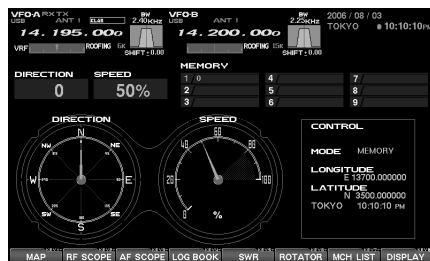

"ROTATOR CONTROL" Screen

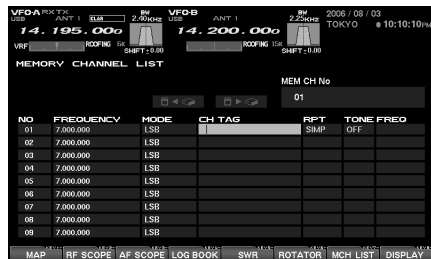

"MEMORY CHANNEL LIST" Screen

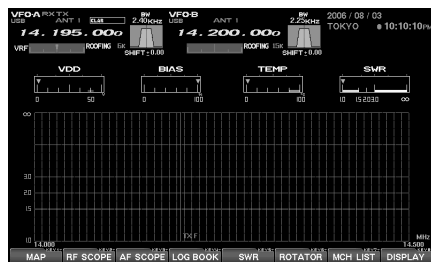

"SWR MONITOR" Screen

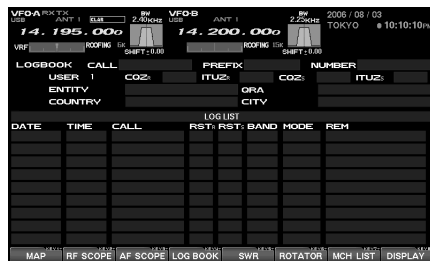

"Log Book" Screen

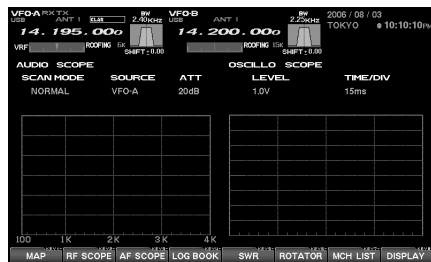

"AUDIO SCOPE / OSCILLO SCOPE" Screen

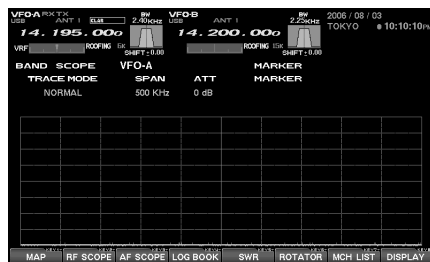

"SPECTRUM SCOPE" Screen

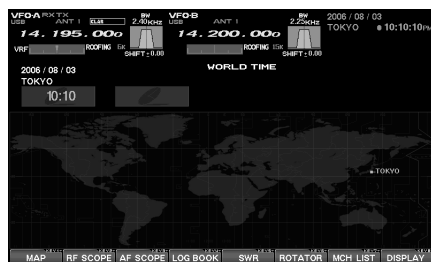

"WORLD CLOCK" Screen

# BEFORE USING AN EXTERNAL MONITOR

## ABOUT MENU MODE OPERATION

The Menu mode's various selections and parameters can be displayed on the external monitor. For details on menu operation, please see the discussion below.

### ENTERING THE MENU MODE

1. If you press and hold in the **[DISPLAY]** key for more than two seconds, white letters will appear at the bottom of the screen to indicate various functions, and the **[F1(CH-1)]** ~ **[F7(P.BACK)]** and **[DISPLAY]** keys will act as "Function" keys.

If you once more press and hold in the **[DISPLAY]** key for at least two seconds, the white-lettered tabs will disappear, and control of the various functions will be cut off; the **[F1(CH-1)]** ~ **[F7(P.BACK)]** and **[DISPLAY]** keys will no longer act as "Function" keys.

2. Press the **[MENU]** button momentarily. The Menu list will appear on the after-market monitor, and you will see the Menu Number, Menu Groups, Menu Items, and the current settings for each item display on the monitor.
3. Rotate the Main Tuning Dial knob (or press the **[F6(▼)]** and **[F7(▲)]** keys) to select the Menu item you wish to work on.
4. Rotate the **[SUB VFO-B]** knob (or press the **[F4(◀)]** and **[F5(▶)]** keys) to change the current setting of the selected Menu item.
5. When you have completed the changes to the Menu item(s), press and hold in the **[MENU]** button for 2 seconds; the setting(s) will now be saved.

If you do not want to save the new setting, press the **[MENU]** button momentarily; the radio will revert to its previous condition.

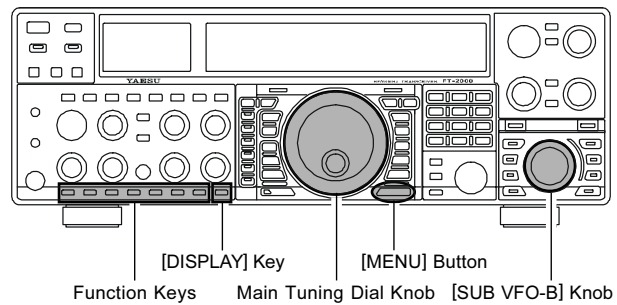

# BEFORE USING AN EXTERNAL MONITOR

## ABOUT MENU MODE OPERATION

There are 147 items in the Menu mode, and they are grouped; the group name is displayed at the left top of the list screen. It will be convenient for you if you initially select the group, by rotating the Main Tuning knob, and *then* select the item you want.

The groups are as follows.

- AGC:**  
Setup of the AGC performance
- DISPLAY:**  
Setup of the configurations of the display
- DVS:**  
Setup of the input/output level of the voice memory
- KEYER:**  
Setup of the configurations of the internal electric keyer
- GENERAL:**  
Setup of the configurations of the General feature
- S IF SHIFT:**  
Setup of the center frequency of the Sub band (VFO-B) receiver's IF filter
- MODE-AM, MODE-CW, MODE-DAT, MODE-FM, MODE-RTY, MODE-SSB**  
Setup of the configurations of the each operating mode
- RX AUDIO:**  
Setup of the RX DSP Filter bandwidth and headphone
- RX DSP:**  
Setup of the RX DSP Filter bandwidth and shaping
- SCOPE:**  
Setup of the starting frequency for the Spectrum Scope
- TUNING:**  
Setup of the Dial steps
- TX AUDIO:**  
Setup of the Parametric Microphone Equalizer
- TX GNRL:**  
Setup of the configurations of the General feature for the transmitter

For detailed information regarding the Menu mode, please see the "How to Use the Menu Mode" section of this manual, and the operating manual of the radio.

### MENU MODE RESET

It is possible to reset (only) the Menu mode settings back to their factory default. Do this if you want to clear all settings out, and start fresh with the original values.

1. Turn off the radio.
2. Turn the radio on while pressing and holding in the **[MENU]** button.

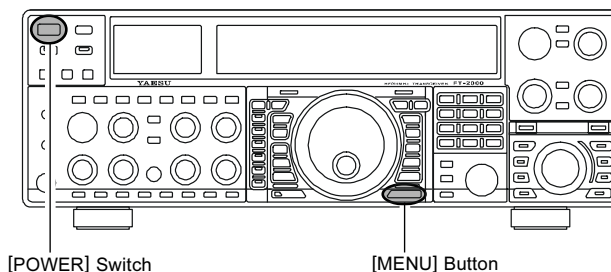

# BEFORE USING AN EXTERNAL MONITOR

## ABOUT THE MONITOR DISPLAY

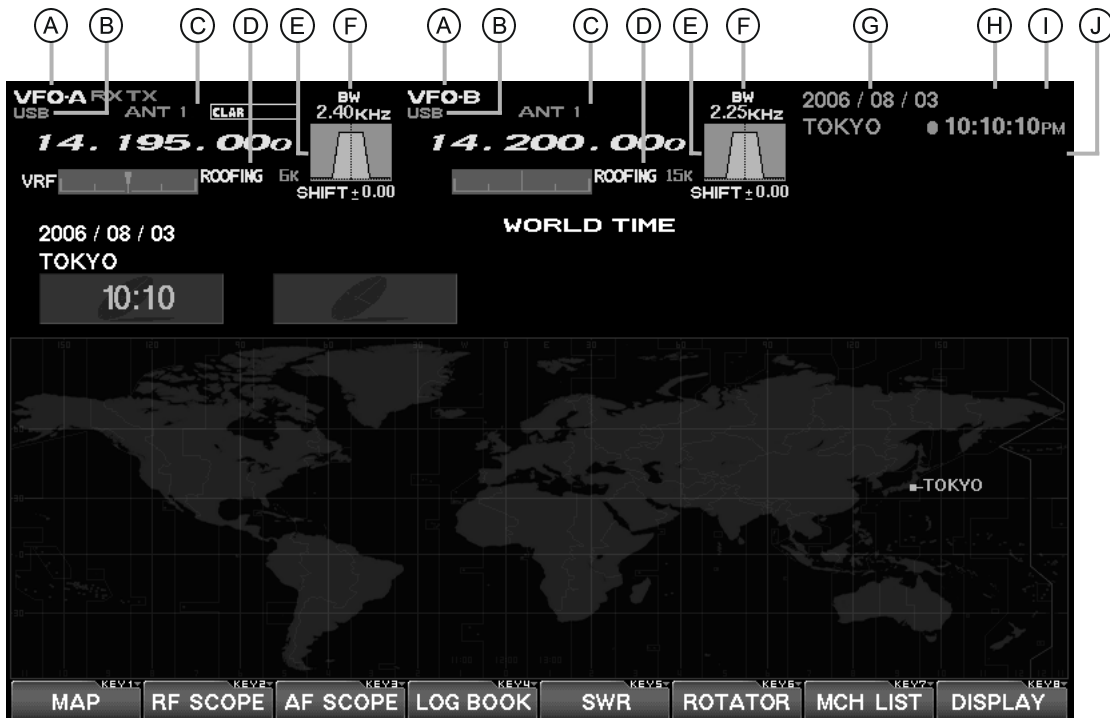

### Ⓐ Main (VFO-A) & Sub (VFO-B) Fields

These areas of the Display contain information about the status of the Main (VFO-A) and Sub (VFO-B) VFOs.

### Ⓑ MODE Fields

These fields indicate the operating mode in use on the above VFOs.

### Ⓒ TX Frequency/Clarifier/ Antenna Selection Fields

These notations advise which VFO is being used for transmission, status of the Clarifier, and a notation of which antenna has been selected on that VFO.

### Ⓓ Filter Fields

These fields note the offset status for the  $\mu$ -Tuning or VRF filters, as well as the Roofing filter selection, for each VFO.

### Ⓔ Filter Shift Fields

These fields graphically depict the positions of the DSP RX filters for the Main and Sub VFOs, indicating any “IF Shift” or “Width” tuning changes applied.

### Ⓕ Bandwidth Fields

This field indicates the net receiver bandwidth currently set for the Main (VFO-A) and Sub (VFO-B) VFOs.

### Ⓖ Date Field

The current date is displayed here.

### Ⓗ Local Time-1 Field

The current time at your location (Local Time-1) is displayed here.

### Ⓘ GPS Field

If you have connected an after-market GPS unit (one providing NMEA location data) to the rear panel of the transceiver, “GPS” icon (Base color is white) will appear here. When display the your location on a World Map with the GPS data, a base color of the “GPS” icon turns into yellow.

### Ⓙ Local Time-2 Field

The Local Time-2 time, as programmed, will appear here.

# BEFORE USING AN EXTERNAL MONITOR

## ABOUT THE MONITOR DISPLAY

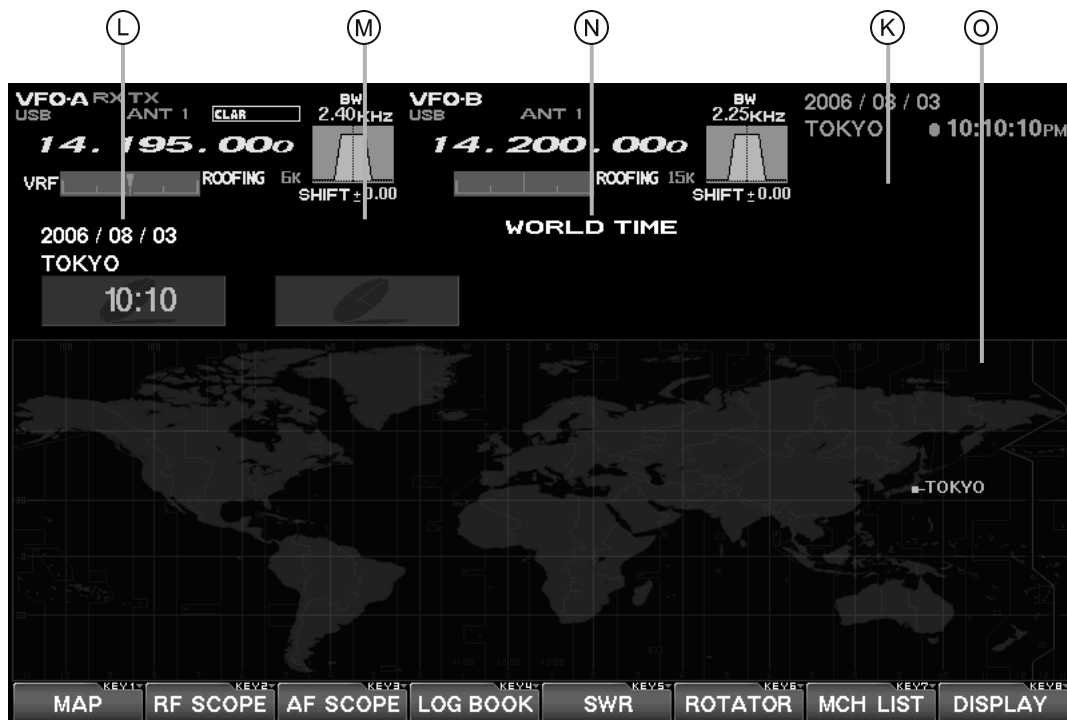

### Ⓚ Timer Field

When the On Timer has been engaged, “TIMER” will appear here; when the Alarm has been engaged, “ALARM” will appear in this field.

### Ⓛ Local Time-1 Field

The current time at your location (Local Time-1) is displayed here.

### Ⓜ Local Time-2 Field

The Local Time-2 time, as programmed, will appear here.

### Ⓝ World Time Field

This area shows the current time at the city selected on the World Map display.

### Ⓞ Display Pages

Individual pages are provided for a wide variety of information or command purposes. Included are the World Clock page, Spectrum Scope page, Audio Scope and Oscilloscope page, Log Book page, Temperature and SWR indications page, Rotator Control with a Great Circle Map page, Memory Channel List page, and the Menu page.

# HOW TO USE THE WORLD CLOCK

## ABOUT THE WORLD CLOCK

The World Clock displays the time in various countries, and the day/night areas are also indicated on the map, including the Grey Line near the terminator. The difference between the daylight areas in the Southern and Northern Hemispheres is displayed correctly, and is updated in real time. For DX hunting, this can be a very important and convenient tool for specific long distance HF QSOs, for example, as you can target the time the other station might have access to, say, the 80-meter band, enabling you to complete a QSO. In addition, an alarm is provided which beeps with respect to a designated area at a designated time, and the auto-off timer can also be matched to any desired area you stipulate.

**Note:** When you turn on the Data Management Unit for the first time after your purchasing, please set the Local Time (the place where you operate this radio), and confirm this setting. If this is not done, the various functions of the World Clock and Great Circle Map will not function correctly. Regarding the setting of the Local Time, please see the “PLEASE READ THIS FIRST” information.

If the “World Map” screen does not initially appear, press the **[DISPLAY]** key to switch the Function key’s function to “Page Select Key,” then press the **[F1(MAP)]** key momentarily to display the “World Map” screen. Next, press the **[DISPLAY]** key again to switch the Function key’s function to the “Function Key.”

## EXPLANATION OF THE FUNCTION KEYS ON THE WORLD MAP SCREEN

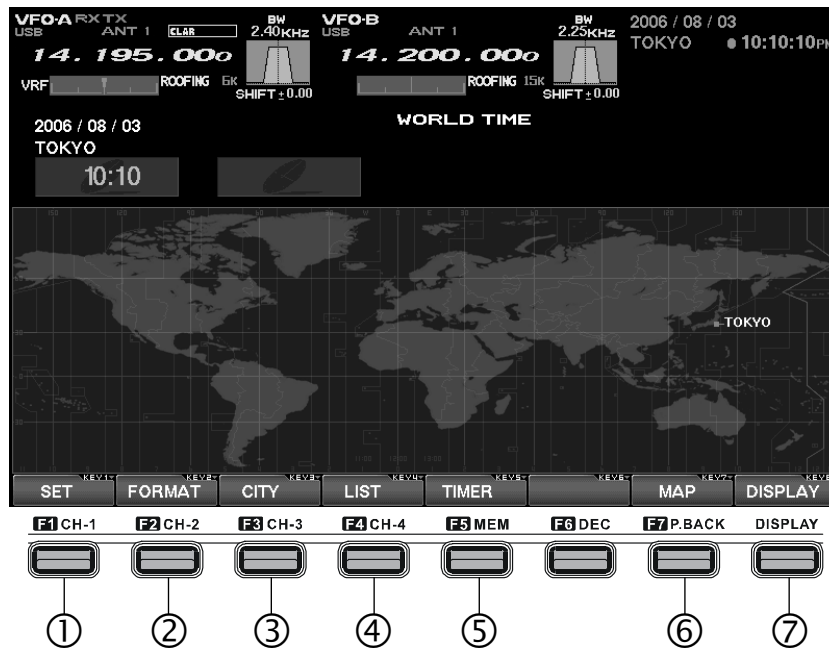

- ① **[F1(SET)]** Key  
Selects the LOCAL TIME-1 setup screen.
- ② **[F2(FORMAT)]** Key  
Selects 12-hour or 24-hour time format.
- ③ **[F3(CITY)]** Key  
Selects the World Map for City selection.
- ④ **[F4(LIST)]** Key  
Displays the City setup list.
- ⑤ **[F5(TIMER)]** Key  
Selects the TIMER setup screen.
- ⑥ **[F7(MAP)]** Key  
This lets you select between the World Map regular screen and the map that includes Daylight/Darkness display.
- ⑦ **[DISPLAY]** Key  
Press this key momentarily to switch the Function key’s function between the “Page Select Key” and the “Function Key.”  
Press and hold in this key to disable the Function keys (except this key).



# HOW TO USE THE WORLD CLOCK

## SET (LOCAL-TIME1) SETUP

Please see the “PLEASE READ THIS FIRST” information (Page 4).

## FORMAT (TIME FORMAT) SETUP

This procedure lets you choose between 12-hour and 24-hour time display format.

1. While the World Map is displayed, press the [F2(FORMAT)] key to select the “TIME FORMAT” screen.
2. Press the [F1(▼)], [F2(▲)], [F3(◀)], [F4(▶)] keys, and select 12-hour or 24-hour display for “LOCAL-TIME1,” “LOCAL-TIME2,” and the “WORLD CITY LIST.”

When “SEC” is set to “ON”, the “seconds” digits will be shown at the top right corner of the after-market monitor, in the Local Time indication area.

*Advice:* If you press the [F6(SECADJ)] key, the “seconds” indication will reset to “00.” Use this to sync your clock to a time standard such as WWV.

3. When all settings are complete, press and hold in the [F7(SELECT)] key for 2 seconds to exit.



↑  
[F2(FORMAT)] Key

↓



“SELECT” Keys

↑  
[F6(SECADJ)] Key  
Set to “00” Second

Provided by   
YAESU museum   
  
Downloaded by    
RadioAmateur.EU

# HOW TO USE THE WORLD CLOCK

## CITY SELECTION

It is possible to select any city name which is displayed on the World Clock screen.

**Advice:** The order of the display of the cities can be changed later; for now, please just select one of the supplied city names.

There may only be one city shown in some countries; however, it is possible to add cities, if desired.

If you wish to add a city to the City List that was programmed at the factory, you will need to supply your own USB or PS/2 Keyboard. If you utilize one of the pre-loaded cities, a keyboard is not necessary.

1. Press the **[F3(CITY)]** key while the World Map is displayed, and the Display will show the “Area Selection” screen.
2. Press the **[F1(▼)]**, **[F2(▲)]**, **[F3(◀)]**, **[F4(▶)]** keys to select the continent in which the desired city is located.
3. Confirm that the desired area is highlighted, and press the **[F7(SELECT)]** key momentarily. Now the country list for the selected continent will be displayed.
4. Use the **[F1(▼)]**, **[F2(▲)]**, **[F3(◀)]**, **[F4(▶)]** keys to select the desired country in this area.
5. Now press the **[F7(SELECT)]** key momentarily, and you will see the list of the city names in the country selected.
6. Press the **[F1(▼)]**, **[F2(▲)]**, **[F3(◀)]**, **[F4(▶)]** key to select the desired city. Even if the city displayed is the only one in the country, select it anyway.
7. Once you have pressed the **[F7(SELECT)]** key momentarily, the selected country name and the city name will be indicated, thanks to the procedure mentioned above. If you want to input a city name which is not in the list, press the **[F7(SELECT)]** key after confirming that the city name is highlighted. Then, enter the city name you want.
8. Press the **[F1(▼)]**, **[F2(▲)]**, **[F3(◀)]**, **[F4(▶)]** key to set “**DAYLIGHT SAVING TIME (Summer Time)**,” “**DISPLAY MAP**” (display or not display city names on the World Clock screen), or “**HIGHLIGHT**” (select highlighted indication (yellow) or normal (white) indication).
9. When finished, press and hold in the **[F7(SELECT)]** key for 2 seconds to exit.



“AREA SELECTION” SCREEN



↑  
**[F7(SELECT)]** Key



“COUNTRY SELECTION” SCREEN



↑  
**[F7(SELECT)]** Key



“CITY SELECTION” SCREEN

↑  
**[F7(SELECT)]** Key

# HOW TO USE THE WORLD CLOCK

## MISCELLANEOUS WORLD CLOCK SETUP OPTIONS

It is possible to change the order of selection of the city times, as well as the display color, etc.

1. On the World Map Screen, press the [F4(LIST)] key to select the “City Name List” screen.
2. If you want to change the order of the city times as indicated at the middle of the Display screen, press the [F1(▼)] or [F2(▲)] keys to move the cursor to the city name you want to change the position of. When the [F6(DOWN)] key is pressed, the position goes downward. If you need to move it further, repeat as necessary.
3. If you want to change other settings of a city, select the city name by pressing the [F1(▼)] or [F2(▲)] keys to highlight the city, then press the [F7(SELECT)] key momentarily. Now the screen will change to the city setup screen, where the following settings can be done: “DAYLIGHT SAVING TIME” (to select Summer time), “DISPLAY MAP” (display or not display city names on the World Clock screen), and “HIGHLIGHT” (select yellow or white highlighting indication for cities).
4. If you want to delete a city from the World Clock screen, move the cursor to the city name by pressing the [F1(▼)] or [F2(▲)] keys, then press the [F4(DEL)] key.
5. When finished, press and hold in [F7(SELECT)] for 2 seconds to exit.

**Advice:** On the “DISPLAY MAP” setting, if the city name indication is selected, the city name will be displayed on the World Map. When “NO” is selected, the city name will not be displayed, and only the city name and the current time is indicated at the middle of the Display screen.

For the “HIGHLIGHT” setting (city name: highlighted or not highlighted), if “Highlight” (YES) is selected, the city name on the world map will be shown in yellow font color. If “NOT Highlighted” (NO) is selected, the city name will be indicated in white.



[F4(LIST)] Key

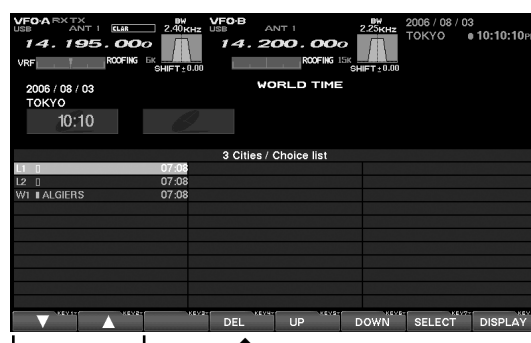

“SELECT” Keys [F4(DELETE)] Key

# HOW TO USE THE WORLD CLOCK

## OFF TIMER AND ALARM SETUP

It is easy to set the OFF Timer and Alarm times.

As to the OFF TIMER, countdown intervals of 120/90/60/30/15 minutes, and OFF, can be selected.

For the alarm setting, it is possible to choose either LOCAL-TIME1 or LOCAL-TIME2, set the alarm time, set the Alarm ON or OFF, and/or sound the alarm one time only or every day.

1. On the World Map screen, press the [F5(TIMER)] key to move to the OFF TIMER and ALARM setup screen.
2. Press the [F1(▼)], [F2(▲)], [F3(◀)], [F4(▶)] key to move the cursor to the desired setup item; the selected item will be highlighted.

### OFF TIMER setup:

120/90/60/30/15 minutes, and OFF

### ALARM setup:

(When setting up the Alarm, be sure to set the OFF TIMER setting to OFF!)

TIME ZONE (LOCAL TIME-1/LOCAL TIME-2)

ALARM TIME

ALARM ON/OFF

CYCLE (ONCE/DAILY)

3. Press and hold in [F7(SELECT)] for 2 seconds to close and exit.

**Advice:** When the OFF timer is engaged (power is shut off), the condition of the radio is the same as if the power switch on the front panel has been turned off. The Main power (circuit breaker) is not turned off.

The Alarm will ring for around 60 seconds. If you want to stop the alarm, press any of the keys located on the front panel.



“OFF TIMER AND ALARM SETUP” SCREEN



## ABOUT THE SPECTRUM SCOPE

This page displays the Spectrum Scope which is convenient for monitoring band activity.

The entire screen will become the spectrum display, and you can see both strong and weak signals clearly and easily on the Main (VFO-A) band.

Furthermore, the LBWS function allow you to realize very high-speed signal detection over a limited band segment. The CTR mode let you monitor close by your current frequency (your frequency is located at the center of the screen), and the FIX mode can also be engaged, whereby the left edge frequency is fixed. These features have been carefully considered for their utility in actual Amateur Radio operation.

If the “Spectrum Scope” screen does not initially appear, press the [DISPLAY] key to switch the Function key’s function to “Page Select Key,” then press the [F2(RF SCOPE)] key momentarily to display the “Spectrum Scope” screen. Next, press the [DISPLAY] key again to switch the Function key’s function to the “Function Key.”

**Quick Point:** The vertical axis of the Spectrum Scope is 10 dB per division.

During transmission, the transmitter’s waveform will be displayed.

## EXPLANATION OF THE FUNCTION KEYS ON THE SPECTRUM SCOPE SCREEN

The functions of the individual function tabs will change, depending on the display page being viewed. Therefore, carefully inspect each tab as you change pages, to ensure you are performing the correct and desired function.

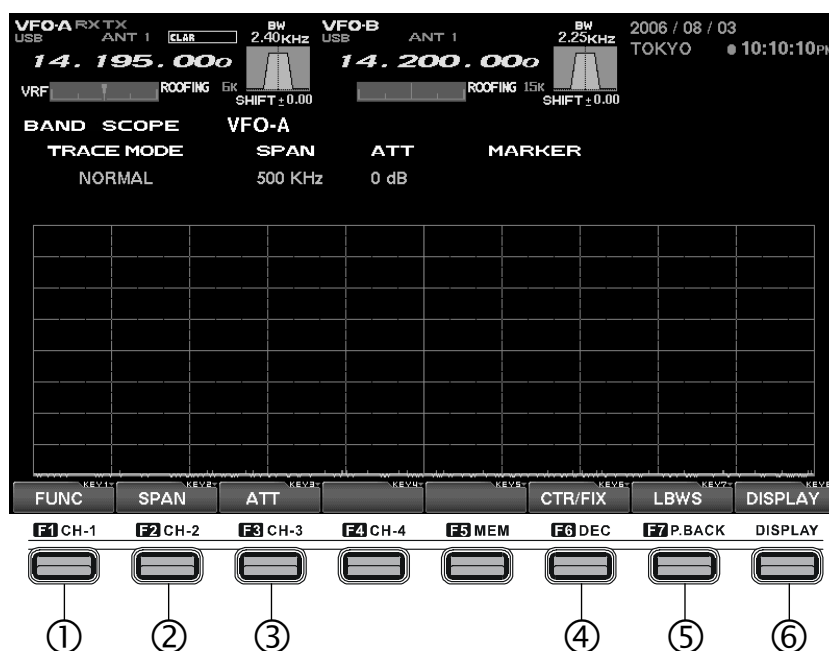

### ① [F1(FUNC)] Key

Moves you to the function screen of the Spectrum Scope used for setup of the MKR (Marker) function, etc.

**Advice:** On this screen, the functions assigned to the function keys can be changed. If you want to go back to the previous screen, press the [F7(EXIT)] key.

### ② [F2(SPAN)] Key (Bandwidth)

By pressing this key momentarily, it is possible to set the range of frequencies from the left edge to the right edge. If the setting is toggled to 2500 kHz, and you press this key once more, the span returns to 25 kHz again. At the top of the screen, the current span is indicated below the span indication.

25 kHz → 50 kHz → 100 kHz → 250 kHz →  
500 kHz → 1000 kHz → 2500 kHz → 25 kHz ……

## EXPLANATION OF THE FUNCTION KEYS ON THE SPECTRUM SCOPE SCREEN

### ③ [F3(ATT)] Key (Attenuator)

By pressing this key, the display attenuation can be switched as shown below. The noise level on the band will vary according to conditions, your antenna, the time of day, etc.; please select the appropriate value for current conditions.

*0 dB → 10 dB → 20 dB → 0 dB* .....

### ④ [F6(CTR/FIX)] Key

By pressing this key, it is possible to switch between the CTR mode and FIX mode.

In the CTR mode, the current operating frequency is displayed at the center of the screen; in the FIX mode, the frequency selected via the Menu is fixed at the left edge of the display.

**Advice:** In either CTR or the FIX mode, the current operating frequency is indicated on the screen by the yellow arrow (▼), for ease of status recognition.

### ⑤ [F7(LBWS)] Key

Press this key to activate the “Limited Band Width Sweep” (LBWS) function, which permits high-speed sweeping of a band segment.

As the bandwidth is set narrower, the sweep speed becomes faster, allowing the scope to capture signals with quicker resolution. The bandwidth can be set to 50 %, 30 %, or 10 % of the full span. The sweep speed becomes faster by the following amounts:

50 %: about 2 times faster

30 %: about 3 times faster

10 %: about 10 times faster

*NORMAL → LBWS-1 (50%) →*

*LBWS-2 (30%) → LBWS-3 (10%) → NORMAL* .....

**Advice:** When you enter the LBWS mode, the function keys below the Display change.

It is possible to move the sweep position by pressing the [F5(◀)] and [F6(▶)] key.

If you want to return to normal operation, press the [F7(LBWS)] key as needed.

Please note that LBWS can not be used in the FIX mode. Please use LBWS only in the CTR mode.

### ⑥ [DISPLAY] Key

Press this key momentarily to switch the Function key’s function between the “Page Select Key” and the “Function Key.”

Press and hold in this key to disable the Function keys (except this key).

### FIX MODE SETUP (LEFT EDGE FREQUENCY)

Press the [MENU] button momentarily to enter the Menu mode. Select the item which you want to change by rotating the Main Tuning Dial knob (in this case, the item will be one of the items in the range from SCOPE “105 SCP 1.8 FI” to “115 SCP 50.0 FI”). Then change the setting by rotating the [SUB VFO-B] knob.

When the change is completed, *press and hold in* the [MENU] button for 2 seconds to save the change.

If you do not want to save the change, press the [MENU] button momentarily. The radio will go back to the previous condition/situation.

There are many setup items in the Menu mode, and they are grouped for easy recognition; the group name is displayed at the top left corner of the list screen. It is usually more convenient if you initially select the group by rotating the Main Tuning Dial knob, and then select the item you want.

## USING THE CTR (CENTER) DISPLAY MODE

It is possible to see both strong and weak signals clearly and easily on the Main (VFO-A) band. Also, the LBWS (Limited Band Width Sweep) mode lets you perform a high-speed, high-resolution sweep of a limited band segment.

1. Press the [F6(CTR/FIX)] key to change to the CTR mode.
2. By pressing [F6(CTR/FIX)] key, the CTR mode and the FIX mode will be toggled alternately. In the CTR mode, the yellow arrow “▼” will appear at the center of the display, indicating your current operating frequency.
3. Press the [F2(SPAN)] key to select the desired frequency span to monitor.

By pressing the [F2(SPAN)] key, the span will change as follows.

*25 kHz → 50 kHz → 100 kHz → 250 kHz →  
500 kHz → 1000 kHz → 2500 kHz → 25 kHz ……*

4. Press the [F3(ATT)] key to select the attenuation value according to current propagation conditions, your operating frequency and antenna, etc.

*0 dB → 10 dB → 20 dB → 0 dB ……*

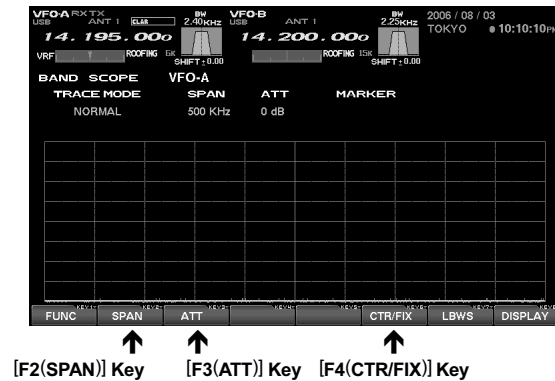

## USING THE MARKER

- Press the [F1(FUNC)] key to show the screen for setup of the Marker. The indication [F1(FUNC)] will change to [F1(MKR ON/OFF)]; now press the [F1(MKR ON/OFF)] key once again, and the Marker line will be displayed at the center of the screen.
- It is possible to change the position of the marker by pressing the [F2(◀)] and [F3(▶)] keys. If you want to center on a strong signal, you can move the marker to the screen position occupied by that signal. When the [F5(CF)] key is pressed momentarily (one touch), the marker position will return to the center.
- In order to remove the marker, press the [F1(MKR ON/OFF)] key.

- When you want to return to the Spectrum Scope screen, press the [F7(EXIT)] key. If the screen returns to the previous screen (with the Marker displayed), the marker will remain on the screen.

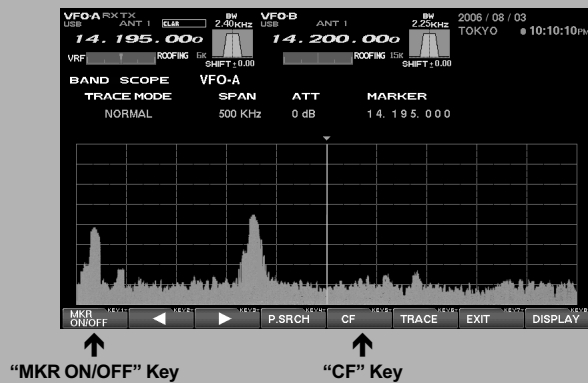



## USING THE CTR (CENTER) DISPLAY MODE

### Miscellaneous Functions

#### SEARCHING FOR STRONG SIGNALS

#### USING THE PEAK SEARCH FEATURE

1. Press the [F1(FUNC)] key to show the screen for setup of the Marker.
2. Press the [F4(P.SRCH)] key to move the marker to the highest peak signal frequency. With each press of the [F4(P.SRCH)] key, the Marker will shift to the strongest signal frequency away from the current frequency.

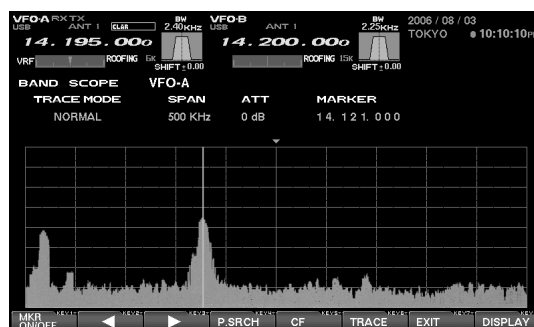

[F4(P.SRCH)] Key

#### CHANGING THE TRACE MODE

1. Press the [F1(FUNC)] key to show the screen for setup of the Marker.
2. Press the [F6(TRACE)] key to select the Trace mode of the Spectrum Scope.

The Trace mode selections are shown below.

**NORMAL** → **AVERAGE** →

**PEAK HOLD** → **NORMAL** .....

**NORMAL:** The real-time signal strength will be displayed. Normally, you will want to use this mode.

**AVERAGE:** The averaged signal strength will be displayed.

**PEAK HOLD:** The signal level will be displayed, with peak strengths held for a few seconds.

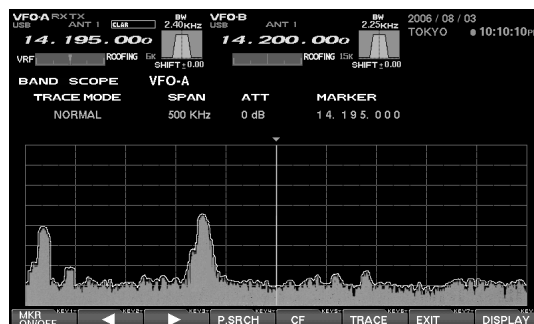

[F6(TRACE)] Key

### QMB MARKER

If the QMB frequency is within the Spectrum Scope sweep range, the QMB channel's frequency will be displayed on the screen by a white arrow (▽).

You may remove the QMB Marker from the screen via menu item "014 diSP QMB MARKER," if desired.

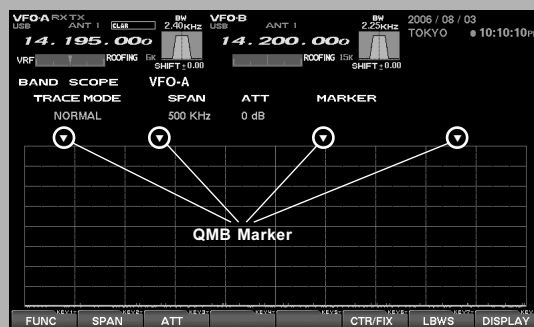

# SPECTRUM SCOPE

## USING THE LBWS (LIMITED BAND WIDTH SWEEP) FUNCTION

LBWS (Limited Band Width Sweep) is a function that sweeps a limited *segment* of the Spectrum Scope span without *changing* the span (bandwidth). As the sweep segment becomes narrower, the speed becomes faster, and the accuracy and resolution become enhanced.

The bandwidth can be set to 50 %, 30 %, or 10 % of the full span. The sweep speed will increase as follows:

50 %: about 2 times faster, 30 %: about 3 times faster, 10 %: about 10 times faster

1. By pressing the [F7(CTR/FIX)] key repeatedly, the CTR mode and the FIX mode will be toggled alternately.
2. By pressing the [F2(SPAN)] key, you can set the bandwidth of the span viewed using the Spectrum Scope. By pressing the [F2(SPAN)] key, the span will change as follows.

$25\text{ kHz} \rightarrow 50\text{ kHz} \rightarrow 100\text{ kHz} \rightarrow 250\text{ kHz} \rightarrow$   
 $500\text{ kHz} \rightarrow 1000\text{ kHz} \rightarrow 2500\text{ kHz} \rightarrow 25\text{ kHz} \dots\dots$

3. Press the [F3(ATT)] key to set the desired attenuation value.

By pressing the [F3(ATT)] key, the attenuation will change as follows.

$0\text{ dB} \rightarrow 10\text{ dB} \rightarrow 20\text{ dB} \rightarrow 0\text{ dB} \dots\dots$

4. By pressing the [F6(LBWS)] key, the LBWS segment width will change as follows.

$NORMAL \rightarrow LBWS-1 (50\%) \rightarrow$   
 $LBWS-2 (30\%) \rightarrow LBWS-3 (10\%) \rightarrow NORMAL \dots\dots$

**Advice:** Please note that the LBWS feature can not be used in the FIX mode. Please use LBWS only in the CTR mode.

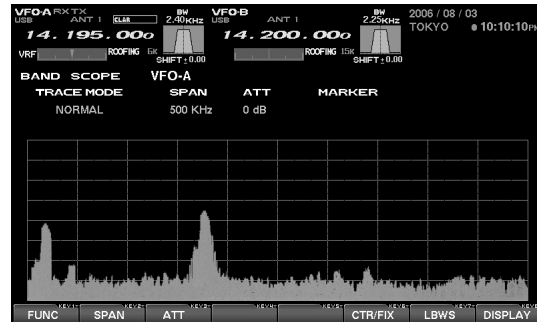

↓ [F5(CTR/FIX)] Key

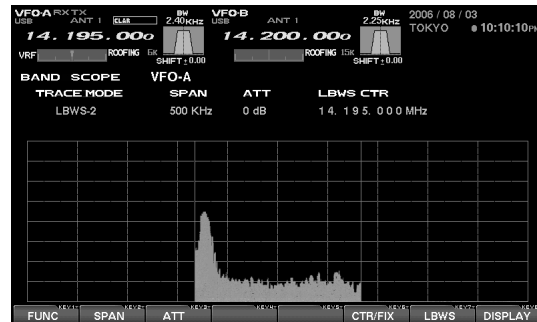

↑ [F5(LBWS)] Key

## USING THE FIX (FIXED) MODE

This feature is convenient when you want to monitor an entire amateur band.

The starting point, located at the left edge of the screen, can be set via the Menu. Even if the screen span (bandwidth) is changed, the start frequency will *not* be changed. By watching the screen, you can move your operation to frequencies where interesting activity appears on the display.

1. By pressing the [**F7(CTR/FIX)**] key, it is possible to switch between the CTR mode and the FIX mode. Select the CTR mode at this time.

2. Press the [**F2(SPAN)**] key to set the desired value for the Span (bandwidth). By pressing the [**F2(SPAN)**] key, the span will change as follows.

25 kHz → 50 kHz → 100 kHz → 250 kHz →  
500 kHz → 1000 kHz → 2500 kHz → 25 kHz .....

3. Press the [**F3(ATT)**] key to set the desired attenuation value. By pressing the [**F3(ATT)**] key, the attenuation will change as follows.

0 dB → 10 dB → 20 dB → 0 dB .....

4. When you rotate the Main Tuning Dial knob, the yellow arrow (▼) will move to follow your receive frequency.

If the receive frequency is outside of the screen, the position of the operating frequency will be “shown” in the lower area of the display as “<<<” “>>>”, and “RCV Freq is out of range” will also be displayed.

5. Just as in the CTR mode, you can use the Marker. Please see page 23 for information on using the marker.

**Advice:** In either CTR or FIX mode, the current operating frequency will be indicated on the screen by the yellow arrow (▼).

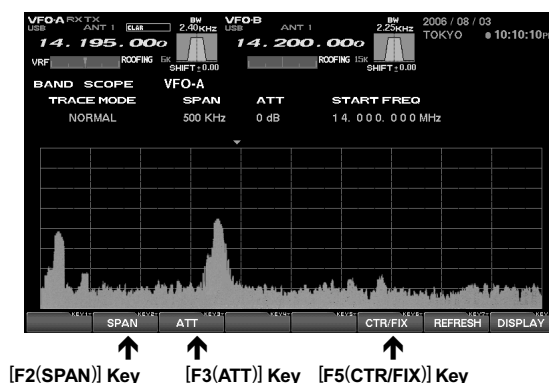

### SETTING THE LEFT EDGE FREQUENCY FOR THE FIX MODE

Press the [**MENU**] button momentarily to enter the Menu mode. Select the item which you want to change by rotating the Main Tuning Dial knob (in this case, the items will be in the range from “105 SCP 1.8 FI” to “115 SPC 50.0 FI”). Now you may change the setting by rotating the [**SUB VFO-B**] knob.

When the change(s) are completed, press and hold in the [**MENU**] button for 2 seconds to save the change.

If you do not want to save the change(s), press the [**MENU**] button momentarily. The radio will go back to its previous condition/situation.

There are many setup items in the Menu, and they are grouped; the group name is displayed at the top left area of the list screen. It will generally be more convenient for you if you initially select the group, by rotating the Main Tuning Dial knob, and then select the item you want to work on.

Provided by   
**YAESU** museum   
  
 Downloaded by   
**RadioAmateur.EU**

# AUDIO SCOPE AND OSCILLOSCOPE

## ABOUT THE AUDIO SCOPE AND OSCILLOSCOPE

It is possible to show both the Audio Scope and the Oscilloscope displays simultaneously.

With the Audio Scope, the horizontal line represents frequency, and you can use this function check the frequency response within the RX or TX bandwidth. In the Oscilloscope mode, the horizontal line represents time, and you can check the RX signal waveform within the RX bandwidth, as well as the TX wave form.

If the “Audio Scope / Oscilloscope” screen does not initially appear, press the **[DISPLAY]** key to switch the Function key’s function to “Page Select Key,” then press the **[F3(AF SCOPE)]** key momentarily to display the “Audio Scope / Oscilloscope” screen. Next, press the **[DISPLAY]** key again to switch the Function key’s function to the “Function Key.”

## EXPLANATION OF THE FUNCTION KEYS ON THE AUDIO SCOPE AND OSCILLOSCOPE SCREEN

Here are the uses for the function keys when the Audio scope and Oscilloscope are displayed on the screen.

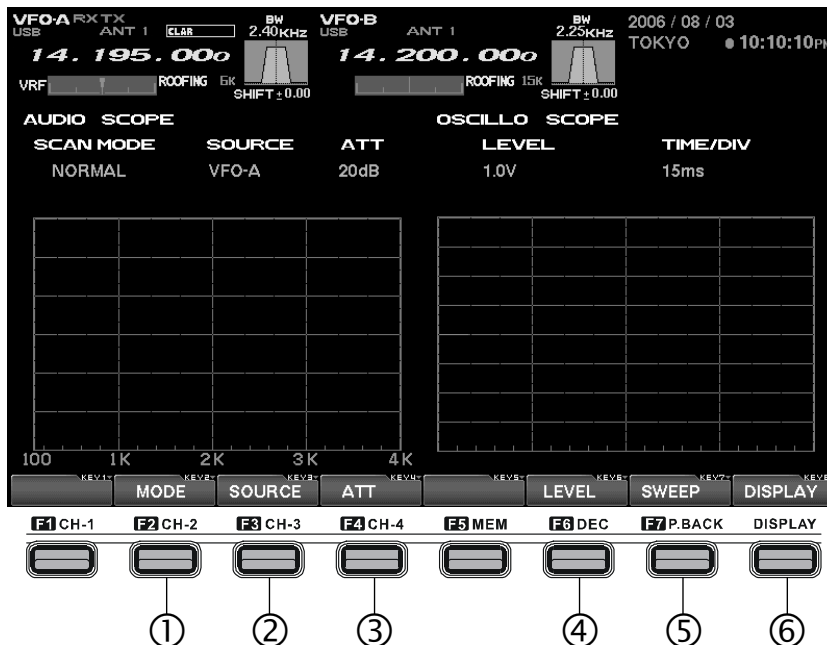

### ① **[F2(MODE)]** Key

The SCAN MODE for the left-side Audio Scope can be changed. By pressing this key, the mode changes:

*NORMAL* → *WF-1* → *WF-2* → *NORMAL* .....

“*WF-1*” and “*WF-2*” are “Waterfall” displays. The sweep time (speed) of “*WF-2*” is faster than that of “*WF-1*.”

### ② **[F3(SOURCE)]** Key

Pressing this key lets you select the source for the audio to be viewed by the Audio Scope. The selections are:

*VFO-A* → *VFO-B* → *EXT* → *VFO-A* .....

When “*EXT*” is selected, you can observe the audio wave form of a signal provided by equipment connected to the **AUDIO IN** jack on the rear panel of the **DMU-2000**.

### ③ **[F4(ATT)]** Key (Attenuator)

This key lets you adjust the attenuator for the Audio scope. Set the appropriate value based on the received signal.

*0 dB* → *10 dB* → *20 dB* → *0 dB* .....

### ④ **[F6(LEVEL)]** Key

This key lets you adjust the sensitivity of the Oscilloscope display at the right side of the screen. Adjust the level while viewing the screen, to optimize the setting according to the signal and noise conditions present. Available values are:

*0.3 V* → *0.1 V* → *1.0 V* → *0.3 V* .....

### ⑤ **[F7(SWEEP)]** Key

This key lets you adjust the sweep time for the Oscilloscope. Adjust this setting while viewing the screen. Available sweep times are:

*10 ms* → *30 ms* → *100 ms* → *300 ms* → *1 s* → *10 ms* .....

### ⑥ **[DISPLAY]** Key

Press this key momentarily to switch the Function key’s function between the “Page Select Key” and the “Function Key.”

Press and hold in this key to disable the Function keys (except this key).

# AUDIO SCOPE AND OSCILLOSCOPE

## USING THE AUDIO SCOPE

The Audio Scope is particularly useful when making adjustments to the transmitter, especially when setting up the Speech Processor as well as the Parametric Microphone Equalizer.

On receive, you can observe the signal characteristics and quality of the incoming signal, as well. In the case of the Waterfall display, this can be used for precise frequency alignment of incoming signals to correspond with filters used in your computer's sound card or modem. The sweep time (speed) of WF-2 is faster than WF-1, and you can choose the sweep most appropriate for your operating application.

1. By pressing the [F2(MODE)] key, the Waterfall mode can be modified. The available selections are:

*NORMAL* → *WF-1* → *WF-2* → *NORMAL* .....

“*NORMAL*” is a regular spectrum display.

“*WF-1*” and “*WF-2*” are Waterfall displays, with “*WF-2*” utilizing a faster sweep time than the “*WF-1*” selection.

2. Pressing the [F3(SOURCE)] key lets you select the source for the audio to be viewed by the Audio Scope. The selections are:

*VFO-A* → *VFO-B* → *EXT* → *VFO-A* .....

**Advice:** When “*EXT*” is selected, you can observe the audio wave form of a signal provided by equipment connected to the **AUDIO IN** jack on the rear panel of the **DMU-2000**.

3. Press the [F4(ATT)] key to change the setting for the attenuator. The available settings are:

*0.3 V* → *0.1 V* → *1.0 V* → *0.3 V* .....

**Advice:** By using this feature, you can conveniently monitor the status of the CONTOUR filter, the performance of the IF Notch, and the WIDTH/SHIFT status.

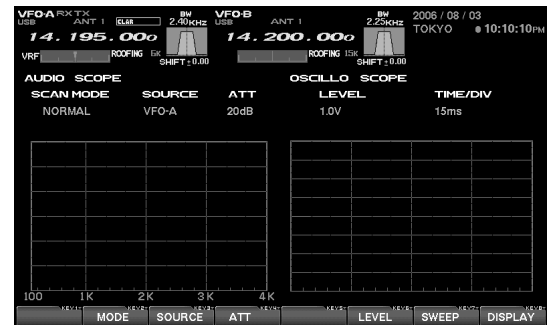

↑ [F2(MODE)] Key  
↑ [F3(SOURCE)] Key  
↑ [F4(ATT)] Key

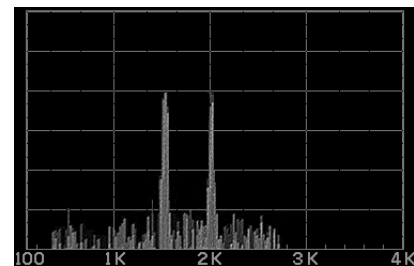

SPECTRUM DISPLAY

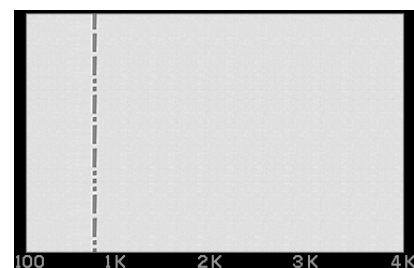

WATERFALL DISPLAY

### AUDIO SCOPE SPECIFICATIONS

- Frequency Range:** 100 Hz - 4 kHz
- Frequency Resolution:** 20 Hz (Approx.)
- Display Range:** 80dB (Approx.)
- Signal Processing:** FFT (Fast Fourier Transformation)
- Input Level:** 1 Vp-p Input (ADC Max. value)
- Attenuator:** @0 dB, top edge;  
@10 dB, 1 division of shift;  
@20 dB, 2 divisions of shift

# AUDIO SCOPE AND OSCILLOSCOPE

## USING THE OSCILLOSCOPE

Both TX and RX waveforms can be observed, allowing optimal adjustments of setup options or filter settings, on Voice, CW, and Digital modes.

1. Press the **[F6(LEVEL)]** key to set the level as appropriate for the signal strength being monitored. Available values are:

*0.3 V → 0.1 V → 1.0 V → 0.3 V .....*

2. Press the **[F7(SWEEP)]** key to set the desired sweep time. Available values are:

*10 ms → 30 ms → 100 ms → 300 ms → 1 s → 10 ms .....*

**Advice:** When monitoring the TX waveform, turn on the monitor feature by pressing the front panel's **[MONI]** button.

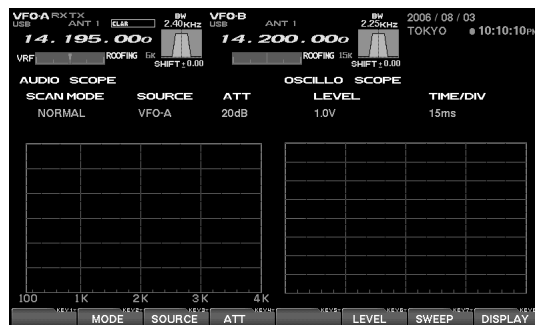

↑  
"LEVEL" Select

↑  
"SWEEP" Select

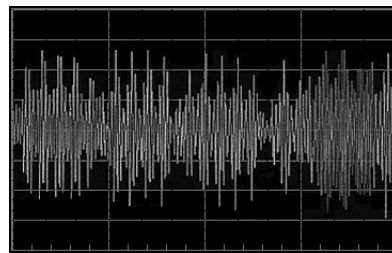

OSCILLOSCOPE DISPLAY

### OSCILLOSCOPE SPECIFICATIONS

**Frequency Range:** 0 - 4 kHz

**Sweep Speed:** 10/30/100/300/1000ms (adjustable)

**Time Base Indication:** One frame: 10 divisions (20 gradations) "Sweep time / 20"  
500 μ/1.5 m/5 m/15 m/50 m/DIV

**Signal Processing:** AC Level Detection Synchronizer function

**Input Level:** 1 Vp-p Input (ADC Max. value)

# *AUDIO SCOPE AND OSCILLOSCOPE*

---

---

## **NOTE**

---

---

# LOG BOOK FUNCTION

## ABOUT THE LOG BOOK

By connecting your keyboard (not supplied) to the Data Management Unit's rear-panel **KEYBOARD** jack (PS/2 or USB), you can create a Log Book within the radio, and display it on the Display. Date, time, frequency, and mode will be automatically stored, and you can save log data to the Compact Flash card for archive purposes.

If the "Log Book" screen does not initially appear, press the **[DISPLAY]** key to switch the Function key's function to "Page Select Key," then press the **[F4(LOGBOOK)]** key momentarily to display the "Log Book" screen. Next, press the **[DISPLAY]** key again to switch the Function key's function to the "Function Key."

## EXPLANATION OF THE FUNCTION KEYS ON THE LOG BOOK SCREEN

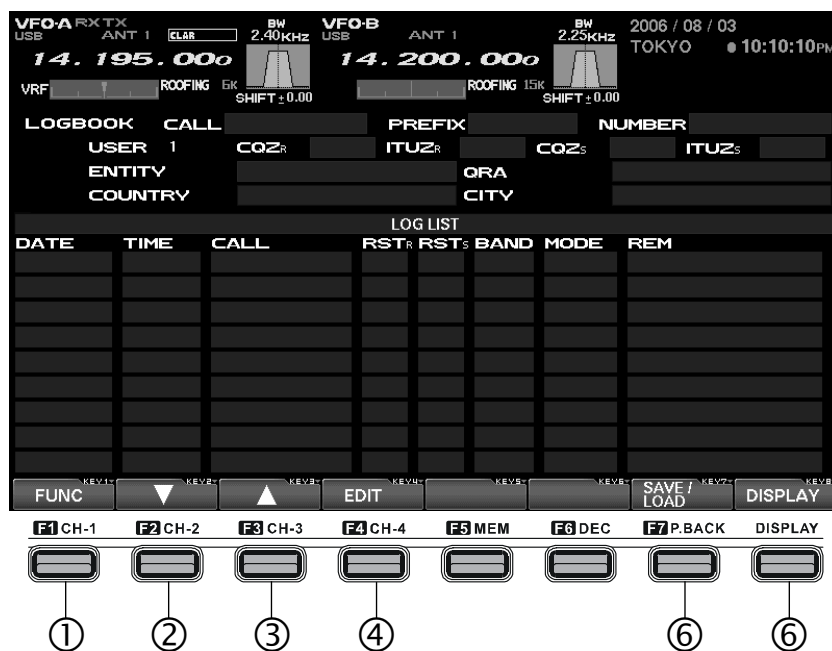

### ① **[F1(FUNC)]** Key

You may use the "CHECK" function to check the log to see if a QSO has been made previously with the logged station, and you may also create a summary of QSOs by band and mode by pressing this key. The log may be viewed solely for the current operator, or for all operators registered into the Logbook and saved on the CF card.

### ② **[F2(▼)]** Key

Press this key to shift to the log line below the current one.

### ③ **[F3(▲)]** Key

Press this key to shift to the log line above the current one.

### ④ **[F4(EDIT)]** Key

Press this key to enable editing of previously-stored log data.

### ⑤ **[F7(SAVE/LOAD)]** Key

Press this key to engage the screen that allows you to manage log data to be saved.

### ⑥ **[DISPLAY]** Key

Press this key momentarily to switch the Function key's function between the "Page Select Key" and the "Function Key."

Press and hold in this key to disable the Function keys (except this key).



# LOG BOOK FUNCTION

## LOG BOOK EXAMPLE

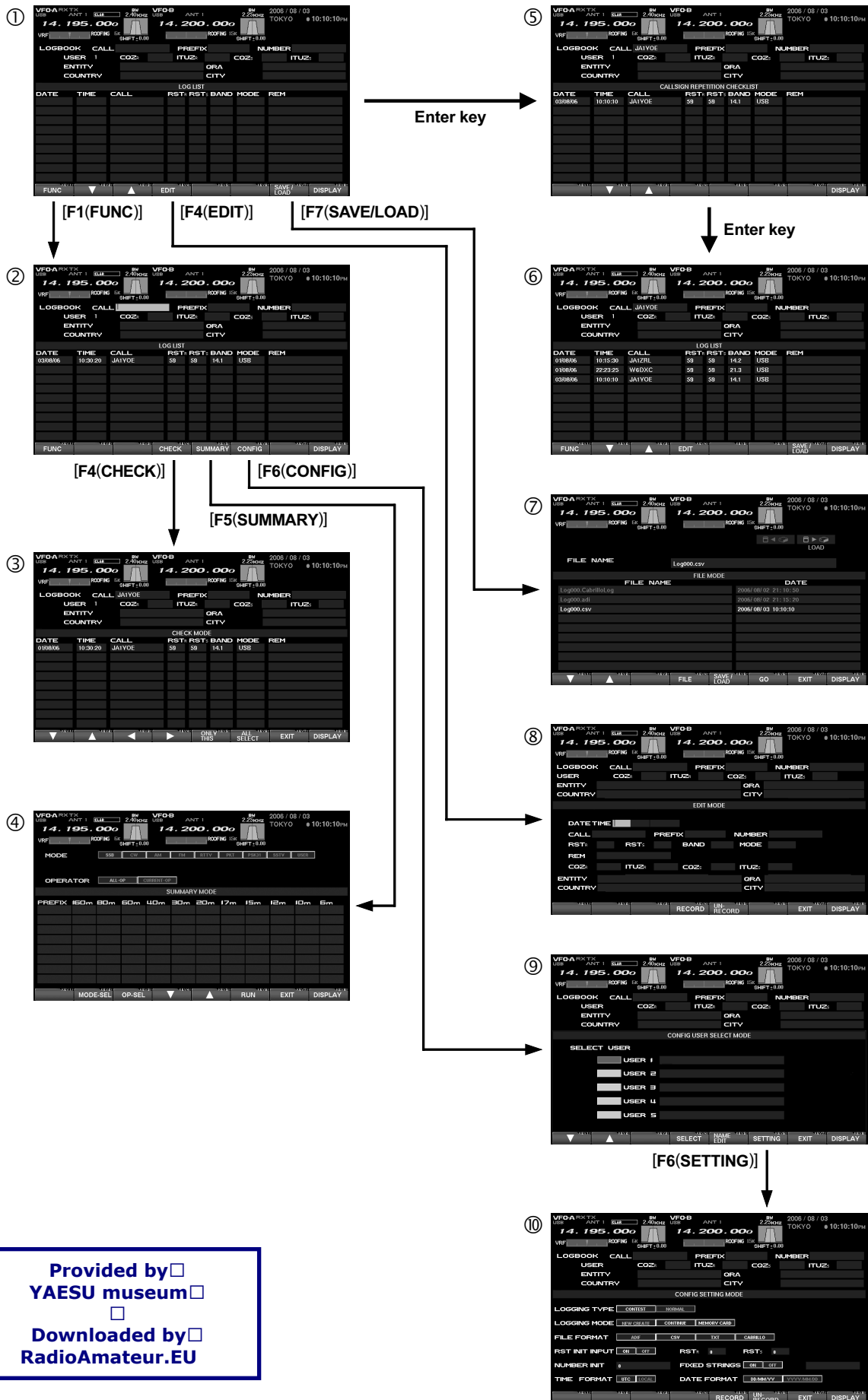

# LOG BOOK FUNCTION

## CONFIG SETTING

Up to five users may be registered into the Logbook. For use in a contest or otherwise, the settings for each operator may be stored for later recall when that operator signs on. The operator's identification may be entered into the NAME column; both the name and callsign may be entered.

1. Referring to Figure ① on page 29, press the [F6(CONFIG)] key to engage the "CONFIG USER SELECT MODE," then the [F1(▼)] / [F2(▲)] keys to utilize the "SELECT USER" function.
2. When you want to register a new user, or change the name of an existing user, press the [F5(NAME EDIT)] key and input the call sign and/or other information.
3. Press the [F5(NAME EDIT)] key again.
4. Press the [F6(SETTING)] key to engage the "CONFIG SETTING MODE," then use the keyboard's arrow keys to navigate to the needed fields. Please see the discussion on the next page for details of the "CONFIG SETTING MODE" mode.
5. Press the [F5(RECORD)] key to register. If you want to un-do the registration, press [F6(UN-RECORD)] key.

**Advice:** If no special entry is performed, the log will register you as "USER1."

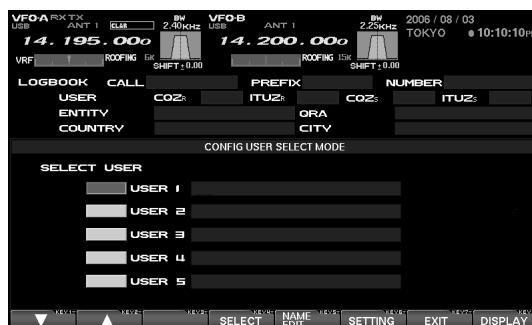

**CONFIG USER SELECT MODE**

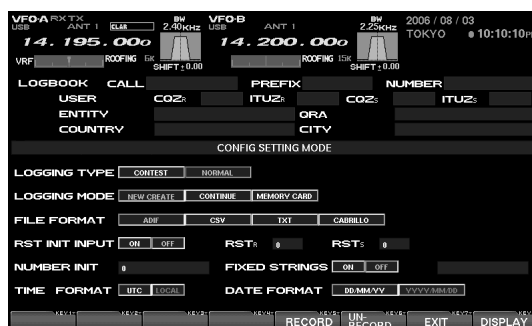

**CONFIG SETTING MODE**

## CONFIG SETTING

### CONFIG SETTING MODE SETUP

#### LOGGING TYPE (Setup of Log preferences)

**CONTEST:** This is a concise log format, with Callsign, RST, REM (Remarks) only being entered by the operator; the Date, Time, Band, and Mode will automatically be entered and saved.

**NORMAL:** Besides the above information from the Contest log format, you can enter the Country, City, Name, and other data.

In addition to the call sign, RST and REM, COUNTRY, CITY QRA, etc. data can be added.

All of the DATE, TIME, CBAND, CMODE are automatically saved; once again, the Date, Time, Band, and Mode will automatically be entered and saved.

#### LOGGING MODE (Logging Operational Mode)

**NEW CREATE:** Create a new Log Book.

**CONTINUE:** Add data to current log book.

**MEMORY CARD:** Download (read) log data from the CF (see page 34 for details).

#### FILE FORMAT (Set up the file format for the log data)

**ADIF:** A worldwide standard format for DX contest log data.

**CSV:** Comma Separated Values format.

**TXT:** Text format.

**CABRILLO:** Worldwide standard format used for electronic submissions of Contest logs.

#### RST INIT INPUT (RST Automatic Input)

**ON:** Automatic filling in of the RSTR and RSTS (RST Received/Sent) reports is enabled. Manual correction of individual log lines is, of course, possible.

**OFF:** On CW mode, "599" will be automatically entered, and on other modes "59" will be automatically entered. You may correct these reports manually via the keyboard.

#### NUMBER INIT (Setting the Initial Sequential Number)

The initial Contest Number (or other sequential number to be assigned to each QSO) is entered here. The automatic entry and transmission of the Contest Number will dramatically reduce fatigue over many hours of operation.

#### FIXED STRINGS (Contest Number/Multiplier Memo On/Off Setup)

**ON:** In a CW contest, this is the area used for enabling input of multiple "memo" columns of data that will be sent automatically, thus reducing fatigue.

**OFF:** If there is no need for multiple "memo" input columns, set this to Off.

#### TIME FORMAT (Conversion of UTC or Local Time for Logbook Time)

When log entry is done in LOCAL (LOCAL TIME-1), the log will automatically convert the time to UTC.

#### DATE FORMAT (Setup of Date Format to be day/month/year or year/month/day)

The Logbook can be set up for two different formats. When set to DD/MM/YY, March 28, 2005 will be formatted as 03/08/06. If the format selected is YYYY/MM/DD, the same date will be formatted as 2006/08/03.

# LOG BOOK FUNCTION

## LOG BOOK DATA INPUT

Log data may be entered by the user. Depending on the user setup (CONFIG) for “LOGGING TYPE,” there are two logging modes: In the “CONTEST” mode, the operator just enters the callsign, signal report, and the REM (“remarks”) fields, and the Date/Time/Band/Mode are all entered automatically. In the “NORMAL” mode, additional information may be entered, such as the Country, City, and Name. Up to 500 stations may store into a file.

Please enter the log data in accordance with the example in the illustration.

**Advice:** Before you start logging, we recommend that you perform the **CONFIG SETTING MODE** procedure within the User setup (CONFIG) protocol.

1. Referring to the Figure ① on page 29, use your keyboard to enter the callsign in the “**CALL**” field. Now press the keyboard’s **[ENTER]** key.
2. The callsign will be checked against the previous entries to see if it is a duplicate; if so, the “**CALLSIGN REPETITION CHECKLIST**” will open, listing this and any other duplicates. During the QSO, if you wish to delete the callsign and other information for this line, just press the keyboard’s **[ESC]** key.
3. Enter all desired data in accordance with the example in the picture. When finished, press the keyboard’s **[ENTER]** key.

**Note:** In order to ensure preservation of log data, be sure to Save the data frequently. It is always a good idea to maintain a paper archive copy of log data. Vertex Standard specifically disclaims responsibility for any liability arising from the loss of log data.

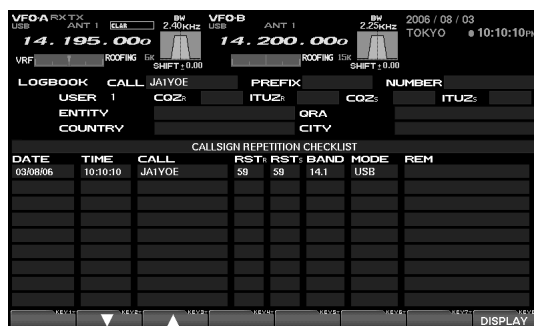

**CALLSIGN REPETITION CHECK LIST**

**Advice:** When entering the Zone via the “**ITUZR**” field, pressing the key-board’s **[ENTER]** key will move you to the CQ Zone (**CQZR**); from there, use the key-board’s **[▶]** key to navigate back to the “**ITUZR**” field, if desired.

When doing input of the “**PREFIX**,” “**CQZR**” (or “**ITUZR**”), “**ENTITY**,” and “**QRA**” data, please set the “**LOGGING TYPE**” to “**NORMAL**” beforehand. This will allow you to move from column to column by pressing the key-board’s **[ENTER]** key. In addition, when (for example) entering the “**PREFIX**” and pressing the key-board’s **[ENTER]** key, the “**PREFIX SELECT LIST**” will appear, and the “**ENTITY**” and “**CQZR**” (or “**ITUZR**”) will automatically be entered.

## LOG BOOK PREVIOUS-QSO CHECK (CHECK)

It is possible to check the log in search for previous QSOs with a particular station. When a log entry of interest is found, you may edit the information on that line, if you like.

1. Referring to the Figure ① on page 29, enter the desired callsign into the “CALL” field.
2. Press the [F4(CHECK)] key to show a list of any previous QSOs with the specified station within the current log. Any previous QSOs will appear on a “CHECK MODE” list.
3. Use the [F1(▼)], [F2(▲)], [F3(◀)], and [F4(▶)] keys to scroll through the data on the “CHECK MODE” list.

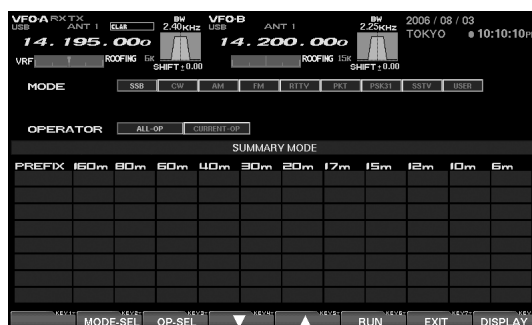

“CHECK MODE” LIST

**Quick Point:** In the Step 2 above, before doing a check for a duplicate QSO, a copy is made of the QSO record, and you may then do editing of that record. Use the [F1(▼)], [F2(▲)], [F3(◀)], and [F4(▶)] keys to select an item from among “CALL,” “RST,” “BAND,” “MODE,” and “REM;” when you press the [F5(ONLY THIS)] key you’ll copy only that item. When you press the [F7(EXIT)] key, the display image changes to what you see on page 29; press the keyboard’s [ENTER] key to do a duplicate check, and press the [ENTER] key once more to return to the log input page and copy the data.

If you select a line of data using the [F1(▼)] and [F2(▲)] keys, pressing the [F6(ALL SELECT)] key followed by [F7(ENTER)] key will cause the display image to change to what you see on page 29, and you may now press the keyboard’s [ENTER] key to do a duplicate check. Press the [ENTER] key once more to return to the log input page and copy the data to that page (however, the “NUMBER,” “RST,” “BAND,” and “MODE” data will not be copied).

## EDITING LOG BOOK ENTRIES

Previously-entered log data may be edited alter, if desired.

1. Referring to Figure ① on page 29, press the [F2(▼)]/[F3(▲)] key to select the log data to be Editing, then press the [F4(EDIT)] key to open the “EDIT MODE” list.
2. Now you may use the arrow keys on your keyboard to move the highlighted area through the log.
3. Use the keyboard to change data within the currently-highlighted area.
4. Press the [F4(RECORD)] key when you are finished editing the entries you have worked on.  
If you do not wish to save your changes, press the [F5(UN-RECORD)] key instead.



“Edit Mode” LIST

**Advice:** Data may easily be deleted, if you make a mistake, enter duplicate data accidentally, etc.

To erase data, use steps 1 and 2 above to select the data to be erased. Then press the keyboard’s [ESC] key; the data will be deleted. Press [F4(RECORD)] to return to the screen depicted on page 29 and end this procedure.

# LOG BOOK FUNCTION

## SAVING LOG DATA

Log data can be saved in the supplied Compact Flash (CF) card.

1. Referring to Figure ① on page 29, press the [F7(SAVE/LOAD)] key to move to the Save/Load page.
2. Press the [F5(SAVE/LOAD)] key to choose the “Save” protocol.



3. Input the desired FILE NAME, and press the [F6(GO)] key to save the data in the CF card.

**Note:** Be sure not to delete the “extension” to the file name, when entering the file name. If the extension is missing, it will not be possible to load log data.

When the ERROR message “**CF CARD IS NOT READY**” appears on the display, please confirm that the CF card is inserted correctly into its slot.

When memory data is saved in the CF card, any file with the same name as the current file will be revised (overwritten), and the previous data will be deleted. Please note.



“SAVE/LOAD” MODE

**Advice:** The user configuration protocol (CONFIG) allows you to specify the file format that is used for saving log data. The available formats are:

- ADIF (International Log Format) ..... **adi**
- CSV (Cursor-Limited Values) ..... **csv**
- TXT (Tab-Limited Values) ..... **txt**
- CABRILLO (International Log Format) .... **cabrillolog**

## LOADING LOG DATA (LOAD)

You may load log data from a CF card into your **DMU-2000** (for example, an archive copy, or a log from a different **DMU-2000** or **FT dx 9000** Series Transceiver). Before starting, be sure the CF card containing the log data has been inserted into the CF Card Slot.

1. Referring to Figure ① on page 29, press the [F7(SAVE/LOAD)] key to engage the Save/Load mode.
2. Press the [F5(SAVE/LOAD)] key to engage the LOAD protocol.



3. Use the [F1(▼)] and [F2(▲)] keys to select the file you wish to upload to the transceiver, then press the [F6(GO)] key to load the file.

**Advice:** Be sure not to delete the “extension” to the file name, when entering the file name. A missing extension will make it impossible to load log data

When the ERROR message “**CF CARD IS NOT READY**” appears on the display, please confirm that the CF card is inserted correctly into its slot.

When memory data is loaded from the CF card, the current memories stored in the **DMU-2000** will be overwritten, and the previous data is erased. We recommend that you save and download the current memory data to the CF card, if you want to use it again later.



“SAVE/LOAD” MODE

## SUMMARY CHECK

You may do a band-by band, mode-by mode, or “all log” summary of your log data.

### MODE-BASED SUMMARY CHECK

1. Referring to Figure ② on page 29, press the [F5(SUMMARY)] key to bring up the “SUMMARY MODE” page, and you may then press the [F2(MODE-SEL)] key and select the desired mode, using the keyboard’s arrow ([◀] or [▶]) keys.
2. When you press the [F6(RUN)] key, the summary list for the selected mode will be displayed.
3. Use the [F4(▼)] and [F5(▲)] keys to scroll through the summary list.

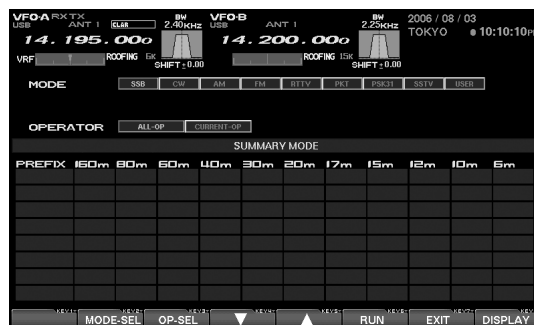

“SUMMARY MODE” PAGE

### OPERATOR-BASED SUMMARY CHECK

1. Referring to Figure ② on page 29, press the [F5(SUMMARY)] key to bring up the “SUMMARY MODE” page, then press the [F3(OP-SEL)] key and then use the keyboard’s arrow ([◀] or [▶]) keys to select “ALL-OP” or “CURRENT OP” as desired.

**ALL-OP:** All log data from all operators registered on the data stored on the CF card will be displayed.

**CURRENT OP:** Only the log data from the current operator will be displayed.

2. Press the [F6(RUN)] key to display the summary list for the selected operator, or all operators.
3. Use the [F4(▼)] and [F5(▲)] keys to scroll through the summary list.

*Note:* The Summary Check function requires that “NORMAL” be selected as the “Log Type” before you start, and only logs containing the PREFIX may be used for this function.

Files saved in either “.CSV” or “.TXT” formats are capable of letting you perform the “Summary Check” function.

Provided by   
YAESU museum   
  
Downloaded by   
RadioAmateur.EU

# TEMPERATURE / SWR INDICATION

## ABOUT THE TEMPERATURE/SWR INDICATION

It is possible to display the VDD (TX Final Amplifier) voltage, bias voltage, the temperature of the heat sink of the final devices, and the (swept) SWR characteristics/performance of the antenna connected, all together on the Display screen.

If the “Temperature/SWR” screen does not initially appear, press the **[DISPLAY]** key to switch the Function key’s function to “Page Select Key,” then press the **[F5(SWR)]** key momentarily to display the “Temperature/SWR” screen. Next, press the **[DISPLAY]** key again to switch the Function key’s function to the “Function Key.”

## EXPLANATION OF THE FUNCTION KEYS ON THE TEMPERATURE/SWR INDICATION SCREEN

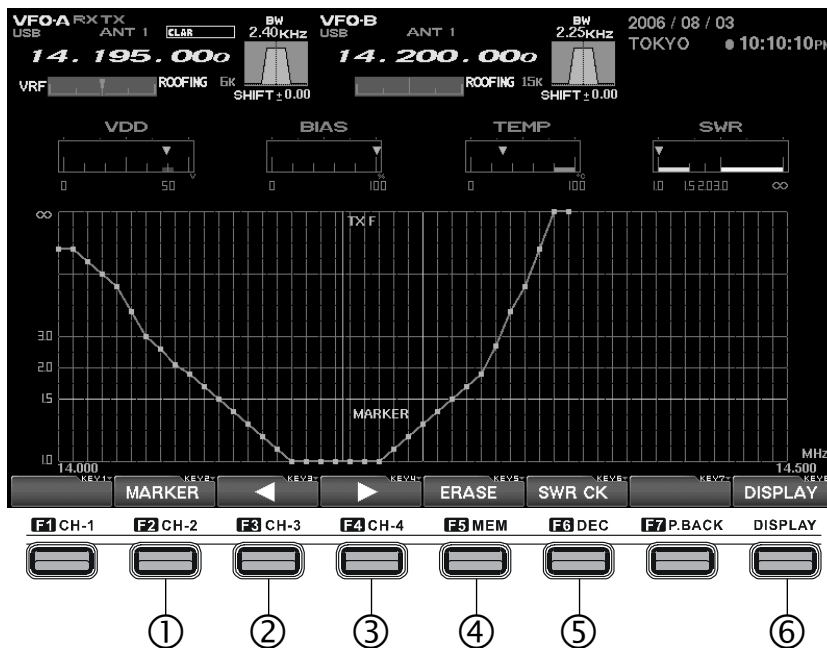

### ① **[F2(MARKER)]** Key

This key turns the marker on the SWR characteristic graph on and off.

The marker lets you identify quickly the frequency on which a particular SWR reading is being observed.

### ② **[F3(◀)]** Key

This key moves the marker cursor to the left.

### ③ **[F4(▶)]** Key

This key moves the marker cursor to the right.

### ④ **[F5(ERASE)]** Key

Press this key when you want to clear the measured SWR at the marker’s current point.

### ⑤ **[F6(SWR CK)]** Key

To check the SWR on a particular frequency, rotate the Main Tuning Dial knob, and set the frequency to be measured. Now press the **[F6(SWR CK)]** key; the SWR will be measured and the result will be displayed on the screen.

### ⑥ **[DISPLAY]** Key

Press this key momentarily to switch the Function key’s function between the “Page Select Key” and the “Function Key.”

Press and hold in this key to disable the Function keys (except this key).



# TEMPERATURE / SWR INDICATION

## GRAPHIC METER DISPLAYS

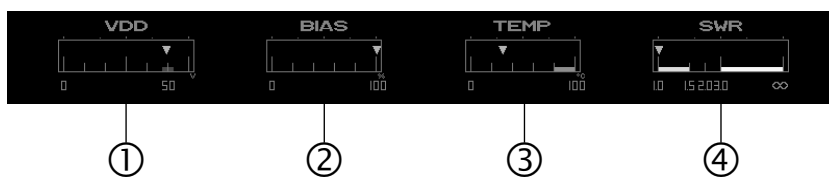

### ① VDD

The drain voltage of the final FETs is measured and displayed here.

In the **FT-2000** (100 W version), the measurement range is 0 ~ 18 V, and the proper voltage is around 13.8 V. On TX, if around 13.8 V is displayed, the transceiver is operating normally.

In the **FT-2000D** (200 W version), the measurement range is 0 ~ 60 V, and the proper voltage is around 50 V. On TX, if around 50 V is displayed, the transceiver is operating normally.

### ② BIAS

While operating with the Class-A on the **FT-2000D** (200 W version), and the bias is changed via the Menu item “**141 tGEN BIAS**” from Class-A to Class-AB, this indication can be used to observe the current setting. The indication is 0 ~ 100 % and “0 %” means Class-AB, while “100 %” means Class-A.

Even if the Bias is varied, the RF output will not change (up to the 75 Watts of maximum power under Class-A), and you can change the bias safely even when you are using a linear amplifier.

In the **FT-2000** (100 W version), this indicator always shows “0 %.”

### ③ TEMP

This indicates the temperature (measured) of the final amplifier FETs’ heat sink.

The measured temperature range of this meter is 0 ~ 100 °C, and above 80 °C is the “Red Zone” temperature range to be avoided, so as to ensure a safe operating temperature range. When the temperature rises above 80 °C, the fan speed will increase by a factor of four, providing a significant increase in air flow. The heat sink temperature may rise appreciably during Class-A operation on the **FT-2000D** (200 W version), especially if the ambient temperature is warm, and we recommend that you monitor the temperature during Class-A transmission, adjusting the Bias control downward (more toward Class-AB) if excessive heating is observed. A lower bias level will cause less heat to be dissipated, thus reducing the heat sink temperature.

### ④ SWR

This displays the SWR characteristic of the amateur band that you are currently using, with points along the graph indicating the frequencies that have been measured.

# TEMPERATURE / SWR INDICATION

## SWEPT SWR DISPLAY

It is possible to show the SWR characteristics and antenna performance on a graph by measuring the SWR at various points across an amateur band.

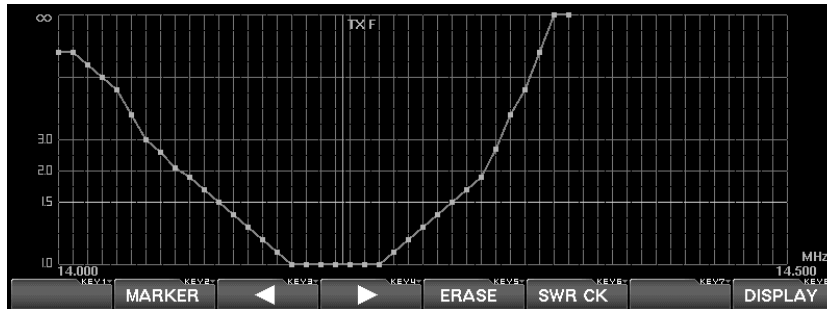

In order to measure the SWR of the antenna system correctly, please turn off the antenna tuner before measuring the SWR.

1. Please confirm that the RF output is over 10 Watts. In order to measure the SWR correctly, 10 Watts of RF output will be required. The TX RF output may be adjusted using the [RF PWR] knob.
2. Please confirm that the test transmission will not cause QRM to other stations (be sure to ask if the frequency is clear, and identify in accordance with regulations). Then press the [F6(SWR CK)] key.
3. Perform the above procedure several times across the band, and the SWR measured at the various test frequencies will automatically be plotted on the chart, creating a performance characteristic graph for the current frequency range.

**Advice:** For the purposes of plotting the SWR across the band, the resolution of the graph is every 10 kHz on the 1.8 ~ 24.9 MHz bands, and 100 kHz on the 28/50 MHz bands.

If a measurement is done on the same frequency as where a previous measurement was made, the old data will be cleared and the new measurement data will replace it.

Always observe proper operating courtesy to others, and check to be sure the frequency is clear before performing any SWR measurements.

# TEMPERATURE / SWR INDICATION

## USING THE MARKER ON THE SWR GRAPH

It is possible to read the measured SWR value by placing the marker onto the desired frequency (measurement test point) of the SWR graph.

1. Press the [F2(MARKER)] key to turn the marker function on; the marker cursor will be displayed.
2. Use the [F3(◀)] and [F4(▶)] keys to move the marker line and select the desired frequency for which you want to read the previously-measured SWR.

**Advice:** Please use an antenna with the SWR below 1.5:1. If the SWR is over 1.5:1, the final protection circuit activates, and the RF output power may be reduced.

If the SWR is over 3.0 in the amateur band, there is a possibility that the coaxial cable or the antenna itself (antenna system) may have some problem. Please take the necessary corrective action so as to ensure optimum, safe performance in your station.

The antenna tuner in the radio can match the SWR between the transceiver and the antenna; however, keep in mind that this is not affecting the SWR at the antenna feedpoint itself. In cases of higher-than-desirable SWR, we recommend corrective action be taken at the antenna itself.

When you want to clear the measured SWR value at the marker test point, press the [F2(MARKER)] key.

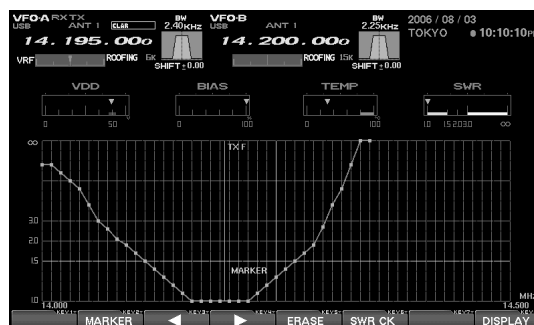

# GREAT CIRCLE MAP / ROTATOR CONTROL FUNCTION

## ABOUT THE GREAT CIRCLE MAP / ROTATOR CONTROL FUNCTION SCREEN

In order to direct the antenna to the desired/opposite station, a Great Circle Map can be displayed on the screen. This Great Circle map will show your location at the center of the map, and you can easily recognize and confirm the direction your antenna should be pointed to work a station elsewhere in the world.

In addition, when a Yaesu Rotator (**G-800DXA**, **G-1000DXA**, or **G-2800DXA**) is connected to the **FT-2000** transceiver, the transceiver can control the direction of the rotation, rotation speed, etc. on the display screen. In this case, the rotator has to be connected to the **FT-2000** via the optional cable T9101556, available from your YAESU dealer.

If the “Rotator Control” screen does not initially appear, press the **[DISPLAY]** key to switch the Function key’s function to “Page Select Key,” then press the **[F6(ROTATOR)]** key momentarily to display the “Rotator Control” screen. Next, press the **[DISPLAY]** key again to switch the Function key’s function to the “Function Key.”

## EXPLANATION OF THE FUNCTION KEYS ON THE GREAT CIRCLE MAP/ROTATOR CONTROL SCREEN



### ① **[F1(ZONE)]** Key

This key moves you to a screen used for input of the location of the other station. When the country name and the city name are entered, your location and the opposite station’s will be connected with a line and displayed on the Great Circle map (short path only). The location of the other station can be set when Rotator control is in the manual mode.

Press the **[F4(MODE)]** key as needed to select the manual mode. The mode is indicated in the middle of the Display.

### ② **[F2(CCW)]** Key

When a Yaesu Rotator (**G-800DXA**, **G-1000DXA**, or **G-2800DXA**) is connected to the transceiver, and you press this key, you can rotate the antenna in the CCW (counter clockwise) direction.

### ③ **[F3(CW)]** Key

When a Yaesu Rotator (**G-800DXA**, **G-1000DXA**, or **G-2800DXA**) is connected to the transceiver, and you press this key, you can rotate the antenna in the CW (clockwise) direction.

# GREAT CIRCLE MAP / ROTATOR CONTROL FUNCTION

## EXPLANATION OF THE FUNCTION KEYS ON THE GREAT CIRCLE MAP/ROTATOR CONTROL SCREEN

### ④ [F4(MODE)] Key

By pressing this key, the rotation control mode can be selected. With every momentary press, the mode changes as shown below. The mode is indicated in the middle of the Display.

*MANUAL* → *PRESET* → *MEMORY* → *MANUAL* .....

**MANUAL:** CW/CCW control is performed manually.

**PRESET:** Rotation to the “PRESET” direction is selected.

**MEMORY:** Rotation to one of the stored rotation memories is selected.



MODE Indicator

### ⑤ [F5(SLOW)] Key

When you want to slow down the speed of the rotation, this key is used. Normally, you will use the “100 %” value; once 100 % is selected, you typically will not need to use this key.

### ⑥ [F6(FAST)] Key

When you want to increase the speed of the rotation, this key is used. Normally, you will use the “100 %” value; once 100 % is selected, you typically will not need to use this key.

### ⑦ [F7(MAP)] Key

This key switches the Display between the Great Circle Map and the regular Rotator Control compass display.

**Advice:** If the Great Circle display is utilized, you probably already know the approximate location of the other station on the map; so even if the country name and the city name are not entered into the radio, the Great Circle Map provides a convenient tool for rotating the antenna to the optimum heading.

If your own location is not indicated at the center of the Great Circle Map, please set the local time (which registers the location where the radio is operated). If this is not done, the various functions of the World clock and Great Circle Map will not function correctly. Regarding the setting of the Local time, please see the “PLEASE READ THIS FIRST” section.

### ⑧ [DISPLAY] Key

Press this key momentarily to switch the Function key’s function between the “Page Select Key” and the “Function Key.”

Press and hold in this key to disable the Function keys (except this key).



“GREAT CIRCLE MAP” DISPLAY

# GREAT CIRCLE MAP / ROTATOR CONTROL FUNCTION

## MANUAL MODE

It is possible to operate/control the rotator manually. If the other station's location has been entered, the location of the other station and yours will be connected with a line on the Great Circle Map, and you can rotate the antenna manually to the direction of the other station.

### MANUAL OPERATION

Use the [F2(CCW)] key to rotate the antenna counter-clockwise, or the [F3(CW)] key to cause clockwise rotation of your antenna.

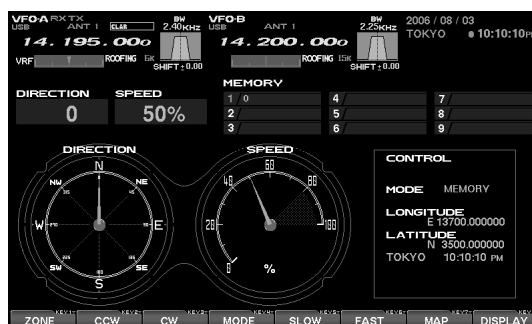

"REGULAR COMPASS" DISPLAY

### MANUAL OPERATION (USING THE GREAT CIRCLE MAP)

1. Press the [F4(MODE)] key, as necessary, to select the "PRESET" or "MANUAL" mode. The mode is indicated in the middle of the Display.
2. Press the [F7(MAP)] key to display the Great Circle Map on the screen. If you know the approximate location of the country of the other station, rotate your antenna by looking the map and rotating the antenna in the appropriate direction.
3. If you want to display a station on the Great Circle Map, start by pressing the [F1(ZONE)] key; the World Map's zones will be displayed.



"GREAT CIRCLE MAP" DISPLAY

Select the Zone of the other station by pressing the [F1(▼)], [F2(▲)], [F3(◀)], and [F4(▶)] keys, then press the [F7(SELECT)] key momentarily. The list of the countries in the selected Zone will be shown. Select the country name of the other station by pressing the [F1(▼)], [F2(▲)], [F3(◀)], and [F4(▶)] keys, then press the [F7(SELECT)] key momentarily. Now, the list of the city names within the selected country will appear, and you will need to select one of the city names by pressing the [F1(▼)], [F2(▲)], [F3(◀)], and [F4(▶)] keys. Now press the [F7(SELECT)] key.

*Note*; in some countries, there may be only one city in the country; select that one city anyway.

4. Press the [F8(EXIT)] key. Automatically the screen will revert to the Great Circle Map, and the location of the other station will plotted on the map, connected by a line to your location via the short path.
5. Use the [F2(CCW)] and [F3(CW)] keys to rotate your antenna system to the direction just plotted on the Display.

Provided by   
YAESU museum   
  
Downloaded by   
RadioAmateur.EU

# GREAT CIRCLE MAP / ROTATOR CONTROL FUNCTION

## PRESET MODE

The Preset mode lets you set the desired direction of the rotator in advance, so you can automatically rotate your Yaesu rotator to the designated direction. Use of a Yaesu Rotator (**G-800DXA**, **G-1000DXA**, or **G-2800DXA**) requires the connection of the optional T9101556 cable to the connector located on the back of the **FT-2000** transceiver.

1. Press the [**F4(MODE)**] key, as necessary, to select the “**PRESET**” mode.
2. Press the [**F7(MAP)**] key, if necessary, to bring up the Great Circle Map screen.
3. Press the [**F2(CCW)**] or [**F5(CW)**] key to set the Preset pointer to the direction of the other station's location.
4. Press the [**F5(START)**] key to engage hands-free rotation to the beam heading you just set up in the previous step.

You may stop the rotation manually by pressing the [**F5(START)**] key again.

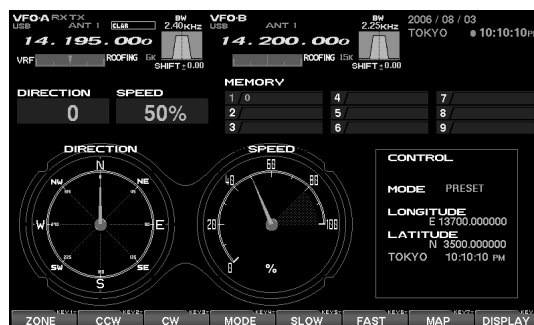

“REGULAR COMPASS” DISPLAY



“GREAT CIRCLE MAP” DISPLAY

# GREAT CIRCLE MAP / ROTATOR CONTROL FUNCTION

## MEMORY MODE

It is possible to rotate the antenna automatically to a direction or directions which you store into memory in advance. Use of a Yaesu Rotator (**G-800DXA**, **G-1000DXA**, or **G-2800DXA**) requires the connection of the optional T9101556 cable to the connector located on the back of the **FT-2000** transceiver.

### PROGRAMMING BEAM HEADINGS INTO MEMORY

1. Press the [**F4(MODE)**] key, as necessary, to select the “**PRESET**” or “**MANUAL**” mode.
2. Use the techniques learned previously to rotate the antenna to the desired beam heading.
3. Now press the [**F4(MODE)**] key to select the “**MEMORY**” mode.
4. Select the desired memory channel register by using the the [**F2(▼)**] key and [**F3(▲)**] keys, then press the [**F6(MW)**] key to memorize the programmed beam heading.

**Advice:** The maximum number of beam-heading memories which can be stored is 9.

If you have connected your after-market keyboard to the **DMU-2000**, you can append a name (tag) to the memory channel (maximum: 6 characters). It often is convenient to enter the callsign of a station, or perhaps a label such as “Europe” for easy reference. The method of entering the name tag into a memory is described below.

1. Use the [**F2(▼)**] key and [**F3(▲)**] keys to select the rotator memory register onto which you wish to append a name tag.
2. Press the keyboard’s [**ENTER**] key; the cursor on the screen will blink.
3. Use your keyboard to enter the name tag; a maximum of six characters may be utilized.

### MEMORY RECALL

1. Use the [**F2(▼)**] key and [**F3(▲)**] keys to select the desired location from the rotator memory list.
2. When you momentarily press the [**F5(MR/ERASE)**] key, the rotator will turn to the direction (beam heading) that has been memorized.

### ERASING MEMORY

1. Use the [**F2(▼)**] key and [**F3(▲)**] keys to select the rotator memory you wish to erase.
2. Press the [**F5(MR/ERASE)**] key for 2 seconds to erase the memory’s data.

**Note:** Once erased, memory data cannot be restored!

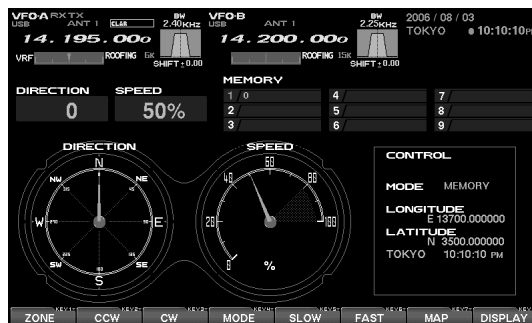

“REGULAR COMPASS” DISPLAY



“GREAT CIRCLE MAP” DISPLAY



# USING THE MEMORY CHANNEL LIST

## ABOUT THE MEMORY CHANNEL LIST

This is the screen which displays the **FT-2000** transceiver's memory channels. On the list, the channel number, ID tag, frequency, and operating mode are shown. The **FT-2000** has an extensive memory system of 99 channels that may be arrayed into up to six groups, and you can check the entire memory system's status by viewing this screen.

If the "Memory Channel List" screen does not initially appear, press the **[DISPLAY]** key to switch the Function key's function to "Page Select Key," then press the **[F7(MCH LIST)]** key momentarily to display the "Memory Channel List" screen. Next, press the **[DISPLAY]** key again to switch the Function key's function to the "Function Key."

## EXPLANATION OF THE FUNCTION KEYS ON THE MEMORY CHANNEL LIST SCREEN

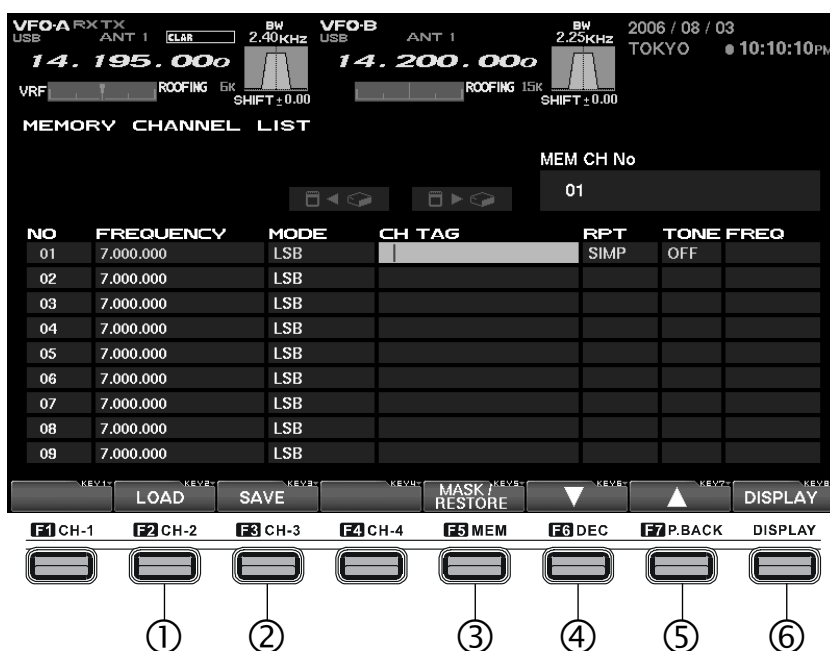

### ① [F2(LOAD)] Key

Press this key to load memory data previously saved on the CF card to the transceiver.

### ② [F3(SAVE)] Key

Press this key to save the current memory data to the CF card.

### ③ [F5(MASK/RESTORE)] Key

It is possible to erase the currently-selected memory channel's data by pressing this key. If you want to restore the erased memory data, press this key again after erasing the memory.

### ④ [F6(▼)] Key

Use this key to move the highlighted field on the memory list downward.

### ⑤ [F7(▲)] Key

Use this key to move the highlighted field on the memory list upward.

### ⑥ [DISPLAY] Key

Press this key momentarily to switch the Function key's function between the "Page Select Key" and the "Function Key."

Press and hold in this key to disable the Function keys (except this key).

# USING THE MEMORY CHANNEL LIST

## ERASING A MEMORY CHANNEL/RESTORING AN ERASED MEMORY CHANNEL

You can erase data from any memory channel which is no longer needed. It also is possible to restore (immediately after deletion) erased memory channel data, in case you erase something by accident.

1. Select the memory channel you want to erase by pressing the [F6(▼)] key or [F7(▲)] key.
2. To mask the current memory's contents, press the [F5(MASK/RESTORE)] key. If you want to restore the erased memory channel's data, press the [F5(MASK/RESTORE)] key once more.

**Advice:** A memory channel which has been erased can be restored by pressing the [F5(MASK/RESTORE)] key again, but if any other key has been pressed after you erased the memory channel, the memory cannot be restored.



[F5(MASK/RESTORE)] Key

## SAVING MEMORY DATA

Memory data from the FT-2000's internal memory may be saved to the supplied Compact Flash (CF) card.

1. Press the [F3(SAVE)] key to open the Save window. If there are several file names stored, select the desired file by pressing the [F6(▼)] key and [F7(▲)] keys.



2. If you want to over-write the file name, go to step 3. If you do not want to over-write the data on an existing file name, and want to save the data in the new file: press the [F4(FILE)] key; now enter the desired file name from your keyboard (the file extension will be ".mcl" for Menu data).
3. Press the [F3(GO)] key to save the data into the CF card. If you want to cancel the saving of the memory data, press the [F2(CANCEL)] key.

**Advice:** When the ERROR message "CF CARD IS NOT READY" appears on the display, please confirm that the CF card is inserted correctly into its slot.

When memory data is saved in the CF card under a previously-used file name, the old/previous data will be revised and the old data erased.



[F3(SAVE)] Key



[F3(GO)] Key

# USING THE MEMORY CHANNEL LIST

## LOADING MEMORY DATA

Loading Memory Data from the CF Card to the Memory on the **FT-2000**.

1. Press the **[F2(LOAD)]** key to open the memory loading window.

If there are multiple file names stored on the CF card, select the desired file by pressing the **[F6(▼)]** key and **[F7(▲)]** key.



2. Press the **[F3(GO)]** key to commence loading of the memory data to the transceiver. If you wish to cancel the download, press the **[F2(CANCEL)]** key.

**Advice:** When the ERROR message “CF CARD IS NOT READY” appears on the display, please confirm that the CF card is inserted correctly into its slot.

When the memory data is loaded from the CF card to the memory on the **FT-2000**, all previous data will be overwritten and the old data will be erased. Please remember to save the current memory contents to the CF card, if you want to retrieve it later.



↑  
**[F2(LOAD)]** Key

↓



↑  
**[F3(GO)]** Key

# USING THE MENU MODE

## ABOUT THE MENU MODE

The **FT-2000**'s Menu mode includes 147 different settings, used for configuration of various transceiver features and functions that generally are set once, and then seldom changed. Press the [**MENU**] button momentarily to bring up the Menu Mode Screen.

*Advice:* The 147 items in the menu are grouped into 18 categories, and the groups are displayed at the left top of the menu list screen. It will be most convenient for you if you initially select the group, by rotating the Main Dial, and then select the individual menu item you want to work on.

### GROUP NAMES IN THE MENU

#### **AGC**

This group is used for the setting up the AGC timing parameters. The AGC characteristics can significantly affect the performance of the receiver, and we recommend that you not change the settings in normal use. If the setting gets changed by accident, please do the menu mode reset described on page 11.

#### **DISPLAY**

This is the display-related group, related to the Dimmer, Display color, clarifier display, etc.

#### **DVS**

This is the group relating to the setting of the input/output level of the voice memory.

#### **KEYER**

Setup of the configurations of the internal electronic keyer.

#### **GENERAL**

This group covers miscellaneous items which are not included in other groups.

#### **S IF SHIFT**

Setup of the center frequency of the Sub band (VFO-B) receiver's IF filter.

#### **MODE AM, MODE CW, MODE DATA, MODE FM, MODE RTTY, MODE SSB**

These are the groups related to items associated with different operating modes, and which may be configured separately.

#### **RX AUDIO**

This is the group related to the setting of the headphones and internal speakers.

#### **RX DSP**

This group pertains to the settings for the RX filter bandwidth, as well as other receiver filter configurations.

#### **SCOPE**

This group is used to set the starting frequency for the Spectrum scope on the FIX mode (band by band).

#### **TUNING**

This is the Dial step configuration group.

#### **TX AUDIO**

This group is used for setup of the parametric equalizer.

#### **TX GNRL**

This group is used for setting the TX RF output, configuration of linear amplifier switching, etc.

Provided by   
YAESU museum

Downloaded by   
RadioAmateur.EU

## EXPLANATION OF THE FUNCTION KEYS ON THE MENU MODE SCREEN



### ① [F2(Load)] Key

Press this key to download previously-used Menu settings from the CF card to the transceiver.

### ② [F3(SAVE)] Key

Press this key to save the current Menu settings to the CF card.

### ③ [F4(◀)] Key

Use this key to select the configuration value of the menu item. The value may also be changed by rotating the [SUB VFO-B] knob.

### ④ [F5(▶)] Key

Use this key to select the configuration value of the menu item. The value may also be changed by rotating the [SUB VFO-B] knob.

### ⑤ [F6(▼)] Key

This is the “down” key for scrolling through the menu mode list. The items also can be selected by rotating the Main Tuning Dial knob.

### ⑥ [F7(▲)] Key

This is the “up” key for scrolling through the menu mode list. The items also can be selected by rotating the Main Tuning Dial knob.

When you have completed making all changes to the menu setting(s), **press the [MENU] button for 2 seconds to lock in the changes.** If you do not want to keep the changes, press the [MENU] button only momentarily; the radio will come back to the previous menu status that was present before you made the changes.

# USING THE MENU MODE

## MENU MODE CONFIGURATION CHANGES

When you want to change something in a menu mode setting, follow the procedure described below.

1. Press the **[MENU]** button momentarily.  
The monitor will display the Menu page. Included on this page will be the Menu Group, Menu Item Name, Menu Item Number, and the current status (setting) for each Menu item.
2. Use the Main Tuning Dial, or the the **[F6(▼)]**/**[F7(▲)]** keys, to select the Menu item you wish to work on.
3. Use the **[SUB VFO-B]** knob, or the **[F4(◀)]**/**[F5(▶)]** keys, to change the setting of the selected Menu item.
4. Press and hold the **[MENU]** button for 2 seconds to save (within the transceiver) the new setting; the menu screen will close, and you will then return to the screen that was in use before entering the menu mode.  
If you press the **[MENU]** button momentarily to exit, the new settings will not be saved, and you will exit from the menu mode without retaining the new configuration.



**"MENU" PAGE**

### MENU MODE RESET

It is possible to reset (only) the Menu mode settings back to their factory default. Do this if you want to clear all settings out, and start fresh with the original values.

1. Turn off the radio.
2. Turn the radio on while pressing and holding in the **[MENU]** button.

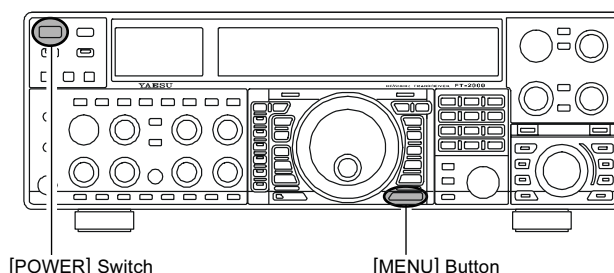

## SAVING MENU CONFIGURATION DATA

You may save the current Menu configuration data to the CF card, for archive purposes or for quick changes in extensive transceiver settings for different operating applications.

1. Press the **[F3(SAVE)]** key to open the Save window. If there are multiple file names already stored, select the desired file by pressing the **[F6(▼)]** and **[F7(▲)]** keys.



2. If you want to over-write the file name, go to step 3. If you do not want to over-write the data on an existing file name, and want to save the data in the new file: press the **[F4(FILE)]** key; now enter the desired file name from your keyboard (the file extension will be “.mep” for Menu data).
3. Press the **[F3(GO)]** key to save the data into the CF card. If you wish to cancel the saving of the data, press the **[F2(CANCEL)]** key.

**Advice:** When the ERROR message “**CF CARD IS NOT READY**” appears on the display, please confirm that the CF card is inserted correctly into its slot.

When the memory data is saved in the CF card under a previously-used file name, the old/previous data will be over-written and the old data erased.

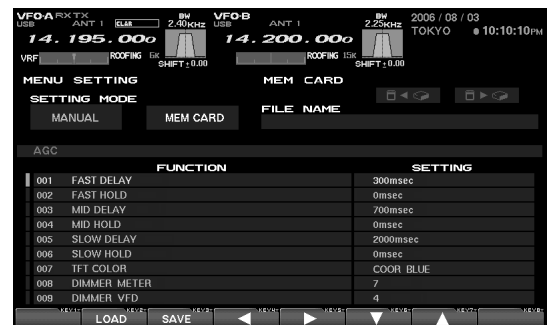

[F3(SAVE)] Key



[F3(GO)] Key

## LOADING MENU DATA

Loading Menu Data from the CF Card

1. Press the **[F2(LOAD)]** key to open the “Load” window. If there are several file names stored, select the desired file by pressing the **[F6(▼)]** and **[F7(▲)]** keys.



2. Press the **[F3(GO)]** key to download the Menu configuration from the CF card to the radio. To cancel the download, press the **[F2(CANCEL)]** key.

**Advice:** When the ERROR message “**CF CARD IS NOT READY**” appears on the display, please confirm that the CF card is inserted correctly into its slot.

When the Menu data is loaded from the CF card to the Menu on the **FT-2000**, the old/previous data will be over-written, and the old data erased.



[F3(SAVE)] Key



[F3(GO)] Key



Copyright 2006  
VERTEX STANDARD CO., LTD.  
All rights reserved

No portion of this manual  
may be reproduced without  
the permission of  
VERTEX STANDARD CO., LTD.

Printed in Japan  
0611X-AY

Provided by   
YAESU museum   
  
Downloaded by   
RadioAmateur.EU

