

INSTRUCTION MANUAL FTV-250

Downloaded by

Amateur Radio Directory

YAESU MUSEN CO., LTD.

TOKYO JAPAN

FTV-250

TWO METER TRANSVERTER



The Model FTV-250 is an all solid-state two meter transverter designed for two meter operation in conjunction with the FT-101/277, FL-101/FR-101 or FT-201 series HF transceiver.

Advanced solid-state circuit offers unsurpassed stability and clean signals at an input of 20 watts on 144 through 148 MHz. The spurious radiations are extremely reduced or eliminated by the use of dual balanced mixer in the exciter stage.

The low noise and high gain dual-gates MOS FET provides superior receiver front end.

The entire two meter band is divided into two segments which are selected by a switch on the front panel. The switch also selects HF and VHF antenna automatically.

The transverter is self-contained. It may be operated from 100/110/117/200/220 or 234 volt 50/60 Hz AC when the power transformer is appropriately wired. The FTV-250 is normally supplied for 117 volt AC and 12 volt DC operation.

The transverter weighs approximately 6 kg and is 210 m/m wide, 150 m/m high and 290 m/m deep.

SPECIFICATIONS

TRANSMITTER

Input Frequency	28 - 30 MHz
Input Voltage	3 Volts RMS
Input Impedance	Approximately 8 kilo ohms
PA Input	20 watts DC
Output Frequency	144 - 148 MHz
Output Impedance	50 ohm unbalanced
Spurious Radiation	Better than -60 dB

RECEIVER

Input Frequency	144 - 148 MHz
Antenna Impedance	50 ohm unbalanced
Sensitivity	SSB/CW: Better than S/N 20 dB at 0.5 u Volt antenna input signal AM: Better than S/N 10 dB at 1 u Volt antenna input signal
Internal Spurious	Better than 0 dB
Output Frequency	28 - 30 MHz
Output Impedance	50 ohms
Power Requirements	100/110/117/200/220/234 Volt 50/60 Hz AC or 13.5 Volt DC negative ground
Power Consumption	AC 0.75 VA DC 2.6 A at 10 watts antenna output
Size	210 (W), 150 (H), 290 (D) m/m
Weight	Approximately 6 kg

*The above values are in conjunction with FT-101E.

Downloaded by

Amateur Radio Directory

SEMICONDUCTORS

FET			
2SK19GR	3	2SK19Y	1
3SK40M	1		
SI TRANSISTOR			
2SC372Y	2	2SC373	1
2SC730	1	2SC735Y	1
2SC741	1	2SC784R	3
2SD313D	2	2N3055	1
2N5591	1	MRF208	1
GE DIODE			
1N60AM	2	1S188FM	1
SI DIODE			
1S1555	5	1S1941	3
10D-1	3	DS-130YD	1
M4B-5	1		
ZENER DIODE			
1N4740	1	WZ061	1
WZ090	1	WZ110	1
VARACTOR DIODE			
1S1658	2	BB105GM	7
LED			
SL103	3		

ACCESSORIES

AC Power Cord	1	Coaxial Plug MP-7	1
Coax. Cable (A)	1	Fuse 2A	1
Coax. Cable (B)	1	DC Cord is optional.	
Coax. Cable (C)	1		

CONTROLS AND SWITCHES

FRONT PANEL

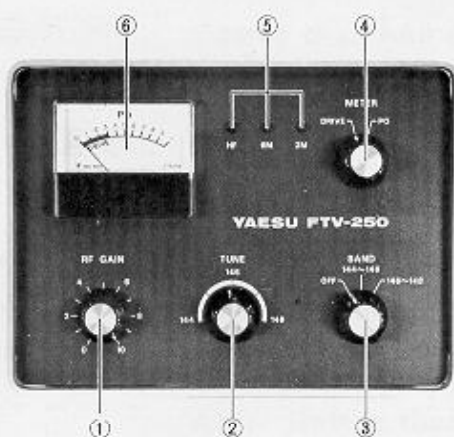

- (1) RF GAIN The RF GAIN controls the gain of RF amplifier stage.
- (2) TUNE This control tunes the signal circuit for both transmitter and receiver for optimum performance.
- (3) BAND The BAND switch is a three position switch that selects the two meter amateur band. In the OFF position, the FTV-250 transverter is inoperative and the HF or six meter transverter, if used, will become operational. If the BAND switch of six meter transverter, when connected, is also in the OFF position, the HF antenna is automatically connected to the HF equipment.
- (4) METER This switch selects the meter mode to read exciter drive level and a relative power output.
- (5) HF 6M 2M The lamp shows the band in use.
- (6) METER The METER indicates the relative power output and drive level.

REAR PANEL

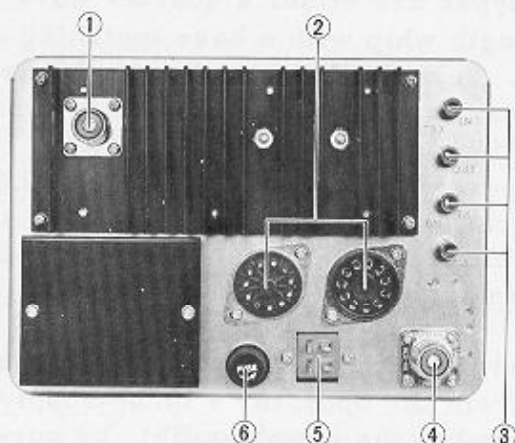

- (1) 2M ANT Two meter antenna is connected here.
- (2) 2M 6M Refer to the interconnection diagram.
- (3) TRX (IN-OUT), 6M (TX-RX)
RF input and output connectors. Refer to the interconnection diagram.
- (4) HF ANT HF antenna is connected here. If FTV-650B is also connected, the HF antenna is connected to the FTV-650B as illustrated in the interconnection diagram.
- (5) POWER Power receptacle. AC power cord is supplied with the transverter.
- (6) FUSE Fuse holder. For AC operation, a 1 amp fuse is used for 100/117 volt and 0.5 amp fuse on 200/234 volt operation.

INSTALLATION

The FTV-250 Transverter has been primarily designed for combination use with our FT-101/FT-201 transceivers and FL-101/FR-101 transmitter/receiver. The power supply is selfcontained.

The transverter should be placed in a location that has adequate space to permit free air circulation around the heat sink on the back panel.

The antenna and its location are the most important consideration. The antenna should always be as high and in the clear as possible, and a minimum distance of 10 feet should be maintained between the VHF and other antennas.

The most popular antenna types are either a quarter wave length whip with unity gain or a 5/8 wave length whip with a base matching device affording approximately 3.5 dB gain. A multi-element Yagi antenna is also widely used for DX communications.

To minimize loss in the antenna system, the use of the shortest length of the coaxial cable that is practical is recommended, avoiding any sharp angles or kinks. Use type RG-8U cable if the cable length exceeds 25 feet, while RG-58/U may be used for shorter lengths.

The transverter is designed for use in many areas of the world where the supply voltage may differ from the operator's local supply voltage. Therefore, before connecting the AC cord to the power outlet, be sure that the transformer windings agree with the local supply voltage. If not, please refer to Figure 1 for rewiring of the transformer primary connections.

CAUTION

PERMANENT DAMAGE WILL RESULT IF IMPROPER AC SUPPLY VOLTAGE IS APPLIED TO THE TRANSVERTER. OUR WARRANTY DOES NOT COVER DAMAGES CAUSED BY SUCH IMPROPER SUPPLY VOLTAGE.

Be sure proper fuse is used according to the local supply voltage; 1 amp for 100 - 117 volts and 0.5 amp for 200 - 234 volts.

For DC operation, use the DC power cord which may be available through your dealer.

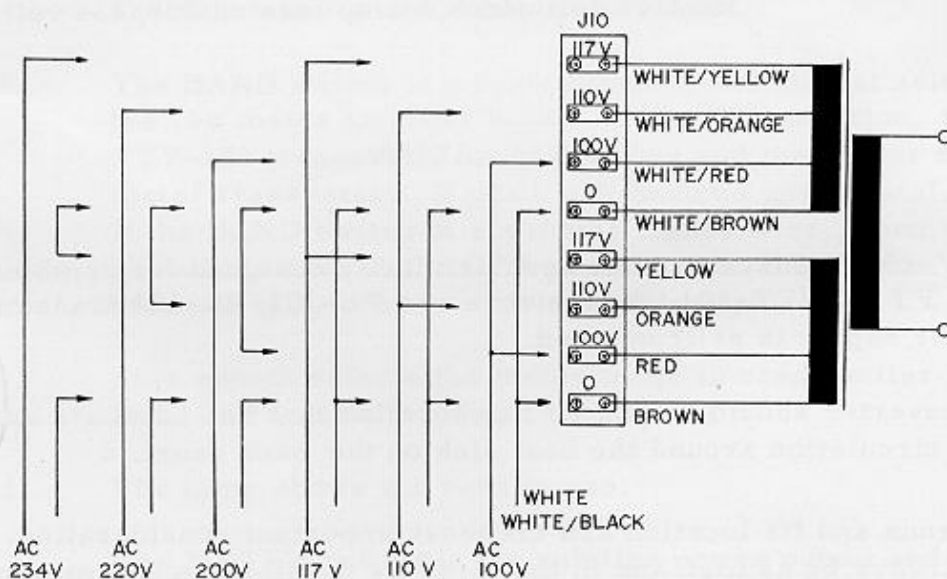

Figure 1 Transformer Primary Wiring

INTERCONNECTIONS

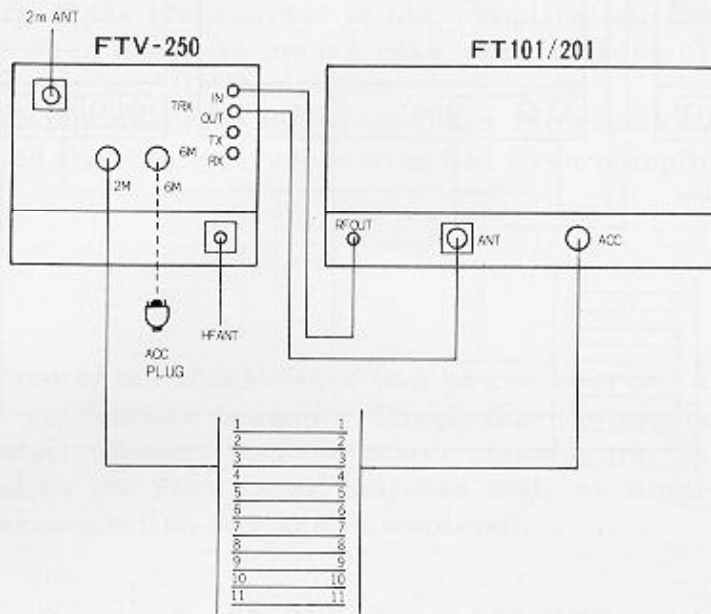

Figure 2 FTV-250 and TRANSCEIVER Combination

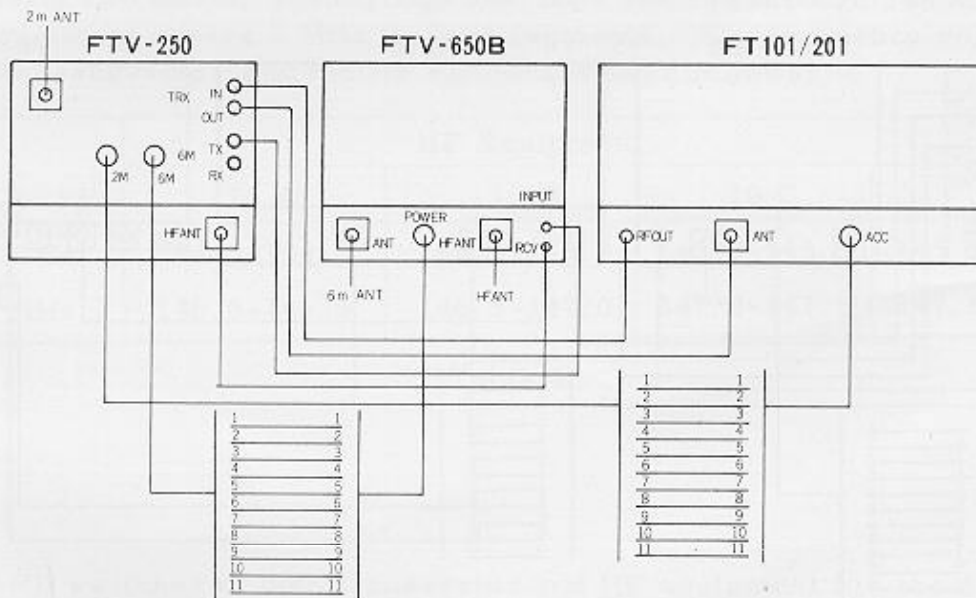

Figure 3 FTV-250, FTV-650B and TRANSCEIVER Combination

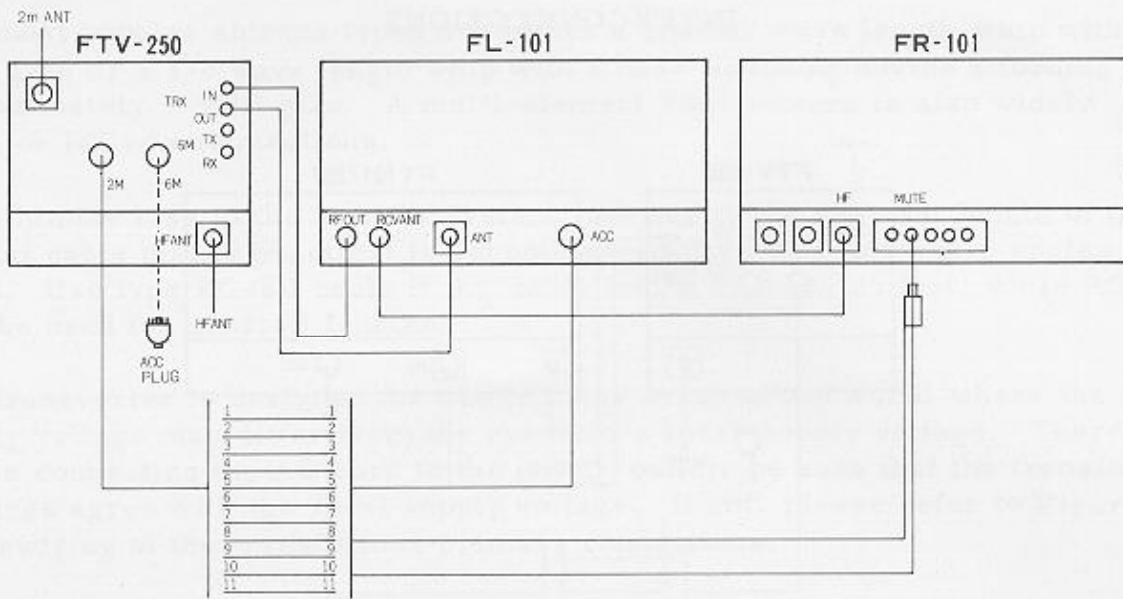

Figure 4 FTV-250 and FL/FR-101 Combination

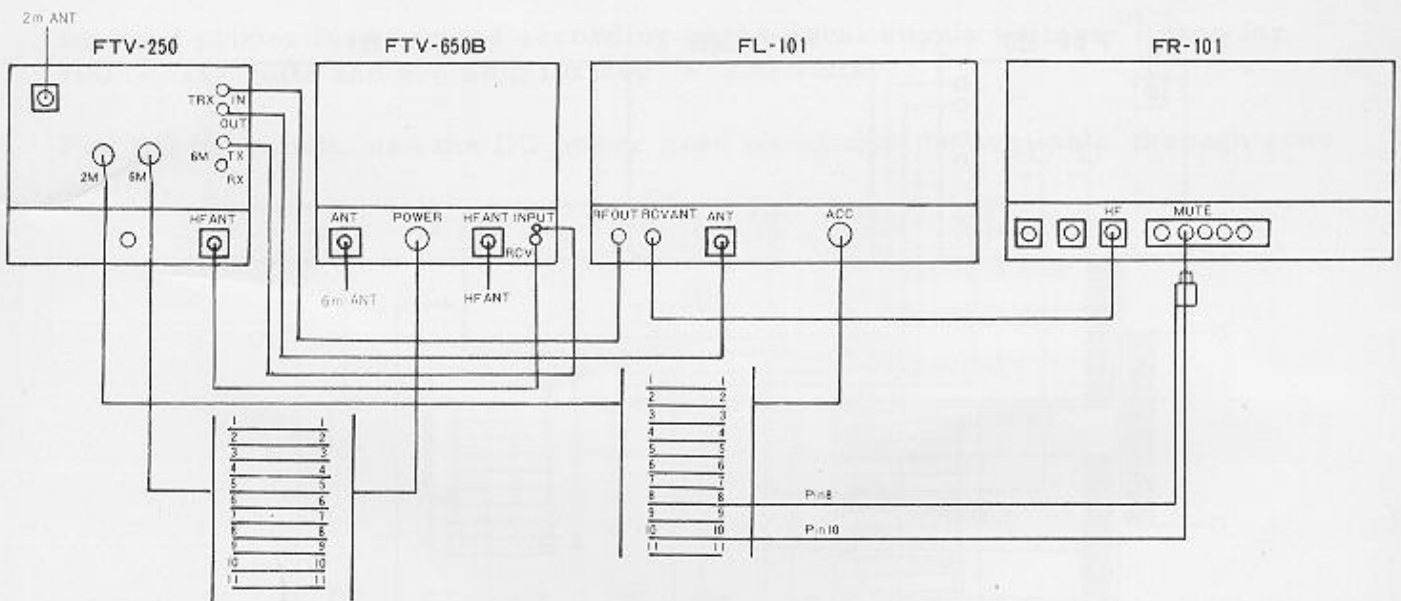

Figure 5 FTV-250, FTV-650B and FL/FR-101 Combination

OPERATION

The tuning procedure of the transverter is not complicated, however, care should be exercised when tuning to insure peak performance of the two combined equipments, transverter and HF equipment.

The following paragraphs describe the procedures for receive and transmit tuning. It is assumed that the interconnection has been completed as shown on page 7 and 8.

INITIAL CHECK

Refer to the connection of the transverter to a power source, and carefully examine the unit for any visible damage. Check that the controls and switches are operating normally. Ensure that the power transformer winding (voltage specification marked on the rear panel) matches with the supply voltage. Ensure that the interconnection has been completed.

FREQUENCY SELECTION

The frequency is determined by the main tuning dial of the HF equipment in conjunction with the transverter BAND switch setting. The transverter BAND switch selects two bands, 144 through 146 MHz and 146 through 148 MHz. The HF equipment covers 2 MHz in four segments. The frequency relation between the transverter and the HF equipment is as follows;

TRANSVERTER	HF Equipment			
	10 A	10 B	10 C	10 D
144 - 146 MHz	144.0-144.5	144.5-145.0	145.0-145.5	145.5-146.0
146 - 148 MHz	146.0-146.5	146.5-147.0	147.0-147.5	147.5-148.0

Table 1

RECEIVE

Set the BAND switches of both transverter and HF equipment for the desired band and tune to the signal by the main tuning dial of the HF equipment. Peak the TUNE control for maximum S-meter reading on the HF equipment. Adjust the RF GAIN of the transverter to reduce interferences from strong signals.

TRANSMIT

CAUTION:

A DUMMY LOAD OR ANTENNA SHOULD BE CONNECTED TO THE ANTENNA TERMINAL FOR TUNE UP OF THE TRANSVERTER OR THE HF EQUIPMENT.

Set the transverter BAND switch to OFF position. Prior to tuning the transverter, the HF equipment must be tuned to 10 meter band with a dummy load connected to the HF antenna terminal of the transverter. Tune up the HF equipment into the dummy load at the desired frequency given from Table 1.

After completion of the HF equipment tune up, set the MIC GAIN and CARRIER controls to fully counterclockwise position, 0 mark. Set the transverter BAND switch to the desired band and the METER switch to DRIVE position.

Set the HF equipment to TUNE position and set the HF equipment to the transmit mode by the PTT switch. Increase the CARRIER control until the transverter meter reading starts to increase. Peak the PRESELECTOR of the HF equipment and the DRIVE control of the transverter for maximum meter reading. Adjust the CARRIER control until the meter indication stays in the top of the green portion of the meter scale at maximum drive. Set the MODE switch to SSB mode. (Usually the USB mode is used in 2 meter band.)

Advance MIC GAIN until the meter indication goes up to the upper limit of the green portion on voice peaks when speaking normally into the microphone.

On AM mode, the CARRIER LEVEL should be set to the 20% of PO indication on CW mode with the METER switch at PO position.

The MIC GAIN should be set at a level where the meter indication kicks up slightly, with voice peaks.

It is recommended to set the METER switch to the DRIVE position and observe the meter indication so as not to exceed the green portion during operation. Excessive drive may cause the distortion and splatter.

CIRCUIT DESCRIPTION

The following block diagram and circuit description will provide you with better understanding of the transverter.

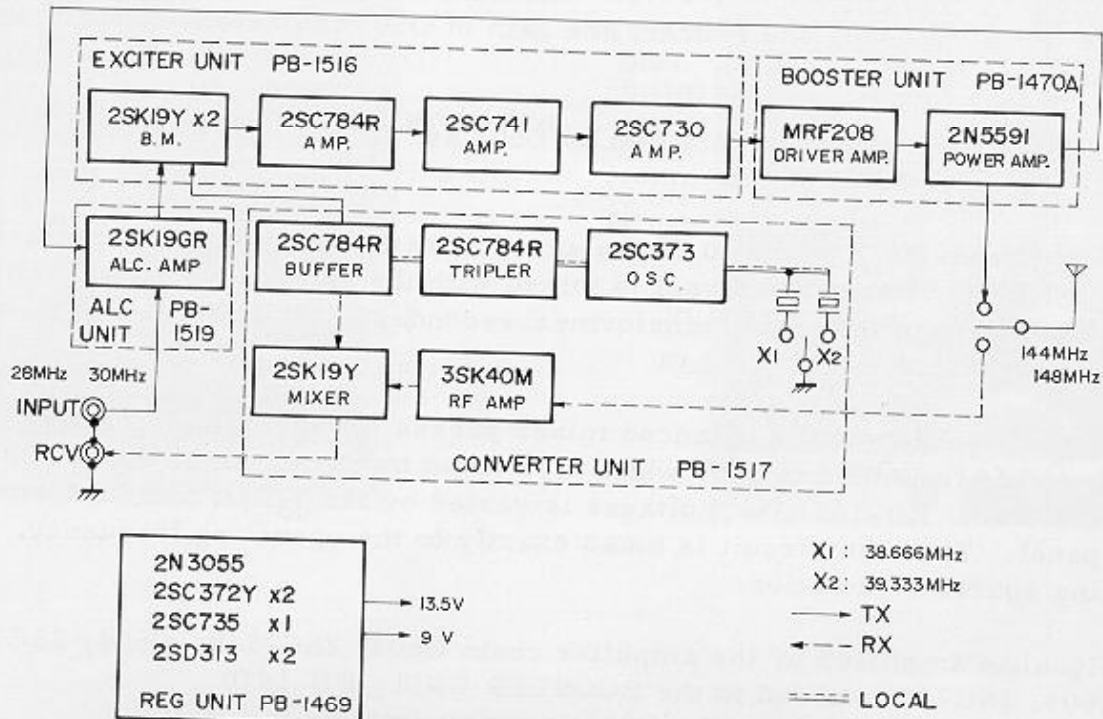

FTV-250 BLOCK DIAGRAM

RECEIVER

The 144 MHz input signal from the antenna is fed through an antenna relay, RL1201 to pin 5 of the CONVERTER UNIT, PB-1517. The signal is amplified by the RF amplifier Q401, 3SK40M, dual gate MOS FET, and then fed to the gate of the mixer Q402, 2SK19Y, where the input signal is heterodyned with a local signal into 28 MHz IF signal.

The input and output circuits of the RF amplifier utilize a double tuned circuit, which is sharply tuned to the frequency of the received signal with the varactor diodes D401 through D404. Voltage to BB-105-GM is controlled by the TUNE control on the front panel, thus reducing cross and intermodulation.

The heterodyne crystal oscillator Q403, 2SC373, oscillates at 38.66 MHz for 144 - 146 MHz or 39.33 MHz for 146 - 148 MHz depending upon the BAND switch position. This signal is fed to the tripler Q404, 2SC784R, producing 116 or 118 MHz heterodyne signal. The heterodyne signal is fed through the buffer amplifier Q405, 2SC784R, to the receiver mixer 2SK19Y and the exciter mixer 2SK19Y. The converted 28 through 30 MHz IF signal is tuned by T401 and a varactor diode 1S1658 and then fed through the antenna change-over relay to the output terminal J5.

Downloaded by



Amateur Radio Directory

TRANSMITTER

The 28 MHz signal from the RF output of the HF transmitter is fed through the antenna relay to pin 6 of ALC AMP UNIT, PB-1519. The 28 MHz signal is amplified by the ALC (Automatic Level Control) amplifier Q501, 2SK19GR, and fed to the EXCITER UNIT, PB-1516. The ALC voltage is fed through pin 7 to the gate circuit of Q501 and reduces the gain of Q501 to prevent distortion caused by over drive.

A part of the input signal is rectified by D501 and D502, 1S1555, and used to indicate the drive level on the meter.

The output from Q501 is fed to the balanced mixer, consisting of Q601 and Q602, 2SK19GR, where the signal is mixed with the heterodyne signal delivered to the center tap of the input transformer secondary, producing a 144 through 148 MHz signal.

The output signal from the balanced mixer passes through tuned circuits consisting of L601, L602 and L603 which are tuned by the varactor diodes D602, D603 and D604, BB-105-GM. Voltages is varied by the TUNE control from the front panel. Thus the circuit is tuned exactly to the operating frequency, reducing spurious radiation.

The signal is amplified by the amplifier chain Q603, 2SC784R, Q604, 2SC741 and Q605, 2SC730, and fed to the BOOSTER UNIT, PB-1470. The output signal level from the Q605 is approximately 0.1 watt.

The signal from the EXCITER UNIT is fed to the BOOSTER UNIT and amplified by the driver amplifier Q1201, MRF208, and the final amplifier Q1202, 2N5591, which delivers 10 watts of RF power to the antenna through two stage lowpass filter and the antenna relay.

The bias voltage is stabilized at 9 volts by a zener diode D1209, 1N4740. Two diodes D1201 and D1202, 10D1, are used to protect the power transistors from damage due to heating. A small portion of the RF output is rectified by a diode D1203, 1S188FM, which delivers a resulting DC voltage to the meter where it provides an indication of the relative power output.

The DC voltage obtained from rectifying a small portion of the RF output by the ALC diode D1204, 1S-1555, which is biased by the ALC threshold control VR-1201, is applied to the gate of Q501 in the ALC AMP unit.

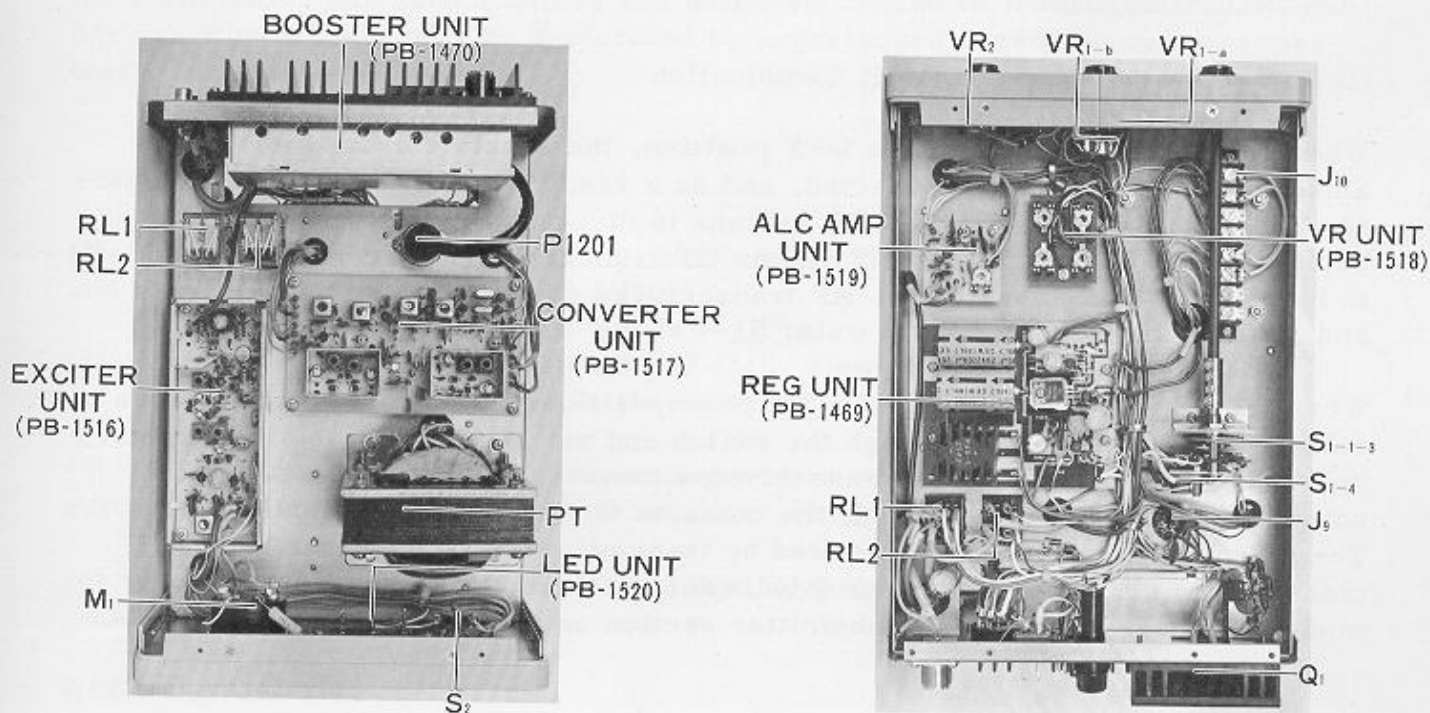

Top View

Bottom View

Downloaded by

 Amateur Radio Directory

POWER SUPPLY

The power supply has been designed to operate from 100/110/117/200/220 or 234 volts AC 50/60 Hz or 12 volts DC negative ground.

Inserting the appropriate power plug into the rear panel receptacle makes the necessary connections to operate the supply in either AC or DC mode.

For AC operation, the DC voltage is supplied from the bridge connected rectifier unit D1501, M4B-5, which is connected to 17.5 volt secondary winding of the power transformer. The DC voltage is regulated at 13.5 volts by the voltage regulator circuit consisting of Q1501, 2SD313D, Q1, 2N3055 and Q1502, 2SC372Y.

The 13.5 volt voltage is further stabilized at 9 volts by the voltage regulator circuit consisting of Q1503, 2SC372Y, Q1504, 2SD313D and Q1505, 2SC372Y and supplied to the receiver circuit and the heterodyne oscillator circuit.

For DC operation, the positive voltage is connected to pin 3 and the negative voltage to pin 4 of the power receptacle. To protect the circuit from reverse connection of the DC voltage, D2, DS130YD, conducts heavily with reverse polarity connection to blow the line fuse in the DC cord.

CONTROL CIRCUITS

(1) FTV-250 and TRANSCEIVER Combination

When the BAND switch is in the OFF position, the supply voltage for the antenna relay RL-1 is disconnected, and as a result, DC or AC supply voltage for FTV-250 is disconnected. HF antenna is directly coupled through the relay contacts and J5 (TRX OUT) to the HF transceiver. 12.6 volts is supplied to heat up the final tubes of the HF transceiver, connecting pin 2 of J2 (2M) and J3 (6M) through the fourth wafer S1-4 of the BAND switch.

When the BAND switch is at 144 - 148 MHz positions (2 meter operation) the relay voltage is supplied through the switch and the relay activates for 2 meter operation, connecting the HF transceiver antenna jack, J5 to the 28 MHz IF output of the transverter through the contacts of the antenna relay RL-2. The antenna relay RL-2 is controlled by transmit-receive operation of the HF transceiver. The RL-2 supplies 9 volts for the receiver section on receiver mode and 13.5 volts for the transmitter section on transmit mode.

(2) FTV-250, FTV-650B and TRANSCEIVER Combination

In this combination, the HF antenna is connected to the 6 meter transverter and HF antenna terminal of the FTV-250 is connected to RCV jack of the FTV-650B as illustrated in the interconnection diagram. With the BAND switch at OFF position, the HF transceiver can be operated as described above and, in addition, 6 meter transverter can be operated as follows:

Signal from the HF antenna is fed to the HF transceiver through RCV jack of FTV-650B, J8 (HF ANT), RL-1 and J5 (TRX OUT). On transmit, on 6 meter band, 28 MHz signal from the HF transceiver is fed through J4 (TRX IN), RL-1 and J6 (6M TX) to the input terminal of the FTV-650B.

When the BAND switch of FTV-650B is OFF, the FTV-250 operates as described in the above paragraph.

MAINTENACE & ALIGNMENT

The FTV-250 transverter has been carefully aligned and tested at factory prior to shipment. With normal usage, it should not require other than the usual attention given to electronic equipment. Service or replacement of major parts may require subsequent realignment, but under no circumstances should realignment be attempted unless the operation of the transverter is fully understood,

the malfunction has been analyzed and definitely traced to misalignment. Service work should only be performed by experienced personnel using proper test equipment.

TEST EQUIPMENT REQUIRED

- (1) RF Signal Generator with 1 volt output at an output impedance of 50 ohms and a frequency coverage to 150 MHz.
- (2) Vacuum Tube Volt-Ohm-Meter (VTVM). Hewlett-Packard Model 401B, or equivalent with an RF probe workable up to 150 MHz.
- (3) Dummy Load, Yaesu YP-150, or equivalent with 50 ohm nonreactive load rated at 20 watt average power.
- (4) Frequency Counter, YC-355D, or equivalent workable up to 200 MHz.

REGULATOR UNIT, PB-1469

The voltage adjustment should be done with AC power supply.

13.5 volts; Connect a VTVM DC probe between the 13.5 volt terminal (positive) and ground (negative). Adjust VR1501 for exact 13.5 volt reading on the VTVM.

9 volts: Connect a VTVM DC probe between the 9 volt terminal (positive) and ground (negative) and adjust VR1502 for exact 9 volt reading on the VTVM.

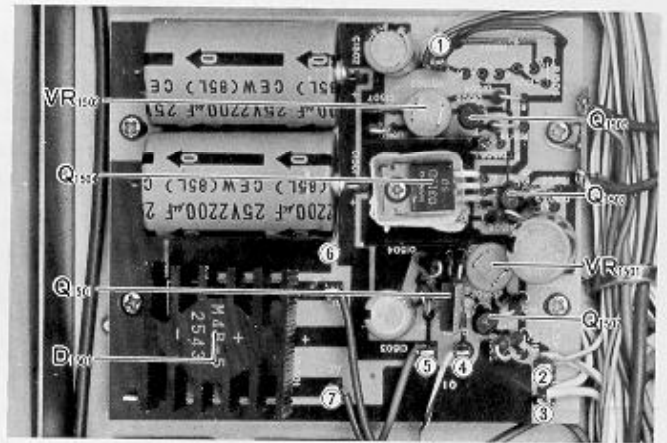

REG UNIT

VR UNIT, PB-1518

Set the TUNE control to 148 MHz setting. Connect the positive probe of VTVM to the center arm of forward potentiometer VR1a (TUNE control pot) located on front panel, and adjust VR104 for 5.5 volt reading on the VTVM. Set the TUNE control to 144 MHz setting and make sure that the voltage drops to 3 volts. Disconnect the VTVM positive probe and connect it to the center arm of rear potentiometer VR1b (TUNE control pot). Set the BAND switch to 146 - 148 MHz segment and the TUNE control to

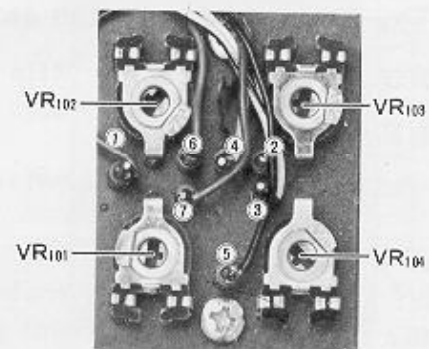

VR UNIT

148 MHz setting. Adjust VR101 for 4.3 volt on the VTVM. Set the TUNE control to 146 MHz and read the VTVM reading.

Set the BAND switch to 144 - 146 MHz segment and the TUNE control to 144 MHz. The VTVM reading should be same as the value measured at 146 MHz with the BAND switch setting of 146 - 148 MHz. Set the TUNE control to 146 MHz. The VTVM should read 4.3 volt.

If these values are not the same, adjust VR102 and VR103 alternately until the VTVM shows the same value at both high and low ends of both band segments.

CONVERTER UNIT, PB-1517

(1) Heterodyne Oscillator

Connect the VTVM RF probe to the base of Q404 and peak T402 for maximum VTVM reading, and set the T402 where the VTVM shows 80% of maximum reading.

Connect the VTVM RF probe and frequency counter to the base of Q405 and peak T403 for maximum VTVM reading.

Connect the VTVM RF probe to pin 8 and peak T403 for maximum VTVM reading.

The coils should be adjusted until the VTVM reading shows the same value with the BAND switch setting of 144 - 146 MHz and 146 - 148 MHz. The output frequency should be 116 MHz for 144 - 146 MHz and 118 MHz for 146 - 148 MHz band.

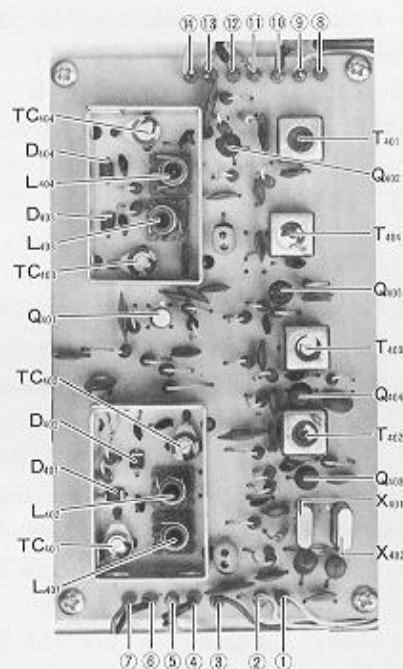

CONVERTER UNIT

(2) Receiver Front End

Prior to this alignment, the VR unit should be realigned as described in the preceding paragraph. Connect the output of the signal generator set at 146 MHz to the antenna connector.

Set the controls and switch as follows.

BAND	144 - 146 MHz
TUNE	146 MHz
RF GAIN	Fully clockwise position

Downloaded by

Amateur Radio Directory

Peak TC401, TC402, TC403, TC404 and T401 for maximum S-meter reading. After above procedures, make sure that the TUNE control indication matches to the frequency on the front panel when the receiver is tuned to 144 MHz and 146 MHz respectively.

Set the BAND switch to 146 - 148 MHz segment, and make sure that the TUNE control indicates 146 MHz, 147 MHz and 148 MHz when the receiver is tuned to these frequency respectively.

ALC AMP UNIT, PB-1519

Set the METER switch of FTV-250 to DRIVE position and the controls of the HF transceiver as follows.

BAND	10B
FREQUENCY	29 MHz
MODE	TUNE
CARRIER	0

Tune up the HF transceiver at 29 MHz and connect the VTVM RF probe to pin 6 of PB-1519. Increase the CARRIER control until the VTVM indicates 3 volt RMS. Connect the VTVM RF probe to pin 3 and peak TC501 for maximum VTVM reading.

Adjust VR501 until the meter shows 0.3 in the green scale.

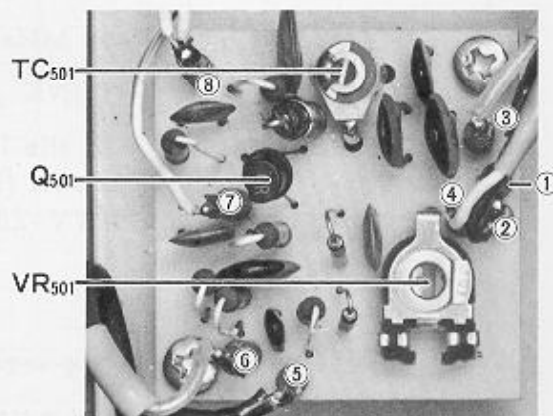

ALC AMP UNIT

EXCITER UNIT, PB-1516

Set the HF transceiver to the same condition as ALC AMP alignment. Set the TUNE control to 145 MHz and the BAND to 144 - 146 MHz. Connect the RF probe of VTVM to the RF input terminal of the BOOSTER UNIT. Peak TC601 through TC607 and T601 for maximum VTVM reading. Connect the VTVM RF probe to the hot end of L602 (junction point between L602 and C614). Adjust VR601 for minimum VTVM reading.

TC601 through TC607 should be realigned for maximum power output at 146 MHz after the completion of the BOOSTER UNIT realignment.

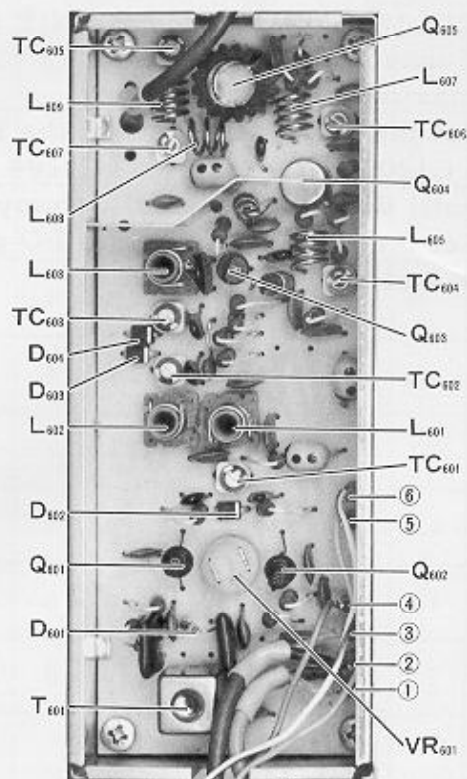

EXCITER UNIT

BOOSTER UNIT, PB-1470

Set the controls and switches as follows:

HF Transceiver

BAND	10 D
FREQUENCY	30 MHz
MODE	TUNE
CARRIER	At the level which gives 3 volt (RMS) RF input at FTV-250 RF input.

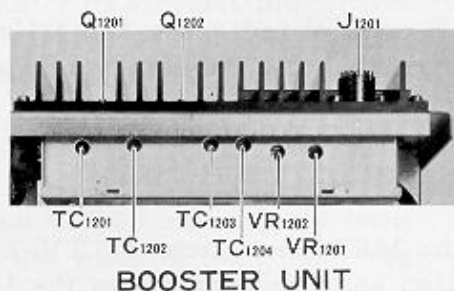

FTV-250

BAND	144 - 146 MHz
TUNE	146 MHz (12 o'clock position)

It is assumed that the FTV-250 alignment is completed, except the BOOSTER UNIT. Set the VR1201 and VR1202 to fully counterclockwise position. Connect the RF probe of VTVM to the base of Q1201 and peak TC1201, and TC605 and TC607 in the EXCITER UNIT for maximum VTVM reading.

Connect the RF probe of VTVM to the base of Q1202 and peak TC1202 for maximum VTVM reading.

Set the METER switch of the FTV-250 to PO position and peak TC1201, TC1202, TC1203 and TC1204 for maximum meter indication. Adjust VR1201 until the power meter (dummy) shows exactly 10 watts.

Set the METER switch to PO position and adjust VR1202 until the meter indicates 0.8 at 10 watts output.

CONNECTOR RESISTANCE CHART

UNIT	PIN	1	2	3	4	5	6	7	8	9	10	11	12	13	14
	MAIN CHASSIS	J ₁	∞	∞	∞	E	-	-	-	-	-	-	-	-	-
J ₂		550K	∞	∞	∞	∞	∞	∞	E	4.6K	∞	∞	-	-	-
J ₃		600K	∞	∞	∞	∞	∞	∞	E	10K	∞	130K	-	-	-
REG		82	95	95	50	28	10	10	-	-	-	-	-	-	-
CONVERTER		500K	500K	82	E	0	E	82	0	82	E	0	E	*3K	*18K
ALC AMP		E	E	∞	*1.2K	E	22K	180K	13	-	-	-	-	-	-
EXCITER		∞	E	0	*3K	*18K	13	-	-	-	-	-	-	-	-
BOOSTER	J ₉	E	0	*3K	*1.7K	82	13	13	-	-	-	-	-	-	-

POWEROFF
 BANDOFF
 RF GAINMAX
 METER SWITCH.....PO

Measured with 20 k ohm/V.
 Values are in OHM.

VOLTAGE CHART

UNIT		E (S)		C (D)		B (G)		UNIT		E (S)		C (D)		B (G)	
		R	T	R	T	R	T			R	T	R	T	R	T
MAIN CHASSIS	Q ₁	13.5	13.5	18.0	18.0	14.0	14.0	ALC AMP	Q ₅₀₁	0	0.95	0	13.0	0	0
REG	Q ₁₅₀₁	14.0	14.0	18.0	18.0	14.6	14.6	EXCITER	Q ₆₀₁	0	1.75	0	12.5	0	0
	Q ₁₅₀₂	9.0	9.0	14.6	14.6	9.6	9.6		Q ₆₀₂	0	1.75	0	12.5	0	0
	Q ₁₅₀₃	9.6	9.6	13.5	13.5	10.2	10.2		Q ₆₀₃	0	1.25	0	13.0	0	1.9
	Q ₁₅₀₄	9.0	9.0	13.5	13.5	10.2	10.2		Q ₆₀₄	0	0.75	0	13.0	0	1.65
	Q ₁₅₀₅	6.0	6.0	10.2	10.2	6.4	6.4		Q ₆₀₅	0	0	0	13.0	0	0.6
CONVERTER	Q ₄₀₁	2.9	0	9.0	0	G ₁ 0.8 G ₂ 4.4	0.	BOOSTER	Q ₁₂₀₁	0	0	0	13.0	0	0.7
	Q ₄₀₂	1.7	0	9.0	0	0	0.		Q ₁₂₀₂	0	0	0	13.0	0	0.7
	Q ₄₀₃	1.5	1.5	8.3	8.3	1.54	1.54								
	Q ₄₀₄	0.85	0.85	8.5	8.5	0.24	0.24								
	Q ₄₀₅	0.8	0.8	8.5	8.5	1.2	1.2								

Measured with VTVM.
 Values are in VOLT DC.

FTV-250 PARTS LIST

MAIN CHASSIS			
Q	TRANSISTOR		
1	2N3055		
D	DIODE		
3, 6	Si	1S1555	
1, 4, 5		1S1941	
2		DS-130YD	
R	RESISTOR		
	CARBON COMPOSITION		
1	$\frac{1}{2}$ W		1K Ω
4	$\frac{1}{2}$ W		470K Ω
2, 3	$\frac{1}{2}$ W		1M Ω
	WIRE WOUND		
5	2W		150 Ω
VR	POTENTIOMETER		
1	EVL-BOAS	15B53	5KB
2	EWf-POAS	15O98	5KB/50KB
C	CAPACITOR		
	CERAMIC DISC		
3, 6, 7	50WV		0.01 μ F
2, 4, 9~11	50WV		0.047 μ F
8, 12	1.5KV		0.0047 μ F
	MYLAR		
5	50WV		0.1 μ F
	ELECTROLYTIC		
1	25WV		220 μ F
PT	POWER TRANSFORMER		
1	52-45		
M	METER		
1	47820C1		
RL	RELAY		
1, 2	AP3241		
RLS	RELAY SOCKET		
1, 2	AP3844		
S	SWITCH		
1	RS32-1-4-3		
2	ESR-E132R15A		
3	AH-71507		
J	CONNECTOR		
1	QMS-AB4M		
2	SA-602B		
3	PA-603B		
4~7	CN-7017		
8	JSO-239		
9	S9-241Y		
10	ML-3161		
FH	FUSE HOLDER		
1	SN-1001		
CONVERTER UNIT			
PB	PRINTED CIRCUIT BOARD		
1517(A~Z)			
Q	FET & TRANSISTOR		
401	FET		3SK40M
402	FET		2SK19Y
403	Tr		2SC373
404, 405	Tr		2SC784R
D	DIODE		
406, 407	Ge		1N60AM
405	Varactor		1S1658
401~404	Varactor		BB105GM
X	CRYSTAL		
401	HC25/U		38.6666MHz
402	HC25/U		39.3333MHz
R	RESISTOR		
	CARBON FILM		
415, 418, 422, 426	$\frac{1}{4}$ W		100 Ω
425, 429	$\frac{1}{4}$ W		220 Ω
408, 421	$\frac{1}{4}$ W		270 Ω
413, 430	$\frac{1}{4}$ W		1.5K Ω
409, 417, 424	$\frac{1}{4}$ W		2.2K Ω
420	$\frac{1}{4}$ W		3.3K Ω
428	$\frac{1}{4}$ W		4.7K Ω
416, 419	$\frac{1}{4}$ W		10K Ω
427	$\frac{1}{4}$ W		22K Ω
404	$\frac{1}{4}$ W		33K Ω
423	$\frac{1}{4}$ W		47K Ω
405, 406	$\frac{1}{4}$ W		68K Ω
403, 407, 412	$\frac{1}{4}$ W		100K Ω
401, 402, 410, 411, 414	$\frac{1}{4}$ W		1M Ω
C	CAPACITOR		
	CERAMIC DISC		
437, 438	50WV		3PF(CH)
401, 402, 411, 413	50WV		5PF(CH)
427, 432	50WV		12PF(CH)
429	50WV		15PF(CH)
403, 414, 421	50WV		20PF(CH)
423	50WV		24PF(CH)
417	50WV		150PF(CH)
415, 420, 425	50WV		0.001 μ F
404, 406~410, 412, 416	50WV		0.01 μ F
418, 419, 422, 424, 426, 428			
430, 431, 436			
405, 433~435	50WV		0.047 μ F
TC	TRIMMER CAPACITOR		
401~404	ECV-1ZW	10 \times 32	10PF
L	INDUCTOR		
401	Antenna	A	# 221003
402	Antenna	B	# 221004
403	RF	A	# 221005
404	RF	B	# 221006
405	RFC		10 μ H
410	RFC		250 μ H
406, 407	RFC		1mH
T	TRANSFORMER		
401			R12-4423
402			R12-4425
403, 404			R12-4862

ALC AMP UNIT				C CAPACITOR			
PB PRINTED CIRCUIT BOARD 1519(A~Z)				DIPPED MICA 604, 605 50WV 390PF			
Q FET				CERAMIC DISC			
501		2SK19GR		615	50WV	0.5PF	
				614, 616	50WV	5PF (CH)	
				611, 612, 622, 626	50WV	10PF (CH)	
D DIODE				618 50WV 56PF (CH)			
501, 502	Si	1S1555		601, 606, 607, 623, 624	50WV	0.001 μ F	
				628, 629	50WV		
				602, 608~610, 613	50WV	0.01 μ F	
R RESISTOR				617, 619~621, 625			
CARBON FILM				627, 630			
503, 507		$\frac{1}{4}$ W	100 Ω	TC TRIMMER CAPACITOR			
505		$\frac{1}{4}$ W	220 Ω	601~603, 605 ECV-1ZW 10 \times 50 10PF			
501		$\frac{1}{4}$ W	10K Ω	604, 606, 607 ECV-1ZW 20 \times 50 20PF			
502		$\frac{1}{4}$ W	22K Ω				
504		$\frac{1}{4}$ W	100K Ω				
VR POTENTIOMETER				L INDUCTOR			
501		EVL-S3AA0014	10KB	601		#221007	
C CAPACITOR				602 #221008			
CERAMIC DISC				603 #221009			
501		50WV	10PF (CH)	604, 606	RFC	#221017	
506, 507		50WV	82PF (CH)	605, 607, 609		#221018	
504, 508		50WV	100PF (CH)	608		#220045	
502, 503, 505		50WV	0.01 μ F	610~612	RFC		10 μ H
509		50WV	0.047 μ F	T TRANSFORMER			
TC TRIMMER CAPACITOR				601 R12-4423			
501		ECV-1ZW 40 \times 32	40PF				
L INDUCTOR				BOOSTER UNIT			
501		RFC	#220044	PB PRINTED CIRCUIT BOARD			
EXCITER UNIT				1470(A~Z)			
PB PRINTED CIRCUIT BOARD				Q TRANSISTOR			
1516(A~Z)				1201 MRF-208			
Q FET & TRANSISTOR				1202 2N5591			
601, 602	FET	2SK19GR		D DIODE			
605	Tr	2SC730		1203	Ge	1S188FM	
604	Tr	2SC741		1204	Si	1S1555	
603	Tr	2SC784R		1201, 1202	Si	10D-1	
D DIODE				1209 Zener 1N4740			
605	Si	10D-1		R RESISTOR			
601	Varactor	1S1658		CARBON COMPOSITION			
602~604	Varactor	BB105GM		1204	$\frac{1}{2}$ W	10 Ω	
R RESISTOR				1201 $\frac{1}{2}$ W 22 Ω			
CARBON FILM				1203 $\frac{1}{2}$ W 56 Ω			
619, 621		$\frac{1}{4}$ W	22 Ω	1205 $\frac{1}{2}$ W 120 Ω			
618		$\frac{1}{4}$ W	56 Ω	1202 $\frac{1}{2}$ W 330 Ω			
608, 614		$\frac{1}{4}$ W	100 Ω	1206 $\frac{1}{2}$ W 15K Ω			
613		$\frac{1}{4}$ W	220 Ω	VR POTENTIOMETER			
616		$\frac{1}{4}$ W	330 Ω	1202 EVL-SOAA 00B53 5KB			
617		$\frac{1}{4}$ W	2.7K Ω	1201 EVL-SOAA 00B14 10KB			
612		$\frac{1}{4}$ W	3.3K Ω	C CAPACITOR			
622		$\frac{1}{4}$ W	4.7K Ω	CERAMIC DISC			
611		$\frac{1}{4}$ W	15K Ω	1216 50WV 2PF (CH)			
604, 605		$\frac{1}{4}$ W	56K Ω	1217, 1223 50WV 5PF (CH)			
602, 603, 606, 607, 609, 610		$\frac{1}{4}$ W	1M Ω	1201, 1205 50WV 10PF (CH)			
VR POTENTIOMETER				1213~1215 50WV 20PF (CH)			
601		SR19R	1KB	1212 50WV 39PF (CH)			
				1211 50WV 68PF (CH)			
				1206 50WV 100PF (CH)			

PB-1516A (EXCITER)

PB-1519 (ALC-AMP)

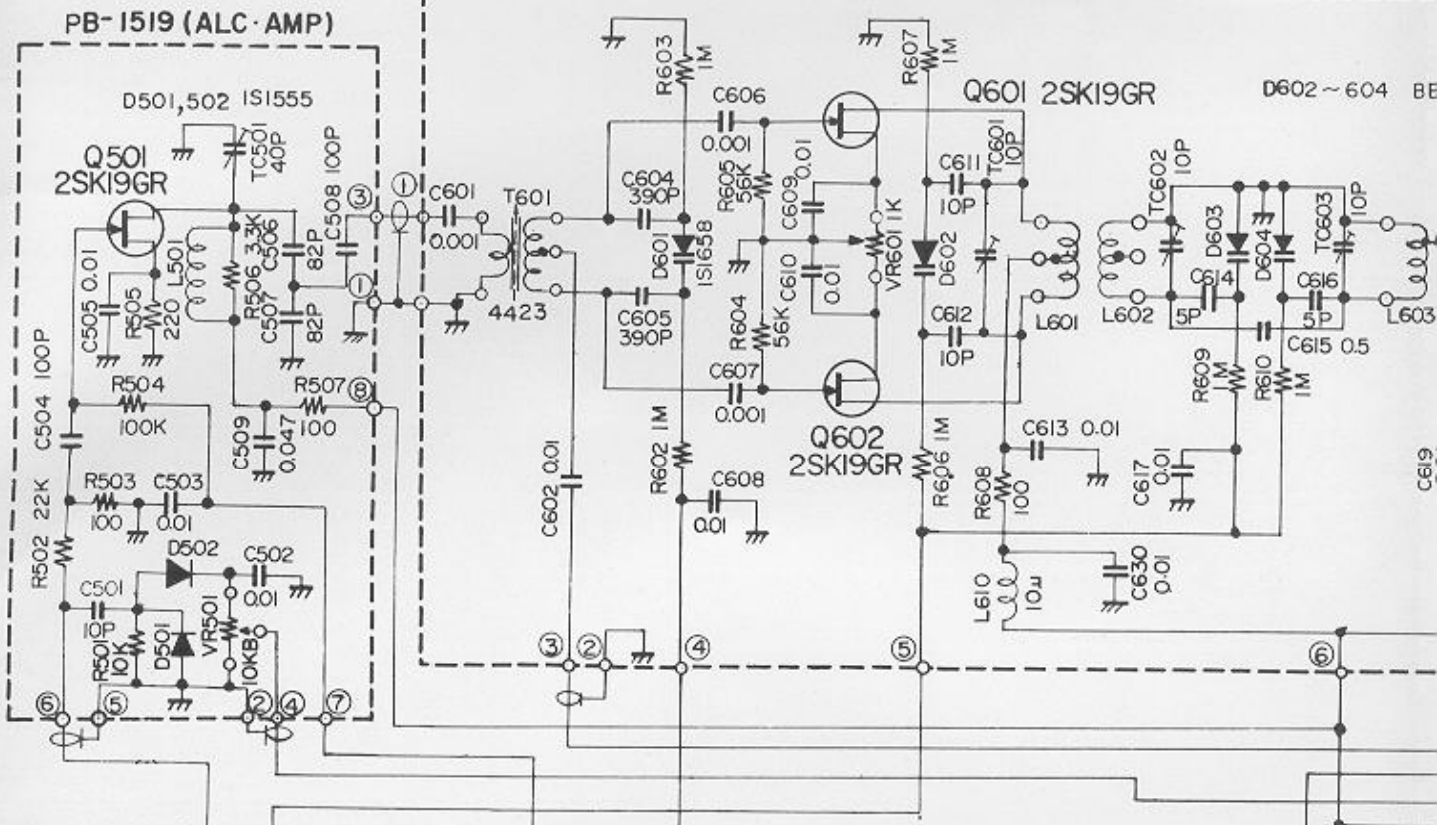

TRX IN J4
(RF OUT)

OUT J5
(REC)

6M TX J6

6M RX J7

J8
(M)

PB-1469A(REG)

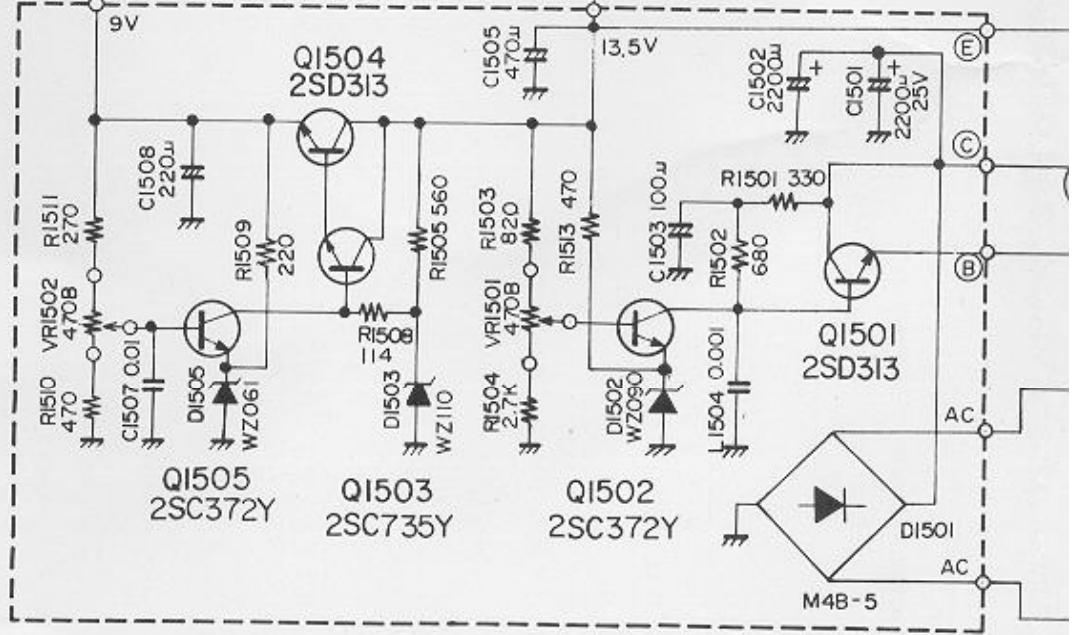

5GM

PB-1470A (BOOSTER)

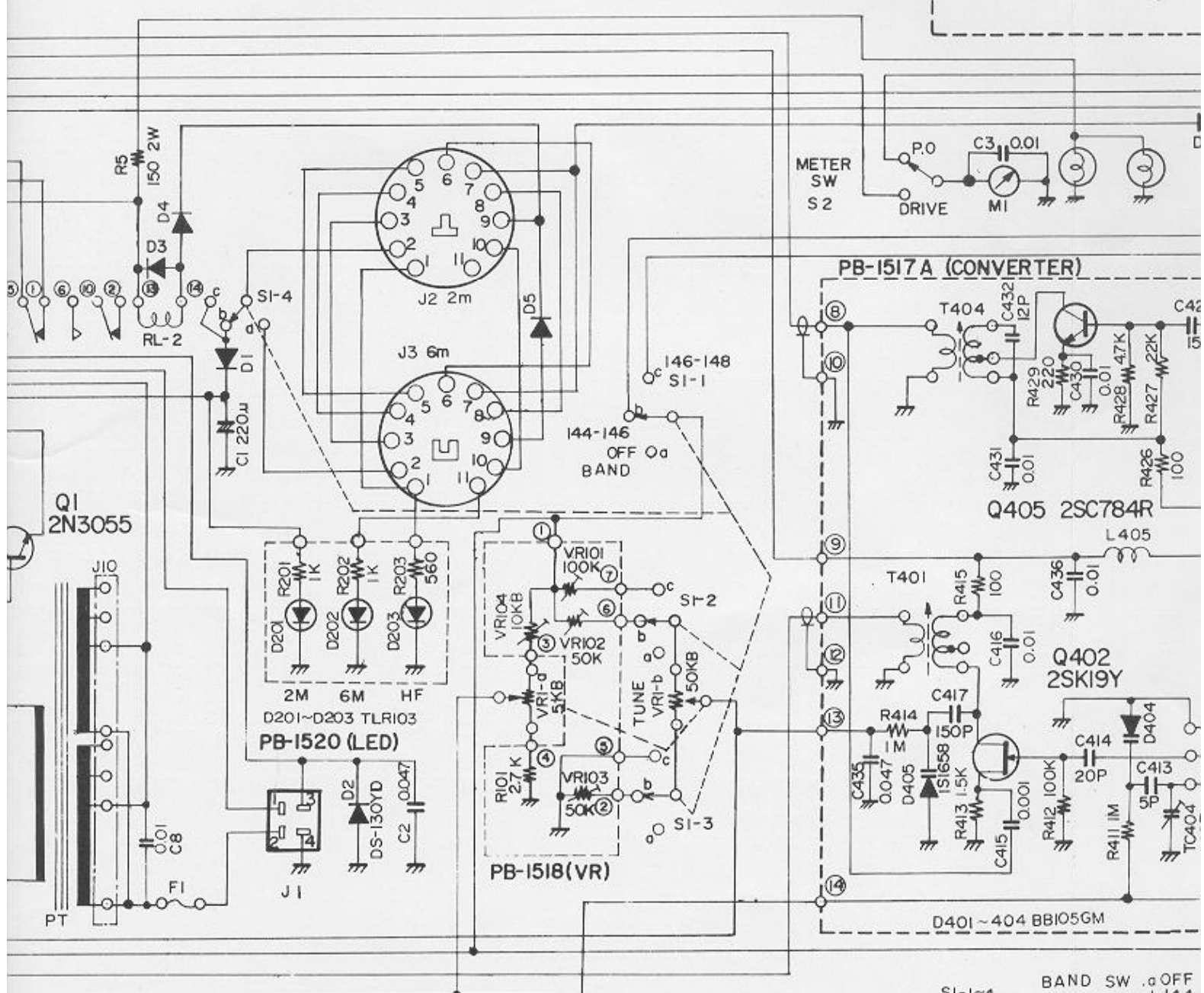
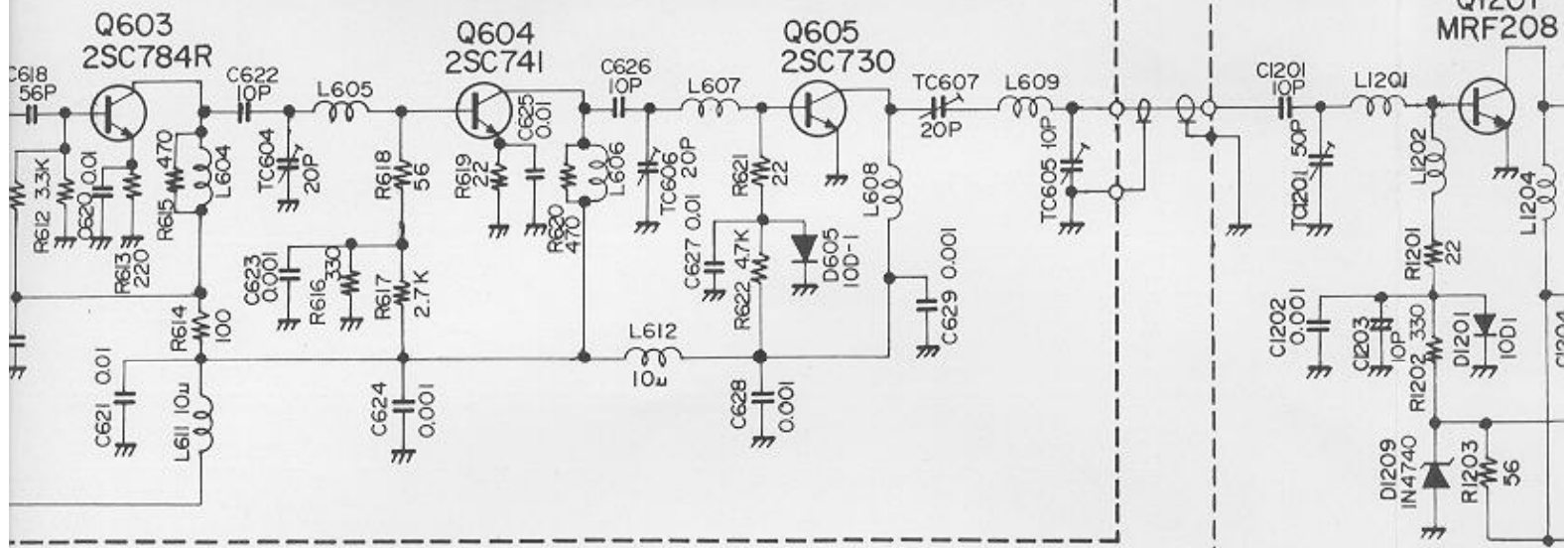

SI-1-4 BAND SW
 a OFF
 b 144
 c 146

OSTER)

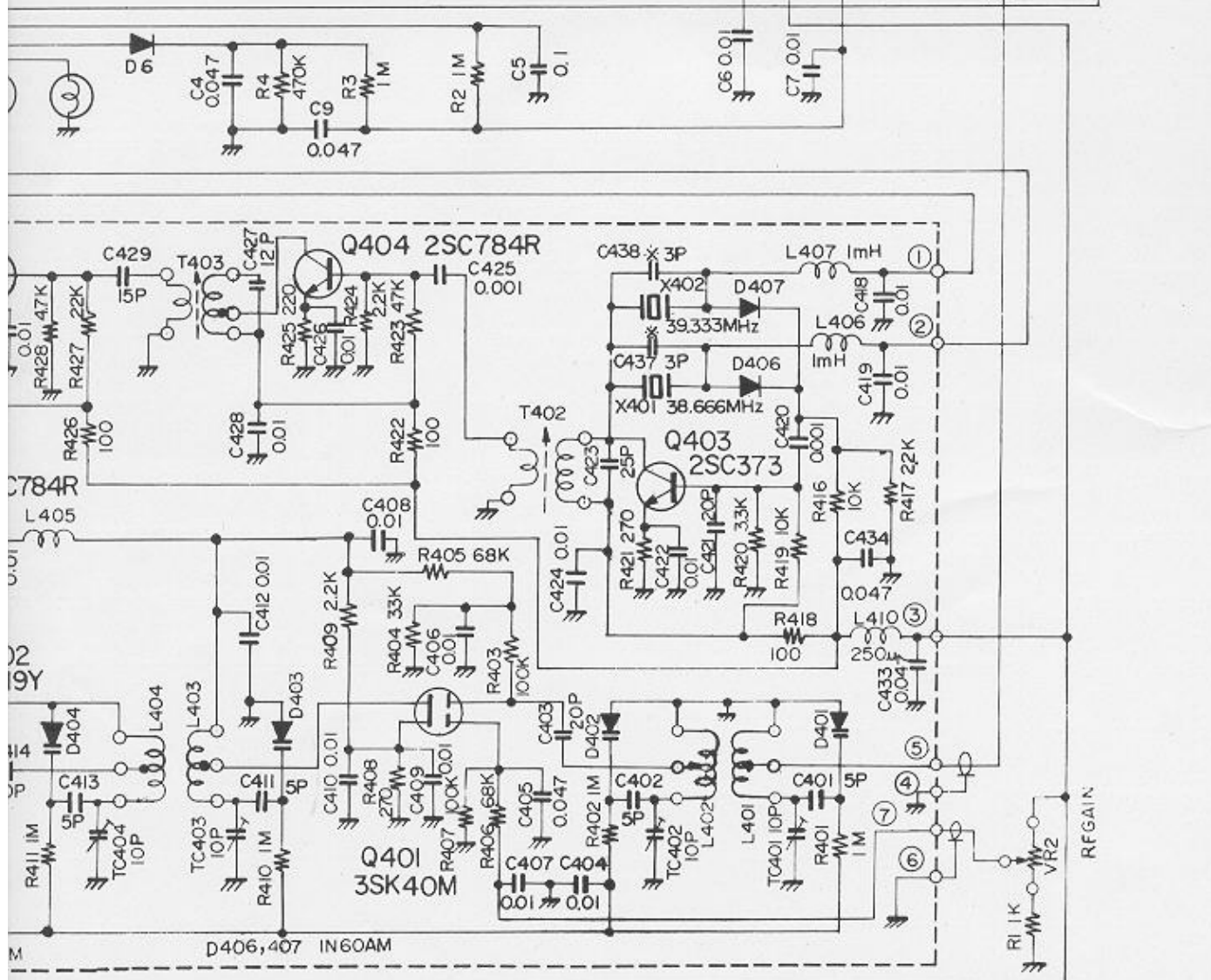
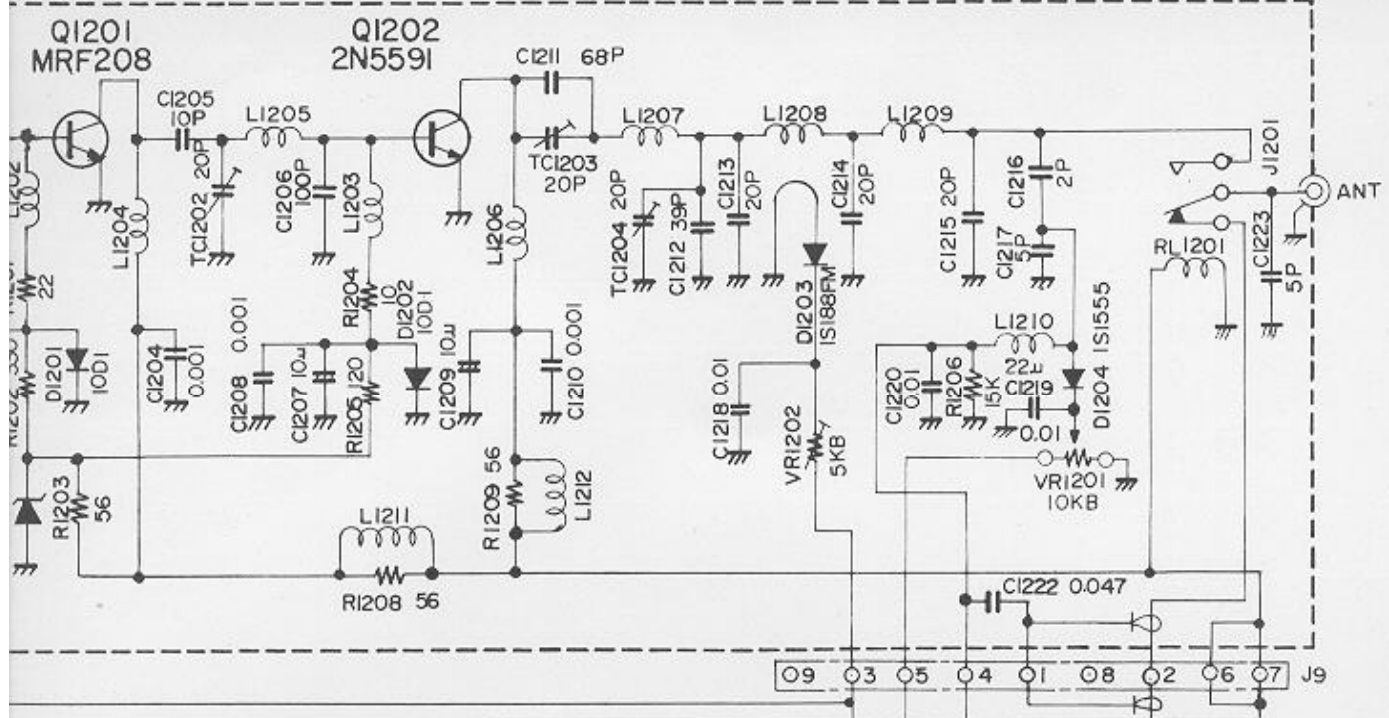

SW a OFF
 b 144 ~ 146
 c 146 ~ 148

Downloaded by

 Amateur Radio Directory

FTV-250
 CIRCUIT DIAGRAM



Downloaded by

Amateur Radio Directory