

**INSTRUCTION  
MANUAL**

**FT401b**

**YAESU MUSEN CO., LTD.**

TOKYO JAPAN

### SPECIFICATIONS

Emission Type	SSB (USB and LSB selectable) CW
Input Power	560 watts PEP maximum, 430 watts CW
Frequency Range	3.5-4.0, 7.0-7.5, 14.0-14.5, 21.0-21.5, 28.0-30.0 MHz 10.0—10.5 (RX only) (2 extra bands can be added)
Frequency Stability	After warmup 100 Hz for any 30 min.
Antenna Impedance	50 to 100 ohms unbalanced
Carrier Suppression	Better than -40 db
Sideband Suppression	Better than -50 db at 1000 Hz
Distortion products	Better than -25 db
Receiver sensitivity	0.5 $\mu$ V S/N 20db at 14 MHz SSB
Selectivity	{ SSB ...2.4 KHz at -6db, 4.2 KHz at -60 db CW .....600Hz at -6db, 1.2 KHz at -60 db
Image rejection	50 db
Audio output	1 watt
Output impedance	8 ohms
Power requirement	AC 117 or 220 volts at 50/60 Hz
Dimensions	15 $\frac{3}{4}$ " wide, 6 $\frac{1}{4}$ " high, 13 $\frac{3}{4}$ " deep
Weight	approximately (40 lbs.)

CONGRATULATIONS! You have just purchased one of the finest, high performance transceivers available to the amateur today. To fully appreciate the features, flexibility, and efficient operating procedures available with your new transceiver, we recommend that the instruction manual be studied thoroughly prior to operation.

**GENERAL:**

The FTdx401 Single Sideband Transceiver is a precision built transceiver providing SSB (USB and LSB), and CW modes of operation. This transceiver operates at a maximum input of (560) watts PEP for SSB, and (430) watts CW on all bands, 80 through 10 meters.

In addition to the high output power of the transceiver, many features that have previously been considered extra cost options are included as standard equip-

ment on the FTdx401. Standard equipment includes built-in solid state power supply, CW filter, noise blanker, cooling fan, fully adjustable VOX, break-in CW operation, adjustable CW side tone, clarifier control provides  $\pm 5$  KHz off-set receiver operation, dual calibration markers at 100 and 25 KHz, 10 MHz WWV Band, provision for two additional transceive bands outside the amateur bands between 3.5 and 30 MHz, and front panel external VFO switching.

**FV401 External VFO**

The companion FV401 External VFO allows cross-band DX operation and has the effect of providing the operator with split frequency, separate receiver-transmitter operation, controlled by VFO or X-tal.

The FTdx401 has been designed to anticipate the amateur's future operating requirements and will provide many hours of trouble free service.

The FT-401B series transceivers have been modified for the AM operation, but the instruction manual has not yet been revised. The followings are supplemental information for the transceiver bearing the serial number later than 317001.

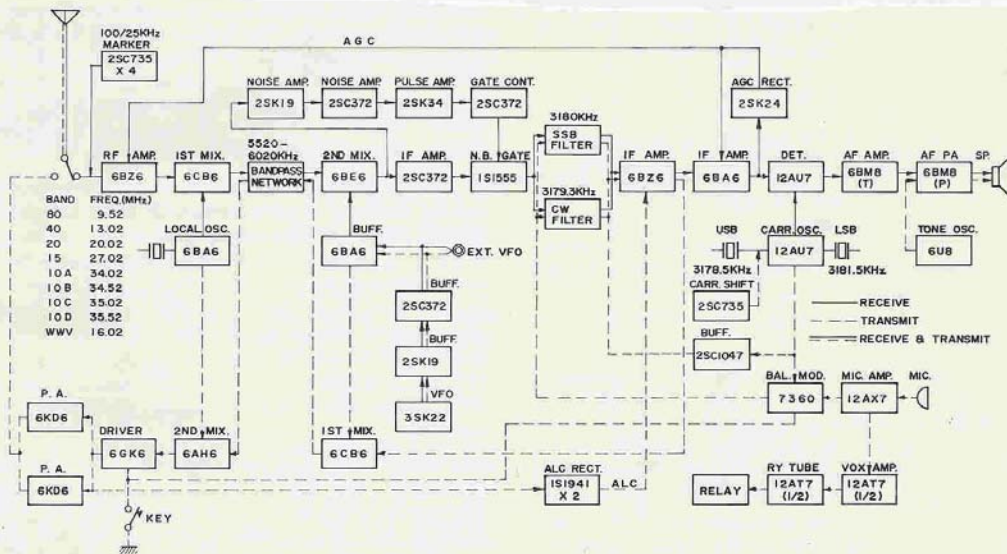

**BLOCK DIAGRAM**



## PRINCIPLES OF OPERATION

The block diagram and the circuit description provides you with a better understanding of this transceiver. The transceiver consists of a double-conversion receiver and a double-conversion exciter-transmitter. Receiver and transmitter circuits use common oscillators, common crystal filter, and common IF stages. The low frequency IF is 3,180 KHz. The high frequency IF is pass band tuned to cover 5,520 to 6,020 KHz.

### RECEIVER CIRCUIT:

A signal from the antenna passes through the antenna relay and trap coil, (tuned to 5,770 KHz), then to the tuned circuit and is applied to the grid of the RF amplifier, V1, 6BZ6.

The high frequency oscillator injection signal is also fed to the cathode of the first mixer from the local oscillator V2, 6BA6. The product of the first mixer is applied from the plate of the tube to the high IF pass band transformer. Output of this transformer (5,520 to 6,020 KHz) is applied to the grid of the second receiver mixer, V203, 6BE6. When the signal is applied to the grid of V203, and the VFO injection signal is applied to another grid of the tube, the 3,180 KHz difference product is fed from the V203 plate circuit to the Noise Blanker Unit.

The output from V203 is fed to the base of the IF amplifier TR351, 2SC372 and the gate of the noise amplifier TR352, 2SK19. The output from TR351 is fed to the crystal filter through the noise blanker diode D351, 1S1555. The diode disconnects the input to the crystal filter each time there is noise pulse. The diode switch is driven by TR355.

D1301 through D1304 are diode switches which select the crystal filter for SSB or CW operation. The diode switch selects the CW filter automatically when the MODE switch is set to CW position. The output from the filter is applied to the grid of the first IF amplifier, V204, 6BZ6. The signal is amplified by V204 and V205 and applied through T205 to the AGC rectifier transistor, and the grid of product detector V213, 12AU7.

The beat-frequency oscillator signal which is generated in V206, 12AU7 is applied to the cathode of V213, 12AU7 and the result is the detected audio signal. Output of the AGC rectifier circuit is applied to the grid circuit of the RF amplifier tube and IF amplifier tubes to control the gain of the receiver automatically and prevent overloading. Output from the product detector is applied through the AF GAIN control, VR9, to the grid of the first AF amplifier tube, triode section of V210, 6BM8. Amplified audio output of the triode section is coupled to the grid of the AF output amplifier, pentode section of V210, which drives the output transformer T1.

### TRANSMITTER CIRCUIT:

The microphone input is connected to the grid of the first microphone amplifier V208A, 12AX7, and then coupled to the grid of the second amplifier, V208B, the other half of the tube. Output from V208B is coupled to the beam deflection electrode of V207, 7360, through the MIC GAIN control, VR-6.

In the CW/TUNE position of the MODE switch, output from the tone oscillator, V212, 6U8, is fed to the grid of the receiver power amplifier tube, V210. The carrier signal generated in V206, 12AU7; is fed to the control grid of V207. Output from the balanced modulator V207 coupled to the grid of the IF amplifier, V204, 6BZ6, through the crystal filter, XF-201 of which the passband is centered at 3,180 KHz. This passes either the upper or lower sideband, depending upon the sideband selected when the MODE switch is set to carrier crystal X201 or X202.

The output from the IF amplifier is fed through T204 to the grid of transmitter VFO mixer, V201, 6CB6. The plate circuit of the first mixer is connected to the passband tuning transformer BPF5, and converts the 3,180 KHz sideband signal to a 5,520 to 6,020 KHz single sideband signal. The passband tuning is so designed that it provides excellent spurious reduction. The output signal from the passband network is fed to the grid of the second mixer, V3, 6AH6, and the high frequency injection signal from crystal oscillator, V2, 6BA6 is also fed to the grid of V3. This arrangement converts the IF signal to the desired transmitting frequency. Output from the second mixer is fed through a tuned circuit to the grid of the driver tube, V4, 6GK6 and amplified to a level sufficient to drive the final linear amplifier, V5 and V6, 6KD6s.

Final output from V5 and V6 is fed to a pi-section network consisting of L15 and PLATE and LOAD capacitors. A section of the bandswitch adjusts the inductance of L15 to the correct value for each band, and adds fixed amounts of capacity to the PLATE and LOAD capacitor on the lower bands. Output from the pi-network is fed to the antenna through the contacts of the antenna relay. Both the driver and final stages are neutralized to ensure stability. A section of the band switch selects the capacitors to the correct value for perfect neutralization on each band.

The ALC circuit is placed in the grid circuit of the final tubes. When RF driving voltage to the final tubes becomes sufficient to drive the grids positive, the grids begin to draw current and the signal is detected. This produces an audio envelope. The audio is then rectified by the ALC rectifier, which in turn produces a negative DC voltage. The voltage is filtered by C61 and R-29, which also determines the time constant, and controls the gain of V204. This system allows a high average of



modulation without increased distortion.

The output voltage from the second microphone amplifier, V208, is coupled through the VOX GAIN control to the grid of V209A, 12AT7, and fed to the VOX rectifier. The positive DC output voltage of the VOX rectifier is applied to the grid of VOX relay amplifier tube, V209B, 12AT7, causing it to conduct current and actuate the VOX relay RL1. The relay tube is so biased that the relay is actuated by the VOX GAIN switch in the MOX position. Contacts on the relay switch, -70 volts DC muting and bias voltage, the metering circuit from receive to transmit, the clarifier and antenna relay.

The ANTITRIP circuit provides a threshold voltage to prevent the loud speaker output from tripping the transceiver into the transmit function. The receiver output audio voltage is connected through ANTITRIP control, VR8, to a rectifier. Negative DC output voltage from the ANTITRIP rectifier, connected to the grid of the VOX tube V209B, 12AT7, provides the necessary antitrip threshold. ANTITRIP control VR8 adjusts the value of the antitrip voltage threshold so that the loudspeaker output will not produce too much positive DC output from the VOX rectifier so as to exceed the negative DC output from the antitrip rectifier and cause V209B to actuate the relay. However, the microphone input will cause the positive voltage to overcome the negative voltage and actuate the relay. VR13 provides coarse adjustment for relay tube sensitivity.

Relay hold time will be determined by DELAY control, located on chassis rear apron.

## OSCILLATORS

The transceiver contains 5 oscillators. They are the carrier oscillator, the high frequency crystal oscillator, the variable frequency oscillator, the tone oscillator, and the crystal calibrator.

### Carrier Oscillator

The carrier oscillator is crystal controlled at either 3,178.5 or 3,181.5 KHz, depending upon whether X201 or X202 is selected by the MODE switch. The MODE switch disconnects the cathode circuit of either tube when not in use. These crystal frequencies are matched to the pass band of the crystal filter, to place the carrier frequency approximately 20db down on the skirt of the filter response. The 3,178.5 KHz crystal frequency is shifted into the filter response range to insert the carrier for CW/TUNE operation.

### High Frequency Oscillator

The band determining oscillator, V2, 6BA6, is crystal controlled by one of the 9 crystals selected by the BAND switch. Output from the oscillator is fed to the cathode of the receiver first mixer V202, 6CB6, and the grid of the transmitter second mixer, V3, 6AH6. The output frequency of this oscillator is always 6,020 KHz higher than the lower edge of the selected band. The output signal from this oscillator is the crystal fundamental frequency for 80 and 40 meters, but for higher bands, the crystal frequency is doubled in the plate circuit of the oscillator.

### Variable frequency oscillator

The VFO uses a FET transistor, TR401, 3SK22G, as the oscillator, and TR402, first buffer and TR403 buffer amplifier. The VFO oscillating frequency is 8,700 to 9,200 KHz to provide 500 KHz Band coverage. Varactor diode 1S145 is in series with capacitor, C415 and is switched into the circuit by the CLARIFIER switch and relay contacts to shift the VFO frequency. Output from TR403 is fed through the SELECT switch to VFO buffer tube V211.

### Crystal calibrator

The 100 KHz crystal oscillator, TR301, 2SC735Y is used for dial calibration. Output from the oscillator, TR301 is fed into the 25 KHz multivibrator which generates a marker signal every 25 KHz.

### Tone oscillator

The tone oscillator operates when the MODE switch is in CW/TUNE position. It is a phase shift oscillator operating at approximately 800Hz. The output is applied to the receiver audio amplifier for sidetone monitoring in CW operation.

## POWER SUPPLY

The built-in power supply is an all solid state bridge-type, delivering 4 different DC voltages and also AC heater supply for all tubes. The power transformer has two primary windings for operation from either 117 or 220 volt AC supply.

The power amplifier plate voltage (600V DC) is supplied from bridge connected silicon rectifiers. 300 volts DC is delivered to the plates of the other tubes, and 150 volt DC supply is provided through the center tap of the medium voltage supply. Bias is supplied from a half wave rectifier, D513, 1S1943 The plate voltage for all oscillator tubes is regulated with a VR-105 MT, stabilizer tube.

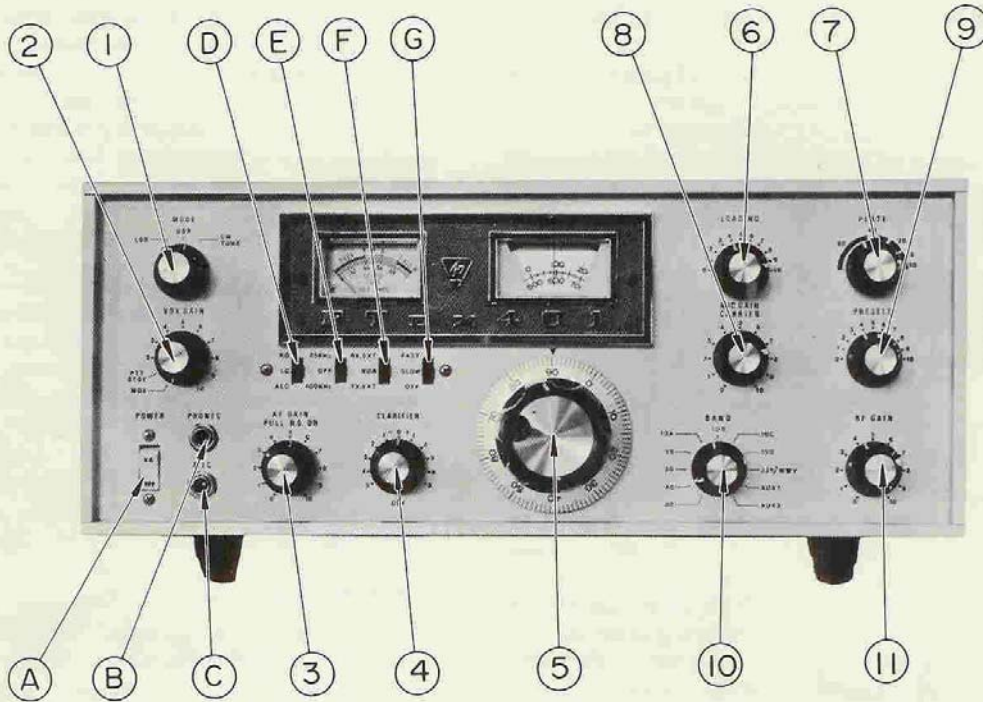

- |                        |   |                    |  |
|------------------------|---|--------------------|--|
| 1. MODE                | USB/LSB: Side Band selection.<br>CW/TUNE: Use transmitter tune-up and code operation.         | 10. BAND           | Selects operating band.  |
| 2. VOX GAIN            | Controls the VOX gain and functions for push to talk, standby or manual operation.            | 11. HF GAIN        | Controls the gain of RF and IF stages.   |
| 3. AF GAIN             | Varies the gain of receiver audio amplifier, and noise blanker is connected at pull position. | A. POWER           | Main switch  |
| 4. CLARIFIER           | Varies the VFO frequency slightly for receiver incremental tuning.                            | B. HEADPHONE JACK  |  |
| 5. MAIN TUNING         | Controls operating frequency.   | C. MICROPHONE JACK |  |
| 6. LOADING             | Tunes the output circuit of PI network.   | D. METER           | Selects the meter to read PA cathode current, relative power output, or cathode current of ALC controlled stage.   |
| 7. PLATE               | Tunes the plate circuit of PA tubes.  | E. CALIBRATOR      | 100 KHZ: 100 KHz calibration on.<br>25 KHZ: 25 KHz multivibration on.  |
| 8. MIC GAIN<br>CARP:ER | Controls microphone gain for transmitting, and carrier input for CW and tune-up.              | F. SELECT          | NOR: Operating frequency is controlled by main tuning dial.<br>RX-EXT: Receiving frequency is controlled by external VFO.<br>TX-EXT: Transmitting frequency is controlled by external VFO. |
| 9. PRESELE             | Pretunes signal circuits for both transmit and receive condition.                             | G. AGC             | Changes receiver AGC release time.   |



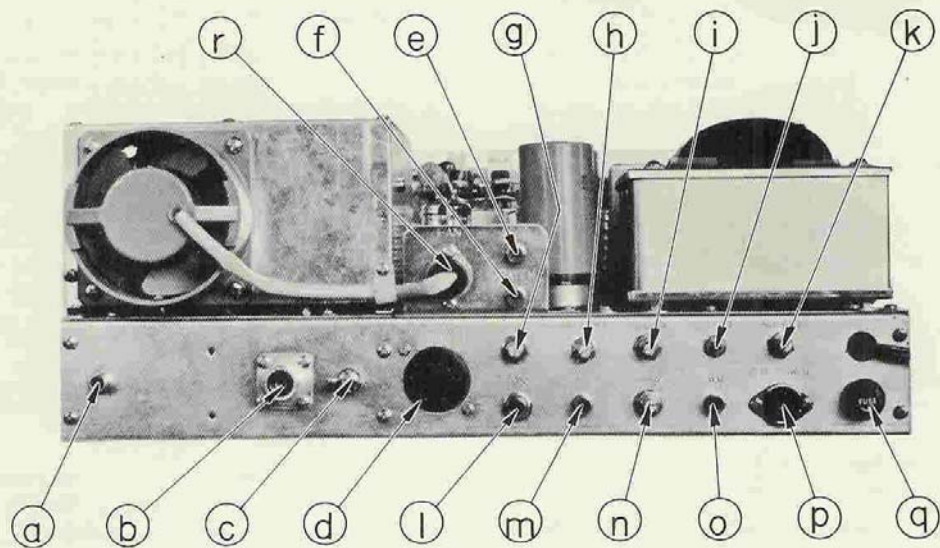

- |  |  |  |  |
|--|--|--|--|
| <p>Ⓐ RF OUT</p> <p>Ⓑ ANT</p> <p>Ⓒ GND</p> <p>Ⓓ ACC</p> <p>Ⓔ 600Ω</p> <p>Ⓕ PATCH</p> <p>Ⓖ DELAY</p> | <p>Output from driver stage may be obtained for the use of optional equipments, such as our FTV-650 transverter.</p> <p>Coaxial connector for antenna.</p> <p>Ground connection.</p> <p>Accessory socket.</p> <p>Pins 1 and 2 shorted by ACC. plug (11pin male plug) when operating without transverter.</p> <p>Receiver output at 600 ohm impedance to be used for phone patch.</p> <p>Speech input terminal for phone patch connection. Impedance is 50 kilo-ohms.</p> <p>Adjusts "hold-in" time of VOX.</p> | <p>Ⓕ ANTITRIP</p> <p>Ⓖ RELAY</p> <p>Ⓖ S-ADJ</p> <p>Ⓖ ALC</p> <p>Ⓖ KEY</p> <p>Ⓖ VFO</p> <p>Ⓖ BIAS</p> <p>Ⓖ 8Ω</p> <p>Ⓖ VFO POWER</p> <p>Ⓖ FUSE</p> <p>Ⓖ FAN</p> | <p>Adjusts VOX anti-trip level.</p> <p>Adjusts operating level of VOX relay</p> <p>Adjusts S-meter zero setting.</p> <p>Adjusts ALC limiting action.</p> <p>Key jack for code operation.</p> <p>Input jack for external V. F. O.</p> <p>Adjusts bias on PA tubes.</p> <p>Receiver output at 8ohm impedance for loud speaker.</p> <p>Source for external V. F. O. SHORT plug (7 pin male plug) should be inserted when operating without external V. F. O., shorting Pins 3 and 4.</p> <p>Fuse holder.</p> <p>10amps. for 117volts, 6amps. for 220volts operation.</p> <p>Power outlet for cooling fan.</p> |
|--|--|--|--|

## INSTALLATION

It is recommended that an excessively warm location be avoided. The transceiver should be placed in a location that has adequate space to permit free air circulation through the cabinet openings.

The transceiver should be connected to a good ground by a heavy lead to the terminal marked GND on rear apron of the chassis. It is not recommended that a gas pipe or electrical conduit pipes be used. The ground lead should be as short as possible.

Impedance of the antenna is designed to match a 50 to 120 ohm load. Most commercial antenna and feeders are designed between 50 and 75 ohms. If the impedance is far from this value, an antenna matching device should be placed between the antenna terminal and the feeder.

## OPERATION

### INITIAL CHECK

Prior to connecting the transceiver to power outlet, carefully examine for any visible damage, check that all tubes and crystals are properly seated in their sockets, and check tuning controls and switches for complete freedom. Connect the speaker to jack marked 8 ohms on rear apron of the chassis, and an antenna cable to the coaxial cable connector. Make sure that supply voltage is the same as the voltage marked on the rear apron of the chassis before connecting to power outlet. Insert ACC plug (11 pin male plug shorting pins 1 and 2) into ACC socket on the rear apron of the chassis, and check that SHORT plug (7 pin male plug shorting pins 3 and 4) is inserted into VFO POWER socket on the rear apron of the chassis.

### RECEIVER TUNING

Set the controls as follows:

POWER	OFF
VOX GAIN	STBY
MODE	Desired operation mode
BAND	Desired Band
MIC GAIN	Fully counterclockwise
RF GAIN	Fully clockwise
SELECT	NOR
CLARIFIER	OFF
AGC	FAST

Press the power switch to ON position, then adjust the AF GAIN control until some receiver noise is heard in speaker. Peak the PRESELECTOR for maximum S-meter reading, and tune slowly for desired signal.

### INITIAL ADJUSTMENTS

#### Dial Calibration:

Set CALIBRATION switch to 100 KHz position. Rotate tuning knob to nearest 100 KHz mark as indicated on the lighted main tuning dial. An audio tone will be heard as tuning knob is rotated through each 100 KHz dial point. Very slowly rotate tuning knob in the direction that causes

audio tone to decrease in frequency, until tone is just inaudible. (Zero Beat) Hold tuning knob firmly at this point and rotate skirt vernier dial to zero position. The skirt vernier dial surrounds the tuning knob and is held in position by a friction locking device. This dial is easily movable by hand but will retain its position after adjustment. The transceiver must be recalibrated when changing mode of operation to LSB, USB, or CW.

### METER ADJUSTMENTS:

The transceiver features four separate meter functions; S-meter, ALC (Automatic Limiter Control Indication), IC (Cathode Current of Final Amplifier Tubes), and PO (Relative Power Output Indication).

These functions are controlled from the METER switch on the front panel and are adjusted for zero settings by means of two variable potentiometers on the rear apron of the chassis.

#### S-Meter Adjustments

Set VOX GAIN switch to STBY position, and R. F. GAIN control to fully clockwise, disconnect antenna, then adjust S-meter control on chassis rear apron until meter reads zero. Reconnect antenna.

#### ALC Adjustment

When METER switch on the front panel is set to ALC position the meter will indicate limiting action. To adjust meter to zero, set controls as follows:

MODE	USB
MIC GAIN	Fully counterclockwise
VOX GAIN	MOX

If meter reads other than zero, adjust ALC control on rear apron of chassis for zero indication. Return VOX GAIN to STBY position.

#### BIAS ADJUSTMENT

After warmup, set MODE switch to USB, METER to IC, and the VOX GAIN switch to MOX for transmit condition. The meter will indicate PA plate current. The needle of the meter should rise to IDLE position which is approximately 50 ma. If plate current is other than 50 ma, adjust BIAS potentiometer on rear apron.

#### VOX ADJUSTMENT

VOX controls have been preset for normal operation settings at the factory, however, in the event of V209 tube replacement it may be necessary to readjust controls.

Set ANTITRIP and DELAY control on rear apron of chassis to end of counter-clockwise travel. Remove microphone from mic jack. Set VOX GAIN control to fully clockwise position. Set MODE switch to USB or LSB. Advance VR13 marked "RELAY" clockwise until relay activates. Then, decrease slowly the setting of VR13 counter-clockwise to the point where the transceiver again turn into receive.



## TRANSMITTER TUNING

Set controls as follows:

SELECT	NOR
VOX GAIN	STBY
MODE	CW/TUNE
MIC GAIN	Fully counter clockwise
AF GAIN	Normal listening level
METER	IC position
CLARIFIER	OFF
BAND	Desired band
PLATE	Desired band
LOADING	To position shown in table

### LOADING POSITIONS

BAND	LOADING
80 .....	4
40 .....	2.5
20 .....	5
15 .....	3
10A .....	3
10B .....	3
10C .....	3
10D .....	3

### PRE-TUNING

1. Adjust PRESEL for maximum receiver noise level.
  2. Turn VOX GAIN switch to MOX position with meter in IC position.
  3. Rotate MIC GAIN control until meter rises just above normal idling current. (50 ma)
  4. Rotate PRESEL control for maximum meter reading. (Caution: if meter reading exceeds 0.2 reduce MIC GAIN control).
  5. Rotate PLATE control for minimum meter reading. (Dip plate).
  6. Return VOX GAIN switch to STBY.
- The transmitter is now pre-tuned to the desired frequency. Final peak tuning is accomplished by carefully following the final tuning procedure.

### FINAL TUNING

**CAUTION: EXCEEDING THE TIME LIMITS NOTED DURING FINAL TUNING MAY RESULT IN DESTRUCTION OF THE FINAL OUTPUT TUBES.**

1. Set meter to P.O. position, VOX-GAIN to STBY, MODE to CW/TUNE, MIC GAIN to 10.
  2. Momentarily set VOX-GAIN to MOX (ten seconds maximum), adjust PRESEL for *maximum* meter reading. Return VOX-GAIN to STBY.
  3. Momentarily set VOX-GAIN to MOX (ten seconds maximum), increase or decrease LOADING slightly for *maximum* meter reading. Return VOX-GAIN to STBY.
  4. Momentarily set VOX-GAIN to MOX (ten seconds maximum), adjust PLATE for *maximum* meter reading. Return VOX-GAIN to STBY.
  5. Repeat steps 3 and 4 until maximum meter reading is obtained.
- The transmitter is now peaked to maximum output. Return MIC GAIN to zero, meter to IC position, and set MODE switch to desired operating position.

### SSB OPERATION

After completion of tuning set MODE to LSB or USB. Set the METER switch to ALC position. Set the VOX-GAIN control to MOX and adjust the MIC GAIN control until the meter kicks up to midscale of green colored portion when speaking into the microphone normally. Set the VOX-GAIN control to desired operation, MOX (manual), PTT (push to talk), or VOX (voice control). For VOX operation, advance VOX GAIN control until voice actuates the transceiver. Set the ANTI-

TRIP control to the minimum point to prevent the speaker output from tripping the VOX. Do not use more VOX gain or more ANTITRIP gain than necessary. Adjust the DELAY control on rear apron for suitable release time.

NOTE: When meter is set to IC, voice modulation peaks will indicate 250 to 300 ma. Actual peak current, however, is approximately 2 times the indicated value.

## CW OPERATION

Using the two contact jack supplied with the accessory pack, connect key as shown in the illustration. Most relay type automatic keyers can be connected into the transceiver for break-in operation without modification, but when using reed relay or transistorized automatic keyers place 390 ohm resistor in series with key line.

## TUNING PROCEDURE - CW

Set up transceiver as described in transmitter tuning with adjusting CARRIER control to desired power output up to maximum.

After completion of final tuning, install key jack in rear apron of transceiver. Set MODE switch to CW and VOX-GAIN switch to MOX. The transceiver is now set up for manual CW operation. After completing a transmission the VOX-GAIN switch must be returned to STBY position for receive operation. For break-in operation, simply advance VOX-GAIN control.

## SIDETONE ADJUSTMENT

CW sidetone level may be adjusted by rotating the tone level potentiometer (VR 203) located on the main circuit board under the top cover. NOTE: Do not disturb setting of adjacent paint marked controls.

## SERVICE INSTRUCTIONS

### WARNING

Dangerous voltages are present, therefore extreme care is essential. Be sure that all power is disconnected before working on the chassis. Check the high voltages in the capacitors by shorting the high voltage line to ground with an insulated screw driver. The transceiver has been aligned and calibrated at the factory with proper test instruments and should not require realignment. Service or replacement of a major component may require subsequent realignment, but do not attempt to make an alignment unless the operation of the transceiver is fully understood.

## TEST EQUIPMENT REQUIRED

A signal generator, a vacuum tube volt ohm meter with RF probe, a general coverage communication receiver, and a 300 watt dummy load.

## VOLTAGE AND RESISTANCE MEASUREMENTS

The table lists voltages and resistance at all tube sockets. These values are measured with a VTVM with all tubes installed in their respective sockets.

All measurements should be made from socket pins to ground.

Adjust transistor voltage regulator to exactly 9 volts with VR-202 on the printed board. Measure voltage at junction of R294 and R295.

## TRANSMITTER ALIGNMENT

1. Disconnect the high voltage (600 volts) by unsoldering the lead at rectifier, and also the screen voltage by unsoldering the connection at pin 3 of the two tube sockets. (V5, V6)
2. Connect VTVM RF probe to pin 5 of V5.
3. Set the MODE switch to USB or LSB, and the VOX GAIN switch to MOX position. Adjust carrier balance potentiometer VR 201 on the main print board for minimum VTVM indication.
4. Advance MIC GAIN control two positions, and turn the MODE switch to CW/TUNE.
5. Adjust PRESEL control for maximum VTVM reading.
6. Adjust the MIC GAIN control during transmitter alignment to keep VTVM reading at 15 volts to avoid saturation of the circuits.
7. Start with upper slug of T203 nearly out and peak for peak VTVM reading.
8. Start with both slugs of T204 nearly out and adjust both slugs for peak VTVM reading.
9. Set the BAND switch to the 80 meter band, the main tuning dial to the center (250 KHz), and the PRESEL control at center. Adjust the slugs of L901 & L1001 for peak VTVM reading. Adjust the slugs on all appropriate bands from 40 to 15 meters using the same procedure. Set the BAND switch to 10B and the main tuning dial at upper edge, and adjust L905 and L1005 for peak VTVM readings.



10. Disconnect the VTVM from pin 5 of V5, and connect it to pin 2 of V202. Set the BAND switch to 10D and adjust slug L3 for peak VTVM reading. Set the BAND switch to 10C and adjust the TC1101 for peak VTVM reading. Adjust TC1102 for 10B, TC 1103 for 10A, TC1104 for 15 and TC1105 for the 20. Set the band switch to 40 and adjust L4 for peak VTVM reading. For 80 meter band, adjust TC1106 for peak VTVM reading. Disconnect VTVM.
11. It is not recommended to align BPF5 passband network unless proper measuring instrument is available.
12. Turn the FUNCTION switch to OFF. Restore unsoldered PA screen grid and high voltage wire.
13. Connect the transceiver output to a 50 or 75 ohms dummy load. Set the main tuning dial at center, and tuneup the transceiver on 80 meter band as described. Adjust MIC GAIN control setting to keep PA current less than 100 ma. Readjust L1001 for peak meter reading. Readjust L1001 to L1005 for appropriate BAND settings.
14. Tune the transceiver to maximum output at 14,350 Kc. To measure spurious radiation, use the S-meter of another receiver and tune it to 14,520 Kc where a spurious signal can be heard. Adjust TC-205 for minimum S-meter reading without decreasing power output of the transceiver. Adjust L17 and L19 for minimum S-meter reading.

#### TRANSMITTER SIGNAL LEVEL

The following table shows voltage measuring points and normal signal levels. Before making measurements, set MODE switch to CW and unsolder the lead from pin 3 of V5, and V6 sockets. Set the VOX-GAIN switch to MOX. Plug-in key to key-Jack and close key to measure the signal level.

TEST POINT	FREQUENCY	RF VOLTAGE
V207 — pin 3	3,178.5 KHz	1 volt
V201 — pin 1	Variable	1.2 volts (Function STBY sw.)
V3 — pin 1	X-tal frequency selected	0.5-1 volts
V207 — pin 7	3,178.5 KHz	5.5 volts
V204 — pin 1	3,178.5 KHz	0.02 volts
V204 — pin 5	3,178.5 KHz	3.0 volts
V201 — pin 5	Variable IF	9.0 volts
V3 — pin 5	Transmit frequency	10.0 volts
V5 — pin 5	Transmit frequency	33.0 volts

Voltages given in the table are nominal and may vary  $\pm 20\%$

#### FINAL AMPLIFIER NEUTRALIZATION

When replacing the final amplifier tubes it may be necessary to reset the bias to 50 ma and check neutralization. Using the procedure outlined below will guarantee maximum output and long tube life.

#### CAUTION:

HIGH VOLTAGES ARE PRESENT ON UNDERSIDE OF CHASSIS.

USE GREAT CARE WHILE MAKING ADJUSTMENTS WITH WIRING EXPOSED.

1. Locate TC-1 the neutralization variable capacitor shaft on the underside of chassis near the last band-switch wafer, in the final amplifier section.
2. Connect antenna to dummy load, set meter to I.C.
3. Check final amplifier bias in upper or lower Side Band position. If meter indicates other than 50 ma, reset bias.
4. Tune up the transceiver in the center of the 15 meter band.
5. After tune up place meter in I.C. position, Mode switch in Tune position, and advance Mic Gain until meter reads 150 ma.
6. Rotate Plate tuning control and observe dip as indicated on meter. (NOTE: If dip is not prominent, reduce loading control slightly for better indication). As the Plate control is rotated the meter should rise equally and smoothly on either side of maximum dip indication.
7. Determine which side of the dip rises abruptly. Set Plate control slightly to this side of dip keeping the meter reading below 200 ma.
8. Using a non-metallic tuning wand, rotate neutralization capacitor shaft *very slightly* in the direction which reduces the current shown on the meter.
9. Repeat steps 7 and 8 until the meter indicates a smooth, equal rise on either side of the maximum dip point.

## RECEIVER CIRCUIT ALIGNMENT

When the transmitter circuits are aligned, the only alignment remaining for the receiver circuits are the last IF stage transformer T205, T351 through T353 IF transformers in the noise blanker unit, antenna input transformer L801 to L805, trap coils L806, L906, L23 and S-meter zero set.

1. Connect signal generator output to the antenna terminal. Set the BAND switch to 80 meters, and receive 3,750 Kc signal from signal generator. Adjust PRE-SEL control for peak S-meter reading. Adjust L801 for peak S-meter reading. Adjust coils L802 to L805 at 7,250, 14,250, 21,250, 29,000 KHz respectively for peak S-meter reading.
2. Tune the receiver circuit to 7,100 KHz incoming signal, and leave controls as is. Apply 5,920 KHz signal generator output to antenna terminal. Adjust L806, L906, for minimum S-meter reading. Then tune the receiver to 7,500 KHz and adjust L23 same as above at 5,520 KHz signal generator output.
3. Tune the receiver to incoming signal on any band, and adjust slugs of Lower slug of T203 and slugs of T205, T351, T352 and T353 for peak S-meter reading.

## NOISE BLANKER CIRCUIT ALIGNMENT

The blanking level of the noise blanker is determined by the THRESHOLD control VR351 and the noise amplifier stage transformer T354.

Connect a signal generator output to the antenna terminal, and tune the receiver to the signal generator frequency with AGC switch OFF position. Connect VTVM DC probe between the cathode of the Diode D352 and ground, then adjust T354 for peak VTVM reading.

## RECEIVER SIGNAL LEVEL

The following table shows test points and nominal signal level to produce S-9 reading on S-meter.

SIGNAL GENERATOR CONNECTION POINT	SIGNAL GENERATOR FREQUENCY	SIGNAL GENERATOR OUTPUT LEVEL
V205 — pin 1	3,180 KHz	100 db
V204 — pin 1	3,180 KHz	75 db
V203 — pin 7	5,770 KHz	77 db
V201 — pin 1	5,770 KHz	50 db
V1 — pin 1	14,255 KHz	47 db
Antenna Terminal	14,255 KHz	34 db
Oscillator injection voltages		
V213 — pin 7	3,178.5 KHz	4 volts
V203 — pin 1	Variable	3 volts
V202 — pin 1	Crystal Selected	1-2 volts

The receiver was tuned to 14,255 KHz for these measurements and the test signal injected at indicated test points. Signal generator output levels are taken from signal generator attenuator. All values are nominal and may vary  $\pm 20\%$  without degrading performance.



## TROUBLE SHOOTING GUIDE

DEFECT	POSSIBLE CAUSE
PA idling current unstable:	1. Defective V5 and V6. 2. Defective Bias supply including bias potentiometer.
Insufficient load:	1. PRESEL improperly tuned. 2. BAND switch improperly set. 3. Antenna not resonant at frequency. 4. Defective antenna or transmission line. 5. V3, V4, V5, V6 defective. 6. Defective rectifier.
Insufficient carrier suppression:	1. Defective V207. 2. Carrier balance control improperly set. 3. Defective crystal X201 or X202. 4. Carrier frequency improperly set.
Distorted transmitted signal:	1. Excessive MIC GAIN adjust. 2. V7 defective. 3. D2, D3 defective. 4. Incorrect neutralization.
Insufficient drive or no drive:	1. Defective rectifier. 2. Defective V204, V201, V3, V4, V5. 3. Defective crystal.
Low receiver sensitivity:	1. Antenna relay back contacts defective. 2. Defective V1, V201, V203, V204, V205.
VOX unstable:	1. Defective V209. 2. Improper setting of VOX GAIN and ANTITRIP controls.

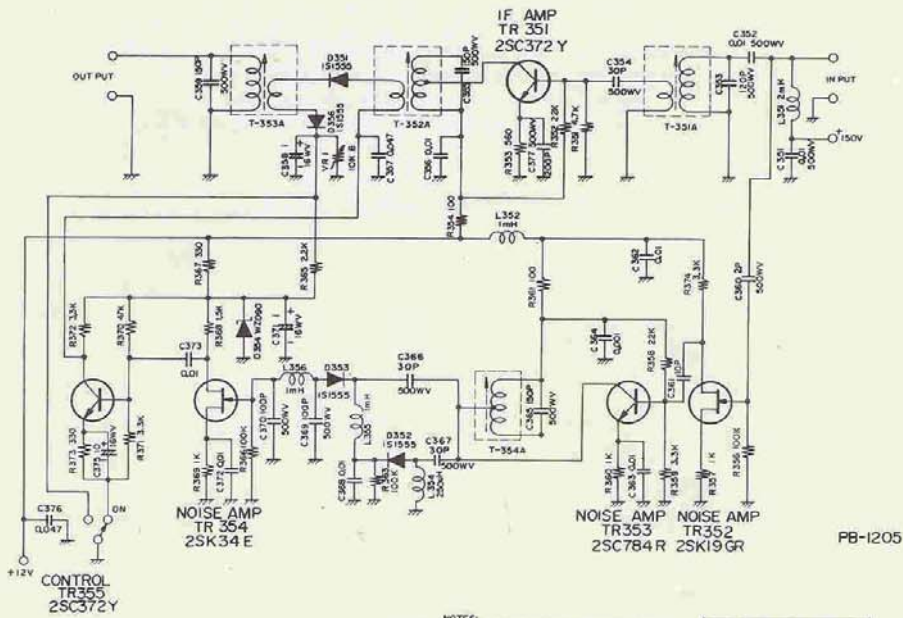

NOTES:  
 1. ALL RESISTORS IN OHM 1/4W ±10% UNLESS OTHERWISE NOTED.  
 2. ALL CAPACITORS IN P.F. 50V UNLESS OTHERWISE NOTED.

NOISE BLANKER  
CIRCUIT DIAGRAM

PB-1205

## RESISTANCE CHART

(Ω) USB

	TUBE	PIN											
		1	2	3	4	5	6	7	8	9	10	11	12
V 1	6 B Z 6	∞	100	0	0	7K	10K	0					
V 2	6 B A 6	50K	0	0	0	10K	10K	0					
V 3	6 A H 6	∞	0	0	0	10K	7K	1K					
V 4	6 G K 6	200	60K	0	0	0	0	10K	10K	0			
V 5	6 K D 6	0	0	7K	0	30K	0	0	0	30K	0	7K	0
V 6	6 K D 6	0	0	7K	0	30K	0	0	0	30K	0	7K	0
V 7	VR105MT	10K	0	∞	0	10K	∞	0					
V201	6 C B 6	∞	100	0	0	8K	8K	0					
V202	6 C B 6	∞	1K	0	0	8K	100K	0					
V203	6 B E 6	20K	100	0	0	8K	20K	100K					
V204	6 B Z 6	∞	100	0	0	8K	8K	100					
V205	6 B A 6	∞	60	0	0	8K	10K	60					
V206	1 2 A U 7	20K	50K	∞	0	0	20K	50K	1K	0			
V207	7 3 6 0	∞	0	∞	0	0	30K	30K	30K	30K			
V208	1 2 A X 7	∞	50K	3K	0	0	∞	∞	2K	0			
V209	1 2 A T 7	∞	∞	2K	0	0	20K	∞	2K	0			
V210	6 B M 8	∞	200	∞	0	0	10K	8K	2K	∞			
V211	6 B A 6	50K	0	0	0	10K	10K	200					
V212	6 U 8	∞	∞	∞	0	0	80K	∞	∞	∞			
V213	1 2 A U 7	50K	470	1K	0	0	100K	100K	1K	0			
V212	CW 6 U 8 TUNE	∞	∞	∞	0	0	80K	2K	10K	∞			

### ACCESSORY SOCKET CONNECTION

- Pin 1. 6KD6 Heater  
 2. 6.3 Volt AC  
 3. +150 Volt DC  
 4. +300 Volt DC  
 5. +600 Volt DC  
 6. -100 Volt DC  
 7. ALC

8. Ground  
 9. Relay contact open for receive and close to ground for transmit.  
 10. Relay contact open for transmit and close to ground for receive.  
 11. 6.3V AC

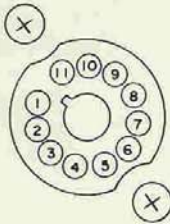

NOTE: ACCESSORY SOCKET IS WIRED TO USE TRANSVERTOR. WHEN TRANSVERTOR IS NOT USED, ACCESSORY PLUG MUST BE IN THE SOCKET, OTHERWISE, 6KD6 HEATERS ARE NOT CONNECTED TO POWER SUPPLY.

### KEY AND MICROPHONE CONNECTIONS

#### CONNECTION

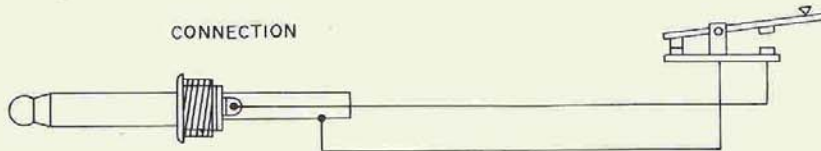

#### CONNECTION FOR PTT OPERATION

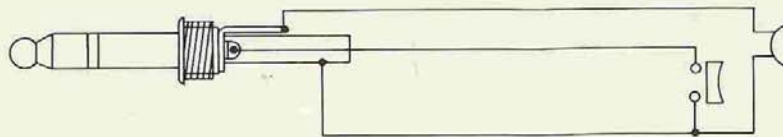

#### CONNECTION FOR MOX OPERATION

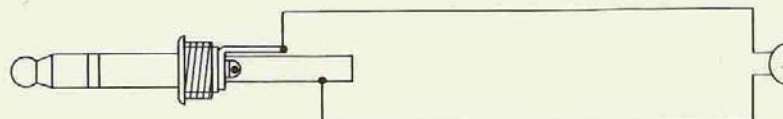





The FT-401B series transceivers have been modified for the AM operation, but the instruction manual has not yet been revised. The followings are supplemental information for the transceiver bearing the serial number later than 317001.

#### SPECIFICATIONS

Power Input	120 Watts DC.
Receiver Sensitivity	1uV or better at S/N 10 db.
Semiconductor Complement	2SC372Y 2 MK-10F 1 1S-1007 1

#### CIRCUIT

An AM modulator unit (PB-1165) consists of a carrier oscillator, a microphone amplifier and modulator, and an AM detector circuit are added to the main printed board PB-1001.

A 3180 KHz carrier signal is generated by TR453, 2SC-372Y, in the AM modulator unit and applied to the base of the AM modulator, TR452, 2SC-372Y, where the speech signal is applied through TR451, MK-10F, from the speech amplifier tube 12AX7 in the main printed board.

The modulator 3180 KHz signal is then applied to the grid of the transmitter first mixer, 6CB6, through T204.

The bias voltage applied to the base of TR453, carrier oscillator, disables the carrier oscillator during receiving period.

The received signal is added to the AM detector diode 1S-1007 from T205 in the main printed board. The detected audio signal is amplified by V210, 6BM8.

#### OPERATION

The AM signal is received when the Mode switch is placed to AM position. The maximum S-meter reading is used for calibration against the marker signal as the beat note can not be heard for AM operation.

After completion of transmitter tuning described in page 7 of the instruction manual, set the Mode switch to AM position. Set the Meter switch to IC position. Set the VOX control to MOX position. The meter will show 150mA. If the meter shows other than 150mA, adjust VR451 on the AM modulator unit PB-1165 for 150mA. Advance Mic Gain control until meter kicks up to 160mA at the voice peak. Excessive setting of Mic Gain control causes distortion due to overmodulation.



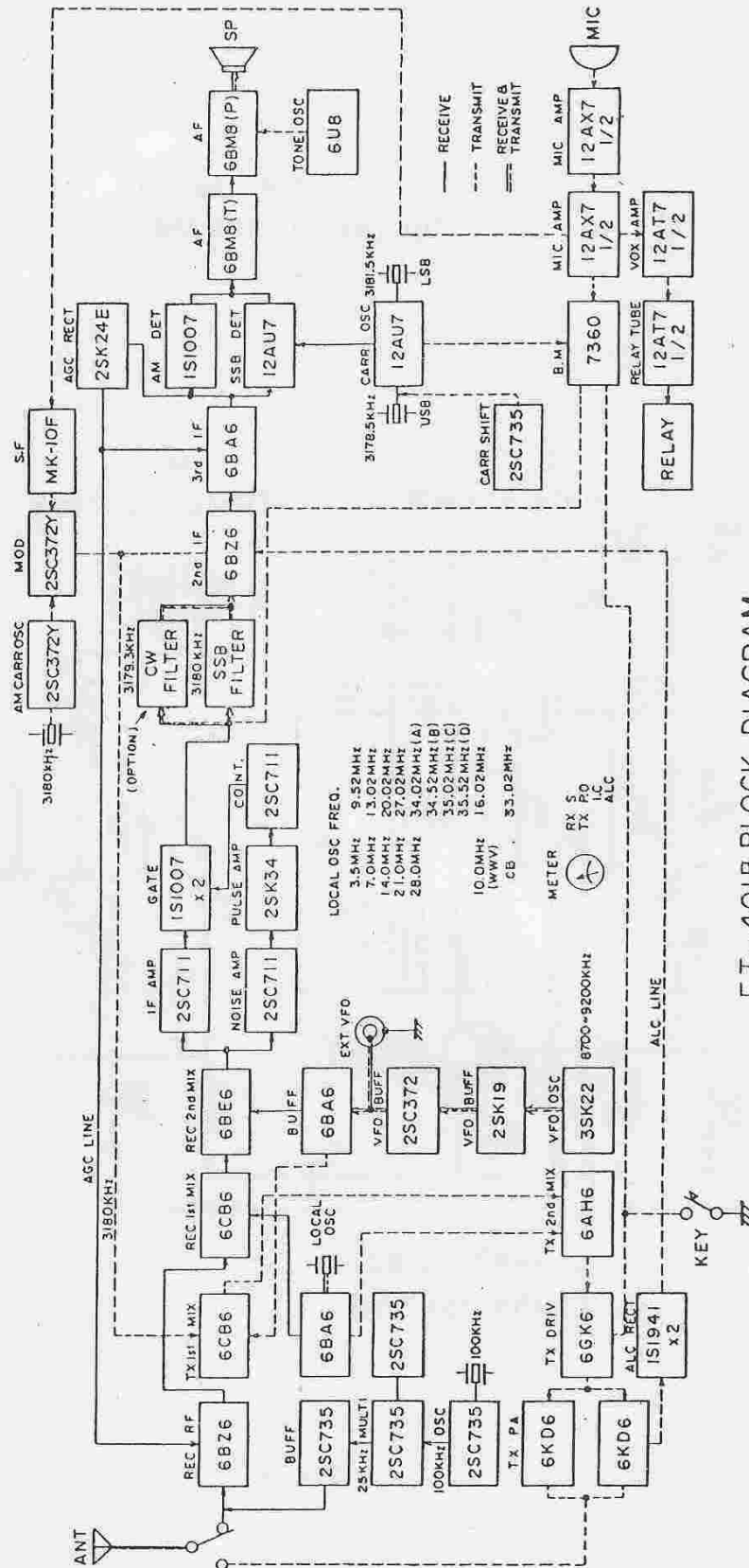

FT-401B BLOCK DIAGRAM

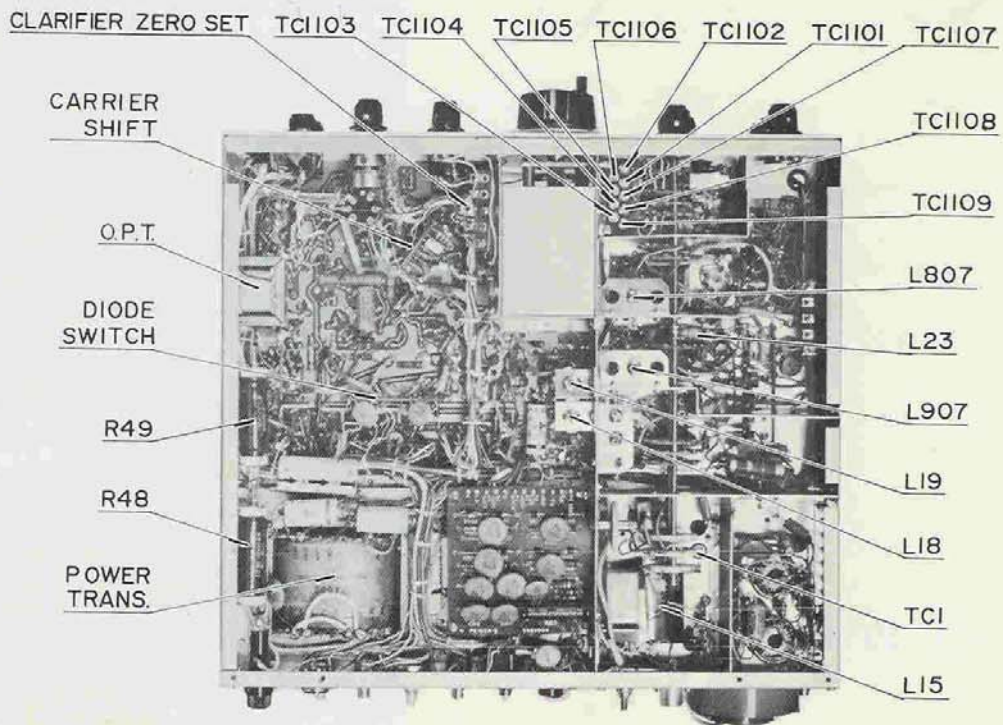
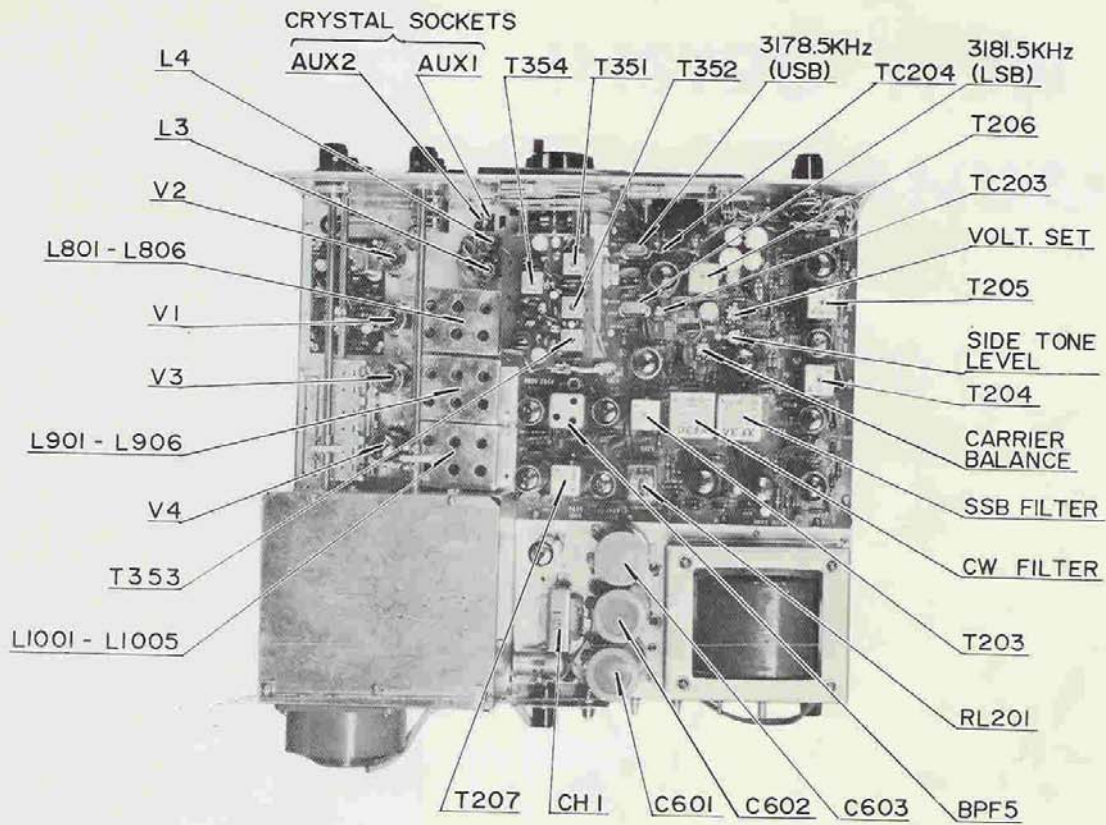





30310

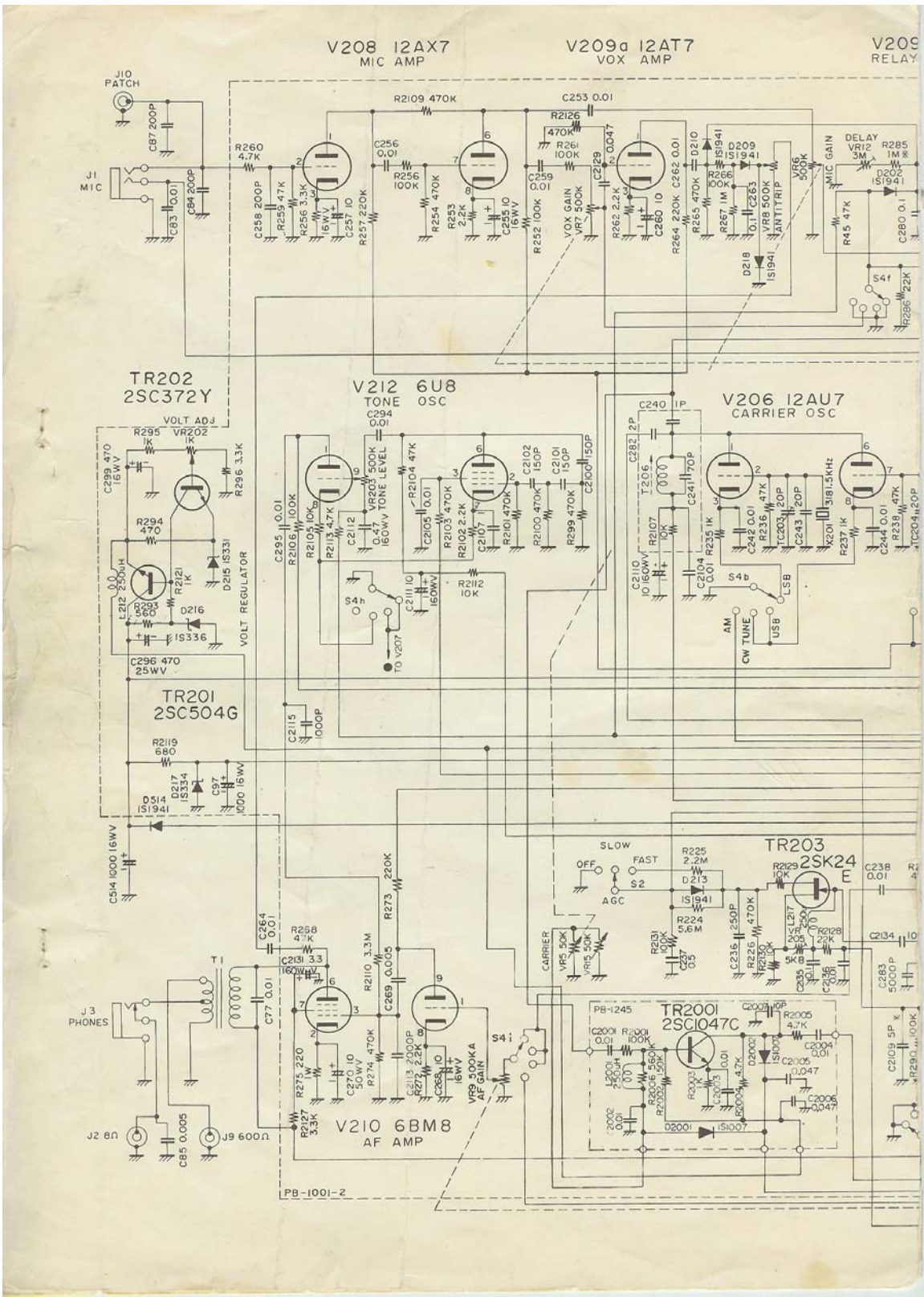



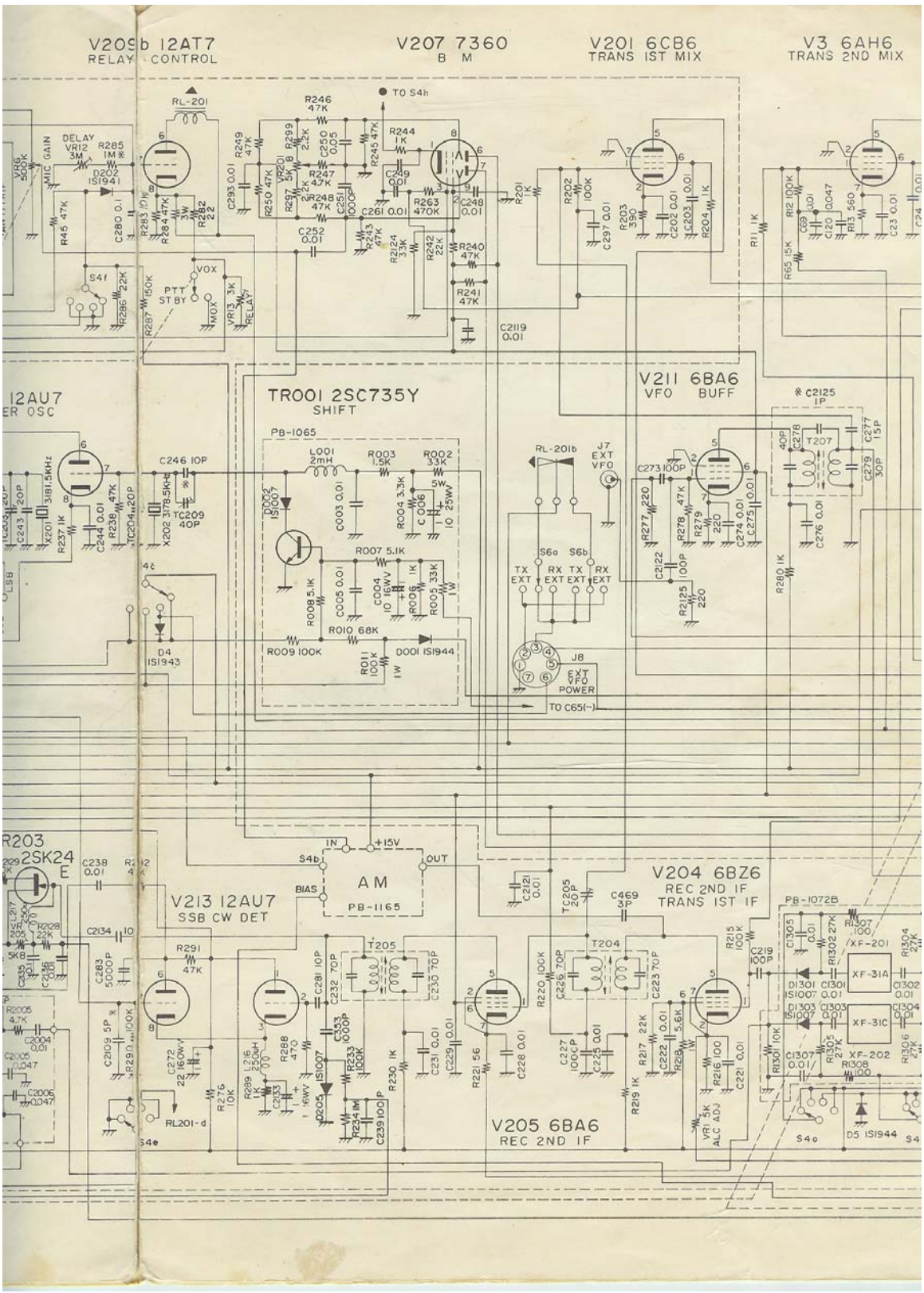

V209b 12AT7  
RELAY CONTROL

V207 7360  
B M

V201 6CB6  
TRANS 1ST MIX

V3 6AH6  
TRANS 2ND MIX

12AU7  
ER OSC

TROU1 2SC735Y  
SHIFT

V211 6BA6  
VFO BUFF

R203 2SK24

V213 12AU7  
SSB CW DET

V204 6BZ6  
REC 2ND IF  
TRANS 1ST IF

V205 6BA6  
REC 2ND IF

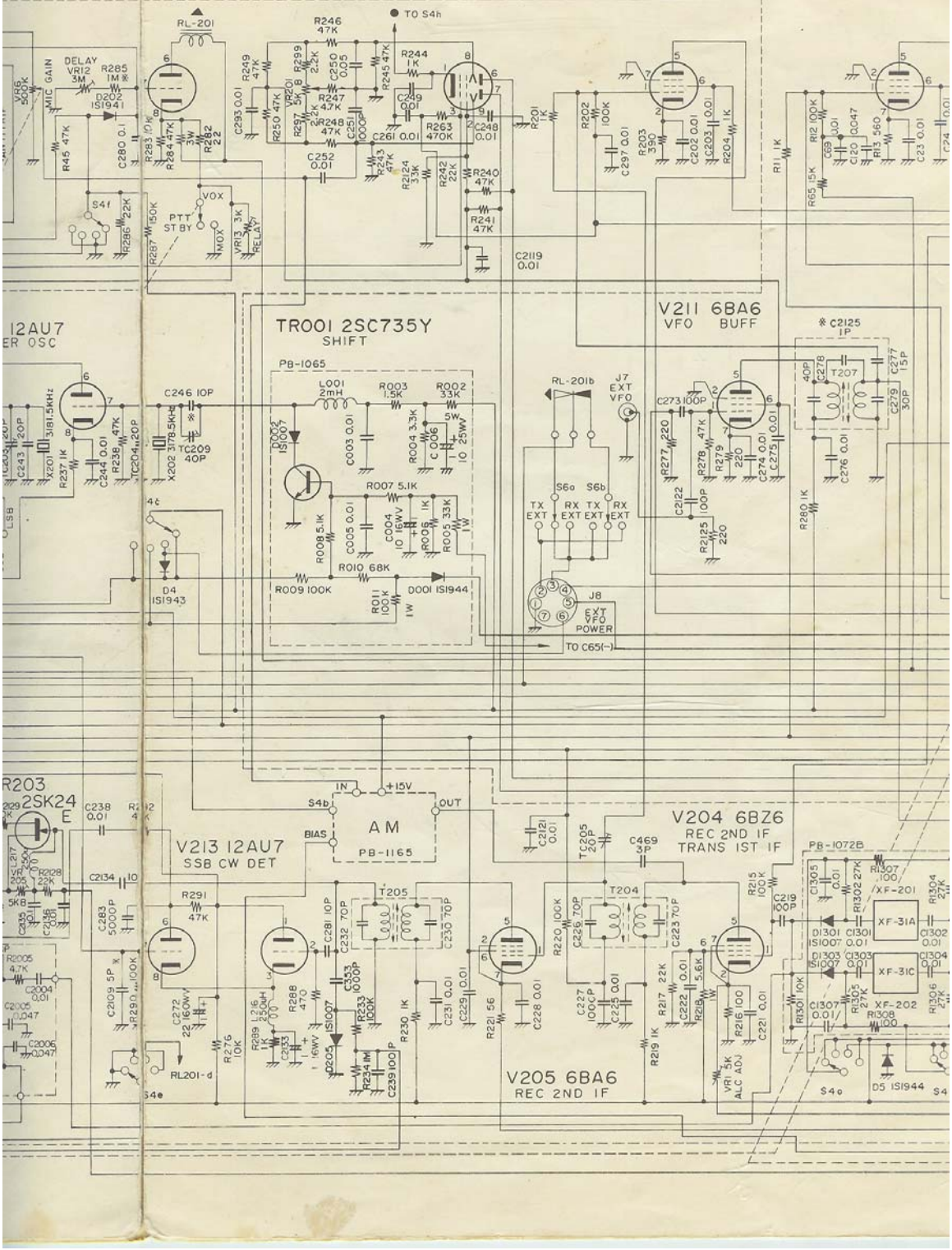

V3 6AH6  
RANS 2ND MIX

V4 6GK6  
DRIVER

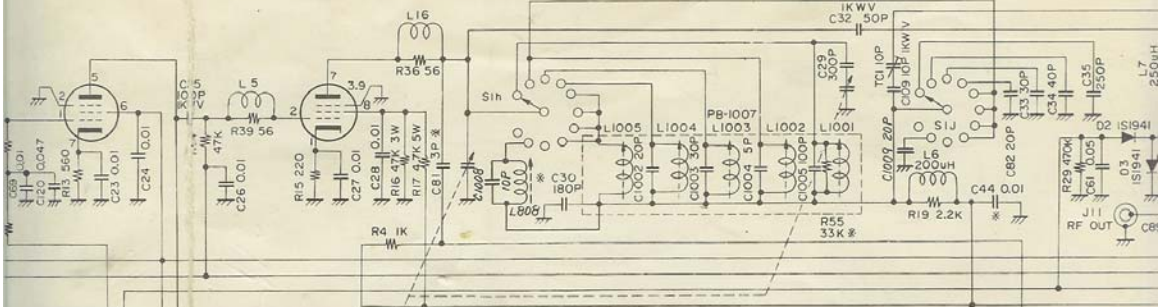

TR401 3SK22G VFO OSC  
TR402 2SK19G VFO BUFF  
TR403 2SC372Y VFO AMP

NOISE BLANKER

V2 6BA6  
LOCAL OSC

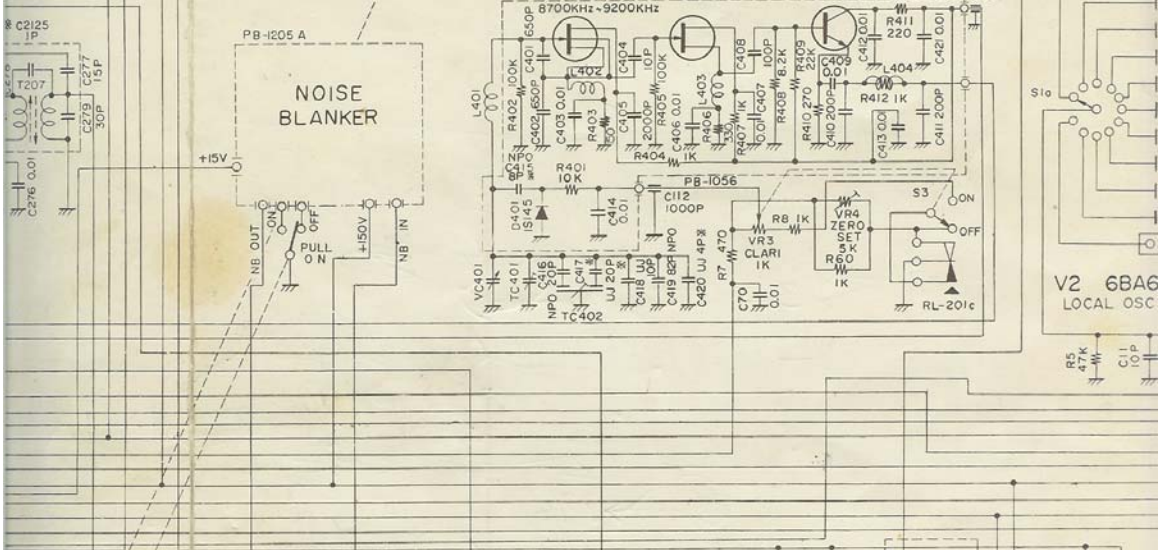

V203 6BE6  
REC 2ND MIX

V202 6CB6  
REC 1ST MIX

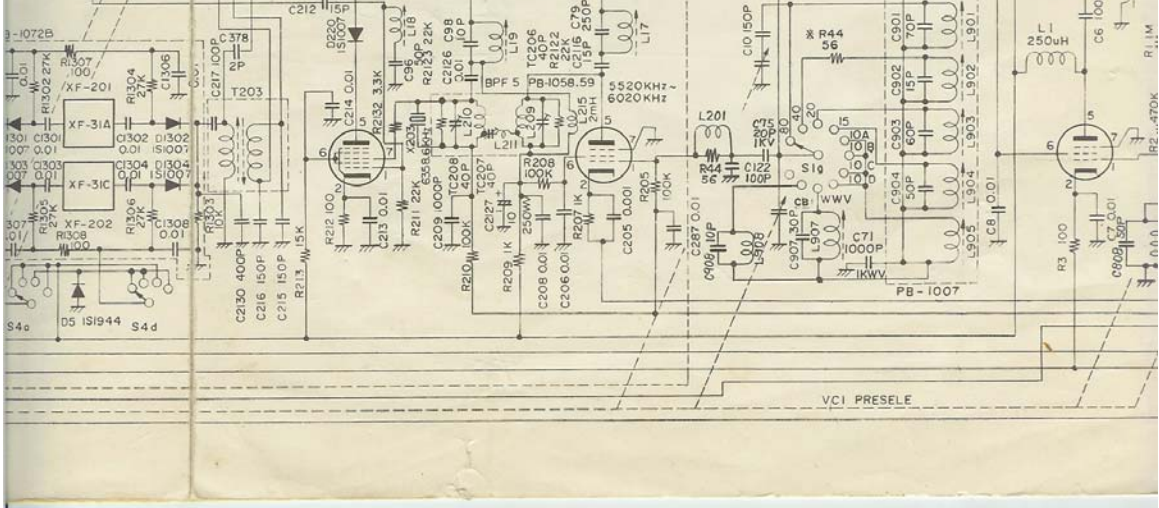





V6 6KD6

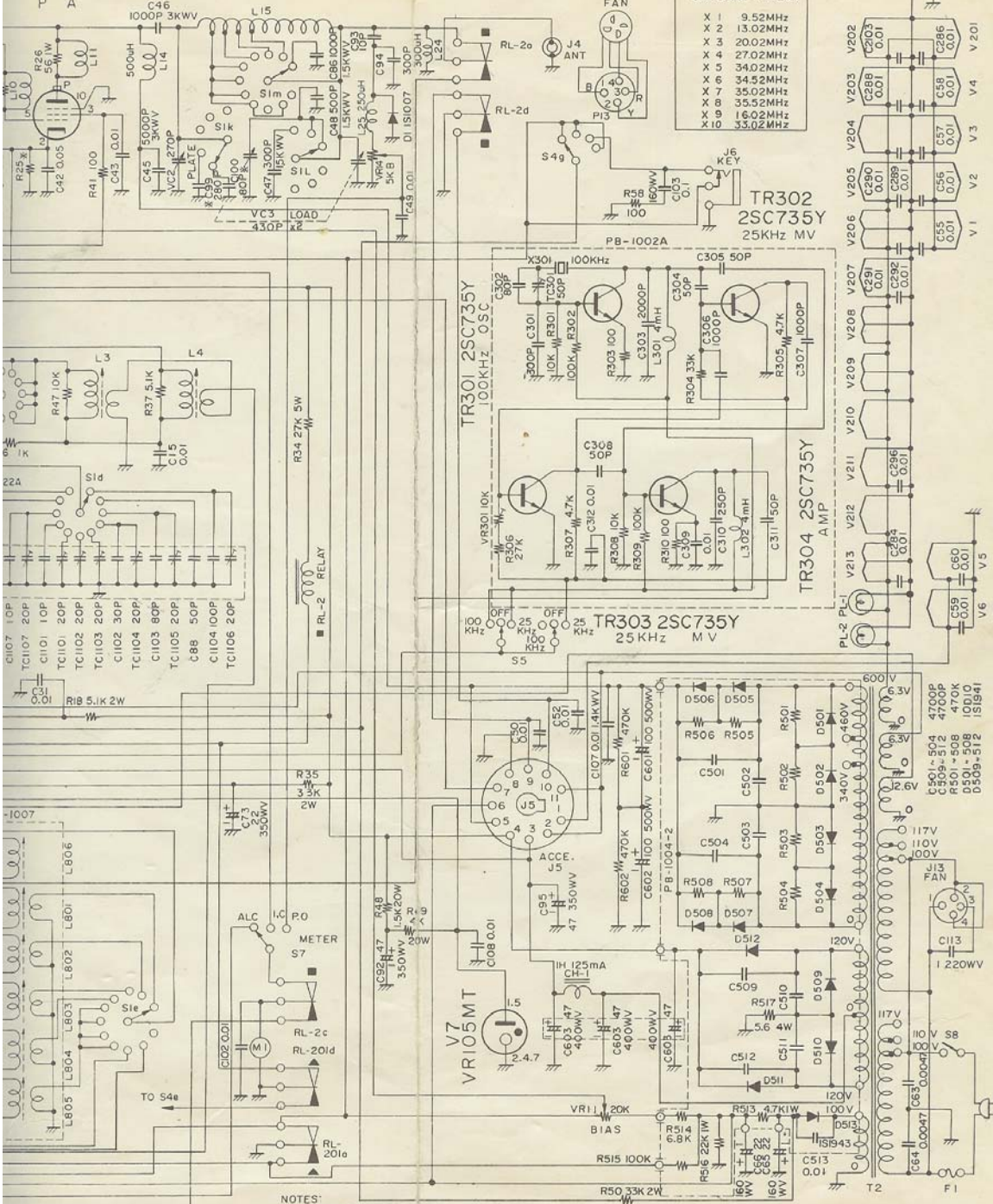

LOCAL OSC  
CRYSTAL FREQ.

X 1	9.52MHz
X 2	13.02MHz
X 3	20.02MHz
X 4	27.02MHz
X 5	34.02MHz
X 6	34.52MHz
X 7	35.02MHz
X 8	35.52MHz
X 9	16.02MHz
X 0	33.02MHz

- NOTES:
1. ALL RESISTORS 1% OHM 1/2W ± 10% UNLESS OTHERWISE NOTED.
  2. ALL CAPACITORS IN μF UNLESS OTHERWISE NOTED.
  3. \* VALUE IS NOMINAL

FT-401B/FTdx 505  
CIRCUIT DIAGRAM

317001