

YAESU

**OPERATING
MANUAL**

FT-747GX

YAESU MUSEN CO., LTD.

C.P.O. BOX 1500

TOKYO, JAPAN

CONTENTS

<p>1. SPECIFICATIONS 2</p> <p style="padding-left: 20px;">TRANSMITTER 2</p> <p style="padding-left: 20px;">RECEIVER 2</p> <p style="padding-left: 20px;">GENERAL 3</p> <p style="padding-left: 20px;">ACCESSORIES 3</p> <p>2. CONTROLS AND CONNECTORS . . . 4</p> <p style="padding-left: 20px;">FRONT PANEL CONTROLS 4</p> <p style="padding-left: 20px;">REAR PANEL CONTROLS & CONNEC- TORS 7</p> <p>3. INSTALLATION 9</p> <p style="padding-left: 20px;">Preliminary Inspection 9</p> <p style="padding-left: 20px;">Base Station Installation 9</p> <p style="padding-left: 20px;">Equipment Location and Grounding 10</p> <p style="padding-left: 20px;">Antenna Considerations 10</p> <p style="padding-left: 20px;">Receiver Front End Protection 10</p> <p style="padding-left: 20px;">Mobile Power Connection 11</p> <p style="padding-left: 20px;">Mobile Mounting 11</p> <p style="padding-left: 20px;">Mobile Antenna Installation 11</p> <p style="padding-left: 20px;">Interconnections 12</p> <p style="padding-left: 20px;">Memory Backup 12</p> <p>4. OPERATION 14</p> <p style="padding-left: 20px;">BASIC RECEPTION 14</p> <p style="padding-left: 40px;">Band Selection 14</p> <p style="padding-left: 40px;">Mode Selection 14</p> <p style="padding-left: 40px;">Tuning 15</p> <p style="padding-left: 40px;">SSB Reception 15</p> <p style="padding-left: 60px;">Attenuator (15); Noise Blank- er (15); Squelch (15)</p>	<p style="padding-left: 40px;">CW Reception 16</p> <p style="padding-left: 40px;">AM Reception 16</p> <p style="padding-left: 40px;">FM Reception 16</p> <p style="padding-left: 40px;">RTTY and Packet Reception 17</p> <p style="padding-left: 20px;">TRANSMITTER OPERATION 17</p> <p style="padding-left: 40px;">SSB Transmission 17</p> <p style="padding-left: 60px;">Clarifier (18)</p> <p style="padding-left: 40px;">CW Transmission 18</p> <p style="padding-left: 40px;">FM Transmission 18</p> <p style="padding-left: 40px;">AM Transmission 19</p> <p style="padding-left: 40px;">RTTY, HF Packet & SSTV Trans- mission 19</p> <p style="padding-left: 20px;">MEMORY OPERATION 20</p> <p style="padding-left: 40px;">VFO A/B Selection 20</p> <p style="padding-left: 40px;">VFO/Memory Selection 20</p> <p style="padding-left: 40px;">Memory Storage 20</p> <p style="padding-left: 40px;">Memory Recall 20</p> <p style="padding-left: 40px;">Changing Memory Mode & Fre- quency 21</p> <p style="padding-left: 60px;">Split Frequency Operation 21</p> <p style="padding-left: 20px;">SCANNING 21</p> <p style="padding-left: 40px;">Selective Memory Scanning 22</p> <p style="padding-left: 20px;">PRIORITY CHANNEL MONITORING 22</p> <p>5. MODIFICATIONS & OPTIONS 23</p> <p style="padding-left: 20px;">Top Cover Removal 23</p> <p style="padding-left: 20px;">AGC Time Constant Selection 24</p> <p style="padding-left: 20px;">Tx Control for FC-757AT & FL-7000 24</p> <p style="padding-left: 20px;">Optional FM Unit Installation 24</p> <p style="padding-left: 20px;">Optional TCXO Installation 25</p> <p>6. CAT SYSTEM COMPUTER CONTROL 26</p>
--	---

FT-747GX
HF ALL MODE
COMPUTER AIDED TRANSCEIVER



The FT-747GX is a compact SSB/CW/AM and (optionally) FM transceiver for the amateur radio service, providing 100 watts of PEP transmitter power output on all hf amateur bands, and general coverage reception from 100 kHz to 30 MHz.

Convenient features include operator selectable mode-dependent tuning steps, twenty memory channels which store mode, simplex or split frequencies and scanning status, auto-resume scanning of selectable memories, a clarifier, and a CAT (Computer Aided Transceiver) System for user programming and more advanced control by an external computer. Wideband (6 kHz) AM and narrowband (500 Hz) CW IF filters are included as standard. A switchable 20dB receiver attenuator and noise blanker are provided to optimize reception under varying conditions.

The transmitter power amplifier is enclosed in its own diecast aluminum heatsink chamber inside the transceiver, with forced-air cooling by an internal fan allowing full power FM and AFSK operation when used with a heavy duty power supply. Optional accessories include your choice of the MD-1B8 Desktop Scanning Microphone or the MH-1B8 Handy Scanning Microphone, and the microprocessor controlled FC-757AT or FC-1000 Automatic Antenna Tuners or FL-7000 500-watt Automatic Solid State Linear Amplifier.

Special power supplies for the FT-747GX include the FP-757HD Heavy Duty Series-Regulator Power Supply with forced-air cooling and automatic thermal fan control, or the FP-700 standard power supply for low power and light-duty applications. Both power supplies can be wired for 100/110/117/200/220 or 234 VAC.

1. SPECIFICATIONS

TRANSMITTER

Frequency range

160m band - 1.5 to 1.9999 MHz
80m band - 3.5 to 3.9999 MHz
40m band - 7.0 to 7.4999 MHz
30m band - 10.0 to 10.4999 MHz
20m band - 14.0 to 14.4999 MHz
17m band - 18.0 to 18.4999 MHz
15m band - 21.0 to 21.4999 MHz
12m band - 24.5 to 24.9999 MHz
10m band - 28.0 to 29.9999 MHz

Emission types

LSB, USB (J3E); CW (A1A); AM (A3E)
and optionally FM (F3E)

Power output

SSB, CW & FM*: 100W PEP/DC,
AM: 25W Carrier

SSB Carrier suppression

better than 40dB below peak output

Unwanted sideband suppression (SSB)

better than 50dB (1 kHz tone)

Spurious radiation

Harmonic: better than -50dB
Non-Harmonic: better than -40dB

Audio response

less than -6dB from 400 to 2600Hz

3rd order intermodulation distortion

better than -25dB (@100W PEP)

Modulation systems

SSB/CW: active balanced modulator
AM: early stage (low level)
FM*: variable reactance

Maximum FM* deviation

± 2.5 kHz

Microphone impedance

500 to 600 ohms

RECEIVER

Frequency range

100 kHz to 29.9999 MHz (continuous)

Circuit type

CW, SSB, AM: double conversion
FM*: triple conversion

Clarifier range

±9.975 kHz

Sensitivity (for 10dB S+N/N, exc FM)

	0.5-1.5MHz	>1.5MHz
SSB/CW:	0.5uV	0.25uV
AM:	2uV	1.0uV
FM*:	0.7uV for 12dB SINAD (above 28MHz)	

Squelch sensitivity

SSB/CW/AM: 2.0uV above 1.5 MHz,
4.0uV within 0.5-1.5 MHz
FM*: 0.32uV

Intermediate frequencies

47.055MHz, 8.215MHz, 455kHz(FM-only*)

Image rejection

better than 70dB within 1.5-30MHz

IF rejection

better than 60dB within 1.5-30MHz

Selectivity (-6/-60dB)

SSB, CW(W), AM(N): 2.2/5 kHz
CW(N): 500 Hz/1.8 kHz
AM(W): 6/14 kHz; FM(-6/-50dB)*: 8/19kHz

Maximum audio power output

at least 1.5W into 8 ohms w/10% THD

* FM operation requires optional unit.

Audio output impedance
4 to 8 ohms

GENERAL

Tuning steps (selectable)

SSB & CW: 25 Hz or 2.5 kHz/step
AM: 1 kHz or 10 kHz/step
FM*: 12.5 kHz or 5 kHz/step

Frequency stability (0° to +40°C)

SSB, CW, AM: ±200 Hz
FM: ±300 Hz

Frequency accuracy

SSB, CW, AM: ±200 Hz
FM: ±300 Hz

Antenna impedance (nominal)

50 ohms, unbalanced

Supply voltage

13.5 V DC ±10% (neg. ground)

Maximum current consumption

19A (@100W output)

Dimensions (WHD)

238 x 93 x 238mm (without knobs)

Weight (approx)

3.3 kg (7.25 lb)

Specifications may be subject to change without notice or obligation.

ACCESSORIES

Supplied

	<u>Part No.</u>
DC Power Cord (w/o fuse)	T9014900
20A Fuses (2 supplied)	Q0000009

Options

<u>Model</u>	<u>Part No.</u>
MD-1B8 Desktop Scanning Mic.	D1000039
MH-1B8 Hand Scanning Mic.	D1000040
FRB-757 Relay Control Box	D3000280
MMB-38 Mobile Bracket	D6000032
External Computer Interfaces	
FIF-65A for Apple II	
FIF-232 for RS-232C	
FP-757HD Heavy Duty Power Supply	
FP-700 Standard Duty Power Supply	
FC-757AT Automatic Antenna Tuner (100W)	
FL-7000 500W Automatic Linear Amplifier	
FAS-1-4R Remote Antenna Selector (for use with FC-757AT or FL-7000)	
SP-767 Base Station Loudspeaker	
SP-767P Base Loudspeaker w/Phone Patch	
SP-55 Mobile Loudspeaker	

Audio output impedance
4 to 8 ohms

GENERAL

Tuning steps (selectable)

SSB & CW: 25 Hz or 2.5 kHz/step

AM: 1 kHz or 10 kHz/step

FM*: 12.5 kHz or 5 kHz/step

Frequency stability (0° to +40°C)

SSB, CW, AM: ±200 Hz

FM: ±300 Hz

Frequency accuracy

SSB, CW, AM: ±200 Hz

FM: ±300 Hz

Antenna impedance (nominal)

50 ohms, unbalanced

Supply voltage

13.5 V DC ±10% (neg. ground)

Maximum current consumption

19A (@100W output)

Dimensions (WHD)

238 x 93 x 238mm (without knobs)

Weight (approx)

3.3 kg (7.25 lb)

Specifications may be subject to change
without notice or obligation.

ACCESSORIES

Supplied

DC Power Cord (w/o fuse)

20A Fuses (2 supplied)

Part No.

T9014900

Q0000009

Options

Model

Part No.

MD-1B8 Desktop Scanning Mic. D1000039

MH-1B8 Hand Scanning Mic. D1000040

FRB-757 Relay Control Box D3000280

MMB-38 Mobile Bracket D6000032

External Computer Interfaces

FIF-65A for Apple II

FIF-232 for RS-232C

FP-757HD Heavy Duty Power Supply

FP-700 Standard Duty Power Supply

FC-757AT Automatic Antenna Tuner (100W)

FL-7000 500W Automatic Linear Amplifier

FAS-1-4R Remote Antenna Selector (for
use with FC-757AT or FL-7000)

SP-767 Base Station Loudspeaker

SP-767P Base Loudspeaker w/Phone Patch

SP-55 Mobile Loudspeaker

2. CONTROLS AND CONNECTORS

FRONT PANEL CONTROLS

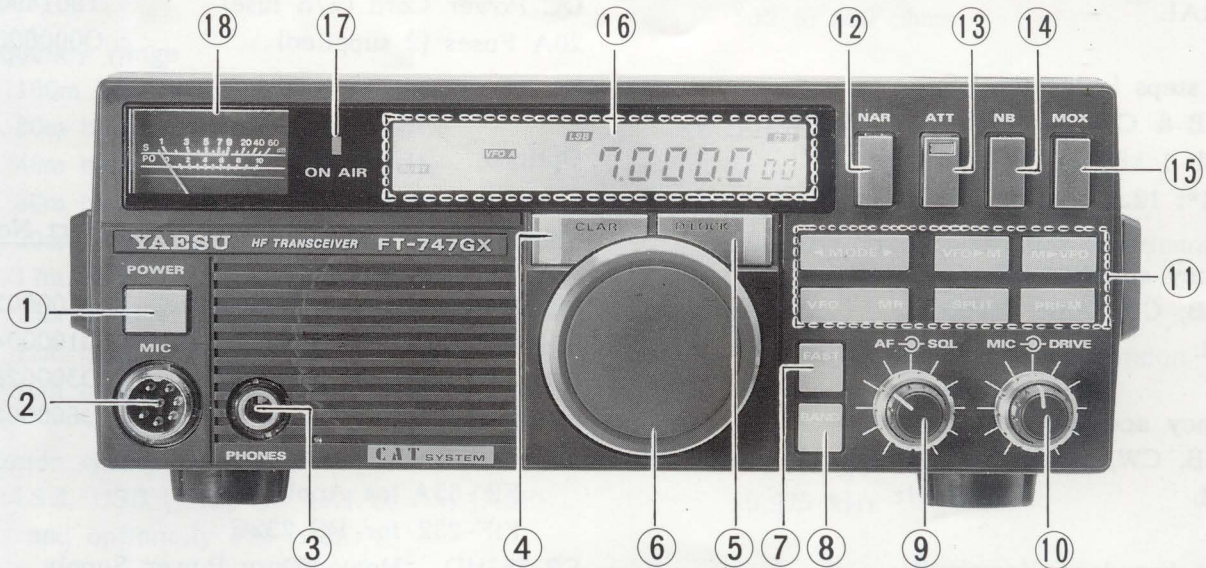

(1) POWER

This pushbutton switch turns the transceiver on and off. Frequency and mode data in the memories and vfos is not affected by this switch (or by whether power is connected to the transceiver), since the data is retained by an internal lithium battery.

(2) MICrophone

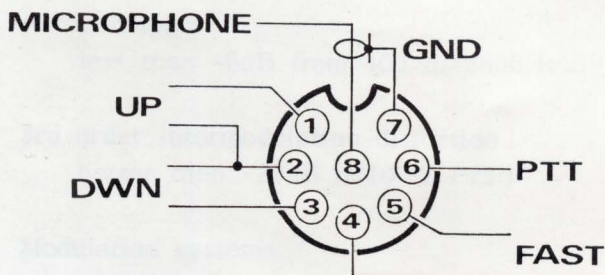

This 8-pin connector accepts the plug of the MD-1B8 Desktop Mic or MH-1B8 Hand Mic. Scanning control lines from these microphones allow pushbutton fast and slow tuning and scanning from the microphone.

(3) PHONES

Monaural or stereo headphones with 4-16 ohms impedance may be connected to this jack. Stereo headphones with a 3-conductor plug reproduce audio in both ears, as with monaural headphones with a 2-conductor plug. Inserting a plug into this jack disables the internal or external loudspeaker.

(4) CLAR

Press this button while receiving to activate clarifier operation. The tuning knob then tunes the receiver without affecting the transmit frequency. Press this button again to turn off the clarifier.

(5) D LOCK

This button disables the tuning knob and microphone tuning buttons to prevent accidental frequency changes. "LOCK" is shown on the display when active. Press this button again to re-enable tuning.

(6) Tuning Knob and (7) FAST button

When operating on a vfo, this knob tunes at a rate determined by the operating mode and selected by the FAST button:

MODE	FAST ON	FAST OFF
SSB/CW	2.5 kHz	25 Hz
AM	10 kHz	1 kHz
FM*	12.5 kHz	5 kHz

* requires optional FM Unit

When operating on memories, the tuning knob selects the operating memory.

(8) BAND button

When receiving on a vfo, this button is used to change frequency bands by providing 500 kHz tuning knob steps (or 5 MHz steps when FAST tuning has been selected).

(9) AF/SQL

The inner AF control adjusts receiver volume.

The outer squelch control sets the threshold level of incoming signals or noise at which receiver audio is muted. Clockwise rotation increases the threshold level, causing the receiver not to respond to background noise or weaker signals.

(10) MIC/DRIVE

The inner MICrophone control adjusts the gain of the transmit audio amplifier during SSB and AM transmission (for FM, gain is preset internally). This adjusts output power in SSB modes, and modulation level in the AM mode. It is disabled for FM and CW.

The outer DRIVE control adjusts the carrier power output level for CW, AM and FM transmission. This control is disabled during SSB transmission.

(11) Momentary Push Keys

◀MODE▶

Press either side of this see-saw button to select the operating mode: LSB, USB, CW, AM and FM. The mode is indicated on the display above the operating frequency (in the above order). Press the left side to select a mode left of the present one displayed, or the right side to select a mode to the right (FM operation requires the optional FM Unit).

VFO▶M

Press this button when operating on a vfo to store the frequency and mode data from that vfo into the memory (whose number is displayed at the right). This will overwrite previous memory data, and leave the vfo and memory the same. When operating on a memory with the squelch closed, this button toggles the selective scan feature.

M▶VFO

Press this button when operating on a memory to transfer its data into the last-used vfo. This overwrites previous vfo data, leaving the vfo and memory the same. After pressing this button operation is on the vfo.

VFO/MR

This see-saw button switches operation between the vfos and the memory. When operating on a vfo, pressing the VFO side selects the other vfo (A or B, displayed), and pressing the MR side selects the memory (number displayed). When operating on a memory, pressing the VFO side selects the last-used vfo. The frequency and mode data in the vfo and memory are unaffected. The display indicates which (VFO A, VFO B or MemoRy) is currently selected.

SPLIT

Press this button to activate split-frequency operation between the two vfos, and press it again to cancel split operation.

PRI-M

This button activates priority monitoring of the memory while operating on a vfo. This feature is described in the Operation section.

(12) NAR (Narrow) Button

This button selects narrow IF filters when operating in the CW or AM modes. "NAR" is displayed above the rightmost frequency digit when a narrow filter is selected.

(13) ATT Button & Indicator Lamp

Places a 20dB attenuator in the receiver front end circuit, to avoid overload of the rf amplifier and mixer when listening to very strong signals, by reducing the sensitivity of the receiver. The indicator on the button glows green when the attenuator is on.

(14) NB (Noise Blanker) Button

Activates the noise blanker for SSB, CW and AM reception.

(15) MOX Button

Manually switches the transmitter on and off. This button MUST be in the OUT position to receive.

(16) Display

All of the segments of the display are shown in the diagram below. To the left of the operating frequency, the display the indicators signify as follows:

- BAND - blinks when changing band
- SCAN - the operating memory is activated for scanning. Blinks when scanning.
- BUSY - the squelch is open
- LOCK - tuning knob locked
- SPLIT - split frequency operation active
- CLAR - clarifier active
- FAST - fast (coarse) tuning active
- VFO A- operating vfo, or
- VFO B- or
- MR - operation is on the memory

The digital frequency display indicates the operating frequency with 100 Hz resolution. The number of the active (or last-used) memory (00 thru 19) is displayed to the right of the frequency (with 'CH' above).

(17) ON AIR Indicator Lamp

This lamp glows red when transmitting.

(18) Meter

The meter shows relative signal strength in S-units on the uppermost scale when receiving, and relative power output (PO), when transmitting.



REAR PANEL CONTROLS & CONNECTORS

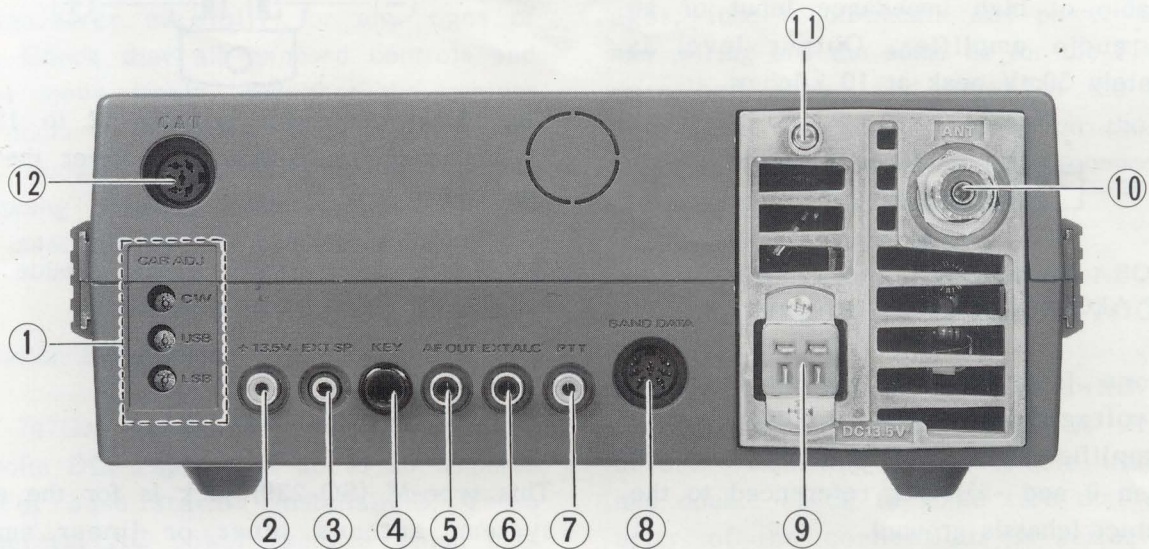

(1) CAR ADJ Potentiometers

These (recessed) trimmer capacitors set the IF passband center offset from the carrier. They are aligned at the factory and should not be adjusted without proper test equipment. The procedure is described in the "FT-747GX Technical Supplement".

(2) +13.5V

This phono jack provides 13.5V DC at up to 200 mA for powering accessories. The center contact is positive.

Note: Repairs to damage caused by exceeding the current capabilities of the accessory DC jack may not be covered by the warranty.

(3) EXT SP (External Speaker)

This 1/8-inch 2-conductor mini phone jack provides amplified receiver output to drive an external 4- to 16-ohm loudspeaker.

(4) KEY

This 1/4-inch 2-conductor phone jack accepts a CW key or external electronic keyer. Open circuit voltage is +13V DC and closed circuit current is 0.7 to 1 mA.

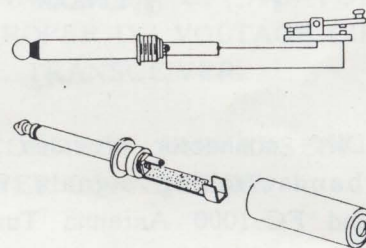

(5) AF OUT

This phono jack provides constant low-level receiver audio, unaffected by the AF gain control, for tape recording, digital demodulators capable of high impedance input or an external audio amplifier. Output level is approximately 50mV peak at 10 kilohms.

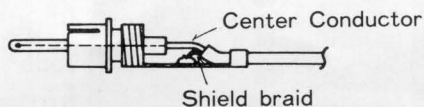

(6) EXT ALC

This phono jack accepts automatic level control voltage for the transmitter from a linear amplifier. The applied voltage should be between 0 and -5V DC, referenced to the outer contact (chassis ground).

(7) PTT Jack

This phono jack provides access to the PTT line, for external receive/transmit switching. Connecting the inner contact to the outer contact (chassis ground) activates the transmitter. Open circuit voltage is about 5V, and closed circuit current is about 1 mA.

(8) BAND DATA

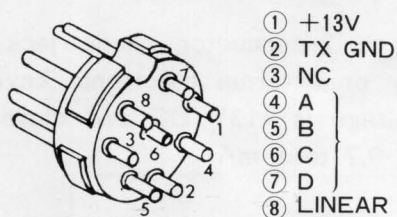

This 8-pin DIN connector provides parallel TTL-level bandswitching signals for the FC-757AT and FC-1000 Antenna Tuners or the FL-7000 Linear Amplifier.

(9) DC 13.5V

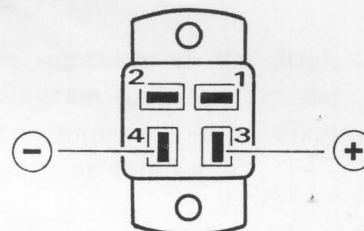

This 4-pin connector accepts 12 to 15V DC at 19 amperes (transmit), to power the transceiver.

CAUTION: AC voltage or DC outside of this range may damage the transceiver.

(10) ANT Coaxial Jack

This type-M (SO-239) jack is for the antenna system, antenna tuner or linear amplifier input. Impedance requirement is 50 ohms, unbalanced. Use only a properly mating type-M (PL-259) plug and 50- or 52-ohm coaxial cable.

(11) GND

For best performance and safety, connect this terminal to a good earth ground through the shortest path possible.

(12) CAT



This 6-pin DIN jack provides access to the serial data lines from the microcomputer and A/D converter, for control of the transceiver from an external computer. See the CAT section of this manual for details.

3. INSTALLATION

Preliminary Inspection

When you open the packing carton, inspect the transceiver carefully for any signs of damage. Check that all exposed controls and switches move freely, and that the cabinet has no dents or scratches. If you notice any damage, document it completely and contact the shipping company immediately. Save the packing materials for possible future use.

Base Station Installation

The FT-747GX requires a power source of 12 to 15 volts DC, capable of up to 20 amperes peak. For base station installations, Yaesu offers several AC power supplies which may be used with AC line voltages of 100, 110, 117, 200, 220 or 234 VAC. However, before connecting any power supply to the transceiver or AC line, make sure that the supply is properly wired for the local line voltage, and that the correct fuse is installed.



FP-757HD

The FP-757HD is a heavy duty series regulated power supply capable of full power transmissions for up to 30 minutes at a time (50% duty cycle is recommended for continuous operation). Forced-air cooling is provided over an extra large internal heatsink. The FP-757HD requires a 6-amp fuse for 100, 110 or 117 VAC, or a 3-amp fuse for 200, 220 or 234 VAC. Power transformer primary connections for the different line voltages are shown at the right.

The FP-700 power series regulated supply may be used for light duty operation (CW, SSB or reduced power AM or FM). AC voltages, fuse requirements and power transformer wiring are the same as for the FP-757HD described above and shown in the diagram below, but the plastic sleeve on the supply DC cable must be cut to allow connection to the speaker in the power supply.

NEVER CONNECT AC, OR DC ABOVE 15V, DIRECTLY TO THE FT-747GX.

Make certain that the POWER switch on the front panel of the FT-747GX is OFF (out) before connecting power to the transceiver, and double check to make sure that the polarity of the connections is correct before switching the transceiver on.

Power Transformer Primary Connections

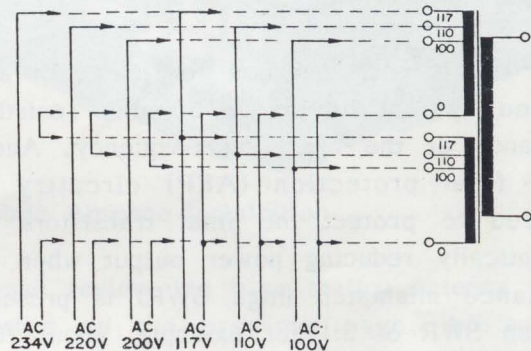

NOTICE

THE FOLLOWING ABUSES MAY CAUSE DAMAGE TO THE EQUIPMENT WHICH IS NOT COVERED UNDER WARRANTY:

- (1) CONNECTION OF AC VOLTAGE OR IMPROPER DC VOLTAGE DIRECTLY TO THE TRANSCEIVER.
- (2) INCORRECT (REVERSED) POLARITY POWER CONNECTION.
- (3) USE OF AN IMPROPER FUSE IN THE POWER SUPPLY.

Equipment Location and Grounding

In all base station installations, the GND terminal on the rear panel of the transceiver should be connected by a heavy braided cable to a good earth ground. Best performance on all frequencies may require that the grounding cable be less than 10 feet (3 meters) long. All station equipment should have its own grounding cable (independent of signal or control cables), connected to a common point on the ground bus close to the transceiver or linear amplifier (if used). See the diagram below.

Locate the transceiver so that air can flow freely into the air intake on the left side, and out the rear. Avoid placing the transceiver on top of another heat generating device such as a linear amplifier.

Antenna Considerations

The FT-747GX is designed for use with any antenna system having a 50-ohm resistive impedance at the operating frequency. Automatic final protection (AFP) circuitry is included to protect the final transistors by automatically reducing power output when an impedance mismatch (high SWR) is present. With an SWR of 3:1 for example, about 75% of full power output is available.

Despite this protection, the transmitter should never be activated unless an antenna or dummy load is connected to the ANT jack. Use 50-ohm coaxial cable with a proper

(type-M, PL-259) plug to connect the transceiver to the antenna or load, and if SWR is too high to permit the desired performance, connect an antenna tuner such as the automatic FC-757AT or FC-1000 between the transceiver and the antenna. See page 12 for interconnection information.

Receiver Front End Protection

The receiver front end in FT-747GX includes a surge suppressor and a lamp fuse to protect the sensitive receiver circuitry from high voltage pulses (EMP) at the antenna terminal, and a choke to bypass DC overload. Several thousands of volts can develop naturally when dry wind or electrical storms create an electrostatic charge on the antenna elements, and this is delivered to the antenna jack if the antenna is connected to the transceiver. In such a case, the lamp fuse may burn out (even if the transceiver is turned off at the time). The only sure way to avoid this condition is to disconnect the antenna from the transceiver whenever the weather is likely to create high voltage on the antenna (the feedline should be grounded to allow the charge to dissipate).

If the receiver is found to have suddenly lost sensitivity, inspect the filament of the lamp fuse (F1001 on the MAIN Unit). If it is open, determine the cause of the overvoltage; eg., was the antenna left connected during an electrical storm or dry windy weather since you last used the equipment? To obtain replacement lamp fuses, ask your local Yaesu

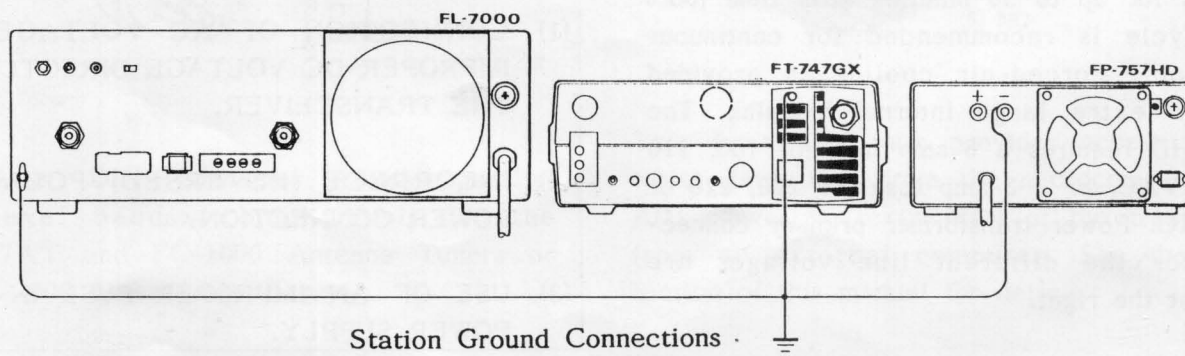

dealer for Yaesu part no. Q1000010, BQ041-22803A; or substitute any 8V 100mA pilot lamp. Do not jumper across the lamp fuse terminals however, as this will defeat the protection and could result in serious damage.

Mobile Power Connection

(Negative Ground vehicles only)

The DC power cable for mobile installation is supplied with the transceiver. Please review the NOTICE on page 9 before connecting power. The DC cable should be connected directly to the vehicle battery, rather than to the ignition or accessory circuitry. Route the cable as far away from ignition cables as possible, and then cut off any extra cable in order to minimize voltage drop losses.

- (1) Do not connect the cable to the transceiver until after the proper connections are made to the battery; the RED cable lead to the POSITIVE battery terminal, and BLACK lead to the NEGATIVE terminal. Make sure the battery terminal connections are tight, and remember to check them periodically for signs of loosening or corrosion.
- (2) Measure the voltage across the battery terminals with the engine running fast enough to show a charge. If above 15 volts, the automobile voltage regulator must be adjusted to reduce the charging voltage before proceeding.
- (3) Make sure the POWER switch on the transceiver is OFF, and connect the DC cable to the transceiver. The plug pin connections are shown on page 8.

The positive RED wire must include a 20 amp fuse, installed in the supplied cable.

Always check to ensure the POWER switch is OFF before starting the engine.

Mobile Mounting

The optional MMB-38 Mobile Mounting Bracket for the FT-747GX allows quick insertion and removal of the transceiver from the vehicle. Complete instructions are provided with the bracket, which may be installed either above or underneath the transceiver as shown here.

Mobile Installations



Mobile Antenna Installation

Please review the base station antenna information on the previous page. An antenna tuner such as the FC-757AT or FC-1000 is particularly desirable in a mobile station, where the short antenna elements have very narrow bandwidth. Make sure that the shield of the antenna coax is firmly grounded to the car body at the antenna feedpoint.

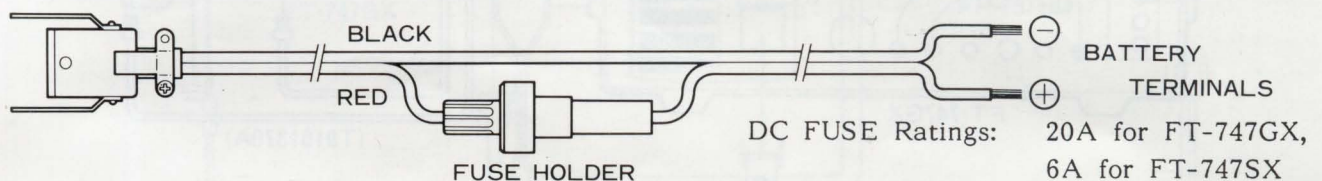

Interconnections

Linear Amplifiers

The FT-747GX includes a high voltage (150V) transistor switch capable of handling up to 1.5 amperes DC, to control transmit/receive switching of a linear amplifier via pin 6 of the BAND DATA jack. However, make certain that the t/r switching requirements of your linear amplifier do not exceed these limits, and that the linear switching voltage is +DC, and not -DC or AC. Yaesu offers the optional FRB-757 Relay Box for t/r switching of linears that require negative or AC switching, or higher voltage or current switching. The FRB-757 installs between the relay jack on the amplifier and the PTT jack on the transceiver, and is capable of switching up to 250V AC or DC, at up to 2.5A.

If you are installing the FT-747GX with the FL-7000 Auto-Tune Linear Amplifier or the FC-757AT Automatic Antenna Tuner, set internal switch S02 to position 1 as described on page 25.

Memory Backup

The memories and vfos of the FT-747GX are retained by an internal lithium cell for five years or longer. The backup circuit is turned on at the factory, so it is not necessary to do anything unless the battery runs down, in which case memories will be lost when the transceiver is turned off and power removed. If this occurs, contact your Yaesu dealer for replacement of the lithium battery.

If you want to clear all memories, or if you plan to store the transceiver for a long time without power connected, disable the backup system by moving the backup switch (indicated on page 22) to its alternate position. If clearing memories, do this with the power disconnected, wait 30 seconds, and then set the switch back ON before restoring power.

INTERCONNECTION DIAGRAMS

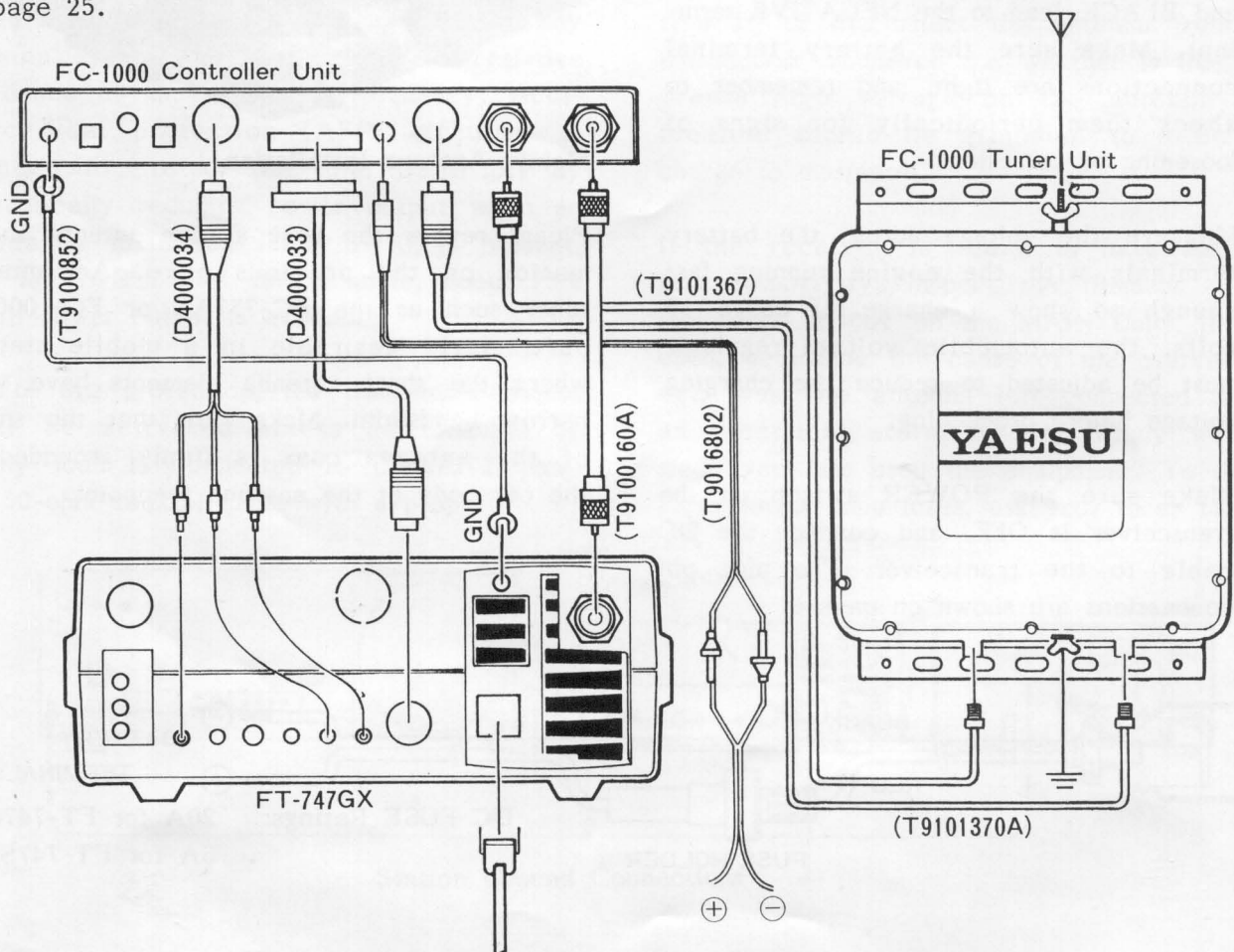

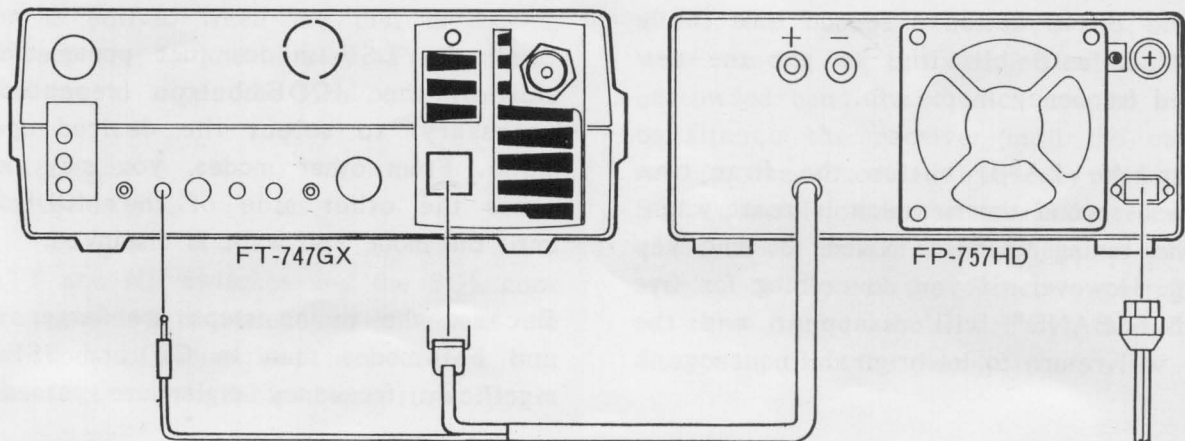
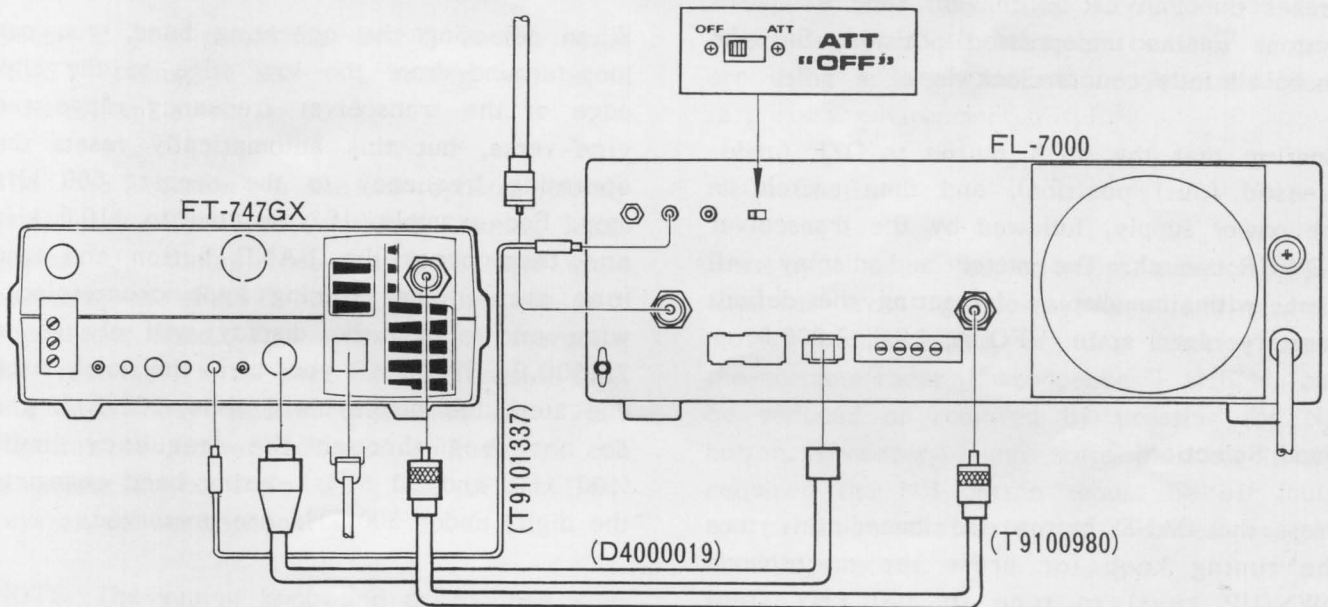
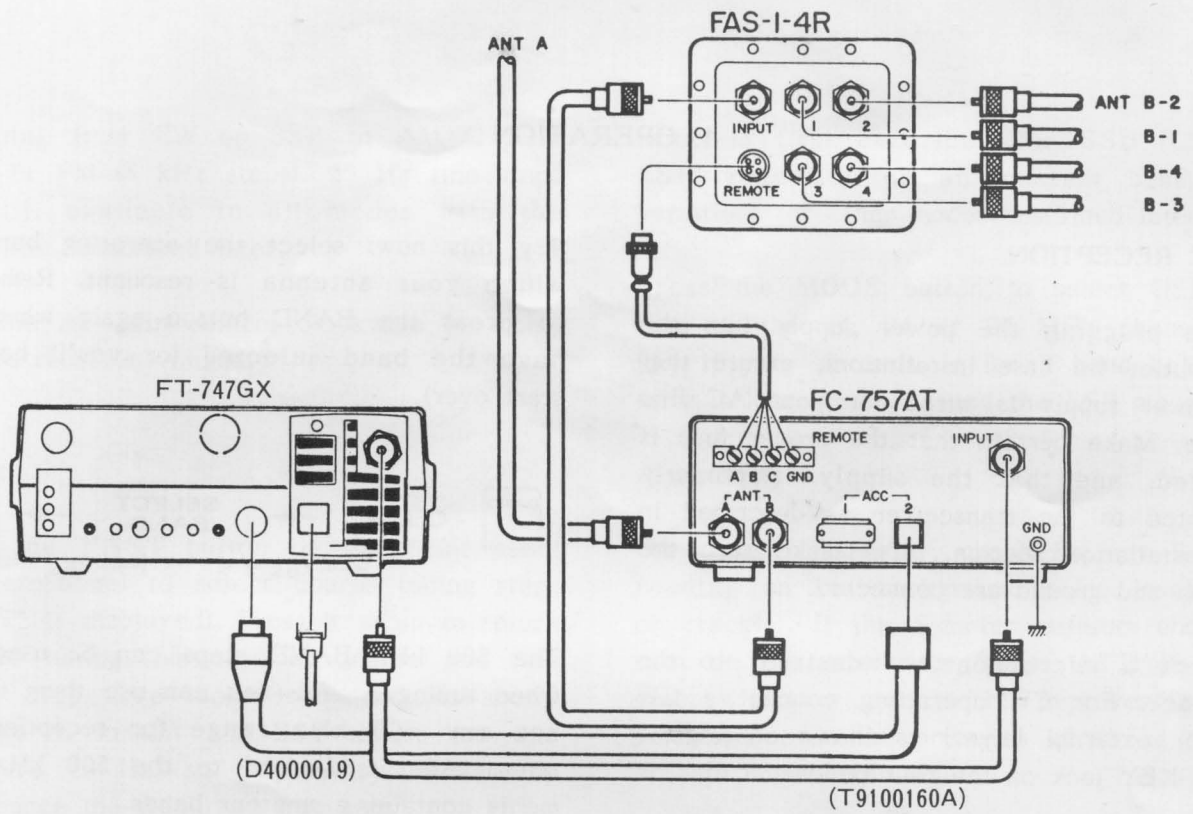

4. OPERATION

BASIC RECEPTION

Before plugging the power supply into the wall outlet (in base installation), ensure that the power supply is wired for your AC line voltage. Make certain that the proper fuse is installed, and that the supply is properly connected to the transceiver as described in the Installation section. Also make sure the antenna and ground are connected.

Connect a microphone, if desired, to the MIC jack. For CW operation, connect a CW key (or external keyer) as shown on page 7 to the KEY jack on the rear panel.

Preset the POWER switch off, and all push-buttons to the undepressed position. Set the knobs all fully counterclockwise.

Confirm that the MOX button is OFF (undepressed (out) position), and then switch on the power supply, followed by the transceiver POWER switch. The meter and display will light, with the display indicating the default (memory clear) state: VFO A, LSB, 7.000.0.

Band Selection

Press the BAND button and immediately turn the tuning knob (or press the microphone DWN/UP keys) to tune in 500 kHz steps ("BAND" appears blinking on the display). Press the BAND button a second time (while "BAND" is still blinking) to set the new displayed frequency in the vfo.

Pressing the BAND button the first time starts a 5-second timer, which is reset whenever the tuning knob is moved (or mic key pressed). However, if you do nothing for five seconds, "BAND" will disappear and the display will return to its original frequency.

Try this now: select the operating band for which your antenna is resonant. Remember to press the BAND button again when you have the band selected (or you'll have to start over).

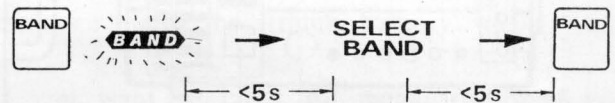

The 500 kHz BAND steps can be used only when tuning a vfo. You can use them to select any 500 kHz range for reception, but transmission is limited to the 500 kHz segments containing amateur bands.

When selecting the operating band, you can loop around from the low edge to the high edge of the transceiver frequency range and vice-versa, but this automatically resets the operating frequency to the nearest 500 kHz step. For example, if you tune to 110.5 kHz and then press the BAND button and tune (one step) lower (tuning knob counterclockwise one click), the display will change to 29.500.0. Then, if you turn the knob back one step, the display will show 500.0. If you do not tune through the frequency limits (100 kHz and 30 MHz) during band changing, the digits under 500 kHz are preserved.

Mode Selection

From the LSB mode, just press the right side of the MODE button (repeatedly, if necessary) to select the desired operating mode. From other modes, you may need to press the other side of the MODE button until the mode you want is displayed.

Because the tuning steps are larger in AM and FM modes than in CW and SSB, least significant frequency digits are zeroed when

switching from CW or SSB to AM (1 kHz steps) or FM (5 kHz steps). 25 Hz fine steps are still available in all modes with the CLARifier, described later.

Turn the AF gain control clockwise for comfortable receiver volume.

Tuning

Press the FAST button on the front panel (or microphone) to select course tuning steps ("FAST" is displayed). Press it again to return to fine tuning. Notice that coarse and fine tuning steps are mode-dependent, as shown on page 5. In CW and SSB modes the fine steps are 25 Hz, so only every fourth step will change the displayed frequency.

Note: if you press the BAND button while "FAST" tuning is selected, tuning will be in 5 MHz giant steps!

The FAST button on the microphone greatly facilitates vfo tuning with the tuning knob: operate the tuning knob with one hand while operating the FAST button on the mic with your other hand. This allows quick searching for activity (with the FAST function on), and then easy fine tuning when the FAST function is turned off. Of course you can also tune up or down using the UP or DWN keys on the microphone.

NOTE: The tuning knob and microphone keys are deactivated when the D LOCK (dial lock) function is active. When the dial is locked, 'LOCK' appears on the display. Press the D LOCK button to toggle the lock on and off.

SSB Reception

The ATT and NB switches and the SQL control are provided to reduce or eliminate the various types of noise and interference that can obstruct comfortable reception. Oper-

ation is first described for SSB (USB or LSB) reception on an amateur band, with variations for other modes described later.

Press the MODE button to select USB and tune to the 14, 21 or 28 MHz phone band (or, if your antenna is for a band below 10 MHz, select that band and the LSB mode).

Attenuator

On a clear frequency, check for any S-meter reading on the background noise level (hiss or crackle). If the S-meter deflects above 3, turn on the attenuator (press ATT: its indicator will glow green). This improves receiver performance in the presence of strong signals or high noise levels.

The attenuator may often be needed on frequencies below 10 MHz, particularly if you are using a large antenna or your station is in a noisy environment (city).

Noise Blanker

Pulse-type noise, either short duration types such as from ignition systems and electric motors and switches, or long duration over-the-horizon radar ("woodpecker") signals, can be reduced or removed by pressing the NB button. However, when noise blanking is not required the NB button should be off (out), to minimize distortion introduced by the blanking process.

Squelch (All Mode)

When waiting for a scheduled call on a fairly uncrowded band the squelch can be activated to silence the receiver until the call. Just tune to the scheduled frequency and turn the SQL control clockwise until the receiver is quiet. Two other things happen when the squelch is closed: the S-meter reading drops to zero (if it wasn't already), and "BUSY" disappears from the display.

Of course using the squelch to wait for a signal to appear only works if the expected signal is strong enough to overcome the squelch threshold set by the SQL control. If the expected signal will be weak, or when operating in modes other than FM and not scanning, the SQL control should be set fully counterclockwise.

Note: Whenever using the squelch feature, make sure to set the ATTenuator switch as described previously before adjusting the SQL control, as the squelch threshold is affected by the ATT setting.

CW Reception

In addition to the ATT, NB and SQL controls described for SSB, the FT-747GX CW NAR (narrow) mode provides a 500 Hz IF crystal filter to enhance reception. Use the CW (wide) mode to tune in the desired signal for about a 700 Hz pitch, and then press the NAR switch.

The CW (wide) mode provides the same IF bandwidth as for SSB, allowing you to hear signals up to about 1 kHz away while tuning around the band. Noise and interference are greater than for CW NAR, but the wider bandwidth makes tuning easier.

Hint: when you make contact with another station on CW, press the CLAR button after he responds to you if you need to retune, then press the D LOCK button to avoid accidental frequency change, and finally the NAR button to select the narrow filter.

AM Reception

The FT-747GX includes a 6 kHz (wide AM) filter for good fidelity during reception of mediumwave and shortwave AM broadcasts. Pressing the NAR switch reduces the band-

width to the same as SSB, but fidelity is reduced.

When interference or noise is severe, ECSS (Exalted Carrier Selectable Sideband) reception may be preferable over the AM mode for receiving AM signals. This special technique allows you to select either the upper or lower sideband of an AM signal using USB or LSB modes; eliminating interference that may be present on the other sideband due to a nearby signal while still getting about twice the audio bandwidth (fidelity) of the AM narrow mode.

To use ECSS, first tune in the station using the AM mode (shortwave broadcasters generally transmit on precise multiples of 5 kHz), and then select either USB or LSB, whichever gives best reception. Now carefully fine tune for zero beat (most natural voice/-music pitch), and push D LOCK so you don't lose the frequency.

Hint: Zero beating an AM signal in ECSS reception requires very precise setting of the tuning knob. Some practice with stronger signals first will make tuning the weak ones easier. Coarse tuning is useless for ECSS.

When receiving AM signals in either AM or ECSS mode, the noise blanker should be off unless it is really needed. Its effectiveness will vary depending on the signal strength of the received signal and those on adjacent channels; being most effective when the signals are weak and noise pulses are strong.

FM Reception

The FT-747GX requires the optional FM Unit (circuit board) for FM operation.

The MIC gain control and noise blanker (NB) switch are disabled for FM operation. However, the ATT and SQL settings are especially important. For weak signal work, set the

SQL control only after you have finished tuning. The FT-747GX FM Unit is designed for ± 2.5 kHz deviation, as is most common in 2-way FM communications.

RTTY and Packet Reception

An external TU (terminal unit) or TNC (terminal node controller) is required for RTTY or packet operation, respectively. Receiver audio is best obtained from the AF OUT jack on the rear panel, as the level of the signal at this jack is not affected by the AF gain control. However, your TU or TNC must be capable of high impedance input (50mVp-p @10 kilohms) to use this signal. Otherwise, low impedance output is available from the EXT SP jack, but this is affected by the AF gain control, and using this jack disables the internal speaker. Select either the LSB or USB mode for operation, and see your TU or TNC manual for further details.

TRANSMITTER OPERATION

The solid state transmitter in the FT-747GX requires no adjustment other than setting the desired output level. The maximum power output is determined by the mode and the capability of the power supply (in AM, FM and RTTY, power should be restricted to avoid overheating the power supply if you plan to make long transmissions). Also, there are certain precautions to be observed at all times when transmitting to avoid possible damage to the transceiver, and to assure a clean signal.

Never transmit without having a dummy load or antenna tuned to the operating frequency connected to the transceiver (or linear amplifier, if used). If you have doubts about the suitability of your antenna on a certain frequency, check the SWR (Standing Wave Ratio) first using an external SWR meter. The transmitter includes protection circuits

that reduce the output power if SWR is high. For example, with an SWR of 3:1 only about 75% of full power is available, but very high SWRs can cause poor performance due to feedline radiation and RF feedback in the shack. If using the FC-757AT Automatic Antenna Tuner or FL-7000 Linear Amplifier, SWR is calculated and displayed automatically. See the Tuner or Amplifier manual for complete details. Otherwise, use an external SWR meter such as the Yaesu YS-60, connected between the transceiver and antenna feedline.

Avoid changing frequency during transmission. First return to receive, then do your tuning, and remember to listen for at least a minute or two to make sure the new frequency is not already occupied; or ask if the frequency is occupied and then listen for a response.

When using a light- or medium duty power supply such as the FP-700, do not attempt to transmit FM, AM or RTTY at full output power. Although the transceiver is capable of this, some power supplies are not, and they may rapidly overheat and be seriously damaged. In any mode, feel the supply occasionally and reduce power or stop transmitting for a while if it feels hot.

Never start transmitting (except into a dummy load) without first listening for a few minutes to make sure the frequency is clear, and then transmit your callsign. This prevents accidental interference to other stations.

SSB Transmission

With a microphone connected to the MIC jack on the front panel, preset the MIC gain control to 12 o'clock, tune to a valid transmitting frequency (in the amateur bands), and select the LSB mode (on bands below 10 MHz) or the USB mode.

To activate the transmitter, close the PTT switch on the microphone, and adjust the

MIC gain control while speaking into the microphone so that the meter deflects up to about 6 on the PO scale on voice peaks. This will result in full power output; reduce the MIC gain to reduce power.

Clarifier (Receiver Offset)

The CLAR button can be pressed while receiving to allow independent tuning of the receiver (in 25 Hz steps) without affecting the transmit frequency (CLAR is displayed to the left of the operating frequency). This feature is useful if, after making contact with another station, his transmitter drifts; you can retune his signal without changing your own transmitting frequency.

While the clarifier is on tuning affects only the receiver: the transmitting frequency remains the same as before the clarifier was activated, and is displayed when transmitting.

The FT-747GX incorporates a special 'clarifier memory', which allows you to listen on the transmit frequency by switching off the clarifier. As long as you don't touch the tuning knob, pressing CLAR again returns you to the same (offset) receive frequency. When the contact is finished, remember to switch off the clarifier.

CW Transmission

The FT-747GX offers semi break-in operation for both simplex and split-frequency operation. Connect your key or external electronic keyer to the KEY jack on the rear panel, and select the CW mode. Close the key to activate the transmitter, and adjust the DRIVE control for the power output desired (100W output = "8" on the PO meter scale). After making contact with another station, reduce power with the DRIVE control as much as possible without losing contact.

You should be able to hear the sidetone from the loudspeaker (or headphones) when you close the key. The sidetone volume control (inside the hole near the rear of the bottom cover) can be adjusted for comfortable sidetone volume.

To practice sending CW, just set the DRIVE control fully counterclockwise. Now, closing the key will generate the sidetone but no signal will be transmitted.

If you need to change the delay time between release of your key and receiver reactivation, adjust VR1013 inside the top cover at the location shown below.

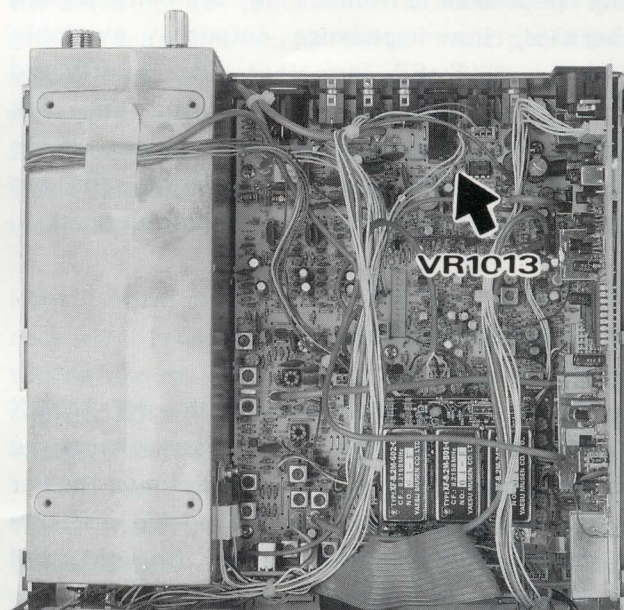

FM Transmission (requires optional Unit)

For FM transmission, just select the FM mode and close the PTT switch to transmit. The MIC gain control is disabled for FM, as the gain of the microphone amplifier is preset internally for ± 2.5 kHz deviation, and requires no further adjustment. RF power output is adjusted by the DRIVE control. For full power output (using the FP-757HD power supply), adjust the DRIVE so that the meter deflects to "8" on the PO scale. When contact is established, reduce the DRIVE.

CAUTION

When the FT-747GX is used with the FP-757HD power supply, full power FM, AM or RTTY transmissions must be limited to 30 minutes maximum.

When the FP-700 or other light-duty supply is used, transmitter power in the above modes must be limited to half ("4" on the PO scale) at all times, to avoid overheating and subsequent damage to the supply.

Regardless of the power source or mode, we recommend reducing power from the maximum levels mentioned above whenever transmitting for more than 10 minutes, or if the ambient air temperature is very hot or the power supply feels hot.

AM Transmission

Because carrier power is only one fourth of the total PEP of an AM signal, it must be limited to 25 watts or less ("4" on the PO scale) when transmitting with the FT-747GX. When the power of the modulating sidebands is added to the carrier power, actual PEP output is 100 watts, although this does not show on the meter.

To adjust the FT-747GX for AM transmission;

- (1) Preset the MIC gain fully counterclockwise.
- (2) Make sure the frequency is clear, and then close the PTT switch on the microphone and advance the DRIVE for a meter deflection of "4" on the PO scale.
- (3) Speak into the microphone and advance the MIC gain control until slight movement of the meter occurs on voice peaks. PEP output is now 100 watts. Do not

advance the MIC gain further, or over-modulation (and distortion) may result.

- (4) Use the DRIVE control to reduce power once contact has been established.

Unless using a heavy duty power supply, keep transmissions short, and stop transmitting if the power supply becomes hot.

RTTY, HF Packet & SSTV Transmission

Transmission of narrowband FSK (RTTY, SSTV and Bell 103 HF packet) requires input of equal level audio tones (AFSK) at pin 8 of the MIC jack. Select LSB or USB mode.

The PTT jack on the rear panel may be used for external transmit/receive control. Of course manual transmit/receive control is also possible with the MOX button.

Note that the displayed frequency is the (suppressed) carrier frequency, so your actual transmitted MARK and SPACE frequencies will be displaced from the display by the audio frequencies of the input tones.

Use the MIC gain control to adjust power output: "8" on the PO scale indicates full power. Reduce output by turning the MIC gain counterclockwise while observing the PO meter or on an external wattmeter.

As mentioned previously, the FT-747GX is capable of full power AFSK for limited periods when used with a heavy duty power supply. Restrict transmissions to 30 minutes with the FP-757HD. If using the FP-700, restrict power output to "4" on the PO scale. If the air temperature is high or at high altitudes, cooling efficiency is decreased and so power output should be reduced accordingly. Also, it is a good practice to back off on the power whenever making a long transmission, and even then supply temperature should be closely monitored.

After transmitting, if the cooling fan is on, don't turn the POWER switch off until the set has had a few minutes to cool and the fan to switch off.

MEMORY OPERATION

Twenty memory channels, numbered 00 through 19, are available for storing frequencies and modes after selection on the vfos. The two vfos, denoted VFO A and VFO B, each hold frequency and mode independently, so there are actually 22 memories altogether.

VFO A/B Selection

The current operating vfo is indicated by "VFO A" or "VFO B" displayed to the left of the frequency. To select the alternate vfo, press the left (VFO) side of the VFO/MR button while receiving on a vfo. The frequency and mode of the other vfo are retained until selected again (in the same way).

VFO/Memory Selection

The memory number is always indicated on the display to the right of the operating frequency. While receiving on a vfo, press the right (MR) side of the VFO/MR button to select operation on the displayed memory: "MR" is displayed to the left of the operating frequency during memory operation.

To return to vfo operation from a memory, just press the "VFO" side of the VFO/MR button: once for the last-used vfo, and again for the alternate vfo.

Memory Storage

This procedure allows storage of the vfo mode and frequency into a memory channel;

- (1) Set the vfo to the frequency and mode of emission to be stored.
- (2) Press the MR side of the VFO/MR button to switch to memory operation.
- (3) Press the microphone DWN/UP keys or turn the tuning knob to select an unused memory channel (default data is 10.000 MHz LSB in all channels), or one you are willing to overwrite.
- (4) Press the VFO side of the VFO/MR button to return to the vfo.
- (5) Press the VFO-M button to write the data from the vfo to the memory (operation remains on the vfo).

Note that the VFO-M key overwrites (erases!) the previous memory contents. Steps (2), (3) and (4) are required only to select the memory channel that is to be written. If you already know that the selected memory is free to accept new data, these steps can be skipped.

Memory Recall

- (1) Press the right side of the VFO/MR button to recall memories: the display and mode indicators will change to the displayed memory's data.
- (2) While watching the memory number, (beneath "CH" at the right side of the display), press the DWN and UP keys on the microphone or turn the tuning knob to select different memories.

The mode of a recalled memory may be changed temporarily by the MODE keys. When another memory or a vfo is selected, the temporary mode selection is cancelled (but see the next procedure).

Changing Memory Mode & Frequency

To permanently change the data stored in a memory it is necessary to shift the data to a vfo where it can be manipulated. The following procedure assumes that you begin operating on the memory you want to change.

- (1) Press the VFO side of the VFO/MR button, twice if necessary, to select the vfo you want to use. Note that its contents will be lost!
- (2) Press M>VFO to copy the memory data into the selected vfo.
- (3) Retune or change mode as desired.
- (4) Press VFO>M to restore the displayed vfo data back into the memory.

Notice that operation is left on the vfo, but you can press the MR side of the VFO/MR button to return to the (changed) memory.

Split Frequency Operation

The two vfos and the SPLIT key can be used to set up split frequency operation, which can then be stored in any memory (except memories 18 and 19) in the normal fashion.

- (1) Press the VFO side of the VFO/MR button, as necessary, to select VFO B (displayed at the left).
- (2) Tune to the desired transmit frequency (and mode, if different from receive).
- (3) Press the VFO side of VFO/MR again to select VFO A, and tune to the desired receive frequency and mode.
- (4) Press SPLIT.

Now receiving is on VFO A, but when the PTT switch or key is closed, transmission is

on VFO B. To reverse transmit and receive frequencies (for example, to listen on the transmit frequency), just select the alternate VFO while receiving.

Once the vfos are set for split operation, you can store the complete split in a memory by following the Memory Storage procedure. However, note that if you press M>VFO to recall the split memory into the vfo, both vfos (A and B) will be overwritten.

SCANNING

When the squelch is adjusted to silence the receiver, some or all of the memories can be scanned automatically. Signals that are strong enough to open the squelch will cause scanner to pause for five seconds.

The ATT switch should be set for the desired sensitivity before adjusting the squelch, as it affects squelch sensitivity.

The DWN and UP buttons on the microphone are used to activate and deactivate the scanner. A small arrowhead appears on the display just beneath the memory number to indicate scanning direction.

To scan the memories:

- (1) Set the SQL control to the point where background noise is just silenced.
- (2) Press the MR side of the VFO/MR button, if necessary, to recall the memories.
- (3) Press the DWN or UP button on the microphone to start the scanner: "SCAN" is displayed blinking.

Scanning will pause for five seconds on any channel having a signal strong enough to open the squelch, and will resume again if the signal drops out. If you notice that the

scanner is skipping some memories, see the next section: Selective Memory Scanning.

To stop scanning press the microphone DWN or UP buttons or the PTT switch momentarily.

Selective Memory Scanning

When not scanning you can select memories individual to be skipped by the scanner. Normally, when a memory is scannable (but the scanner is not activated), "SCAN" will appear on the display when that memory is recalled and the squelch is closed. To cause it to be skipped, just press the VFO•M key once. "SCAN" will disappear, and the memory will be skipped when you next start the scanner.

To re-enable scanning of a memory, just recall it, close the squelch, and press VFO•M once again (so "SCAN" is displayed).

PRIORITY CHANNEL MONITORING

Priority Monitoring allows you to tune and operate on a vfo while the receiver periodically checks a memory for a signal.

Before activating Priority Monitoring store the frequency (and mode) you want to check periodically in a memory, and adjust the squelch so that it is just closed. Then press the VFO side of the VFO/MR button to move to the vfo.

Press the PRI-M button. "PRI" appears just above the memory number, and you may now operate on the vfo as normal (even for transmitting). While you are receiving, every four seconds the display will jump to the memory to check briefly for activity.

If a signal appears on the memory frequency (strong enough to open the squelch), the receiver will stick on the memory for five seconds, during which you can press the PTT switch on the microphone momentarily (the transmitter will not be activated) to cancel priority monitoring and stay on the memory.

Note: While operating on the vfo, be careful not to press the PTT while the receiver is checking the memory unless you want to shift operation to the memory.

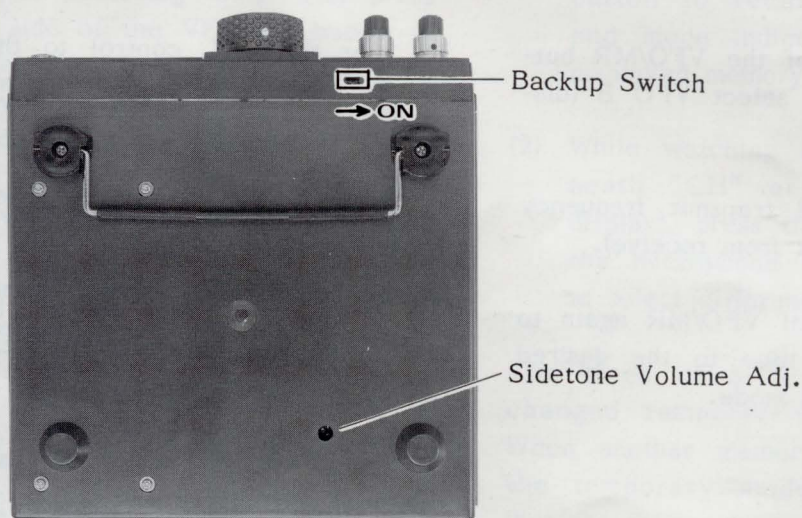

Controls Accessible Through Bottom Cover

5. MODIFICATIONS & OPTIONS

Top Cover Removal

The top cover of the FT-747GX must be removed as described here to install the modifications and internal options described afterwards.

- (1) Switch off the transceiver and disconnect all cables from the rear panel.
- (2) Referring to Figure 1 below, use a sharp instrument (such as a small screwdriver) to depress the catch pin in the strip on the side of the set (near the rear), while sliding the strip towards the rear with

your other hand. Do this on each side to remove both strips.

- (3) With the transceiver facing away from you, grasp the top panel with both hands near the front as shown in Figure 2. There are clips at positions (1) which can move only vertically, and a clip at (2) which can move only horizontally. Lift up on both sides to unlatch the clips at points (1) while holding the center clip (2) in the same position, and slide the top panel back about 2 centimeters ($\frac{1}{2}$ -inch) until the clips clear the top edge of the front panel.

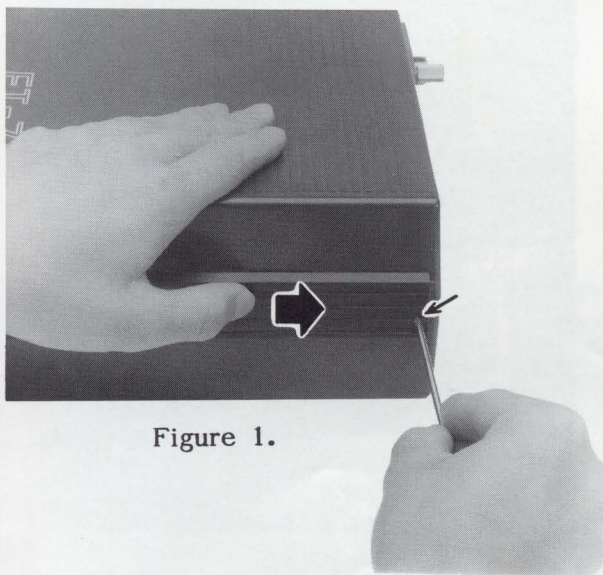

Figure 1.

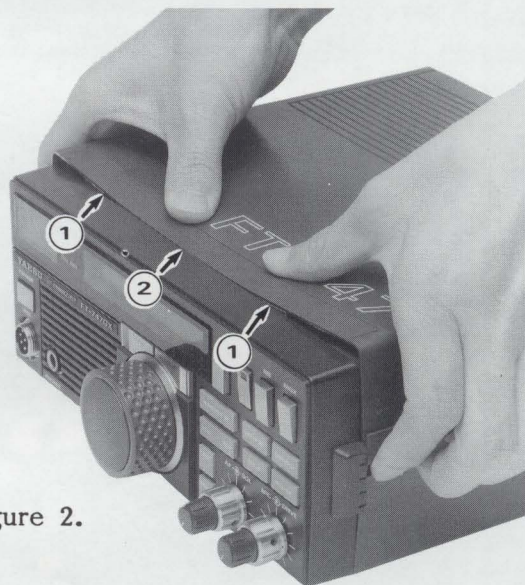
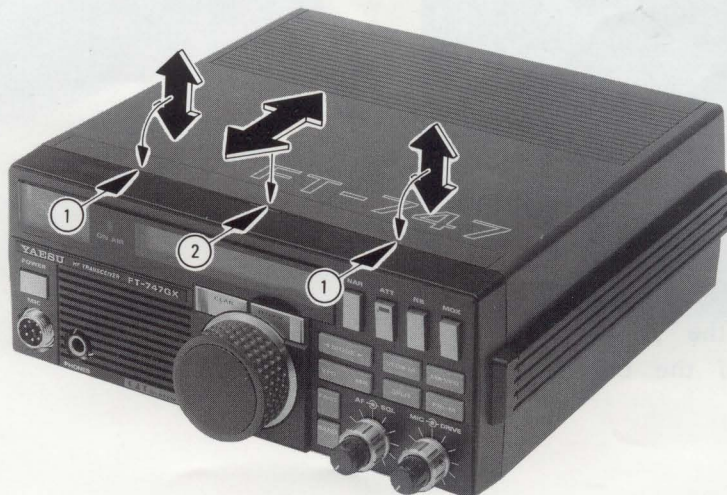
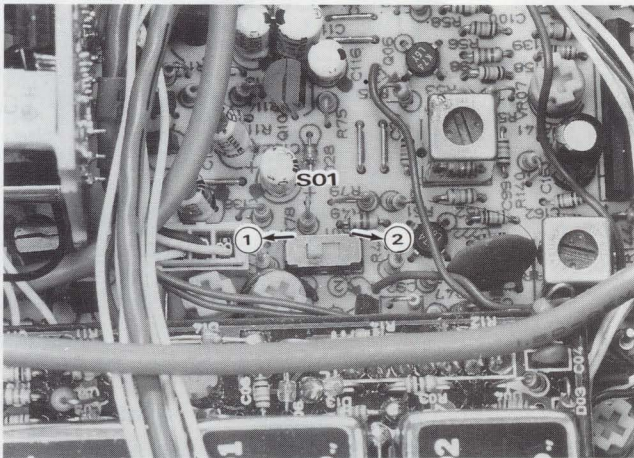

Figure 2.



AGC Time Constant Selection

As supplied from the factory, the AGC (automatic gain control voltage for the receiver) is set for slow decay in SSB and AM modes, and fast decay in CW and FM. If desired, you can change this for slow decay in all modes, by moving switch S01 from position 1 to position 2, as shown below.



Optional FM Unit Installation

The optional FM Unit can be installed in the 11-pin jack shown in the photo above, with the component side of the board facing to the left.

Tx Control for FC-757AT & FL-7000

When the FT-747GX is installed with the FC-757AT Automatic Antenna Tuner or the FL-7000 Automatic Linear Amplifier, the external device needs to be able to inhibit transmission by the FT-747GX during band changing, and to control receive-to-transmit switching time. This can be done by setting switch S02 to position (1) as shown in the diagram below. However, when used without the FC-757AT or FL-7000, this switch MUST be in position (2) to enable transmission.

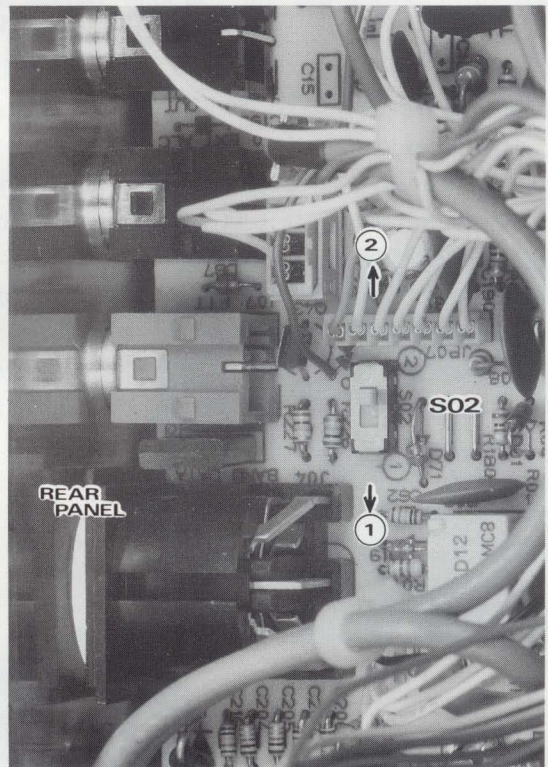

Optional TCXO Installation

Optimum stability can be obtained with the FT-747GX by installing the TCXO (Temperature Compensated Crystal Oscillator) in place of PLL reference crystal X1004 on the Local Unit.

- (1) Referring to Figure 1, slide the Local Unit upwards to remove it from the Main Unit and provide free access to both sides of the board.

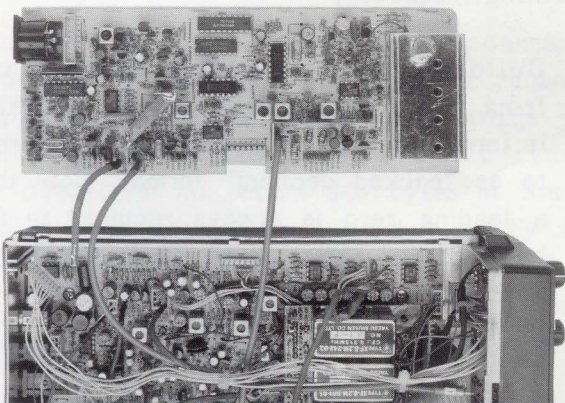

Figure 1

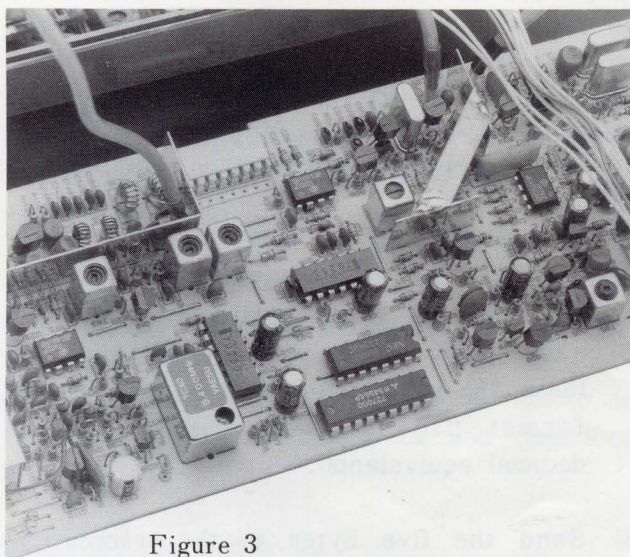

Figure 3

- (2) Unsolder and remove trimmer TC1004, crystal X1004 and capacitors C1104 and C1105 (Figure 2). Use a vacuum solder remover or solder wick to clean away solder from around the holes under the TXCO mounting location.
- (3) Install the TXCO Unit as shown in Figure 3, and solder the TCXO case at points A (2 places), and the TCXO leads at B (3 places). Then trim the leads, and reinstall the Local Unit.

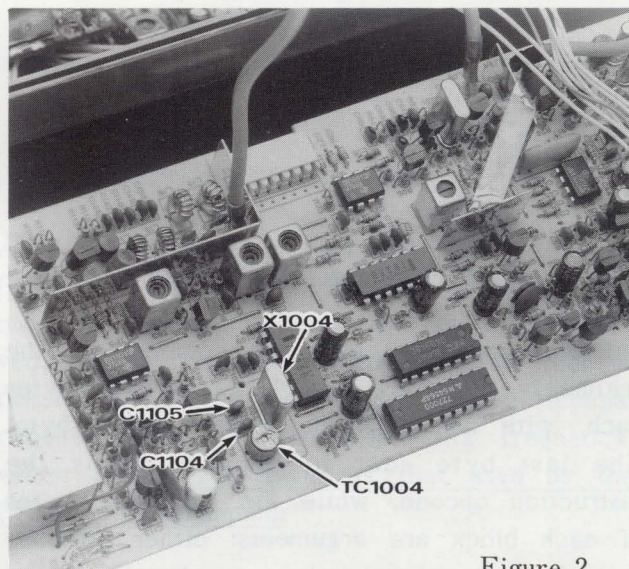
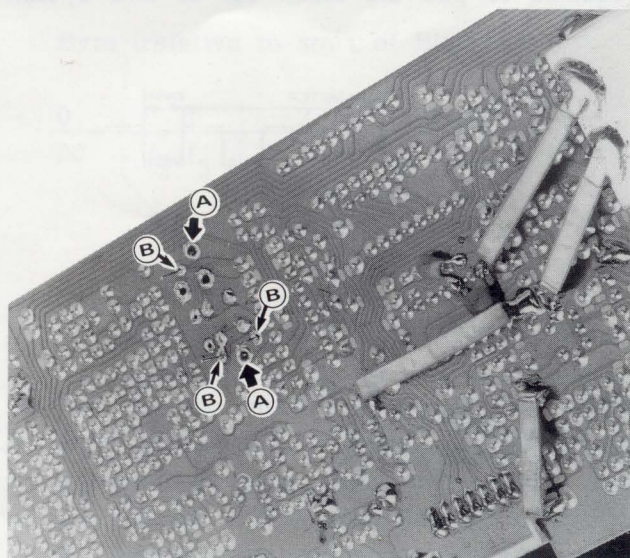

Figure 2



6. CAT SYSTEM COMPUTER CONTROL

The CAT (Computer Aided Transceiver) System in the FT-747GX allows control of frequency, mode, memory and other settings by the operator's external personal computer.

Serial data is passed at TTL levels (0 and 5V) via SO (serial output) and SI (serial input) pins 2 and 3 of the CAT jack on the rear panel of the transceiver at 4800 bits/sec (CAT jack pinout is shown on page 8). Each byte sent consists of one start bit, 8 data bits (no parity bit) and two stop bits:

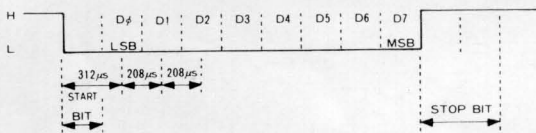

Data Format for 1 Character

All commands sent from the computer to the transceiver consist of blocks of five bytes each, with 50 to 200ms between each byte. The last byte sent in each block is the instruction opcode, while the first four bytes of each block are arguments: either parameters for that instruction, or dummy values (required to pad the block out to five bytes):

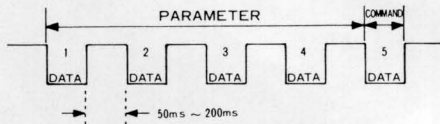

Data Format for 1 Block (5 Characters)

There are fourteen instruction opcodes for the FT-747GX, listed in the upper table on page 29. Notice that several instructions (UP500K, DN500K and UPDATE) require no parameters. However, every Command Block sent to the 767 must always consist of five bytes.

The CAT control program in the computer must construct the 5-byte block, organizing the parameters, if any, and providing unused (dummy) argument bytes for padding. These will be ignored when such instructions are executed, so they need not be zeroed. The instruction opcode is then placed at the end of the block, and all five bytes are sent to the SI serial input pin of the CAT jack on the transceiver.

EXAMPLE: Set 14.25000 MHz as the current operating frequency;

- Build the four argument byte values from the desired frequency by breaking it into 2-digit blocks: technically referred to as "packed decimal" format. Note that a leading zero is always required in the hundreds-of-MHz place (and another in the ten's-of-MHz if below 10 MHz).

0 1 4 2 5 0 0 0

Step (1) 01 42 50 00

Step (2) 00h 05h 42h 01h 0Ah
 LSD MSD FREQ_SET
 Frequency Parm's Opcode

- Now REVERSE the order of these bytes, and add the appropriate instruction byte on the end. The small "h" following each byte value indicate hexadecimal (base 16) values (which in packed decimal format use the same digits as their decimal equivalents).

- Send the five bytes to the transceiver, LSD (least significant digit) first (left-to-right as above).

Notice that there is space for a ten's-of-Hz digit in the frequency parameters, although



is 25 Hz, so ten's-of-Hz digits are converted (in the transceiver) as follows when the command is executed.

Ten's-of-Hz Conversion to 25 Hz Steps:

CAT Parameter for 10's of Hz									
0	1	2	3	4	5	6	7	8	9
00		25			50			75	
Resulting Freq. (ten's & one's of Hz)									

Reading Transceiver Status

The UPDATE and the PACING commands allow the computer to obtain, upon request, a report of various transceiver settings via the SO (Serial Output) line. UPDATE causes the transceiver to return 345 bytes of Status Update data, with each byte delayed by the interval selected by the PACING command (0 to 1,275ms in 5ms steps). This delay is initially zero until the PACING command is sent.

The PACING command allows Status Update data to be read and processed by even very slow computers. However, the pacing delay should always be selected to be as fast as your computer will accommodate, to minimize the inconvenience of the delay. Sending 345 bytes requires 790ms with "0"-length delay selected, but over 7 minutes if the maximum delay is selected!.

Status Update Data Organization

Status Update Data is mapped as shown in the lower table on page 29 and described below.

(1) Status Flags (1 byte)

The first byte of the Status Update data is the Status Flag Byte for the current display. Seven bits of this byte are used as flags to indicate the on/off status of the seven ele-

ments that appear at the left side of the transceiver display, as follows:

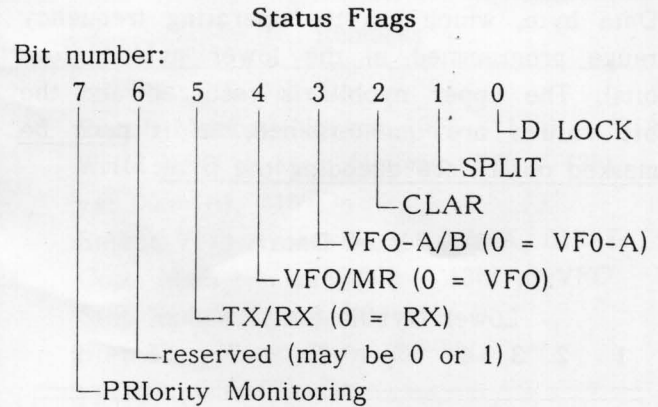

(unless otherwise indicated, 0=off, 1=on.)

(2) Frequency Block (5 bytes)

After the Status Flags byte is a 5-byte Frequency Block used for the operating frequency. The first byte of this block is reserved, and returns zero (00h). The last four of these bytes hold an 8-digit packed decimal representation of the operating frequency, which is not the same as that used by the FREQ SET command:

Frequency Block

Byte (relative to start of Block)

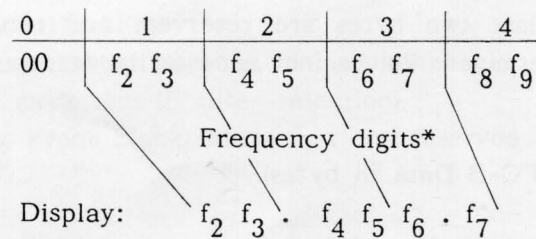

f₈f₉ = 00, 25, 50 or 75 Hz (not displayed)

* Compare this with the parameters of the FREQ SET command:

Parameter Byte			
1	2	3	4
f ₇ f ₈	f ₅ f ₆	f ₃ f ₄	0 f ₂

(3) Band Data (1 byte)

Following the Frequency Block is the Band Data byte, which has the operating frequency range programmed in the lower nybble (four bits). The upper nybble is reserved and the bit values are undetermined, so it must be masked out before decoding the byte:

Band Data

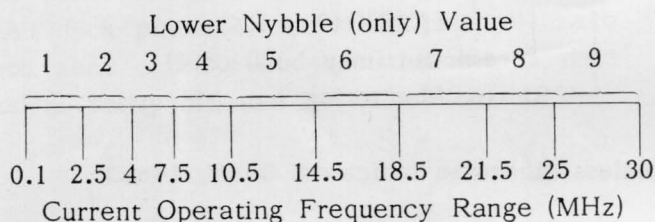

(4) VFO-A (8 bytes)

After the Band Data are eight bytes holding the current data for VFO-A. The first byte is a Status Flags Byte, with the same format as already described for the current display. If currently operating on VFO-A, this byte is the same as the first Status Flags Byte (first byte of the Status Update data).

The next five bytes are the Frequency Block for VFO-A, with the same format as already described in item (1) above.

The last two bytes are reserved, and return indeterminate values (not necessarily zeros).

(5) VFO-B Data (8 bytes)

Following the VFO-A data are eight bytes holding the data for VFO-B, which has the same format as just described for VFO-A.

(6) Displayed Memory Number (1 byte)

The byte following the VFO-B data is the binary value of the currently displayed mem-

ory number (00 to 13h). Note that this is not packed decimal format.

(7) Current Mode (1 byte)

The next byte has six bits used as a mode bit map, with one or (at most) two bits set to indicate the current (displayed) mode, as follows:

Mode Bit Map

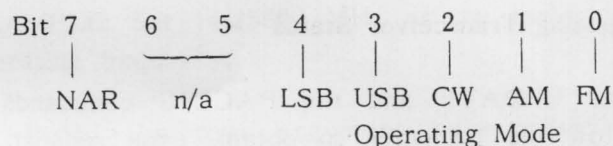

NAR = Narrow IF filter (may be set along with bits 0, 1 or 2).

n/a = Not Assigned. Value undetermined.

(8) Memory Data (8 bytes x 38)

The next 304 bytes of the Status Update Data consists of thirty-eight 8-byte structures:

Memory Data Structure

- 1-byte Status Flags,
- 5-byte Frequency Block,
- 1-byte Mode Bit Map,
- 1-byte reserved (value undetermined)

Each component in this structure has the same format as already described (items (1), (2) or (7) above). The first twenty structures represent receiver (or simplex) data for memories 00 through 19. The remaining 18 structures represent transmit data for any of memories 00 through 17 that were stored for split operation. Note, however, that if split operation was not stored, the data in the corresponding structure is indeterminate.

(9) The last sixteen bytes of the Status Update data are reserved, and undefined.

INSTRUCTION OPCODES

("xx" indicates padding: any value is acceptable)

Instruction Name	Parameters				Instr. Opcode(Hex)	Remarks
	LSD			MSD		
SPLIT	xx	xx	xx	yy	01h	yy: 00h=Off, 01h=On
MEMORY	xx	xx	xx	mm	02h	Recall Memory No. mm (00h - 13h)
VFO_TO_M	xx	xx	xx	mm	03h	Write VFO to Mem No. mm (00h - 13h)
DLOCK	xx	xx	xx	yy	04h	yy: 00h=Off, 01h=On
A_BVFO	xx	xx	xx	yy	05h	Select VFO-A or -B. yy: 00h=A, 01h=B
M_TO_VFO	xx	xx	xx	mm	06h	Copy Mem No. mm (00h - 13h) to VFO
UP500K	xx	xx	xx	xx	07h	Step Frequency up 500 kHz
DN500K	xx	xx	xx	xx	08h	Step Frequency down 500 kHz
CLAR	xx	xx	xx	yy	09h	yy: 00h=Off, 01h=On
FREQ_SET	f ₇ f ₈	f ₅ f ₆	f ₃ f ₄	0f ₂	0Ah	f ₂ -f ₈ = seven packed decimal digits*
MODE_SET	xx	xx	xx	zz	0Ch	zz: 00h=LSB, 01h=USB, 02h=CWW, 03h=CWN, 04h=AMW, 05h=AMN, 06h=FMW, 07h=FMN
PACING	xx	xx	xx	pp	0Eh	pp: 00-FFh (Delay Update pp x 5ms/byte)
PTT	xx	xx	xx	yy	0Fh	yy: 00h=Receive, 01h=Transmit
UPDATE	xx	xx	xx	xx	10h	Return Status (345 bytes) on SO line

* see examples in the text

STATUS UPDATE MAP

Location		Text Ref.	Data Description
Decimal	Hex		
0	00h	(1)	Displayed Status Flags (bit-mapped toggle indicators)
1-5	01h-05h	(2)	Displayed Freq. Block (8 packed decimal digits w/two leading zeros)
6	06h	(3)	Current Band Data (one bit set to indicate selected band)
7	07h	(4)	VFO-A Status Flags (same format as Displayed Status Flags)
8-12	08h-0Ch	(4)	VFO-A Frequency Block (same format as Displayed Freq. Block)
13-14	0Dh-0Eh	(4)	reserved (undefined)
15-20	0Fh-16h	(5)	VFO-B (same format as bytes 07h-0Eh)
21	17h	(6)	Displayed Memory No. (binary number between 00 and 13h)
22	18h	(7)	Displayed Mode (bit-mapped mode and IF filter selection)
23-32	19h-20h	(8)	Memory 00 Rx Status Flags, Freq. Block, Mode and one reserved byte
33-40	21h-28h	(8)	Memory 01 Rx " " " " " " " " " " "
.	.	.	.
177-184	B1h-B8h	(8)	Memory 19 Rx Status Flags, Freq. Block, Mode and one reserved byte
185-192	B9h-C0h	(8)	Memory 00 Tx Status Flags, Freq. Block, Mode and one reserved byte
193-200	C1h-C8h	(8)	Memory 01 Tx " " " " " " " " " " "
.	.	.	.
321-328	141h-148h	(8)	Memory 17 Tx Status Flags, Freq. Block, Mode and one reserved byte
329-344	149h-158h	(9)	reserved (undefined)

100W PA UNIT F2947000 (No.5xxxx)

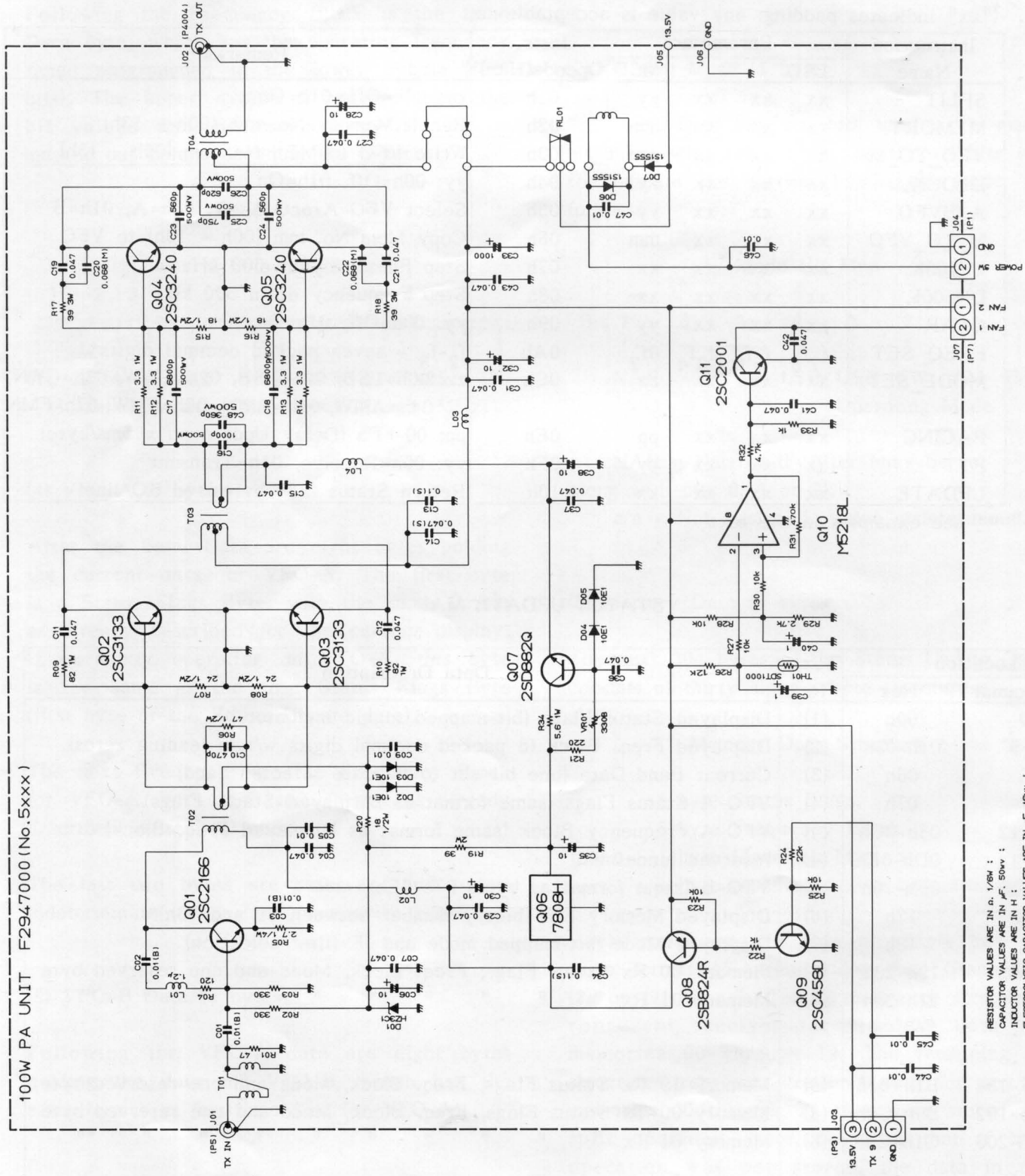

RESISTOR VALUES ARE IN Ω , 1/8W ;
 CAPACITOR VALUES ARE IN μ F, 50V ;
 INDUCTOR VALUES ARE IN H ;
 ELECTROLYTIC CAPACITOR VALUES ARE IN μ F, 16V ;
 UNLESS OTHERWISE NOTED,
 (M) CAPACITORS ARE POLYESTER FILM 50V,
 (S) CAPACITORS ARE SEMICONDUCTOR CERAMIC 25V.

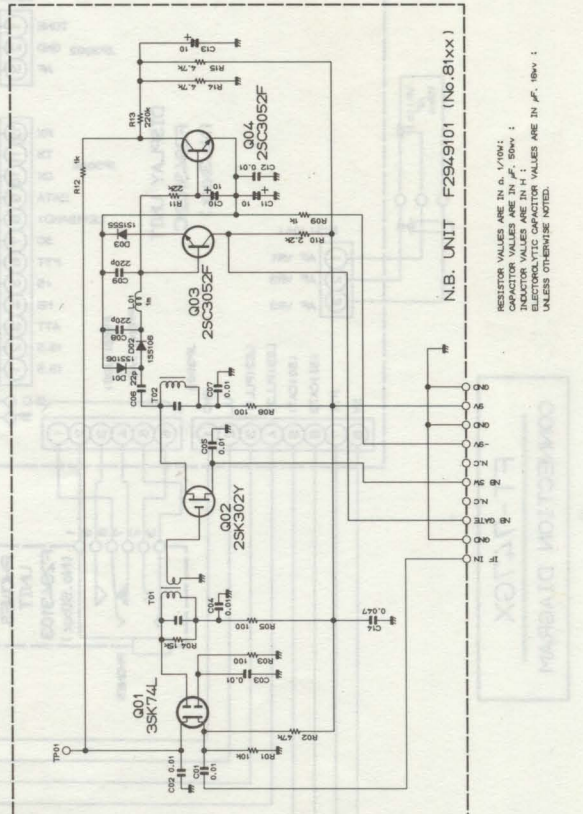
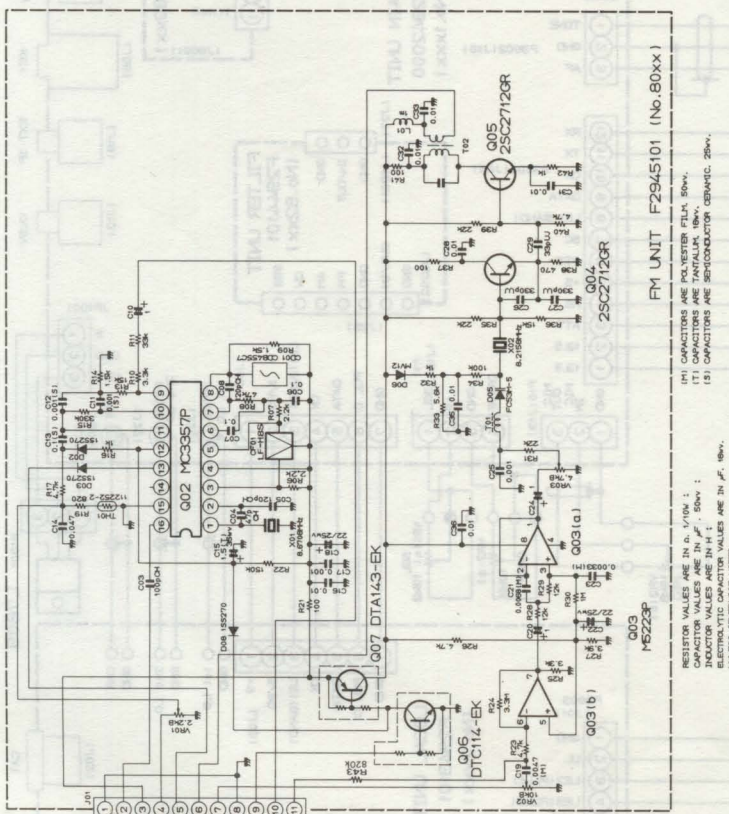
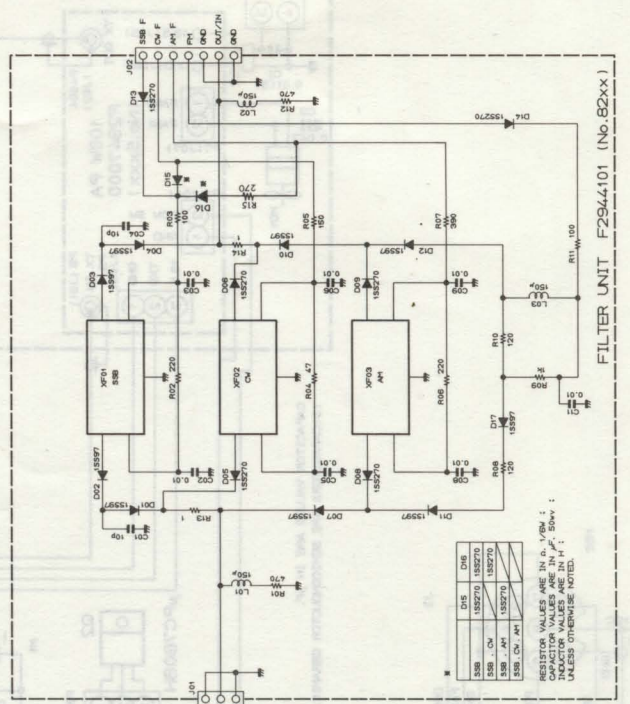
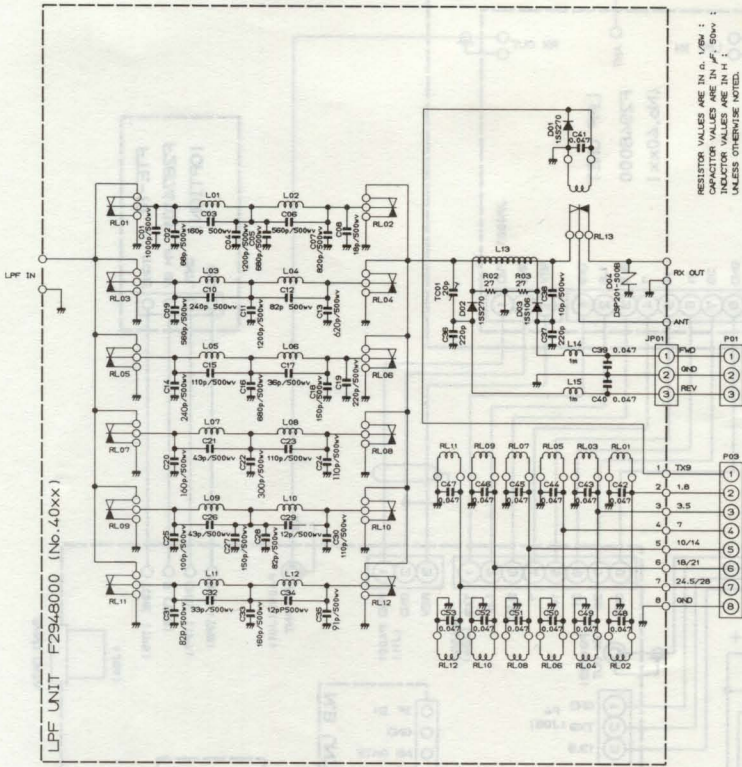

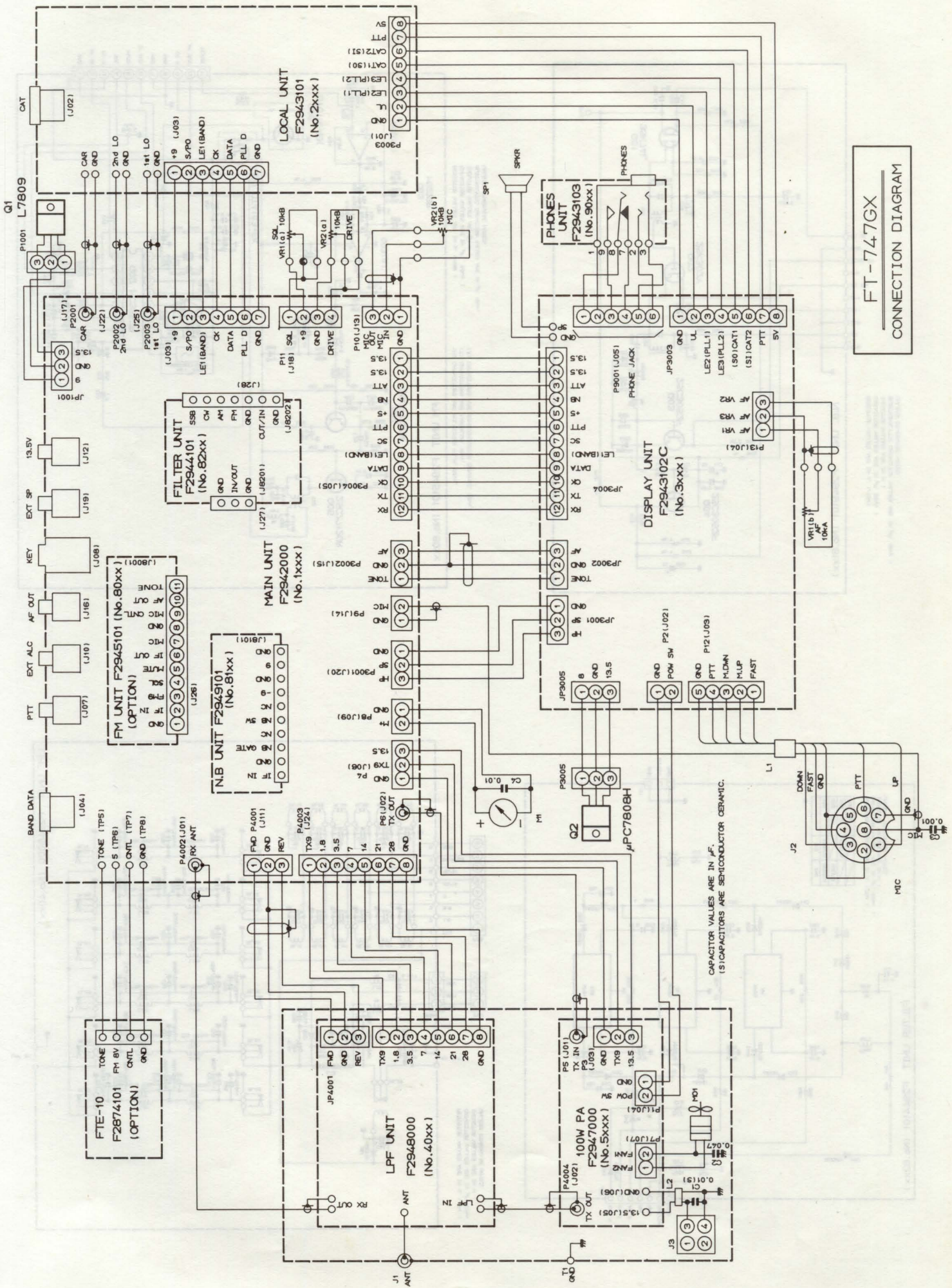

FT-747GX
CONNECTION DIAGRAM

CAPACITOR VALUES ARE IN μ F.
IS: CAPACITORS ARE SEMICONDUCTOR CERAMIC.

LOCAL UNIT F2943101 (No. 2xxxx)

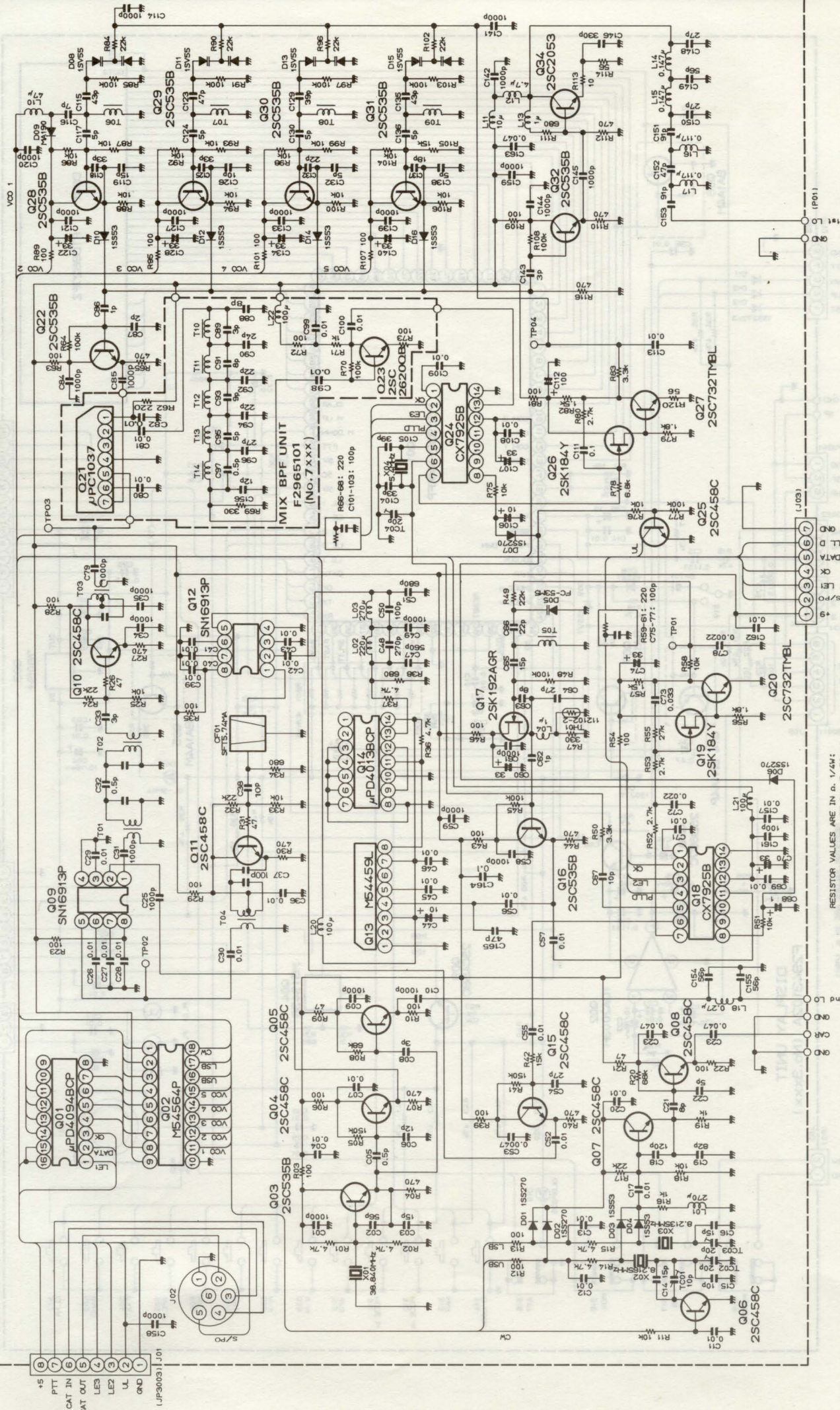

RESISTOR VALUES ARE IN Ω , 1/4W;
 CAPACITOR VALUES ARE IN μ F, 50V;
 INDUCTOR VALUES ARE IN H;
 ELECTROLYTIC CAPACITOR VALUES ARE IN μ F, 16V.

UNLESS OTHERWISE NOTED.

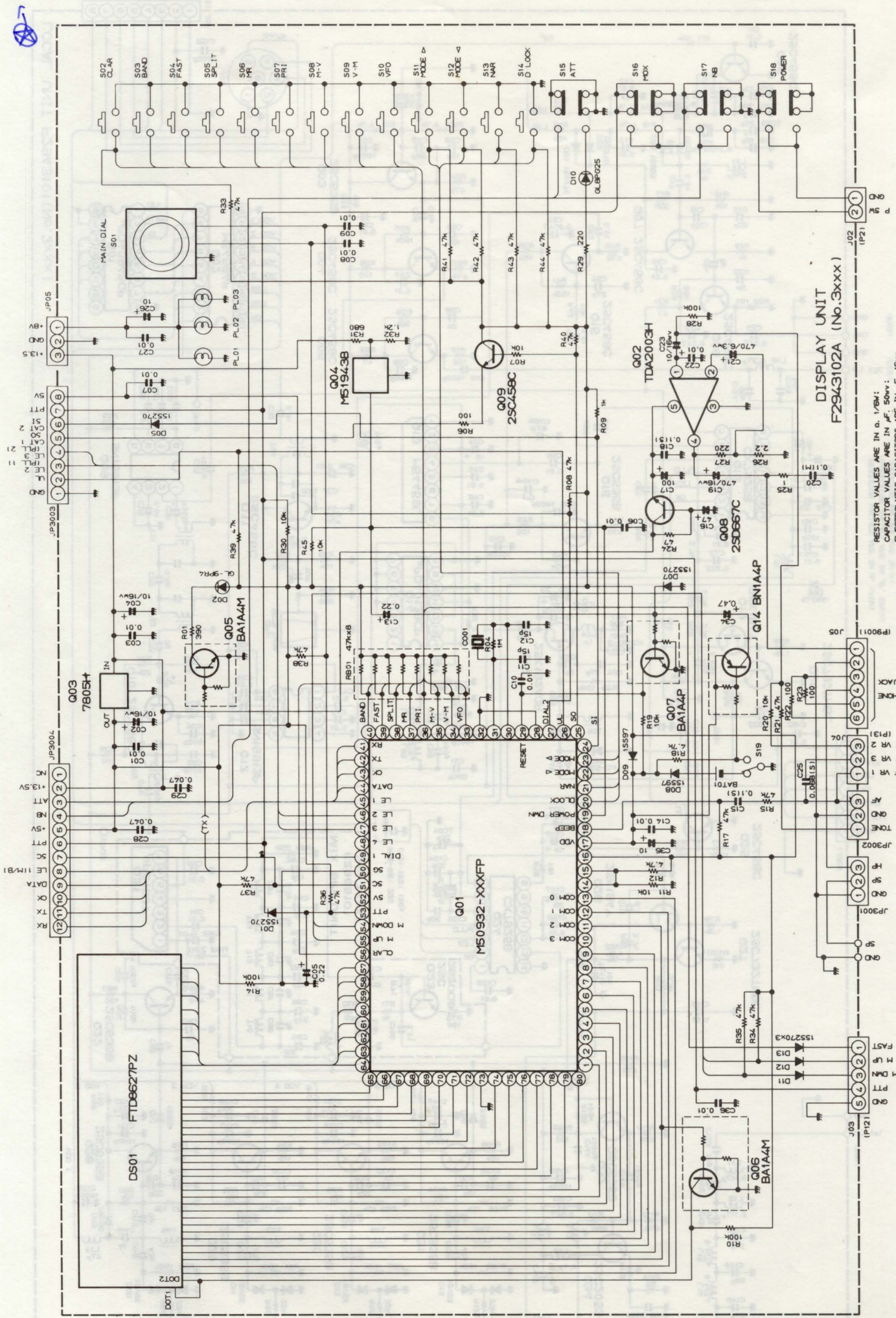

DISPLAY UNIT
F2943102A (No.3xxx)

RESISTOR VALUES ARE IN Ω, 1KΩ,
CAPACITOR VALUES ARE IN pF, 50μV;
ELECTROLYTIC CAPACITORS ARE IN μF, 16V,
UNLESS OTHERWISE NOTED.
151/CAPACITORS ARE POLYESTER FILM, 50μV.
111/CAPACITORS ARE SPICONDUCTOR GERMANIC, 25μV.
111/CAPACITORS ARE TANTALUM, 25μV.

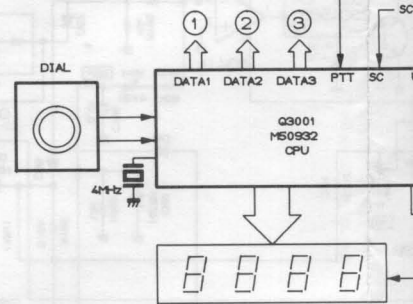
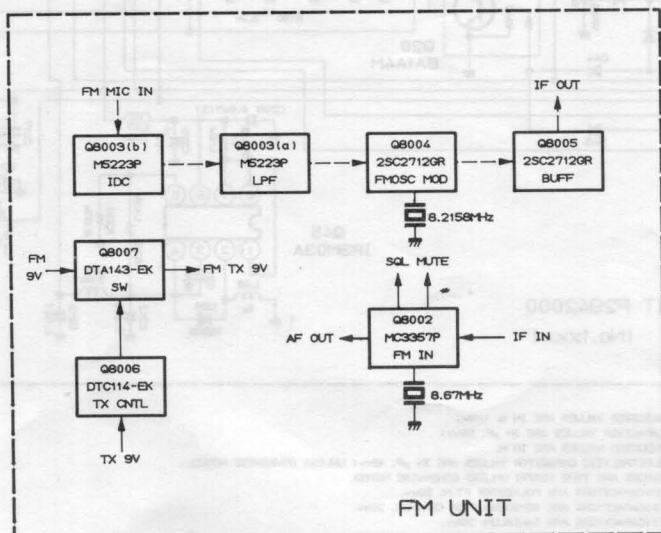
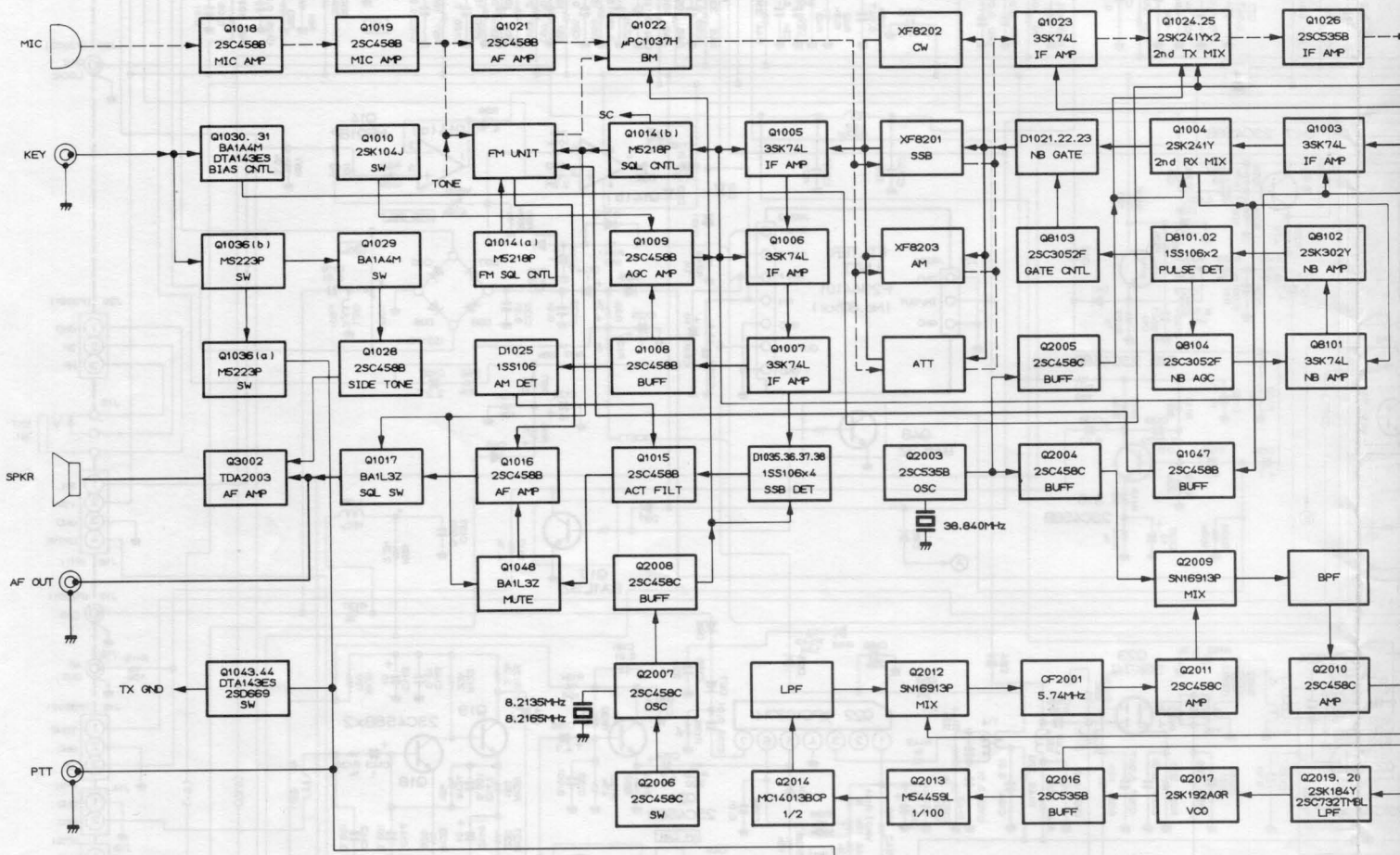
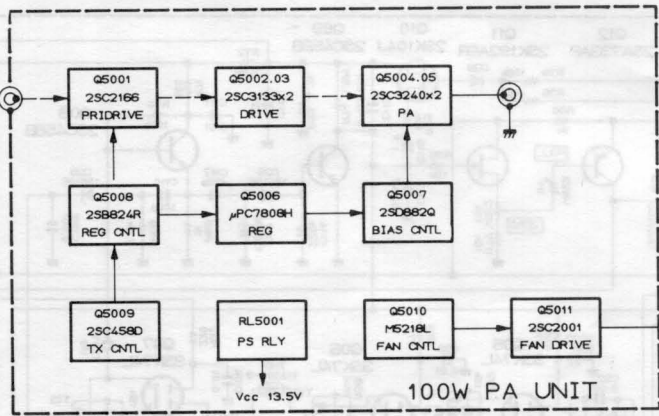

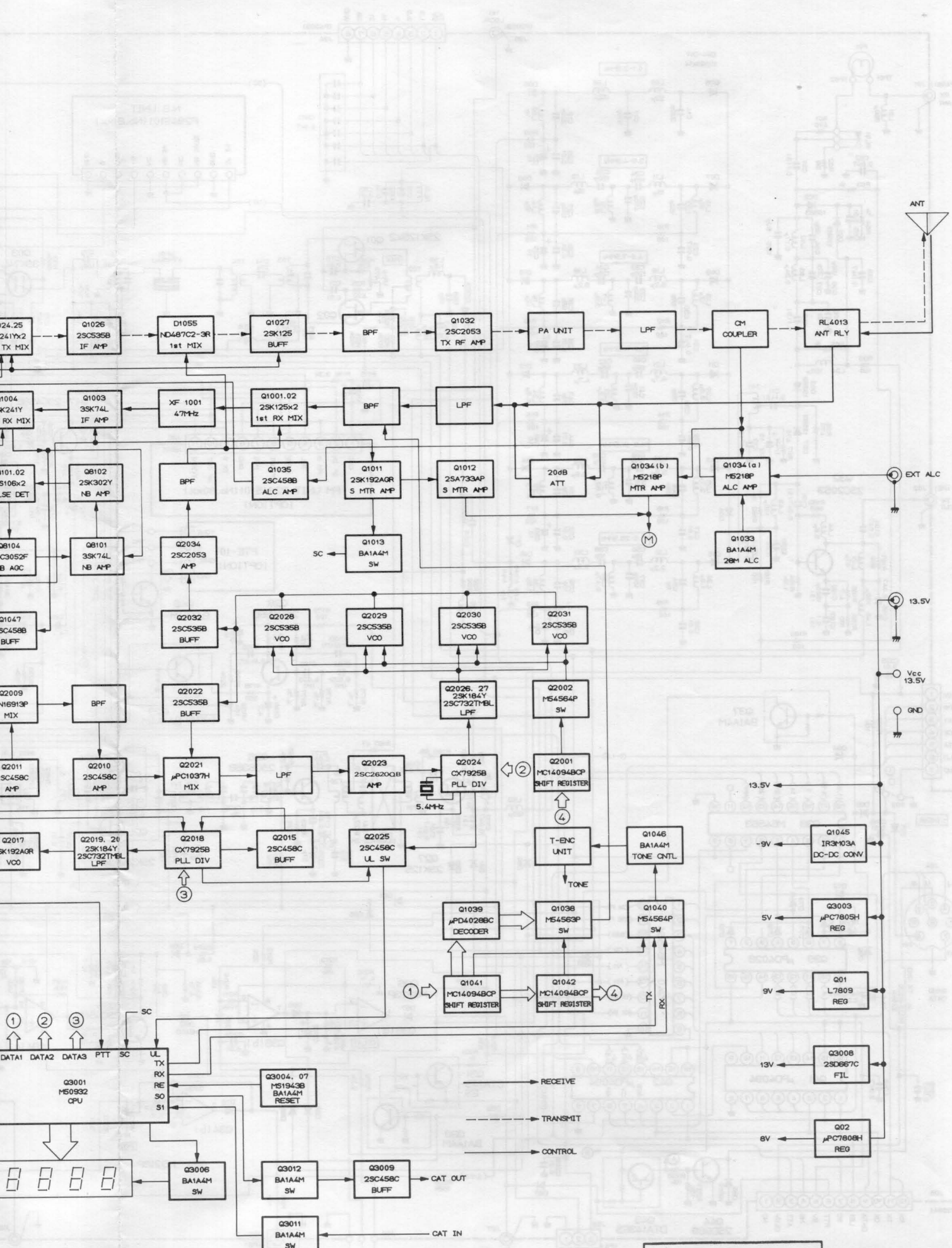

FT-747GX
BLOCK DIAGRAM

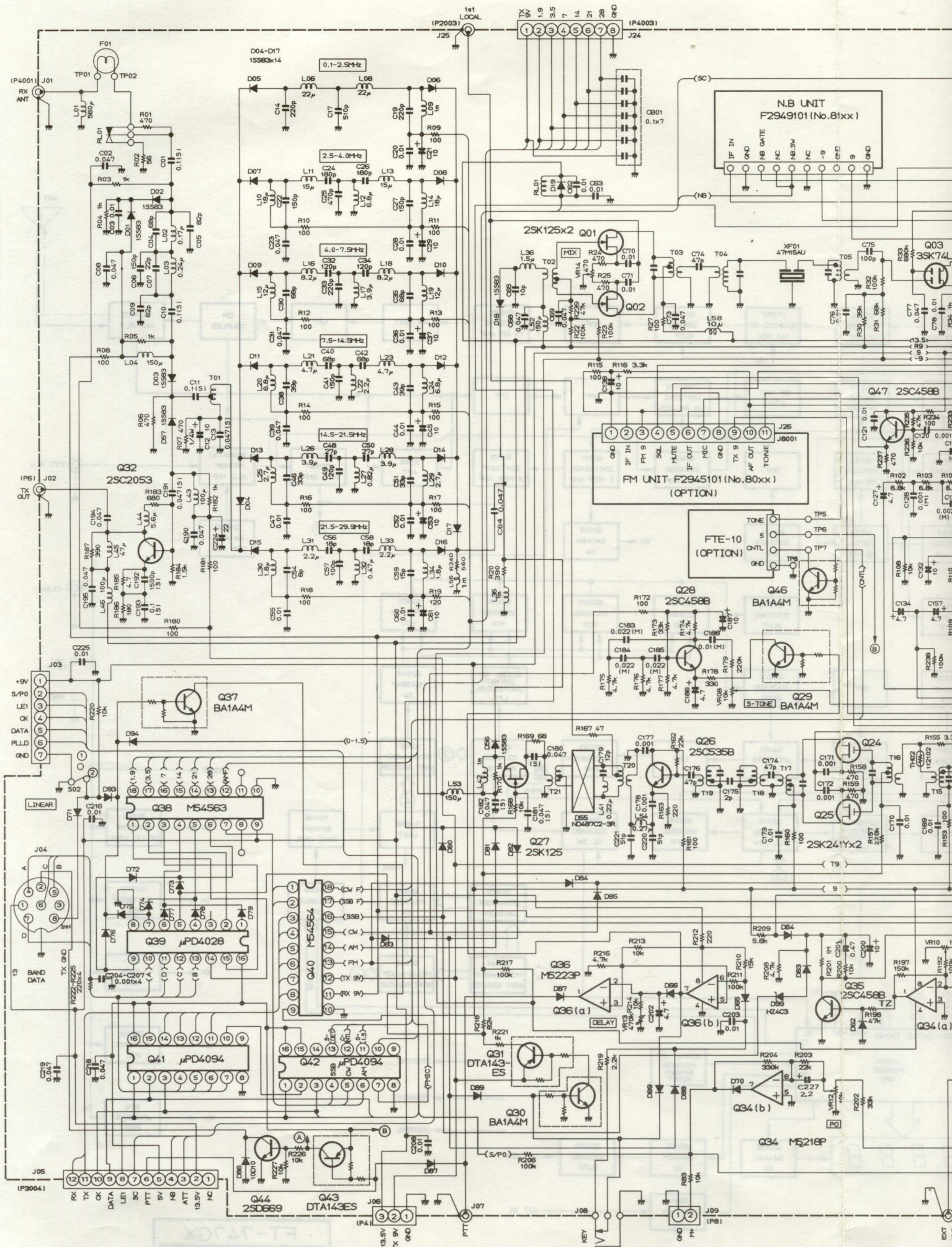

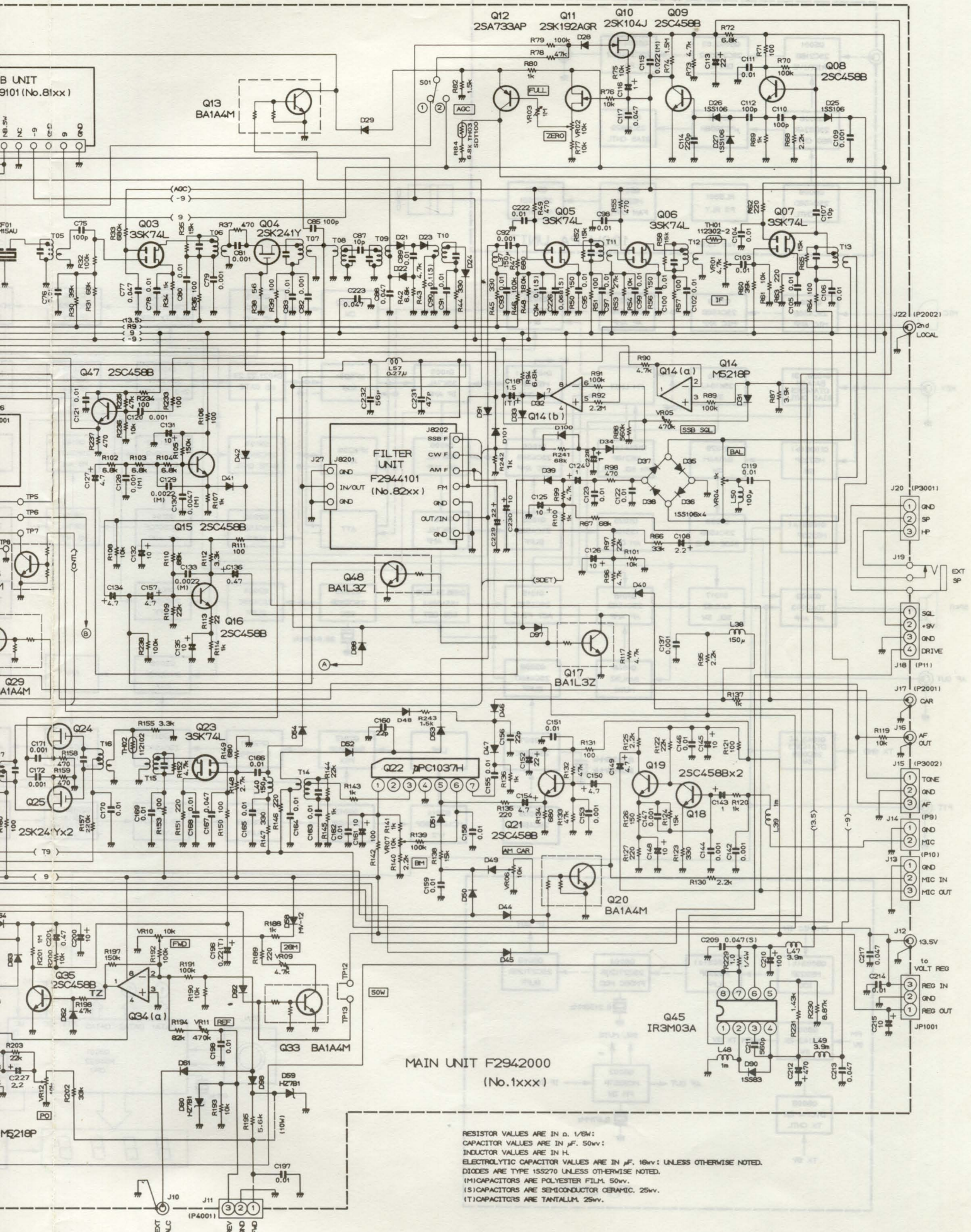

MAIN UNIT F2942000
(No. 1xxx)

RESISTOR VALUES ARE IN Ω, 1/10Ω;
CAPACITOR VALUES ARE IN μF, 50V;
INDUCTOR VALUES ARE IN H;
ELECTROLYTIC CAPACITOR VALUES ARE IN μF, 16V; UNLESS OTHERWISE NOTED.
DIODES ARE TYPE 1S5270 UNLESS OTHERWISE NOTED.
1H(CAPACITORS ARE POLYESTER FILM, 50V.
1S(CAPACITORS ARE SEMI-CONDUCTOR CERAMIC, 25V.
1T(CAPACITORS ARE TANTALUM, 25V.





E2530100(E806-EK)