



**HF/VHF/UHF  
ALL MODE TRANSCEIVER  
FT-897D  
Operating Manual**



**VERTEX STANDARD CO., LTD.**  
4-8-8 Nakameguro, Meguro-Ku, Tokyo 153-8644, Japan  
**VERTEX STANDARD**  
**US Headquarters**  
10900 Walker Street, Cypress, CA 90630, U.S.A.  
**YAESU EUROPE B.V.**  
P.O. Box 75525, 1118 ZN Schiphol, The Netherlands  
**YAESU UK LTD.**  
Unit 12, Sun Valley Business Park, Winnall Close  
Winchester, Hampshire, SO23 0LB, U.K.  
**VERTEX STANDARD HK LTD.**  
Unit 5, 20/F., Seaview Centre, 139-141 Hoi Bun Road,  
Kwun Tong, Kowloon, Hong Kong

# Contents

<b>Introduction</b> .....	1	ARTS™ Operation .....	37
<b>Specifications</b> .....	2	CW Identifier Setup .....	37
<b>Accessories &amp; Options</b> .....	3	Dedital Mode Operation .....	38
<b>Installation</b> .....	4	RTTY (Radio Tele Type) Operation .....	38
Power connections .....	4	PSK31 Operation .....	39
External DC power source operation .....	4	Packet (1200/9600 bps FM) Operation .....	39
AC power source operation .....	5	WeatherFax Monitoring .....	40
Internal battery operation .....	6	Time-Out Timer .....	40
Grounding .....	7	Split Frequency Operation .....	40
Mobile Station Grounding .....	7	Active-Tuning Antenna System (ATAS-100/-120) Operation .....	41
Base Station Earth Grounding .....	7	Automatic Tuning .....	41
Antenna Considerations .....	8	Manual Tuning .....	41
Mobile Antenna Installations .....	8	ATAS-100/-120 Operating Tips .....	42
Base Station Antenna Installations .....	8	Grounding .....	42
RF Field Exposure .....	9	Tuning Procedure .....	42
Electromagnetic Compatibility .....	9	External Wattmeters .....	42
Heat and Ventilation .....	9	Operation on 30/17/12 Meters .....	42
Linear Amplifier Interfacing .....	10	FC-30 Automatic Antenna Tuner Operation .....	43
CW Key/Keyer Connections .....	11	Antenna Tuner Memory System .....	43
Receiver Accessories (Tape Recorder etc.) .....	11	<b>Memory Operation</b> .....	<b>44</b>
Adjusting the Front Feet .....	11	QMB (Quick Memory Bank) Channels .....	44
<b>Front Panel Control &amp; Switches</b> .....	<b>12</b>	QMB Channel Storage .....	44
<b>Rear panel Connectors</b> .....	<b>18</b>	QMB Channel Recall .....	44
<b>Top &amp; Bottom Panel Connectors</b> .....	<b>19</b>	Memory Operation on “Regular” Memory Channel .....	44
<b>Operation</b> .....	<b>20</b>	Normal Memory Storage .....	44
Turning the Transceiver On and Off .....	20	Split-Frequency Memory Storage .....	44
Operating Band Selection .....	20	Memory Channel Recall .....	45
Mode Selection .....	21	Masking (“Hiding”) a Memory .....	45
Adjusting the Audio Volume Level .....	21	Memory Operation on “HOME” Channel Memories .....	46
Adjusting the RF Gain and Squelch .....	21	HOME Channel Storage .....	46
Setting the Operating Frequency .....	22	HOME Channel Recall .....	46
Stacked VFO System .....	22	Labeling Memories .....	46
Changing the DIAL Speed .....	22	<b>Spectrum Scope Monitor</b> .....	<b>47</b>
Operation on 5 MHz Band (U.S. Version Only) .....	23	<b>Smart Search™</b> .....	<b>47</b>
<b>Receiver Accessories</b> .....	<b>24</b>	<b>Scanning Operation</b> .....	<b>48</b>
Locking Front Panel Controls .....	24	Scanning Features .....	48
Clarifier .....	24	Scanning Operation .....	48
IF Shift .....	25	Scan-Resume Choices .....	48
AGC .....	25	Scan Skip Programming (Memory Mode only) .....	49
Noise Blanker .....	26	“Priority Channel” Scanning .....	49
IPO .....	26	Programmable Memory Scan (PMS) Operation .....	50
ATT .....	26	Dual Watch Operation .....	50
DSP Bandpass Filter .....	26	<b>Miscellaneous Settings</b> .....	<b>51</b>
DSP CW Peaking Filter .....	27	Operation on Alaska Emergency Frequency:5167.5 kHz ...	51
DSP Noise Reduction .....	27	CW Training Feature .....	51
DSP Notch Filter .....	27	Programming the Panel Key Functions .....	51
AM/FM Tuning Dial Operation .....	28	Beacon Feature .....	52
Automatic Power-Off Feature .....	28	Beacon Text Storage .....	52
Beacon Text Sending (On the Air) .....	52	Display Customization .....	53
Display Lamp Mode .....	53	Display Contrast .....	53
Display Dimmer .....	53	Display Color .....	53
<b>Transmitter Operation</b> .....	<b>30</b>	<b>Menu Operation</b> .....	<b>54</b>
SSB/AM Transmission .....	30	<b>CAT (Computer Aided Transceiver) Operation</b> .....	<b>63</b>
Basic Setup/Operation .....	30	<b>Power-On Microprocessor Reset Procedures</b> .....	<b>65</b>
VOX Operation .....	30	<b>Cloning</b> .....	<b>65</b>
AF Speech Processor Operation .....	31	<b>Installation Optional Accessories</b> .....	<b>66</b>
DSP Microphone Equalizer .....	31	Optional Filters:YF-122S, YF-122C, and YF-122CN .....	66
CW Transmission .....	32	External Automatic Antenna Tuner “FC-30” .....	67
Operation using Straight Key/External Keying Device .....	32	<b>Appendix</b> .....	<b>68</b>
Using the Built-in Electronic Keyer .....	33	Setup of Memories for Low Earth Orbit (LEO) FM Satellite Operation .....	68
FM Transmission .....	34	MH-59A&J Remote Microphone .....	69
Basic Setup/Operation .....	34		
Repeater Operation .....	34		
Tone Search Scanning .....	35		
DCS Operation .....	36		
DCS Search Scanning .....	36		
Split Tone Operation .....	36		



The **FT-897D** is a rugged, innovative multiband, multi-mode portable transceiver for the amateur radio MF/HF/VHF/UHF bands. Providing coverage of the 160-10 meter bands (include the 60 m band: USA version) plus the 6 m, 2 m, and 70 cm bands, the **FT-897D** includes operation on the SSB, CW, AM, FM, and Digital modes, yielding the most comprehensive performance package available for field operation.

Designed for use from (1) an external DC power source, (2) internal battery (requires optional **FNB-78** Ni-MH battery pack), or (3) AC power source (requires optional **FP-30** External AC Power Supply), the **FT-897D** provides 100 watts of power output from a 13.8-Volt external power supply or AC operation. When using the optional **FNB-78** Ni-MH Battery Pack, the **FT-897D** automatically switches to 20 Watts (430 MHz:10W) of output power.

The multi-function Liquid-Crystal Display includes attractive backlighting, which may be disabled for battery conservation. The display includes bar-graph indication of power output, ALC voltage, SWR, and modulation level. Also include are a number of operating status icons, as well as the function displays for the three operating function keys (A, B, and C).

Among the advanced features of the **FT-897D** are many incorporated only in large base-station transceivers. These include Dual VFOs; Split-Frequency operation; Digital Signal Processing (Bandpass Filtering, Noise Reduction, Notch, and Microphone Equalizer); IF Shift; Clarifier (“R.I.T.”); IF Noise Blanker; AGC Fast/Slow/Auto/Off selection; RF Gain and Squelch control; IPO (Intercept Point Optimization) and a receiver front-end Attenuator; Built-in High Stability Reference Oscillator; AM Aircraft reception; AM and FM Broadcast reception; U.S. Weather Band reception; VOX; Built-in Electronic Keyer; Adjustable CW Pitch; Automatic FM Repeater Shift (ARS); Built-in CTCSS Encoder/Decoders; ARTS™ (Auto-Range Transponder System); Smart Search™ Automatic Memory Loading System; Spectrum Scope; 200 Memories plus Home Channels and Band-limiting Memories; Alpha-Numeric Labeling of Memories; Automatic Power-Off (APO) and Time-Out Timer (TOT) functions; Computer Interface capability; and Cloning capability.

We urge you to read this manual in its entirety, so as to gain a full understanding of the amazing capability of the exciting new **FT-897D** Transceiver.

# SPECIFICATIONS

## General

<b>Frequency Range:</b>	Receive: 0.1-56 MHz, 76-108 MHz, 118-164 MHz, 420-470 MHz Transmit: 160 - 6 Meters (USA: includes 60 meters), 2 Meters, 70 Centimeters (Amateur bands only) 5.1675 MHz (Alaska Emergency Frequency: USA only)
<b>Emission Modes:</b>	A1 (CW), A3 (AM), A3J (LSB/USB), F3 (FM), F1 (9600 bps packet), F2 (1200 bps packet)
<b>Synthesizer Steps (Min.):</b>	10 Hz (CW/SSB), 100 Hz (AM/FM/WFM)
<b>Antenna Impedance:</b>	50 Ohms, Unbalanced (M)
<b>Operating Temp. Range:</b>	+14 °F to +140 °F (−10 °C to +60 °C)
<b>Frequency Stability:</b>	±0.5 ppm/1 hour @25 °C, after warmup
<b>Supply Voltage:</b>	Normal: 13.8 VDC ±15 %, Negative Ground FNB-78 (Ni-MH Battery Pack): 13.2 V (Option)
<b>Current Consumption:</b>	Squelched: 600 mA (Approx.) Receive: 1 A Transmit: 22 A
<b>Case Size (W x H x D):</b>	7.87" x 3.15" x 10.3" (200 x 80 x 262 mm)
<b>Weight (Approx.):</b>	8.6 lb (3.9 kg) (w/o Ni-MH battery, antenna, Microphone)

## Transmitter

<b>RF Power Output (@13.8 V DC):</b>	SSB/CW/FM	AM Carrier
160- 6 Meter:	100 W	25 W
2 Meter:	50 W	12.5 W
70 Centimeter:	20 W	5 W
<b>Modulation Types:</b>	SSB: Balanced Modulator, AM: Early Stage (Low Level), FM: Variable Reactance	
<b>FM Maximum Deviation:</b>	±5 kHz (FM-N: ±2.5 kHz)	
<b>Spurious Radiation:</b>	−50 dB (1.8-29.7 MHz) −60 dB (50/144/430 MHz)	
<b>Carrier Suppression:</b>	>40 dB	
<b>Opp. Sideband Suppression:</b>	>50 dB	
<b>SSB Frequency Response:</b>	400 Hz-2600 Hz (−6 dB)	
<b>Microphone Impedance:</b>	200-10k Ohms (Nominal: 600 Ohms)	

## Receiver

<b>Circuit Type:</b>	Double-Conversion Superheterodyne (SSB/CW/AM/FM) Superheterodyne (WFM)		
<b>Intermediate Frequencies:</b>	1st: 68.33 MHz (SSB/CW/AM/FM); 10.7 MHz (WFM) 2nd: 455 kHz		
<b>Sensitivity:</b>	SSB/CW	AM	FM
100 kHz-1.8 MHz	—	32 µV	—
1.8 MHz-28 MHz	0.2 µV	2 µV	—
28 MHz-30 MHz	0.2 µV	2 µV	0.5 µV
50 MHz-54 MHz	0.125 µV	1 µV	0.2 µV
144/430 MHz	0.125 µV	—	0.2 µV
(SSB/CW/AM = 10 dB S/N, FM = 12 dB SINAD)			
<b>Squelch Sensitivity:</b>	SSB/CW/AM	FM	
100 kHz-1.8 MHz	—	—	
1.8 MHz-28 MHz	2.5 µV	—	
28 MHz-30 MHz	2.5 µV	0.32 µV	
50 MHz-54 MHz	1 µV	0.16 µV	
144/430 MHz	0.5 µV	0.16 µV	
<b>Image Rejection:</b>	HF/50 MHz: 70 dB, 144/430 MHz: 60 dB		
<b>IF Rejection:</b>	60 dB		
<b>Selectivity (−6/−60 dB):</b>	SSB/CW: 2.2 kHz/4.5 kHz AM: 6 kHz/20 kHz FM: 15 kHz/30 kHz FM-N: 9 kHz/25 kHz SSB (optional YF-122S installed): 2.3 kHz/4.7 kHz (−66 dB) CW (option YF-122C installed): 500 Hz/2.0 kHz CW (option YF-122CN installed): 300 Hz/1.0 kHz		
<b>AF Output:</b>	2.5 W (@4 Ohms, 10% THD or less)		
<b>AF Output Impedance:</b>	4-16 Ohms		

*Specifications are subject to change without notice, and are guaranteed within the amateur bands only.*

# ACCESSORIES & OPTIONS

---

---

## SUPPLIED ACCESSORIES

---

---

Hand Microphone MH-31<sup>A&J</sup>  
DC Power Cord  
Operating Manual  
Warranty Card

---

---

## AVAILABLE OPTIONS

---

---

**FP-30** External AC Power Supply  
**FP-1030A** External AC Power Supply (25A)  
**FP-1023A** Compact Power Supply (23A; U.S.A. only)  
**FNB-78** Ni-MH Battery Pack (13.2 V, 4500 mAh)  
**PA-26B/C/U** Ni-MH Battery Charger  
**CD-24** Ni-MH Battery Charger Adapter  
**YF-122S** Collins SSB Filter (2.3 kHz/4.7 kHz: -6 dB/-66 dB)  
**YF-122C** Collins CW Filter (500 Hz/2 kHz: -6 dB/-60 dB)  
**YF-122CN** Collins CW Filter (300 Hz/1 kHz: -6 dB/-60 dB)  
**FC-30** External Automatic Antenna Tuner  
**ATAS-25** Active-Tuning Antenna System  
**ATAS-100** Active-Tuning Antenna System  
**ATAS-120** Active-Tuning Antenna System  
**ATBK-100** VHF/UHF Antenna Base/Counterpoise Kit  
**MMB-80** Mounting Bracket  
**VL-1000** Solid-State Linear Amplifier  
**MD-200A<sup>8x</sup>** Desktop Microphone  
**MH-36E<sup>8J</sup>** DTMF Microphone  
**MH-59A<sup>8J</sup>** Remote Control Microphone  
**CT-62** CAT Interface Cable  
**CT-39A** Packet Cable  
**CT-58** BAND DATA Cable

## POWER CONNECTIONS

The **FT-897D** is designed use from (1) an external DC power source, (2) internal battery (requires optional **FNB-78** Ni-MH battery pack), or (3) AC power source (requires optional **FP-30** Internal AC Power Supply).

### External DC power source operation

The DC power connector for the **FT-897D** must only be connected to a DC source providing 13.8 Volts DC ( $\pm 15\%$ ), and capable of at least 22 Amperes of current. Always observe proper polarity when making DC connections:

The **Red** DC power lead connects to the **Positive (+)** DC terminal; and the **Black** DC power lead connects to the **Negative (-)** DC terminal.

In mobile installations, noise pickup may be minimized by connecting the DC cable directly to your vehicle's battery, rather than to the ignition switch or "accessory" circuitry. Direct connection to the battery also provides the best voltage stability.

#### Tips for Successful Mobile Installations:

- Before connecting the DC cable to the battery, measure the voltage across the battery terminals with the engine running fast enough to show a charge. If the voltage is above 15 Volts, the vehicle's voltage regulator should be adjusted to reduce the charging voltage to 14 Volts or lower.
- Route the DC cable as far away from the ignition cables as possible.
- If the DC cable is not long enough, use #12 AWG (minimum) stranded, insulated wire to extend it. Be certain to solder the connections at the splice securely, and provide ample insulation for the soldered splice (heat shrink tubing plus black electrical tape work well).

- Check the battery terminal connections frequently to be sure they are tight and not corroded.
- When operating with the vehicle turned off, or operating from a stand-alone car battery (in a camp site, etc.), be mindful of the minimum operating voltage (11.73 Volts) for the **FT-897D**. If the battery is not charged sufficiently to maintain at least 11¾ Volts at the radio, erratic operation or shut-down may occur.

#### Caution

Permanent damage can result if improper supply voltage, or reverse-polarity voltage, is applied to the **FT-897D**. The Limited Warranty on this transceiver does not cover damage caused by application of AC voltage, reversed polarity DC, or DC voltage outside the specified range of 13.8V  $\pm 15\%$ . Never attempt to connect the **FT-897D** to a 24 Volt battery system.

When replacing fuses, be certain to use a fuse of the proper rating. The **FT-897D** requires a 25A fast-blow fuse.

## POWER CONNECTIONS

### AC power source operation (requires optional FP-30 AC power supply)

For base station installations, Yaesu recommends the use of the **FP-30** AC power supply, which is designed to clamp onto the **FT-897D**.

#### Installation

1. Turn the transceiver's power off, and disconnect all cables from the transceiver.
2. Remove the six screws (three screws on bottom side and rear side), then lift off the bottom cover (Figure 1 and 2).
3. Attach the **FP-30** to the bottom of the **FT-897D**, then affix it in place with the six screws removed in the above steps (Figure 3).
4. Connect the 6-pin Molex plug from the **FP-30** to the **INPUT** jack on the rear panel of the **FT-897D** (Figure 4).
5. Make sure that your AC voltage is correct and that the **FP-30 POWER** switch is set to Off; connect the AC power cable between the **INPUT** jack on the rear panel of the **FP-30** and a nearby AC wall outlet.

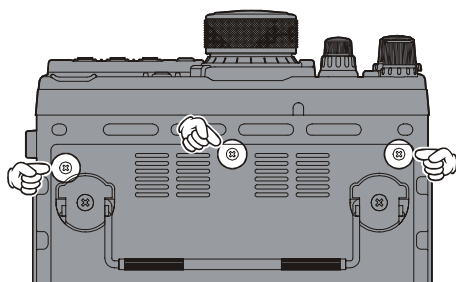

Figure 1

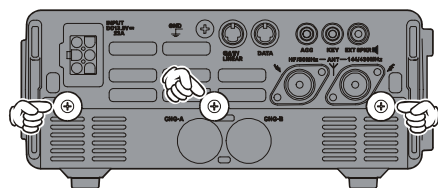

Figure 2

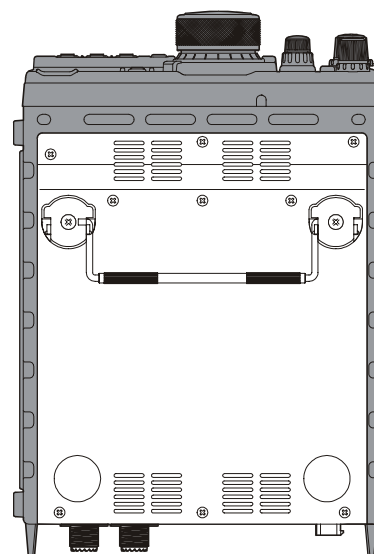

Figure 3

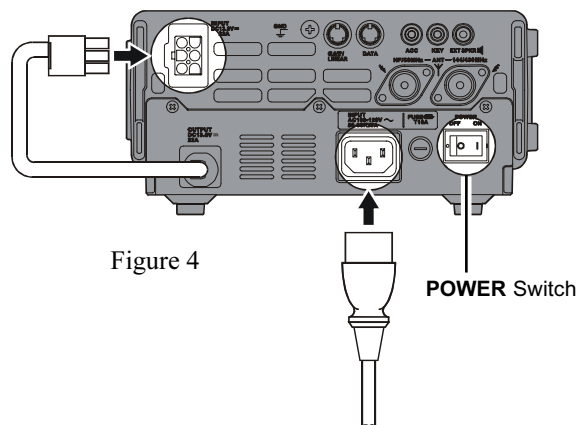

Figure 4

### AC Input Voltage Selection (U.S.A. Users only)

- Before moving the AC range switch, disconnect the **FP-30**'s AC Power Cable from the AC line outlet, then wait 10 minutes to allow the power supply's electrolytic capacitors to discharge (electrical shock hazard!).
- Peel off the label on the side of the **FP-30**.
- Move the AC range switch to the "115" position for operation from 100-120 VAC, or to the "230" position for operation from 200-240 VAC.
- Always uses the 10 A Fuse in the fuse holder on the rear panel whether operate on 100-120 VAC or 200-240 VAC. Do not use the improper fuse.



**Warning:** Our Warranty does not cover damage caused by improper supply voltage nor use of an improper fuse.

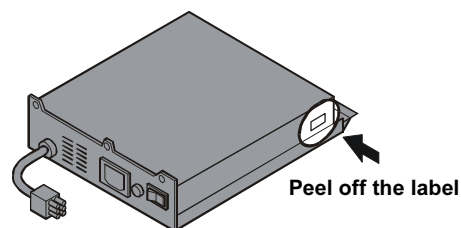

Peel off the label

## POWER CONNECTIONS

### Internal battery operation (requires optional FNB-78 Ni-MH battery pack)

The optional **FNB-78** Ni-MH Battery Pack provides 13.2 Volts of DC power for your **FT-897D**, with a maximum capacity of 4500 mAh (you may install the two **FNB-78** into the **FT-897D**, in this time, maximum capacity is 9 Ah!).

A fully charged set of **FNB-78** Ni-MH Battery Pack should provide approximately 4 hours of reception under typical conditions.

### Installation

1. Turn the transceiver's power off, and disconnect all cables from the transceiver.
2. Remove the six screws (three screws on bottom side and rear side), then lift off the bottom cover (Figure 1 and 2).
3. Insert the **FNB-78** into the battery compartment "A" or "B" on the bottom of the radio so that the battery's mounting tab is aligned with the mounting hole on the radio's chassis (Figure 3).
4. Connect the 3-pin connector from the **FNB-78** to the battery jack on the radio's chassis, corresponding to the label ("A" or "B") of the battery compartment to which the **FNB-78** is installed (Figure 3).
5. Remove the plastic cap, which is same label ("A" or "B") of the battery compartment which is the **FNB-78** installed, from the to bottom cover, before turning the plastic cap so that the small project of the cap is aligned with the slot of the bottom cover (Figure 2).
6. Replace the bottom cover and its six screws.

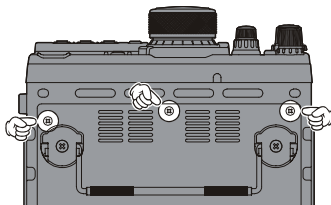

Figure 1

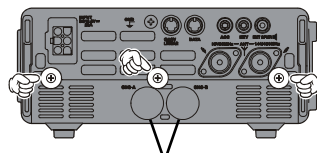

Figure 2 Plastic Cap

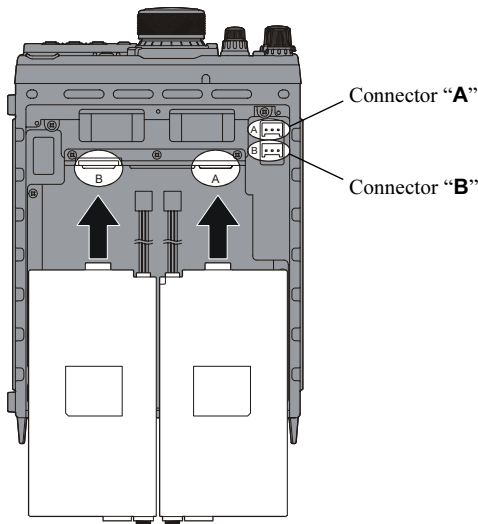

Figure 3

### Charging

Charging of the **FNB-78** requires the use of the optional **CD-24** Charge Adapter.

1. Turn the radio off.
2. Connect the cable plug from the DC Power supply into the **INPUT** jack on the **CD-24** Charge Adapter, then insert the cable plug from the **CD-24** into the "CHG-A" or "CHG-B" jack on the rear of the radio.
3. The "BATT-A" or "BATT-B" indicator on the front panel of the **FT-897D** will glow red (Charging) while the battery is being charged. When charging is completed, the red LED indicator will turn to off (Fully Charged).  
A fully-discharged pack will be charged completely in about four hours.
4. Unplug the cable from the **CHG** terminal, then disconnect the **CD-24** from the DC Power supply.

### Operation

Before turning the radio on, select the battery ("A" or "B") to be used by setting the top panel's **A-B** switch as appropriate.

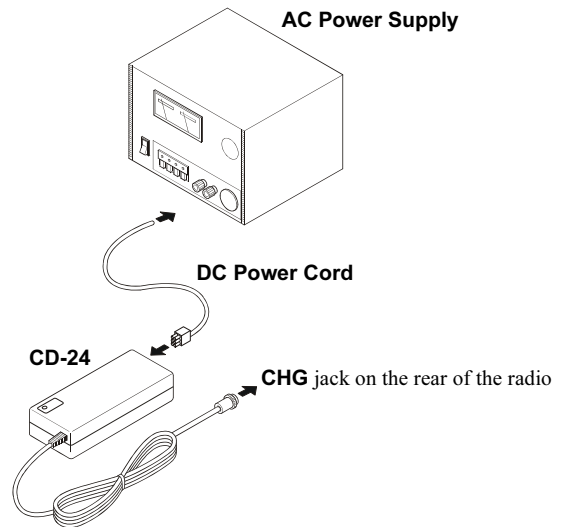



## GROUNDING

The provision of an effective ground system is important in any successful communications station. A good ground system can contribute to station efficiency in a number of ways:

- It can minimize the possibility of electrical shock to the operator.
- It can minimize RF currents flowing on the shield of the coaxial cable and the chassis of the transceiver which may cause interference to nearby home entertainment devices or laboratory test equipment.
- It can minimize the possibility of erratic transceiver operation caused by RF feedback or improper current flow through logic devices.

An effective earth ground system may take several forms; for a more complete discussion, see an appropriate RF engineering text. The information presented below is intended only as a guideline.

Inspect the ground system – inside the station as well as outside – on a regular basis so as to ensure maximum performance and safety.

### Mobile Station Grounding

Although satisfactory grounding in most installations will be achieved via the DC cable's negative lead and the antenna system's coaxial cable shield, it is often recommended that you provide a direct ground connection to the vehicle chassis at the mounting location of the transceiver (installation using the optional **MMB-80** Mounting Bracket will accomplish this, if the **MMB-80** itself is mounted to the vehicle's chassis). Due to unexpected resonance which may naturally occur in any location, improper communication system performance may result from insufficient grounding. These symptoms may include:

- RF feedback (resulting in distortion on your transmitted signal);
- Unintended frequency change;
- Blinking or blanking of the frequency display;
- Noise pickup; and/or
- Loss of memory.

Note that these conditions may occur in any communications installation. The **FT-897D** includes extensive filtering designed to minimize the chance of such problems; however, random currents set up by insufficient RF grounding can nullify such filtering. Bonding the rear panel Ground lug of the **FT-897D** transceiver to the vehicle or vessel's ground system should clear up any such difficulties.

Vertex Standard does not recommend the use of "on glass" mobile antennas unless the shield of the coaxial cable is securely grounded near the feedpoint of the antenna. Such antennas frequently are responsible for the ground-related difficulties described above.

### Base Station Earth Grounding

Typically, the ground connection consists of one or more copper-clad steel rods, driven into the ground. If multiple ground rods are used, they should be configured in a "V" configuration, and bonded together at the apex of the "V" which is nearest the station location. Use a heavy, braided cable (such as the discarded shield from type RG-213 coaxial cable) and strong cable clamps to secure the braided cables to the ground rods. Be sure to weatherproof the connections to ensure many years of reliable service. Use the same type of heavy, braided cable for the connections to the station ground bus (described below).

***Do not use gas line pipes in an attempt to provide a ground connection! To do so creates a serious risk of explosion!!***

Inside the station, a common ground bus consisting of a copper pipe of at least 25 mm (1") diameter should be used. An alternative station ground bus may consist of a wide copper plate (single-sided circuit board material is ideal) secured to the bottom of the operating desk. Grounding connections from individual devices such as transceivers, power supplies, and data communications devices should be made directly to the ground bus using a heavy, braided cable.

Do not make ground connections from one electrical device to another, and thence to the ground bus. This so-called "Daisy Chain" grounding technique may nullify any attempt at effective radio frequency grounding. See the drawings below for examples of proper and improper ground connections. If your coaxial cable does not connect directly to the station ground bus, you may connect a ground cable to the Ground lug on the **FT-897D** rear panel.

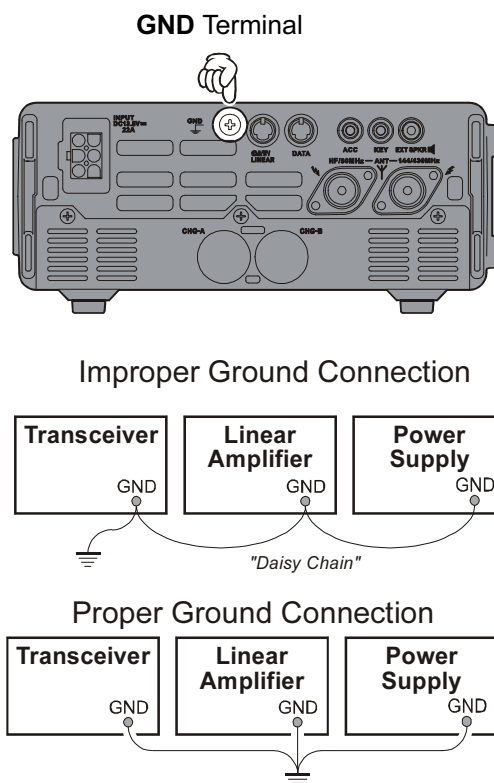

## ANTENNA CONSIDERATIONS

The antenna systems connected to your **FT-897D** transceiver are, of course, critically important in ensuring successful communications. The **FT-897D** is designed for use with any antenna system providing a 50  $\Omega$  resistive impedance at the desired operating frequency. While minor excursions from the 50  $\Omega$  specification are of no consequence, the power amplifier's protection circuitry will begin to reduce the power output of there is more than a 50% divergence from the specified impedance (less than 33  $\Omega$  or greater than 75  $\Omega$ , corresponding to a Standing Wave Ratio (SWR) of 1.5:1).

Two antenna jacks are provided on the rear panel of the **FT-897D**. The "HF/50 MHz ANT" jack is used for HF and 50 MHz, while the "144/430 MHz ANT" jack is used for 144 MHz and 430 MHz.

Guidelines for successful base and mobile station installations are shown below.

### Mobile Antenna Installations

Mobile antennas for the HF bands, with the possible exception of those designed for 28 MHz, display very high "Q" due to the fact that they must be physically shortened, then resonated using a loading coil. Additional system bandwidth may be realized using the Yaesu **FC-30** Automatic Antenna Tuner, which will present a 50  $\Omega$  impedance to your transceiver on the 1.8 ~ 50 MHz bands so long as the SWR on the coaxial line connected to the **FC-30** is below 3:1.

On the VHF and UHF bands, coaxial line losses increase so rapidly in the presence of SWR that we recommend that all impedance matching to 50  $\Omega$  be performed at the antenna feedpoint.

Yaesu's Active-Tuned Antenna System (**ATAS-100/-120**) is a unique HF/VHF/UHF mobile antenna system, which provides automatic tuning when used with the **FT-897D**. See page 39 for full details on the **ATAS-100/-120**.

For VHF/UHF weak-signal (CW/SSB) operation, remember that the antenna polarization standard for these modes is horizontal, not vertical, so you must use a loop or otherwise horizontally-polarized antenna so as to avoid cross-polarization loss of signal strength (which can be 20 dB or more!). On HF, signals propagated via the ionosphere develop mixed polarizations, so antenna selection may be made strictly on mechanical considerations; vertical antennas are almost always utilized on HF for this reason.

### Base Station Antenna Installations

When installing a "balanced" antenna such as a Yagi or dipole, remember that the **FT-897D** is designed for use with an (unbalanced) coaxial feedline. Always use a balun or other balancing device so as to ensure proper antenna system performance.

Use high-quality 50  $\Omega$  coaxial cable for the lead-in to your **FT-897D** transceiver. All efforts at providing an efficient antenna system will be wasted if poor quality, lossy coaxial cable is used. Losses in coaxial lines increase as the frequency increases, so a coaxial line with 0.5 dB of loss at 7 MHz may have 6 dB of loss at 432 MHz (thereby consuming 75% of your transceiver's power output!). As a general rule, smaller-diameter coaxial cables tend to have higher losses than larger-diameter cables, although the precise differences depend on the cable construction, materials, and the quality of the connectors used with the cable. See the cable manufacturers' specifications for details.

For reference, the chart below shows approximate loss figures for typically-available coaxial cables frequently used in HF installations.

Loss in dB per 30 m (100 feet)  
for Selected 50-ohm Coaxial Cables

Cable Type	Loss		
	1.8 MHz	28 MHz	432 MHz
RG-58A	0.55	2.60	>10
RG-58 Form	0.54	2.00	8.0
RG-8X	0.39	1.85	7.0
RG-8A, RG-213	0.27	1.25	5.9
RG-8 Form	0.22	0.88	3.7
Belden 9913	0.18	0.69	2.9
7/8" "Hardline"	<0.1	0.25	1.3

Loss figures are approximate; consult cable manufacturer's catalogs for complete specifications.

Always locate antennas such that they can *never* come in contact with outdoor power lines in the event of a catastrophic support or power-pole structural failure. Ground your antennas' support structure(s) adequately, so as to dissipate energy absorbed during a lightning strike. Install appropriate lightning arrestors in the antenna coaxial cables (and rotator cables, if rotary antennas are used).

In the event of an approaching electrical storm, disconnect all antenna lead-in, rotator cables, and power cables *completely* from your station **if the storm is not immediately in your area**. Do not allow disconnected cables to touch the case of your **FT-897D** transceiver or accessories, as lightning can easily jump from the cable to the circuitry of your transceiver via the case, causing irreparable damage. If a lightning storm is in progress in your immediate area, do not attempt to disconnect the cables, as you could be killed instantly if lightning should strike your antenna structure or a nearby power line.

If a vertical antenna is utilized, be certain that humans and/or pets and farm animals are kept away both from the radiating element (to prevent electrical shock and RF exposure danger) *and* the ground system (in the event of an electrical storm). The buried radials of a ground-mounted vertical antenna can carry lethal voltages outward from the center of the antenna in the event of a direct lightning strike.

## RF FIELD EXPOSURE

This transceiver is capable of power output in excess of 50 Watts, so customers in the United States may be required to demonstrate compliance with Federal Communications Commission (FCC) regulations concerning maximum permissible exposure to radio frequency energy. Compliance is based on the actual power output used, feedline loss, antenna type and height, and other factors which can only be evaluated as a system.

Information regarding these regulations may be available from your Dealer, your local radio club, from the FCC directly (press releases and other information can be found on the FCC's site on the World Wide Web at <<http://www.fcc.gov>>), or from the American Radio Relay League, Inc. (225 Main St., Newington CT 06111 or <<http://www.arrl.org>>).

Although there is negligible radio frequency (RF) leakage from the **FT-897D** transceiver itself, its antenna system should be located as far away from humans and animals as practicable, so as to avoid the possibility of shock due to accidental contact with the antenna or excessive long-term exposure to RF energy. During mobile operation, do not transmit if someone is standing adjacent to your antenna, and use the lowest power possible.

Never stand in front of an antenna (during testing or operation) when RF power is applied, especially in the case of 430 MHz directional arrays. The 20 Watt power output supplied by the **FT-897D**, combined with the directivity of a beam antenna, can cause immediate heating of human or animal tissues, and may cause other undesirable medical effects.

## ELECTROMAGNETIC COMPATIBILITY

If this transceiver is used with, or in the vicinity of, a computer or computer-driven accessories, you may need to experiment with grounding and/or Radio Frequency Interference (RFI) suppression devices (such as ferrite cores) to minimize interference to your communications caused by energy from the computer. Computer-generated RFI is usually a result of inadequate shielding of the computer's cabinet or I/O and peripheral connections. While computer equipment may "comply" with RF emission standards, this does not ensure that sensitive Amateur Radio receivers like the **FT-897D** will not experience interference from the device!

Be certain to use only shielded cables for TNC-to-Transceiver connections. You may need to install AC line filters on the power cord(s) of the suspected equipment, and decoupling ferrite toroidal chokes may be required on interconnecting patch/data cables. As a last resort, you can try installing additional shielding within the computer's case, using appropriate conductive mesh or conductive shielding tape. Especially check "RF holes" where plastic is used for cabinet front panels.

For further information, consult amateur radio reference guides and publications relating to RFI suppression techniques.

## HEAT AND VENTILATION

To ensure long life of the components, be certain to provide adequate ventilation around the cabinet of the **FT-897D**. The cooling system of the transceiver must be free to draw cool air in from the side of the transceiver and expel warm air from the rear of the transceiver.

Do not install the transceiver on top of another heat-generating device (such as a linear amplifier), and do not place equipment, books, or papers on top of the transceiver. Place the transceiver on a hard, flat, stable surface. Avoid heating vents and window locations that could expose the transceiver to excessive direct sunlight, especially in hot climates.

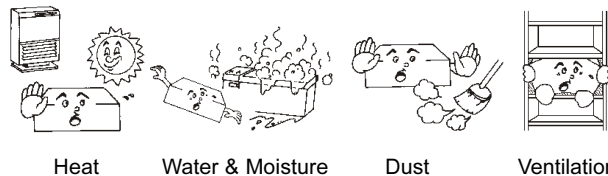

Heat      Water & Moisture      Dust      Ventilation

### Note

Save the packing materials in case you need to transport the set (on an airplane, etc.) and/or return the set for service.

## LINEAR AMPLIFIER INTERFACING

The **FT-897D** provides the switching and drive-control lines required for easy interfacing to most all commonly-available amplifiers sold today.

These include:

- The Antenna Jacks (“HF/50MHz” and “144/430MHz”);
- A T/R control line (open circuit on RX, closure to ground on TX); and
- A negative-going ALC jack (control voltage range: 0V to -4V DC).
- When interfacing to the **VL-1000** Solid State 1 KW Linear Amplifier, the optional CT-58 Interface Cable provides for easy interconnection (requires that the Menu Mode No-020 [CAT/LIN/TUN] setting changes to “LINEAR”).

The rear-panel **CAT/LINEAR** jack is an 8-pin, miniature DIN type, with the “TX GND” pin providing a closure to ground on transmit, for T/R control of your linear amplifier. The **ACC** jack is a miniature stereo type, with external ALC input capability on the tip connection. The main shaft is the ground return. The ring connection of the **ACC** jack, when closed to ground, places the **FT-897D** into the transmit mode, and sends a steady CW carrier, for amplifier (or antenna tuner) adjustment purposes.

Typical amplifier interface circuits are shown below.

Note that some amplifiers, particularly VHF or UHF “brick” amplifiers, offer two methods of T/R switching: application of +13V or a closure to ground.

Be sure to configure your amplifier so that it switches via a closure to ground, as provided by your **FT-897D**’s **CAT/LINEAR** jack (“TX GND” pin). Alternatively, many of these amplifiers use “RF Sensing” to control their relays; if yours is in this category, you may then use the T/R control line from the “TX GND” pin of the **CAT/LINEAR** jack for control of your HF linear amplifier, and RF sensing for your VHF or UHF amplifier.

The “TX GND” T/R control line is a transistor “open collector” circuit, capable of handling positive amplifier relay coil voltages of up to +50V DC and current of up to 400 mA. If you plan on using multiple linear amplifiers for different bands, you must provide external band-switching of the “TX GND” relay control line from the **CAT/LINEAR** jack.

### Important Note!

Do not exceed the maximum voltage or current ratings for the “TX GND” line at the **CAT/LINEAR** jack. This line is not compatible with negative DC voltages, nor AC voltages of any magnitude.

Most amplifier control relay systems require only low DC voltage/current switching capability (typically, +12V DC at 25 ~ 75 mA), and the switching transistor in the **FT-897D** will easily accommodate such amplifiers.

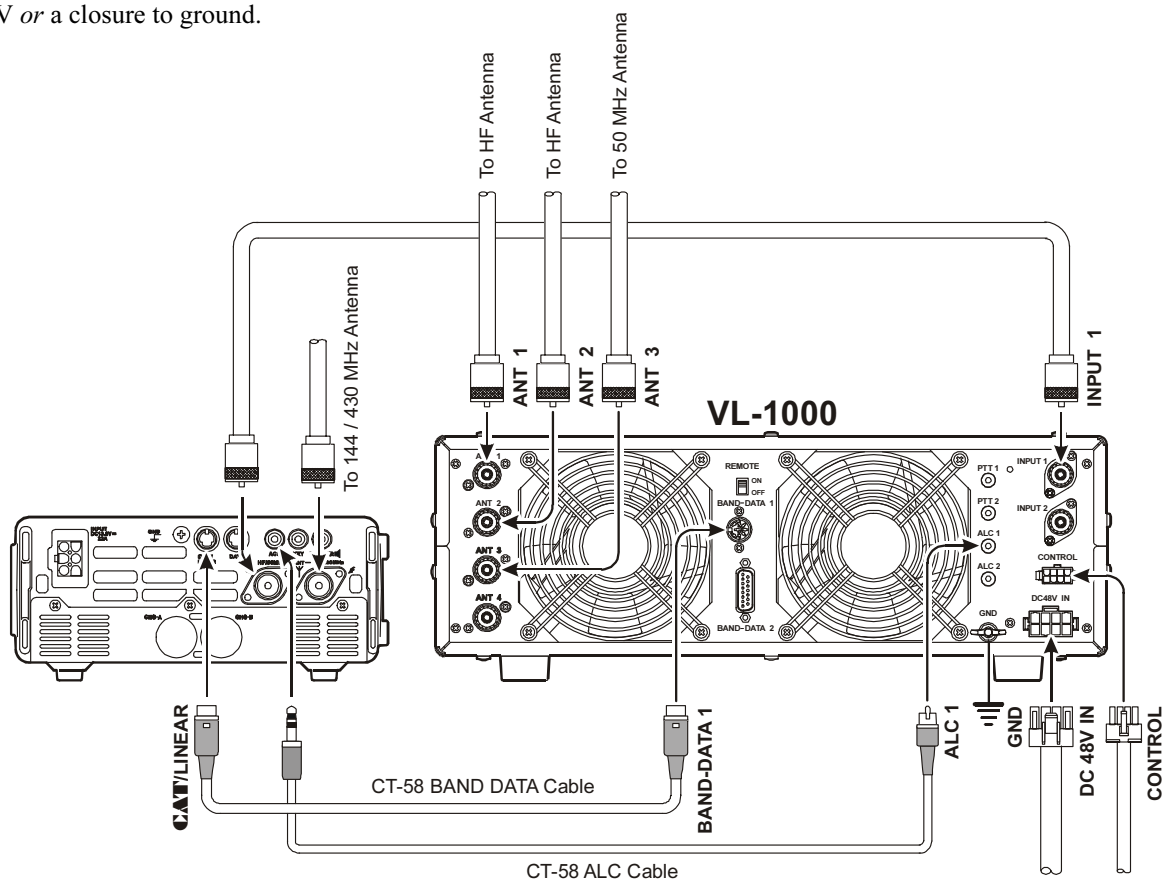

\*The “CT-58” consists of two separate cables: the BAND DATA cable (Part # T9101500) and the ALC Cable (T9101501).

---

## CW KEY/KEYER CONNECTIONS

---

All commonly-available keyer paddles should work perfectly with the built-in Electronic Keyer. The wiring configuration for the paddle is shown below.

For straight-key operation, only the tip and shaft connections are used.

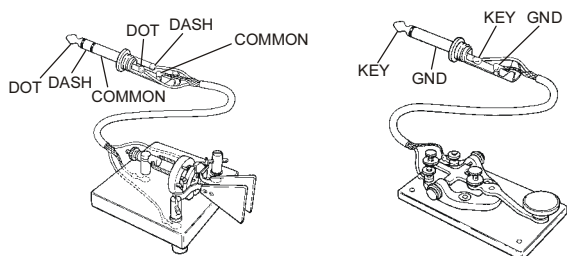

**Note:** Even when using a straight key, you must use a three-conductor (“stereo”) plug. If a two-conductor plug is used, the key line will be constantly shorted to ground.

When using an external electronic keyer, be absolutely certain that it is configured for “positive” keying, not “negative” or “grid block” keying. The “key-up” voltage of the **FT-897D** is +5V, and the “key-down” current is only about 1 mA.

For CW automated keying using a personal computer, with an external memory keyer providing for manual sending, it usually is possible to connect the keyed lines together via a “Y” connector. Check with the documentation accompanying your keyer and your contest/DX software for any cautions which need to be observed.

---

## RECEIVER ACCESSORIES (TAPE RECORDER ETC.)

---

Connection of a tape recorder or other such receiver accessory is easily accomplished by using the **DATA** jack’s Data Out (1200 bps) terminal (Pin 5) and Ground (Pin 2). The audio output is fixed at 100 mV, with an impedance of 600  $\Omega$ .

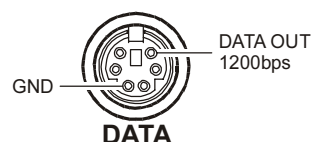

---

## ADJUSTING THE FRONT BAIL

---

The front bail of the transceiver allows the transceiver to be tilted upward for better viewing. Simply fold bail forward to raise the front of the transceiver, and fold bail back against the bottom case to lower the front of the **FT-897D**.

# FRONT PANEL CONTROL & SWITCHES

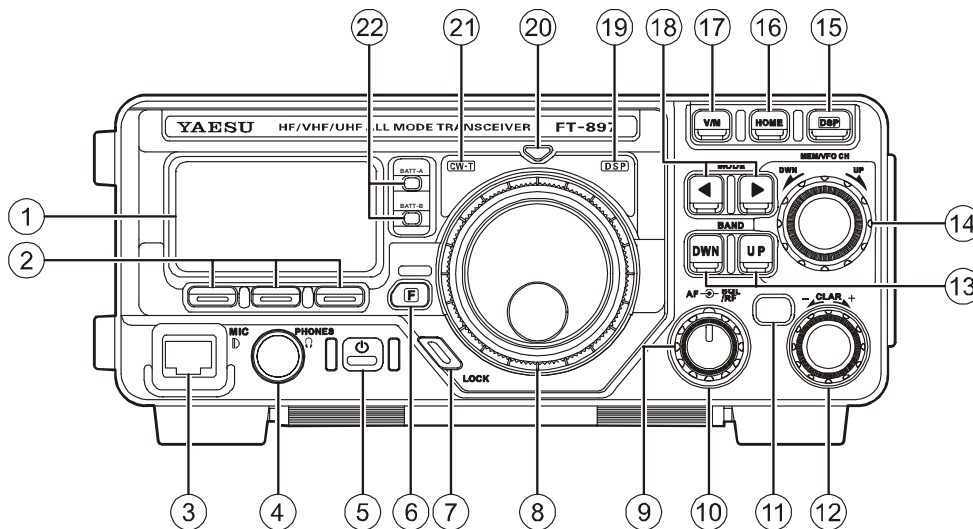

## ① Liquid Crystal Display

The Liquid Crystal Display (LCD) provides indication of the operating frequency and other aspects of transceiver status.

## ② FUNC Keys

These three keys select many of the most important operating features of the transceiver. When you press the [F] key, then rotate the **MEM/VFO CH** knob, the current function of that key will appear above each of the [A], [B], and [C] keys (along the bottom of the LCD). You may scroll the display through 17 rows of functions available for use via the [A], [B], and [C] keys.

The available features are shown in page 14.

## ③ MIC Jack

Connect the supplied **MH-31A8J** Hand Microphone to this jack.

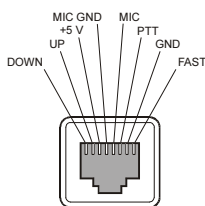

## ④ PHONES Jack

This 1/4-inch, 3-contact jack accepts either monaural or stereo headphones with 2- or 3-contact plugs. When a plug is inserted, the loudspeaker is disabled. The audio level varies according to the setting of the front panel's **AF** knob.

## ⑤ POWER Switch

Press and hold in the **POWER** switch for one second to turn to the transceiver on or off.

While the transceiver is turned on, pressing this switch momentarily will engage the “Fast Tuning” mode, to allow more rapid frequency navigation (a small “running man” icon will be observed in the bottom right-hand corner of the LCD).

## ⑥ [F] Key

Press this key momentarily to enable the changing of the function of the Multi Function keys ([A], [B], and [C]) by the **MEM/VFO CH** knob.

Press and hold this key for one second to activate the “Menu” mode.

## ⑦ LOCK Key

Pressing this key locks the front panel keys so as to prevent accidental frequency change. The **LOCK** key itself, though, will never be disabled.

## ⑧ MAIN DIAL

This is the main tuning dial for the transceiver. It is used both for frequency tuning as well as “Menu” setting in the transceiver.

## ⑨ AF Knob

The (inner) **VOL** knob adjusts the receiver audio volume level presented to the internal or external speaker. Clockwise rotation increases the volume level.

## ⑩ SQL/RF Knob

In the USA version, this (outer) **SQL/RF** knob adjusts the gain of the receiver's RF and IF stages. Using Menu Mode No-080 [SQL/RF GAIN], this control may be changed to function as a Squelch control, which may be used to silence background noise when no signal is present. In the other versions, its default setting is set to “Squelch.”

## ⑪ CLAR/IF SHIFT Key

Pressing this key activates the Receiver Clarifier feature. When this feature is activated, the **CLAR** knob is used to set a tuning offset of up to  $\pm 9.99$  kHz. The transmitter's frequency is not affected by the setting of the Clarifier.

Press and hold this key for one second to activate the IF Shift feature, which allows you to use the **MEM/VFO CH** knob to adjust the center frequency of the IF filter's passband response.



# FRONT PANEL CONTROL & SWITCHES

## ⑫ CLAR Knob

This knob tunes the clarifier offset frequency up to  $\pm 9.99$  kHz, when the Receiver Clarifier feature is activated by pressing the **CLAR/IF SHIFT** key.

## ⑬ BAND(DWN)/BAND(UP) Key

Pressing either of these keys momentarily will cause the frequency to be moved up or down by one frequency band. The selections available are:

... 1.8 MHz  $\leftrightarrow$  3.5 MHz  $\leftrightarrow$  7.0 MHz  $\leftrightarrow$  10 MHz  $\leftrightarrow$  14 MHz  $\leftrightarrow$  15 MHz  $\leftrightarrow$  18 MHz  $\leftrightarrow$  24 MHz  $\leftrightarrow$  28 MHz  $\leftrightarrow$  50 MHz  $\leftrightarrow$  88 MHz  $\leftrightarrow$  108 MHz  $\leftrightarrow$  144 MHz  $\leftrightarrow$  430 MHz  $\leftrightarrow$  1.8 MHz ...

Recalling the 5 MHz band (U.S. model) requires different procedure. See page 23 for details.

## ⑭ MEM/VFO CH Knob

This detented rotary switch is used for VFO frequency tuning, memory selection, and function selection for the [A], [B], [C] keys of the transceiver.

## ⑮ DSP Button

Pressing this button momentarily provides instant access to Multi Function Row "p" (MFp), which contains the command key for the receiver's Digital Signal Processing system. The available functions will appear as the functions displayed above the [A], [B], and [C] keys, as described previously.

## ⑯ HOME Key

Pressing this key momentarily recalls a favorite "Home" frequency memory.

## ⑰ V/M Key

Pressing this key switches frequency control between the VFO and Memory Systems.

## ⑱ MODE(◀)/MODE(▶) Key

Pressing either of these keys momentarily will change the operating mode. The selections available are:

... USB  $\leftrightarrow$  LSB  $\leftrightarrow$  CW  $\leftrightarrow$  CWR  $\leftrightarrow$   $\leftrightarrow$  AM  $\leftrightarrow$  DIG  $\leftrightarrow$  PKT  $\leftrightarrow$  USB ...

## ⑲ DSP Indicator

This indicator glows green when the DSP feature is activated.

## ⑳ TRANSMIT/BUSY Indicator

This indicator glows green when the squelch opens, and turns red during transmit.

## ㉑ CW-T Indicator

This indicator is a visual tuning indicator for CW reception, which glows green in synchronization with a signal tuned to the center of the IF passband during CW reception.

## ㉒ BATT-A, BATT-B Indicator

These LEDs indicate the battery status for the optional **FNB-78** Ni-MH battery pack while internal battery operation.

The LED glows green when the battery pack is waiting (switch to off by the **A-B** switch on the top panel), and turns orange when the is the battery pack on the radio operate the corresponded battery pack by the **A-B** switch on the top panel. When the battery voltage is approaching the value which indicates depletion is near, the LED blinks orange, indicating it is time to replace the batteries.

## LCD Details

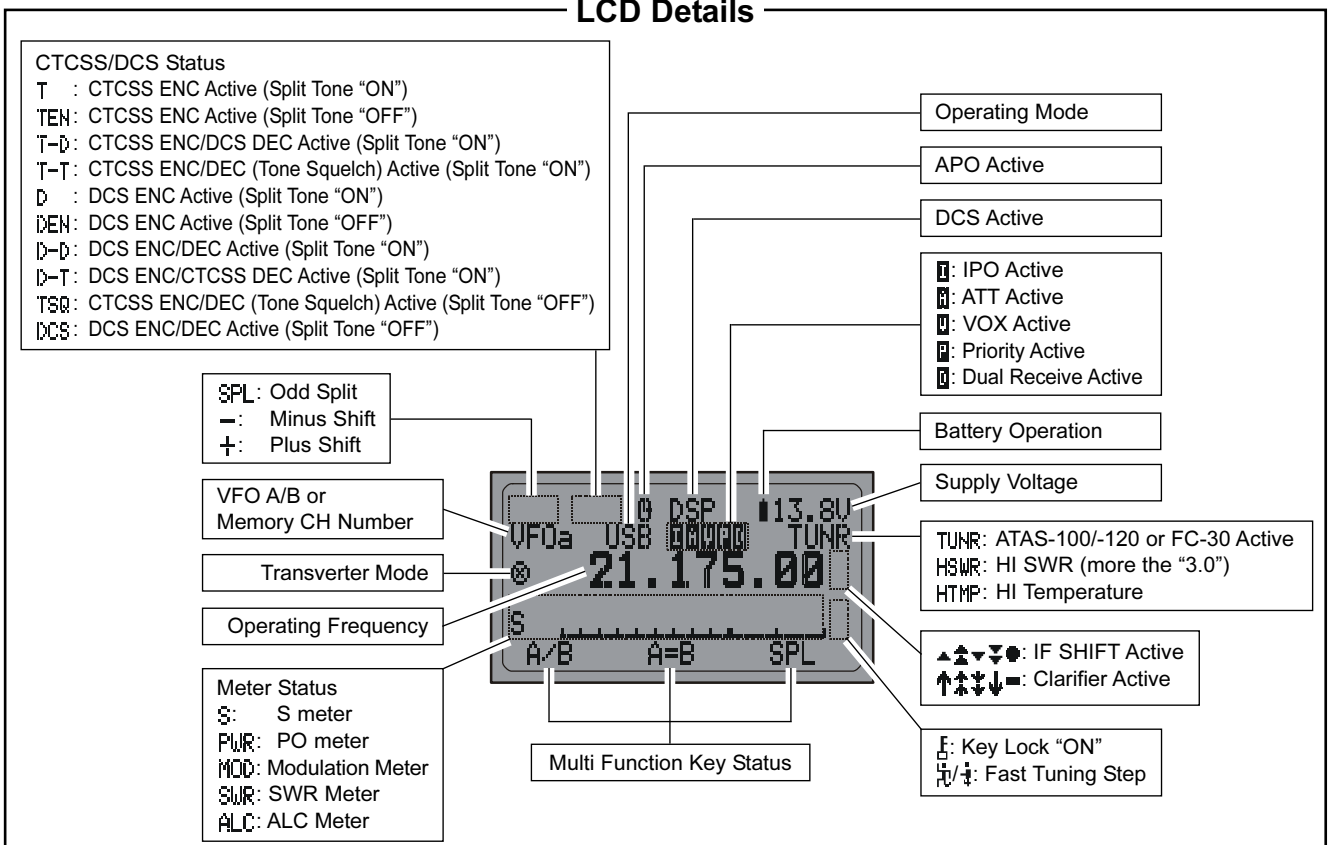

# FRONT PANEL CONTROL & SWITCHES

The [A], [B], and [C] keys select many of the most important operating features of the transceiver. When you press the [F] key, then rotate the **MEM/VFO CH** knob, the current function of that key will appear above each of the [A], [B], and [C] keys (along the bottom of the LCD). You may scroll the display through 17 rows of functions available for use via the [A], [B], and [C] keys.

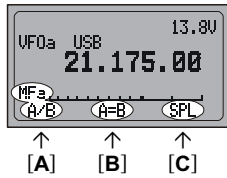
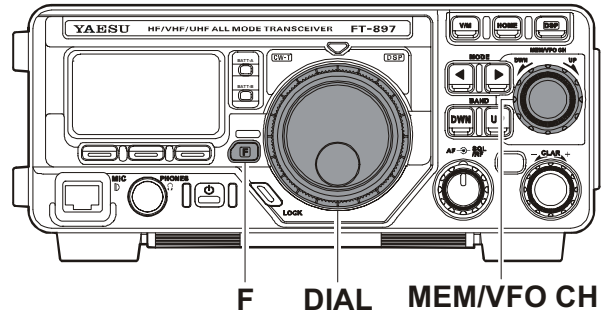

Multi Function Row "a" (MFa) [A/B, A=B, SPL]	
	[A] Key: A/B Press the [A](A/B) key to switch between VFO-A and VFO-B on the display.
	[B] Key: A=B Press the [B](A=B) key to copy the contents of Main VFO to be copied into the Sub VFO, so that the two VFO's contents will be identical.
	[C] Key: SPL Press the [C](SPL) key to activate Split frequency operation between VFO-A and VFO-B.



Multi Function Row "b" (MFb) [MW, SKIP, TAG]	
	[A] Key: MW Press and hold in the [A](MW) key for one second to transfer the contents of the VFO into a Memory register.
	[B] Key: SKIP Press the [B](SKIP) key to designate the current Memory channel to be "skipped" during scanning.
	[C] Key: TAG Press the [C](TAG) key to select the display type (Frequency or Alpha-numeric Tag) during Memory operation.



Multi Function Row "c" (MFc) [STO, RCL, PROC]	
	[A] Key: STO Press the [A](STO) key to store the contents of the VFO into the QMB (Quick Memory Bank) register.
	[B] Key: RCL Press the [B](RCL) key to recall the QMB Memory.
	[C] Key: PROC Press the [C](PROC) key to activate the speech processor for SSB and AM transmission. Press and hold in the [C](PROC) key for one second to recall Menu Mode No-074 [PROC LEVEL] (for setting the compression level of the AF Speech Processor).



Multi Function Row "d" (MFd) [RPT, REV, VOX]	
	[A] Key: RPT Press the [A](RPT) key to select the direction of the uplink frequency shift (+, -, or simplex) during FM repeater operation. Press and hold in the [A](RPT) key for one second to recall Menu Mode No-076 [RPT SHIFT] (for setting the shift frequency offset).
	[B] Key: REV Press the [B](REV) key to reverse the transmit and receive frequencies while working through a repeater.
	[C] Key: VOX Press the [C](VOX) key enable the VOX (voice-operated transmitter switching system) in the SSB, AM, and FM modes. Press and hold in the [C](VOX) key for one second to recall Menu Mode No-088 [VOX GAIN] (for setting the VOX gain level).





# FRONT PANEL CONTROL & SWITCHES

## Multi Function Row “e” (MFe) [TON, —, TDCH] ([ENC, DEC, TDCH])

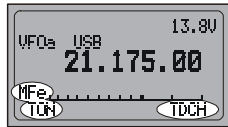

↑ [A]    ↑ [B]    ↑ [C]

### [A] Key: TON/ENC

Press the [A](TON) key to activate CTCSS or DCS operation on FM.

When the Split Tone feature is activated via Menu Mode No-079 [SPLIT TONE], this key function changes to “ENC” for activation of the CTCSS Encoder or DCS Encoder. Press the [A](ENC) key to activate the encoder.

Press and hold in the [A](TON/ENC) key for one second to recall Menu Mode No-083 [TONE FREQ] (for selecting the CTCSS tone frequency).

### [B] Key: —/DEC

Normally, this key does nothing.

When the Split Tone feature is activated via Menu Mode No-079 [SPLIT TONE], this key function changes to “DEC” to engage the DCS or CTCSS Decoder. Press the [B](DEC) key to activate the decoder.

Press and hold in the [B](DEC) key for one second to recall Menu Mode No-033 [DCS CODE] (for selecting the DCS code).

### [C] Key: TDCH

Press the [C](TDCH) key to initiate CTCSS Tone or DCS Search.

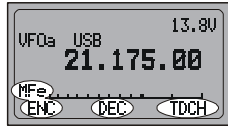

↑ [A]    ↑ [B]    ↑ [C]



## Multi Function Row “f” (Mf) [ARTS, SRCH, PMS]

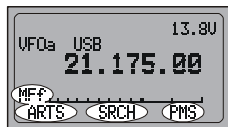

↑ [A]    ↑ [B]    ↑ [C]

### [A] Key: ARTS

Press the [A](ARTS) key to initiate the Auto-Range Transponder mode.

Press and hold in the [A](ARTS) key for one second to recall Menu Mode No-008 [ARTS BEEP] (for selecting the ARTS “Beep” option).

### [B] Key: SRCH

Press the [B](SRCH) key to activate the Smart Search feature.

Press the [B](SRCH) key to initiate Smart Search scanning.

### [C] Key: PMS

Press the [C](PMS) key to activate the Programmable Memory Scan feature.



## Multi Function Row “g” (MFg) [SCN, PRI, DW]

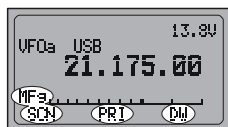

↑ [A]    ↑ [B]    ↑ [C]

### [A] Key: SCN

Press the [A](SCN) key to initiate the Scanning (in the direction of higher frequencies).

### [B] Key: PRI

Press the [B](PRI) key to activate the Priority Scan feature.

### [C] Key: DW

Press the [C](DW) key to activate the Dual Watch feature.



## Multi Function Row “h” (MFh) [SCOP, WID, STEP]

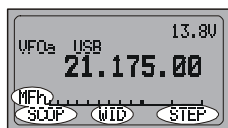

↑ [A]    ↑ [B]    ↑ [C]

### [A] Key: SCOP

Press the [A](SCOP) key to activate the Spectrum Scope Monitor feature.

Press and hold in the [A](SCOP) key for one second to initiate the Spectrum Scope.

### [B] Key: WID

Press the [B](WID) key to select the visible bandwidth for the Spectrum Scope Monitor.

Press and hold in the [B](WID) key for one second to select the operating mode for the Spectrum Scope Monitor.

### [C] Key: STEP

Press the [C](STEP) key to select the channel steps for Spectrum Scope Monitor.

Press and hold in the [C](STEP) key for one second to activate the **MAX HOLD** feature, which will display and hold the peak signal strength level for each channel.



# FRONT PANEL CONTROL & SWITCHES

## Multi Function Row “i” (MFi) [MTR, —, DISP]

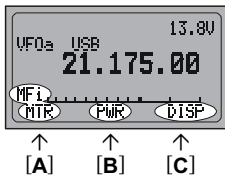

**[A] Key: MTR**  
Pressing the **[A]**(MTR) key repeatedly allows selection of the display function of the meter in the transmit mode.  
PWR → ALC → SWR → MOD → PWR ……  
The selected function will appear above the **[B]** key.  
Press and hold in the **[A]**(MTR) key for one second to recall Menu Mode No-062 [MTR PEAK HOLD] (for setting the “Peak-Hold” function of the meter).

**[B] Key**  
Pressing the **[B]** key repeatedly allows selection of the display function of the meter in the transmit mode.  
PWR → MOD → SWR → ALC → PWR ……

**[C] Key: DISP**  
Press the **[C]**(DISP) key to switch the display between the Large Character and Small Character modes.



## Multi Function Row “j” (MFj) [SPOT, BK, KYR]

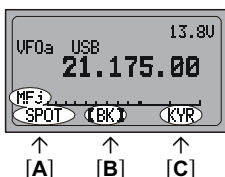

**[A] Key: SPOT**  
Press the **[A]**(SPOT) key to activate the CW spotting heterodyne oscillator.

**[B] Key: BK**  
Press the **[B]**(BK) key to disable the CW “Semi” break-in operation.  
Press and hold in the **[B]**(BK) key for one second to recall Menu Mode No-029 [CW SIDE TONE] (for setting the CW side tone volume level).

**[C] Key: KYR**  
Press the **[C]**(KYR) key to activate the built-in Electronic Keyer.  
Press and hold in the **[C]**(KYR) key for one second to recall Menu Mode No-030 [CW SPEED] (for setting the Keyer speed).



## Multi Function Row “k” (MFK) [TUNE, DOWN, UP]

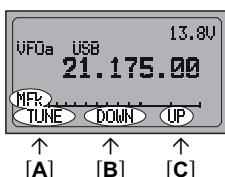

**[A] Key: TUNE**  
Press the **[A]**(TUNE) key to activate the optional **FC-30** Automatic Antenna Tuner or **ATAS-100/-120** Active-Tuning Antenna System.  
Press and hold in the **[A]**(TUNE) key for one second to initiate tuner or antenna retuning.

**[B] Key: DOWN**  
Press and hold in the **[B]**(DOWN) key to lower the **ATAS-100/-120** antenna manually.

**[C] Key: UP**  
Press and hold in the **[C]**(UP) key to raise the **ATAS-100/-120** antenna manually.



## Multi Function Row “l” (MFl) [NB, AGC, —]

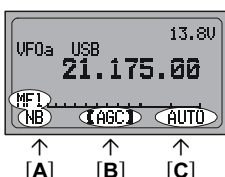

**[A] Key: NB**  
Press the **[A]**(NB) key to activate the receiver’s IF Noise Blanker.  
Press and hold in the **[A]**(NB) key for one second to recall Menu Mode No-63 [NB LEVEL] (for setting of the NB level).

**[B] Key: AGC**  
Press the **[B]**(AGC) key to disable the receiver’s AGC system. Normally, the AGC should be left On.

**[C] Key**  
Press the **[C]** key to select the recovery time (Slow, Fast, or Auto) for the receiver’s AGC system.

## Multi Function Row “m” (MFm) [IPO, ATT, NAR]

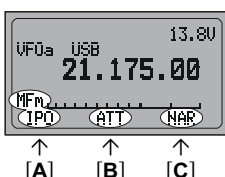

**[A] Key: IPO**  
Press the **[A]**(IPO) key to bypass the receiver preamplifier, thereby activating Intercept Point Optimization for improved overload characteristics while operating on the HF and 50 MHz bands.  
The IPO feature does not function on 144/430 MHz.

**[B] Key: ATT**  
Press the **[B]**(ATT) key to engage the receiver front-end attenuator, which will reduce all signals and noise by approximately 10 dB.  
The ATT feature does not function on 144/430 MHz.

**[C] Key: NAR**  
Press the **[C]**(NAR) key to select the low-deviation mode required for HF FM operation on 29 MHz.

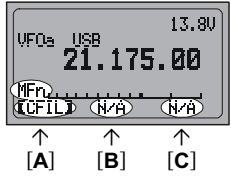

# FRONT PANEL CONTROL & SWITCHES

Multi Function Row “n” (MFn) [CFIL, —, —]	
	<p><b>[A] Key: CFIL</b> Press the <b>[A]</b>(CFIL) key to select the 2.4 kHz ceramic IF filter.</p>
	<p><b>[B] Key</b> Press the <b>[B]</b> key to select the optional IF filter which is located on the “FIL-1” (Optional Filter 1) slot on the Main Unit. When an optional filter is not installed on the “FIL-1” slot, this key function is disabled, and its label is “N/A.”</p>
	<p><b>[C] Key</b> Press the <b>[C]</b> key to select the optional IF filter which is located on the “FIL-2” (Optional Filter 2) slot on the Main Unit. When an optional filter is not installed on the “FIL-2” slot, this key function is disabled, and its label is “N/A.”</p>

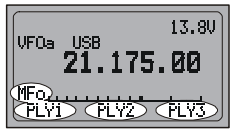

Multi Function Row “o” (MFo) [PLY1, PLY2, PLY3]	
	<p><b>[A] Key: PLY1</b> Press the <b>[A]</b>(PLY1) key to send the CW message which is memorized in BEACON TEXT 1.</p>
	<p><b>[B] Key: PLY2</b> Press the <b>[B]</b>(PLY2) key to send the CW message which is memorized in Keyer BEACON TEXT 2.</p>
	<p><b>[C] Key: PLY3</b> Press the <b>[C]</b>(PLY3) key to send the CW message which is memorized in Keyer BEACON TEXT 3.</p>

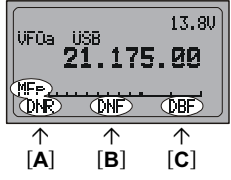

Multi Function Row “p” (MFp) [DNR, DNF, DBF]	
	<p><b>[A] Key: DNR</b> Press the <b>[A]</b>(DNR) key to activate the DSP Noise Reduction system. Press and hold in the <b>[A]</b>(DNR) key for one second recall Menu Mode No-049 [DSP NR LEVEL] (for setting the degree of DSP Noise Reduction).</p>
	<p><b>[B] Key: DNF</b> Press the <b>[B]</b>(DNF) key to activate the DSP’s Auto Notch Filter.</p>
	<p><b>[C] Key: DBF</b> Press the <b>[C]</b>(DBF) key to activate the DSP’s receiver Bandpass Filter. In the SSB, AM, FM, and AFSK modes, press and hold in the <b>[C]</b>(DBF) key for one second to recall Menu Mode No-047 [DSP LPF CUTOFF] (for adjusting the high-frequency cutoff of the DSP Bandpass Filter). In the CW mode, press and hold in the <b>[C]</b>(DBF) key for one second to recall Menu Item No-045 [DSP BPF WIDTH] (for setting the CW bandwidth).</p>

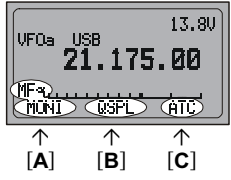

Multi Function Row “q” (MFq) [MONI, QSPL, ATC]	
	<p><b>[A] Key: MONI</b> Press the <b>[A]</b>(MONI) key to disable the Noise Squelch. You may program the configuration of this key by the Menu Mode No-065 [PG A].</p>
	<p><b>[B] Key: QSPL</b> Press the <b>[B]</b>(QSPL) key to change the Sub VFO frequency (Main VFO frequency + 5 kHz) and automatically engage the “Split” feature. You may program the configuration of this key by the Menu Mode No-066 [PG B].</p>
	<p><b>[C] Key: ATC</b> Press the <b>[C]</b>(ATC) key to activate a 1750-Hz burst tone for 2 seconds when pressing the <b>PTT</b> switch while the channel is clear. You may program the configuration of this key by the Menu Mode No-067 [PG C].</p>

# REAR PANEL CONNECTORS

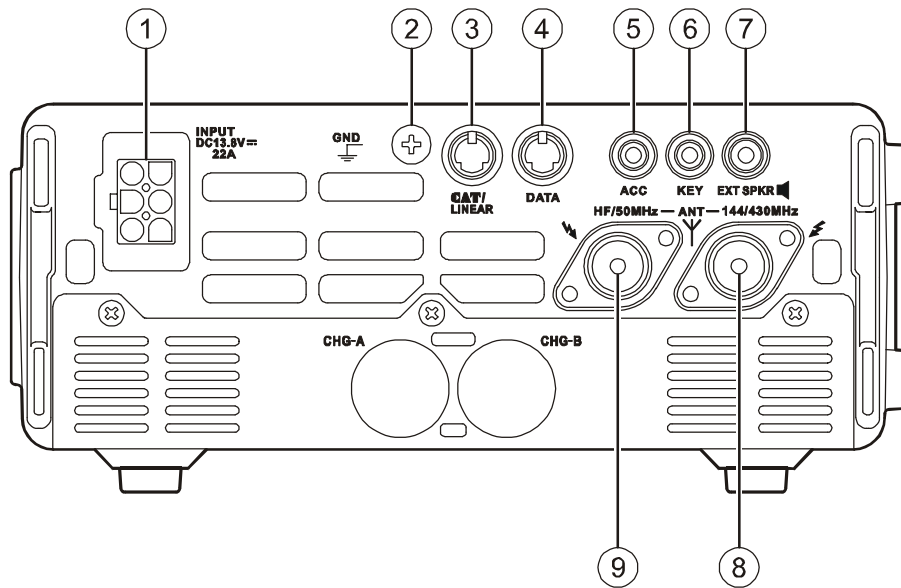

## ① INPUT Jack

This is the DC power supply connection for the transceiver, used when operating the transceiver with an external power supply. Use the supplied DC cable to connect this jack to the car battery or DC power supply, which must be capable of supplying at least 22A @ 13.8 VDC. For base station operation, the optional **FP-30** External AC power supply may be attached to the bottom of the transceiver and connect the output pigtail of the **FP-30** to this jack.

## ② GND Terminal

For best performance and safety, this Ground lug may be connected to a good earth ground using a short, heavy, braided cable.

## ③ CAT/LINEAR Jack

This 8-pin mini-DIN jack is used for connection to the **FC-30** External Automatic Antenna Tuner or **ATAS-100/-120** Active-Tuning Antenna System. It is also used for interfacing to a personal computer for control of the transceiver using the **CAT** system, and for interconnection to the **VL-1000** Linear Amplifier.



## ④ DATA Jack

This 6-pin, mini-DIN jack accepts AFSK input from a Terminal Node Controller (TNC); it also provides fixed-level Receiver Audio Output, Push-To-Talk (PTT), Squelch Status, and ground lines.

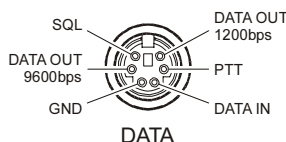

## ⑤ ACC Jack

This 3.5-mm 3-pin jack accepts external ALC (Automatic Level Control) voltage from a linear amplifier on the tip connection, and accepts a “Transmit Request” command on the ring connection. The main shaft is the ground return.

The “TX Request” connection, when shorted to ground, puts the **FT-897D** into the transmit mode, and sends out a steady CW carrier, for linear amplifier or manual antenna tuner adjustment.

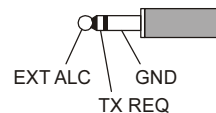

## ⑥ KEY Jack

This 3.5-mm, 3-pin jack is used for connection to a CW keyer paddle or a straight key.

## ⑦ EXT SPKR Jack

This 3.5-mm, 2-pin jack provides variable audio output for an external speaker. The audio output impedance at this jack is 4 Ω ~ 16 Ω and the level varies according to the setting of the front panel’s **AF** control.

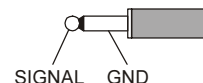

## ⑧ 144/430 MHz Antenna Jack

Connect your 144 and/or 430 MHz antenna’s 50 Ω coaxial cable to this M-type (“SO-239”) connector.

## ⑨ HF/50 MHz Antenna Jack

Connect your HF and/or 50 MHz antenna’s 50 Ω coaxial cable to this M-type (“SO-239”) connector.

# TOP & BOTTOM PANEL CONNECTORS

## Top Panel Switch

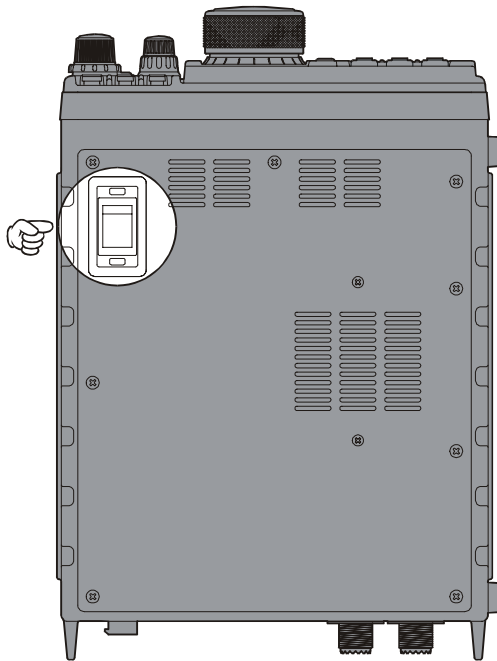

## Bottom Panel Connector

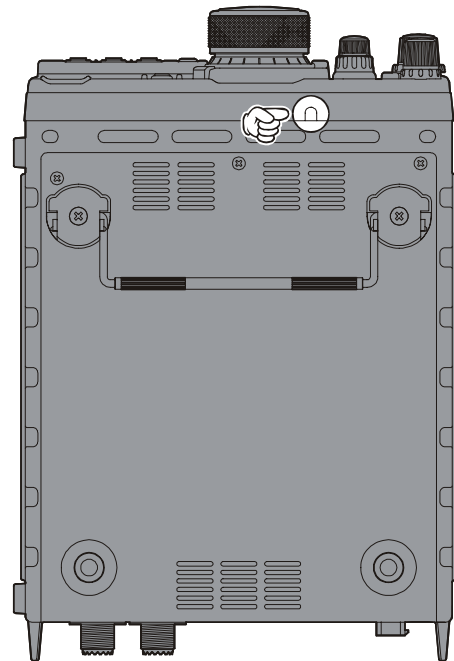

### A-B Switch

Selects the battery pack to be used, when you have installed *two* optional **FNB-78** Ni-MH battery packs into the **FT-897D**.

### METER Jack

This 3.5-mm 2-pin jack is used for connection to an analog meter (not produced by Vertex Standard). Please refer to the MENU No-060 and No-061.

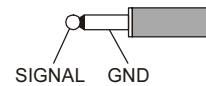

# OPERATION



Hi! I'm R.F. Radio, and I'm here to guide you through the fine points of the setup and use of your new FT-897D. I know you're anxious to get on the air, but I encourage you to read the "Operation" section of this manual as thoroughly as possible, so you'll get the most out of this fantastic new rig. Now... let's get operating!

## TURNING THE TRANSCEIVER ON AND OFF

- To turn the transceiver on, press and hold in the **POWER** switch for one second.
- To turn the transceiver off, again press and hold in the **POWER** switch for one second.

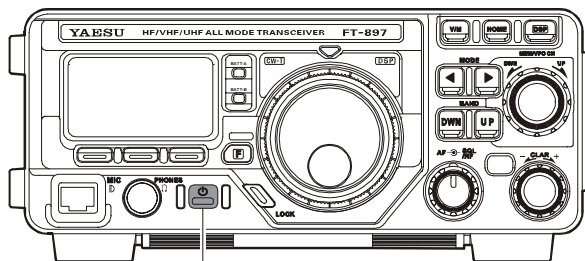

POWER

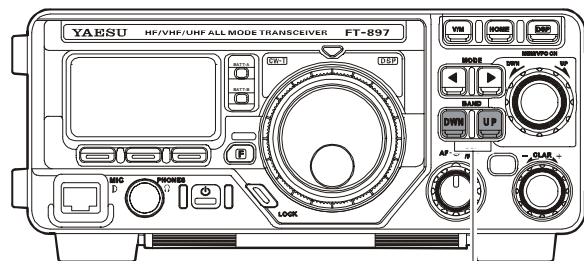

BAND



When you are operating the FT-897D with the optional FP-30 External power supply, always turn on the MAIN switch on the FP-30 before turning on the POWER switch on the FT-897D. When shutting down, please turn off the POWER switch on the FT-897D before turning off the MAIN switch on the FP-30.

## LCD Contrast

If you experience difficulty in reading the main display, try adjusting the LCD's contrast, using the Menu mode.

1. Press and hold in the [F] button for one second to activate the Menu mode.
2. Rotate the **MEM/VFO CH** knob to select Menu Mode No-042 [DISP CONTRAST].
3. Rotate the **DIAL** knob to adjust the contrast. As you make the adjustment, you will be able to see the effects of your changes.
4. When you have completed the adjustment, press and hold in the [F] button for one second to exit the Menu mode.

## OPERATING BAND SELECTION

This transceiver covers an incredibly wide frequency range, over which a number of different operating modes are used. Therefore, this transceiver's frequency coverage has been divided into different operating bands, each of which has its own pre-set frequency steps and operating modes. You can change the channel steps and operating mode once you get started, of course, per the next section.

To change the frequency band, press either the **BAND(DWN)** or **BAND(UP)** key to move to the next lower or higher operating band, respectively.

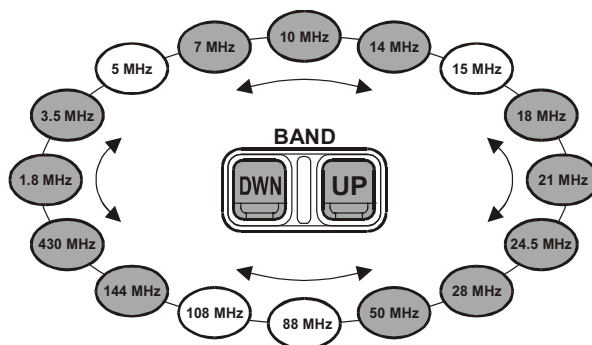

- 1) Recalling the 5 MHz band (U.S. model) requires different procedure. See page 23 for details.
- 2) VFOa and VFOb are independent VFOs, so they may be set to different bands. See the "Stacked VFO System" discussion on page 22 for details.

## Menu Quick Start

Many aspects of this transceiver's configuration may be customized using the convenient "Menu" system, which allow you to configure many "set and forget" settings just the way you want to. A full discussion of the Menu system begins on page 54; for now, here is a brief discussion on how to change Menu settings:

1. Press and hold in the [F] key for one second to enter the Menu mode.
2. Rotate the **MEM/VFO CH** knob to recall the Menu Item to be changed (for example, Menu Mode No-001 [EXT MENU], which Enables or Disables the "Extended Menu" Mode).
3. Rotate the **DIAL** knob to set this feature (in this example, the default setting is "OFF (Disabled)," so rotate the **DIAL** knob to set this feature to "ON" (Enabled).
4. Press and hold in the [F] key for one second to save the new setting and exit to normal operation.

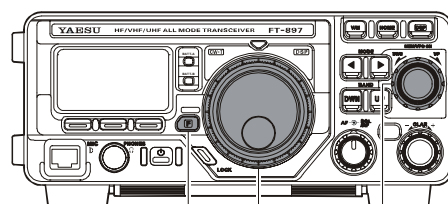

F DIAL MEM/VFO CH



If you have momentarily pressed the [F] key to enable the changing of the function of the Multi Function keys ([A], [B], and [C]) by the MEM/VFO CH knob.



## MODE SELECTION

Press either the **MODE**(◀) or **MODE**(▶) key to move among the eight settings for the operating modes, respectively.

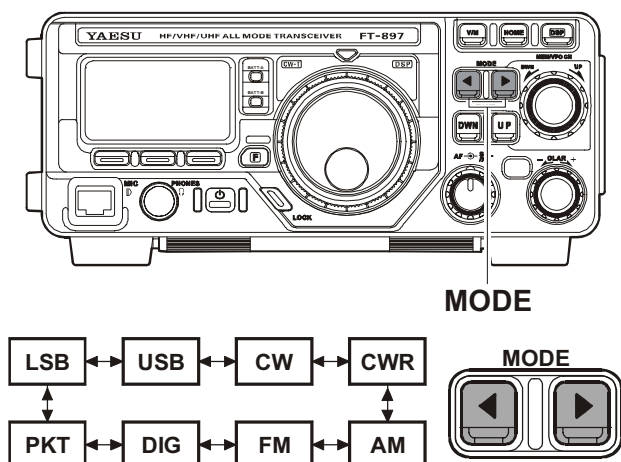

where “CWR” is “CW-Reverse,” using the opposite sideband from the “default” BFO injection sideband (in most cases, the default injection sideband is on the “USB” side); “DIG” is an AFSK-based Digital mode, set up per Menu Mode No-038 [DIG MODE]; and “PKT” represents either 1200 or 9600 bps FM packet.



*You can set VFOa and VFOb to different modes in the same band, allowing you to have a “Phone” VFO and a “CW” VFO, for example.*

## ADJUSTING THE AUDIO VOLUME LEVEL

Rotate the **AF** knob to set a comfortable listening level.

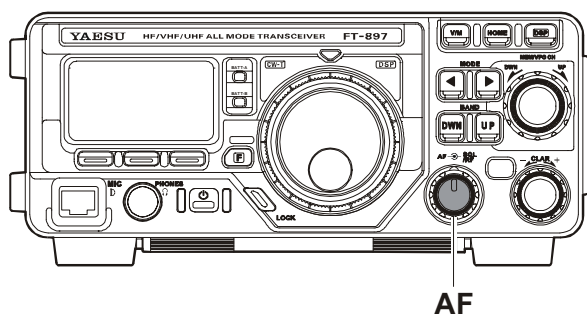

When operating in the “DIG” or “PKT” modes, you may set the AF knob to any comfortable setting, or even all the way off, because the output from the **DATA** jack is a fixed-level audio signal.



*Start with the AF knob set fully counter-clockwise, especially when using FM (the background noise on FM can be surprisingly loud)!*

## ADJUSTING THE RF GAIN AND SQUELCH

The **SQL/RF** Gain control is configured differently, depending on the country to which the **FT-897D** has been exported. In the U.S. version, the default function of this control is “RF Gain.” The configuration of the **SQL/RF** Gain control is set via Menu Mode No-080 [SQL/RF GAIN]; see page 62 for details.

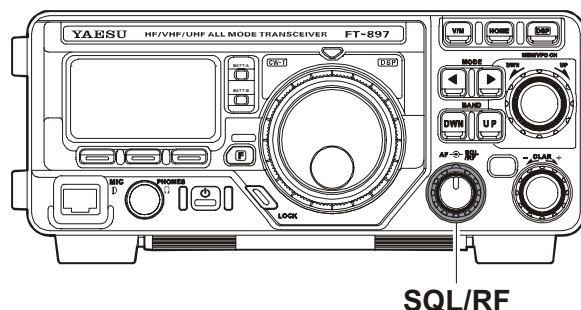

If your transceiver is configured for “RF Gain” use, rotating this control fully clockwise in the SSB/CW/Digital modes will provide best sensitivity. To reduce the receiver’s RF Gain somewhat, rotate this control counter-clockwise slightly. You will observe an increasing number of bars on the S-meter as you rotate the RF Gain control counter-clockwise; this indicates increasing AGC voltage, which is causing the front-end gain to be reduced. In the FM and Packet modes, this control will automatically be set to “Squelch,” even though the setting of Menu Mode No-080 [SQL/RF GAIN] is “RF Gain.” But if you set it this way, the **SQL/RF** control has no effect on FM.

More accurately, this should say:

In the FM and Packet modes, with “RF Gain” selected, the **FT-897D** goes into an “Auto Squelch” mode, with the Squelch level being preset at the factory.

If this control is configured for “SQL” operation, the **FT-897D**’s RF Gain will be set for maximum sensitivity in all modes, and the **SQL/RF** Gain control will function solely as a Squelch control. In this case, rotate the **SQL/RF** Gain control to the point where the background noise is just silenced; this will provide the best sensitivity to weak signals, while keeping the receiver quiet when no signal is received. The LED just above the Main Dial will glow Green when the squelch is opened by an incoming signal or noise.



*Battery consumption is significantly reduced if the receiver is squelched, as the audio amplifier stage is shut off when the receiver is muted.*

# OPERATION

## SETTING THE OPERATING FREQUENCY

1. In the “SSB/CW/DIG” modes, rotate the **DIAL** knob to set the frequency. Clockwise rotation of the **DIAL** increases the operating frequency.
2. In the “AM/FM/PKT” modes, rotate the **MEM/VFO CH** knob to set the frequency. Clockwise rotation of the **MEM/VFO CH** increases the operating frequency.
3. You may also use the **MEM/VFO CH** knob to adjust the operating frequency in the “SSB/CW/DIG” modes. The **MEM/VFO CH** knob provides faster tuning, ideal for making quick changes in frequency when you want to move across the band in a hurry. You can then use the **DIAL** knob to make fine frequency adjustments.

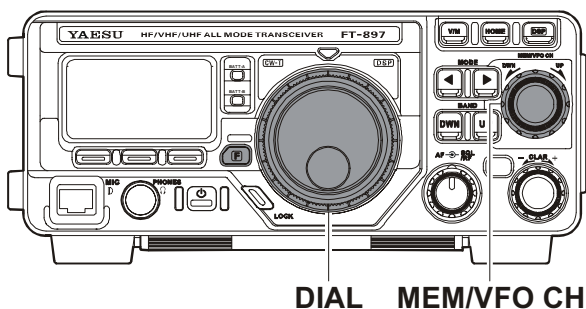

The synthesizer steps for the **MEM/VFO CH** knob may be adjusted independently by mode. Use Menu Mode No-006 [AM STEP] for AM, No-052 [FM STEP] for FM, and No-082 [SSB STEP] for SSB/CW/Digital. See pages 56, 59, and 62 for details.

If you press the **MEM/VFO CH** knob momentarily, then rotate the **MEM/VFO CH** knob, you can now change the operating frequency in 1 MHz steps, allowing very quick frequency excursions. This can be particularly helpful on the VHF and UHF bands.

In step 2 above, it was mentioned that tuning in the “AM/FM/PKT” modes is accomplished using the **MEM/VFO CH** knob. By default, the **DIAL** is disabled in these modes; if you wish to enable the **DIAL** in these modes, use Menu Mode No-004 [AM&FM DIAL]; see page 56.

 *The main **DIAL** synthesizer’s tuning rate (the number of steps per rotation of the **DIAL**) can be adjusted using Menu Mode No-035 [DIAL STEP]. See page 58 for details.*

## STACKED VFO SYSTEM

Press the [**F**] key momentarily, then rotate the **MEM/VFO CH** knob, as needed, until Multi Function Row “a” [A/B, A=B, SPL] appears on the display.

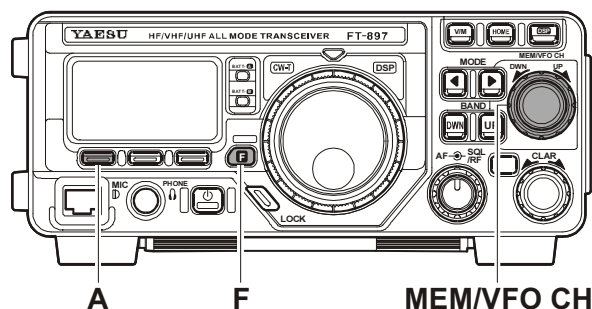



Now press the [**A**](A/B) key to toggle between the “A” and “B” VFOs. There are two such VFOs provided on each Amateur band, so you may set VFO-A to the CW sub-band, and VFO-B to the SSB sub-band, if you like. The operating mode will be preserved, along with the frequency information, on each VFO.

 *When changing bands on either the “A” or “B” VFO, the two VFOs do not change bands together. This facilitates split-band operation, such as on FM satellites.*

## CHANGING THE DIAL SPEED

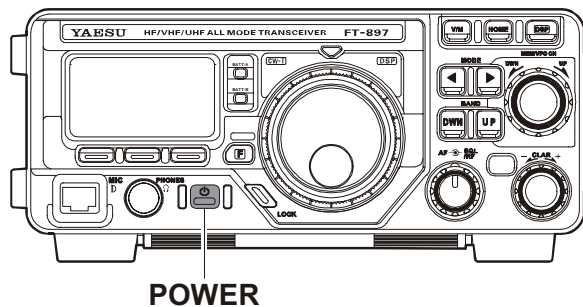
By default, the **FT-897D** begins operation in the “fine tuning” mode for the main tuning dial. However, a faster tuning rate may be selected, for quick navigation up and down the band.



To engage the “Fast Tuning” mode, just press the **POWER** switch momentarily while the transceiver is on. You will observe a small “” icon in the bottom right-hand corner of the LCD, and as you rotate the main tuning dial you will notice that the tuning rate has increased significantly. Press the **POWER** switch momentarily once more to return to the “Slow Tuning” mode (the small “” will disappear).



## OPERATION ON 5 MHz BAND (U.S. VERSION ONLY)

The **FT-897D** includes the capability for transmission and reception on the five spot frequencies assigned to the Amateur Service in the United States. To operate on the 5 MHz band:

1. Press the **V/M** key once to enter the “Memory” mode (a memory channel number “M-*nnn*” will appear on the display in the space previously occupied by “VFOa” or “VFOb”).

2. Memory channels “M-601” through “M-605” are pre-programmed, at the factory, with the permitted frequencies in the 5 MHz band, and the USB mode is automatically selected on these channels.

CH No.	FREQUENCY
M-601	5.332 MHz
M-602	5.348 MHz
M-603	5.368 MHz
M-604	5.373 MHz
M-605	5.405 MHz

If you have partitioned your memory channels into Memory Groups via Menu Mode No-055 [MEM GROUP], the memory channel numbers for 60-meter operation will be displayed as “MI-001” ~ “MI-005.” See page 45 for details regarding Memory Group operation, and page 60 for details regarding Menu Mode No-055 [MEM GROUP].

3. To exit from 60-meter operation and return to the VFO mode, just press the **V/M** key (the memory channel number will be replaced by “VFOa” or “VFOb”).



*The frequencies and operating mode for 5 MHz band operation are both fixed, and may not be changed.*

# RECEIVER ACCESSORIES

## LOCKING FRONT PANEL CONTROLS

The front panel **LOCK** button allows you to disable the **DIAL** and/or the front panel controls.

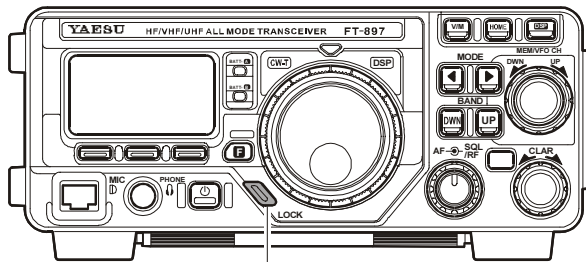

**LOCK**

In the transceiver's default configuration, pressing the **LOCK** button disables just the **DIAL**, while the other keys and switches are unaffected.

To lock out the remainder of the controls and the **MEM/VFO CH** knob, use Menu Mode No-054 [LOCK MODE];

1. Press and hold in the [F] key for one second to enter the Menu mode.
2. Rotate the **MEM/VFO CH** knob so as to recall No-054 [LOCK MODE].
3. Rotate the **DIAL** to select the desired configuration:
  - DIAL: Locks **DIAL** knob only.
  - FREQ: Locks front panel keys and knobs related to frequency control (such as **BAND(DWN)** and **BAND(UP)** key, [A](A/B) key., etc.)
  - PANEL: Locks all front panel keys and knobs (except **POWER** and **LOCK** keys)
  - ALL: Locks all front panel keys and knobs (except **POWER** and **LOCK** keys) and microphone keys.
4. When you have made your selection, Press and hold in the [F] key for one second to save the new setting and exit to normal operation.

When the controls are locked out, press the **LOCK** button once more to release them to normal operation.

## CLARIFIER (RECEIVER INCREMENTAL TUNING)

The Clarifier (RIT) allows you to set an offset of up to  $\pm 9.99$  kHz of the receive frequency relative to your transmit frequency. To achieve a wider offset than this, you may use the "Split" operating mode, described later.

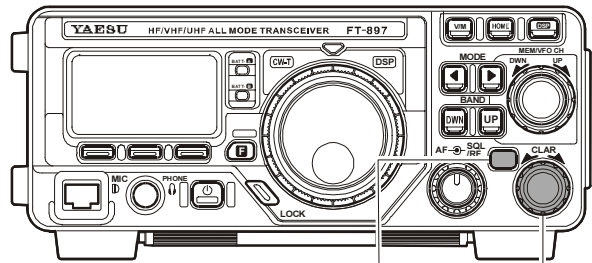

**CLAR/IF SHIFT CLAR**

1. Press the **CLAR/IF SHIFT** button momentarily to activate the Clarifier function.
2. Turn the **CLAR** knob, which allows the receiver frequency to be varied over a range of  $\pm 9.99$  kHz.
3. When the receiving frequency is higher than transmit frequency, the "↑ (within 1 kHz)" or "↑ (exceed 1 kHz)" icon will appear at the right of the frequency display. Similarly, when the receiving frequency is lower than transmit frequency, the "↓ (within 1 kHz)" or "↓ (exceed 1 kHz)" icon will appear at the right of the frequency display. When the receiving frequency is equal to transmit frequency (Clarifier offset is zero) while the Clarifier is activated, the "—" icon will appear at the right of the frequency display.
4. To turn the Clarifier off, again press the **CLAR/IF SHIFT** button momentarily. When you turn the Clarifier back on, the offset previously stored will still be applied.
5. To reset the Clarifier offset to zero, turn the Clarifier off, then turn the **DIAL** by any amount. The Clarifier will reset to zero after the first "step" of the **DIAL**.

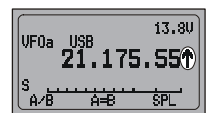
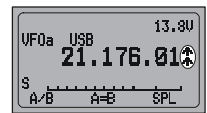

[TX<RX (within 1 kHz)]

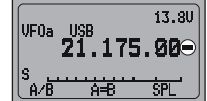

[TX=RX (Simplex)]

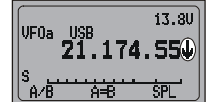

[TX>RX (within 1 kHz)]



[TX>RX (exceed 1 kHz)]



- 1) If you leave the Clarifier on, moving the **DIAL** will not cause the offset to be cancelled.
- 2) You may change the knob that controls the Clarifier offset from the **DIAL** to the **MEM/VFO CH** knob via Menu Mode No-021 [CLAR DIAL SEL].

## IF SHIFT

The receiver's IF SHIFT feature is an effective interference-reduction tool, which allows you to shift the passband response higher or lower without changing the pitch of the incoming signal.

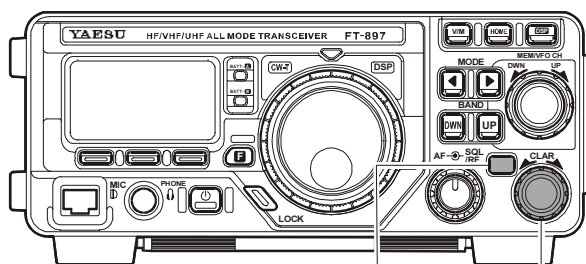

**CLAR/IF SHIFT CLAR**

1. Press and hold in the **CLAR/IF SHIFT** button for one second to activate the IF SHIFT feature. An icon, such as “●”, “▲ (slightly shifted to the upper side),” “▲ (more shifted to the upper side),” “▼ (slightly shifted to the lower side),” or “▼ (more shifted to the lower side)” icon will appear at the right of the frequency display to indicate the IF SHIFT's current position.
2. Rotate the **CLAR** knob, as needed, to reduce or eliminate the interference.
3. To turn the IF SHIFT feature off, again press and hold in the **CLAR/IF SHIFT** button for one second. The last setting of the IF SHIFT control will be retained until you change it again.

If you wish to make a more permanent shift in the receiver's IF passband, use Menu Mode No-015 [CAR LSB R] (for LSB mode) or No-017 [CAR USB R] (for USB mode). This allows you to set up a higher or lower listening pitch, if you prefer such as compared to the default passband response. See page 57.

## AGC (AUTOMATIC GAIN CONTROL)

The receiver recovery time constant of the AGC system may be modified to match your operating needs.

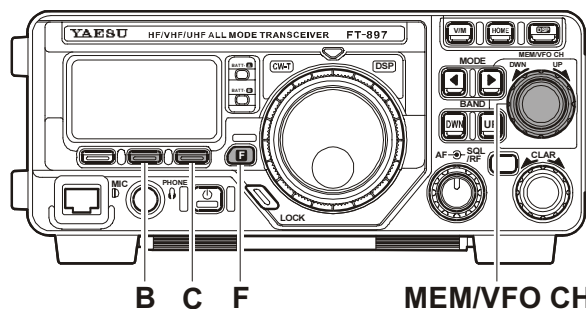

1. Press the **[F]** key momentarily, then rotate the **MEM/VFO CH** knob, as needed, until Multi Function Row “I” [NB, AGC, AUTO] appears on the display.
2. Press the **[C]** key to toggle the AGC recovery time constant among the following selections:  
 AUTO ⇨ FAST ⇨ SLOW ⇨ AUTO ⇨  
 where “AUTO” represents “FAST” on CW and DIG (AFSK), and “SLOW” on the voice modes.



*If you disable the AGC by pressing the **[B]**(AGC) key (to make the parentheses disappear), the **S-meter** (which monitors AGC voltage) will cease to function. Depending on the setting of the RF Gain control, incoming signals will probably be distorted if the AGC is turned off.*

# RECEIVER ACCESSORIES

## NOISE BLANKER

The IF Noise Blanker may be useful in reducing or eliminating some types of impulse noise, especially noise generated by automotive ignition systems.

1. Press the **[F]** key momentarily, then rotate the **MEM/VFO CH** knob, as needed, until Multi Function Row “I” [NB, AGC, OFF] appears on the display.
2. Press the **[A](NB)** key to activate the Noise Blanker. Parentheses will appear on both sides of the “NB” selection, indicating that the Noise Blanker is now on.
3. To adjust the blanking level, press and hold in the **[A](NB)** key for one second. This instantly activates Menu Mode No-063 [NB LEVEL], which allows adjustment of Noise Blanking Level. Rotate the **DIAL** knob to set a higher or lower blanking level (on a scale of 0 to 100). When done, press and hold in the **[F]** key for one second to save the new setting and return to normal operation.
4. Press the **[A](NB)** key again to turn the Noise Blanker off.

## IPO (INTERCEPT POINT OPTIMIZATION)

The IPO feature bypasses the receiver RF preamplifier, thereby eliminating the preamp’s gain. This feature is not available on the 144 MHz and 430 MHz bands.

1. Press the **[F]** key momentarily, then rotate the **MEM/VFO CH** knob, as needed, until Multi Function Row “m” [IPO, ATT, NAR] appears on the display.
2. Press the **[A](IPO)** key to bypass the receiver input preamplifier. Parentheses will appear on both sides of the “IPO” selection, and the “” icon will appear on the display, indicating that the preamp is now disengaged from the receiver circuit.
3. Press the **[A](IPO)** key once more to re-activate the preamp.



*On the bands below 14 MHz, the input preamplifier is rarely necessary, and activation of the IPO feature will provide substantial protection against intermodulation and other problems associated with strong signal input to the receiver. Rule of thumb: so long as the S-meter is moving on background noise, additional front-end gain is not necessary.*

## ATT (FRONT END ATTENUATOR)

The Attenuator will reduce all signals (and noise) by 10 dB, and it may be used to make reception more pleasant under extremely noisy conditions. This feature is not available on the 144 MHz and 430 MHz bands.

1. Press the **[F]** key momentarily, then rotate the **MEM/VFO CH** knob, as needed, until Multi Function Row “m” [IPO, ATT, NAR] appears on the display.
2. Press the **[B](ATT)** key to activate the Attenuator. Parentheses will appear on both sides of the “ATT” selection, and the “” icon will appear on the display.
3. Press the **[B](ATT)** key once more to switch the Attenuator out of the receiver front end circuit. Signals will again be received at a level 10 dB louder than was the case when the Attenuator was engaged.

## DSP BANDPASS FILTER

In the SSB mode, the receiver’s selectivity may be enhanced via the DSP Bandpass Filter.

1. Press the **[DSP]** key momentarily. This instantly activates Multi Function Row “p” [DNR, DNF, DBF].
2. Press the **[C](DBF)** key to activate the DSP Bandpass Filter. Parentheses will appear on both sides of the “DBF” selection, and the “**DSP**” will appear at the center top on the display. You will notice a decrease in both background noise and interference, if any is present.
3. The bandwidth of the DSP filter may be modified, to customize the bandwidth to your operating needs. To adjust the Low-Cut and High-Cut characteristics of the DSP Bandpass Filter:
  - Press and hold in the **[C](DBF)** key for one second. This instantly activates Menu Mode No-047 [DSP LPF CUTOFF], which allows adjustment of the High-Cut (Low-Pass) filter.
  - Turn the **DIAL**, as desired, to adjust the high-frequency cutoff of the DSP Bandpass Filter.
  - Now rotate the **MEM/VFO CH** knob one click counter-clockwise to select Menu Mode No-047 [DSP HPF CUTOFF], which allows adjustment of the Low-Cut (High-Pass) filter.
  - Turn the **DIAL**, as desired, to adjust the low-frequency cutoff of the DSP Bandpass Filter.
  - When done, press and hold the **[F]** key for one second to save the new setting(s) and return to normal operation.
4. Press the **[C](DBF)** key once more to disable the DSP Bandpass Filter.

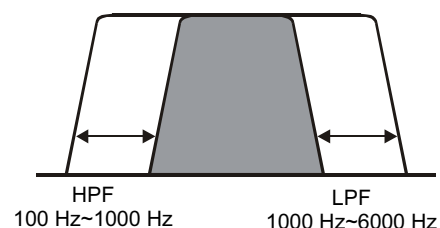

## DSP CW PEAKING FILTER

In the CW mode, pressing the [C](DBF) key in Multi Function Row “p” [DNR, DNF, DBF] activates a narrow-bandwidth peaking filter, which may be ideal for use under very crowded conditions. The DSP CW Peaking Filter also is especially helpful under VHF/UHF weak-signal situations.

The center frequency of the DSP CW Peaking Filter is automatically aligned to be centered on the response you have selected via the Menu Mode in item No-027 [CW PITCH]. See page 57 for details.

To change the bandwidth of the DSP CW Peaking Filter:

1. Press and hold in the [C](DBF) key for one second on the CW mode. This instantly activates Menu Mode No-045 [DSP BPF WIDTH], which allows selection of the bandwidth of the DSP CW Peaking Filter.
2. Rotate the **DIAL** to select the desired bandwidth. The available values are 60 Hz, 120 Hz, and 240 Hz (default value: 240 Hz).
3. When you have made your selection, press and hold in the [F] key for one second to save the new setting and return to normal operation.

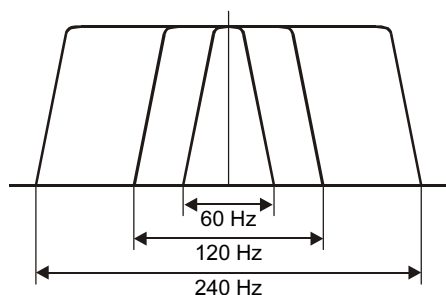

## DSP NOISE REDUCTION (NR)

The Noise Reduction feature of the DSP system may be used to enhance signal-to-noise ratio on weak signals.

1. Press the [DSP] key momentarily. This instantly activates Multi Function Row “p” [DNR, DNF, DBF].
2. Press the [A](DNR) key to activate the DSP Noise Reduction feature. “Parentheses” will appear on the both sides of the “DNR” indication, and the “DSP” will appear at the center top on the display.
3. Now press and hold in the [A](DNR) key for one second. This instantly activates Menu Mode No-049 [DSP NR LEVEL], which allows adjustment of the DSP Noise Reduction level.
4. Rotate the **DIAL** to find the point where best signal-to-noise ratio is obtained under the current noise conditions.
5. Press and hold in the [F] key for one second to save the new setting and exit to normal operation.
6. To turn off the DSP Noise Reduction feature, press the [A](DNR) key again.



*If noise is present at a level which causes indication on the S-meter, the performance of the Noise Reduction filter may be enhanced by rotating the SQL/RF (RF Gain) control in a counter-clockwise direction so as to set the (fixed) S-meter reading at the same level as the noise peaks. This adjustment raises the AGC threshold of the receiver.*

## DSP NOTCH FILTER

The DSP system’s Notch Filter may be helpful in removing one or more offending carrier or heterodyne signals from the audio passband.

1. Press the [DSP] key momentarily. This instantly activates Multi Function Row “p” [DNR, DNF, DBF].
2. Press the [B](DNF) key to activate the Notch Filter. “Parentheses” will appear on the both sides of the “DNF” indication, and the “DSP” will appear at the center top on the display. You will notice that the audio level of the carrier signal is now being reduced.
3. Press the [B](DNF) key once more to turn the Notch Filter off.



*Do not activate this filter in the CW mode, as incoming CW signals will be notched out of the audio passband!*

# RECEIVER ACCESSORIES

## AM/FM TUNING DIAL OPERATION

In the AM and FM modes, the **DIAL** knob is locked out (via the setting of Menu Mode No-004 [AM&FM DIAL]) so as to allow “channelized” tuning on these modes. To adjust the operating frequency, simply rotate the **MEM/VFO CH** knob.

If you wish to *enable* the **DIAL** for tuning in the AM and FM modes, change the setting of Menu Mode No-004 [AM&FM DIAL]. See page 56 for details.



*The “channelized” mode of tuning on AM and FM automatically rounds off the frequency to the next “logical” step when you rotate the **MEM/VFO CH** knob one “click” in either direction. This eliminates the inconvenience of having to preset the frequency to an “even” channel.*

## AUTOMATIC POWER-OFF FEATURE

The APO feature helps conserve battery life by automatically turning the transceiver off after a user-defined period of time within which there has been no dial or key activity. The available selections for the time before power-off are 1 ~ 6 hours, as well as “APO Off.” The default condition for the APO is OFF, and here is the procedure for activating it:

1. Press and hold the [**F**] key for one second to enter the Menu mode.
2. Rotate the **MEM/VFO CH** knob to recall Menu Mode No-007 [APO TIME].
3. Rotate the **DIAL** knob to select the desired time period after which the radio will automatically shut down.
4. Press and hold in the [**F**] key for one second to save the new setting and exit to normal operation.

Once you have programmed a time interval, the APO count-down timer will start whenever some front panel action (tuning, transmission, etc.) is completed.

When the APO is activated, the “” icon will appear at the center top on the LCD. If there is no action by you within the time interval programmed, the microprocessor will shut down the radio automatically.

Just press and hold in the **POWER** switch for one second to turn the transceiver back on after an APO shutdown, as usual.



*The APO feature will be disabled while using the Beacon or ARTS features, even if the APO feature is set to “ON.”*

---

---

## NOTE

---

---



# TRANSMITTER OPERATION

## SSB/AM TRANSMISSION

### Basic Setup/Operation

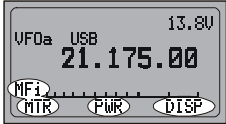
1. Press the **MODE**(◀) or **MODE**(▶) key so as to select either SSB (LSB/USB) or the AM mode. In the SSB mode, if you are operating on the 7 MHz or lower bands, select the LSB mode. If you are operating on the 14 MHz or higher bands, select the USB mode.
2. Press the **[F]** key momentarily, then rotate the **MEM/VFO CH** knob, as needed, until Multi Function Row “i” [MTR, PWR, DISP] appears on the display.
3. Now press the **[A]**(MTR) or **[B]** key to select the “ALC” meter function (“ALC” will appear above the **[B]** key). You may need to press the **[A]** or **[B]** key multiple times, as you will be toggling through several selections.
4. Press the microphone’s **PTT** switch, and speak into the microphone in a normal voice level while watching the meter. The ideal audio input level to the transmitter from the microphone will cause a few “segments” of indication on the ALC meter. Release the **PTT** switch to return to receive mode.
5. If the ALC meter is too high, or too low, you may need to reset the Microphone Gain:
  - Press and hold in the **[F]** key for one second to enter the Menu mode.
  - Rotate the **MEM/VFO CH** knob to recall Menu Mode No-081 [SSB MIC GAIN] (on SSB) or No-005 [AM MIC GAIN] (on AM).
  - Close the **PTT** switch, and while speaking into the microphone rotate the **DIAL** until the proper ALC indication is achieved on voice peaks.
  - When done, press and hold in the **[F]** key for one second to save the new setting for the Microphone Gain.



1) The AM carrier level is preset to 25 Watts during alignment at the factory, and should not require further adjustment. It is important to remember that AM transmission requires that power must be distributed among the carrier and voice sidebands; therefore, if excessive carrier power is used, there will be insufficient power available for the information-carrying voice sidebands.

2) The [TONE] switch on the back of the MH-31<sub>ASJ</sub> microphone provides adjustment of the microphone’s frequency response. Setting this switch to the “2” position will roll off some of the bass response, resulting in improved “talk power” in many instances. The “1” position is primarily used in countries like Japan, where vowel sounds are of critical importance in conveying information; in Western languages, consonant sounds (which are rich in high-frequency components) are frequently more important.

### VOX Operation

The VOX system provides automatic transmit/receive switching based on voice input to the microphone. With the VOX system enabled, you do not need to press the **PTT** switch in order to transmit.

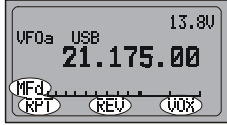
1. Press the **[F]** key momentarily, then rotate the **MEM/VFO CH** knob, as needed, until Multi Function Row “d” [RPT, REV, VOX] appears on the display.
2. Press the **[C]**(VOX) key to activate the VOX circuitry. “Parentheses” will appear on the both sides of the “VOX” indication, and the “**[C]**” icon will appear on the display.
3. **Without** pressing the **PTT** switch, speak into the microphone in a normal voice level. When you start speaking, the transmitter should be activated automatically. When you finish speaking, the transceiver should return to the receive mode (after a short delay).
4. To cancel VOX and return to **PTT** operation, again press the **[C]**(VOX) key. The parentheses and “**[C]**” icon will disappear, signifying that the VOX system has been turned off.
5. The VOX Gain may be adjusted, so as to prevent accidental transmitter activation in a noisy environment. To adjust the VOX Gain:
  - While still in Multi Function Row “d” [RPT, REV, VOX], press and hold in the **[C]**(VOX) key for one second. This is a “hot key” feature which will instantly recall Menu Mode No-088 [VOX GAIN].
  - While speaking into the microphone, rotate the **DIAL** to the point where the transmitter is quickly activated by your voice, without causing background noise to activate the transmitter.
  - When you have selected the optimum setting, press and hold the **[F]** key for one second to save the new settings and return to normal operation.
6. The “Hang-Time” of the VOX system (the transmit-receive delay after the cessation of speech) may also be adjusted via the Menu. The default delay is one second. To set a different delay time:
  - Press and hold in the **[F]** key for one second to activate the Menu mode.
  - Rotate the **MEM/VFO CH** knob to select Menu Mode No-087 [VOX DELAY].
  - Rotate the **DIAL** while saying a brief syllable like “Ah” and listening to the hang time, so as to set the desired delay.
  - When your adjustments are complete, press and hold in the **[F]** key for one second to save the new setting and return to normal operation.



The delay time for return to the receive mode is set independently on CW and voice modes; for CW, use Menu Mode No-024 [CW DELAY] (see next chapter).



## SSB/AM TRANSMISSION

### AF Speech Processor Operation

The AF Speech Processor increases your average power output while operating on SSB and AM modes.

1. Press the **[F]** key, as necessary, to recall Multi Function Row “c” [STO, RCL, PROC].
2. Press the **[C]**(PROC) key to activate the AF Speech Processor. “Parentheses” will appear on both sides of the “PROC” indication.
3. Now press the **PTT** key (unless you have VOX enabled), and speak into the microphone in a normal voice level, as usual.
4. To deactivate the AF Speech Processor, again press the **[C]**(PROC) key.
5. The Compression Level may be adjusted via the Menu, as follows:
  - While still in Operating Function “c” [STO, RCL, PROC], press and hold in the **[C]**(PROC) key for one second. This instantly recalls Menu Mode No-074 [PROC LEVEL].
  - Rotate the **DIAL** to set a new level of Compression (the default value is “50”).
  - When you have made your selection, press and hold the **[F]** key for one second to save your new setting and return to normal operation.
  - Make some on-the-air checks, or use a monitor receiver in your station, to ensure that good voice quality has been obtained via your adjustment.

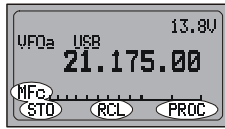

### DSP Microphone Equalizer

In the SSB, AM, and FM transmission modes, you may use the DSP system to change the frequency response of the audio stage. This will allow you to roll off excessive high-and/or low-frequency components of your voice’s audio characteristics.

To set up the DSP Microphone Equalizer feature:

1. Press and hold in the **[DSP]** key for one second. This instantly activates Menu Mode No-048 [DSP MIC EQ].
2. Rotate the **DIAL** to select one of the following equalization choices:
  - OFF: Microphone Equalization Off
  - LPF: High Cut (lower frequencies are emphasized)
  - HPF: Low Cut (higher frequencies are emphasized)
  - BOTH: High/Low Cut (mid-range frequencies are emphasized)
3. When you have made your selection, Press and hold in the **[F]** key for one second to save the new setting and exit to normal operation.



*Excessive advancement of the Compression Level may lead to distortion. Each operator’s voice pattern is different, so try several settings to find the one which is best for your voice.*

# TRANSMITTER OPERATION

## CW TRANSMISSION

### Operation using Straight Key/External Keying Device

When using a straight key, an *external* electronic keyer, or a computer-generated keying device, please follow the instructions in this section.

1. Insert your key's (*three-conductor*) plug into the rear-panel **KEY** jack.

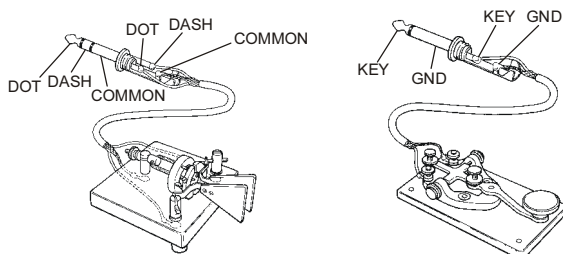

2. Press the **MODE**(◀) or **MODE**(▶) key, as needed, to select one of the CW modes (CW/CWR).

*The “CW” mode utilizes USB-side carrier injection, while the CWR (Reverse) mode utilizes LSB-side injection.*

3. When you close the key (or activate your computer-generated keying interface by whatever means), the transmitter will automatically be engaged. When you have finished sending, the receiver will return, after a brief delay (see next section).
4. The CW hang time can be adjusted using the Menu Mode. To adjust the CW hang time:
  - Press and hold in the **[F]** key for one second to enter the Menu mode.
  - Rotate the **MEM/VFO CH** knob to Menu Mode No-024 [CW DELAY].
  - Rotate the **DIAL** to select a longer or shorter delay time (default: 250 ms). If the delay selection is set to “FULL,” the transceiver will operate in the full break-in mode (allowing you to hear between the characters that are being sent).
  - When you have set the desired delay, press and hold in the **[F]** key for one second to save the new setting and exit to normal operation.
5. To practice your CW sending (without transmitting), press the **[B]**(BK) key to make the “Parentheses” disappear. Now, pressing the key will cause the CW sidetone to be heard, but your radio will not be transmitting a signal on the air.

6. You can adjust the CW sidetone volume level via Menu Mode No-029 [CW SIDE TONE]. To adjust the CW sidetone volume level:
  - While still in Multi Function Row “j” [SPOT, BK, KYR], press and hold in the **[B]**(BK) key for one second. This is a “hot key” feature which will instantly recall Menu Mode No-029 [CW SIDE TONE]
  - Rotate the **DIAL** to select a new level; on the arbitrary scale of “0” ~ “100,” the default value is “50.”
  - When done, press and hold in the **[F]** key for one second to save the new setting and exit to normal operation.
7. You also can adjust the CW sidetone pitch using Menu Mode No-027 [CW PITCH]. This adjustment also controls the BFO offset (actual pitch of your transmitted signal relative to your current receive frequency). To adjust the CW sidetone pitch:
  - Press and hold in the **[F]** key for one second to enter the Menu mode.
  - Rotate the **MEM/VFO CH** knob to Menu Mode No-027 [CW PITCH].
  - Rotate the **DIAL** to select a new pitch tone/BFO offset. The available offset range is 400 ~ 800 Hz (default value is “700 Hz”).
  - When done, press and hold in the **[F]** key for one second to save the new setting and exit to normal operation.
8. The **FT-897D** also has a “CW SPOT” feature, utilizing the sidetone. Because the sidetone is a representation of the actual pitch of your transmitted signal, it may be used for zeroing in on another station. To activate the CW SPOT tone, just press and hold in the **[HOME]** key for one second while in the CW mode.



*Pressing the **[A]**(SPOT) key while in Multi Function Row “j” [SPOT, BK, KYR] will also activate the CW SPOT tone.*

## CW TRANSMISSION

### Using the Built-in Electronic Keyer

The built-in Electronic Keyer provides a convenient method of generating CW. The Electronic Keyer includes weight and speed adjustments.

1. Connect your keyer paddle's cable to the **KEY** jack on the rear panel of the transceiver.
2. Press the **MODE**(◀) or **MODE**(▶) key, as needed, to select the desired CW mode (CW/CWR).
3. Press the **[F]** key momentarily, then rotate the **MEM/VFO CH** knob, as needed, until Multi Function Row "j" [SPOT, BK, KYR] appears on the display.
4. Press the **[C]**(KYR) key to activate the Electronic Keyer. "Parentheses" will appear on both sides of the "KYR" indication. Closing the contacts on your keyer paddle will now cause CW dots and/or dashes to be generated.
5. The keyer speed may be adjusted using the Menu Mode. To adjust the Keyer speed:
  - While still in Multi Function Row "j" [SPOT, BK, KYR], press and hold in the **[C]**(KYR) key for one second. This is a "hot key" feature which will instantly recall Menu Mode No-030 [CW SPEED].
  - Press the **MEM/VFO CH** knob if you wish to select display of "cpm" (characters per minute) instead of "wpm" (words per minute). The "cpm" selection is based on the international "PARIS" standard, which stipulates five characters per word.
  - Rotate the **DIAL** knob, while sending, to set the desired sending speed.
  - When done, press and hold in the **[F]** key for one second to save the new setting and exit to normal operation.

6. The Dot:Dash weighting ratio may be adjusted via Menu Mode. To adjust the Dot:Dash weighting ratio:
  - Press and hold in the **[F]** key for one second to enter the Menu mode.
  - Rotate the **MEM/VFO CH** knob to select Menu Mode No-032 [CW WEIGHT].
  - Rotate the **DIAL** knob to set the desired weight.
  - When done, press and hold in the **[F]** key for one second to save the new setting and exit to normal operation.

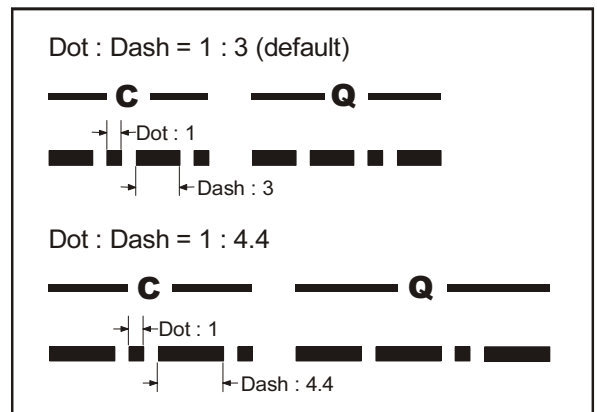

7. You may select "normal" or "reverse" paddle polarity via Menu Mode No-025 [CW KEY REV]. The default setting for this feature is "NORMAL," whereby the "Tip" connection on the Key Plug is "Dot" and the "Ring" connection is "Dash." To change the paddle polarity:
  - Press and hold in the **[F]** key for one second to enter the Menu mode.
  - Rotate the **MEM/VFO CH** knob to select Menu Mode No-025 [CW KEY REV].
  - Rotate the **DIAL** knob to select the new setting.
  - When done, press and hold in the **[F]** key for one second to save the new setting and exit to normal operation.

# TRANSMITTER OPERATION

## FM TRANSMISSION

### Basic Setup/Operation

1. Press the **MODE**(◀) or **MODE**(▶) key so as to select the FM mode.
2. Press the microphone's **PTT** switch, and speak into the microphone in a normal voice. Release the **PTT** switch to return to the receive mode.
3. If you get reports that your modulation level is too high or too low, you may need to adjust the FM-mode microphone gain. The procedure is similar to that used on SSB:
  - Press the **[F]** key momentarily, then rotate the **MEM/VFO CH** knob, as needed, until Multi Function Row "i" [MTR, PWR, DISP] appears on the display, then press the **[A]**(MTR) key to select the "Deviation" meter function ("MOD" will appear above the **[B]** key).
4. Press and hold in the **[F]** key for one second to enter the Menu mode.
5. Rotate the **MEM/VFO CH** knob to recall Menu Mode No-051 [FM MIC GAIN].
6. Rotate the **DIAL** to increase or decrease the setting of the FM Mic Gain, depending on the level correction required, then press and hold in the **[F]** key to save the new setting.
7. Close the **PTT** switch, and while speaking into the microphone observe the meter indication; the proper setting of the FM Mic Gain will produce eight "bars" of indication on voice peaks, slightly less on lower levels of speech input.
8. When done, press and hold in the **[F]** key to save the new setting for the FM-mode microphone gain.
9. The VOX feature is operational during FM transmission. From Multi Function Row "d" [RPT, REV, VOX], press the **[C]**(VOX) key to activate/deactivate VOX.

### Repeater Operation

1. Press the **[F]** key momentarily, then rotate the **MEM/VFO CH** knob, as needed, until Multi Function Row "d" [RPT, REV, VOX] appears on the display.
2. Press the **[A]**(RPT) key to activate repeater operation. One press of the **[A]**(RPT) key will have set the transceiver for "Minus Shift" operation. In this situation, you will observe the "-" indicator on the display. The transmitter frequency will be shifted down by a default value so as to access the repeater input frequency. If your repeater uses a positive shift (instead of negative), press the **[A]**(RPT) key again; the "+" indicator will replace the "-" indicator on the display. Set the transceiver's receiver to the repeater output (downlink) frequency. Close the **PTT** switch and speak into the microphone. You will observe that the transmitted frequency has shifted according to the setting of the **[A]**(RPT) key in the Multi Function Row "d" [RPT, REV, VOX]. Release the **PTT** switch to return to the Receive mode.
3. If the default repeater shift is not appropriate for the majority of the repeaters your area, it may be set independently for each band. To change the default repeater shift:
  - Press and hold in the **[A]**(RPT) key for one second. This instantly recalls Menu Mode No-076 [RPT SHIFT].
  - Rotate the **DIAL** knob to select the desired shift frequency.
  - When done, press and hold in the **[F]** key for one second to save the new setting and exit to normal operation.

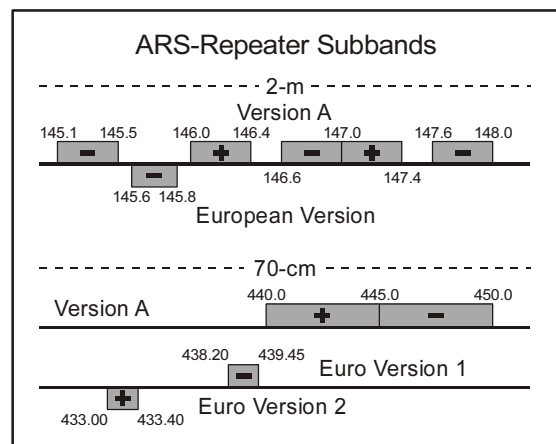

4. If your repeater uses controlled access (using either CTCSS or DCS), press the **[F]** key momentarily, then rotate the **MEM/VFO CH** knob one click clockwise to cause Multi Function Row "e" [TON, —, TDCH] to appear on the display. Now select the appropriate tone access system:
  - Press the **[A]**(TON) key to activate the CTCSS tone encoder, which provides a subaudible repeater access tone. One press of the **[A]**(TON) key will activate the CTCSS tone encoder. In this situation, you will observe the "TEN" indicator on the display. If

## FM TRANSMISSION

you press the **[A]**(TON) key repeatedly, you will observe “TSQ” (CTCSS Encode/Decode), “DEN” (Digital Coded Squelch, Encode), followed by “DCS” (Digital Coded Squelch, Encode/Decode). One additional press will disable all repeater-access tone systems. See the next section for a discussion of DCS operation.

- If the default repeater access tone is not appropriate for the repeater on which you are operating, it may be set easily:

1. Press and hold the **[A]**(TON) key for one second. This instantly recall Menu Mode No-083 [TONE FREQ].
2. Rotate the **DIAL** knob to select the desired CTCSS frequency.

CTCSS TONE FREQUENCY (Hz)							
67.0	69.3	71.9	74.4	77.0	79.7	82.5	85.4
88.5	91.5	94.8	97.4	100.0	103.5	107.2	110.9
114.8	118.8	123.0	127.3	131.8	136.5	141.3	146.2
151.4	156.7	159.8	162.2	165.5	167.9	171.3	173.8
177.3	179.9	183.5	186.2	189.9	192.8	196.6	199.5
203.5	206.5	210.7	218.1	225.7	229.1	233.6	241.8
250.3	254.1						

3. When done, press and hold the **[F]** key for one second to save the new setting and exit to normal operation.
5. With repeater shift activated, you can temporarily reverse the transmit and receive frequencies by pressing the **[B]**(REV) key in the Multi Function Row “d” [RPT, REV, VOX]. The “-” icon will blink while “Reverse” shift is activated. Press the **[B]**(REV) key again to revert to the “Normal” shift direction.
6. On many transceiver versions, the Automatic Repeater Shift (ARS) feature is enabled at the factory. This feature automatically activates the appropriate repeater shift when you are operating inside the designated 144 MHz or 430 MHz FM repeater sub-bands in your country. If you wish to change the On/Off settings for the ARS, use Menu Mode No-002 [144MHz ARS] or Menu Mode No-003 [430MHz ARS] (see page 56).



*If your local repeaters need a 1750-Hz burst tone for access (typically in Europe), press and hold in the front panel’s **[HOME]** key to transmit the burst tone (FM mode only).*

### Tone Search Scanning

In operating situations where you don’t know the CTCSS tone being used by another station, you can command the radio to listen to the incoming signal and scan in search of the tone being used. To scan for the CTCSS tone in use:

1. Press the **[F]** key momentarily, then rotate the **MEM/VFO CH** knob, as needed, until Multi Function Row “e” [TON, —, TDCH] appears on the display.
2. Press the **[A]**(TON) key to activate CTCSS Encoder/Decoder; (the “TSQ” icon will appear on the display)
3. Press the **[C]**(TDCH) key to start scanning for the incoming CTCSS tone.
4. When the radio detects the correct tone, it will halt on that tone, and audio will be allowed to pass
5. The CTCSS tone detected will be stored as the “current” tone, so it may be used for memory storage purposes, and you may now exit to normal operation.

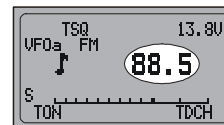

# TRANSMITTER OPERATION

## FM TRANSMISSION

### DCS Operation

Another form of tone access control is Digital Code Squelch, or DCS. It is a newer, more advanced tone system that is less susceptible to false triggering than CTCSS. A DCS Encoder/Decoder is built into your transceiver, and operation is very similar to that described above for CTCSS.

1. Press the **[F]** key momentarily, then rotate the **MEM/VFO CH** knob, as needed, until Multi Function Row “e” [TON, —, TDCH] appears on the display.
2. Press the **[A]**(TON) key four times to activate the DCS Encoder/Decoder (the “DCS” icon will appear on the display). The receiver will remain muted until a matching DCS code is received on an incoming signal.
3. Press and hold in the **[B]** key for one second. This instantly recalls Menu Mode No-033 [DCS CODE].
4. Rotate the **DIAL** to select the desired DCS code, then press and hold in the **[F]** key for one second to save new setting and exit to normal operation.

DCS CODE									
023	025	026	031	032	036	043	047	051	053
054	065	071	072	073	074	114	115	116	122
125	131	132	134	143	145	152	155	156	162
165	172	174	205	212	223	225	226	243	244
245	246	251	252	255	261	263	265	266	271
274	306	311	315	325	331	332	343	346	351
356	364	365	371	411	412	413	423	431	432
445	446	452	454	455	462	464	465	466	503
506	516	523	526	532	546	565	606	612	624
627	631	632	654	662	664	703	712	723	731
732	734	743	754						

5. Press the **[A]**(TON) key once to cancel DCS operation (the “DCS” icon will disappear).

### DCS Search Scanning

In operating situations where you don’t know the DCS code being used by another station, you can command the radio to listen to the incoming signal and scan in search of the code being used.

To scan for the DCS code in use:

1. Press the **[F]** key momentarily, then rotate the **MEM/VFO CH** knob, as needed, until Multi Function Row “e” [TON, —, TDCH] appears on the display.
2. Press the **[A]**(TON) key to activate DCS (the “DCS” icon will appear on the display).
3. Press the **[C]**(TDCH) key to start scanning for the incoming DCS code.
4. When the radio detects the correct DCS code, it will halt on that code, and audio will be allowed to pass.
5. The DCS code detected will be stored as the “current” code, so it may be used for memory storage purposes, and you may now exit to normal operation.

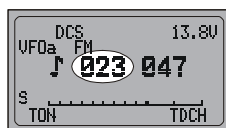

### Split Tone Operation

The **FT-897D** can be configured in a “Split Tone” configuration via the Menu mode.

This allows you to encode a CTCSS Tone, decode a DCS code, encode (only) a DCS code, etc.

1. Press and hold in the **[F]** key for one second to enter the Menu mode.
2. Rotate the **MEM/VFO CH** knob to select Menu Mode No-079 [SPLIT TONE].
3. Rotate the **DIAL** knob to select “ON” (to enable the Split Tone feature).
4. Press and hold in the **[F]** key for one second to save the new setting and exit to normal operation.

When the Split Tone feature is activated, the Multi Function Row “e” selection changes to [ENC, DEC, TDCH]. So, you can set the desired encoder (by pressing **[A]**(ENC) key, repeatedly, if necessary) and decoder (by pressing the **[B]**(DEC) key) separately.

When the Split Tone feature is activated, you can see the following additional parameters.

- T-T :Encodes a CTCSS Tone and Decodes a CTCSS Tone
- T-D :Encodes a CTCSS Tone and Decodes a DCS Code
- T :CTCSS Tone Encode only
- D :DCS Encode only
- D-T :Encodes a DCS Code and Decodes a CTCSS Tone
- D-D :Encodes a DCS Code and Decodes a DCS Code
  - D :DCS Decode only
  - T :CTCSS Tone Decode only

### Split Tone Frequency or DCS Code Setup

1. Press and hold in the **[A]**(ENC)(if you use CTCSS) or **[B]**(DEC)(if you use DCS) key for one second. This instantly recalls Menu Mode No-083 [TONE FREQ] or No-033 [DCS CODE].
2. Press the **MEM/VFO CH** knob momentarily, then rotate the **DIAL** knob to select the “R” option. This is the tone you Receive, i.e. the “Decode” tone.
3. Rotate the **DIAL** knob to select the desired *Decode* CTCSS frequency (or DCS code).
4. Press the **MEM/VFO CH** knob momentarily, then rotate the **DIAL** knob to select the “T” option. This is the tone you Transmit, i.e. the “Encode” tone.
5. Rotate the **DIAL** knob to select the desired *Encode* CTCSS frequency (or DCS code).
6. Press and hold in the **[F]** key for one second to save the new setting and exit to normal operation.



## FM TRANSMISSION

### ARTS™ Operation

The ARTS™ system uses DCS signaling to inform you when you and another ARTS™-equipped station are within communications range. This can be especially valuable during search-and-rescue operations, as a base station can quickly use ARTS™ to alert a field unit that it is out of range; the field unit can then move to a better location to re-establish communications.

ARTS™ is easy to use:

1. Press the **[F]** key momentarily, then rotate the **MEM/VFO CH** knob, as needed, until Multi Function Row “F” [ARTS, SRCH, PMS] appears on the display.
2. Press the **[A]**(ARTS) key to activate ARTS™ operation.
3. Your display will change to “out range” to indicate the beginning of ARTS™ operation. Every 30 seconds, your radio will transmit a “polling” call to the other station. When that station responds with its return ARTS™ polling signal, your display will change to “in range” to confirm reception of the response.

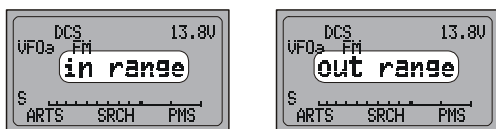

4. To cancel ARTS™ operation, press the **[A]**(ARTS) key again (the “out range” or “in range” indication will disappear from the LCD).

### ARTS ALERT BEEP OPTIONS

The ARTS™ feature allows two kinds of alert beeps (with the additional option of turning them off), so as to alert you to the current status of ARTS™ operation. Depending on your location and the potential annoyance associated with frequent beeps, you may choose the Beep mode which best suits your needs. The choices are:

- RANGE: The beeps are issued only when the radio first confirms that you are within range, but does not re-confirm with beeps thereafter.
- ALL: Every time a polling transmission is received from the other station, the alert beeps will be heard.
- OFF: No alert beeps will be heard; you must look at the display to confirm current ARTS™ status.

To set the ARTS™ Beep mode:

1. While still in Multi Function Row “f” [ARTS, SRCH, PMS], press and hold the **[A]**(ARTS) key for one second. This is a “hot key” which will instantly recall Menu Mode No-008 [ARTS BEEP].
2. Rotate the **DIAL** to select the desired ARTS™ Beep mode (see above).
3. When you have made your selection, press and hold the **[F]** key for one second to save the new setting and exit to normal operation.

### CW Identifier Setup

The ARTS™ feature includes a CW identifier, as discussed previously. Every ten minutes during ARTS™ operation, the radio can be instructed to send “DE (your callsign) K” if this feature is enabled. The callsign field may contain up to 10 characters.

Here’s how to program the CW Identifier:

1. Press and hold the **[F]** key for one second to enter the Menu mode.
2. Rotate the **MEM/VFO CH** knob to select the Menu Mode No-010 [ARTS IDW].
3. Press the **MEM/VFO CH** knob momentarily to initiate callsign storage (the first character location of the callsign field will be underlined.).
4. Rotate the **DIAL** knob to select the first letter/number of your callsign, then rotate the **MEM/VFO CH** knob one click clockwise to save the first letter/number and move to the next entry position.
5. Repeat the previous step as many times as necessary to complete your callsign.
6. Press the **MEM/VFO CH** knob momentarily to save your completed callsign and exit.
7. Rotate the **MEM/VFO CH** knob one click counter-clockwise to select the Menu Mode No-009 [ARTS ID].
8. Rotate the **DIAL** to set the CW ID function to “ON.”
9. Press and hold the **[F]** key for one second to save the new setting and exit to normal operation.



# TRANSMITTER OPERATION

## DIGITAL MODE OPERATION (SSB-BASED AFSK)

The **FT-897D** provides extensive capability for digital mode operation on the HF, VHF, and UHF bands. The use of AFSK (Audio Frequency-Shifted Keying) configurations allows a wide variety of different communication modes to be utilized. The Menu provides for specific digital mode selections, which include custom BFO offsets to optimize the receive and transmit passbands for the mode selected.

Before beginning Digital operation, you need to define which Digital mode will be utilized. To do this, use Menu #38 as follows (in this example, we will set up RTTY as the Digital mode):

1. Press and hold in the **[F]** key for one second to enter the Menu mode.
2. Rotate the **MEM/VFO CH** knob to select Menu Mode No-038 [DIG MODE].
3. Rotate the **DIAL** knob to select “RTTY-L” or “RTTY-U” (see discussion below).
4. Press and hold in the **[F]** key for one second to save the new setting and exit.



*Use this technique to set up any digital mode.*

### RTTY (Radio TeleType) Operation

The “RTTY” mode on the **FT-897D** is available in either LSB-side or USB-side BFO injection. Long-standing Amateur practice calls for the use of LSB-side injection, but some applications require that you use USB-side injection.

1. Connect your TNC (Terminal Node Controller) or terminal modem to the **FT-897D**'s rear-panel **DATA** jack, per the illustration. Be sure to use the “TX AUDIO” line, not an “FSK” line, for the transmit data connection to the **FT-897D**.

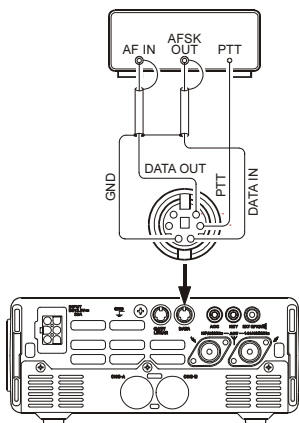

2. Press the **MODE(◀)** or **MODE(▶)** key, as needed, to select the DIG mode (the “DIG” icon will appear on the display). You should now be able to tune around the band, and any RTTY signals heard should be capable of being decoded.

3. If the optional **YF-122C** 500 Hz filter or **YF-122CN** 300 Hz filter filter has been installed, it may be used for RTTY work. Recall Multi Function Row “n” [CFIL, —, —], then press the **[B](—)** or **[C](—)** key to engage the narrow filter.
4. To set up the transmit side, be sure that the Meter is set to monitor ALC voltage. If not, press the **[F]** key momentarily, then rotate the **MEM/VFO CH** knob to select to select Multi Function Row “i” [MTR, —, DISP], then press the **[A](MTR)** or **[B]** key so as to select metering of ALC (“ALC” icon will appear at the upper of the **[B]** key).
5. Press and hold in the **[F]** key for one second to enter the Menu mode, then rotate the **MEM/VFO CH** knob to select Menu Mode No-037 [DIG GAIN].
6. Following the instructions for your TNC's software, activate the transmitter from the computer keyboard; this should cause the AFSK output from the TNC to be sent to the radio. While transmitting, view the ALC meter; a few “dots” of ALC indication should be observed. If not, rotate the **DIAL** knob to adjust the AFSK level within the **FT-897D** for seven to eight dots of indication on the ALC meter.
7. Press and hold in the **[F]** key for one second to save the new AFSK level setting and return to normal operation. You are now ready for full RTTY operation.



*Because RTTY is a continuous-duty transmission mode, try to keep your transmission short when running on battery power, so as to minimize current drain.*

## DIGITAL MODE OPERATION (SSB-BASED AFSK)

### PSK31 Operation

Two dedicated PSK31 modes are available, one each for USB-side and LSB-side injection. For BPSK work, the injection does not matter, but for QPSK the two working stations must use the same sideband.

Connect the **FT-897D** to your computer's sound card or interface, per the illustration.

Setup for PSK31 operation is basically identical to that previously described for RTTY operation. As before, use the "DIG" mode. However, in Menu Mode No-038 [DIG MODE], select "PSK31-L" (for LSB injection) or "PSK31-U" (for USB injection). As with RTTY, Menu #38 may be used to set the drive to the transmitter. And the **YF-122C** 500 Hz filter or **YF-122CN** 300 Hz filter may also be utilized, as described previously.

### "USER" DEFINED DIGITAL MODES

Also provided in the **FT-897D** are two convenient "USER" Digital modes, one each providing USB- and LSB-side injection, which may be used for SSTV, Fax, Pactor, and other digital operating modes.

Here is an example involving the configuration of the USER mode for JT44 (WSJT) operation with USB-side injection (as opposed to LSB injection, used in the default "RTTY" mode):

1. Use Menu Mode No-038 [DIG MODE] to set the Digital mode to "USER-U."
2. Press the **MODE(◀)/MODE(▶)** key, as needed, to select the DIG operating mode (the "DIG" icon will appear on the display).
3. Now use Menu mode to configure the transceiver's passband response. Once in the Menu mode, rotate the **MEM/VFO CH** knob to select Menu Mode No-039 [DIG SHIFT], and rotate the **DIAL** knob to set the desired BFO offset. (a center frequency for the receiver response). For WSJT use, a setting of about "+1500" will be a good starting point.
4. Finally, depending on how you wish the display to respond, you may program in a corresponding display shift, using Menu Mode No-036 [DIG DISP].
5. Remember to press and hold in the [**F**] key for one second when exiting the Menu mode.

The setup of the AFSK drive level is identical to that described previously for RTTY operation.



*The **USER-L** and **USER-U** Digital modes should allow you to operate on any SSB-based AFSK Digital mode. Note that the "PSK31" configurations will also work well for many Digital operating situations.*

### Packet (1200/9600 bps FM) Operation

The **FT-897D** is designed for operation on either 1200 bps or 9600 bps packet, and setup is similar to that described previously for SSB-based modes. A separate Data input adjustment is provided, allowing you to optimize the deviation on the FM Packet modes separately from the levels set for SSB-based Digital modes. The RX-Data output lines are fixed-level outputs, not affected by the setting of the AF Gain control.

1. Connect your TNC to the **FT-897D**'s rear-panel **DATA** jack, per the illustration.

Note that different connections are used for 1200 bps and 9600 bps Packet.

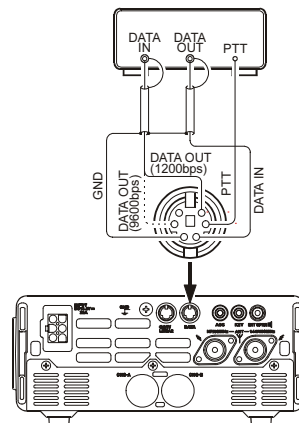

2. Use Menu Mode No-073 [PKT RATE] to select the desired Packet mode.

Once you have entered the Menu and have selected Menu Mode No-073 [PKT RATE], rotate the **DIAL** knob to select either "1200" or "9600" (bps) as the Packet rate.

3. Press the **MODE(◀)/MODE(▶)** key, as needed, to select the PKT operating mode (the "PKT" icon will appear on the display).

You are now set up for reception on Packet. If you are operating on 1200 bps, try now to connect to another station or node; you may well find that the drive level needs no further adjustment. If, however, you are having trouble connecting due to insufficient or excessive drive from the TNC to the **FT-897D**, use Menu Mode No-071 [PKT 1200] (for 1200 bps Packet) or No-072 [PKT 9600] (for 9600 bps Packet) to set the drive. Use your terminal software's "test" protocol to send out test tones, and adjust the deviation by rotating the **DIAL** knob, which will vary the data input level to the **FT-897D**'s modulator. Remember to press and hold in the [**F**] key for one second when adjustments are completed, so as to save the new setting for Menu Mode No-071 [PKT 1200] or No-072 [PKT 9600].



*The 9600 bps Packet deviation setting is very critical to successful operation, and it can only be accomplished using a calibrated deviation meter; the optimum setting is usually  $\pm 2.75$  kHz ( $\pm 0.25$  kHz). For 1200 bps, the optimum level is much less critical, with the optimum deviation being between  $\pm 2.5$  kHz and  $\pm 3.5$  kHz.*

# TRANSMITTER OPERATION

## WEATHERFAX MONITORING

Monitoring of HF WeatherFax broadcasts is easily accomplished using the **FT-897D**.

Before proceeding, be certain that the WeatherFax demodulator is properly connected to Pins 5 and 2 of the rear panel **DATA** jack.

1. Set the transceiver to the VFO mode, and set the operating mode to “DIG,” setting Menu Mode No-038 [DIG MODE] to “PSK31-U,” as described previously.
2. Now, select the operating frequency of the station transmitting the WeatherFax broadcast. Note that, in the USB mode, the frequency you should program onto the display is typically 1.90 kHz below the station’s “assigned” frequency. Thus for a WeatherFax station assigned to 8.682.0 MHz, tune to 8.680.1 MHz.
3. When the WeatherFax broadcast begins, no further operator intervention should be needed from the transceiver standpoint. The audio level from the **DATA** jack on the rear of the transceiver is fixed, and cannot be adjusted.
4. Fine adjustments in the gray-scale and the frame alignment are accomplished using the computer and software connected to your WeatherFax demodulator.

## TIME-OUT TIMER

Most often used on FM, the transmitter’s Time-Out Timer (TOT) feature disables the transmitter after a user-defined period of transmission. This feature may be useful in preventing a “stuck microphone” (accidental closure of the **PTT** switch) from causing interference to other users, and it will also force you to keep your transmissions short, thereby conserving battery power.

To activate the Time-Out Timer:

1. Press and hold in the [**F**] key for one second to enter the Menu mode.
2. Rotate the **MEM/VFO CH** knob to recall Menu Mode No-084 [TOT TIME].  
The default setting for this feature is “OFF.” Rotate the **DIAL** knob to set a new time-out setting (from 1 minute to 20 minutes).
3. When you have made your selection, press and hold in the [**F**] key for one second to save the new setting and exit to normal operation.

## SPLIT FREQUENCY OPERATION

This transceiver provides convenient split-frequency operation, using the VFO-A and VFO-B, for DX working and other operating situations requiring unique split frequency pairs.

The example below will describe a typical split-frequency DX situation on the 20-meter band, with a DX station transmitting on 14.025 MHz, listening 10 kHz higher in the band.

1. Set VFO-A to 14.035.00 MHz CW (DX station’s listening frequency).
2. Press the [**F**] key momentarily, then rotate the **MEM/VFO CH** knob, as needed, until Multi Function Row “a” [A/B, A=B, SPL] appears on the display.
3. Press the [**A**](A/B) key momentarily to select VFO-B.
4. Tune the VFO-B frequency to 14.025.00 MHz (DX station’s transmitting frequency).
5. Press the [**C**](SPL) key momentarily. The transceiver will now transmit using the VFO-A frequency, and will receive using the VFO-B frequency.  
“Parentheses” will appear on the both sides of the “SPL” indication, and the “SPL” icon will appear at the upper left corner of the display.
6. To listen to the pile-up calling the DX station (so as to align your frequency more closely to that of the station being worked by the DX), press the [**A**](A/B) key to reverse the VFOs. You will now be tuning in the vicinity of 14.035 MHz, and you can zero in on the DX station’s listening frequency by tuning in on the station in QSO with the DX. Press the [**A**](A/B) key again to return to reception on the DX station’s frequency.
7. Press the [**C**](SPL) key once more to cancel split operation; the “Parentheses” and “SPL” icon will disappear from the display.

## ACTIVE-TUNING ANTENNA SYSTEM (ATAS-100/-120) OPERATION

The optional **ATAS-100/-120** Active-Tuning Antenna System provides operation on a number of HF bands (7/14/21/28 MHz) plus 50 MHz, 144 MHz, and 430 MHz. The **FT-897D** provides microprocessor control of the tuning mechanism in the **ATAS-100/-120** for convenient automatic tuning.

Before operation can begin, you must instruct the **FT-897D**'s microprocessor that the **ATAS-100/-120** is being used. This is done using the Menu Mode:

1. Press and hold in the **[F]** key for one second to activate the Menu mode.
2. Rotate the **MEM/VFO CH** knob to recall Menu Mode NO-085 [TUNER/ATAS]. The default setting for this Menu is "OFF." Rotate the **DIAL** to change the setting to "ATAS(ALL)," if you are using the **ATAS-100/-120** for all bands (you must connect an external diplexer to combine the two antenna ports so as to use the **ATAS-100/-120** on all bands). Or make the setting "ATAS(HF&50)," if you are using the **ATAS-100/-120** on 7 ~ 50 MHz, with a dual-band VHF/UHF antenna connected separately to the 144/430 MHz antenna port. If you are just using the **ATAS-100/-120** on the HF bands only, with a dual-band VHF/UHF antenna connected separately to the 144/430 MHz antenna port (no 50 MHz operation) make the setting "ATAS(HF)."
3. Press and hold in the **[F]** key for one second to save the new setting and exit to normal operation.

### Automatic Tuning

1. Press the **[F]** key, as needed, to recall Multi Function Row "k" [TUNE, DOWN, UP].
2. Press the **[A]**(TUNE) key to turn the **ATAS-100/-120** on (this action only supplies voltage to the antenna at this point; re-tuning does not begin). "Parentheses" will appear on the both sides of the "TUNE" indication, and the "ATAS" will appear on the LCD.
3. Now press and hold in the **[A]**(TUNE) key for one second to initiate **ATAS-100/-120** tuning. The transmitter will automatically be activated, a carrier will be sent, and the antenna's length will be adjusted for best SWR.
4. If the microprocessor determines that the antenna's length is radically incorrect from the optimum value, no carrier will be sent out. Instead, in the receive mode, the antenna will retract to its shortest position (this may take up to one minute). While this is happening, do not press the **[A]**(TUNE) key again.  
When the **ATAS-100/-120** reaches its minimum length, automatic tuning will be initiated, and the transmitter will automatically shut off when a satisfactory SWR is achieved.
5. On the 144 MHz and 430 MHz bands, the **ATAS-100/-120** does not require a tuning process. SWR will be satisfactory when the antenna is fully retracted.
6. When you wish to conclude **ATAS-100/-120** operation, press the **[A]**(TUNE) key; the "Parentheses" disappear surrounding the "ATAS" indication.

### Manual Tuning

In some instances, the SWR may be slightly improved by manual adjustment of the antenna position. This may be needed for operation on bands like 40 meters, where the "Q" of the **ATAS-100/-120** is high, causing a narrow resonance range.

Before Manual Tuning, press the **[F]** key, as needed, to recall Multi Function Row "i" [MTR, —, DISP], then press the **[A]**(MTR) or **[B]** key to change the meter function to the SWR meter ("SWR" icon will appear at the upper of the **[B]** key).

To tune the **ATAS-100/-120** manually, recall Multi Function Row "k" [TUNE, DOWN, UP], then press and hold in the microphone **PTT** switch. With the transceiver in the "transmit" mode, press and hold in the **[C]**(UP) key (to raise the antenna) or the **[B]**(DOWN) key (to lower the antenna). While you hold in one of these keys, the **FT-897D** will generate a carrier, and you may watch the top scale of the **FT-897D**'s meter, looking for the meter indication to reach its minimum value. When this is reached, release the **[C]**(UP) or **[B]**(DOWN) key, then release the **PTT** key to return to the "receive" mode.



- 1) *Once automatic matching has been successfully accomplished, you must change frequency by at least 10 kHz before attempting automatic matching again. Within a window of  $\pm 10$  kHz from a match point, the transceiver's microprocessor will ignore any command to attempt automatic matching.*
- 2) *Antenna tuning is accomplished using a "CW" carrier, although the mode indication will not change to "CW" (if you are operating on another mode) during antenna tuning.*
- 3) *If you see a "HI SWR" on the LCD, it may mean that there is a problem in your coaxial cable (bad connection, etc.) which is preventing successful tuning. Replace the cable, or try adding a few feet/meters of cable (to eliminate the possibility of adverse "transformer action" in the  $50\Omega$  cable during the tuning process).*
- 4) *If you are able to achieve an SWR of less than 2:1 via manual tuning, the FT-897D will "accept" the manual setting, and you may then re-tune automatically when changing bands. If, however, you stop manual tuning at a non-optimum setting (SWR > 2:1), the FT-897D will not permit further automatic tuning. To refresh the setting of the ATAS-100/-120, press the **[B]**(DOWN) key until the ATAS-100/-120 fully retracts. You may then restart automatic tuning per the procedures described earlier.*
- 5) *The FT-897D may also be used with the model ATAS-100 antenna, although the tuning speed of the ATAS-100 will be slower than with the ATAS-120.*

# TRANSMITTER OPERATION

## ACTIVE-TUNING ANTENNA SYSTEM (ATAS-100/-120) OPERATION

### ATAS-100/-120 Operating Tips

The information below will help you derive the best performance possible from the **ATAS-100/-120** Active-Tuning Antenna System.

### Grounding

It is critically important that you establish a good mechanical and RF ground connection for your **ATAS-100/-120** (as with all vertical antennas). Mobile mounts which are bolted through the vehicle's roof, or otherwise mechanically affixed, will usually be satisfactory. However, magnetic mounts do not provide the RF grounding necessary for good performance, and are not recommended for use with this antenna.

### Tuning Procedure

The feedpoint impedance of the **ATAS-100/-120** (resistance and reactance) will necessarily vary over a wide range when you change bands. Occasionally, the transceiver's microprocessor will not initially be able to determine the proper direction for the **ATAS-100/-120** to travel (inward or outward) for best SWR.

To resolve this situation, the transceiver will then command the **ATAS-100/-120** to retract fully to its minimum height, and thence restart the tuning process. In this instance, the "TUNE" icon will remain on the display after you press the [A](TUNE) key. If this happens, do not press the [A](TUNE) key repeatedly. The transceiver will remain in the receive mode as it retracts (this may take up to one minute). Thereafter, the transmitter will be engaged, and the **ATAS-100/-120** will be automatically adjusted for best SWR. The "TUNE" icon will then disappear from the LCD, and you will be ready for operation.

### External Wattmeters

If you wish to use an external wattmeter in conjunction with the transceiver and your **ATAS-100/-120**, please check the wattmeter with an Ohmmeter prior to installation. Be sure there is a direct connection between the "In" and "Out" jacks of the wattmeter (zero resistance), and also ensure that there is a completely open circuit between the center pin and shield of the wattmeter's output jack. Some wattmeters use a coil or other device which shorts the center pin to ground at DC, and this type of internal wattmeter circuitry will not allow the tuning function of the **ATAS-100/-120** to operate.

### Operation on 30/17/12 Meters

Although the **ATAS-100/-120** is not specified for operation on the above bands, and optimum operation is therefore not guaranteed, the **ATAS-100/-120** generally can be tuned successfully on these bands (some manual adjustment may be required). Operation of the **ATAS-100/-120** on these bands will not damage the antenna's components; please feel free to experiment on these bands, if you like.



## FC-30 AUTOMATIC ANTENNA TUNER OPERATION

The optional **FC-30** Automatic Antenna Tuner provides automatic tuning of a coaxial line so as to present a nominal 50  $\Omega$  impedance to the **FT-897D**'s HF/50 MHz antenna port.

Before operation can begin, you must instruct the **FT-897D**'s microprocessor that the **FC-30** is being used. This is done using the Menu Mode:

1. Press and hold in the **[F]** key for one second to activate the Menu mode.
2. Rotate the **MEM/VFO CH** knob to recall Menu Mode No-001 [EXT MENU], then rotate the **DIAL** to change the setting to "ON" to enable the extended Menu Mode.
3. Rotate the **MEM/VFO CH** knob to recall Menu Mode No-020 [CAT/LIN/TUN]. The default setting for this Menu is "CAT." Rotate the **DIAL** to change the setting to "TUNER."
4. Press and hold in the **[F]** key for one second to save the new setting and exit, then turn the transceiver off.
5. Set up the **FC-30** and **FT-897D** per the illustration, then turn on the transceiver's power again. **Do not set up the FC-30 and FT-897D before changing the Menu Mode, item No-020 [CAT/LIN/TUN].**
6. Press and hold in the **[F]** key for one second to activate the Menu mode.
7. Rotate the **MEM/VFO CH** knob to recall Menu Mode No-085 [TUNER/ATAS]. The default setting for this Menu is "OFF." Rotate the **DIAL** to change the setting to "TUNER."
8. Press and hold in the **[F]** key for one second to save the new setting and exit.

Operation is similar to the procedure for the **ATAS-100/-120**:

1. Press the **[F]** key, as needed, to recall Multi Function Row "k" [TUNE, DOWN, UP].
2. Press the **[A](TUNE)** key to turn the **FC-30** on. "Parentheses" will appear on both sides of the "TUNE" indication, and the "TUNR" will appear on the LCD.
3. Press and hold in the **[A](TUNE)** key to initiate automatic tuning. The **FT-897D** transmitter will be activated, a carrier signal will be sent out, and the coils and capacitors in the **FC-30** will be selected/adjusted for optimum SWR. When tuning is complete, the transmission will cease, and you will be ready for operation on this frequency.



*Tuning data will be stored in the FC-30's Memory system. See the discussion below for details on how this works.*

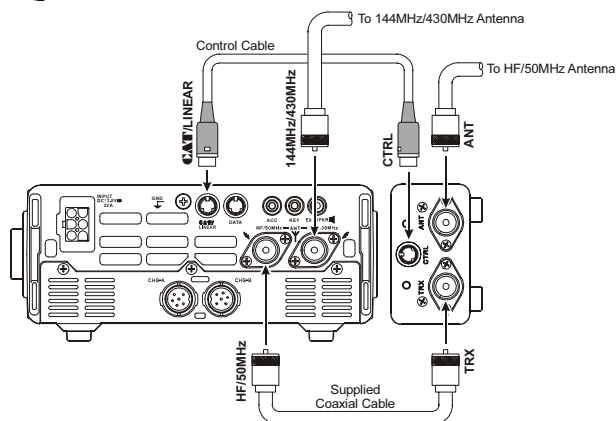

### Antenna Tuner Memory System

The **FC-30**, working in concert with the **FT-897D**, can store impedance matching data in its micro-computer memory, so as to provide instant adjustment as you transmit in different areas of a particular band. A total of 100 memories are provided: 11 of these are "general" memories apportioned one per band, while the remaining 89 are allocated for specific frequency data within the various bands, with the capability to resolve new tuning data every 10 kHz. A few guidelines should be noted regarding the **FC-30**'s memory system:

Tuning data is stored when you make an active effort to store it by pressing and holding in the **[A](TUNE)** key for one second. Although the tuner will automatically activate itself if it encounters more than 1.5:1 SWR, this memory will not be stored unless you have pressed the **[A](TUNE)** key for one second. This allows you to store your favorite operating frequency areas into tuner memory without tying up memory space with matching data on seldom-used frequencies.

If the **FC-30** cannot resolve a satisfactory match because the SWR is above 3:1 (2:1 on the 50 MHz band), the tuning process will stop, and no memory data will be stored. However, you may wish to move frequency a few kHz, then press the **[A](TUNE)** key again for one second, as slight changes in the reactance may allow a match to be obtained. Then go back to the original frequency and try again.

Another technique which may allow matching in some situations is to add a few feet or meters of coaxial cable on the "antenna side" of the **FC-30**. This will change the impedance transformation taking place in the coaxial cable, possibly moving the impedance presented to the **FC-30** into an acceptable range. Note that this is not changing the actual antenna SWR, but only the impedance "seen" by the **FC-30**'s matching circuits.

If your antenna system presents an SWR of less than 1.5:1, you may wish to turn off the antenna tuner, as full transmitter power will be delivered to the antenna system without intervention by the **FC-30**.

If the impedance encountered by the **FC-30** exceeds 3:1, and the "HI SWR" icon is illuminated, the microprocessor will not retain the tuning data for that frequency, as the **FC-30** presumes that you will want to adjust or repair your antenna system so as to correct the high SWR condition.



# MEMORY OPERATION

## QMB (QUICK MEMORY BANK) CHANNELS

The “Quick Memory” Bank provides one-touch access to frequencies you want to store and recall in a hurry. You may store a “QMB” channel into a “regular” memory later, if you like; use of the “regular” memories will be described later.

### QMB Channel Storage

1. Tune in the desired frequency and set the operating mode and bandwidth. If this is an FM channel, set up any required CTCSS/DCS and repeater shift configurations.
2. Press and hold in the **V/M** key until a double “beep” is heard. The second beep provides audible confirmation that the data has been stored into the QMB memory.



*Pressing the [A](STO) key momentarily while in Multi Function Row “c” [STO, RCL, PROC] will also store a frequency into the QMB register.*

### QMB Channel Recall

1. Press the **[F]** key momentarily, then rotate the **MEM/VFO CH** knob, as needed, until Multi Function Row “c” [STO, RCL, PROC] appears on the display.
2. Press the **[B](RCL)** key momentarily to recall the QMB memory. “QMB” will appear at the upper left corner on the display.
3. Press the **[B](RCL)** key once more to return to the previous frequency (either a VFO frequency or a Memory channel).



*If you move the DIAL knob or MEM/VFO CH knob while in the QMB mode, you can change frequencies as if you were in a “VFO” mode. You also can change operating mode by pressing the MODE(◀) or MODE(▶) key. When this is done, “MTQMB” will appear in the display, where “MT” represents “Memory Tuning.” Press the [B](RCL) key once more to return to the originally-stored QMB frequency.*

## MEMORY OPERATION ON “REGULAR” MEMORY CHANNELS

Most Memory operation will be conducted in the “regular” memory registers. There are 200 memory channels available for storage and recall of important frequencies.

### Normal Memory Storage

1. Tune in the desired frequency, and set the operating mode and bandwidth. If this is an FM channel, set up any required CTCSS/DCS and repeater shift configurations. Standard (default) repeater shifts do not require you to utilize the “split” frequency memory technique, described later.
2. Press the **[F]** key momentarily, then rotate the **MEM/VFO CH**, as needed, until Multi Function Row “b” [MW, SKIP, TAG] appears on the display.
3. Press the **[A](MW)** key momentarily to enter the “Memory Check” mode, which is used to find an unused memory channel. The frequency stored (if any) on the current memory channel will be shown in the display. Rotate the **MEM/VFO CH** knob to select the channel number on which you wish to store the current frequency data.
4. Press and hold in the **[A](MW)** key for one second until you hear a double beep; the second beep confirms that the frequency information was successfully stored.

### Split-Frequency Memory Storage

You can also store “Split” frequencies, such as when operating on a repeater system not utilizing a “standard” offset. This procedure may also be used for DX work on 7 MHz SSB, etc.

1. In the VFO mode, set the desired Receive frequency and mode.
2. Press the **[F]** key momentarily, then rotate the **MEM/VFO CH** knob, as needed, until Multi Function Row “b” [MW, SKIP, TAG] appears on the display.
3. Press the **[A](MW)** key momentarily to enter the “Memory Check” mode, which is used to find an unused memory channel. The frequency stored (if any) on the current memory channel will be shown in the display. Rotate the **MEM/VFO CH** knob to select the channel on which you wish to store the receive frequency data.
4. Press and hold in the **[A](MW)** key for one second until you hear a double beep, which confirms that the Receive frequency data is now stored.
5. Now, set the desired Transmit frequency and mode on the VFO.
6. Press the **[A](MW)** key momentarily; do not rotate the **MEM/VFO CH** knob!

While the “memory channel number” is blinking, press and hold in the **PTT** switch; while holding it in, press and hold in the **[A](MW)** key for one second.

The double “beep” will confirm that independent Transmit frequency data is now stored. You may now release the **PTT** switch.



*In step 6 above, pressing the PTT switch does not activate the transmitter. It simply sends a signal to the microprocessor that an independent Transmit frequency is being stored on the same channel as a previously-stored Receive frequency.*

## MEMORY OPERATION ON “REGULAR” MEMORY CHANNELS

### Memory Channel Recall

1. If you currently are in the VFO tuning mode, press the **V/M** key once to enter the “Memory” mode (a memory channel number “M-*nnn*” will appear on the display in the space previously occupied by “VFOa” or “VFOb”).
2. To select another memory channel, turn the **MEM/VFO CH** knob.
3. When your memory channels are partitioned into Memory Groups via Menu Mode No-055 [MEM GROUP], it is easy to change Memory Groups; press the **MEM/VFO CH** knob momentarily (a Group Number (“Ma” ~ “Mj”) will blink), then turn the **MEM/VFO CH** knob to step through the channels until you enter another. You may now press the **MEM/VFO CH** knob once more to restrict memory channel access to the newly-selected Group.
4. Once you are operating on a memory channel, you may tune off of the originally-memorized frequency (as though you were in the VFO mode). Just rotate the **DIAL** knob; the “Memory Channel Number” will be replaced by one which indicates “MTUNE,” indicating that you have now shifted into the “Memory Tuning” mode. When operating the Memory Tuning mode, if you find another frequency you wish to store into another memory channel, just press the **[A](MW)** key momentarily, select a new memory channel via the **MEM/VFO CH** knob, then press and hold in the **[A](MW)** key until you hear the double beep.
5. To exit the Memory Tuning mode, press the **V/M** key as follows:
  - One touch of the **V/M** key returns you to the original memory frequency.
  - A second touch of the **V/M** key will cause you to exit the Memory mode and return to the VFO mode (the memory channel number will be replaced by “VFOa” or “VFOb”).



*When operating on a “Split” frequency memory, a special “-+” indication will appear on the LCD.*

### Masking (“Hiding”) a Memory

Frequency data stored on a memory channel can be deleted, if desired, from any memory channel except channel “1.” The deletion process is not a “hard” erasure, so if you erase a channel by mistake using this procedure, the memory channel contents can be recovered.

1. Press the **[F]** key momentarily, then rotate the **MEM/VFO CH** knob, as needed, until Multi Function Row “b” [MW, SKIP, TAG] appears on the display.
2. Press the **[A](MW)** key momentarily, then rotate the **MEM/VFO CH** knob to select the memory channel to be deleted.
3. Press the **[B](MCLR)** key momentarily. The frequency display field on the LCD will go blank, and the memory channel number will blink.
4. Wait about five seconds; when the memory channel number stops blinking, the data will now be “masked” and will not be available for operation.
5. To restore the masked frequency data, repeat the above steps. However, if you store new frequency information on a channel containing masked data, the masked data will be over-written and lost.
6. Memory Channel 1 is used for Priority operation, and frequency information may only be over-written (not masked) on this channel.

MEMORY CHANNEL NUMBER	
MEMORY GROUP “OFF”	MEMORY GROUP “ON”
M-001 ~ M-020	Ma-01 ~ Ma-20
M-021 ~ M-040	Mb-01 ~ Mb-20
M-041 ~ M-060	Mc-01 ~ Mc-20
M-061 ~ M-080	Md-01 ~ Md-20
M-081 ~ M-100	Me-01 ~ Me-20
M-101 ~ M-120	Mf-01 ~ Mf-20
M-121 ~ M-140	Mg-01 ~ Mg-20
M-141 ~ M-160	Mh-01 ~ Mh-20
M-161 ~ M-180	Mi-01 ~ Mi-20
M-181 ~ M-200	Mj-01 ~ Mj-20
M-P1L ~ M-P5U	Mk-1L ~ Mk-5U

# MEMORY OPERATION

## MEMORY OPERATION ON “HOME” CHANNEL MEMORIES

Four Special one-touch “Home” channels are available, for special frequencies you use often. Either “simplex” or “split” frequency/mode data may be stored in the “Home” channel locations. Special “Home” channels are available for HF (any frequency between 1.8 and 29.7 MHz), 50 MHz, 144 MHz, and 430 MHz.

These memories may prove particularly useful for monitoring propagation beacons, providing one-touch recall of the beacon frequency for a quick check of band conditions.

### HOME Channel Storage

1. Tune the desired frequency, and set the operating mode. If this is an FM channel, set up any required CTCSS/DCS and repeater shift configurations.
2. Press the [F] key momentarily, then rotate the **MEM/VFO CH** knob, as needed, until Multi Function Row “b” [MW, SKIP, TAG] appears on the display.
3. Press the [A](MW) key momentarily to enter the “Memory Check” mode.
4. Press and hold in the **HOME** key for one second. This stores the frequency data into the “Home” channel location. As usual, you will hear a double beep to confirm the successful storage of the frequency data.
5. If you wish to store a “Split” frequency pair into the “Home” channel, store the Receive frequency as in steps 1 ~ 4 above. Now set the desired Transmit frequency. Once more, press the [A](MW) key momentarily. Press and hold in the microphone’s **PTT** switch; while holding the **PTT** switch, again press and hold in the **HOME** key for one second. This stores the transmit frequency data into the “Home” channel location.

### HOME Channel Recall

1. Press the **HOME** key momentarily to recall the Home Channel on the band group where you currently are operating (HF, 50 MHz, 144 MHz, or 430 MHz). The “HOME” indication will appear on the display.
2. Press the **HOME** key once more to return to the previously-used frequency (either a VFO frequency or a memory channel).

## LABELING MEMORIES

You may wish to append an alpha-numeric “Tag” (label) to a memory or memories, to aid in recollection of the channel’s intended use (such as a club name, etc.). This is easily accomplished using the Menu mode.

1. Recall the memory channel onto which you wish to append a label.
2. Press and hold in the [F] key for one second to enter the Menu mode.
3. Rotate the **MEM/VFO CH** knob to recall Menu Mode No-056 [MEM TAG].
4. Press the **MEM/VFO CH** knob to enable the programming of the label.
5. Rotate the **DIAL** knob to select the first character (as shown below) in the name you wish to store, then rotate the **MEM/VFO CH** knob clockwise to move to the next character.
6. Again rotate the **DIAL** knob to select the next number, letter, or symbol, then rotate the **MEM/VFO CH** knob clockwise to move to the next character’s slot.
7. Repeat step 6 as many times as necessary to complete the name tag for the memory, then press and hold in the [F] key for one second to save the A/N (Alpha-Numeric) name entry and exit to normal operation.
8. During Memory operation, press the [F] key momentarily, then rotate the **MEM/VFO CH** knob, as needed, until Multi Function Row “b” [MW, SKIP, TAG] appears on the display. Press the [C](TAG) key momentarily to activate the alpha-numeric Tag. Repeatedly pressing this key will toggle operation between “Frequency” display and “Tag” display.



“Frequency” Display



“Tag” Display



*You can recall Menu Mode No-056 [MEM TAG] instantly by pressing and holding in the [C](TAG) key for one second.*

↑	"	#	\$	%	&	'	(	)	*	+	,	-	.	/	0
1	2	3	4	5	6	7	8	9	:	;	<	=	>	?	0
A	B	C	D	E	F	G	H	I	J	K	L	M	N	O	P
Q	R	S	T	U	V	W	X	Y	Z	[	¥	]	^	_	`
a	b	c	d	e	f	g	h	i	j	k	l	m	n	o	p
q	r	s	t	u	v	w	x	y	z	ƒ	#	€	£	¤	¥
Ⓚ	Ⓛ	Ⓜ	Ⓝ	Ⓟ	Ⓡ	Ⓢ	Ⓣ	Ⓤ	Ⓥ	Ⓦ	Ⓧ	Ⓨ	Ⓩ	ⓐ	ⓑ
ⓓ	ⓔ	ⓕ	ⓖ	ⓗ	ⓘ	ⓙ	ⓚ	ⓛ	ⓜ	ⓝ	ⓞ	ⓟ	ⓠ	ⓡ	ⓢ
ⓣ	ⓤ	⓶	⓷	⓸	⓹	⓺	⓻	⓼	⓽	⓾	⓿	⓫	⓬	⓭	⓮
⓯	⓰	⓱	⓲	⓳	⓴	⓵	⓶	⓷	⓸	⓹	⓺	⓻	⓼	⓽	⓾
⓿	⓫	⓬	⓭	⓮	⓯	⓰	⓱	⓲	⓳	⓴	⓵	⓶	⓷	⓸	⓹
⓺	⓻	⓼	⓽	⓾	⓿	⓫	⓬	⓭	⓮	⓯	⓰	⓱	⓲	⓳	⓴
⓵	⓶	⓷	⓸	⓹	⓺	⓻	⓼	⓽	⓾	⓿	⓫	⓬	⓭	⓮	⓯

## SPECTRUM SCOPE MONITOR OPERATION

The Spectrum Scope Monitor allows viewing of operating activity on above and below your current frequency channel in the VFO mode, or viewing of memory channel activity on the current memory group when in the Memory mode. When the Spectrum Scope Monitor is activated, the display indicates the relative signal strength on channels immediately adjacent to the current operating frequency.

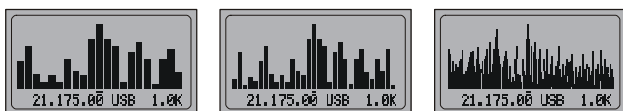

### Using the Spectrum Scope

1. Set the transceiver to the VFO mode in the desired band or within the desired memory group.
2. Press the **[F]** key momentarily, then rotate the **MEM/VFO CH** knob, as needed, until Multi Function Row “h” [SCOP, WID, STEP] appears on the display.
3. Press the **[A]**(SCOP) key momentarily to engage the Spectrum Scope.

When the Spectrum Scope is in operation, the relative signal strength of stations on channels immediately adjacent to the current frequency will be indicated on the display.

4. While the Spectrum Scope is activated in the VFO mode, press the **[B]**(WID) key to change the visible bandwidth. Available selections are  $\pm 10$  (default),  $\pm 15$ , and  $\pm 63$  channels. Press the **[C]**(STEP) key to change the channel step resolution. Available selections are shown below.

Mode	Channel Steps (kHz)
CW, SSB, DIG	1.0 / 2.5 / 5.0
AM	2.5 / 5.0 / 9.0 / 10.0 / 12.5 / 25.0
FM, PKT	5.0 / 6.25 / 10.0 / 12.5 / 15.0 / 20.0 / 25.0 / 50.0

- While the Spectrum Scope is activated, press and hold in the **[B]** key for one second to change the Sweep mode. This allows you to switch between “Scanner sweeps just once” and “Scanner sweeps continuously (default).”
  - When the Spectrum Scope mode is in the “Scanner sweeps just once” mode press and hold in the **[A]** key for one second to restart the Sweep.
  - While the Spectrum Scope is activated, press and hold in the **[C]** key for one second to enable the “Meter peak hold” feature.
5. To disable the Spectrum Scope, press the **[A]**(SCOP) key once more.



*The receiver’s audio output and S-meter are disabled when using the Spectrum Scope.*

## SMART SEARCH™ OPERATION

The Smart Search™ feature automatically stores frequencies where activity is encountered on the current band. When Smart Search™ is engaged, the transceiver quickly searches above your current frequency, storing active frequencies as it goes (without stopping on them even momentarily). These frequencies are stored in a special Smart Search™ memory bank, consisting of 50 memories. This feature is available on the FM and AM modes.

The Smart Search™ feature is especially helpful when traveling, as you can instantly store active FM repeater frequencies without having to look up the frequencies in a reference book.

1. Set the **SQL** knob to the point where background noise is silenced. A typical setting, for effective Smart Search™ operation, will be at 12 o’clock or slightly clockwise from this position.
2. Set the VFO to the frequency on which you wish to begin the search (the Smart Search™ feature is available on the VFO mode only).
3. Press the **[F]** key momentarily, then rotate the **MEM/VFO CH** knob, as needed, until Multi Function Row “P” [ARTS, SRCH, PMS] appears on the display.
4. Now press the **[B]**(SRCH) key momentarily; the blinking “SRCH” indicator will appear on the LCD, and the transceiver will sweep upward on the current band, loading channels on which it encounters a signal strong enough to open the squelch. All channels where activity is present (up to 50 channels) will be loaded into the Smart Search™ memories.
5. Now you can turn the **MEM/VFO CH** knob to select from the just-stored Smart Search™ memories. If you find frequencies you wish to store into a “regular” memory, just follow the procedures described previously; just don’t press the **[B]**(SRCH) key while storing these memories, because this will disable Smart Search™ operation.
6. To disable Smart Search™ operation, press the **[B]**(SRCH) key momentarily.



*The Smart Search™ memories are so-called “soft” memories; they will be lost if you initiate a new Smart Search™ sweep of the band.*

# SCANNING OPERATION

## SCANNING FEATURES

This transceiver contains a wide variety of scanning capabilities. Whether you are in the VFO mode or one of the memory modes, scanning operation is fundamentally identical in all configurations, but with the following differences:

- In the VFO mode, scanning causes the transceiver to sweep up or down the band, pausing or halting on any signal encountered;
- In the Memory mode, the scanner will scan the programmed memories, and can be instructed to skip certain memories during scanning;
- In the Programmable Memory Scan (PMS) mode, the scanner will scan the band within user-programmed frequency limits.

### Scanning Operation

In order for the **FT-897D** to scan automatically, the Squelch must be set so that the background noise is silenced, because the command to “Stop Scanning” driven by the same circuit that causes the green “Busy” LED to light up (when noise or a signal is received).

1. Set the **SQL** knob to the point where background noise is silenced. A typical setting, for effective scanning operation, will be at 12 o’clock or slightly clockwise from this position.
2. Set the transceiver into the operating configuration in which you wish to scan (VFO or Memory; PMS will be described later).
3. Press the **[F]** key momentarily, then rotate the **MEM/VFO CH** knob, as needed, until Multi Function Row “g” [SCN, PRI, DW] appears on the display.
4. Press the **[A](SCN)** key momentarily to start upward scan (toward higher frequencies or higher memory channel numbers).
5. Rotate the **DIAL** knob or **MEM/VFO CH** knob counter-clockwise to toggle the scanning direction downward.
6. The scanner will now cause the transceiver to increment in the chosen direction until a signal is detected. When a signal is encountered which opens the Squelch, it will do different things, depending on the operating mode:
  - In the FM/AM modes**, the transceiver pauses on the signal and stays locked on its frequency for five seconds. Thereafter, scanning will resume whether or not the other station’s transmission has ended. While the transceiver is in the “Pause” condition, the decimal points in the frequency display area will blink. See “Scan-Resume Choices” on next chapter for details of how to customize the resumption of scanning.
  - In the SSB/CW modes**, the scanner will slow down (but won’t stop).
7. Press the **PTT** switch on the microphone to cancel scanning.



*You may also press and hold in either the **[UP]** or **[DWN]** key on the microphone for one second to initiate upward or downward scanning, respectively, if Menu Mode No-058 [MIC SCAN] is set to “ON.”*

### Scan-Resume Choices

Scanning operation requires that you have the **FT-897D**’s audio squelched. The transceiver then “assumes” that the opening of the squelch corresponds to the discovery of a signal you may wish to listen to.

Once the scan has been halted, one of three things may happen:

**TIME** (default action): In this mode, the transceiver pauses on the signal and stays locked on its frequency for five seconds. Thereafter, scanning will resume whether or not the other station’s transmission has ended. The pause time is adjustable from 1 to 10 seconds via Menu Mode No-078 [SCAN RESUME].

**BUSY**: In this mode, the scanner will halt until the other station’s transmission ceases (at which point the squelch will close). One second after the squelch closes, scanning resumes automatically.

**STOP**: In this mode, the scanner will find a signal, and lock on that frequency without resuming the scan.

### To choose the Scan-Resume mode:

1. Press and hold in the **[F]** button for one second to activate the Menu mode.
2. Rotate the **MEM/VFO CH** knob to select Menu Mode No-077 [SCAN MODE].
3. Rotate the **DIAL** knob to select the desired Scan-Resume mode.
4. Press and hold in the **[F]** button for one second to exit the Menu mode.



## SCANNING FEATURES

### Scan Skip Programming (Memory Mode Only)

Among the memories you have programmed, there may be some stations which you do not wish to scan. For example, broadcast signals (which are transmitted continuously) will cause the scanner to stop, and such channels may be skipped so as to avoid this inconvenience.

To remove a channel from the scanning loop:

1. Press the **[F]** key momentarily, then rotate the **MEM/VFO CH** knob, as needed, until Multi Function Row “b” [MW, SKIP, TAG] appears on the display.
2. Recall the memory channel to be skipped.
3. Press the **[B]**(SKIP) key momentarily. The “hyphen” in the memory channel number will change to become a “dot;” this shows that this channel now is not included in the scanning loop.

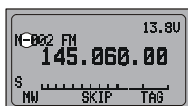

Memory Skip “OFF”

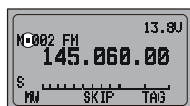

Memory Skip “ON”

4. Repeat steps 2 and 3 as many times as necessary to skip all the channels you do not wish to scan.
5. Initiate memory scanning; you will observe that the channels you marked to be skipped are not included in the scanning loop.
6. Press the **PTT** switch to stop the scan; you may now use the **MEM/VFO CH** knob to step through the channels manually - one at a time - and you will observe that the “Skipped” channels are, nonetheless, available for recall by manual means.
7. You may restore a previously-skipped channel to the scanning loop by selecting the channel manually, then pressing the **[B]**(SKIP) key momentarily so that the “dot” changes to become a “hyphen.”

## “PRIORITY CHANNEL” SCANNING

The **FT-897D**'s scanning features include a two-channel scanning capability which allows you to operate on a VFO or Memory channel, while periodically checking a Memory Channel “M-001” for activity. If a station is received on the Memory Channel “M-001” which is strong enough to open the Squelch, the scanner will pause on that station in accordance with the Scan-Resume mode set via Menu Mode No-078 [SCAN RESUME]. See page 62.

Here is the procedure for activating Priority Channel Dual Watch operation:

1. Rotate the **SQL** control until the background noise is just silenced, then store the frequency to be the “Priority” channel into the Memory Channel “M-001.”
2. Set the **FT-897D** for operation on another memory channel, or on a VFO frequency.
3. Press the **[F]** key momentarily, then rotate the **MEM/VFO CH** knob, as needed, until Multi Function Row “g” [SCN, PRI, DW] appears on the display.
4. Press the **[B]**(PRI) key momentarily to start the “Priority” monitoring (the “**P**” icon will appear at the upper of the frequency display). During Priority monitoring, the displayed frequency will shift to the Priority memory briefly about five seconds, while the receiver check for the presence of a signal.
5. When no signal appears on the Priority memory (i.e. the squelch remains closed), you can tune, transmit and receive on the VFO, or select and operate on other memories.
6. If a station you wish to talk with appears on the Priority channel, press the **PTT** switch momentarily while receiving their signal (no transmission will occur) to halt Priority scanning. Otherwise, when a signal appears on the Priority channel, Priority monitoring will just pause on the channel. Priority monitoring will resume.
7. To cancel Priority monitoring, press again the **[B]**(PRI) key.

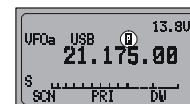



# SCANNING OPERATION

## PROGRAMMABLE MEMORY SCAN (PMS) OPERATION

To limit scanning (and manual tuning) within a particular frequency range, you can use the Programmable Memory Scanning (PMS) feature, which utilizes 10 special-purpose memory pairs (“M-P1L/ M-P1U” through “M-P5L/ M-P5U”). The PMS feature is especially useful in helping you to observe any operating sub-band limits which apply to your Amateur license class.

PMS setup is simple to accomplish:

1. Store the upper and lower frequency limits of the desired range into the PMS memory pair (“M-PxL” and “M-PxU”)
2. Switch to the Memory mode by pressing the **V/M** key once, then rotate the **DIAL** to select the Memory channel “M-PxL” or “M-PxU”.
3. Press the **[F]** key momentarily, then rotate the **MEM/VFO CH** knob, as needed, until Multi Function Row “f” [ARTS, SRCH, PMS] appears on the display.
4. Press the **[C]**(PMS) key. The “PMS-x” indication will appear at the upper left corner of the LCD, signifying that the PMS feature is engaged. Tuning and scanning (by pressing the **[A]**(SCN) key on the Multi Function Row “g” [SCN, PRI, DW]) are now limited within the range between the selected PMS memory pair, keeping operation inside this programmed range.

**Example:** Limit tuning & scanning to the frequency range 144.30 - 148.00 MHz

1. Press the **V/M** key, as necessary, to recall the VFO mode. Tune the **MEM/VFO CH** or **DIAL** knob to 144.300 MHz.
2. Press the **[F]** key momentarily, then rotate the **MEM/VFO CH** knob, as needed, until Multi Function Row “b” [MW, SKIP, TAG] appears on the display.
3. Press the **[A]**(MW) key momentarily, then turn the **MEM/VFO CH** knob to select memory channel “M-P1L.”
4. Press and hold in the **[A]**(MW) key for one second to write the VFO frequency into “M-P1L.”
5. Now, tune the **MEM/VFO CH** or **DIAL** knob to 148.000 MHz.  
Press the **[A]**(MW) key momentarily, then turn the **MEM/VFO CH** knob to select memory channel “M-P1U.”
6. Press and hold the **[A]**(MW) key for one second to write the VFO frequency into “M-P1U.”
7. Press the **[F]** key momentarily, then rotate the **MEM/VFO CH** knob one click clockwise to recall Multi Function Row “f” [ARTS, SRCH, PMS].
8. Press the **[C]**(PMS) key momentarily. Tuning and scanning are now limited to the 144.30 - 148.00 MHz range until you press the **V/M** key to return to memory or VFO operation.

## DUAL WATCH OPERATION

Dual Watch is similar, in some respects, to scanning. In Dual Watch, however, the transceiver monitors (squelsched) on the VFO-A frequency while periodically checking VFO-B for activity (or vice-versa). A typical example might be for you to set VFO-A to 50.110 MHz, watching for DX stations who might call CQ on that frequency, while periodically checking 28.885 MHz for stations reporting band openings on 6 meters.

To activate Dual Watch:

1. Set up transmit and receive operation on VFO-A, establishing your primary monitoring frequency. Set up the frequency to be checked periodically on VFO-B.
2. Recall VFO-A, then rotate the **SQL** control until the background noise is just silenced.
3. Press the **[F]** key momentarily, then rotate the **MEM/VFO CH** knob, as needed, until Multi Function Row “g” [SCN, PRI, DW] appears on the display.
4. Press the **[C]**(DW) key momentarily to activate Dual Watch operation (the “**DW**” icon will appear at the upper of the frequency display). The transceiver will continue to monitor (squelsched) on the current (VFO-A) frequency, but every five seconds will switch briefly to VFO-B frequency, looking for activity.
5. If a station is detected on the VFO-B frequency, the transceiver will pause on the VFO-B frequency (the decimal point in the frequency will blink).
6. Press the **[C]**(DW) key again to cancel Dual Watch operation (the “**DW**” icon will disappear).

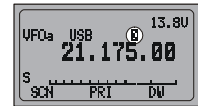

*Note that pressing the PTT switch on the microphone does not cancel Dual Watch operation.*

---

---

## OPERATION ON ALASKA EMERGENCY FREQUENCY: 5167.5 kHz (U.S. VERSION ONLY)

---

---

Section 97.401(d) of the regulations governing amateur radio in the United States permit emergency amateur communications on the spot frequency of 5167.5 kHz by stations in (or within 92.6 km of) the state of Alaska. This frequency is only to be used when the *immediate safety of human life and/or property* are threatened, and is never to be used for routine communications.

The **FT-897D** includes the capability for transmission and reception on 5167.5 kHz under such emergency conditions via the Menu system. To activate this feature:

1. Press and hold in the **[F]** button for one second to activate the Menu mode.
2. Rotate the **MEM/VFO CH** knob to select Menu Mode No-050 [EMERGENCY].
3. Rotate the **DIAL** knob to select “ON.”
4. Press and hold in the **[F]** button for one second to exit the Menu mode.

Emergency communication on this spot frequency is now possible:

5. Press the **V/M** key, as necessary, to enter the Memory mode, then rotate the **MEM/VFO CH** knob to select the emergency channel (M-EMG), which is found between channels M-P5U and M-001.
6. Note that the receive-mode CLARIFIER functions normally while using this frequency, but variation of the transmit frequency is not possible. Activation of Menu Mode No-050 [EMERGENCY] does not enable any other out-of-amateur-band capability on the transceiver. The full specifications of the **FT-897D** are not necessarily guaranteed on this frequency, but power output and receiver sensitivity should be fully satisfactory for the purpose of emergency communication.
7. If you wish to disable operation capability on the Alaska Emergency Frequency, repeat the procedure detailed above, but set Menu Mode No-050 [EMERGENCY] to “OFF” in step 3 of the procedure.

In an emergency, note that a half-wave dipole cut for this frequency should be approximately 45’3” on each leg (90’6” total length). Emergency operation on 5167.5 kHz is shared with the Alaska-Fixed Service. This transceiver is not authorized for operation, under the FCC’s Part 87, for aeronautical communications.

---

---

## CW TRAINING FEATURE

---

---

The **FT-897D** provides a CW Training feature, which sends random Morse Code five-character groups via the sidetone (heard in the speaker), so you can improve your CW proficiency whether or not the bands are open.

1. Press and hold in the **[F]** key for one second to enter the Menu mode.
2. Rotate the **MEM/VFO CH** knob to select Menu Mode No-031 [CW TRAINING].
3. Rotate the **DIAL** to select the Training mode:  
N: Numeric characters only  
A: Alphabet characters only  
AN: Numeric and Alphabet characters (Mixed)
4. Press the **[B]**(STRT) key to begin generation of the five-character code groups (CW sidetone only, does not key the transmitter).
5. When the code group is completed, code, the “Answer” will appear on the display.
6. Press the **[B]**(STRT) key to generate another code group, as above.
7. To disable the CW Training feature, press and holding the **[F]** key for one second to exit to normal operation.



*You may adjust the Morse speed by the Menu Mode No-030 [CW SPEED].*

---

---

## PROGRAMMING THE PANEL KEY FUNCTIONS

---

---

The Function (**[A]**, **[B]**, **[C]**) keys in Multi Function Row “q” [PG A, PG B, PG C], may each be assigned the function of a particular key. These may be used to create a custom set of “hot keys” to often-used functions from other Multi Function Rows.

To assign the key functions:

1. Press and hold in the **[F]** button for one second to activate the Menu mode.
2. Rotate the **MEM/VFO CH** knob to select Menu Mode corresponding to the key to be assigned a function (No-065: [PG A] key, No-066: [PG B] key, No-067: [PG C] key).
3. Rotate the **DIAL** knob to select the feature or function you wish to assigned to the key.
4. When you have completed the set-up, press and hold in the **[F]** button for one second to exit the Menu mode.

# MISCELLANEOUS SETTINGS

## BEACON FEATURE

The **FT-897D**'s unique "Beacon" feature allow you to set up the transceiver to send a repetitive message. For example, on a DX-pedition, the **FT-897D** beacon might be activated on a 50 MHz frequency, to alert DXers as to possible band openings.

### Beacon Text Storage

1. Press and hold in the **[F]** key for one second to enter the Menu mode.
2. Rotate the **MEM/VFO CH** knob to select Menu Mode No-011 [BEACON TEXT 1].
3. Press the **MEM/VFO CH** knob to enable storage of the Beacon Text (the first character location will be underlined).
4. Rotate the **DIAL** to select the first character (number or letter) in the Beacon Text you wish to store, then rotate the **MEM/VFO CH** knob one click clockwise to move to the next character.
5. Repeat step 4 as many times as necessary to complete the Beacon Text.
  - If the Beacon Text is less than 40 characters long, add the "⏏" mark after the last character to terminate the text, then press the **MEM/VFO CH** knob.
  - If the Beacon Text is more than 40 characters long, but less than 79, set the last (40th) character to be "⏏," press the **MEM/VFO CH** knob, then rotate the **DIAL** to select "BEACON TEXT 2." Now repeat step 4.
  - If the Beacon Text is more than 79 characters long, up to 118 characters may be stored. In this case, set the final character slot in "BEACON TEXT 2" to be "⏏," press the **MEM/VFO CH** knob, then rotate the **DIAL** to select "BEACON TEXT 3." Now repeat step 4.
  - Do not forget to install the "⏏" mark after the last character, to terminate the text.
6. Press and hold in the **[F]** key for one second until you hear a double beep; the second beep confirms that the Beacon text was successfully stored.

### Beacon Transmission (On the Air)

1. Press and hold in the **[F]** key for one second to enter the Menu mode.
2. Rotate the **MEM/VFO CH** knob to select Menu Mode No-012 [BEACON TIME].
3. Rotate the **DIAL** to select the interval time (between message and message) (1 ~ 255 seconds).
4. Press and hold in the **[F]** key for one second to exit to normal operation.
5. Press the **[F]** key momentarily, then rotate the **MEM/VFO CH** knob, as needed, until Multi Function Row "o" [PLY1, PLY2, PLY3] appears on the display.
6. Press the **[A]**(PLY1) key to activate the Beacon Feature.

**NOTE:** When using the "beacon" feature, please disable the "VOX" feature.



*If you press **[B]**(PLY2) or **[C]**(PLY3), the message will be transmitted, after which the transmission will halt. Operationally, these two keys function the same as a traditional CW message keyer.*

7. To disable the transmission from the Beacon, just repeat the above procedure, rotating the **DIAL** to select "OFF" in step 3 above.



*You may adjust the CW speed using Menu Mode No-030 [CW SPEED].*

You may also send the Beacon Text manually. If this is done, all three "Beacon" messages may be used as a traditional CW message keyer. To do this:

1. Press and hold in the **[F]** key for one second to enter the Menu mode.
2. Rotate the **MEM/VFO CH** knob to select Menu Mode No-012 [BEACON TIME].
3. Rotate the **DIAL** to select "OFF."
4. Press and hold in the **[F]** key for one second to exit to normal operation.
5. Press the **[F]** key momentarily, then rotate the **MEM/VFO CH** knob, as needed, until Multi Function Row "o"[PLY1, PLY2, PLY3] appears on the display.
6. Press the **[A]**(PLY1) key momentarily to send the "BEACON TEXT 1" message.

Alternatively, pressing the **[B]**(PLY2) or **[C]**(PLY3) key will initiate the message at those respective break points.

## DISPLAY CUSTOMIZATION

### Display Lamp Mode

The **FT-897D** illumination lamp has four options for activation of the illumination.

To set up the Lamp mode:

1. Press and hold in the **[F]** button for one second to activate the Menu mode.
2. Rotate the **MEM/VFO CH** knob to select Menu Mode No-044 [DISP MODE].
3. Rotate the **DIAL** knob select the desired mode. Available selections are:

OFF: Disables the LCD illumination.

AUTO1: Illuminates the LCD for three seconds when any button is pressed, or if you rotate the **MEM/VFO CH** knob.

AUTO2: Illuminates the LCD continuously while the **FT-897D** is operating on an *external* power supply. When using the **FNB-78** internal battery in the AUTO2 mode, the LCD will light up for three seconds when any button is pressed, or if you rotate the **MEM/VFO CH** knob (identical to AUTO1 mode).

ON: Illuminates the LCD continuously.

4. When you have completed your selection, press and hold in the **[F]** button for one second to exit the Menu mode.

### Display Contrast

The LCD's contrast may be adjusted using the Menu Mode, as well.

1. Press and hold in the **[F]** button for one second to activate the Menu mode.
2. Rotate the **MEM/VFO CH** knob to select Menu Mode No-042 [DISP CONTRAST].
3. Rotate the **DIAL** knob to adjust the contrast. As you make the adjustment, you will be able to see the effects of you changes.
4. When you have completed the adjustment, press and hold in the **[F]** button for one second to exit the Menu mode.

### Display Dimmer

The LCD illumination may also be adjusted using the Menu Mode.

1. Press and hold in the **[F]** button for one second to activate the Menu mode.
2. Rotate the **MEM/VFO CH** knob to select Menu Mode No-043 [DISP INTENSITY].
3. Rotate the **DIAL** knob to adjust the display illumination for a comfortable brightness level. As you make the adjustment, you will be able to see the effects of you changes.
4. When you have completed the adjustment, press and hold in the **[F]** button for one second to exit the Menu mode.

### Display Color

The LCD color may be changed using the Menu Mode for different operating status conditions. For example, the display may be configured to show a different color according to ARTS status, by Band, by Memory Group, by VFO/Memory/HOME/QMB status, or may be set to indicate different colors according to meter indication (i.e. signal strength, power output, etc.). Two banks ("1" and "2") of color combination patterns are available for all selections except "FIX."

1. Press and hold in the **[F]** button for one second to activate the Menu mode.
2. Rotate the **MEM/VFO CH** knob to select Menu Mode No-041 [DISP COLOR].
3. Rotate the **DIAL** to select the desired operating status which you wish utilize. The default selections are:

ARTS: The color changes depending on the "In Range" or "Out of Range" status.

BAND: The color changes according to the Band in use.

FIX: This is a fixed color.

MEMGRP: The color changes according to the selected Memory Group.

MODE: The color changes according to the selected Mode.

MTR: The color changes according to the S-meter, PWR-meter, MOD-meter, SWR-meter, or ALC-meter reading.

VFO: The color changes according to the VFO/Memory/HOME/QMB status.

4. Press the **MEM/VFO CH** knob momentarily, then rotate the **DIAL** to select the desired color bank to be utilized in conjunction with the selection made in step 3.
5. Press the **MEM/VFO CH** knob momentarily, then rotate the **DIAL** to select the desired color to be utilized for this function, in place of the default color.
6. When you have completed your selection(s), press and hold in the **[F]** button for one second to exit the Menu mode.

# MENU OPERATION

The Menu System allows you to customize a wide variety of transceiver performance aspects and operating characteristics. Once you have gone through the various Menu customization procedures initially, you will find that you will not have to resort to them frequently during everyday operation.

## MENU OPERATION

1. Press and hold in the [F] key for one second. The Menu Item number and a title for the Menu Mode will appear in the display.
2. Rotate the **MEM/VFO CH** knob to select the Menu Item you wish to work on.
3. When you have chosen the desired Menu Item number, rotate the **DIAL** knob to change the value or condition for the Menu Item.
4. When you have made your selection, press and hold in the [F] key for one second to save the new setting and exit to the normal operation.



- 1) In step 3 above, if you press the [HOME] key momentarily, it will reset the setting of that Menu Item to its factory-default value.
- 2) In step 4 above, if you press the [C] key momentarily, you will exit to normal operation without saving the new setting.
- 3) In step 2 above, press the [A] key momentarily, The “hyphen” in the Menu channel number will change to become a “dot”; this shows that this Menu now is not included in the recall the Menu Item loop.

No	Menu Item	Function	Available Values	Default
001	EXT MENU	Enables/Disables the extended Menu Mode.	ON/OFF	OFF
002	144MHz ARS	Activates/deactivates the Automatic Repeater Shift feature when operating on the 144 MHz band.	ON/OFF	×1
003	430MHz ARS	Activates/deactivates the Automatic Repeater Shift feature when operating on the 430 MHz band.	ON/OFF	×1
004	AM&FM DIAL	Enabling/disabling the DIAL knob on the AM and FM modes.	ENABLE/DISABLE	DISABLE
005	AM MIC GAIN	Adjusts the microphone gain level for the AM mode.	0 ~ 100	50
006	AM STEP	Selects the tuning steps for the MEM/VFO CH knob on the AM mode.	2.5/5/9/10/12.5/25kHz	×1
007	APO TIME	Selects the Auto Power Off time (time before power goes off).	OFF/1h ~ 6h	OFF
008	ARTS BEEP	Selects the ARTS beep mode.	OFF/RANGE/ALL	RANGE
009	ARTS ID	Enables/disables the CW identifier during ARTS operation.	ON/OFF	OFF
010	ARTS IDW	Stores your callsign into the CW identifier.	–	YAESU
011	BEACON TEXT 1	Stores the message for the Beacon.	–	–
012	BEACON TIME	Selects the interval time (between message and message).	OFF/1 sec ~ 255 sec	OFF
013	BEEP TONE	Selects the beep frequency.	440/880/1760 Hz	880 Hz
014	BEEP VOL	Selects the beep volume level.	0 ~ 100	50
015	CAR LSB R	Sets the Rx Carrier Point for LSB.	–300 ~ +300 Hz	0 Hz
016	CAR LSB T	Sets the Tx Carrier Point for LSB	–300 ~ +300 Hz	0 Hz
017	CAR USB R	Sets the Rx Carrier Point for USB	–300 ~ +300 Hz	0 Hz
018	CAR USB T	Sets the Tx Carrier Point for USB	–300 ~ +300 Hz	0 Hz
019	CAT RATE	Sets the transceiver’s circuitry for the CAT baud rate to be used.	4800bps/9600bps/38400bps	4800bps
020	CAT/LIN/TUN	Selects the device which is connected to the CAT/LINEAR jack on the rear panel.	CAT/LINEAR/TUNER	CAT
021	CLAR DIAL SEL	Defines the “control” knob to be used for setting of the clarifier offset frequency.	CLAR, M/V, MAIN	CLAR
022	CW AUTO MODE	Selects whether the KEY jack shall be “Enabled” or “Disabled” while using the SSB/FM modes.	ON/OFF	OFF
023	CW BFO	Sets the CW carrier oscillator injection side on the CW mode.	USB/LSB/AUTO	USB
024	CW DELAY	Sets the receiver recovery time during pseudo-VOX CW semi-break-in operation.	FULL/30 ~ 3000 msec	250 msec
025	CW KEY REV	Sets the keyer paddle’s wiring configuration.	NORMAL/REVERSE	NORMAL
026	CW PADDLE	Enables/disables CW keying by the microphone’s [UP]/[DWN] keys.	ELEKEY/MICKEY	ELEKEY
027	CW PITCH	Setting of the pitch of the CW sidetone, BFO offset, and CW filter center frequencies.	400 ~ 800 Hz	700 Hz
028	CW QSK	Selects the time delay between when the PTT is keyed and the carrier is transmitted during QSK operation when using the internal keyer.	10/15/20/25/30 ms	10 ms
029	CW SIDE TONE	Setting of the CW sidetone volume level.	0 ~ 100	50
030	CW SPEED	Sets the sending speed for the built-in Electronic keyer.	4 ~ 60 wpm (1wpm/step)/ 20 ~ 300 cpm (5cpm/step)	12 wpm (60 cpm)
031	CW TRAINING	Sends random Morse Code five-character groups via the sidetone.	N, A, AN	N
032	CW WEIGHT	Sets the Dot:Dash ratio for the built-in electronic keyer.	1:2.5 ~ 1:4.5	1:3.0
033	DCS CODE	Setting of the DCS code.	104 Standard DCS codes	023
034	DCS INV	Selects “Normal” or “Inverted” DCS coding.	Tn-Rn/Tn-Riv/Tiv-Rn/Tiv-Riv	Tn-Rn
035	DIAL STEP	Setting of the DIAL knob’s tuning speed.	FINE/COARSE	FINE
036	DIG DISP	Defines the displayed frequency offset during DIG (USER-L or USER-U) mode operation.	–3000 ~ +3000 Hz	0 Hz
037	DIG GAIN	Adjusts the audio input level from terminal equipment during DIG (Digital) mode operation.	0 ~ 100	50
038	DIG MODE	Selects the mode and sideband in the DIG (Digital) mode.	RTTY-L/RTTY-U/PSK31-L/ PSK31-U/USER-L/USER-U	RTTY-L
039	DIG SHIFT	Defines the carrier frequency offset during DIG (USER-L or USER-U) mode operation.	–3000 ~ +3000 Hz	0 Hz

No	Menu Item	Function	Available Values	Default
040	DIG VOX	Sets the gain of the VOX circuitry's input level for the DIG mode.	0 ~ 100	0
041	DISP COLOR	Selects the illumination color for each operating status.	–	–
042	DISP CONTRAST	Setting of the display contrast level.	0 ~ 13	5
043	DISP INTENSITY	Setting of the display brightness level.	0 (Dim) ~ 3 (Bright)	3
044	DISP MODE	Sets up the LCD Lamp mode.	OFF/AUTO1/AUTO2/ON	AUTO2
045	DSP BPF WIDTH	Setting of the bandwidth for the DSP CW audio filter.	60/120/240 Hz	240 Hz
046	DSP HPF CUTOFF	Adjusts the low-cut characteristics of the DSP HPF filter.	100 ~ 1000 Hz	100 Hz
047	DSP LPF CUTOFF	Adjusts the high-cut characteristics of the DSP LPF filter.	1000 ~ 6000 Hz	6000 Hz
048	DSP MIC EQ	Sets the DSP microphone equalization pattern.	OFF/LPF/HPF/BOTH	OFF
049	DSP NR LEVEL	Setting of the degree of DSP Noise Reduction.	1 ~ 16	8
050	EMERGENCY	Enables Tx/Rx operation on the Alaska Emergency Channel, 5167.5 kHz.	ON/OFF	OFF
051	FM MIC GAIN	Adjusts the microphone gain level for the FM mode.	0 ~ 100	50
052	FM STEP	Selects the tuning steps for the MEM/VFO CH knob in the FM mode.	5/6.25/10/12.5/15/20/25/ 50 kHz	×2
053	HOME-->VFO	Enables/disables the moving of HOME channel data to the VFO.	ON/OFF	ON
054	LOCK MODE	Selects the operation of the front panel's LOCK key.	DIAL/FREQ/PANEL/ALL	DIAL
055	MEM GROUP	Enables/disables the memory grouping feature.	ON/OFF	OFF
056	MEM TAG	Stores Alpha-Numeric "Tags" for the memory channels.	–	–
057	MEM/VFO DIAL MODE	Selects the function which is engaged when you press the MEM/VFO CH knob.	CW SIDETONE, CW SPEED, MHz/MEM GRP, MIC GAIN, NB LEVEL, RF POWER, STEP	MHz/MEM GRP
058	MIC SCAN	Enables/disables scanning access via the microphone's [UP]/[DWN] keys.	ON/OFF	ON
059	MIC SEL	The choice of the equipment which connects to the MIC jack.	NOR/RMT/CAT	NOR
060	MTR ARX SEL	Select the meter display configuration while the transceiver is receiving.	SIG, CTR, VLT, N/A, FS, OFF	SIG
061	MTR ATX SEL	Selects the meter display configuration while the transceiver is transmitting.	PWR, ALC, MOD, SWR, VLT, N/A, OFF	PWR
062	MTR PEAK HOLD	Enabling/disabling of the "peak hold" function of the meter.	ON/OFF	ON
063	NB LEVEL	Setting of the blanking level for the IF Noise Blanker.	0 ~ 100	50
064	OP FILTER 1	Not available at this time.	–	–
065	PG A	Programming the [A] key (in the Operating Function Row 17) function.	All Multi Function, all Menu Item, MONI, Q.SPL, TCALL, ATC, and USER.	MONI
066	PG B	Programming the [B] key (in the Operating Function Row 17) function.		Q.SPL
067	PG C	Programming the [C] key (in the Operating Function Row 17) function.		ATC
068	PG ACC	Programming the optional MH-59A8J microphone's [ACC] button assignment.		MONI
069	PG P1	Programming the optional MH-59A8J microphone's [P1] button assignment.		Q.SPL
070	PG P2	Programming the optional MH-59A8J microphone's [P2] button assignment.		TCALL
071	PKT 1200	Adjusts the audio input level from the TNC during 1200 bps Packet operation.	0 ~ 100	50
072	PKT 9600	Adjusts the audio input level from the TNC during 9600 bps Packet operation.	0 ~ 100	50
073	PKT RATE	Sets the transceiver's circuitry for the Packet baud rate to be used.	1200/9600 (bps)	1200 bps
074	PROC LEVEL	Sets the compression level for the AF speech processor in the SSB/AM modes.	0 ~ 100	50
075	RF POWER SET	Setting of the maximum power level for the current band.	5 ~ 100	100
076	RPT SHIFT	Sets the magnitude of the repeater shift.	0.00 ~ 99.99 (MHz)	×2
077	SCAN MODE	Selects the desired Scan-Resume mode.	TIME/BUSY/STOP	TIME
078	SCAN RESUME	Sets the delay time for scanning resumption.	1 ~ 10 (sec)	5 sec
079	SPLIT TONE	Enables/disables split CTCSS/DCS coding.	ON/OFF	OFF
080	SQL/RF GAIN	Selects the configuration of the front panel's SQL/RF knob.	RF-GAIN/SQL	×1
081	SSB MIC GAIN	Adjusts the microphone gain level for the SSB mode.	0 ~ 100	50
082	SSB STEP	Selects the tuning steps for the MEM/VFO CH knob on the SSB mode.	1kHz/2.5kHz/5kHz	2.5 kHz
083	TONE FREQ	Setting of the CTCSS Tone Frequency.	50 Standard CTCSS tones	88.5 Hz
084	TOT TIME	Select the Automatic Power Off time.	OFF/1 ~ 20 (min)	OFF
085	TUNER/ATAS	Selects the device (FC-30 or ATAS-100/-120) to be controlled via the front panel's [A](TUNE) key.	OFF/ATAS(HF)/ATAS(HF&50) /ATAS(ALL)/TUNER	OFF
086	TX IF FILTER	Selects the Transmit IF filter.	CFIL/FIL1/FIL2	CFIL
087	VOX DELAY	Sets the "hang time" for the VOX circuitry.	100 ~ 3000 (ms)	500 ms
088	VOX GAIN	Sets the gain of the VOX circuitry's input audio detector.	1 ~ 100	50
089	XVTR A FREQ	Allows an arbitrary frequency to be set on the display, to allow direct frequency readout during transverter operation.	00,000,00 ~ 99,999,99 (kHz)	–
090	XVTR B FREQ			
091	XVTR SEL	Enables/disables/selects the antenna port to be used for Transverter operation.	OFF/X VTR A/X VTR B	OFF

※1: Depends Mon transceiver version.

※2: Depends on operating band and transceiver version.



# MENU OPERATION

## MENU MODE No-001 [EXT MENU]

**Function:** Enables/Disables the extended Menu Mode.

**Available Values:** ON/OFF

**Default:** OFF

## MENU MODE No•002 [144 MHz ARS]

**Function:** Activates/deactivates the Automatic Repeater Shift feature when operating on the 144 MHz band.

**Available Values:** ON/OFF

**Default:** ON (depending on transceiver version)

## MENU MODE No•003 [430 MHz ARS]

**Function:** Activates/deactivates the Automatic Repeater Shift feature when operating on the 430 MHz band.

**Available Values:** ON/OFF

**Default:** ON (depending on transceiver version)

## MENU MODE No•004 [AM&FM DIAL]

**Function:** Enabling/disabling of the DIAL knob on the AM and FM modes.

**Available Values:** ENABLE/DISABLE

**Default:** DISABLE

## MENU MODE No-005 [AM MIC GAIN]

**Function:** Adjusts the microphone gain level for the AM mode.

**Available Values:** 0 ~ 100

**Default:** 50

## MENU MODE No-006 [AM STEP]

**Function:** Selects the tuning steps for the MEM/VFO CH knob on the AM mode.

**Available Values:** 2.5/5/9/10/12.5/25kHz

**Default:** 5 kHz (depending on transceiver version)

## MENU MODE No-007 [APO TIME]

**Function:** Selects the Auto Power Off time (time before power goes off).

**Available Values:** OFF/1h ~ 6h

**Default:** OFF

## MENU MODE No•008 [ARTS BEEP]

**Function:** Selects the ARTS beep mode.

**Available Values:** OFF/RANGE/ALL

**Default:** RANGE

OFF: No alert beeps sound; you must look at the display to determine current ARTS status.

RANGE: A high tone beep will sound when the transceiver first detects that you are within range, and a low beep will sound when the other station goes out of range.

ALL: A high tone beep will sound every time a polling transmission is received from the other station, and a low beep will sound once when the other station goes out of range.

## MENU MODE No•009 [ARTS ID]

**Function:** Enables/disables the CW identifier during ARTS operation.

**Available Values:** ON/OFF

**Default:** OFF

## MENU MODE No•010 [ARTS IDW]

**Function:** Stores your callsign into the CW identifier. Up to ten characters may be stored. The storage procedure is as follows:

1. Press the **MEM/VFO CH** knob momentarily to initiate callsign storage (the first character location of the callsign will be underlined).
2. Rotate the **DIAL** knob to select the first letter/number of your callsign, then rotate the **MEM/VFO CH** knob one click clockwise to save the first letter/number and move to the next entry position.
3. Repeat the previous step as many times as necessary to complete your callsign.
4. Press the **MEM/VFO CH** knob to save your completed callsign and exit.

**Default:** YAESU

## MENU MODE No•011 [BEACON TEXT 1]

**Function:** Stores the message for the Beacon. Up to 40 characters may be stored. The storage procedure is as follows:

1. Press and hold in the [**F**] key for one second to enter the Menu mode.
2. Rotate the **MEM/VFO CH** knob to select Menu Mode No-011 [BEACON TEXT 1].
3. Press the **MEM/VFO CH** knob to enable storage of the Beacon Text (the first character location will be underlined).
4. Rotate the **DIAL** to select the first character (number or letter) in the Beacon Text you wish to store, then rotate the **MEM/VFO CH** knob one click clockwise to move to the next character.
5. Repeat step 4 as many times as necessary to complete the Beacon Text.

If the Beacon Text is less than 40 characters or more than 40 characters, see page 50 for details.

## MENU MODE No•012 [BEACON TIME]

**Function:** Selects the interval time (between message and message).

**Available Values:** OFF/1 sec ~ 255 sec

**Default:** OFF

## MENU MODE No•013 [BEEP TONE]

**Function:** Selects the beep frequency.

**Available Values:** 440/880/1760 Hz

**Default:** 880 Hz

## MENU MODE No-014 [BEEP VOL]

**Function:** Selects the beep volume level.

**Available Values:** 0 ~ 100

**Default:** 50

Press the [**B**] key to monitor the level during adjustment.

## MENU MODE No•015 [CAR LSB R]

**Function:** Sets the Rx Carrier Point for LSB.

**Available Values:** -300 ~ +300 Hz

**Default:** 0 Hz

## MENU MODE No•016 [CAR LSB T]

**Function:** Sets the Tx Carrier Point for LSB

**Available Values:** -300 ~ +300 Hz

**Default:** 0 Hz

## MENU MODE No•017 [CAR USB R]

**Function:** Sets the Rx Carrier Point for USB

**Available Values:** -300 ~ +300 Hz

**Default:** 0 Hz

## MENU MODE No•018 [CAR USB T]

**Function:** Sets the Tx Carrier Point for USB

**Available Values:** -300 ~ +300 Hz

**Default:** 0 Hz

## MENU MODE No•019 [CAT RATE]

**Function:** Sets the transceiver's circuitry for the CAT baud rate to be used.

**Available Values:** 4800bps/9600bps/38400bps

**Default:** 4800bps

## MENU MODE No•020 [CAT/LIN/TUN]

**Function:** Selects the device which is connected to the **CAT**/LINEAR jack on the rear panel.

**Available Values:** CAT/LINEAR/TUNER

**Default:** CAT

## MENU MODE No•021 [CLAR DIAL SEL]

**Function:** Defines the "control" knob to be used for setting of the clarifier offset frequency.

**Available Values:** CLAR, M/V, MAIN (Clarifier/Selector/Main Dial Knobs)

**Default:** CLAR

## MENU MODE No-022 [CW AUTO MODE]

**Function:** Selects whether the KEY jack shall be "Enabled" or "Disabled" while using the SSB/FM modes.

**Available Values:** ON/OFF

**Default:** OFF

OFF: The KEY jack is enabled on the CW mode only.

ON: The KEY jack is enabled on all modes (SSB mode: A1, FM mode: F2). Thus, on SSB, you can ask a station for a CW QSO without having to change your **FT-897D**'s Mode selection, if Menu #022 is set to "On."

## MENU MODE No•023 [CW BFO]

**Function:** Sets the CW carrier oscillator injection side on the CW mode.

**Available Values:** USB/LSB/AUTO

**Default:** USB

USB: Injects the CW carrier oscillator on the USB side

LSB: Injects the CW carrier oscillator on the LSB side

AUTO: Injects the CW carrier oscillator on the LSB side while operating on the 10 MHz band and below, USB side while operate on the 10 MHz band and up.

## MENU MODE No-024 [CW DELAY]

**Function:** Sets the receiver recovery time during pseudo-VOX CW semi-break-in operation.

**Available Values:** FULL/30 ~ 3000 msec

**Default:** 250 msec

The recovery time may be adjusted in steps of 10 msec. A longer delay may be preferable if you pause frequently while sending.

## MENU MODE No•025 [CW KEY REV]

**Function:** Sets the keyer paddle's wiring configuration.

**Available Values:** NORMAL/REVERSE

**Default:** NORMAL

NORMAL: Keyer paddle polarity is normal. The "tip" plug connection produces dots, and the "ring" plug connection produces dashes.

REVERSE: Keyer paddle polarity is inverted. The "tip" paddle produces dashes, and the "ring" paddle produces dots.

## MENU MODE No•026 [CW PADDLE]

**Function:** Enables/disables CW keying by the microphone's [UP]/[DWN] keys.

**Available Values:** ELEKEY/MICKEY

**Default:** ELEKEY

When this Menu Item is set to "MICKEY," press the microphone's [UP] key to send a "dot," and press the microphone's [DWN] key to send a "dash" (while the built-in electronic keyer is engaged).

## MENU MODE No-027 [CW PITCH]

**Function:** Setting of the pitch of the CW sidetone, BFO offset, and CW filter center frequencies.

**Available Values:** 400 ~ 800 Hz

**Default:** 700 Hz

The CW pitch may be adjusted in steps of 100 Hz.

## MENU MODE No•028 [CW QSK]

**Function:** Selects the time delay between when the **PTT** is keyed and the carrier is transmitted during QSK operation when using the internal keyer.

**Available Values:** 10/15/20/25/30 ms

**Default:** 10 ms

*Note: If you select "25 (or 30) ms," please do not attempt to set Menu [No-030 CW SPEED] to a speed faster than "50 (42) wpm," as the delay will make it impossible to transmit.*

## MENU MODE No-029 [CW SIDE TONE]

**Function:** Setting of the CW sidetone volume level.

**Available Values:** 0 ~ 100

**Default:** 50

# MENU OPERATION

## MENU MODE No-030 [CW SPEED]

**Function:** Sets the sending speed for the built-in Electronic keyer.

**Available Values:** 4wpm ~ 60 wpm (1wpm/step)/20cpm ~ 300 cpm (5cpm/step)

**Default:** 12 wpm (60 cpm)

You can set the sending speed according to either of two units of speed (wpm: words per minute; cpm: characters per minute)

To switch units between “wpm” and “cpm,” just press the **MEM/VFO CH** knob.

## MENU MODE No•031 [CW TRAINING]

**Function:** Sends random Morse Code five-character groups via the sidetone.

**Available Values:** N / A / AN

**Default:** N

N: Numeric characters only

A: Alphabet characters only

AN: Numeric and Alphabet characters (Mixed)

## MENU MODE No•032 [CW WEIGHT]

**Function:** Sets the Dot:Dash ratio for the built-in electronic keyer.

**Available Values:** 1:2.5 ~ 1:4.5

**Default:** 1:3.0

## MENU MODE No-033 [DCS CODE]

**Function:** Setting of the DCS code.

**Available Values:** 104 Standard DCS codes

**Default:** 023

You can set the DSC codes for Encode and Decode separately.

To switch between “ENCODE” and “DECODE,” just press the **MEM/VFO CH** knob.

## MENU MODE No•034 [DCS INV]

**Function:** Selects “Normal” or “Inverted” DCS coding.

**Available Values:** Tn-Rn/Tn-Riv/Tiv-Rn/Tiv-Riv

**Default:** Tn-Rn

“n” = “normal”

“iv” = “inverted”

## MENU MODE No-035 [DIAL STEP]

**Function:** Setting of the **DIAL** knob’s tuning speed.

**Available Values:** FINE/COARSE

**Default:** FINE

You may choose between two speeds for the DIAL knob. Selecting “COARSE” doubles the tuning rate compared to the default value.

FINE: 10 Hz/step @SSB/CW mode, 100 Hz/step @AM/FM

COARSE: 20 Hz/step @SSB/CW mode, 200 Hz/step @AM/FM

## MENU MODE No•036 [DIG DISP]

**Function:** Defines the displayed frequency offset during DIG (USER-L or USER-U) mode operation.

**Available Values:** -3000 ~ +3000 Hz

**Default:** 0 Hz

## MENU MODE No•037 [DIG GAIN]

**Function:** Adjusts the audio input level from terminal equipment (such as a TNC or PSK-31 sound card) during DIG (Digital) mode operation.

**Available Values:** 0 ~ 100

**Default:** 50

## MENU MODE No•038 [DIG MODE]

**Function:** Selects the mode and sideband (if applicable) in the DIG (Digital) mode.

**Available Values:** RTTY-L/RTTY-U/PSK31-L/PSK31-U/USER-L/USER-U

**Default:** RTTY-L

RTTY-L: AFSK RTTY operation on the LSB mode

RTTY-U: AFSK RTTY operation on the USB mode

PSK31-L: PSK-31 operation on the LSB mode

PSK31-U: PSK-31 operation on the USB mode

USER-L: User-programmed costume operation based on LSB mode

USER-U: User-programmed costume operation based on USB mode



*In the USER-L and USER-U modes, you can define the display frequency offset and carrier frequency offset by Menu Mode No-036 [DIG DISP] and No-039 [DIG SHIFT].*

## MENU MODE No•039 [DIG SHIFT]

**Function:** Defines the carrier frequency offset during DIG (USER-L or USER-U) mode operation.

**Available Values:** -3000 ~ +3000 Hz

**Default:** 0 Hz

## MENU MODE No•040 [DIG VOX]

**Function:** Sets the gain of the VOX circuitry’s input level for the DIG mode.

**Available Values:** 0 ~ 100

**Default:** 0

*Note: When you wish to use “DIG VOX,” press the [F] key momentarily, then rotate the MEM/VFO CH knob, until you reach Multi Function Row “d” [RPT, REV, VOX], then press the [C](VOX) key. The parentheses and “” icon will disappear, signifying that the (SSB/AM/FM voice) VOX system has been turned off. Despite these indicators having disappeared, the Digital Mode “VOX” system will still be active, allowing audio input from a TNC or sound card to engage the transmitter.*

## MENU MODE No-041 [DISP COLOR]

**Function:** Selects the illumination color for each operating status.

**Available Values:** ARTS/BAND/FIX/MEMGRP/MODE/MTR/VFO

**Default:** FIX

## MENU MODE No-042 [DISP CONTRAST]

**Function:** Setting of the display contrast level.

**Available Values:** 1 ~ 13

**Default:** 5

## MENU MODE No-043 [DISP INTENSITY]

**Function:** Setting of the display brightness level.

**Available Values:** 0 (Dim) ~ 3 (Bright)

**Default:** 3

## MENU MODE No-044 [DISP MODE]

**Function:** Sets up the LCD Lamp mode.

**Available Values:** OFF/AUTO1/AUTO2/ON

**Default:** AUTO2

OFF: Disables the LCD illumination.

AUTO1: Illuminates the LCD for three seconds when any button is pressed, or if you rotate the **MEM/VFO CH** knob.

AUTO2: Illuminates the LCD continuously while the **FT-897D** is operating on an external power supply. When using the **FNB-78** internal battery in the AUTO2 mode, the LCD will light up for three seconds when any button is pressed, or if you rotate the **MEM/VFO CH** knob (identical to AUTO1 mode).

ON: Illuminates the LCD continuously.

## MENU MODE No-045 [DSP BPF WIDTH]

**Function:** Setting of the bandwidth for the DSP CW audio filter.

**Available Values:** 60/120/240 Hz

**Default:** 240

## MENU MODE No-046 [DSP HPF CUTOFF]

**Function:** Adjusts the low-cut characteristics of the DSP HPF filter.

**Available Values:** 100/160/220/280/340/400/460/520/580/640/700/760/820/880/940/1000 (Hz)

**Default:** 100



*This Menu Item determines the low-cut frequency of the DSP HPF filter in the SSB, AM, and FM modes. Generally, acceptable voice fidelity will be obtained only if you do not set this parameter much above 400 Hz.*

## MENU MODE No-047 [DSP LPF CUTOFF]

**Function:** Adjusts the high-cut characteristics of the DSP LPF filter.

**Available Values:** 1000/1160/1320/1480/1650/1800/1970/2130/2290/2450/2610/2770/2940/3100/3260/3420/3580/3740/3900/4060/4230/4390/4550/4710/4870/5030/5190/5390/5520/5680/5840/6000 (Hz)

**Default:** 6000



*This Menu Item determines the high-cut frequency of the DSP LPF filter in the SSB, AM, and FM modes. Best voice-mode interference rejection will usually be obtained with a setting of between 2130 and 2770 Hz.*

## MENU MODE No-048 [DSP MIC EQ]

**Function:** Sets the DSP microphone equalization pattern.

**Available Values:** OFF/LPF/HPF/BOTH

**Default:** OFF

OFF: This function is disabled.

LPF: Lower frequencies are emphasized.

HPF: Higher frequencies are emphasized.

BOTH: Mid-range frequencies are emphasized.

## MENU MODE No-049 [DSP NR LEVEL]

**Function:** Setting of the degree of DSP Noise Reduction.

**Available Values:** 1 ~ 16

**Default:** 8

## MENU MODE No-050 [EMERGENCY]: USA Version only

**Function:** Enables Tx/Rx operation on the Alaska Emergency Channel, 5167.5 kHz.

**Available Values:** ON/OFF

**Default:** OFF

When this Menu Item is set to "ON," the spot frequency of 5167.5 kHz will be enabled. To get to this frequency, use the **MEM/VFO CH** knob to navigate; the Alaska Emergency Channel will be found between the Memory channel "M-P20U" and "M-001."



*Use of this frequency is restricted to amateurs operating in (or within 92.6 km of) the U.S. State of Alaska, and it is to be used for emergency communications only (involving the immediate protection of life or property).*

## MENU MODE No-051 [FM MIC GAIN]

**Function:** Adjusts the microphone gain level for the FM mode.

**Available Values:** 0 ~ 100

**Default:** 50

## MENU MODE No-052 [FM STEP]

**Function:** Selects the tuning steps for the **MEM/VFO CH** knob in the FM mode.

**Available Values:** 5/6.25/10/12.5/15/20/25/50 kHz

**Default:** Depends on operating band and transceiver version.

## MENU MODE No-053 [HOME→VFO]

**Function:** Enables/disables the moving of HOME channel data to the VFO.

**Available Values:** ON/OFF

**Default:** ON

Recall the HOME channel, then rotate the "DIAL" or "MEM/VFO CH" knob.

The data will now have been copied to the current VFO, although the original HOME contents will remain intact on the previously-stored HOME channel.

# MENU OPERATION

## MENU MODE No•054 [LOCK MODE]

**Function:** Selects the operation of the front panel's LOCK key.

**Available Values:** DIAL/FREQ/PANEL/ALL

**Default:** DIAL

DIAL: Locks the **DIAL** knob only.

FREQ: Locks the front panel keys and knobs related to frequency control (such as **BAND**(UP) and **BAND**(DWN) key, [**A**](A/B) key., etc.)

PANEL: Locks all front panel keys and knobs (except **POWER** and **LOCK** keys)

ALL: Locks all front panel keys and knobs (except **POWER** and **LOCK** keys) and microphone keys.

## MENU MODE No•055 [MEM GROUP]

**Function:** Enables/disables the memory grouping feature.

**Available Values:** OFF/ON

**Default:** OFF

When this Menu Item is set to "ON," the 200 "standard" memory channels are partitioned into ten Memory Groups, each holding up to 20 memory channels.

MEMORY CHANNEL NUMBER	
MEMORY GROUP "OFF"	MEMORY GROUP "ON"
M-001 ~ M-020	Ma-01 ~ Ma-20
M-021 ~ M-040	Mb-01 ~ Mb-20
M-041 ~ M-060	Mc-01 ~ Mc-20
M-061 ~ M-080	Md-01 ~ Md-20
M-081 ~ M-100	Me-01 ~ Me-20
M-101 ~ M-120	Mf-01 ~ Mf-20
M-121 ~ M-140	Mg-01 ~ Mg-20
M-141 ~ M-160	Mh-01 ~ Mh-20
M-161 ~ M-180	Mi-01 ~ Mi-20
M-181 ~ M-200	Mj-01 ~ Mj-20
M-P1L ~ M-P5U	Mk-1L ~ Mk-5U

## MENU MODE No•056 [MEM TAG]

**Function:** Stores Alpha-Numeric "Tags" for the memory channels.

Up to eight characters may be stored. The storage procedure is as follows:

1. Recall the memory channel onto which you wish to appended a label.
2. Press and hold in the [**F**] key for one second to enter the Menu mode.
3. Rotate the **MEM/VFO CH** knob to recall Menu Mode No-056 [MEM TAG].
4. Press the **MEM/VFO CH** knob to enable the programming of the label.
5. Rotate the **DIAL** knob to select the first character (number, letter, or symbol) in the name you wish to store, then rotate the **MEM/VFO CH** knob clockwise to move to the next character.
6. Again rotate the **DIAL** knob to select the next number, letter, or symbol, then rotate the **MEM/VFO CH** knob clockwise to move to the next character's slot.
7. Repeat step 6 as many times as necessary to complete the name tag for the memory, then press and hold in the [**F**] key for one second to save the A/N (Alpha-Numeric) name entry and exit to normal operation.
8. During Memory operation, press the [**F**] key momen-

tarily, then rotate the **MEM/VFO CH** knob, as needed, until Multi Function Row "b" [MW, MCLR, TAG] appears on the display. Press the [**C**](TAG) key momentarily to activate the alpha-numeric Tag. Repeatedly pressing this key will toggle operation between "Frequency" display and "Tag" display.



*You can recall Menu Mode No-056 [MEM TAG] instantly by pressing and holding in the [**C**](TAG) key for one second.*

## MENU MODE No•057 [MEM/VFO DIAL MODE]

**Function:** Selects the function which is engaged when you press the **MEM/VFO CH** knob.

**Available Values:** CW SIDETONE, CW SPEED, MHz/MEM GRP, MIC GAIN, NB LEVEL, RF POWER/STEP

**Default:** MHz/MEM GRP

## MENU MODE No•058 [MIC SCAN]

**Function:** Enables/disables scanning access via the microphone's [UP]/[DWN] keys.

**Available Values:** OFF/ON

**Default:** ON

## MENU MODE No•059 [MIC SEL]

**Function:** The choice of the equipment which connects to the MIC jack.

**Available Values:** NOR/RMT/CAT

**Default:** NOR

NOR: Normal Microphone.

RMT: Optional **MH-59A8J** Remote Microphone.

CAT: CAT system: if you are using the optional **FC-30** antenna tuner, you can still use the CAT system by connecting the serial Data cable to the MIC jack.

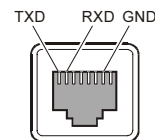

## MENU MODE No•060 [MTR ARX SEL]

**Function:** Select the meter display configuration while the transceiver is receiving.

**Available Values:** SIG, CTR, VLT, N/A, FS, OFF

**Default:** SIG

SIG: Indicates the incoming signal strength.

CTR: Discriminator center meter.

VLT: Indicates the battery voltage.

N/A: Not available at this time.

FS: Applies a calibration signal (1 mA for full scale) at the METER Jack on the transceiver bottom, for adjustment of an external meter's calibration.

You may adjust the external potentiometer in your metering system so that the external meter reading is full scale.

OFF: Disables the meter.

## MENU MODE No•061 [MTR ATX SEL]

**Function:** Selects the meter display configuration while the transceiver is transmitting.

**Available Values:** PWR, ALC, MOD, SWR, VLT, N/A, OFF

**Default:** PWR

PWR: Indicates the relative transmit power.

ALC: Indicates the relative Automatic Level Control voltage.

MOD: Indicates the deviation level.

SWR: Indicates the Standing Wave Ratio (forward:reflected).

VLT: Indicates the battery voltage.

N/A: Not available at this time.

OFF: Disables the meter.

## MENU MODE No-062 [MTR PEAK HOLD]

**Function:** Enabling/disabling of the “peak hold” function of the meter.

**Available Values:** OFF/ON

**Default:** ON

## MENU MODE No-063 [NB LEVEL]

**Function:** Setting of the blanking level for the IF Noise Blanker.

**Available Values:** 0 ~ 100

**Default:** 50

## MENU MODE No•064 [OP FILTER 1]

Not available at this time.

## MENU MODE No•065 [PG A]

**Function:** Programming the [A] key (in the Operating Function Row 17) function.

**Available Values:** All Multi Function , all Menu Item, MONI, Q.SPL, TCALL, ATC and USER.

**Default:** MONI

## MENU MODE No•066 [PG B]

**Function:** Programming the [B] key (in the Operating Function Row 17) function.

**Available Values:** All Multi Function , all Menu Item, MONI, Q.SPL, TCALL, ATC and USER.

**Default:** Q.SPL

## MENU MODE No•067 [PG C]

**Function:** Programming the [C] key (in the Operating Function Row 17) function.

**Available Values:** All Multi Function , all Menu Item, MONI, Q.SPL, TCALL, ATC and USER.

**Default:** ATC

## MENU MODE No•068 [PG ACC]

**Function:** Programming the optional MH-59A8J microphone’s [ACC] button assignment.

**Available Values:** All Multi Functions, all Menu Items (except Menu #065 through 070), MONI, Q.SPL, TCALL, ATC and USER.

**Default:** MONI

## MENU MODE No•069 [PG P1]

**Function:** Programming the optional MH-59A8J microphone’s [P1] button assignment.

**Available Values:** All Multi Functions, all Menu Items (except Menu #065 through 070), MONI, Q.SPL, TCALL, ATC and USER.

**Default:** Q.SPL

## MENU MODE No•070 [PG P2]

**Function:** Programming the optional MH-59A8J microphone’s [P2] button assignment.

**Available Values:** All Multi Functions, all Menu Items (except Menu #065 through 070), MONI, Q.SPL, TCALL, ATC and USER.

**Default:** TCALL

## MENU MODE No•071 [PKT1200]

**Function:** Adjusts the audio input level from the TNC during 1200 bps Packet operation.

**Available Values:** 0 ~ 100

**Default:** 50

## MENU MODE No•072 [PKT9600]

**Function:** Adjusts the audio input level from the TNC during 9600 bps Packet operation.

**Available Values:** 0 ~ 100

**Default:** 50

## MENU MODE No•073 [PKT RATE]

**Function:** Sets the transceiver’s circuitry for the Packet baud rate to be used.

**Available Values:** 1200/9600 (bps)

**Default:** 1200 (bps)

## MENU MODE No-074 [PROC LEVEL]

**Function:** Sets the compression level for the AF speech processor in the SSB/AM modes.

**Available Values:** 0 ~ 100

**Default:** 50

## MENU MODE No-075 [RF POWER SET]

**Function:** Setting of the maximum power level for the current band.

**Available Values:** 5 ~ 100

**Default:** 100

## MENU MODE No-076 [RPT SHIFT]

**Function:** Sets the magnitude of the repeater shift.

**Available Values:** 0.00 ~ 99.99 (MHz)

**Default:** Depends on operating band and transceiver version.



# MENU OPERATION

## MENU MODE No.077 [SCAN MODE]

**Function:** Selects the desired Scan-Resume mode.

**Available Values:** TIME/BUSY/STOP

**Default:** TIME

This Menu Item allows you to select your favorite method of scan-restart after the scanner has stopped on an incoming signal (when the squelch opens).

**TIME:** The scanner will hold for a fixed length of time, set via MENU MODE No.078 [SCAN RESUME], then resume whether or not the other station is still transmitting.

**BUSY:** The scanner will hold until the signal disappears, then will resume after one second.

**STOP:** The scanner will stop when a signal is received, and will not restart.

## MENU MODE No.078 [SCAN RESUME]

**Function:** Sets the delay time for scanning resumption.

**Available Values:** 1 ~ 10 (sec)

**Default:** 5

## MENU MODE No.079 [SPLIT TONE]

**Function:** Enables/disables split CTCSS/DCS coding.

**Available Values:** OFF/ON

**Default:** OFF

## MENU MODE No.080 [SQL/RF GAIN]

**Function:** Selects the configuration of the front panel's SQL/RF knob.

**Available Values:** RF-GAIN/SQL

**Default:** Depends on transceiver version.

## MENU MODE No.081 [SSB MIC GAIN]

**Function:** Adjusts the microphone gain level for the SSB mode.

**Available Values:** 0 ~ 100

**Default:** 50

## MENU MODE No.082 [SSB STEP]

**Function:** Selects the tuning steps for the MEM/VFO CH knob on the SSB mode.

**Available Values:** 1kHz/2.5kHz/5kHz

**Default:** 2.5kHz

## MENU MODE No.083 [TONE FREQ]

**Function:** Setting of the CTCSS Tone Frequency.

**Available Values:** 50 Standard CTCSS tones

**Default:** 88.5 Hz

## MENU MODE No.084 [TOT TIME]

**Function:** Select the Automatic Power Off time.

**Available Values:** OFF/1 ~ 20 (min)

**Default:** OFF

## MENU MODE No.085 [TUNER/ATAS]

**Function:** Selects the device (**FC-30** or **ATAS-100/-120**) to be controlled via the front panel's [A](TUNE) key.

**Available Values:** OFF/ATAS(HF)/ATAS(HF&50)/ATAS(ALL)/TUNER

**Default:** OFF

**OFF:** The [A](TUNE) key is disabled.

**ATAS(HF):** The [A](TUNE) key will activate the optional **ATAS-100/-120** on the HF amateur bands.

**ATAS(HF&50):** The [A](TUNE) key will activate the optional **ATAS-100/-120** on the HF amateur bands and 50 MHz amateur band.

**ATAS(ALL):** The [A](TUNE) key will activate the optional **ATAS-100/-120** on the all amateur bands which enable to the **FT-897D** transceiver.

**TUNER:** The [A](TUNE) key will activate the optional **FC-30**.

## MENU MODE No.086 [TX IF FILTER]

**Function:** Selects the Transmit IF filter.

**Available Values:** CFIL/FIL1/FIL2

**Default:** CFIL

## MENU MODE No.087 [VOX DELAY]

**Function:** Sets the "hang time" for the VOX circuitry.

**Available Values:** 100 ~ 3000 (ms)

**Default:** 500 (ms)

## MENU MODE No.088 [VOX GAIN]

**Function:** Sets the gain of the VOX circuitry's input audio detector.

**Available Values:** 1 ~ 100

**Default:** 50

## MENU MODE No.089 [XVTR A FREQ]

**Function:** Allows an arbitrary frequency to be set on the display, to allow direct frequency readout during transverter operation; can also be used to account for frequency conversion inaccuracies when a known reference frequency is known.

**Available Values:** 00,000,00 ~ 99,999,99 (kHz)

**Default:** Current VFO frequency.

## MENU MODE No.090 [XVTR B FREQ]

**Function:** Allows an arbitrary frequency to be set on the display, to allow direct frequency readout during transverter operation; can also be used to account for frequency conversion inaccuracies when a known reference frequency is known.

**Available Values:** 00,000,00 ~ 99,999,99 (kHz)

**Default:** Current VFO frequency.

## MENU MODE No.091 [XVTR SEL]

**Function:** Enable/disable the Transverter function.

**Available Values:** OFF/XVTR A/XVTR B

**Default:** OFF

**OFF:** Disables the Transverter operation feature.

**X VTR A:** Activates the transverter operation feature.

The display frequency may be set via MENU No.089 [XVTR A FREQ].

**X VTR B:** Activates the second transverter operation display.

The display frequency may be set via MENU No.090 [XVTR B FREQ].

# CAT (COMPUTER AIDED TRANSCEIVER) OPERATION

The FT-897D's CAT System allows the transceiver to be controlled by a personal computer. This allows multiple control operations to be fully automated as a single mouse click, or it allows a third-party software package (such as contest logging software) to communicate with the FT-897D without (redundant) operator intervention.

The Optional CAT Interface Cable CT-62 is a connection cable for the FT-897D and your computer. The CT-62 has a built-in level converter, allowing direct connection from the rear panel CAT/LINEAR jack to the serial port of your computer, without the need for an external RS-232C level converter box.

Vertex Standard does not produce CAT System operating software, due to the wide variety of personal computers, operating systems, and applications in use today.

The information presented in this section will allow the programmer to understand the command structure and opcodes used in the FT-897D's CAT System.

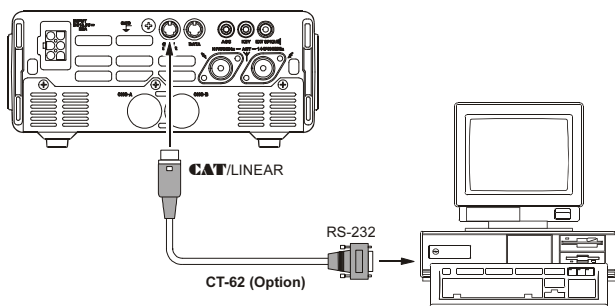

## CAT Data Protocol

All commands sent from the computer to the transceiver consist of five-byte blocks, with up to 200 ms between each byte. The last byte in each block is the instruction opcode, while the first four bytes of each block are arguments (either parameters for that instruction, or dummy values required to pad the block out to five bytes). Each byte consists of 1 start bit, 8 data bits, no parity bit, and two stop bits.

There are 17 instruction opcodes for the FT-897D, listed in the chart on next page. Many of these opcodes are On/Off toggle commands for the same action (e.g. "PTT On" and "PTT Off") Most of these commands require some parameter or parameters to be set. Irrespective of the number of parameters present, every Command Block sent must consist of five bytes.

Accordingly, any CAT control program must construct the five-byte block by selecting the appropriate instruction opcode, organizing the parameters as needed, and providing unused "dummy" argument bytes to pad the block to its required five-byte length (the dummy bytes can contain any value). The resulting five bytes are then sent, opcode last, from the computer to the FT-897D CPU via the computer's serial port and the transceiver's CAT/LINEAR jack.

## All CAT data values are hexadecimal

### Constructing and Sending CAT Commands

*Example #1:* Set the VFO frequency to 439.70 MHz

- Per the CAT command table, the opcode for "Set Frequency" is 01. Placing the opcode into the 5th data bit position, we then enter the frequency into the first four data bit positions:

DATA 1	DATA 2	DATA 3	DATA 4	DATA 5
43	97	00	00	01

←

Parameter Command

Send these five bytes to the transceiver, in the order shown above.

*Example #2:* Turn the Split Mode "On"

- Per the CAT command table, the opcode for "Split On/off" is 02. Placing the opcode into the 5th data bit position, we then enter dummy values into all other parameter locations:

DATA 1	DATA 2	DATA 3	DATA 4	DATA 5
00	00	00	00	02

←

Parameter Command

# CAT (COMPUTER AIDED TRANSCEIVER) OPERATION

## Opcode Command Chart

Command Title	Parameter				Opcode	Notes
LOCK ON/OFF	*	*	*	*	CMD	CMD = 00 : LOCK ON CMD = 80 : LOCK OFF
PTT ON/OFF	*	*	*	*	CMD	CMD = 08 : PTT ON CMD = 88 : PTT OFF
Set Frequency	P1	P2	P3	P4	01	P1 ~ P4 : Frequency Digits 01, 42, 34, 56, [01] = 14.23456 MHz
Operating Mode	P1	*	*	*	07	P1 = 00 : LSB, P1 = 01 : USB, P1 = 02 : CW, P1 = 03 : CWR, P1 = 04 : AM, P1 = 08 : FM, P1 = 0A : DIG, P1 = 0C : PKT P1 = 88 : FMN,
CLAR ON/OFF	*	*	*	*	CMD	CMD = 05 : CLAR ON CMD = 85 : CLAR OFF
CLAR Frequency	P1	*	P3	P4	F5	P1 = 00 : "+" OFFSET P3, P4 : CLAR Frequency P1 = 00 : "-" OFFSET 12, 34 = 12.34 kHz
VFO-A/B	*	*	*	*	81	Toggle
SPLIT ON/OFF	*	*	*	*	CMD	CMD = 02 : SPLIT ON CMD = 82 : SPLIT OFF
Repeater Offset	P1	*	*	*	09	P1 = 09 : "-" SHIFT P1 = 49 : "+" SHIFT P1 = 89 : SIMPLEX
Repeater Offset Frequency	P1	P2	P3	P4	F9	P1 ~ P4 : Frequency Digits 05, 43, 21, 00, [F9] = 5.4321 MHz
CTCSS/DCS Mode	P1	*	*	*	0A	P1 = 0A : DCS ON P1 = 0B : DCS DECODER ON P1 = 0C : DCS ENCODER ON P1 = 2A : CTCSS ON P1 = 3A : CTCSS DECODER ON P1 = 4A : CTCSS ENCODER ON P1 = 8A : OFF
CTCSS Tone	P1	P2	P3	P4	0B	P1 ~ P2 : CTCSS Tone Frequency for TX (Note 1) P3 ~ P4 : CTCSS Tone Frequency for RX (Note 1)
DCS Code	P1	P2	P3	P4	0C	P1 ~ P2 : DCS Code for TX (Note 2) P3 ~ P4 : DCS Code for RX (Note 2)
Read RX Status	*	*	*	*	E7	(Note 3)
Read TX Status	*	*	*	*	F7	(Note 4)
Read RX Status	*	*	*	*	03	(Note 5)

### Note 1: CTCSS Tone

**Example:** Set the CTCSS Tone Frequency to 88.5 Hz (TX) and 100.0 Hz (RX)

P1	P2	P1	P2	
↓	↓	↓	↓	
08	85	10	00	= 88.5 Hz (TX), 100.0 Hz (RX)

### Note 2: DCS Code

**Example:** Set the DCS Code to 023 (TX) and 371 (RX)

P1	P2	P1	P2	
↓	↓	↓	↓	
00	23	03	71	= 023 (TX), 371 (RX)

### Note 3: Read RX Status

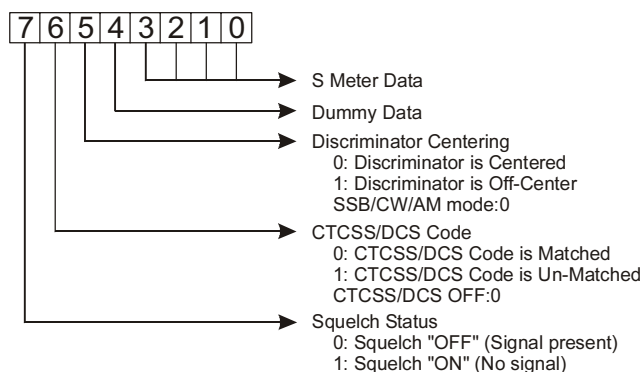

### Note 4: Read TX Status

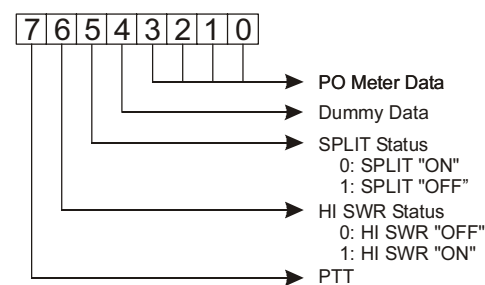

### Note 5: Read Frequency & Mode Status

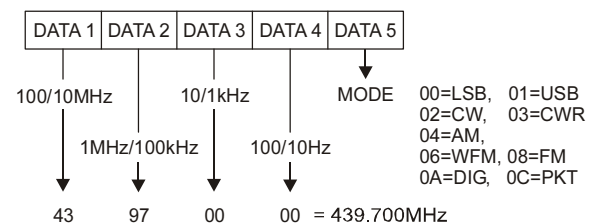

# POWER-ON MICROPROCESSOR RESET PROCEDURES / CLONING

## POWER-ON MICROPROCESSOR RESET PROCEDURES

Some or all transceiver settings can be reset to their factory-default states using one of the following power-on routines:



- [V/M] + POWER** on: Resets all memories and following menu settings to their factory-default values:  
Menu #06 (AM STEP), 33 (DCS CODE), 52 (FM STEP), 56 (MEM TAG), 76 (RPT SHIFT), 82 (SSB STEP), and 83 (TONE FREQ).
- [F] + POWER** on: Resets all menu settings (except the following menu items) to their factory-default values.  
Menu #06 (AM STEP), 33 (DCS CODE), 52 (FM STEP), 56 (MEM TAG), 76 (RPT SHIFT), 82 (SSB STEP), and 83 (TONE FREQ).
- [HOME] + POWER** on: CPU master reset for all memories and menu settings.

## CLONING

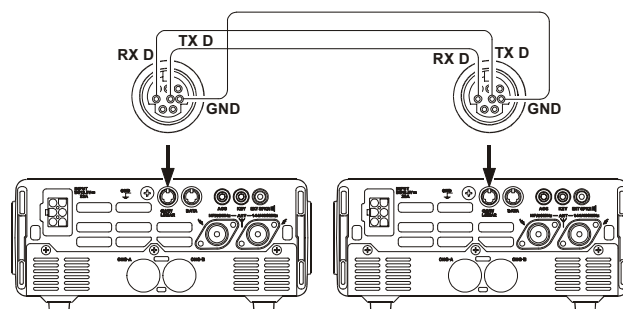
You can transfer all data stored in one transceiver to another set by utilizing the handy “Cloning” feature. This requires a user-constructed cloning cable which connects the **CAT/LINEAR** jacks on the two transceivers, as shown below.

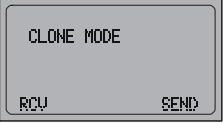
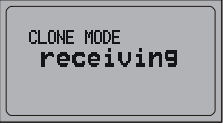

To clone from one transceiver to another, use the following procedure:

1. Insert the Clone Cable into the **CAT/LINEAR** jack of each transceiver.
2. Turn both transceivers off, then press and hold in the **MODE(◀)** and **MODE(▶)** buttons on each radio while turning the power on again. The “CLONE MODE” notation will appear on the display.  

3. On the “destination” radio, press the **[A]** key.  

4. Now, on the “source” radio, press the **[C]** key. Data will now be transferred to the “Destination” radio from the “Source” radio.  

5. If there is a problem during the cloning process, “Error” will be displayed.  
Check your cable connections and try again.  

6. If cloning is successful, turn the “destination” radio off. Now turn the “source” radio off.
7. Remove the clone cable. Channel and operating data for both radios are now identical. They both may be turned on now for normal operation.

# INSTALLATION OF OPTIONAL ACCESSORIES

## OPTIONAL FILTERS: YF-122S, YF-122C, AND YF-122CN

1. Turn the transceiver's power off by pressing and holding in the **PWR** switch for one second, then disconnect the DC cable from the **INPUT** jack on the rear panel of the transceiver, when operating the **FT-897D** with a DC power supply or optional **FP-30** AC power supply.
2. Referring to Figure 1, remove the eight screws affixing the top cover of the transceiver then disconnect the speaker's connector from the MAIN Unit.
3. Fold the top cover centering around the carrying hand side from the main chassis.
4. Refer to Figure 2 for the mounting locations for the optional filters. Position the filter so that its connectors are aligned with the mounting pins on the board, and push it into place (these slots does not distinction for the installed filter).
5. Replace the top cover and its eight screws (remember to replace the internal speaker's plug), then connect the DC cable to the INPUT jack when operating the **FT-897D** with a DC power supply or optional **FP-30** AC power supply.
8. Filter installation is now complete.

To use the optional filter, press the [**B**](2.3, 500, or 300) key (in Multi Function Row "n") to activate the optional filter which is installed in the "**FIL-1**" slot. Press the [**C**](2.3, 500, or 300) key (in Multi Function Row "n") to activate the optional filter which is installed in the "**FIL-2**" slot.

Note: If you wish to use the optional filter for the TX IF filter while operating in the SSB mode, change the setting of Menu Mode No-086 [TX IF FILTER] to "FIL1" or "FIL2" (the slot into which you installed the optional **YF-122S** filter).

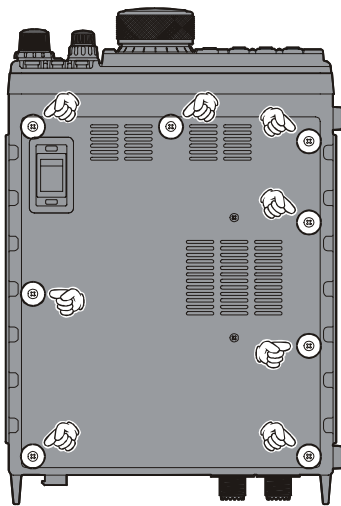

Figure 1

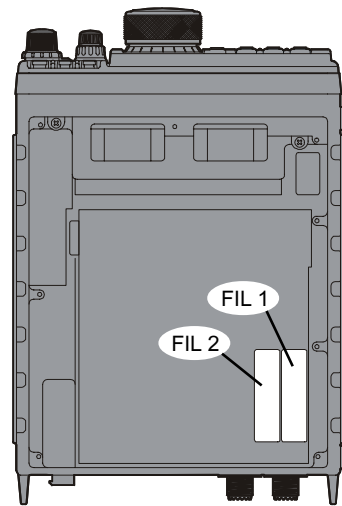
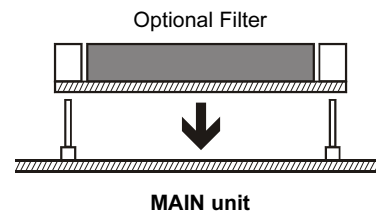



Figure 2



# INSTALLATION OF OPTIONAL ACCESSORIES

## EXTERNAL AUTOMATIC ANTENNA TUNER "FC-30"

### Parts List

Screws (M3 x 6B) 	2
Screws (M3 x 6B) 	6
Mounting Plate A	1
Mounting Plate B	1
Mounting Plate C	1

### Installation

1. Turn the transceiver's power off, and disconnect all cables from the transceiver.
2. Screw the mounting plate "A" to the FC-30 using the supplied screws (**Figure 1**).
3. Remove the four rubber lugs and their four screws (**Figure 2**), then position mounting plates "B" and "C" so that their holes align with those on the FT-897D, and secure using the supplied screws (**Figure 3**).
4. To install the FC-30, position the FC-30 so that the mounting plate "A" on the side fits into the mounting plate "B" on the FT-897D (**Figure 3**), then screw the mounting plate "C" (on the FT-897D) to the FC-30 using the supplied screws (**Figure 1**).

See page 41 for connection of the FC-30/FT-897D and operating procedure.

 **Do not install the supplied FC-30 Mounting Screws if you are not installing the FC-30! Also, do not use an improper screw for mounting the FC-30! An improper screw may cause a "short circuit" to the internal circuitry, causing serious damage!**

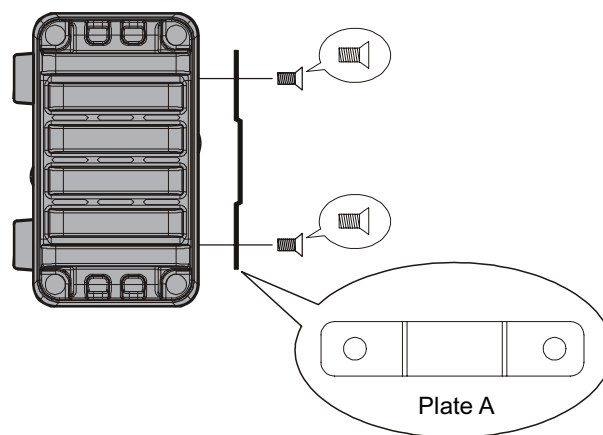
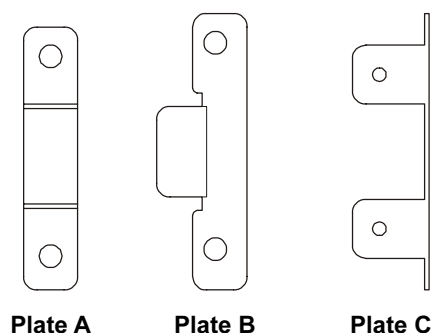

Figure 1

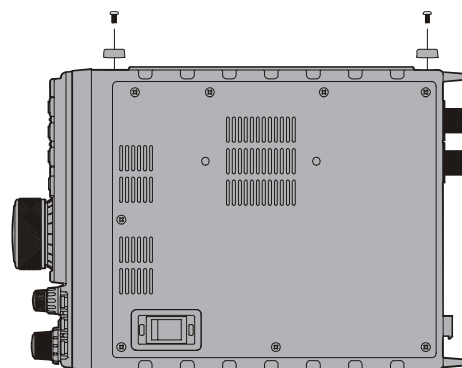

Figure 2

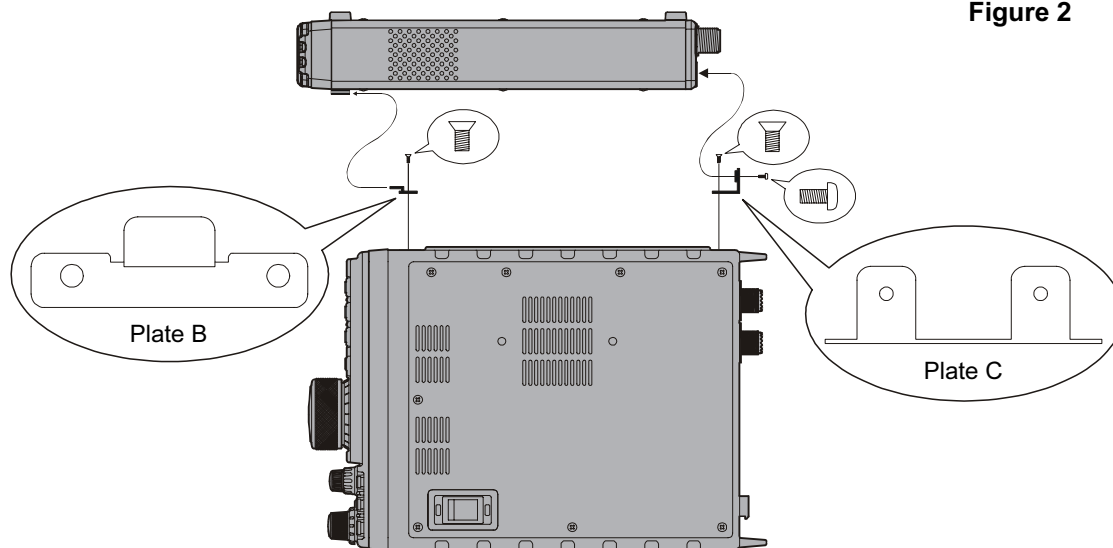

Figure 3



## SETUP OF MEMORIES FOR LOW EARTH ORBIT (LEO) FM SATELLITE OPERATION

Although the **FT-897D** is not capable of “full duplex” operation (simultaneous transmission and reception), its flexible memory system is ideal for configuring a set of memories for LEO satellite work.

The example below is designed around the popular satellite **UO-14**, but the same principles apply to operation using **AO-27**, **SO-35**, and other such satellites.

First, set up a table of the required operating frequencies. For **UO-14**, a typical setup table is shown below:

Channel #	Rx Freq.	Tx Freq.	Notes
1	435.080	145.970.0	AOS
2	435.075	145.972.5	
3	435.070	145.975.0	Mid Pass
4	435.065	145.977.5	
5	435.060	145.980.0	LOS

AOS = Acquisition of Signal (Beginning of Pass)

LOS = Loss of Signal (End of Pass)

The above frequencies are nominal, and the changing frequencies reflects the Doppler Shift which occurs on such satellites, which display rapid apparent motion relative to an earth-based observer. But if we can accommodate a set of several frequency pairs in our memory system, frequencies that reflect the frequency relationships encountered during a typical pass, we will have a good chance of having our frequencies properly aligned when it is time for making a QSO.

So we need to store the above frequency matrix into memories. Note that the receiving frequency and transmitting frequency are on different bands. Therefore, we will use the “Split Frequency Memory” storage technique described on page 42.

First, press the **[F]** key momentarily, then rotate the **MEM/VFO CH** knob to select Multi Function Row “a” [A/B, A=B, SPL]. Press the **[A]**(A/B) key, if necessary, to select VFOa.

Now press the **BAND(DWN)** or **BAND(UP)** key to select the 70 cm band. Check the setting of Menu Mode No-004 [AM&FM DIAL], and set this to “ENABLE” to allow smaller frequency increments to be accommodated.

Set the VFOa operating frequency to 435.0800.00 MHz. Now press the **[A]**(A/B) key in Multi Function Row “a” to select VFOb, and set VFOb to 145.970.00 MHz. Again press the **[A]**(A/B) key to return to VFOa. Be sure that both VFOs are set to the FM mode, as well.

Press the **[F]** key momentarily, and rotate the **MEM/VFO CH** knob one click clockwise to select Multi Function Row “b” [MW, SKIP, TAG].

Press the **[A]**(MW) key momentarily, then rotate the **MEM/VFO CH** knob while the memory channel number is blinking; select memory channel M-001, then press and hold in the **[A]**(MW) key until you hear the double beep. We have just stored the first downlink (earth station receiving) frequency into memory.

Press the **[F]** key momentarily, then rotate the **MEM/VFO CH** knob one click counter-clockwise to re-select Multi Function Row “a” [A/B, A=B, SPL]. Press the **[A]**(A/B) key to select VFOb (145.970 MHz).

Again press the **[F]** key momentarily, and rotate the **MEM/VFO CH** knob one click clockwise to re-select Multi Function Row “b” [MW, SKIP, TAG]. Press the **[A]**(MW) key momentarily; the “M-001” indicator will flash; press and hold in the microphone’s **PTT** key, and while holding it in press the **[A]**(MW) key until you hear the double beep. You have now stored the uplink (earth station transmitting) frequency into the same memory register as we did previously for the downlink frequency.

It’s now time to store the other frequencies in the matrix. Return to Multi Function Row “a” [A/B, A=B, SPL], and press the **[A]**(A/B) key to return to VFOa on 435.080.00 MHz. Now rotate the **DIAL** knob to set the frequency to 435.075.00 MHz. Press the **[A]**(A/B) key again to select VFOb (145.970 MHz), and rotate the **DIAL** knob to set the frequency to 145.972.50 MHz. Press the **[A]**(A/B) key to return to VFOa on 435.075.00 MHz.

Return to Multi Function “b” [MW, SKIP, TAG], and repeat the Split Memory storage process, selecting memory channel M-002 this time when initially storing the 435.075 MHz receiving frequency.

Now repeat this entire process three more times, filling memory channels M-003, M-004, and M-005 with the frequencies shown in the chart above.

When it’s time to operate, press the **[V/M]** key, if necessary, to recall the Memory mode, and rotate the **MEM/VFO CH** knob to select channel M-001. This will be the first frequency pair to be utilized during the UO-14 window of workability when it rises above your local horizon. The Doppler effect will cause the nominal 435.070 MHz downlink frequency to appear higher to you, so utilize memory channel M-001 when the satellite first rises. A few minutes later, switch to M-002, and at mid-pass switch to M-003. As the satellite recedes, switch to M-004 and then M-005 toward the end of the pass.

The **MEM/VFO CH** knob recall of these five channels makes Doppler tracking simple; just choose the memory channel producing the best signal! You have already programmed an uplink frequency corresponding to the optimum downlink frequency, so you will not need to try to make difficult VFO adjustments during the brief satellite passes.

The FM passbands used on LEO satellites are sufficiently broad that more precise frequency adjustment is not needed.

To aid in channel identification, remember that you can use Menu Mode No-056 [MEM TAG] to label each satellite memory (for example, “UO-14a” ~ “UO-14e” for the above five channels).

A complete set of frequencies may be stored for each LEO satellite you wish to utilize, and once configured, the **FT-897D** provides a flexible and easy-to-use earth station capability for these popular satellites.

## MH-59A8J REMOTE MICROPHONE

The optional **MH-59A8J** Remote Microphone provides control of the major functions of the **FT-897D** from the microphone's keypad. The **MH-59A8J** includes a rotary control knob for adjust the operating frequency and receiver audio volume level.

Before connecting the **MH-59A8J**, you must instruct the **FT-897D**'s microprocessor that the **MH-59A8J** is being used, using the Menu Mode:

1. Press and hold in the **[F]** key for one second to activate the Menu Mode.
2. Rotate the **MEM/VFO CH** knob to recall Menu Mode No-001 [EXT MENU], then rotate the **DIAL** to change the setting to "ON" to enable the extended Menu Mode.
3. Rotate the **MEM/VFO CH** knob to recall Menu Mode No-059 [MIC SEL]. The default setting for this Menu is "NOR." Rotate the **DIAL** to change the setting to "RMT."
4. Press and hold in the **[F]** key for one second to save the new setting and exit to normal operation.

### MH-59A8J Switches and Control

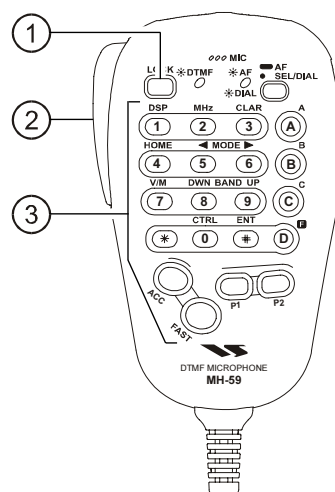

#### ① LOCK Switch

Pressing this key locks the **FT-897D**'s front panel keys so as to prevent accidental frequency change.

#### ② PTT Switch

Press this switch to transmit, and release it to receive.

#### ③ Keypad

##### [1(DSP)] key

Pressing this key provides instant access to Multi Function Row "p" (MFp), which contains the command keys for the receiver's Digital Signal Processing System.

This key generates the DTMF "1" tone during transmission, and frequency entry digit "1" during Direct Keypad Frequency Entry.

##### [2(MHz)] key

Pressing this key allows tuning in 1-MHz steps of the VFO frequency.

This key generates the DTMF "2" tone during transmission, and frequency entry digit "2" during Direct Keypad Frequency Entry.

##### [3(CLAR)] key

Pressing this key momentarily activates the Receiver Clarifier ("R.I.T.") feature.

Press and hold in this key for one second to activate the IF Shift feature.

This key generates the DTMF "3" tone during transmission, and frequency entry digit "3" during Direct Keypad Frequency Entry.

##### [4(HOME)] key

Pressing this key recalls a favorite "Home" frequency memory.

This key generates the DTMF "4" tone during transmission, and frequency entry digit "4" during Direct Keypad Frequency Entry.

## MH-59A8J REMOTE MICROPHONE

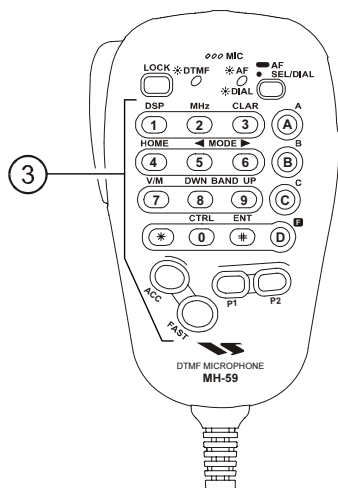

### [5(◀MODE)] key

Pressing this key changes the operating mode:

**USB** ⇨ **LSB** ⇨ **PKT** ⇨ **DIG** ⇨ **FM** ⇨  
**AM** ⇨ **CWR** ⇨ **CW** ⇨ **USB** .....

This key generates the DTMF “5” tone during transmission, and frequency entry digit “5” during Direct Keypad Frequency Entry.

### [6(MODE▶)] key

Pressing this key changes the operating mode:

**USB** ⇨ **CW** ⇨ **CWR** ⇨ **AM** ⇨ **FM** ⇨  
**DIG** ⇨ **PKT** ⇨ **LSB** ⇨ **USB** .....

This key generates the DTMF “6” tone during transmission, and frequency entry digit “6” during Direct Keypad Frequency Entry.

### [7(V/M)] key

Pressing this key switches frequency control between the VFO and Memory Systems.

This key generates the DTMF “7” tone during transmission, and frequency entry digit “7” during Direct Keypad Frequency Entry.

### [8(DWN BAND)] key

Pressing this key causes the frequency to be moved down by one frequency band:

**1.8 MHz** ⇨ **430 MHz** ⇨ **144 MHz** ⇨ **108 MHz** ⇨  
**88 MHz** ⇨ **50 MHz** ⇨ **28 MHz** ⇨ **24 MHz** ⇨  
**21 MHz** ⇨ **18 MHz** ⇨ **15 MHz** ⇨ **14 MHz** ⇨  
**10 MHz** ⇨ **7 MHz** ⇨ **5 MHz** ⇨ **3.5 MHz** ⇨  
**1.8 MHz** .....

This key generates the DTMF “8” tone during transmission, and frequency entry digit “8” during Direct Keypad Frequency Entry.

### [9(BAND UP)] key

Pressing this key causes the frequency to be moved up by one frequency band:

**1.8 MHz** ⇨ **3.5 MHz** ⇨ **5 MHz** ⇨ **7 MHz** ⇨  
**10 MHz** ⇨ **14 MHz** ⇨ **15 MHz** ⇨ **18 MHz** ⇨  
**21 MHz** ⇨ **24 MHz** ⇨ **28 MHz** ⇨ **50 MHz** ⇨  
**88 MHz** ⇨ **108 MHz** ⇨ **144 MHz** ⇨ **430 MHz** ⇨  
**1.8 MHz** .....

This key generates the DTMF “9” tone during transmission, and frequency entry digit “9” during Direct Keypad Frequency Entry.

### [\*] key

This key generates the DTMF “F (\*)” tone during transmission.

### [0(CTRL)] key

This key generates the DTMF “0” tone during transmission, and frequency entry digit “0” during Direct Keypad Frequency Entry.

### [ENT(#)] key

Press this key to enter the Direct Keypad Frequency Entry mode.

Example:

To enter 14.25000 MHz, press

[ENT] → [1] → [4] → [D(point)] → [2] → [5] → [ENT]

To enter 0.95000 MHz, press

[ENT] → [D(point)] → [9] → [5] → [ENT]

You may recall a memory channel, as well;

To recall memory channel 001, press

[ENT] → [1] → [\*]

To recall memory channel 125, press

[ENT] → [1] → [2] → [5] → [\*]

This key generates the DTMF “E (#)” tone during transmission.

### [A] key

This key emulates the function of the **FT-897D**’s front panel [A] key.

This key generates the DTMF “A” tone during transmission.

### [B] key

This key emulates the function of the **FT-897D**’s front panel [B] key.

This key generates the DTMF “B” tone during transmission.

### [C] key

This key emulates the function of the **FT-897D**’s front panel [C] key.

This key generates the DTMF “C” tone during transmission.

## MH-59A8J REMOTE MICROPHONE

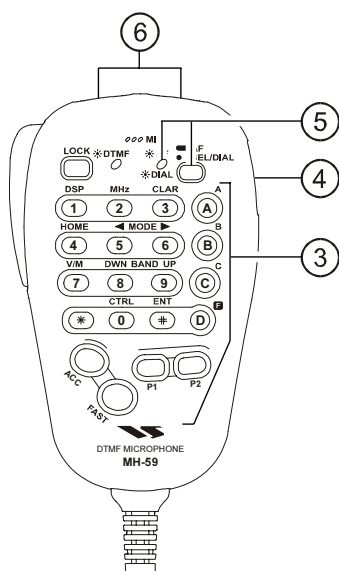

### [F(D)] key

Press this key momentarily to enable the changing of the function of the Multi Function keys ([A], [B], and [C]) by the **MEM/VFO CH** knob.

Press and hold in this key for one second to activate the “Menu” mode.

This key generates the DTMF “D” tone during transmission, and frequency entry digit “point” during Direct Keypad Frequency Entry.

### [ACC] key

Press this key to disable the Noise Squelch.

You may program the configuration of this key, to enable use of a different function, via Menu Mode No-068 [PG ACC].

### [PWR(FAST)] key

Press and hold in this key for one second to turn the transceiver on or off.

While the transceiver is turned on, pressing this key momentarily will engage the “Fast Tuning” mode, to allow more rapid frequency navigation (a small “running man” icon will be observed in the bottom right-hand corner of the LCD).

### [P1] key (Quick Split)

Press this key to change the Sub VFO frequency (Main VFO frequency + 5 kHz) and automatically engage the “Split” feature.

You may program the configuration of this key, to enable use of a different function, via Menu Mode No-069 [PG P1].

### [P2] key

Press this key to engage the 1750-Hz burst tone for access of a repeater requiring tone burst (typically in Europe).

You may program the configuration of this key, to enable use of a different function, via Menu Mode No-070 [PG P2].

### ④ SEL Knob

This rotary switch is used for VFO frequency tuning, memory channel selection, and receiver audio volume level adjustment.

### ⑤ SEL/DIAL Key and Indicator

The **SEL** key switches the synthesizer steps of the **SEL** knob between the fine tuning (same as **DIAL** knob step) and coarse tuning (same as **SEL** knob step) modes.

When the “fine tuning” mode is selected, the **SEL LED** glows orange.

Press and hold in this key for one second to enable the “VOL” feature, which allows adjustment of the receiver audio volume level (by adjusting the **SEL** knob). When the “VOL” feature is engaged, the **SEL LED** glows green.

To return to the synthesizer step-selection mode, just press the **SEL** key.

### ⑥ [UP]/[DWN] Keys

Press (or hold in) either of these keys to tune (or scan up or down) the operating frequency or through the memory channels. In many ways, these keys emulate the function of the **FT-897D**’s **DIAL** knob.

# ***NOTE***

---

1. Changes or modifications to this device not expressly approved by VERTEX STANDARD could void the user's authorization to operate this device.
2. This device complies with part 15 of the FCC Rules. Operation is subject to the following two conditions; (1) this device may not cause harmful interference, and (2) this device must accept any interference including interference that may cause undesired operation.
3. The scanning receiver in this equipment is incapable of tuning, or readily being altered, by the User to operate within the frequency bands allocated to the Domestic public Cellular Telecommunications Service in Part 22.

This device complies with RSS-210 of Industry Canada. Operation is subject to the following two conditions; (1) this device may not cause interference, and (2) this device must accept any interference, including interference that may cause undesirable operation of the device.

**WARNING: MODIFICATION OF THIS DEVICE TO RECEIVE CELLULAR RADIOTELEPHONE SERVICE SIGNALS IS PROHIBITED UNDER FCC RULES AND FEDERAL LAW.**





Copyright 2004  
VERTEX STANDARD CO., LTD.  
All rights reserved

No portion of this manual  
may be reproduced without  
the permission of  
VERTEX STANDARD CO., LTD.

Printed in Japan.

0405z-ME

