

# CQ REVIEWS:

## The Yaesu FT-980 CAT

BY JOHN J. SCHULTZ\*, W4FA

The FT-980 is a very heavy-duty, full-featured base-station transceiver. It has about every operating feature one could imagine in an h.f. transceiver with general-coverage receive. However, it is a lot more than a transceiver with various "bells and whistles." It is one of the "new generation" of transceivers slowly emerging on the market which have all of their major functions controlled by an internal microcomputer. Therefore, one can use the transceiver in a conventional sense by turning knobs and pushing buttons, or one can control it from a personal computer. In the latter case, one can control the transceiver by keyboard commands or develop a program which will command the transceiver to do certain operations in certain sequences, at certain times, or in response to certain received signals. Does one need all of these capabilities in a transceiver? Well, one has to decide that for one's self. I would suggest, however, that an operator who even only enjoys rag-chewing on 75 meters not say no too quickly. Convenience features in a transceiver, once they are understood, really do make amateur radio operating more interesting.

This review will give a general description of the FT-980 and its overall circuitry and construction; highlight interesting circuit features; provide test-bench results; and convey operating impressions and results using the transceiver in the usual "turning the knobs and pushing the buttons" fashion. In a subsequent article we will provide a more technical overview of how the FT-980 can be interfaced with a personal computer.

### Specifications

Table I lists the specifications for the FT-980 as supplied by the manufacturer. They deserve a bit of time for study. One might note, first of all, that the FT-980 is not a paper-weight unit. It weighs some 37 pounds and measures overall some 15 inches wide by 6½ inches high by 18 inches deep, including its internal power supply. It is a very impressive unit as seen in an operating position. The styling is a combination of off-gray colors with the push-buttons and knob caps being aluminum colored. The frequency display is a soft green fluorescent type and the backup lighting for the two panel meters is soft green. Yellow-bar-type LED's are used above or in association with various push-buttons to indicate an "on" status. Besides the main digital frequency display, there is also a unique digital/analog "scroll" type frequency display directly above the main tuning knob which indicates from 000

\*c/o CQ magazine



The FT-980 almost appears small here as it has stacked upon it the SP-980 optional speaker and a Yaesu FTV-707 transverter which can be used with the FT-980 for 2 meter coverage.

to 950 in steps of 50. At first I thought it to be a bit of "decoration." But after many hours of using the transceiver, I completely changed my mind. Also, after many hours of using the transceiver, I must say that I found the subdued color styling extremely easy on the eyes.

Going back to Table I, and if one wishes to study the "numbers," it can be seen that the FT-980 has completely state-of-the-art specifications with regard to spurious responses, sensitivity, selectivity, IMD, dynamic range, image rejection, etc. However, the specifications themselves do not highlight a number of interesting features of the FT-980. Among the more interesting features are:

1. An 8-bit microprocessor control system which includes 12 memory channels which store frequency and mode.
2. Two independent v.f.o.'s, one for amateur band coverage and one for general-coverage receive.
3. Tuning of the v.f.o.'s and the memory channels by use of the main tuning dial, up/down scanning (dual speed) buttons, or keypad frequency entry.
4. Split-frequency operation between the v.f.o.'s and a memory channel (the memory channel being used for receive or transmit, depending on whether the amateur band or general-coverage v.f.o. is used, since the general-coverage v.f.o. cannot be used for transmit). Full transceive operation is possible on any

memory channel that stores a frequency within an amateur band.

5. Full QSK within any band and crossband/crossmode operation.

6. TX and RX tunable frequency offset up to  $\pm 10$  kHz. The main frequency display follows the offset tuning to indicate true operating frequency.

7. Internal reference oscillator stability of  $\pm 3$  Ppm from 0 to 40 degrees C.

8. Digital frequency display has selectable resolution of 100 or 10 Hz and a dimmer control.

9. Independent receiver "front-ends" for amateur band or general-coverage receive.

10. IF Shift and IF Width adjustments on receive along with separate a.f. notching and peaking filters.

11. R.f. speech processing on transmit with microphone audio squelch and i.f. monitor circuit to adjust processing.

12. Complete metering to include s.w.r., power output, a.i.c. (normal or peak hold), compression, etc.

13. All modes standard with a nominal 100 watts output on s.s.b. and c.w., 25 watts on a.m., and 50 watts on f.m. and FSK.

14. Up to 75% of full power output at a load s.w.r. of 1:3 (depending on the reactive components present in the load).

15. Some options are available, but the FT-980 is basically a complete station. Only an



<b>TRANSMITTER</b>	<b>AFSK shift frequencies:</b> 170, 425, 850 Hz	<b>IF rejection:</b> better than 70 dB for all frequencies
<b>Frequency range:</b>	<b>Output impedance:</b> 50 ohms(nominal), unbalanced	<b>Selectivity (adjusted for maximum IF width):</b>
160 m band 1.5 to 1.99999 MHz	<b>Microphone impedance:</b> Low (500 to 600 ohms)	-6 dB -60 dB
80 m band 3.5 to 3.99999 MHz	<b>RECEIVER</b>	SSB, CW (W/N), FSK 2.5 kHz 4.2 kHz
40 m band 7.0 to 7.49999 MHz	<b>Frequency range:</b> 150 kHz to 29.9999 MHz (continuous)	CW(N)* 300 Hz 600 Hz
30 m band 10.0 to 10.49999 MHz	<b>Circuit type:</b> Triple conversion superheterodyne	CW(W)* 600 Hz 1.2 kHz
20 m band 14.0 to 14.49999 MHz	<b>Clarifier range:</b> ±10 kHz	AM(W) 6 kHz 17 kHz
17 m band 18.0 to 18.49999 MHz	<b>Sensitivity:</b>	AM(W)* 5 kHz 12 kHz
15 m band 21.0 to 21.49999 MHz	(CW, SSB, and AM figures measured for 10 dB S+N/N)	AM(N) 3 kHz 9 kHz
12 m band 24.5 to 24.99999 MHz	* 2 to 30 MHz ** 150 kHz to 2 MHz	FM* 12 kHz 24 kHz
10 m band 28.0 to 29.99999 MHz	SSB/FSK/CW(W; w/out options)	* with optional filter installed
<b>Tuning steps:</b> 10 Hz, 5 kHz and 500 kHz (band step)	* better than 0.25 µV, ** better than 4.0 µV	<b>NOTE:</b> These figures apply as maximum bandwidths with Width control set to maximum.
<b>Emission types:</b> LSB, USB (A3J/J3E*), CW (A1/A1A*), AM (A3/A3E*), AFSK (F1/J1B*), FM (F3/F3E*) * New emission designation per WARC '79	CW(N)	<b>Dynamic range:</b> (at maximum sensitivity) better than 95 dB with optional 300 Hz CW(N) filter
<b>Power output:</b>	(with optional XF-455.8MCN 300 Hz filter installed)	<b>Audio peak filter range:</b> 350-1400 Hz
(all bands)	* better than 0.1 µV, ** better than 1.6 µV	<b>IF notch filter range (demodulated):</b> 500-2700 Hz
SSB, CW 100 W (PEP)	CW(W)	<b>Audio output power:</b> 3-watts minimum (into 4 ohms, with less than 10% THD)
AM 25 W	(with optional XF-8.9HC filter installed)	<b>Audio output impedance:</b> 4 to 16 ohms
FM, FSK 50 W	* better than 0.16 µV, ** better than 2.6 µV	<b>POWER REQUIREMENTS</b>
<b>Carrier suppression:</b> better than 40 dB below peak output	AM(W)	<b>Voltage:</b>
<b>Unwanted side band suppression:</b> better than 50 dB below peak output (1 kHz tone)	* better than 1.4 µV, ** better than 22 µV	AC: 100 to 120 V, or 200 to 234 V; 50 to 60 Hz
<b>Spurious radiation:</b> better than 50 dB below peak output	AM(W)	<b>Power consumption:</b>
<b>Audio response:</b> better than -6 dB from 250 Hz to 2750 Hz	(with optional XF-8.9GA filter installed)	Receiver 72 VA
<b>3rd order intermodulation distortion:</b> better than -40 dB below peak output (14 MHz, 100 W)	* better than 1.25 µV, ** better than 20 µV	Transmit (100 W output) 530 VA
<b>Frequency accuracy:</b> better than ±3 ppm from 0-40°C	AM(N)	<b>Dimensions (WHD):</b>
<b>Modulation type:</b>	* better than 1.0 µV, ** better than 16 µV	approximately 370 mm x 157 mm x 350 mm; 380 mm x 165 mm x 465 mm with all feet, knobs and heatsink
A3J, AFSK: Balanced Modulator	FM	<b>Weight:</b> approximately 17 kg.
A3: Low Level Modulation	better than 0.6 µV for 12 dB SINAD	
F3: Variable Reactance	<b>Intermediate frequencies:</b>	
<b>Maximum FM deviation:</b> ±5 kHz	1st IF: 47.055 MHz	
	2nd IF: 8.9875 MHz	
	3rd IF: 455 kHz	
	FM IF: 455 kHz	
	<b>Image rejection:</b> better than 70 dB	

Table 1- Technical specifications for the FT-980 as supplied by Yaesu.

a.c. connection, antenna connection, and microphone and/or keyer are needed to operate.

## Circuitry

The FT-980 incorporates a complex mix of digital and analog circuit techniques. It would be fun to describe and analyze all of them, but it would take a small book to do so. I think, however, that a basic circuit overview and the highlighting of a few circuit details would be interesting.

Fig. 1 is a block diagram of the FT-980. Such diagrams do, I agree, seem to be overwhelming with all their blocks, but they can provide some interesting insights into the circuitry concepts used in different transceivers. The "front-end" of the FT-980 (upper right of fig. 1) shows, for instance, how the incoming signal on receive goes through a fixed low-pass filter assembly, but then splits, depending upon whether the transceiver is being used in the

amateur band or general-coverage mode. In the general-coverage mode the signal goes on to a bandpass filter block (one of six diode-switched filters) and then on to a dual FET r.f. amplifier stage (Q1005,6). In the amateur band mode the signal is routed through a fixed highpass filter, on through one of twelve (!) diode-switched bandpass filters, and then to r.f. amplifier stage Q1007,8, which is also of the dual FET variety. Fig. 2 shows a bit of the elaborate "front-end" circuitry in the FT-980. In either case, the now amplified receive signal goes on to the first mixer stage Q1009. The signal then goes on to a number of frequency translations which involve 47.055 MHz, 8.9875 MHz, and 455 kHz i.f.'s. One can follow this from right to left across the top of fig. 1. The demodulated signal then goes through an elaborate series of filtering and amplifier stages. It's interesting to note that the a.p.f. (audio peaking filter) operates, just as its name

states, at audio frequencies (stage Q3026½). However, the notch filter (stage Q2006,07 labeled Q MULT) operates at the 455 kHz i.f. frequency and is a modern-day version of the 20-year-old "Q Multiplier" which, of course, originally used vacuum tubes. The detailed circuitry is shown in fig. 3.

In the transmit mode the s.s.b. signal is generated at the 8.9875 MHz i.f. frequency. The signal chain can be fairly well followed from the microphone amplifier stage (Q3001) to a balanced mixer stage (Q3009) and then via the dashed signal-flow lines in and out of the 8.9875 MHz filter block. Perhaps the most interesting thing about the transmit signal chain flow is to observe how it is routed in and out of various i.f. filter blocks common to the receive signal chain, but completely separate mixer stages are used for the transmit signal until it gets to its final output frequency. The circuitry necessary to do this makes things a bit more



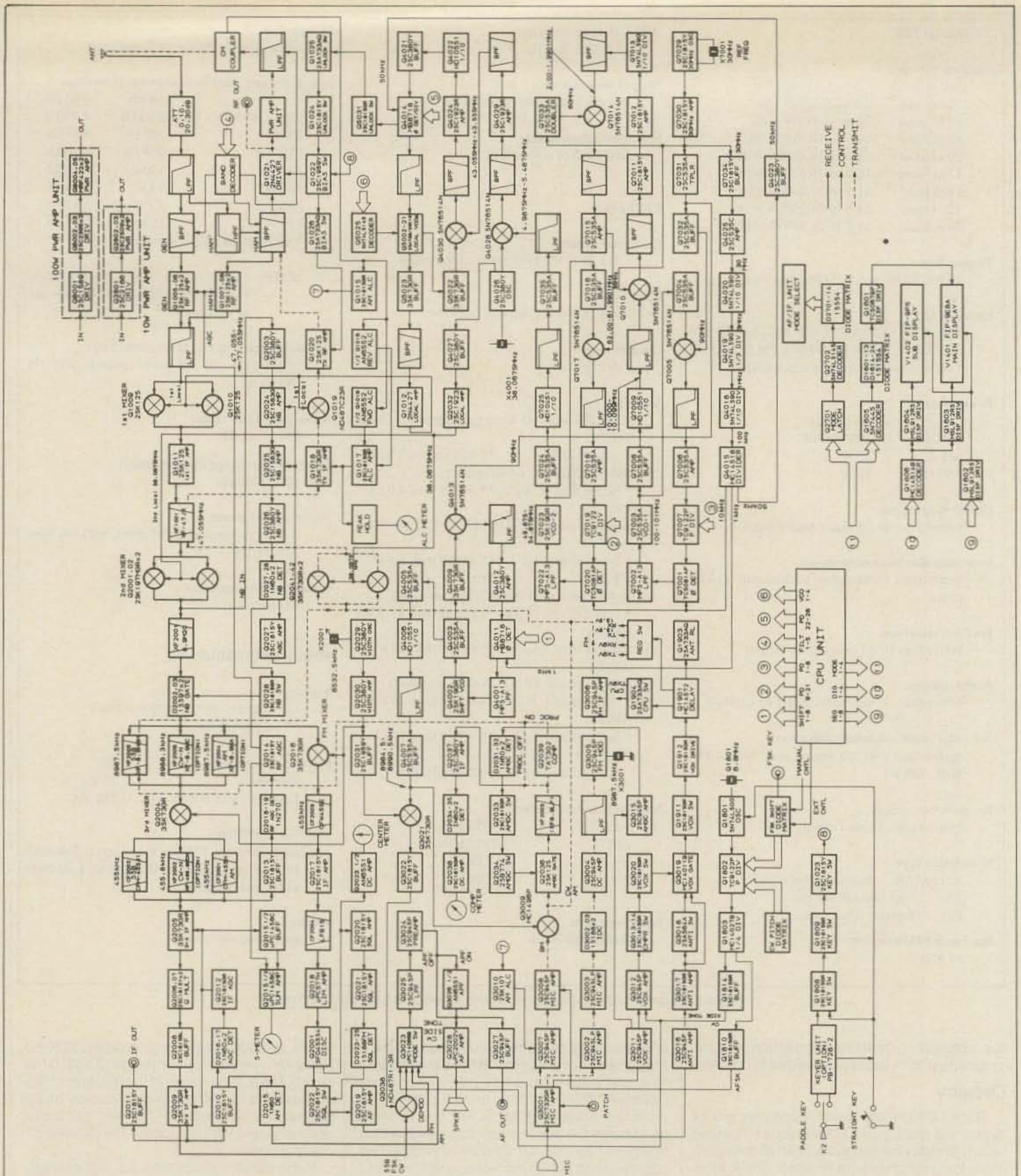

Fig. 1- Complete block diagram of the FT-980.

elaborate, but some of the compromises involved in using common mixer stages for the transmit and receive signal flows are avoided. The transmit signal, at the final output frequency, goes through one of the twelve band-pass filters associated with the receive chain and then on to a power amplifier unit. The latter operates with a supply voltage of 24 volts and utilizes two MRF 422 power transistors.

Finally, the 100 watt output level signal is routed through one out of seven relay-switched low-pass filters. Transmit/receive antenna switching is done by a relay in the low-pass filter section, and there are provisions for the use of separate transmit/receive antennas as well as an external receiver.

The rest of the blocks in fig. 1 are concerned with a variety of oscillator signal gen-

eration and control functions. Fig. 4 gives one some idea of the frequency relationships in the FT-980. In this diagram the r.f. signal chain for the receive and transmit modes is shown in abbreviated form in the upper part of the diagram. Most of the diagram shows how various voltage-controlled oscillators are used to supply the injection frequencies for all of the mixers in the r.f. chain (down to the product detec-



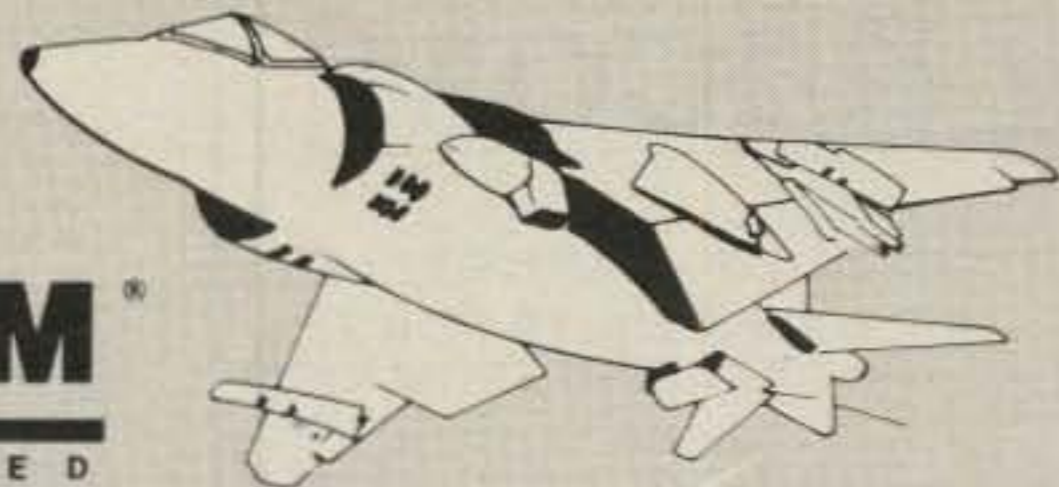
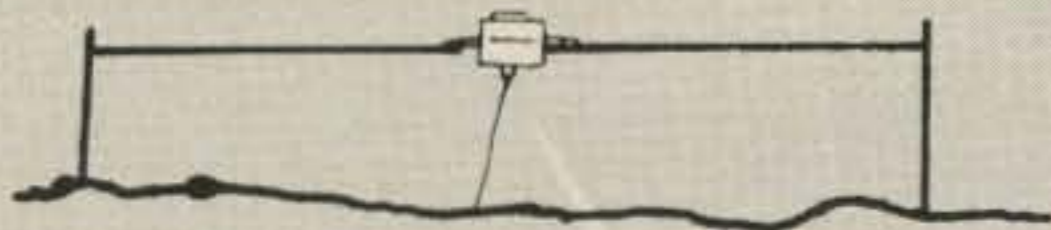

**MAXCOM**<sup>®</sup>  
INCORPORATED  
AUTOMATIC  
ANTENNA MATCHER

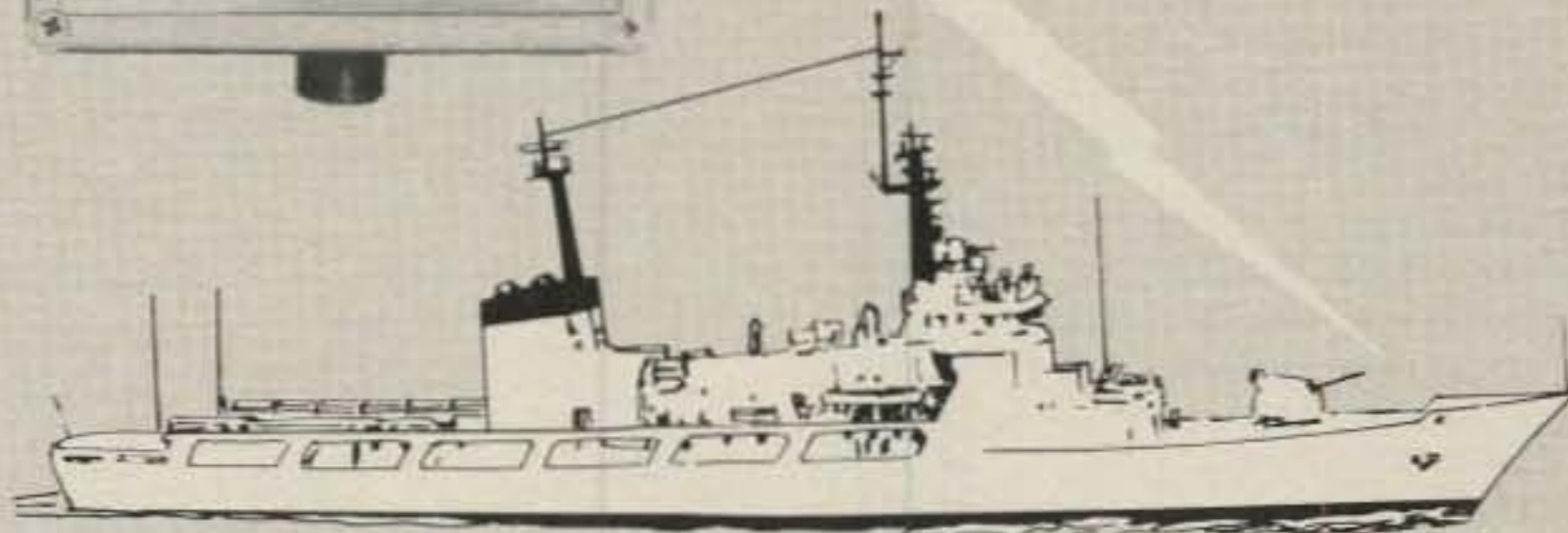
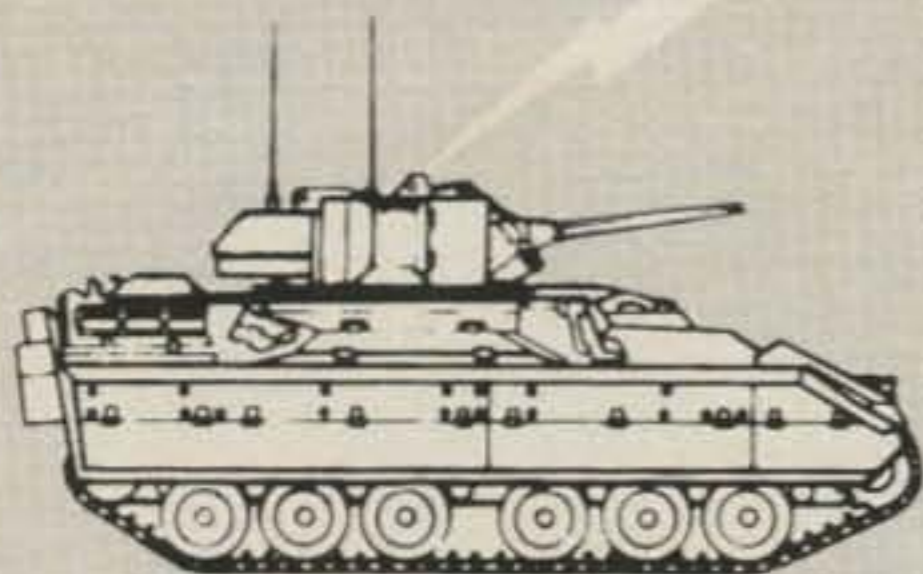

**ONE ANTENNA .3 TO 70 MHZ.  
VSWR 1.5:1 OR LESS**

UNEXCELLED FOR "FREQUENCY HOPPING"

- \* NO MOVING PARTS !
- \* 5 YEAR WARRANTY !
- \* INSTANT MATCHING !
- \* 50 OHM INPUT !
- \* LOW NOISE !
- \* DIPOLE !
- \* MARINE !
- \* AMATEUR !

- \* 100% SOLID STATE !
- \* NO CONTROL LEADS !
- \* LIGHT WEIGHT !
- \* HIGH EFFICIENCY !
- \* 200 TO 2KW. P.E.P. !
- \* LONG WIRE !
- \* MILITARY !
- \* AVIONICS !

**"NEW R.F. GROUNDLESS LONGWIRE MODELS  
NOW AVAILABLE"**

CONTACT

**MAGNUM DISTRIBUTORS INC.**

1831 South Dixie Highway, Pompano Beach, Florida 33060  
305-785-2002 • Telex 514365 (English FTL)





FACTORY AUTHORIZED DEALER  
PLEASE CALL OR WRITE FOR THE  
LATEST AND GREATEST FROM ICOM

**ICOM**

IC-745 HF Xcvr./Gen. Cov. Rcvr.	\$779.00
IC-R70 HF Gen. Cov. Rcvr.	599.00
IC-R71A HF Gen. Cov. Rcvr.	669.00
IC-PS15 12 VDC, 15 Amp. Power Supply	131.12
IC-PS30 12 VDC, 30 Amp. Sys. Pwr. Supply	228.76
IC-SP2 External Speaker	52.50
IC-SP3 External Speaker	49.50
IC-271H 2-Mtr., FM/SSB/CW, 100 W., Xcvr.	789.00
IC-SM5 Desk Microphone	39.00
IC-SM6 Desk Microphone	39.00
IC-SM8 Desk Microphone, Dual Cables	69.95
IC-27A 2-Meter, FM, 25 Watt Xcvr.	319.00
IC-27H 2-Meter, FM, 45 Watt Xcvr.	359.00
IC-37A 220-MHz., FM, 25 Watt Xcvr.	389.00
IC-2AT 2-Mtr., FM, Handheld W/Touch-Tone	214.50
IC-3AT 220-MHz., FM, Handheld With T-T	234.50
IC-02AT 2-Mtr., FM, Handheld With T-T	309.50
IC-BP2 7.2 VDC, 425 mah., Ni-Cad Batt. Pack.	39.50
IC-BP3 8.4 VDC, 250 mah., Ni-Cad Batt. Pack.	29.50
IC-BP4 Battery Case	12.50
IC-BP5 10.8 VDC, 425 mah., Ni-Cad Batt. Pack.	49.50
IC-BP7 13.2 VDC, 425 mah., Ni-Cad Batt. Pack.	67.50
IC-BP8 8.4 VDC, 800 mah., Ni-Cad Batt. Pack.	62.50
BC-35 Drop-In Rapid Charger; IC-BP2, 5, 7, 8	69.00
IC-CP1 Mobile Charging Cord	9.50
IC-DC1 DC Converter	17.50
IC-HM9 Speaker/Microphone	34.50
IC-2AT-LC Leather Case; IC-2AT, 3AT, 4AT	34.95
LC-14 Leatherette Case For IC-02AT	17.95
HS-10 Headset For Handhelds	19.50
HS-10SA VOX Unit For HS-10	19.50
HS-10SB PTT Unit For HS-10	19.50
IC-EX310 Voice Synthesizer Unit	39.95
RC-10 Frequency Controller For IC-751	35.00
RC-11 Infrared Remote Controller For IC-R71A	59.95

**TOKYO HY-POWER LABS**

HC-200 200 Watt PEP Antenna Coupler	\$86.14
HC-400L 200 Watt PEP Antenna Coupler	134.40
HC-2000 2-KW PEP Antenna Coupler	285.60
HL-30V 2-Meter FM Amplifier	59.78
HL-110V 2-Meter Multi-Mode Amplifier	201.60
HL-160V 2-Meter Multi-Mode Amplifier	287.84
HL-90U 430-MHz. Multi-Mode Amplifier	318.00
HRA-2 144-MHz. Mast-Mounted Pre-Amp.	132.00

**WELZ**

CT-15A Dummy Load, 50W Peak, 15W Avg.	\$12.95
CT-150 Dummy Load, 400W Peak, 150W Avg.	49.95
CT-300 Dummy Load, 1-KW Peak, 300W Avg.	69.95

**BELDEN**

New 9913 Low Loss VHF/UHF Coax Cable, RG-8/U Type. Accepts Standard Amphenol PL-259 And Type N Conn. 9½-AWG. Solid, Bare Copper, Center Conductor. 84% Velocity Factor. 100% Shield Coverage. 50 Ohm. Semi-Solid, Polyethylene, Center Insulation. \$44/Ft.

**ASTRON**

RS-7A 13.8 VDC, 7 Amp Int., 5 Amp Cont.	\$46.30
RS-12A 13.8 VDC, 12 Amp Int., 9 Amp Cont.	64.60
RS-20A 13.8 VDC, 20 Amp Int., 16 Amp Cont.	82.90
RS-35A 13.8 VDC, 35 Amp Int., 25 Amp Cont.	125.60
RS-12M Same As RS-12A, With Meter	80.46
RS-20M Same As RS-20A, With Meter	98.76
RS-35M Same As RS-35A, With Meter	141.46
VS-20M Same As RS-20M, Adj. Volt./Curr.	117.06
VS-35M Same As RS-35M, Adj. Volt./Curr.	159.76
VS-50M 13.8 VDC, 50A Int., 37A Cont., Adj.	226.86

*LaRue Electronics*

1112 GRANDVIEW STREET  
SCRANTON, PENNSYLVANIA 18509  
PHONE (717)343-2124

CIRCLE 6 ON READER SERVICE CARD

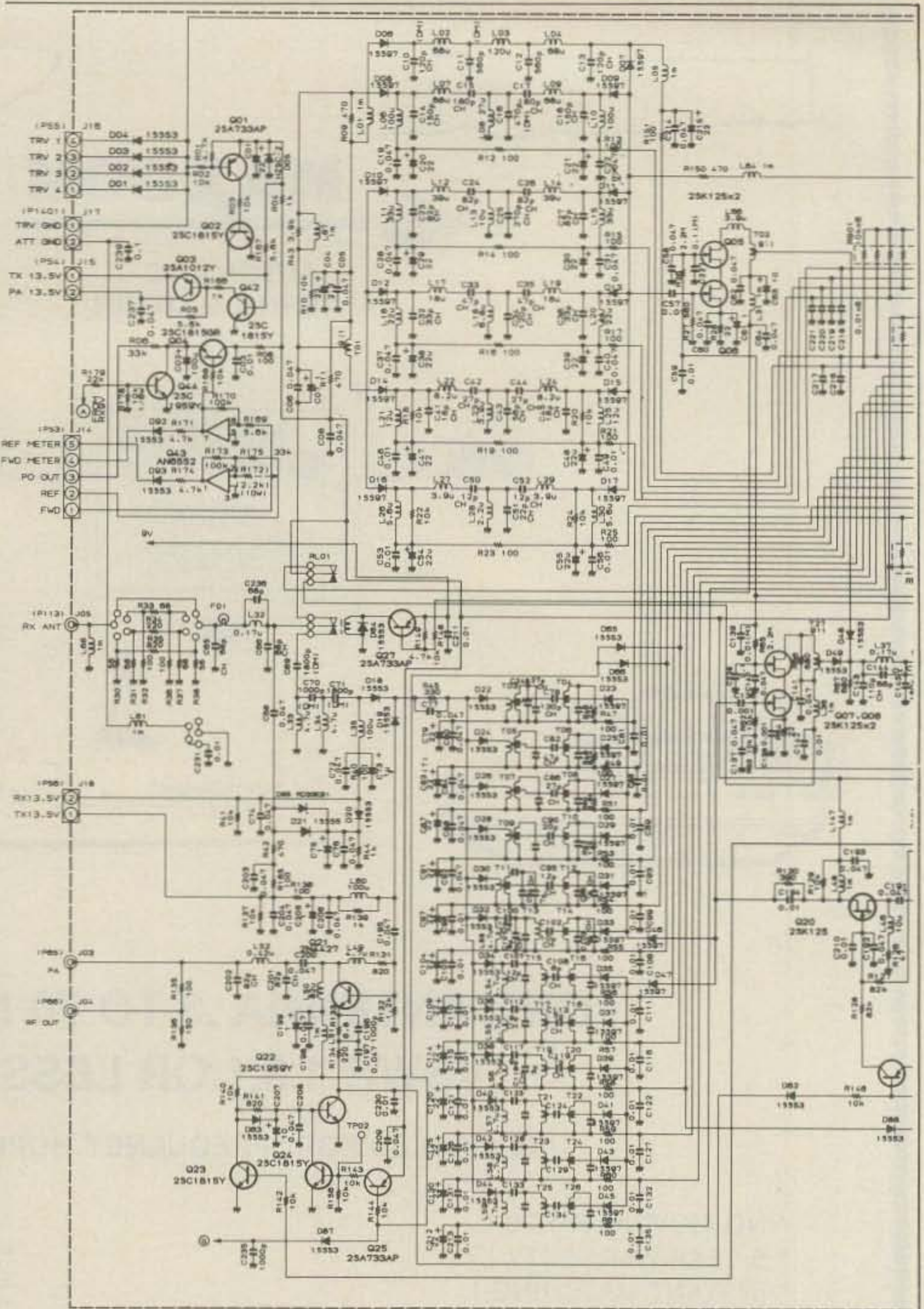

Fig. 2- Part of the "front end" in the FT-980 showing the separate input filter and r.f. amplifier stages used for the general-coverage and amateur band modes. Q05 and Q06 with their associated input filters are for general coverage, while Q07 and Q08 with their associated 12 input filters are for amateur band coverage.

tor stage). The VCO's are stabilized in PLL circuitry, and the PLL circuitry is all locked back to a 30 MHz master oscillator by means of various frequency divider and multiplier circuits coupled to that oscillator. The complexity of the real circuitry is only hinted at by the blocks shown in fig. 4. Some of the blocks labeled "VCO" contain, in fact, up to ten separate VCO's to cover different frequency ranges. The 30 MHz master oscillator is contained in a thermally controlled enclosure that only a few years ago would only have been found in laboratory-grade test equipment. There is an elaborate use of LC filters to prevent spurious signals from causing oscillator noise and interaction problems.

**Construction**

As was mentioned, the FT-980 is not a light-

weight unit, but the weight is all due to its very solid construction. The photograph showing the FT-980 with its top cover removed only hints at some of the elaborate shielding used inside the unit. Separate shielding and heavy heatsinks are used for the PA and power-supply sections. All of the PC boards have connectors, and although they are not of the plug-in type, they all can be accessed and relatively easily removed should servicing ever be required. The construction can only be described as extremely heavy-duty, neat, and orderly.

The back panel of the FT-980 contains enough auxiliary connectors for about every conceivable interconnection-linear amplifier, transverter, phone-patch, computer control, external receiver, i.f. output, etc. There are also slide switches to change the FSK shift (170, 425, or 850 Hz) and the c.w. monitoring



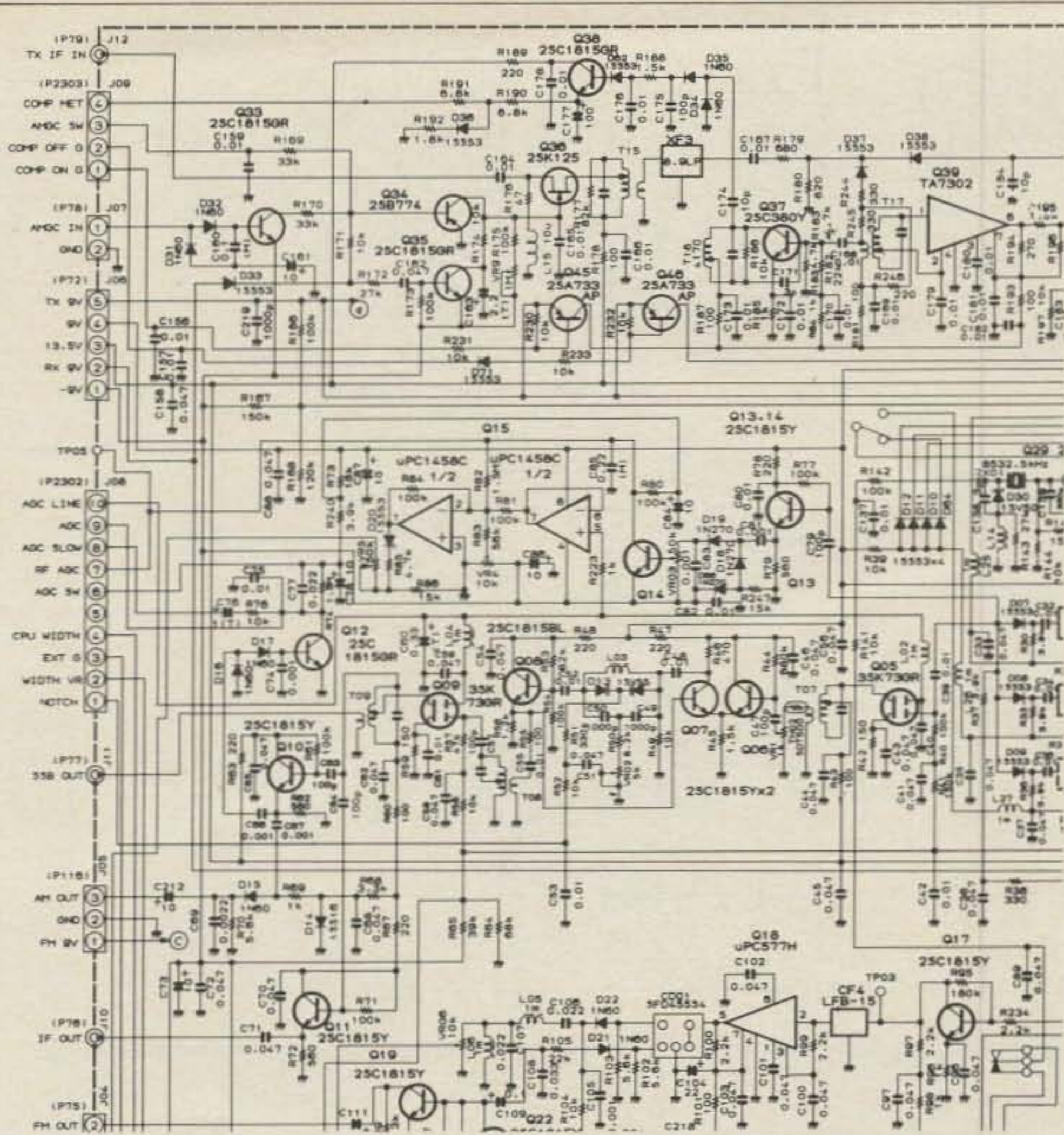

Fig. 3—The interesting 455 kHz i.f. Q Multiplier circuitry (Q 06–09 in the middle of the diagram). A modern-day version of a circuitry idea developed well over 20 years ago.

sidetone pitch (500, 600, or 700 Hz). All of the connectors are well spaced, and there is no difficulty in having a multitude of accessory connections. The only slightly awkward feature is that the access panel for the memory backup battery compartment (holding two AA-size batteries) is on the bottom cover.

### Test Results

The FT-980 is a "quiet" transceiver. In spite of its elaborate digital frequency generation circuits, it is as electrically quiet as any transceiver using analog circuitry. Therefore, signals appear to rise out of a quiet background, and it's not unusual to have a weak, but well-modulated s.s.b. signal sound "loud" while the S meter does not even move, even under QRM conditions. Phase noise is at least 90–100 dB down. The only "noise" the FT-980 does produce is a slight "pop" as one goes between exact 1 MHz points in the general-receiver mode (e.g., 9.999.99 MHz to 10.000.00 MHz). It doesn't amount to much and may even be useful as a reminder that one has tuned across a full MHz point. The transient "pop" will not mask a signal that one might want to receive (e.g., on 9.999.99 MHz or 10.000.00 MHz).

The sensitivity is generally excellent and never checked out less than that shown in Table I. There is, however, a significant difference in sensitivity on 160 meters when receiving in the general-coverage or amateur

band modes. Sensitivity on that band is in the order of 30 dB better in the amateur band mode. On the amateur bands the dynamic range was an excellent 90–95 dB using s.s.b. bandwidth and, of course, even better using c.w. bandwidths (measurements taken with the r.f. attenuator set at zero).

It's interesting to note that Yaesu has moved away from the push-pull type of r.f. amplifier stage as found in the FT-One. As one can see from fig. 2, both of the r.f. amplifier stages (Q05, Q06 for general coverage and Q07, Q08 for the amateur bands) are of the dual FET type, but only one FET is used as an amplifier; the other FET is used for a.g.c.

The s.s.b. selectivity varied from 2.4 kHz at –6 dB to 4.0 kHz at –60 dB and could be reduced to about 400 Hz using the variable bandwidth feature. The standard a.m. normal and wide filters are excellent for general-purpose SW broadcast monitoring. However, c.w. buffs will want to install at least one of the optional c.w. filters. Both were tried and checked exactly as specified. It's difficult to choose between them, but I would opt for the 600 Hz filter, since the main tuning rate is fixed at 10 kHz per knob resolution. The 600 Hz filter is easier to use with that tuning rate, and there are enough other QRM fighting controls built into the FT-980 to handle any situation. I.f. and image rejection were exceptional, measuring out at –80 dB. No significant spurious signals could be found as the FT-980 was set up to scan through its entire receive frequency range. The fast scan rate covers about 1 MHz in 35 seconds, and in the slow scan mode about 10 kHz is covered in 40 seconds. To demonstrate the follies one can get involved in when testing equipment, I thought at first there was some funny low-frequency oscillation in the FT-980 in the 2–6 MHz range. The S meter would jump up a few S units anywhere in that frequency range about once a second. After some confusion, it turned out that I had the VOX control advanced too far, while not having the anti-VOX control adjusted properly, such that an external very low frequency audio feedback loop had been established between the station loudspeaker and microphone. Apparently the gain variations in the transceiver, although minute, were just enough to cause the effect to appear over a certain frequency range. Although one cannot transmit in the general-coverage mode, the VOX circuitry in the FT-980 remains active.

On the transmit side all the usual measurements for carrier suppression, sideband suppression, spurious radiation, etc., showed the FT-980 to be well within its specifications. The power output, into a matched load, was never less than 100 watts over any amateur band, in-

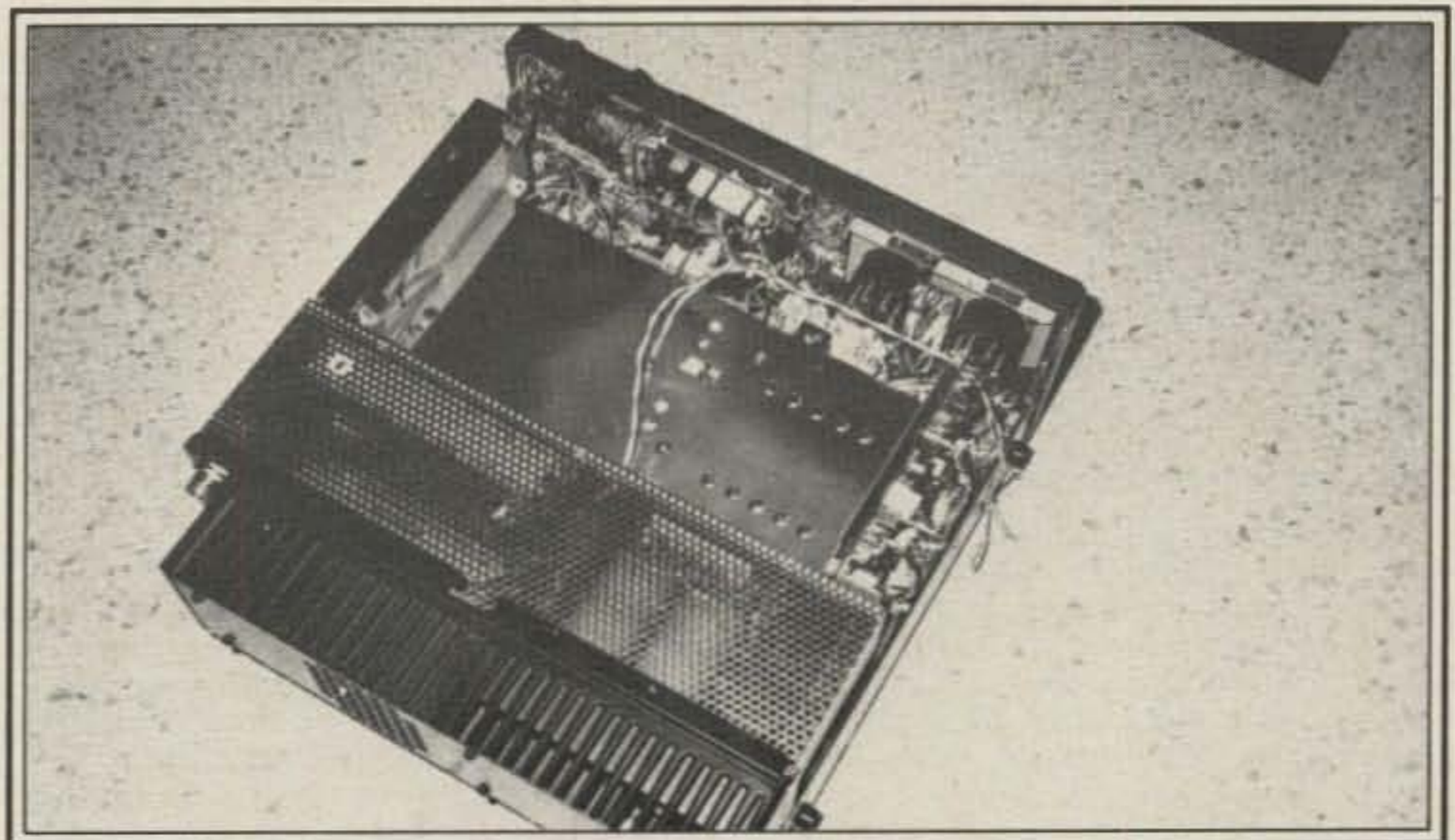

An inside view of the FT-980 with the top cover removed. There is extensive shielding used throughout.



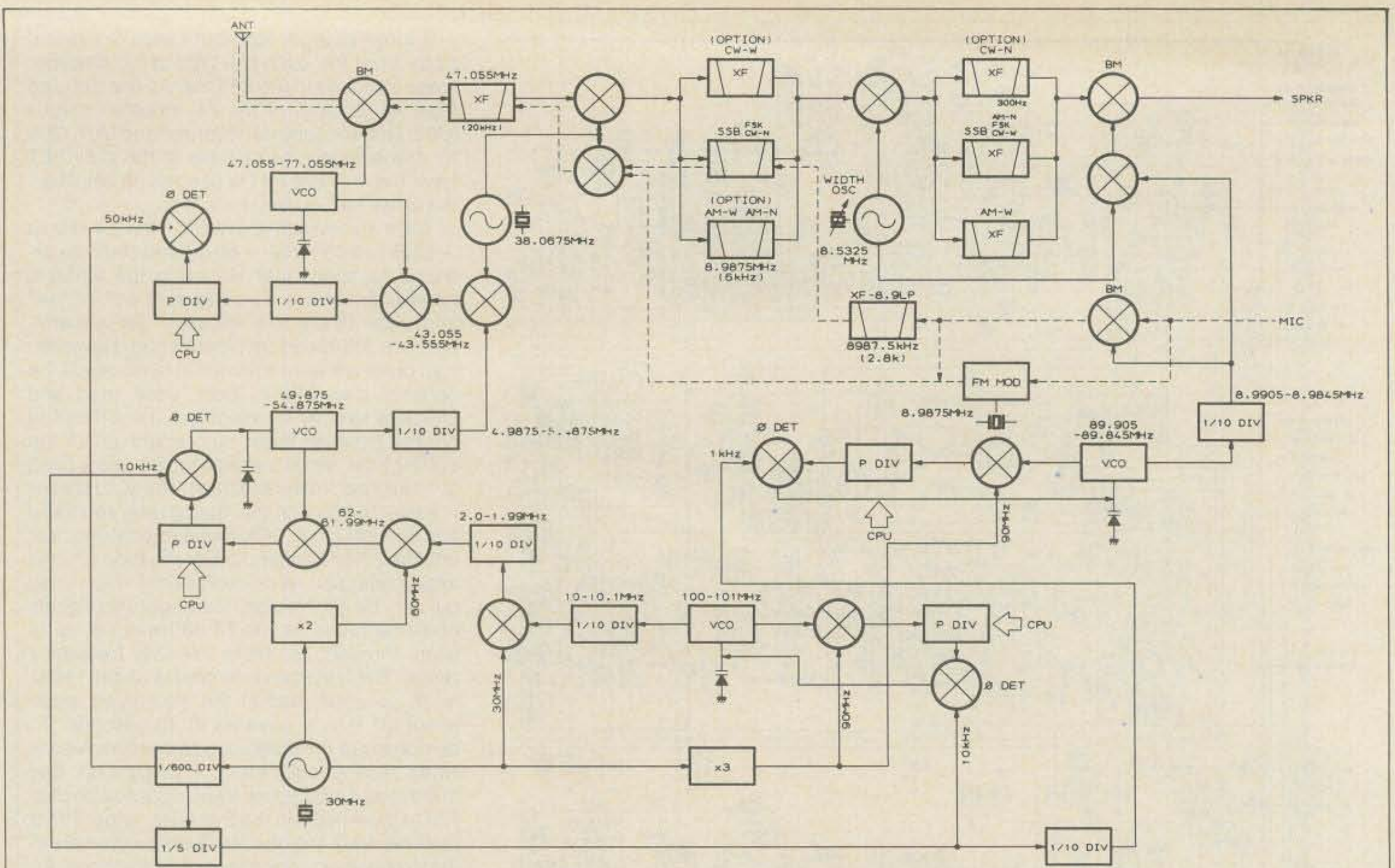

Fig. 4- Frequency relationships within the FT-980. Basic stability all relates back to the 30 MHz crystal oscillator shown in the lower left-hand corner.

cluding 10 meters. Although all of the "specs" have to be considered excellent, there are two that deserve that rare rating of outstanding. Those concern frequency stability overall and IMD products for the power amplifier. I don't have the laboratory equipment to make extremely sophisticated frequency stability measurements, so I went back to empirical methods. The FT-980 is one of the few transceivers I have encountered which could be turned on, tuned to a time standard station, left in a non-temperature-controlled environment, and found days later (not hours) to remain exactly on the tuned frequency. With regard to the power amplifier, I thought at first it was the same as in the FT-One. But although it is similar, it is not exactly the same. Twenty-four v.d.c. is used for the collector voltage on the final transistors, and those transistors have been changed to type MRF 422's rated at 280 watts dissipation each! Fig. 5 shows a diagram of the power amplifier. Measurements showed that it does indeed exhibit third-order IMD products of -40 dB, or slightly better, at 100 watts output on 14 MHz for a truly "clean" signal.

### Operating Impressions and Results

As I have found with most new transceivers which have a variety of sophisticated features, the best way to approach the use of such a transceiver is to learn how the essential controls which allow one to basically communicate work and then slowly dig into the "bells and whistles" features. In this regard the FT-980 is very easy to operate. Press the VFO button (an LED lights), press the HAM button (another LED lights), and then tune through the band for which the transceiver is

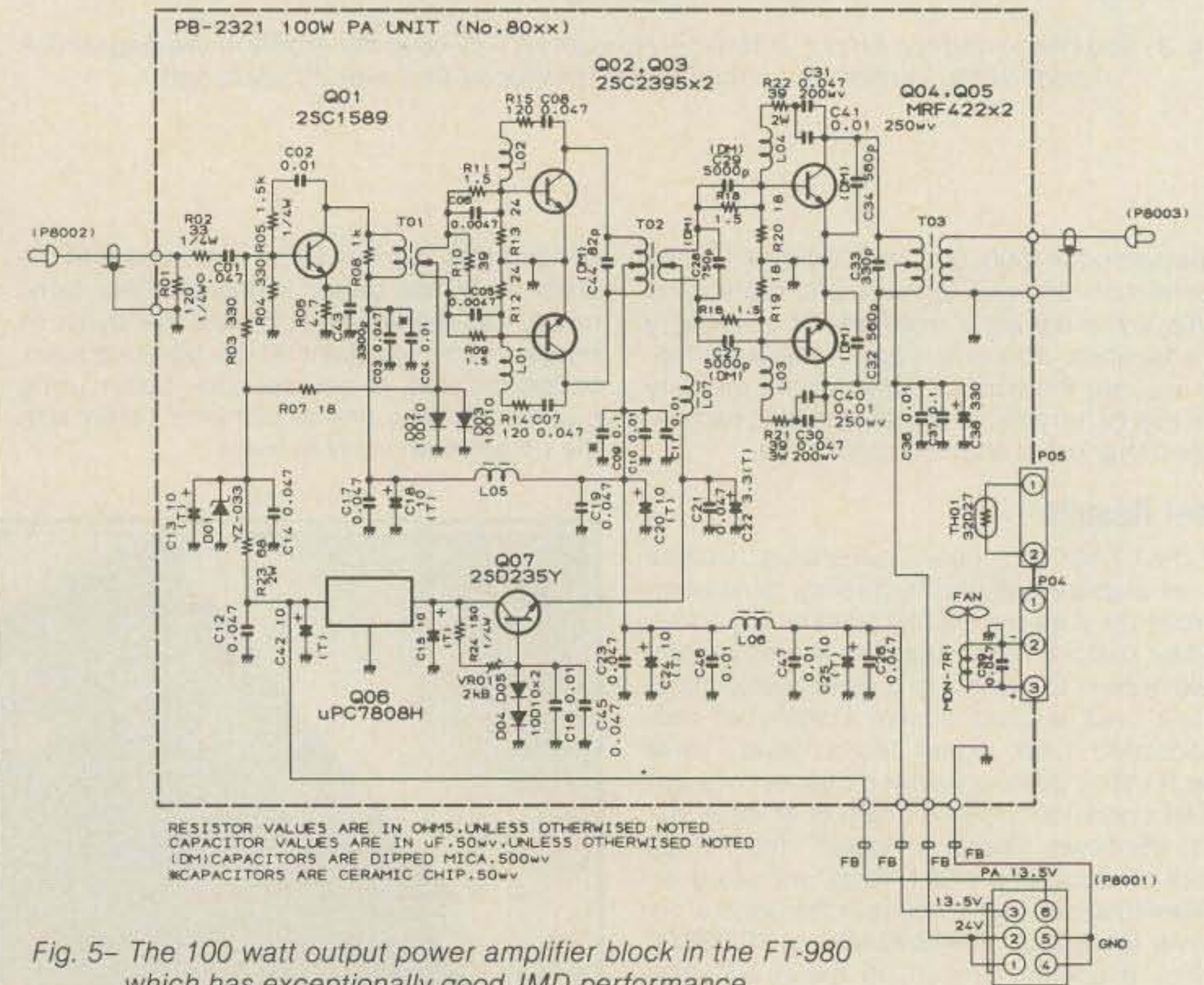
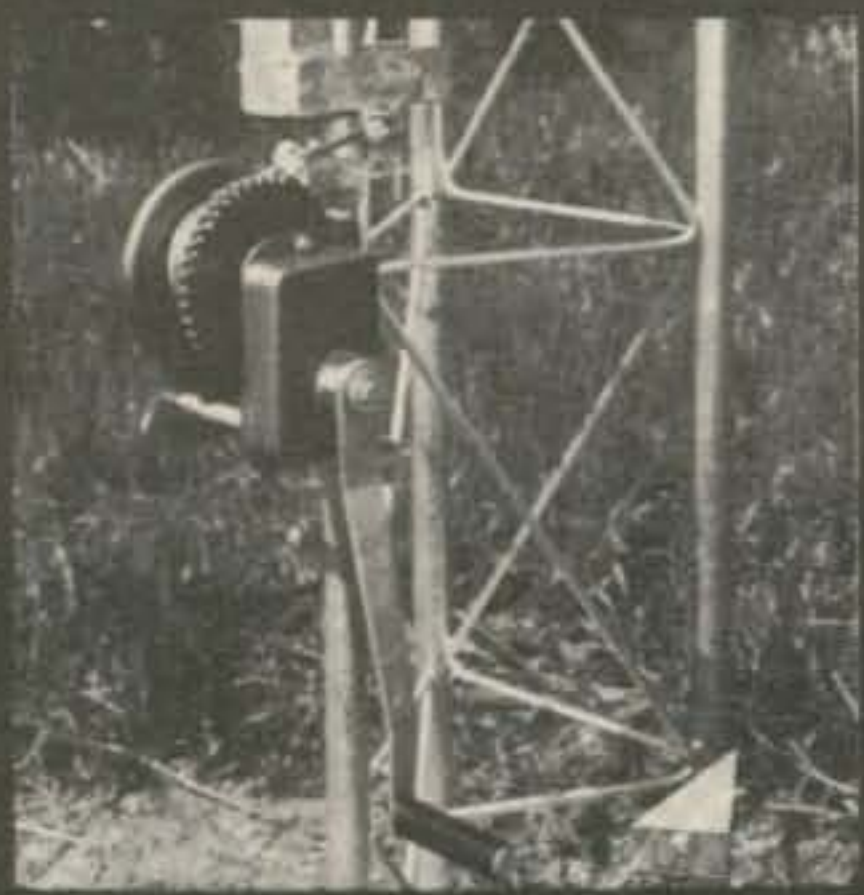

Fig. 5- The 100 watt output power amplifier block in the FT-980 which has exceptionally good IMD performance.

set. All of the rest of the controls that one immediately needs (AF gain, mode switch, microphone gain, etc.) are obvious and clearly marked. To change bands, the UP or DOWN pushbuttons are used. Of course, one should study the instruction manual for the FT-980 to learn the meter readings for which controls

should be set. However, basic operation of the FT-980 is very simple and completely "no tune" except for the main frequency setting. The main tuning knob has one of the smoothest actions I have encountered in years. The finger insert swivels independently to further enhance rapid rotation of the knob. One of the





## ROHN<sup>®</sup> "FOLD-OVER" TOWERS

■ **EASE OF INSTALLATION**  
ROHN "Fold-Over" Towers are quickly and easily installed. The "Fold-Over" is safe and easy to service.

■ **ADAPTABILITY**  
ROHN has several sizes to fit your applications or you can purchase the "Fold-Over" components to convert your ROHN tower into a "Fold-Over".

■ **HOT DIP GALVANIZED**  
All ROHN towers are hot dip galvanized after fabrication.

■ **REPUTATION**  
ROHN is one of the leading tower manufacturers, with over 25 years of experience.

Write today for complete details.

TWX: 910-652-0646 FAX: 309-697-5612

QUALITY STEEL PRODUCTS BY

# ROHN

Box 2000 · Peoria, Illinois 61656  
U.S.A.

Please send all reader inquiries directly.

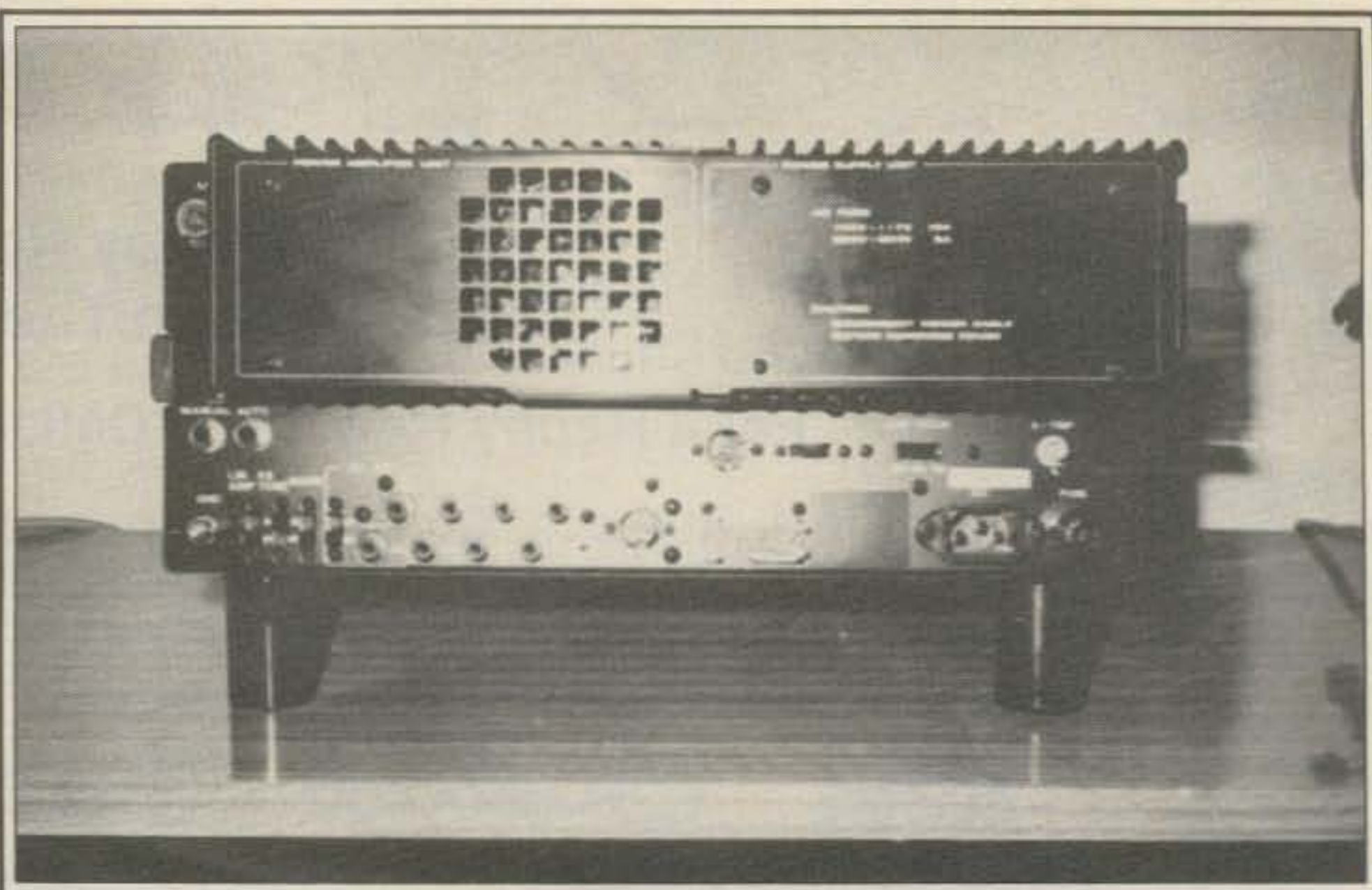

The rear panel of the FT-980 is dominated by enclosed heatsinks (on the right for the power supply and on the left for the power amplifier) plus a variety of connectors for about any possible external accessory items (e.g., linears, transverters, etc.).

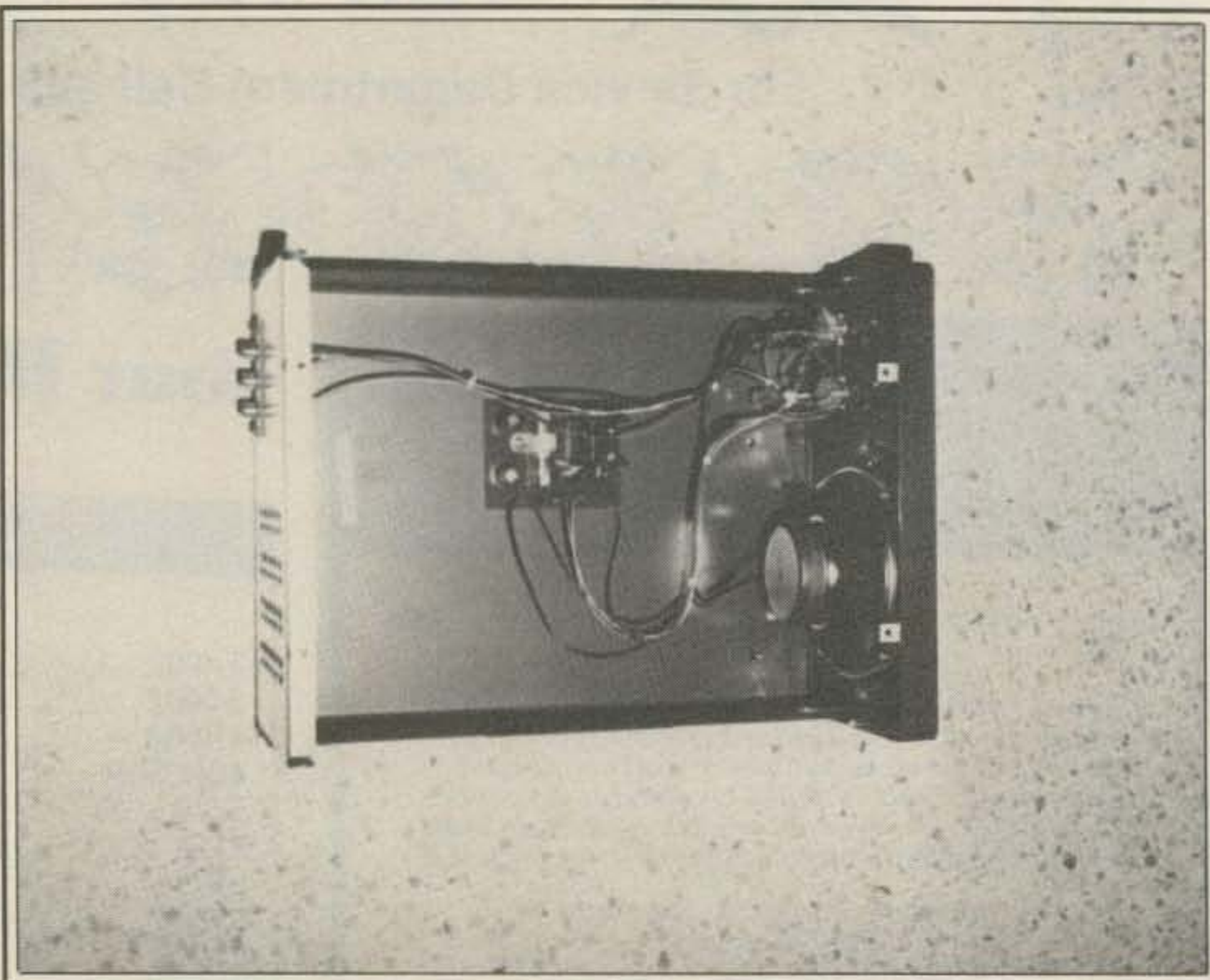

An internal view of the SP-980 optional speaker. It contains front-panel selectable LC filters so one can independently roll off the low or high frequency response. The LC filter board is visible in the approximate center of the bottom cover of the SP-980.

first things one notices when tuning is the digital frequency scroll between the frequency display and the main tuning. The display is slightly confusing at first, but one rapidly appreciates that it is a very handy means to quickly establish which 50 kHz segment of a band (amateur or general coverage) one is tuning. So rather than look at the exact digital readout with its rapidly changing digits as one tunes, one can look at the much more comfortable to view digital scroll.

For instance, if one starts out at 21,050 kHz, the scroll will have the display 0-050-0 with the 5 centered in the middle of the display. As

one tunes higher in frequency, an LED "dash" appears, in turn, in calibrated 1 kHz steps beneath each of the nine display positions. The frequency 21,059 kHz is indicated by the display 0-050-0. As one tunes another full kHz, the display jumps to 00-050-. The 050 portion of the display moves to the right of center to indicate one is above 21,060 kHz. Still further tuning causes the "dash" LED to move from left to right for upward frequency tuning or right to left for downward frequency tuning for displays such as 0-150-1 (21,150 kHz) or 050-000- (21,020 kHz) might appear. The sequence is a bit difficult to explain, since one



must also take into account a centerline marker on the window in front of the scroll display. Fig. 6 illustrates the scroll feature in more detail. In use there is absolutely no ambiguity about which 50 kHz portion of a band one is tuning. I rarely ever looked at the main frequency display when tuning through a band except when an exact frequency was of interest. Besides using the main tuning, the FT-980 can also be tuned using the frequency scan buttons located beneath the main tuning knob or by similar buttons on a scanning-type microphone. The two scan speeds (previously mentioned) are just right for quick scan through a band or detailed tuning, even on c.w.

For general-coverage receive, one simply depresses the **GEN** button and tunes as before. The **UP** and **DOWN** buttons now move the received frequency in 500 kHz bands. A **REPEAT** key allows the bands to be moved continuously up or down until a desired band is reached. There is also a 5 kHz **UP** and **DOWN** key so one can scan the SW broadcast bands in 5 kHz steps, if desired.

The upper two rows on the keypad on the right side of the FT-980 have a dual function. In the frequency entry mode (initiated by pressing the **ENT** key) one enters any desired transceive or receive frequency by following the numbers on the 0 to 9 keys. It doesn't matter what band one is using; one can switch instantly to another band once the frequency keyboard entry is completed. The other functions of the keys involve switching on or off the receive and/or transmit offset feature, choosing control of the transceiver by the v.f.o. or a memory channel, for split-frequency operation choosing whether the receive frequency will come from the v.f.o. or a memory channel, and setting tuning or "tab" limits for v.f.o. tuning. The latter is an interesting convenience feature. It can be used to limit v.f.o. tuning to a sub-band applicable to one's license grade, for instance, so one doesn't have to constantly monitor the frequency display. Once the "tab" limits have been entered, tuning by scanning will also be confined to those limits.

The memory channel switch is above the keypad and has four keys associated with it. To enter a frequency from a v.f.o. one simply sets the switch to one of the 12 memories and depresses a **WRITE** key. The mode for which the v.f.o. was set is also memorized. A **CHECK** key allows one to display the frequency and mode stored in each memory without changing the operating frequency of the transceiver. A **SHIFT** key allows any memory to become tunable, and if in tuning one finds a frequency of interest, using the **WRITE** key will enter that new frequency into memory. The system works extremely fine, but has only one slight disadvantage. When one selects a memory channel for use, one cannot use the **MODE** selector. Therefore, if one calls up a memory channel that was entered for use with u.s.b., one cannot switch to l.s.b. without going back to v.f.o. tuning and then changing the mode and entering the frequency and mode into memory. When the memories are used for frequencies in the amateur bands, they can be used for full transceive operation, which is a great convenience, for instance, if one tunes across a band (or bands) in the v.f.o. mode, finds stations of interest in QSO, stores their frequencies in memory, and then wishes to instantly transmit once one of the stations is free.

During many hours of operation all of the features and controls on the FT-980 worked without fault. Full QSK was possible within a band and semi-QSK for crossband and/or

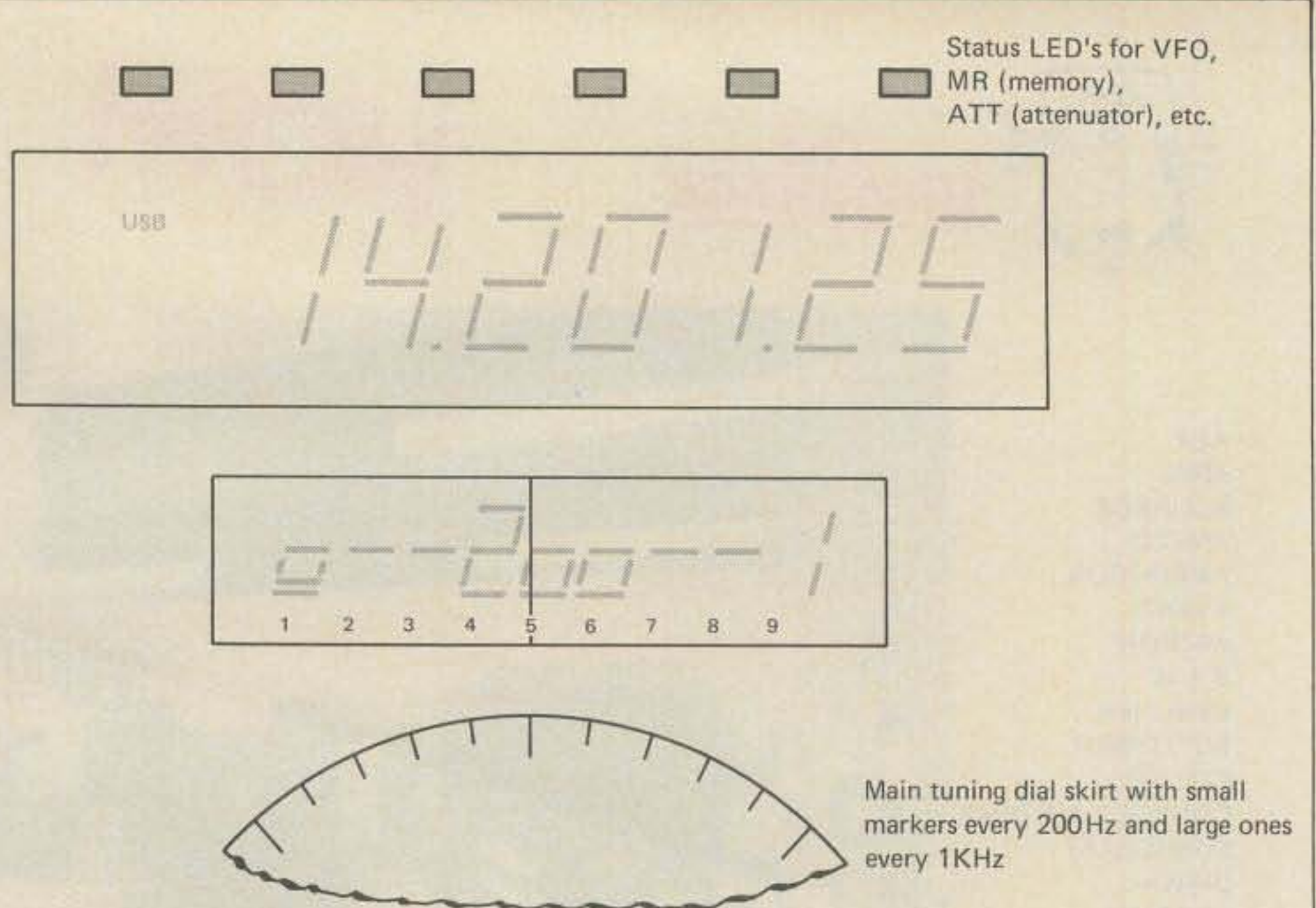
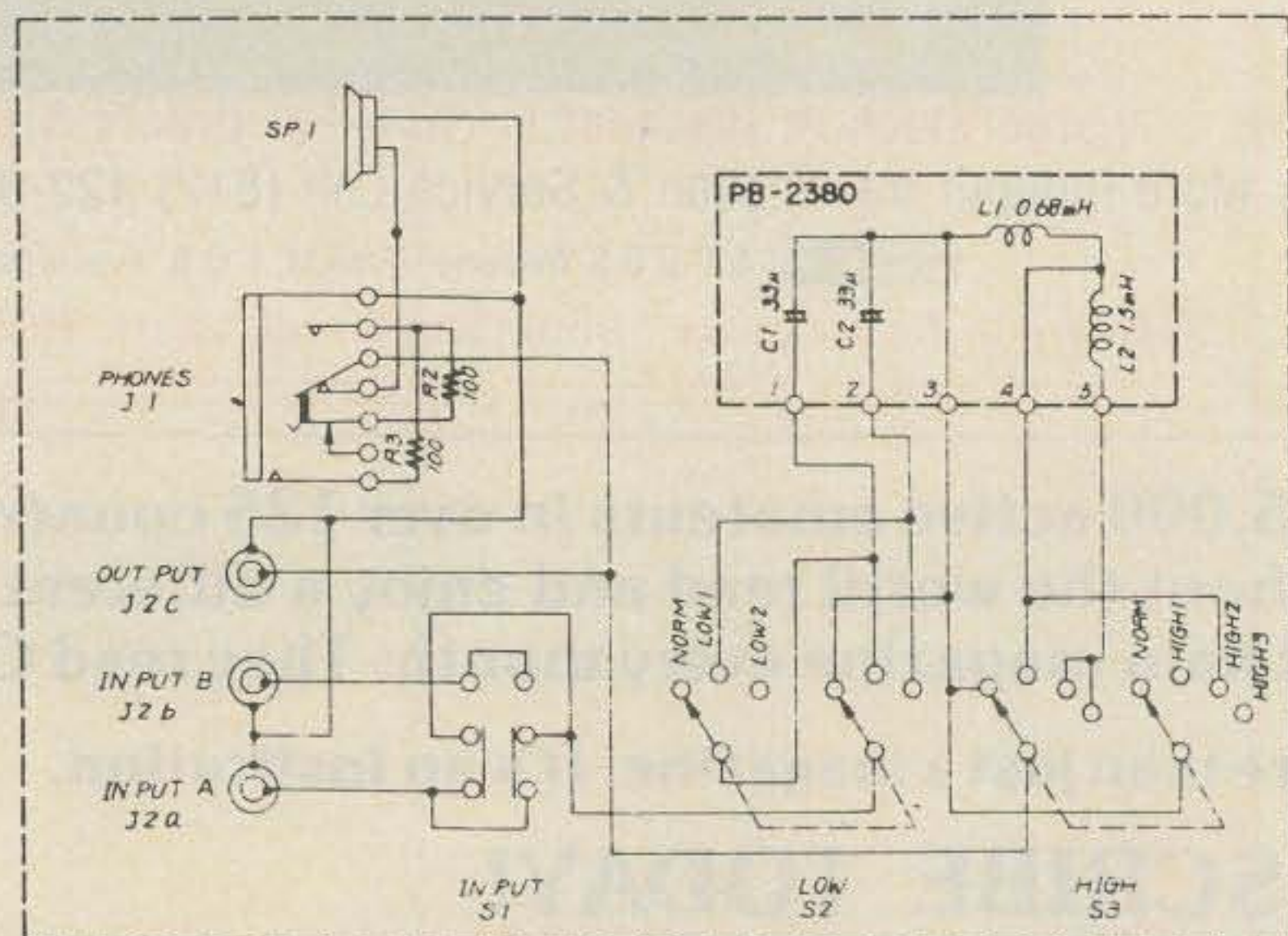

Fig. 6— An illustration and explanation of the digital frequency "scroll" feature in the FT-980.



#### SPECIFICATIONS

##### Speaker Element:

Diameter	120 mm
Power Rating	3 watts
Impedance	8 ohms
Frequency Range	100-12000 Hz

##### General

Case Dimensions (HWD)	129 x 200 x 306 mm
Weight	2.2 kg

##### Filter Circuit Selections:

LOW 1	below 300 Hz	(-6 dB/octave)
2	below 600 Hz	(-6 dB/octave)
HIGH 1	above 2.4 kHz	(-6 dB/octave)
2	above 1 kHz	(-6 dB/octave)
3	above 700 Hz	(-6 dB/octave)

Fig. 7— Specifications and electrical diagram for the optional SP-980 speaker/filter system.

crossmode operation. The FT-980 has so many convenience features that it takes a long time to appreciate them all. The various a.f. and i.f. filtering possibilities along with the i.f. shift and width controls, for instance, could be adjusted to overcome almost any QRM situation. The noise blanker was effective both against ignition noise and the "woodpecker." The dual metering system is very convenient. As usual, Yaesu's microphone squelch system (to reduce background noise) and r.f. processing system got excellent on-the-air re-

ports. The operating manual for the unit is clear and very well illustrated. It also contains full electrical diagrams, which although not sufficient for complete service and alignment, are certainly sufficient for basic troubleshooting.

Even forgetting temporarily the computer control possibilities for the FT-980, I would not hesitate to endorse the FT-980 as a high-performance, heavy-duty base station transceiver that strikes an excellent balance between price and features.