

YAESU

The radio

HF/50 MHz TRANSCEIVER

FT DX 1200

OPERATING MANUAL



YAESU MUSEN CO., LTD.
Tennozu Parkside Building
2-5-8 Higashi-Shinagawa, Shinagawa-ku, Tokyo 140-0002 Japan

YAESU USA
6125 Phyllis Drive, Cypress, CA 90630, U.S.A.

YAESU UK
Unit 12, Sun Valley Business Park, Winnall Close
Winchester, Hampshire, SO23 0LB, U.K.

YAESU HK
Unit 2002, 20/F, 9 Chong Yip Street,
Kwun Tong, Kowloon, Hong Kong

ABOUT THIS MANUAL . . .

The **FTdx1200** is a leading-edge transceiver with a number of new and exciting features, some of which may be unfamiliar to you. In order to gain the most enjoyment and operating efficiency from your **FTdx1200**, we recommend that you read this manual in its entirety, and keep it handy for reference as you explore the many capabilities of your new transceiver.

Before using your **FTdx1200**, be sure to read and follow the instructions in the “Before You Begin” section of this manual.

Congratulations on the purchase of your Yaesu amateur transceiver! If this is your first rig, or if Yaesu equipment is already the backbone of your station, rest assured your transceiver will provide many hours of operating pleasure for years to come.

The **FTDx1200** is an elite-class HF transceiver providing exceptional performance both on transmit and receive. The **FTDx1200** is designed for the most competitive operating situations, whether you primarily operate in contest, DX, or digital-mode environments.

Built on the foundation of the popular **FTDx9000** transceiver, and carrying on the proud tradition of the **FT-1000** series, the **FTDx1200** provides up to 100 Watts of power output on SSB, CW, and FM (25 Watts AM carrier). Digital Signal Processing (DSP) is utilized throughout the design, providing leading-edge transmitter and receiver performance.

For exceptional protection from strong signal interference, the optional RF μ Tuning Kits may be connected via the rear panel. The RF μ Tuning Kits provide extraordinarily sharp selectivity and protect your receiver from close-in interference on a crowded band.

In the front end, you may select one of two RF preamplifiers, or IPO (Intercept Point Optimization), providing direct feed to the first mixer. Three levels of RF attenuation are available in 6-dB steps.

The **FTDx1200** receiver utilizes DSP filtering, incorporating many of the features of the **FTDx9000**, such as: Variable Bandwidth, IF Shift, and Passband Contour tuning. Also provided are Digital Noise Reduction, Digital Auto-Notch Filtering and a manually tuned IF Notch filter.

On the transmit side, the Yaesu exclusive Three-Band Parametric Microphone Equalizer allows precise and flexible adjustment of the waveform created by your voice and microphone. The audio Amplitude, Center Frequency, and Bandwidth are adjusted separately for the low, mid-range, and high-frequency audio spectrum. The transmitted bandwidth may also be adjusted.

Advanced features include: Direct Keyboard Frequency Entry and Band Change, Speech Processor, IF Monitor for Voice modes, CW Pitch control, CW Spot switch, Full CW QSK, CW Message Memory, adjustable IF Noise Blanker, and all mode Squelch. Two TX/RX antenna ports are provided on the rear panel. Two key jacks are provided (one on the front and one on the rear panel). The key jacks may be configured independently for paddle input, connection to a straight key, or computer-driven keying interface.

Frequency setup is straightforward on the **FTDx1200**. Enter frequency directly for VFO-A. Separate keys are available for band selection. Each band key provides three separate VFO settings for three different parts of each band. You may create three independent VFO settings of frequency, mode, and filter for each band.

In addition, 99 memories are provided to store: Frequency, Mode, IF filter selection, Clarifier offset, and Scan-skip status. What's more, five quick-recall ("QMB") memories can instantly store operational settings at the push of a button.

The built-in antenna tuner includes 100 memories that automatically store antenna matching settings for rapid, later automatic recall.

Interfacing for digital modes is extremely simple with the **FTDx1200**, thanks to the dedicated RTTY/DATA connection jack on the rear panel. Optimization of the filter passband, DSP settings, carrier insertion point, and display offset for digital modes, is possible via the Menu programming system.

Advanced technology is only part of the **FTDx1200** story. Yaesu stands behind our products with a worldwide network of dealers and service centers. We greatly appreciate your investment in the **FTDx1200**, and we look forward to helping you get the most enjoyment from your new transceiver. Please feel free to contact your nearest dealer, or one of Yaesu's national headquarters offices, for technical advice, interfacing assistance, or accessory recommendation. Watch Yaesu U.S.A.'s Home Page for late-breaking information about Standard Horizon and Yaesu products: <http://www.yaesu.com>.

Please read this manual thoroughly, to gain maximum understanding of the full capability of the **FTDx1200**. We thank you again for your purchase!

TABLE OF CONTENTS

General Description	1	NARROW (NAR) One-Touch IF Filter Selection	55
Table of Contents	2	IF NOTCH Filter Operation	
Accessories & Options	4	(SSB/CW/RTTY/DATA/AM Modes)	56
Supplied Accessories	4	Digital NOTCH Filter (DNF) Operation	57
Available Options	5	Digital Noise Reduction (DNR) Operation	57
Before You Begin	6	Tools for Comfortable and Effective Reception	58
Extending the Front Feet	6	RF Gain	58
Adjusting the Main Tuning Dial Torque	6	DSP IF Filter Types	59
Adjusting the Clock	7	Audio Pitch Control (SSB mode)	60
Resetting the Microprocessor	7	Audio Peak Filter	60
Installation and Interconnections	8	AGC (Automatic Gain Control)	61
Antenna Considerations	8	Adjustable Receiver Audio Filter	62
About Coaxial Cable	8	SSB/AM Mode Transmission	63
Grounding	9	Using the Automatic Antenna Tuner	65
Connection of Antenna and Power Cables	10	ATU Operation	65
Connection of Microphone and Headphone	11	About ATU Operation	66
Key, Keyer, and Computer-Driven Keying		Enhancing Transmit Signal Quality	67
Interconnections	12	Parametric Microphone Equalizer	
VL-1000 Linear Amplifier Interconnections	13	(SSB/AM/FM mode)	67
Interfacing to Other Linear Amplifiers	14	Using the Speech Processor (SSB Mode)	69
Plug/Connector Pinout Diagrams	15	Adjusting the SSB Transmitted Bandwidth	
Front Panel Controls & Switches	16	(SSB Mode)	70
Display Indications	26	Transmitter Convenience Features	71
Rear Panel	29	Voice Memory (SSB/AM/FM modes:	
Optional FH-2 Switches	31	Requires optional DVS-6 and FH-2)	71
Basic Operation: Receiving on Amateur Bands	32	VOX (SSB/AM/FM Modes: Automatic TX/RX	
Operation on 60-Meter (5 MHz) Band		Switching using Voice Control)	73
(U.S. and U.K. version only)	35	MONITOR (SSB/AM/FM modes)	74
CLAR (Clarifier) Operation	36	Split Operation Using the TX Clarifier	75
LOCK	37	Split-Frequency Operation	76
DIMMER	37	CW Mode Operation	77
VFO COLOR	37	Setup for Straight Key	
Convenience Features	38	(and Straight Key emulation) Operation	77
Band Stack Operation	38	Using the Built-in Electronic Keyer	78
C.S (Custom Switch)	38	CW Convenience Features	81
SCOPE	39	CW Spotting (Zero-Beating)	81
Rotator Control Functions	42	Using CW Reverse	82
More Frequency Navigation Techniques	43	CW Delay Time Setting	83
Antenna Selection	44	CW Pitch Adjustment	83
Receiver Operation (Front End Block Diagram)	45	Contest Memory Keyer (Using the Optional	
Interference Rejection	46	FH-2 Remote Control Keypad)	84
ATT	46	CW Decode	89
μ -TUNE FILTER (REQUIRES THE OPTIONAL		FM Mode Operation	90
RF μ TUNING KIT)	47	Basic Operation	90
IPO (Intercept Point Optimization)	49	Repeater Operation	91
R.FLT (Roofing Filters)	50	Tone Squelch Operation	92
IF Noise Blanker (NB) Operation	51	Memory Operation	93
CONTOUR Control Operation	52	Convenient Memory functions	93
IF SHIFT Operation		QMB (Quick Memory Bank)	93
(SSB/CW/RTTY/PKT Modes)	53	Standard Memory Operation	94
WIDTH (IF DSP Bandwidth) Tuning		Memory Groups	98
(SSB/CW/RTTY/DATA Modes)	54		

TABLE OF CONTENTS

Operation on Alaska Emergency Frequency:	
5167.5 khz (U.S. Version Only)	99
VFO and Memory Scanning	100
VFO Scanning	100
Memory Scan	101
PMS (Programmable Memory Scanning)	102
RTTY (Radio Teletype) Operation	103
RTTY Decode (with Optional FFT Unit).....	103
RTTY Text Memory (with Optional FFT Unit) ...	104
Example of Connecting RTTY Communications Device.....	104
DATA (PSK) Operation	105
PSK Decode (with Optional FFT Unit).....	105
PSK Text Memory (with Optional FFT Unit)	106
Example of Data Communications Device	106
Menu Mode.....	107
AGC Group	112
DISPLAY Group	112
DVS Group.....	113
KEYER Group	113
GENERAL Group	114
MODE-AM Group	116
MODE-CW Group	116
MODE-DATA Group	117
MODE-FM Group.....	118
MODE-RTTY Group	119
MODE-SSB Group	119
RX DSP Group.....	120
SCOPE Group	121
TUNING Group	123
TX AUDIO Group.....	123
TX GNRL Group.....	125
AF SCOPE Group.....	125
DEC CW.....	125
E/D RTTY Group	126
E/D PSK Group.....	126
Installation of Optional Accessories	127
FFT Unit (FFT-1)	127
Voice Memory Unit (DVS-6).....	128
RF μ Tuning Kit	129
FC-40 External Automatic Antenna Tuner (for Wire Antenna).....	130
SCU-17 USB Interface Unit.....	132
Specifications	134

ACCESSORIES & OPTIONS

SUPPLIED ACCESSORIES

Hand Microphone (MH-31B8)	1 pc	A07890001
DC Power Cord	1 pc	T9025225
Spare Fuse (25A)	1 pc	Q0000074
RCA Plug	2 pcs	P0091365
Operating Manual	1 pc	
Warranty Card	1 pc	

AVAILABLE OPTIONS

MD-200A8X	Ultra-High-Fidelity Desktop Microphone
MD-100A8X	Desktop Microphone
YH-77STA	Lightweight Stereo Headphone
FH-2	Remote Control Keypad
VL-1000/VP-1000	Linear Amplifier/AC Power Supply
RF μTuning Kit A	For 160 m Band
RF μTuning Kit B	For 80/40 m Bands
RF μTuning Kit C	For 30/20 m Bands
FC-40	External Automatic Antenna Tuner
FP-1030A	External Power Supply (13.8 VDC 25 A)
FP-2023A	External Power Supply (13.8 VDC 23 A, USA Only)
DVS-6	Voice Memory Unit
FFT-1	FFT Unit
SCU-17	USB Interface Unit
CT-118	VL-1000 Linear Amplifier Connection Cable
CT-39A	Packet Interface Cable
CT Cable (MDIN6P - MDIN6P 2m)	Antenna Rotator Connection Cable (P/N T9101556)
CT Cable (MDIN10P - Bare Wire 2m)	Linear Amplifier Connection Cable (P/N T9207451)

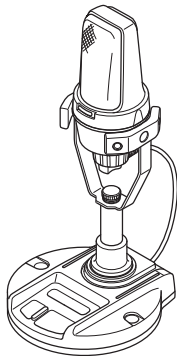

MD-200A8X



YH-77STA

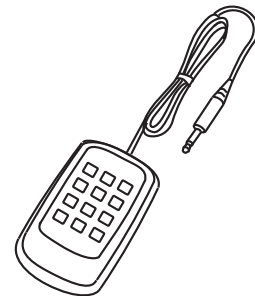

FH-2

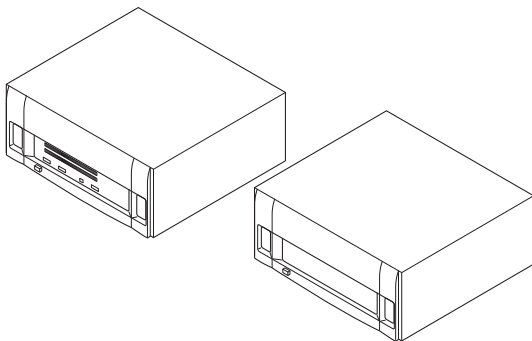

VL-1000/VP-1000

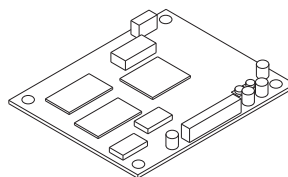

FFT-1

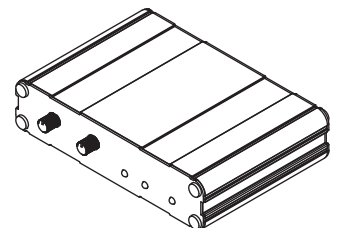

SCU-17

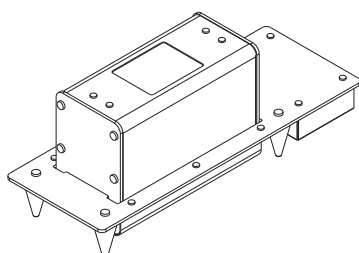

RF μ Tuning Kit

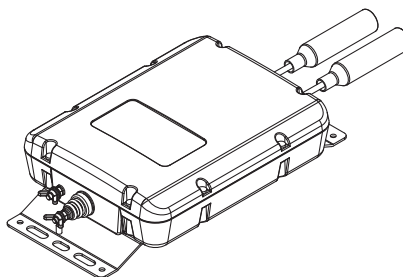

FC-40

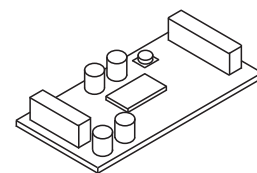

DVS-6

BEFORE YOU BEGIN

EXTENDING THE FRONT FEET

To elevate the front panel for easy viewing, the front left and right feet on the case bottom may be extended.

- ① Pull the front legs outward from the bottom panel.
- ② Rotate the legs counter-clockwise to lock them in the extended position. Be sure the legs have locked securely in place, because the transceiver is quite heavy and an unlocked leg could result in damage, should the transceiver move suddenly.

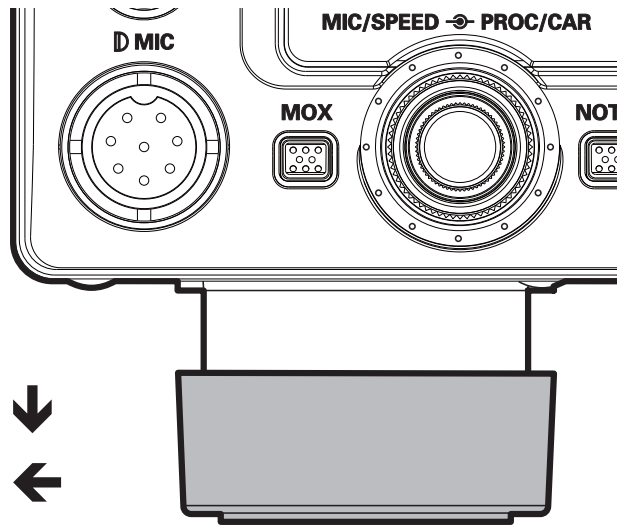

Retracting the Front Feet

- ① Rotate the legs clockwise.
- ② Push them inward while continuing to rotate clockwise. The front feet should now be locked in the retracted position.

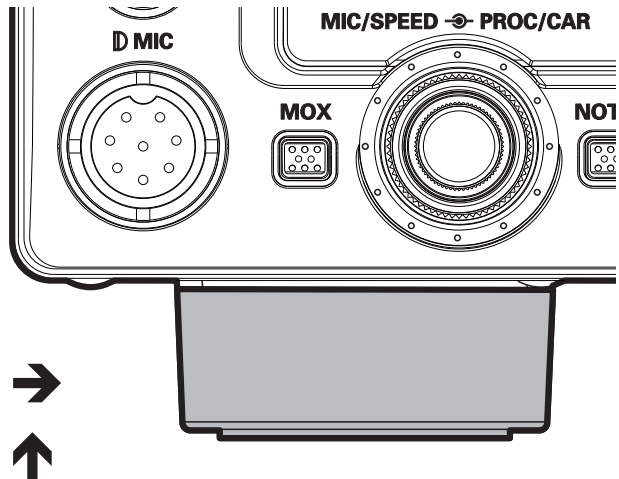

ADJUSTING THE MAIN TUNING DIAL TORQUE

The torque (drag) of the Main Tuning Dial knob may be adjusted according to your preferences. Rotate the skirt at the base of the knob clockwise to reduce the drag, or counter-clockwise to increase the drag.

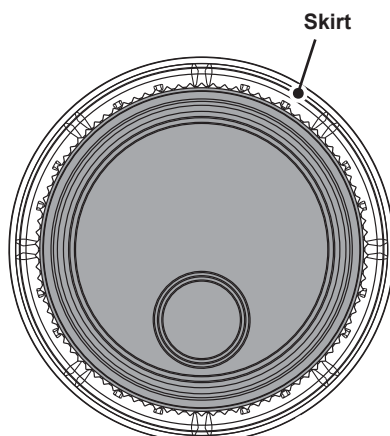

ADJUSTING THE CLOCK

Use the following procedure to adjust the clock shown at the middle right of the TFT display.

1. Press and hold the **[C.S]** button until the clock digits blink.
2. Enter the present time with the number keys (**[BAND]** keys).
3. Press the **[ENT]** button.

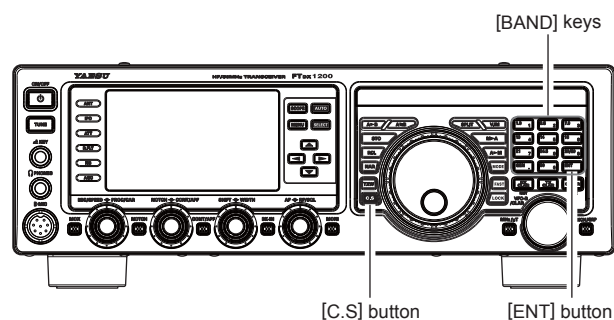

RESETTING THE MICROPROCESSOR

RESETTING MEMORIES (ONLY)

Use this procedure to reset (clear) the previously stored Memory channels, without affecting any configuration changes you may have made to the Menu settings.

1. Press the front panel **[POWER]** switch to turn the transceiver off.
2. While holding the **[A▶M]** button in, press and hold in the front panel **[POWER]** switch to turn the transceiver on. Once the transceiver comes on, you may release the buttons.

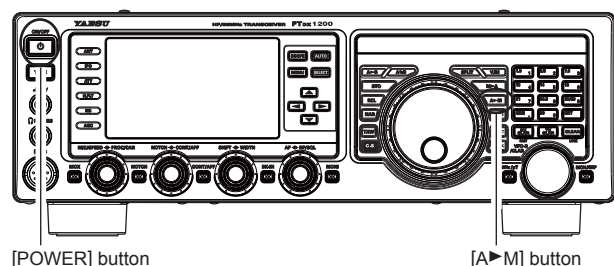

MENU RESETTING

Use this procedure to restore the Menu settings to their factory defaults, without affecting the memories you have programmed.

1. Press the front panel **[POWER]** switch to turn the transceiver off.
2. While holding the **[MENU]** button in, press and hold in the front panel **[POWER]** switch to turn the transceiver on. Once the transceiver comes on, you may release the buttons.

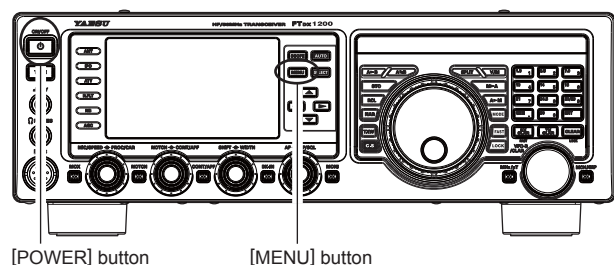

FULL RESET

Use this procedure to restore all Menu and Memory settings to their original factory defaults. All Memories will be cleared by this procedure.

1. Press the front panel **[POWER]** switch to turn the transceiver off.
2. While holding the **[FAST]** and **[LOCK]** buttons in, press and hold in the front panel **[POWER]** switch to turn the transceiver on. Once the transceiver comes on, you may release the buttons.

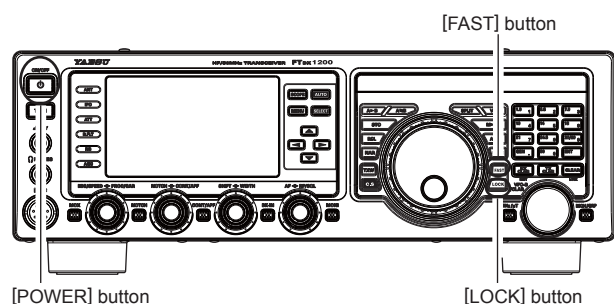

IMPORTANT NOTE:

When the optional μ Tuning Kit is connected to the **FTdx1200**, disconnect all the cables from the μ Tuning Kit before performing the Full Reset.

INSTALLATION AND INTERCONNECTIONS

ANTENNA CONSIDERATIONS

The **FTDx1200** is designed for use with any antenna system providing a 50 Ohm resistive impedance at the desired operating frequency. While minor excursions from the 50-Ohm specification are of no consequence, if the Standing Wave Ratio (SWR) present at the Antenna jack is greater than 3:1, the transceiver's Automatic Antenna Tuner may not be able to reduce the impedance mismatch to an acceptable value.

Every effort should be made to ensure that the impedance of the antenna system be as close as possible to the specified 50-Ohm value. Note that the "G5RV" type antenna does not provide a 50-Ohm impedance on all HF Amateur bands. An external wide-range antenna coupler must be used with this antenna type.

Any antenna to be used with the **FTDx1200** must be fed from the transceiver with 50 Ohm coaxial cable. Therefore, when using a "balanced" antenna such as a dipole, remember that a balun or other matching/balancing device must be used to ensure proper antenna performance.

The same precautions apply to any additional (receive-only) antennas connected to the antenna jacks. If your receive-only antennas do not have impedance near 50 Ohms at the operating frequency, you may need to install an external antenna tuner to obtain optimum performance.

ABOUT COAXIAL CABLE

Use high-quality 50-Ohm coaxial cable for the lead-in to your **FTDx1200** transceiver. All efforts at providing an efficient antenna system will be wasted if poor quality, lossy coaxial cable is used. This transceiver utilizes standard "M" ("PL-259") type connectors.

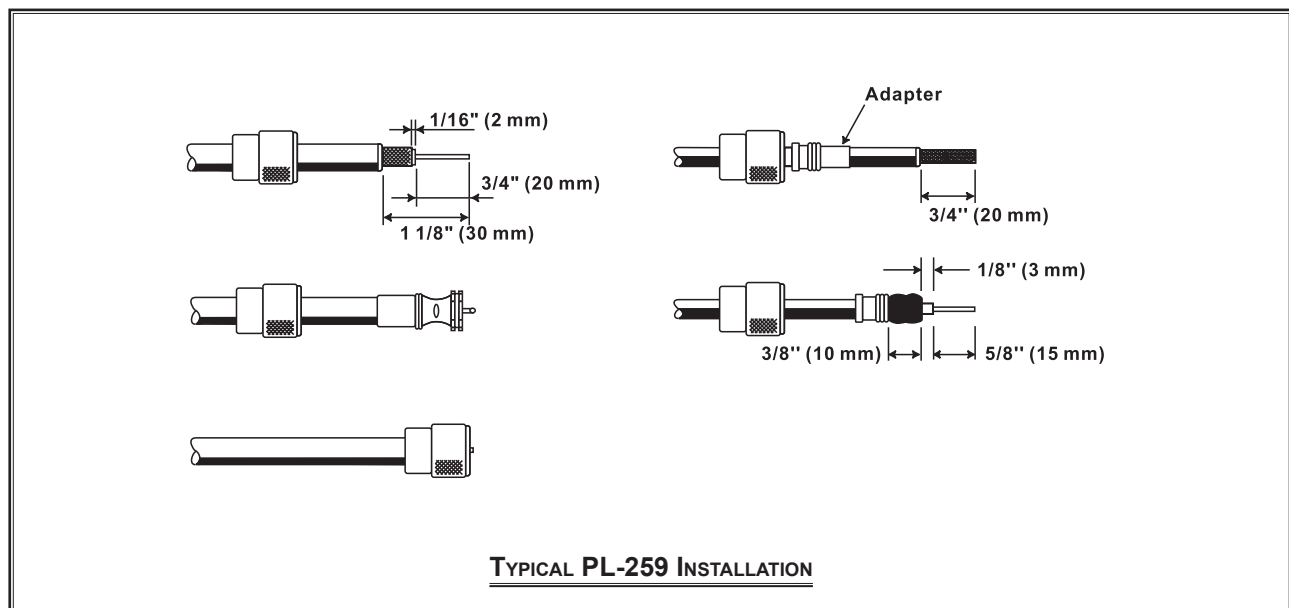

INSTALLATION AND INTERCONNECTIONS

GROUNDING

The **FTdx1200** transceiver, like any other HF communications apparatus, requires an effective ground system for maximum electrical safety and best communications effectiveness. A good ground system can contribute to station efficiency in a number of ways:

- ❑ It can minimize the possibility of electrical shock to the operator.
- ❑ It can minimize RF currents flowing on the shield of the coaxial cable and the chassis of the transceiver. such currents may lead to radiation, which can cause interference to home entertainment devices or laboratory test equipment.
- ❑ It can minimize the possibility of erratic transceiver/accessory operation caused by RF feedback and/or improper current flow through logic devices.

An effective earth ground system may take several forms. for a more complete discussion, see an appropriate RF engineering text. The information below is intended only as a guideline.

Typically, the ground connection consists of one or more copper-clad steel rods, driven into the ground. If multiple ground rods are used, they should be positioned in a “V” configuration and bonded together at the base of the “V” which is nearest the station location. Use a heavy, braided cable (such as the discarded shield from type RG-213 coaxial cable) and strong cable clamps to secure the braided cable(s) to the ground rods. Be sure to weatherproof the connections to ensure many years of reliable service. Use the same type of heavy, braided cable for the connections to the station ground bus (described below).

Inside the station, a common ground bus consisting of a copper pipe of at least 25 mm diameter should be used. An alternative station ground bus may consist of a wide copper plate (single-sided circuit board material is ideal) secured to the bottom of the operating desk. Grounding connections from individual transceivers, power supplies, and data communications devices (TNCs, etc.) should be made directly to the ground bus using a heavy, braided cable.

Do not “Daisy-Chain” ground connections from one electrical device to another and thence to the ground bus. This method may nullify any attempt at effective radio frequency grounding. See the drawing below for examples of proper grounding techniques.

Inspect the ground system - inside the station as well as outside - on a regular basis to ensure continued performance and safety.

Besides following the above guidelines carefully, note that household or industrial gas lines must never be used in an attempt to establish an electrical ground. Cold water pipes may, in some instances, help in the grounding effort, but gas lines represent a significant explosion hazard, and must never be used.

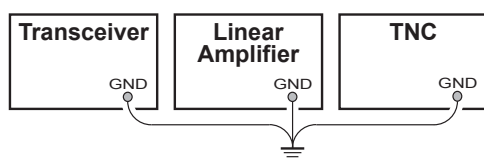

PROPER GROUND CONNECTION

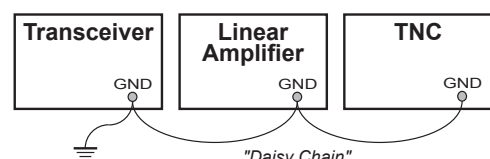

IMPROPER GROUND CONNECTION

INSTALLATION AND INTERCONNECTIONS

CONNECTION OF ANTENNA AND POWER CABLES

Please follow the outline in the illustration regarding the proper connection of antenna coaxial cables, as well as the DC power cable. The DC power connector for the **FTdx1200** must only be connected to a DC source providing 13.8 Volts DC ($\pm 10\%$), and capable of at least 23 Amperes of current. Always observe proper polarity when making DC connection:

The RED DC power lead connects to the Positive (+) DC terminal.

The BLACK DC power lead connects to the Negative (-) DC terminal.

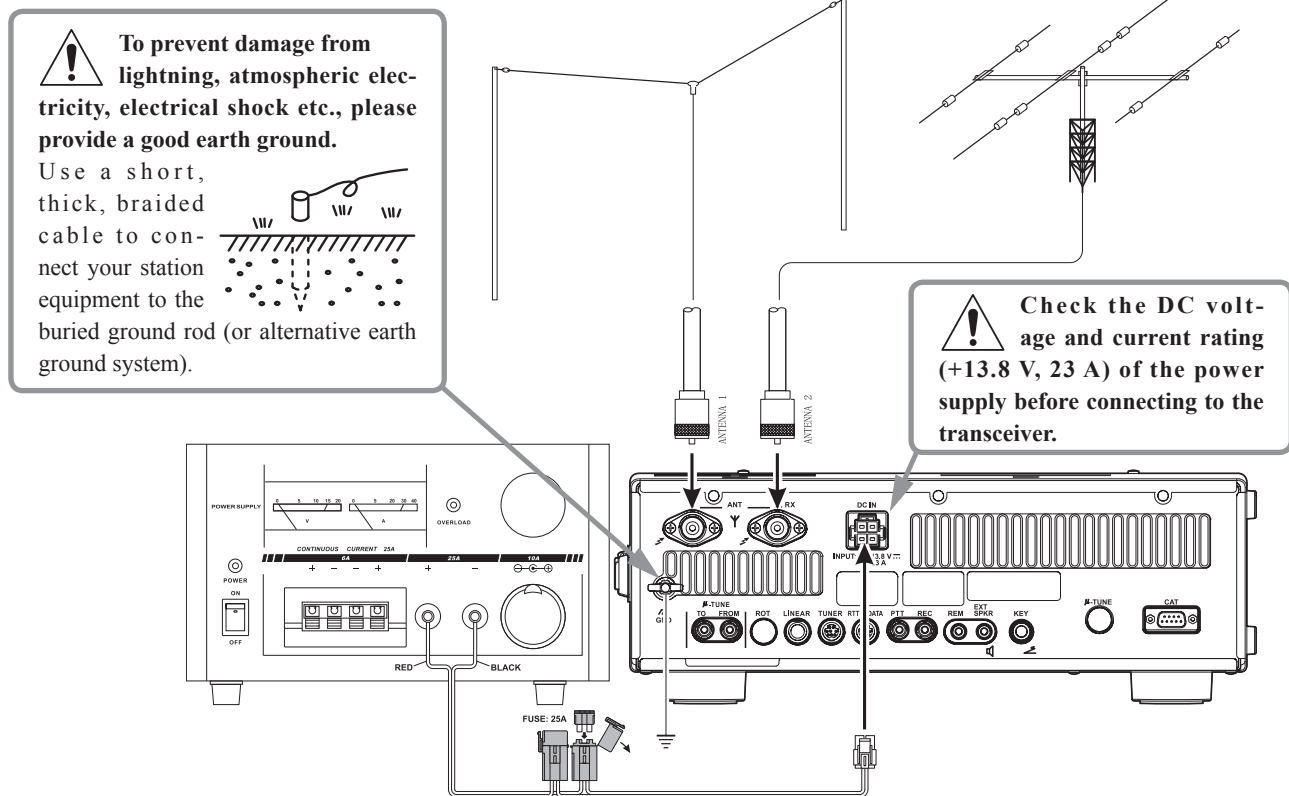

We recommend the use of the **FP-1030A** (USA market only) AC Power Supply. Other models of power supplies may be used with the **FTdx1200**, but the 13.8 VDC input voltage, 23 Ampere current capability, and DC cable polarity guidelines described above must be strictly followed.

Note that other manufacturers may use the same type of DC power connections as does your **FTdx1200** transceiver, however, the wiring configuration may be different from that specified for your transceiver. Serious damage can be caused if improper DC connections are made; consult with a qualified service technician when in doubt.

! The 100 V RF voltage (@100 W/50-ohm) is applied to the TX RF section of the transceiver while transmitting. Do not touch the TX RF section absolutely while transmitting.

! Permanent damage can result when improper supply voltage, or reverse-polarity voltage, is applied to the **FTdx1200. The Limited Warranty on this transceiver does not cover damage caused by application of AC voltage, reverse polarity DC, or DC voltage outside the specified range of 13.8 V $\pm 10\%$. When replacing fuses, be certain to use a fuse of the proper rating. The **FTdx1200** requires a 25 A blade fuse.**

ADVICE:

- Do not position the **FTdx1200** in a location with direct exposure to sunshine.
- Do not position the **FTdx1200** in a location exposed to dust and/or high humidity.
- Ensure adequate ventilation around the **FTdx1200**, to prevent heat build-up and possible reduction of performance due to high heat.
- Do not install the **FTdx1200** on an unstable desk or table. Do not place in a location where objects may fall onto it from above.
- To minimize the possibility of interference to home entertainment devices, take all precautionary steps including separation of TV/FM antennas from Amateur transmitting antennas to the greatest extent possible, and keep transmitting coaxial cables separated from cables connected to home entertainment devices.
- Ensure that the DC power cord is not subject to undue stress or bending, which could damage the cable or cause it to be accidentally unplugged from the rear panel **DC IN** jack.
- Be certain to install your transmitting antenna(s) so they cannot possibly come in contact with TV/FM radio or other antennas, or with power or telephone lines.

INSTALLATION AND INTERCONNECTIONS

CONNECTION OF MICROPHONE AND HEADPHONE

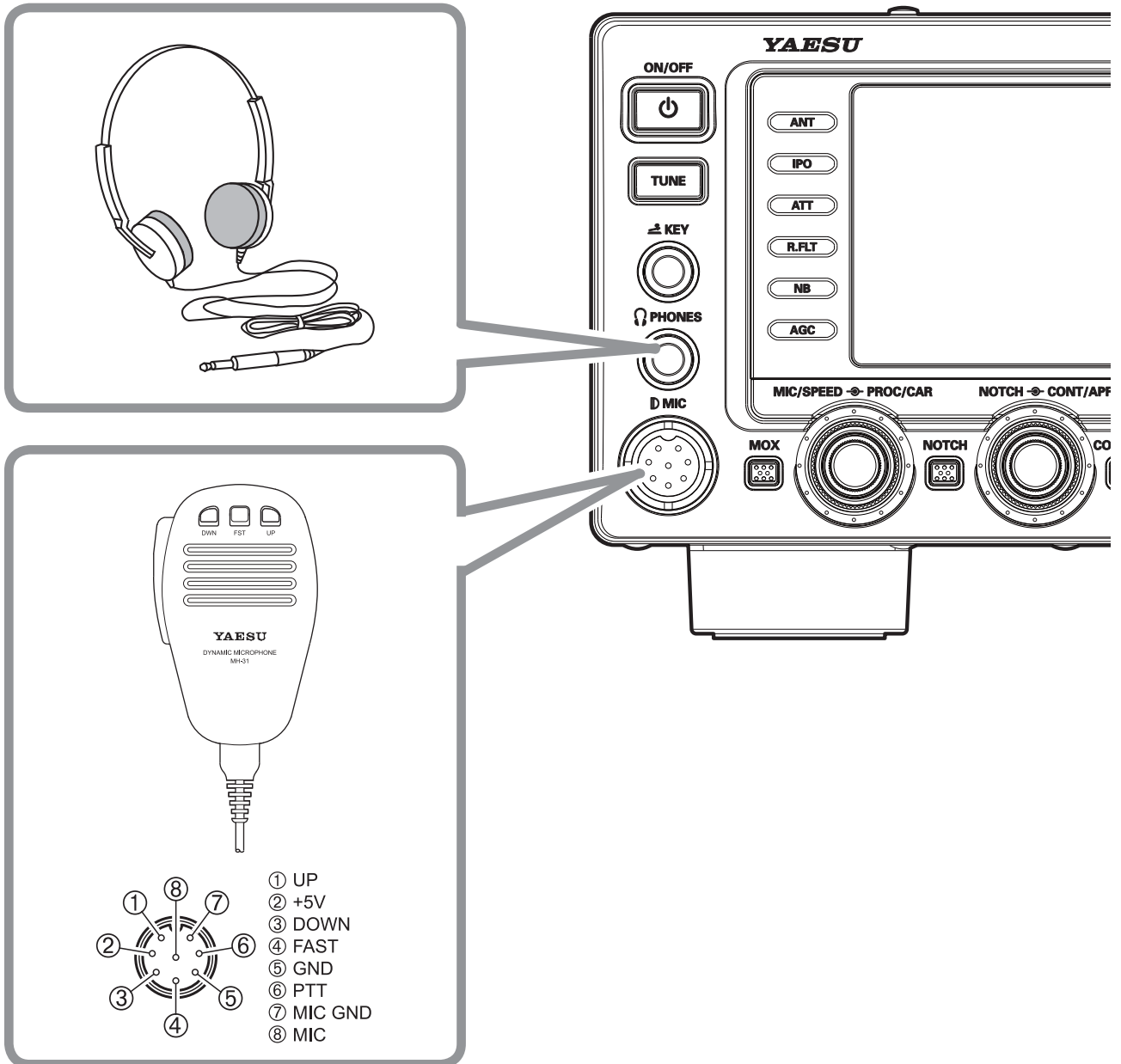

INSTALLATION AND INTERCONNECTIONS

KEY, KEYSER, AND COMPUTER-DRIVEN KEYING INTERCONNECTIONS

The **FTdx1200** includes many features for the CW operator. These functions will be detailed in the “Operation” section later. Besides the built-in Electronic Keyer, two key jacks are provided, one on the front and one on the rear panel, for convenient connection to keying devices.

The Menu selections allow you to configure the front and rear panel **KEY** jacks according to the device you wish to connect. For example, you may connect your keyer paddle to the front panel **KEY** jack, and use Menu item “018 F KEYSER TYPE” for paddle input, and also connect the keying line from your personal computer (which emulates a “straight key”) to the rear panel **KEY** jack, and configure the rear panel jack using Menu item “020 R KEYSER TYPE”.

Both **KEY** jacks on the **FTdx1200** utilize “Positive” keying voltage. Key-up voltage is approximately +3.3V DC, and key-down current is approximately 4 mA. When connecting a key or other device to the **KEY** jacks, use *only* a 3-contact (“stereo”) 1/4” phone plug; a 2-contact plug will place a short between the ring and (grounded) shaft of the plug, resulting in a constant “key-down” condition in some circumstances.

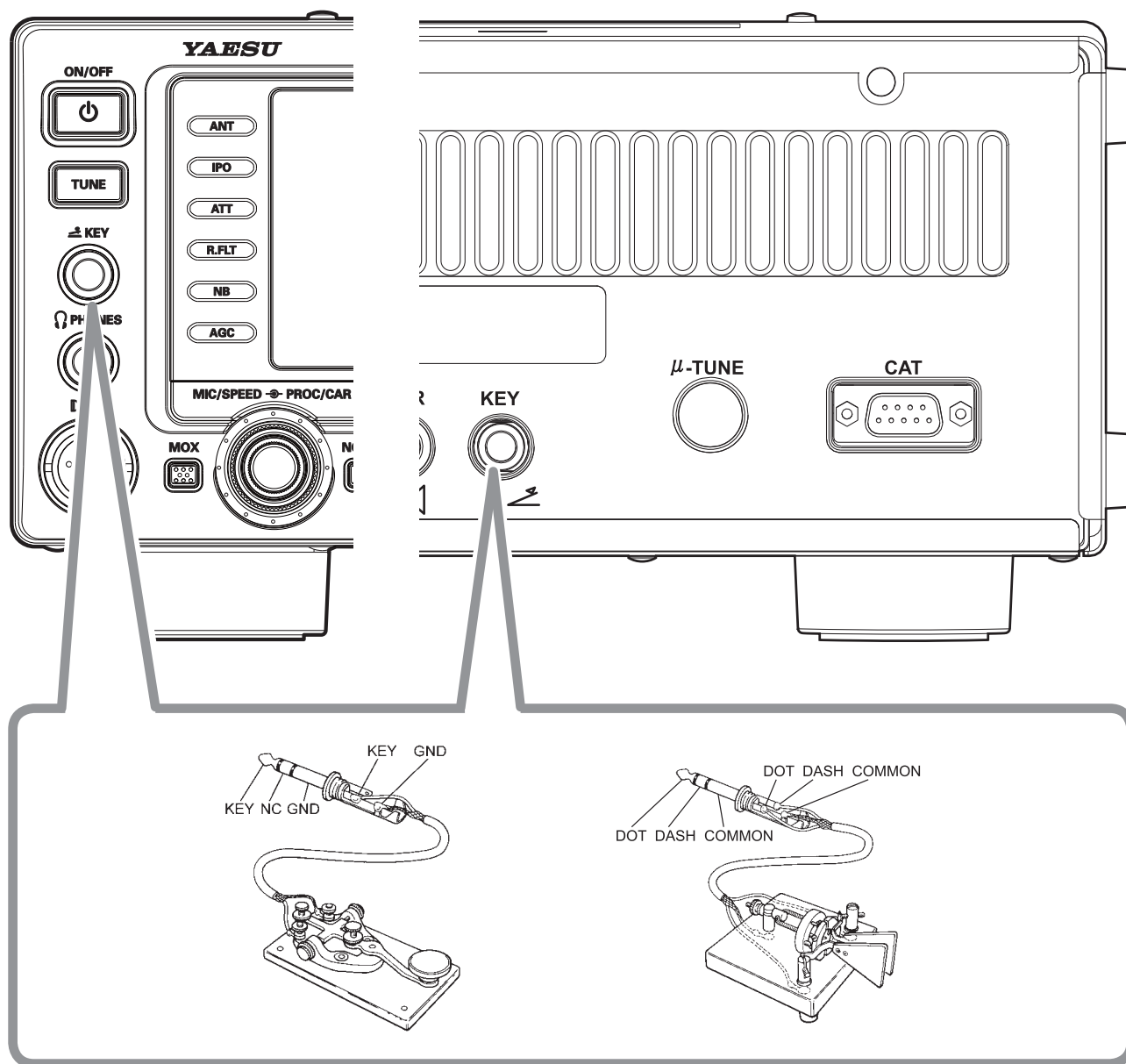

INSTALLATION AND INTERCONNECTIONS

VL-1000 LINEAR AMPLIFIER INTERCONNECTIONS

Be sure that both the FTdx1200 and VL-1000 are turned off, and then follow the installation recommendations contained in the illustration.

NOTE:

- ❑ Refer to the VL-1000 Operating Manual for details regarding amplifier operation.
- ❑ Do not attempt to connect or disconnect coaxial cables when your hands are wet.

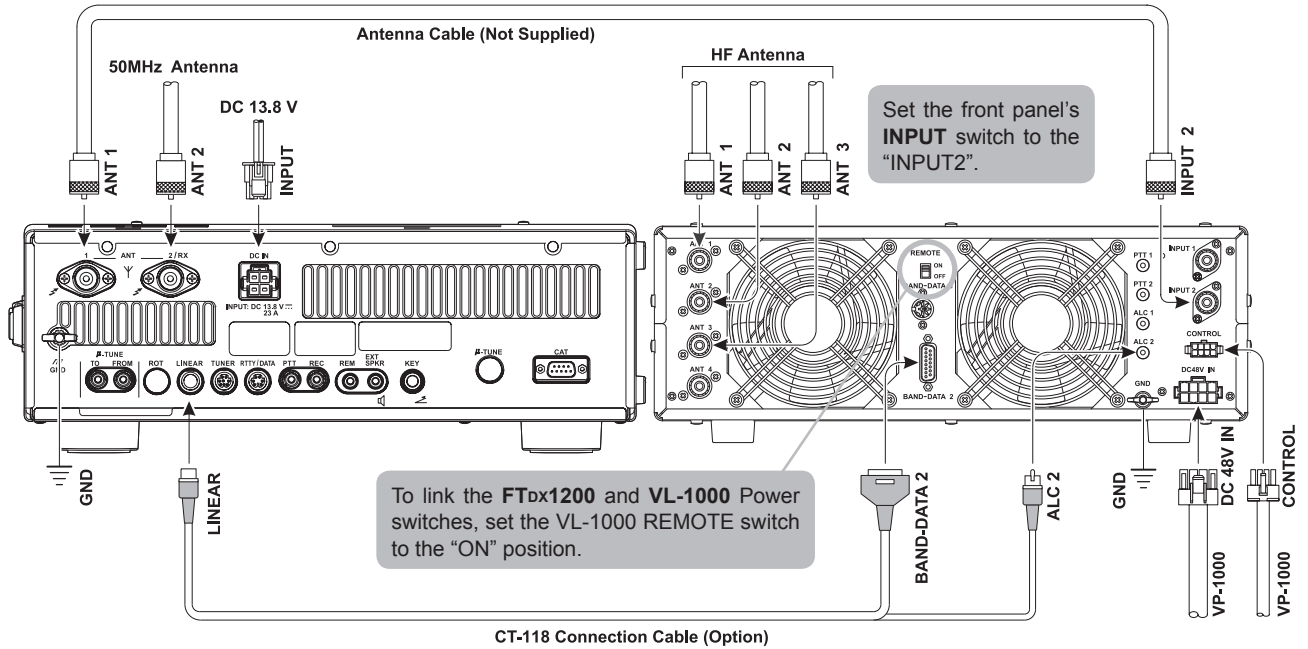

INSTALLATION AND INTERCONNECTIONS

INTERFACING TO OTHER LINEAR AMPLIFIERS

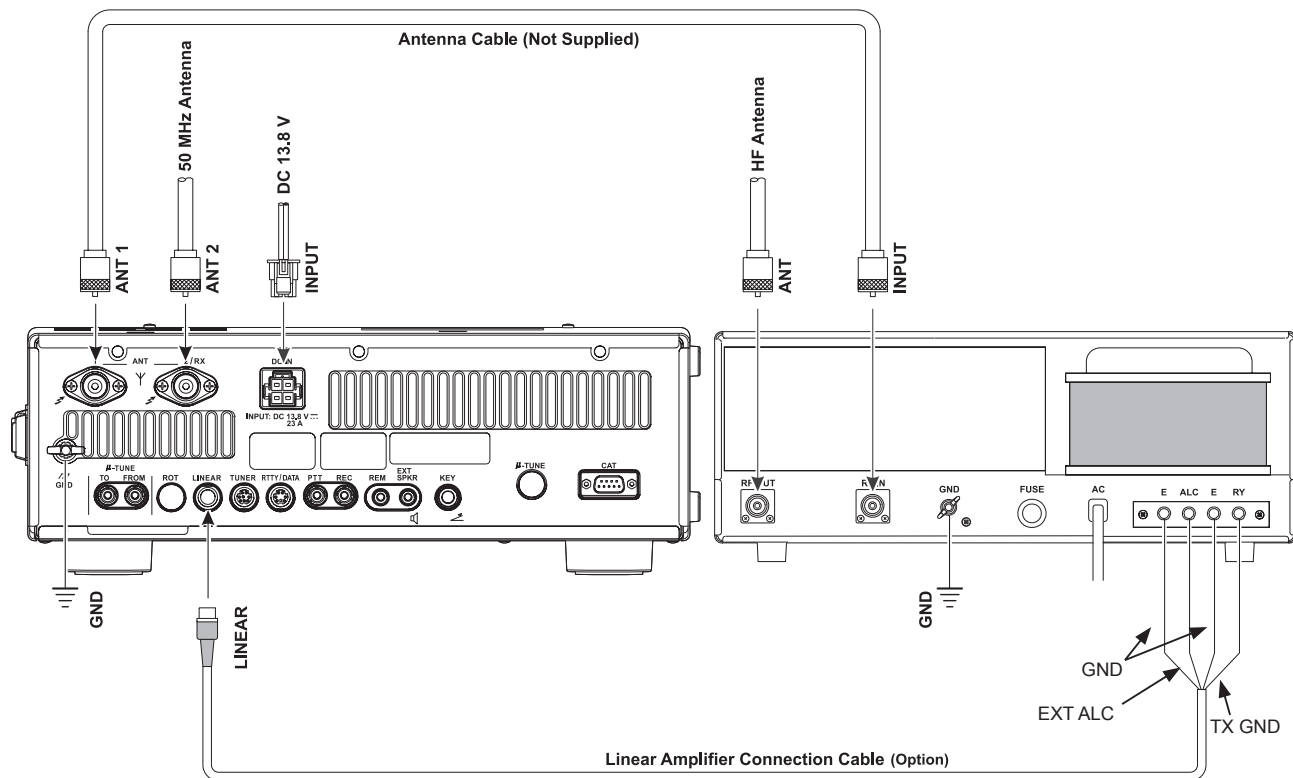

NOTE

- ❑ The TX GND OUT pin (pin 2) of the **LINEAR** jack is a transistor “open collector” circuit. It is capable of handling positive relay coil voltages up to +30 VDC at 500 mA. If you plan to use multiple linear amplifiers for different bands, you must provide external band switching of the “Linear Tx” relay control line from the “TX GND OUT” line at the **LINEAR** jack.
- ❑ The specified range for ALC voltage to be used with the **FTdx1200** is 0 to -4 Volts DC.
- ❑ Amplifier systems utilizing different ALC voltages will not work correctly with the **FTdx1200**, and their ALC lines must not be connected if this is the case.

IMPORTANT NOTE!



- ❑ Do not exceed the maximum voltage or current ratings for the “TX GND OUT” pin (pin 2) of the **LINEAR** jack. This line is not compatible with negative DC voltages, or AC voltages of any magnitude.
- ❑ Most amplifier control relay systems require only low DC voltage/current switching capability (typically, +12V DC at 25 ~ 75 mA), and the switching transistor in the **FTdx1200** will easily accommodate such amplifiers.

Note

When the **FC-40** is connected to the **FTdx1200**, TX GND (pin 2) of the **TUNER** jack and the **LINEAR** jack (pin 2) are common circuits.

Therefore, the maximum voltage at TX GND (pin 2) of the **LINEAR** jack must not exceed +5V.

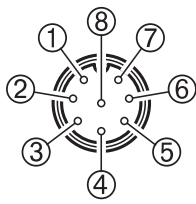
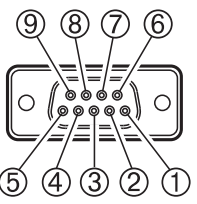
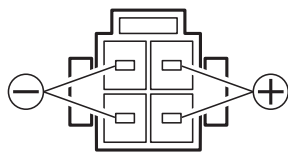
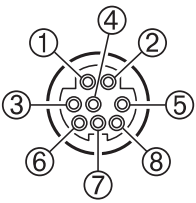
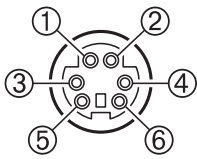
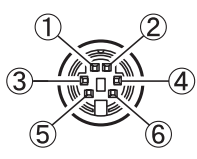
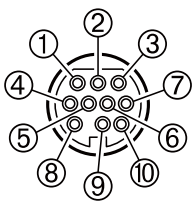
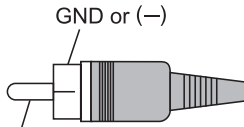
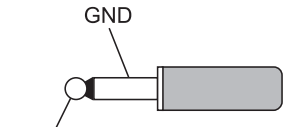
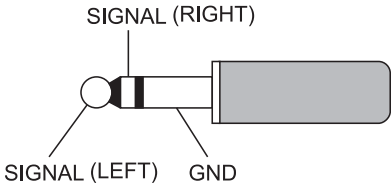
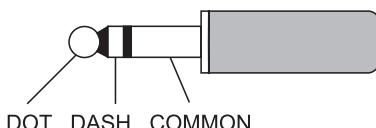
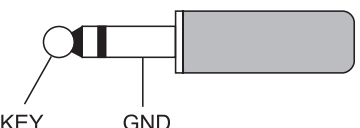
PLUG/CONNECTOR PINOUT DIAGRAMS

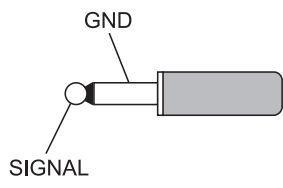
MIC	CAT	DC IN
 <ul style="list-style-type: none"> ① UP ② +5V ③ DOWN ④ FAST ⑤ GND ⑥ PTT ⑦ MIC GND ⑧ MIC <p>(as viewed from front panel)</p>	 <ul style="list-style-type: none"> ① N/A ② SERIAL OUT ③ SERIAL IN ④ N/A ⑤ GND ⑥ N/A ⑦ RTS ⑧ CTS ⑨ NC <p>(as viewed from rear panel)</p>	 <p>(as viewed from rear panel)</p>
TUNER	RTTY/DATA	ROT (ROTATOR)
 <ul style="list-style-type: none"> ① +13V OUT ② TX GND ③ GND ④ RX D ⑤ TX D ⑥ TUNER SENSE ⑦ RESET OUT ⑧ TX INH <p>(as viewed from rear panel)</p>	 <ul style="list-style-type: none"> ① DATA IN ② GND ③ DATA PTT ④ FSK IN ⑤ DATA OUT ⑥ SQL OUT <p>(as viewed from rear panel)</p>	 <ul style="list-style-type: none"> ① CW ROTATION ② CCW ROTATION ③ SPEED ④ DIRECTION ⑤ GND ⑥ NC <p>(as viewed from rear panel)</p>
LINEAR	RCA PLUG	REM (REMOTE)
 <ul style="list-style-type: none"> ① +13V OUT ② TX GND ③ GND ④ BAND DATA A ⑤ BAND DATA B ⑥ BAND DATA C ⑦ BAND DATA D ⑧ TX INH ⑨ EXT ALC IN ⑩ TX REQ IN <p>(as viewed from rear panel)</p>	 <p>GND or (-) SIGNAL or (+)</p>	 <p>GND SIGNAL</p>
PHONE	KEY	
 <p>SIGNAL (RIGHT) SIGNAL (LEFT) GND</p>	<p><i>For Internal Keyer</i></p>  <p>DOT DASH COMMON</p>	<p><i>For Straight Key</i></p>  <p>KEY GND</p> <p> Do not use 2-conductor type plug</p>
EXT SPKR		
 <p>GND SIGNAL</p>		

FRONT PANEL CONTROLS & SWITCHES

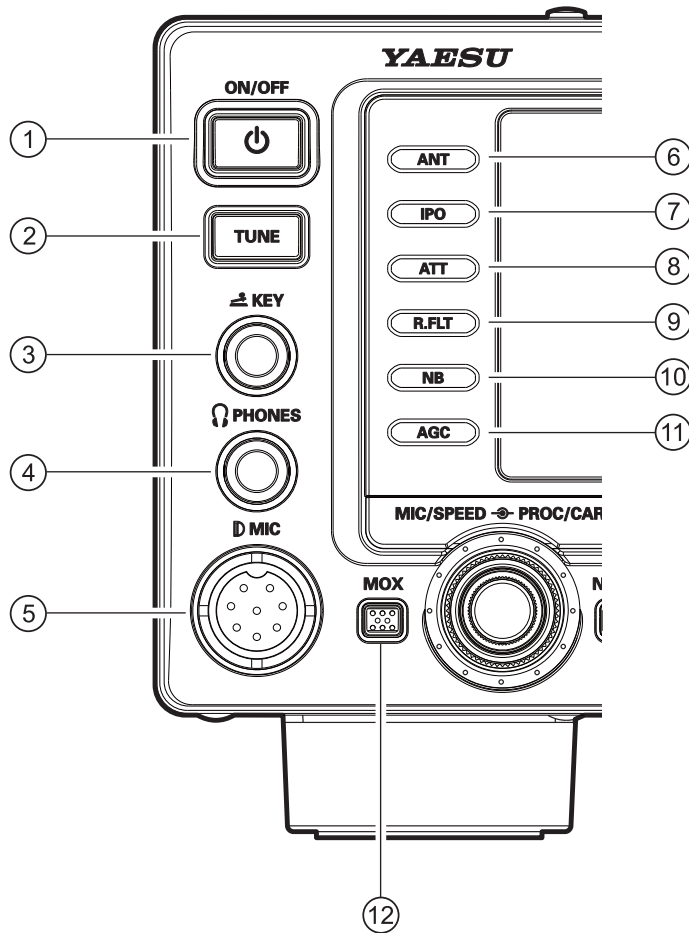

① [POWER] Switch

Press and hold in this switch for one second to turn the transceiver on. Similarly, press and hold in this switch for one second to turn the transceiver off.

② [TUNE] Switch

This is the on/off switch for the FT-DX1200's Automatic Antenna Tuner.

Pressing this button momentarily places the antenna tuner in line between the transmitter final amplifier and the antenna jack (The "TUNER" icon will appear in the display). Reception is not affected.

Pressing and holding in this button for two seconds, while receiving in an amateur band, activates the transmitter for a few seconds while the automatic antenna tuner rematches the antenna system impedance for minimum SWR. The resulting setting is automatically stored in one of the antenna tuner's 100 memories for instant automatic recall later when the receiver is tuned near the same frequency.

Pressing this button momentarily, while the Tuner is engaged, will take the Automatic Antenna tuner out of the transmit line.

NOTE:

When the Automatic Antenna Tuner is tuning itself, a signal is being transmitted. Therefore, be certain that an antenna or dummy load is connected to the selected antenna jack before pressing and holding in the [TUNE] switch to start antenna tuning.

③ KEY Jack

This 1/4-inch, 3-contact jack accepts a CW key or keyer paddles (for the built-in electronic keyer), or output from an external electronic keyer. Pinout is shown on page 15. Key up voltage is +3.3 V DC, and key down current is 4 mA. This jack may be configured for keyer, "Bug", "straight key", or computer keying interface operation via Menu item "019 F CW KEYS" (see page 113). There is another jack with the same name on the rear panel, and it may be configured independently for Internal Keyer or pseudo-straight-key operation.

NOTE:

You cannot use a 2-contact plug in this jack (to do so produces a constant "key down" condition).

FRONT PANEL CONTROLS & SWITCHES

④ PHONES Jack

A 1/4-inch, 3-contact jack accepts either monaural or stereo headphones with 2- or 3-contact plugs. When a plug is inserted, the loudspeaker is disabled.

NOTE:

When wearing headphones, we recommend that you turn the AF Gain levels down to their lowest settings before turning power on, to minimize the impact on your hearing caused by audio “pops” during switch-on.

⑤ MIC Jack

This 8-pin jack accepts input from a microphone utilizing a traditional YAESU HF transceiver pinout.

⑥ [ANT] Switch

Pressing this switch selects the **ANT 1** or the **ANT 2** connector on the rear panel, and allows convenient antenna switching at the press of a button. The selected antenna jack is indicated on the Key Function Display shown in the TFT Display.

ADVICE:

The ANT2 jack may be enabled to use as a receive only antenna, using the Menu item “033 ANT2 SETTING”. See page 114.

⑦ [IPO] (INTERCEPT POINT OPTIMIZATION) Switch

This button may be used to set the optimum front end characteristics of the receiver circuit for a very strong signal environment. Available selections are AMP 1 (low distortion amplifier), AMP 2 (2-stage low-distortion RF amplifier), or IPO (bypasses the front end RF amplifier). The selected receiver RF amplifier appears in the IPO column of the Key Function Display on the display.

⑧ [ATT] Switch

This button selects the degree of attenuation, if any, to be applied to the receiver input.

Available selections are -6 dB, -12 dB, -18 dB, or OFF. The attenuation level appears in the ATT column of the Key Function Display on the display.

ADVICE:

The Attenuator may be used in conjunction with the [IPO] button to provide additional signal reduction when an extremely strong signal is being received.

⑨ [R.FLT] (ROOFING FILTER) Switch

This button selects the bandwidth of the receiver first IF Roofing Filter. Available selections are 3 kHz, 6 kHz, 15 kHz, or Auto.

The selected bandwidth appears in the R.FLT column of the Key Function Display on the TFT display.

ADVICE:

The “AUTO” selection mode selects the optimum bandwidth of the Roofing filter for the reception mode. In this case, the selected bandwidth in the R.FLT column of the Key Function Display glows green (The unselected choices glow Blue).

Because the roofing filter is in the first IF, the protection it provides against interference is quite significant. When set to AUTO, the SSB bandwidth is 6 kHz, CW, RTTY and DATA, the bandwidth is 3 kHz, while AM and FM is 15 kHz.

⑩ [NB] Switch

This button turns the IF Noise Blanker on and off.

Press this button momentarily to reduce short-duration pulse noise.

Available selections are ON, OFF, or NBW ON. The attenuation level appears in the NB column of the Key Function Display on the display.

⑪ [AGC] Switch

This button selects the AGC characteristics for the receiver. Available selections are FAST, MID, SLOW and OFF, or AUTO. The selected AGC characteristic appears in the AGC column of the Key Function Display on the TFT display.

Press the [AGC] button repeatedly to select the desired receiver-recovery time constant. Press and hold in the [AGC] button for one second to disable the AGC (for testing or weak-signal reception).

ADVICE:

The “AUTO” selection mode selects the characteristic of the AGC for the reception mode. The selected AGC characteristic will glow green in the AGC column of the Key Function Display, (unselected characteristics glow Blue).

The Attenuator may be used in conjunction with the [IPO] button to provide two stages of signal reduction when an extremely strong signal is being received.

If the AGC receiver-recovery time is set to “Off” by pressing and holding in the [AGC] button, the S-meter will no longer deflect. Additionally, you will likely encounter distortion on stronger signals, as the IF amplifiers and the following stages are probably being overloaded.

⑫ [MOX] Switch

Pressing this button engages the PTT (Push to Talk) circuit to activate the transmitter (the  icon in the LED indicators area illuminates and the “MOX” icon will appear in the TFT display). It must be turned off (the icons will disappear) for reception. This button replicates the action of the Push to Talk (PTT) switch on the microphone. When engaging the [MOX] button, or otherwise causing a transmission to be started, be certain you have either an antenna or 50-Ohm dummy load connected to the selected Antenna jack.

FRONT PANEL CONTROLS & SWITCHES

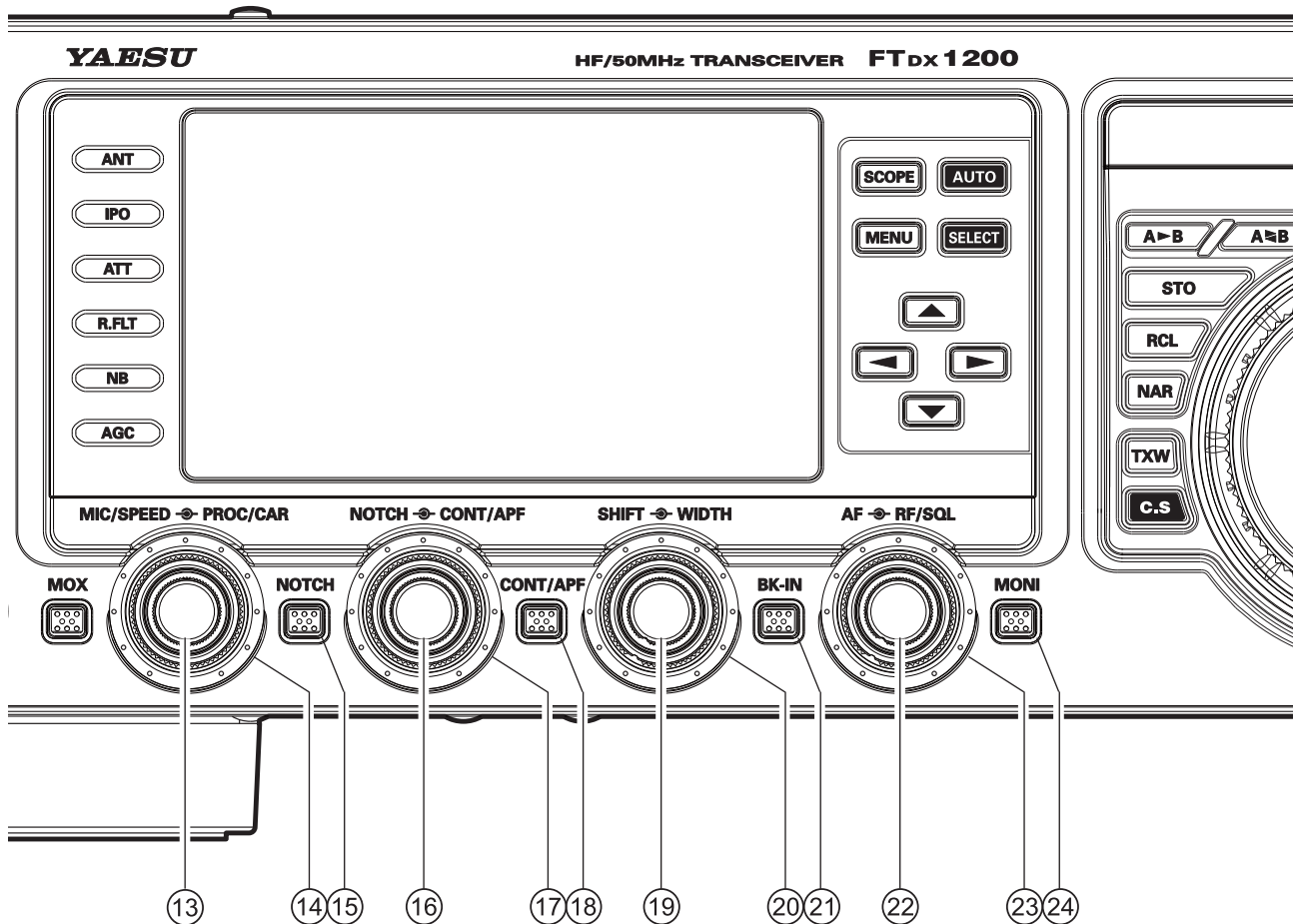

⑬ [MIC/SPEED] Knob

MIC

This knob adjusts the microphone input level for (non-processed) SSB transmission.

The display will show the relative microphone gain level for 3 seconds whenever this knob is turned.

ADVICE:

Adjust the [MIC/SPEED] knob while speaking in a somewhat louder than normal voice level, watch the ALC level and adjust the [MIC/SPEED] knob so that the ALC level indication just reaches the right edge of the ALC scale. Then, when you speak in your normal voice level, you will not be over-driving the microphone amplifier stages.

SPEED

This knob adjusts the keying speed of the internal CW keyer (4 ~ 60 WPM). Clockwise rotation increases the sending speed.

The display will show the keying speed for 3 seconds whenever this knob is turned.

⑭ [PROC/CAR] Knob

PROC

This knob adjusts the compression (input) level of the transmitter RF speech processor in the SSB mode.

CAR

This knob adjusts the RF Power (Carrier) output of the transceiver. For the SSB mode, set the desired maximum RF Power output via Menu item “177 TX MAX POWER” (see page 64).

IMPORTANT NOTE:

The setting value of Menu item “177 TX MAX POWER” is applied to all emission modes.

For example: When Menu item “177 TX MAX POWER” is set to “50”, the maximum RF Power output for all emission modes is “50”, even if the [PROC/CAR] knob is set to the fully clockwise position.

ADVICE:

The RF Power output setting will be shown for 3 seconds in the right of the TFT display whenever the outer [PROC/CAR] knob is turned, except when Menu item “177 TX MAX POWER” is set to 5 watts. In the SSB mode the [PROC] value will be shown instead of the RF Power output.

FRONT PANEL CONTROLS & SWITCHES

⑮ [NOTCH] Switch

Pressing this button allows you to adjust the center frequency of the IF Notch filter using the [NOTCH] knob. While activated, the “NOTCH” indicator in the DSP display illuminates. Press the [NOTCH] switch briefly to toggle the IF Notch filter on/off.

⑯ [NOTCH] Knob

Press the [NOTCH] switch to turn the IF NOTCH filter on or off. Rotate the inner [NOTCH] knob to adjust the center frequency of the IF NOTCH filter. The null position of the IF NOTCH filter can be observed on the display. Furthermore, the display will show the center frequency of the IF NOTCH filter for 3 seconds whenever the [NOTCH] knob is turned.

⑰ [CONT/APF] Knob

CONT

In the SSB, AM, and FM modes, press the [CONT/APF] switch then turn the outer [CONT/APF] knob to select the desired CONTOUR filter response. The CONTOUR filter is engaged via the [CONT/APF] switch.

APF

In the CW mode, press the [CONT/APF] switch and then turn the outer [CONT/APF] knob to select the desired APF (Audio Peak Filter) response. The APF is engaged via the [CONT/APF] switch.

⑱ [CONT/APF] Switch

Pressing this button allows you to select the DSP Contour filter response using the [CONT/APF] knob. While activated, the “CONTOUR” indicator in the DSP display illuminates. Press the [CONT/APF] knob briefly to toggle the IF Contour filter on/off.

In the CW mode, pressing this button will activate the APF (Audio Peak Filter) which provides a very narrow audio bandwidth. While activated, the “APF” indicator in the DSP display illuminates.

⑲ [SHIFT] Knob (EXCEPT ON AM AND FM MODE)

Rotate the inner [SHIFT] to move the passband of the IF DSP filter by 20 Hz steps. The total adjustment range is ± 1 kHz. The position of the passband can be observed on the display. Furthermore, the display will show the shift value of the IF SHIFT for 3 seconds whenever the [SHIFT] knob is turned.

⑳ [WIDTH] Knob (EXCEPT ON AM AND FM MODE)

Rotate the outer [WIDTH] knob to set the overall bandwidth of the IF DSP filter. Counter-clockwise rotation reduces the bandwidth, while clockwise rotation increases the bandwidth. The current bandwidth can be observed on the display. Furthermore, the TFT display will show the bandwidth of the IF passband for 3 seconds whenever the [WIDTH] knob is turned.

㉑ [BK-IN] Switch

This button turns the CW break-in capability on and off. While CW break-in is activated, the “BK-IN” icon appears in the TFT display.

㉒ [AF] Knob

The inner [AF] knob sets the receiver audio volume level. Typically, you will operate with this control set between the 9 o'clock and 10 o'clock positions.

㉓ [RF/SQL] Knob

ADVICE:

This control may be selected between the “SQL” and “RF GAIN” functions via the Menu Item “038 RF/SQL VR”.

RF

The outer [RF/SQL] knob is the receiver RF gain control, which adjusts the gain of the receiver RF and IF amplifier stages. This control is normally left in the fully clockwise position.

SQL

This knob sets the signal level threshold, below which the receiver audio is muted, in all modes. It is very useful during local rag-chews, to eliminate noise between incoming transmissions. This control is normally kept fully counter-clockwise (off), except when scanning and during FM operation.

㉔ [MONI] (Monitor) Switch

This button enables the transmit monitor in all modes. While activated, the “MONI” icon appears in the TFT display.

ADVICE:

When using headphones, the Monitor function is very helpful while adjusting the Parametric Equalizer or other voice quality adjustments. The voice heard in the headphones represents the transmitted audio qualities.

FRONT PANEL CONTROLS & SWITCHES

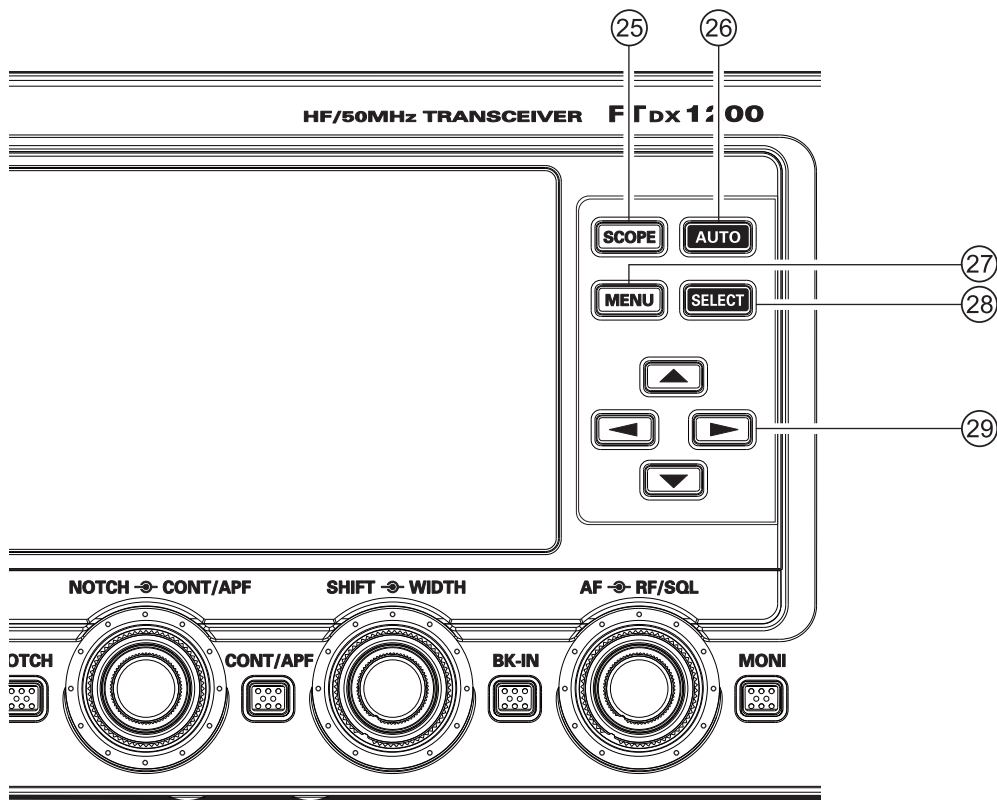

②⑤ [SCOPE] Switch

Press this button momentarily to switch between the Menu, the Scope, the Full TFT screen Scope, the Scope + AF-FFT (when the optional FFT unit is installed), and the Scope Memory (when there is memory) screens. When the optional FFT unit is installed, press and hold this button for more than one second to operate the decode function (when operating CW, RTTY, PSK).

②⑥ [AUTO] Switch

This button is used to select the scope mode (AUTO or MANUAL)

②⑦ [MENU] Switch

This button is used to access the Menu system. The various transceiver characteristics may be configured. Menu operation is described in detail, in this manual.

IMPORTANT NOTE:

Pressing the [MENU] button will activate the Menu, and the Menu items will appear on the display. Once you have changed the parameters, you must press the [MENU] button to save any configuration changes.

②⑧ [SELECT] Switch

This button is used to select the Menu system.

②⑨ [◀▶▶▶] Switch

These buttons permit selection of the Menu items and settings.

FRONT PANEL CONTROLS & SWITCHES

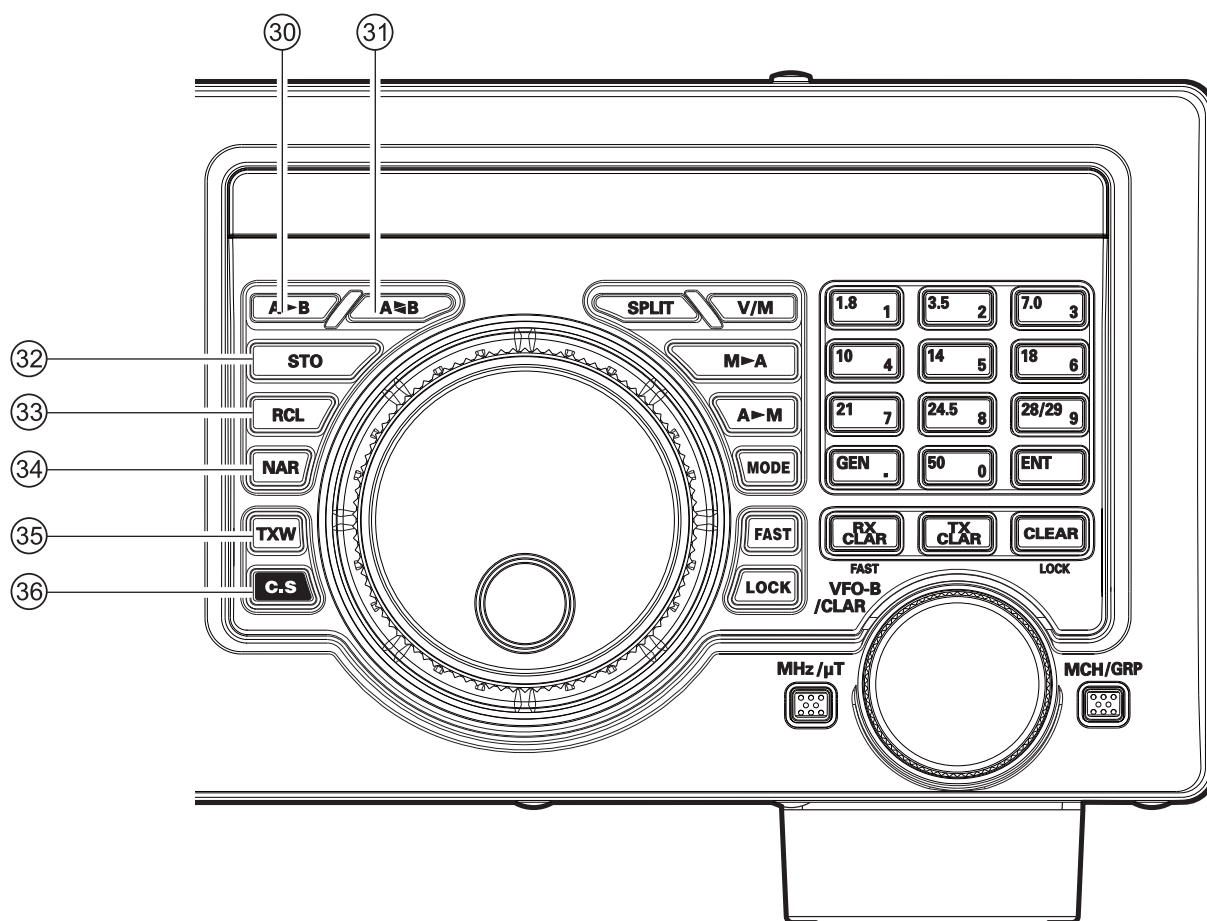

③① [A▶B] Switch

Press this button momentarily to transfer the frequency or memory channel data, from VFO-A to VFO-B, overwriting any previous contents in VFO-B. Use this key to set both VFO-A and VFO-B to the same frequency and mode.

③② [A◀B] Switch

Pressing this button momentarily, exchanges the frequency or memory channel data, of VFO-A and VFO-B.

③③ [STO] (Store) Button

Pressing the [STO] button copies the contents (frequency, mode, bandwidth, FM repeater offset, and CTCSS settings) of VFO-A, into consecutive QMB Memories.

③④ [RCL] (Recall) Button

Pressing the [RCL] button, recalls one of up to five Quick Memory Bank memories for operation.

③⑤ [NAR] (Narrow) Switch

This button is used to set the DSP (digital) IF filters to Narrow bandwidth.

ADVICE:

You may adjust the bandwidth using the [WIDTH] knob.

In the AM mode, this button is used to toggle the receiver bandwidth between wide (9 kHz) and narrow (6 kHz).

In the FM mode on the 28 MHz and 50 MHz bands, this button is used to toggle the FM deviation/bandwidth between wide (± 5.0 kHz Dev./25.0 kHz BW) and narrow (± 2.5 kHz Dev./12.5 kHz BW).

③⑥ [TXW] (TX Watch) Switch

Pressing and holding this button lets you monitor the transmit frequency when split frequency operation is engaged. Release the button to return to normal split frequency operation.

③⑦ [C.S] Switch

Press this button momentarily to directly recall a favorite Menu Selection.

To program a Menu selection to the [C.S] button, press the [MENU] button to enter the Menu. Select the Menu item you want to set as the short cut. Press the [C.S] button, then press the [MENU] button; this will lock in the selected Menu item as the short cut.

FRONT PANEL CONTROLS & SWITCHES

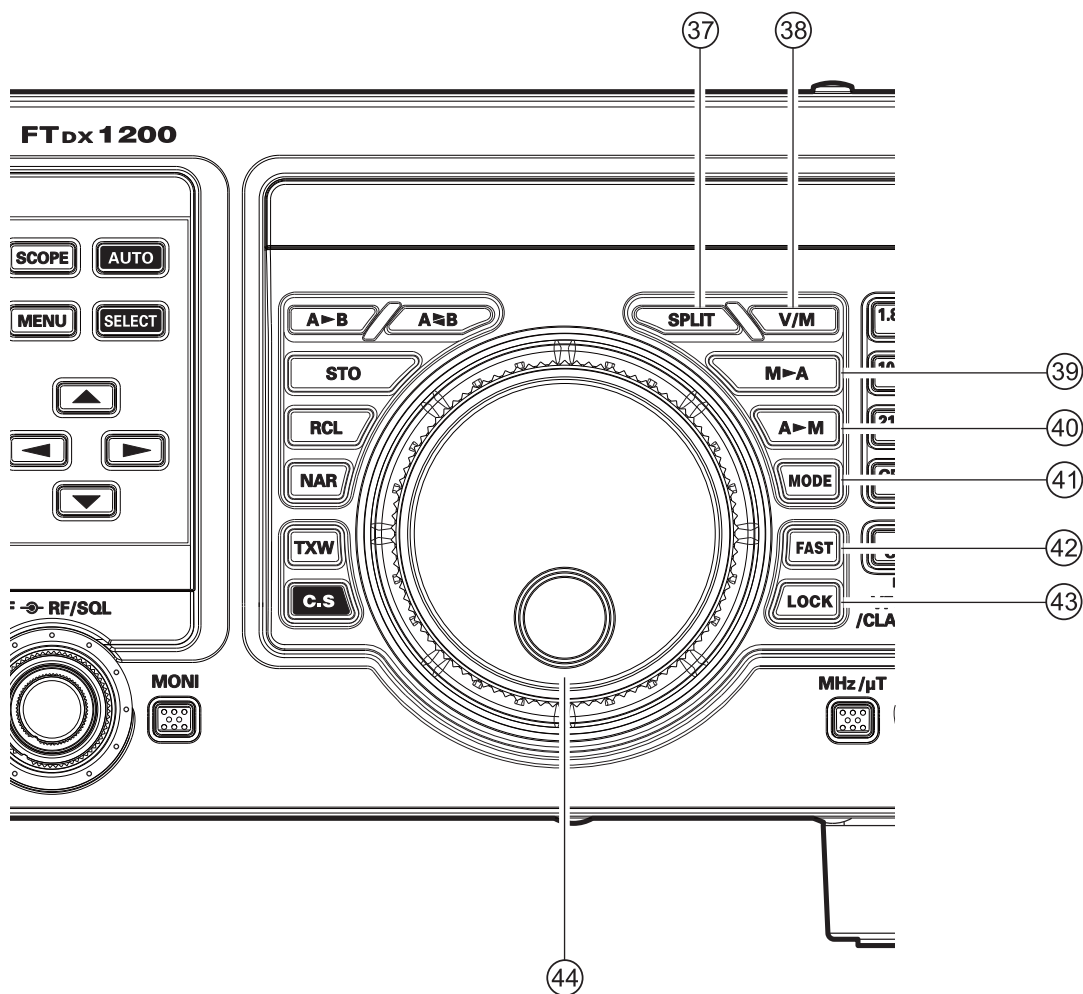

37 [SPLIT] Switch

Press this button to operate split frequency between VFO-A (used for reception) and VFO-B (used for transmission). If you press and hold in the [SPLIT] button for one second, the “Quick Split” feature will be engaged. VFO-B transmit will automatically be set to a frequency 5 kHz higher than the VFO-A receive frequency, with the same operating mode. The transceiver will operate in the Split mode.

38 [V/M] Switch

This button toggles frequency control between VFO-A and the memory system. In memory mode, “MEM” (Memory Channel) will be shown in the display to indicate the current selection. Pressing the [V/M] button displays the original memory frequency, and the “MEM” will be displayed. Pressing it once more returns frequency operation to VFO-A, and the icon will no longer be displayed.

39 [M▶A] Switch

Pressing this button momentarily, will display the contents of the currently-selected memory channel for 10 seconds.

Holding [M▶A] button in for one second copies the data from the selected memory to VFO-A, and two beeps sound. Previous data in VFO-A will be overwritten.

40 [A▶M] Switch

Pressing this button momentarily, displays the contents of the currently-selected memory channel for 10 seconds.

Pressing and holding in this key for one second (until the double beep) copies the current operating data into the currently selected memory channel, overwriting any previous data stored there.

FRONT PANEL CONTROLS & SWITCHES

④① [MODE] Switch

This button selects the operating mode. The selections available are:

LSB → CW (USB) → RTTY (LSB) →
→ DATA (LSB) → AM → LSB →

Repeated presses of this button steps through the available selections.

Pressing and holding this button will toggle to the alternate mode. In the AM mode, a long press will toggle between the AM and FM mode.

For example, *In the LSB or USB modes*, a long press of this button toggles between “LSB” and “USB” mode.

④② [FAST] Switch

Pressing this button will change the tuning of the Main Tuning Dial knob (VFO-A) to a higher step rate.

When this function is activated, the “**FAST**” indicator in the LED indicators area illuminates.

④③ [LOCK] Switch

This button toggles locking on/off for the Main Tuning Dial knob (VFO-A). With “Lock” on, the Main Tuning Dial knob can still be turned, but the frequency will not change, and the “**LOCK**” indicator in the LED indicators area illuminates.

④④ Main Tuning Dial Knob

This large knob adjusts the operating frequency of VFO-A. Clockwise rotation of this knob increases the frequency. Default tuning increments are 10 Hz (CW, SSB), 50 Hz (RTTY/DATA), 100 Hz (AM/FM). When the [FAST] button is pressed, the tuning steps increases. The available steps are:

OPERATING MODE	1 STEP	1 DIAL ROTATION
LSB/USB/CW	10 Hz (100 Hz)	10 kHz (100 kHz)
AM/FM	100 Hz (1 kHz)	100 kHz (1 MHz)
RTTY/DATA	5 Hz (100 Hz)	5 kHz (100 kHz)

Numbers in parentheses indicate steps when the [FAST] button is On.

ADVICE:

The tuning steps for the Main Tuning Dial knob are set, at the factory, to: 10 Hz (SSB, CW), 50 Hz (RTTY/DATA) and 100 Hz (AM/FM) per step. Via Menu item “151 CW DIAL STEP” to “155 SSB DIAL STEP”, however, you may change these settings to 1 or 5 Hz (SSB, CW), 1 or 10 Hz (RTTY, DATA), and 10 Hz (AM, FM) instead.

FRONT PANEL CONTROLS & SWITCHES

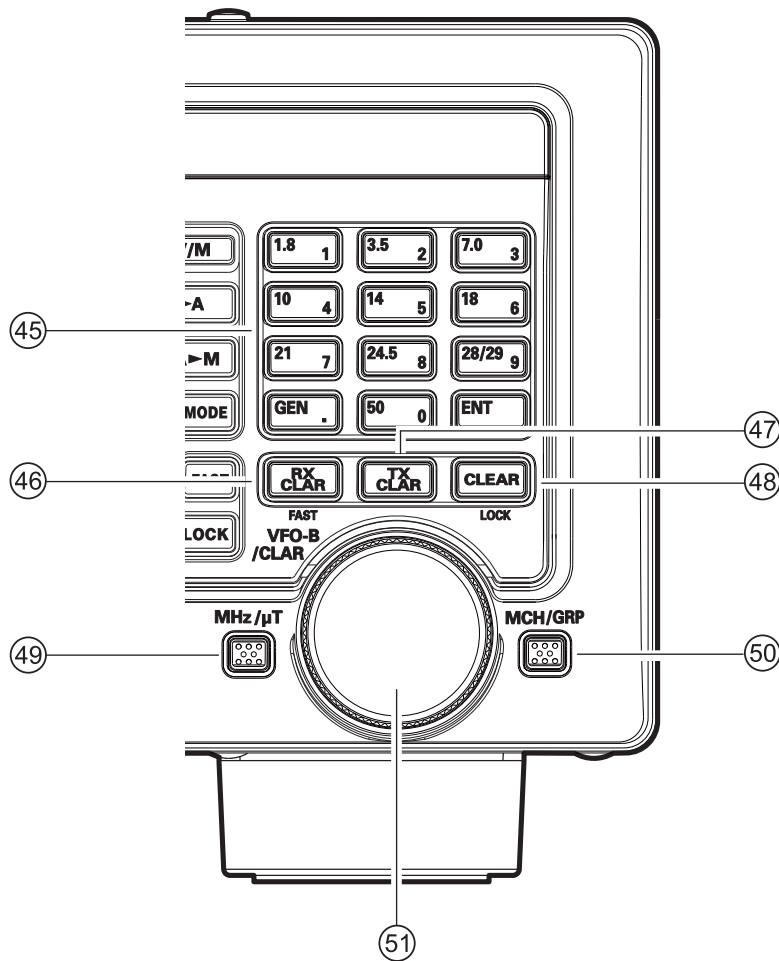

④⑤ [BAND] Keys

These keys allow one-touch selection of the desired Amateur band (1.8 ~ 50 MHz).

The keys may also be used for direct entry of a desired operating frequency during VFO operation.

④⑥ [RX CLAR] Switch

Pressing this button activates the RX Clarifier. This will allow you to temporarily adjust the receive frequency up to ± 9.999 kHz with the [VFO-B/CLAR] knob. Press this button once more to return the receiver to the original frequency; the Clarifier offset will be remembered, in case you want to use it again. To cancel the Clarifier offset, press the [CLEAR] button.

Pressing this switch during Split operation will change the tuning rate of the [VFO-B/CLAR] knob (VFO-B) to 100 Hz/step.

When this function is activated, the “FAST” indicator in the LED indicators area illuminates.

④⑦ [TX CLAR] Switch

Pressing this button activates the TX Clarifier, to allow offsetting the transmit frequency temporarily. Press this button once more to return the transmitter to the original frequency; the Clarifier offset will be remembered, though, in case you want to use it again. To cancel the Clarifier offset, press the [CLEAR] button.

④⑧ [CLEAR] Switch

Pressing this button clears out any frequency offset you have programmed into the Clarifier register (thereby setting the offset to “Zero”).

Pressing this switch during Split operation toggles locking on/off for the [VFO-B/CLAR] knob (VFO-B). With “Lock” on, the [VFO-B/CLAR] knob can still be turned, but the frequency will not change, and the “LOCK” indicator in the LED indicators area illuminates.

FRONT PANEL CONTROLS & SWITCHES

④⑨ [MHz/μT] Switch

Pressing this button allows you to tune the VFO frequency down or up in 1 MHz increments, using the [VFO-B/CLAR] knob.

Pressing and holding this switch for one second allows you to adjust the center frequency of the RF μ-Tuning filter passband using the [VFO-B/CLAR] knob, when the optional RF μ-Tuning Kit is connected. While activated, “μ-Tune” appears in the display. Press and hold in the [MHz/μT] switch for one second to toggle the μ-Tuning function on/off.

When μ-Tuning Kit is not connected, press and hold the [MHz/μT] switch for one second (“RX IN” appear in the display), you can receive by connecting the RX antenna to the “μ-Tune FROM” jack on the rear panel.

⑤⑩ [MCH/GRP] Switch

MCH

Pressing this button allows you to select a memory channel using the [VFO-B/CLAR] knob.

GRP

Pressing this button allows you to select a memory group by turning the [VFO-B/CLAR] knob.

⑤① [VFO-B/CLAR] Knob

During the VFO-A operation, this knob tunes the Clarifier offset frequency up to ±9.999 kHz.

During Split operation, this knob adjusts the operating frequency of VFO-B.

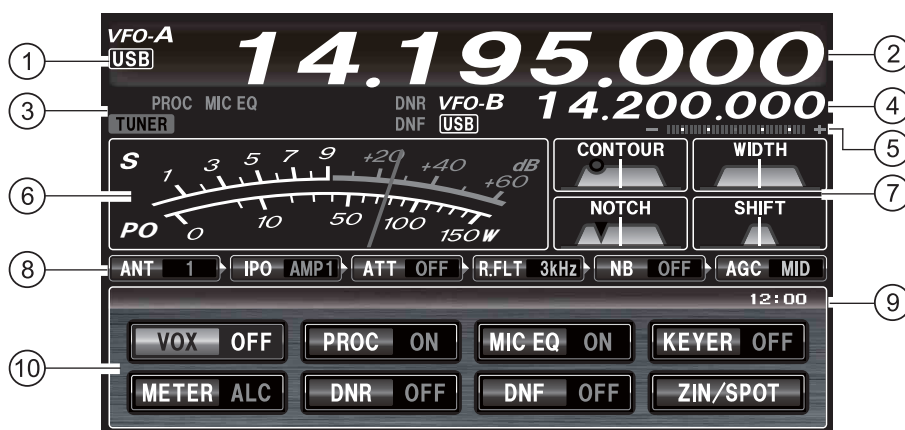
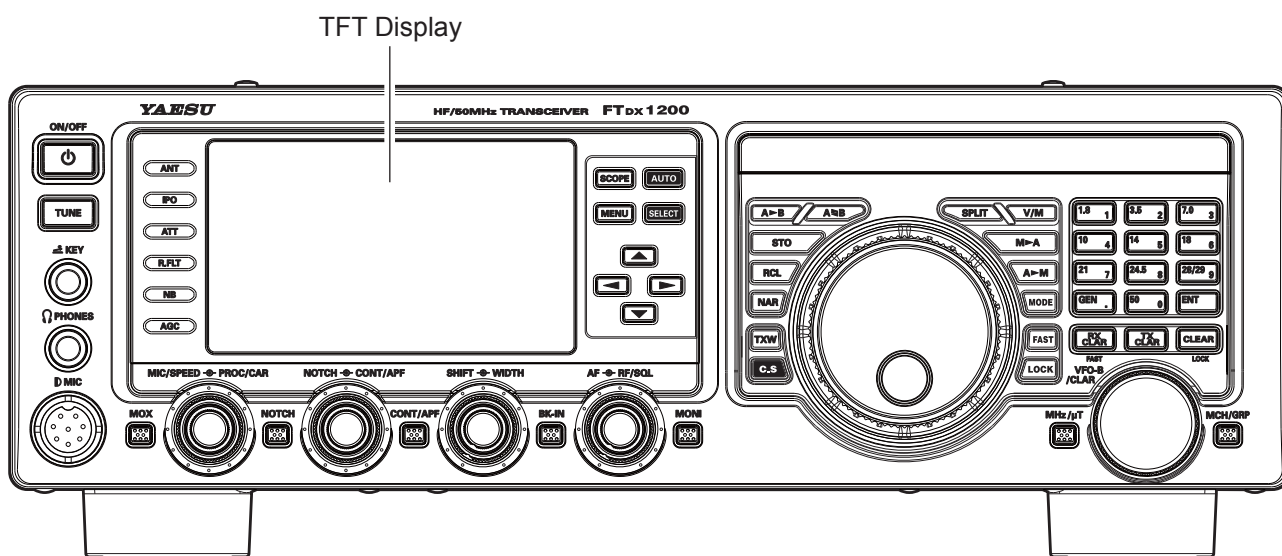

① Mode Indicator

Displays the current operating mode.

Press and hold the [MODE] button in the individual operating modes for approximately one second to switch between modes as follows:

- LSB ⇔ USB
- CW (LSB) ⇔ CW (USB)
- RTTY (LSB) ⇔ RTTY (USB)
- DATA (LSB) ⇔ DATA (USB)
- AM ⇔ FM

② VFO-A Frequency Display

Shows the main band (VFO-A) frequency.

③ Configuration Indicator

TUNER

This indicator appears when the internal Automatic Antenna Tuner is activated.

VOX

This indicator appears when the automatic voice-actuated transmitter switches in the SSB, AM, and FM modes.

PROC

This indicator appears whenever the DSP Speech Processor is activated.

MIC EQ

This indicator appears whenever the Three-Band Parametric Microphone Equalizer is activated via the Menu.

NAR

This indicator appears whenever the receiver's narrow IF DSP filter is engaged.

REC

This indicator appears while the optional Voice Memory Unit is recording your voice message, or the Contest Keyer is recording your CW keying.

PLAY

This indicator appears while the optional Voice Memory Unit is playing back the recorded voice message, or the recorded Contest CW keying.

[+]/[-]

During FM repeater operation, a negative frequency shift will be indicated by “[-]” while a positive frequency shift will be indicated by “[+]”.

DNR

This indicator appears whenever the Digital Noise Reduction feature is activated.

DNF

This indicator appears whenever the Digital Notch Filter is activated.

④ VFO-B Frequency Display

Shows the sub band (VFO-B) frequency during Split operation.

ADVICE:

- When turning the [CLAR], [MIC/SPEED], [PROC/CAR], [NOTCH], [CONT/APF], [SHIFT], or [WIDTH] knob, each frequency or value will appear in this area for 3 seconds.

⑤ Tuning Offset Indicator

This indicates the relative offset of the CW-TUNE, μ -TUNE, Clarifier, etc.

⑥ S/PO Meter

On reception, this indicates the received signal strength from S-0 to S-9+60dB.

On transmission, this indicates the RF Power Output, from 0 to 150 Watts.

ADVICE:

- The S/PO meter types can be changed to ANALOG or BAR type via the menu item “012 METER TYPE SELECT”.
- The S/PO meters can be set to the Peak-hold function (BAR type only) via the menu item “013 BAR MTR PEAK HOLD”.

⑦ DSP Display

This indicator is used for viewing the status of the DSP (CONTOUR, NOTCH, WIDTH and SHIFT).

⑧ Key Function Display

ANT (1, 2):

Indicates which antenna is selected by the front panel [ANT] button.

IPO (AMP1, AMP2, IPO):

Indicates which front end RF amplifier is selected by the front panel [IPO] button.

ATT (OFF, -6 dB, -12 dB, -18 dB):

Indicates the attenuation level, selected by the front panel [ATT] button.

R.FLT (3 kHz, 6 kHz, 15 kHz):

Indicates the receiver IF Roofing Filter that is selected by the front panel [R.FLT] button.

NB (OFF, ON, ON [NBW]):

Indicates the receiver's “short-duration” Noise Blanker setting, which is selected by the front panel [NB] button.

AGC (SLOW, FAST, MID):

Indicates the AGC decay time setting, which is selected by the front panel [AGC] switch.

⑨ Clock

Indicates the current time.

To set the clock:

1. Press and hold the **[C.S]** button until the clock digits blink.
2. Enter the present time via the number keys (**[BAND]** keys).
3. Press the **[ENT]** button.

⑩ Multi-Function Display

This area usually displays the status of major functions.

Press the **[▲/▼/◀/▶]** buttons to select an indicator for the desired function, then press the **[SELECT]** button to select either of the settings.

ADVICE:

- This area also shows the CW/RTTY/DATA texts, SCOPE level meters, memory channels, and menu items.

VOX:

This is the ON or OFF indicator for the automatic voice-actuated transmitter switching in the SSB, AM, and FM modes. The controls affecting VOX operation are the Menu items “181 VOX GAIN”, “182 VOX DELAY”, and “183 ANTI VOX GAIN”. By proper adjustment of these controls, hands-free voice-actuated operation is possible.

METER:

This indicator determines the function of the meter during transmission.

- PO: Indicates the RF Power Output, from 0 to 150 Watts on transmit.
- ALC: Indicates the relative ALC voltage.
- SWR: Indicates the Standing Wave Ratio (Forward/ Reflected).
- COMP: Indicates the speech compressor level (SSB mode only).
- ID: Indicates the final amplifier drain current.
- VDD: Indicates the final amplifier drain voltage.

PROC (Processor):

This indicator enables the Speech Processor for SSB transmission. Adjustment of the Processor level is accomplished via the **[PROC/CAR]** knob.

ADVICE:

- The Speech Processor is a tool for increasing the average power output through a compression technique. However, if the Processor level is advanced too far, the increase in compression becomes counter-productive, as intelligibility will suffer. We recommend that you monitor the sound of your signal using the Monitor (with headphones).

DNR:

This indicator turns the Main band (VFO-A) receiver's Digital Noise Reduction circuit on and off. Adjustment of the Noise Reduction level is accomplished via the Menu item “110 DNR LEVEL”.

MIC EQ:

This indicator enables the Three-Band-Parametric Microphone Equalizer. The Equalizer settings are activated via the Menu.

DNF:

This indicator turns the Main band (VFO-A) receiver's Digital Notch Filter on and off. This is an automatic circuit, and there is no adjustment knob for the DNF.

KEYER:

This indicator toggles the internal CW keyer on and off. The Keyer sending speed is adjusted via the front panel's **[MIC/SPEED]** knob and the CW Hang Time is adjusted via the Menu item “064 CW BK-IN DELAY”.

ZIN/SPOT:

This indicator enables the CW receiver spotting tone. By matching the SPOT tone to that of the incoming CW signal (precisely the same pitch), you will be “zero beating” your transmitted signal with the frequency of the other station.

DISPLAY INDICATIONS

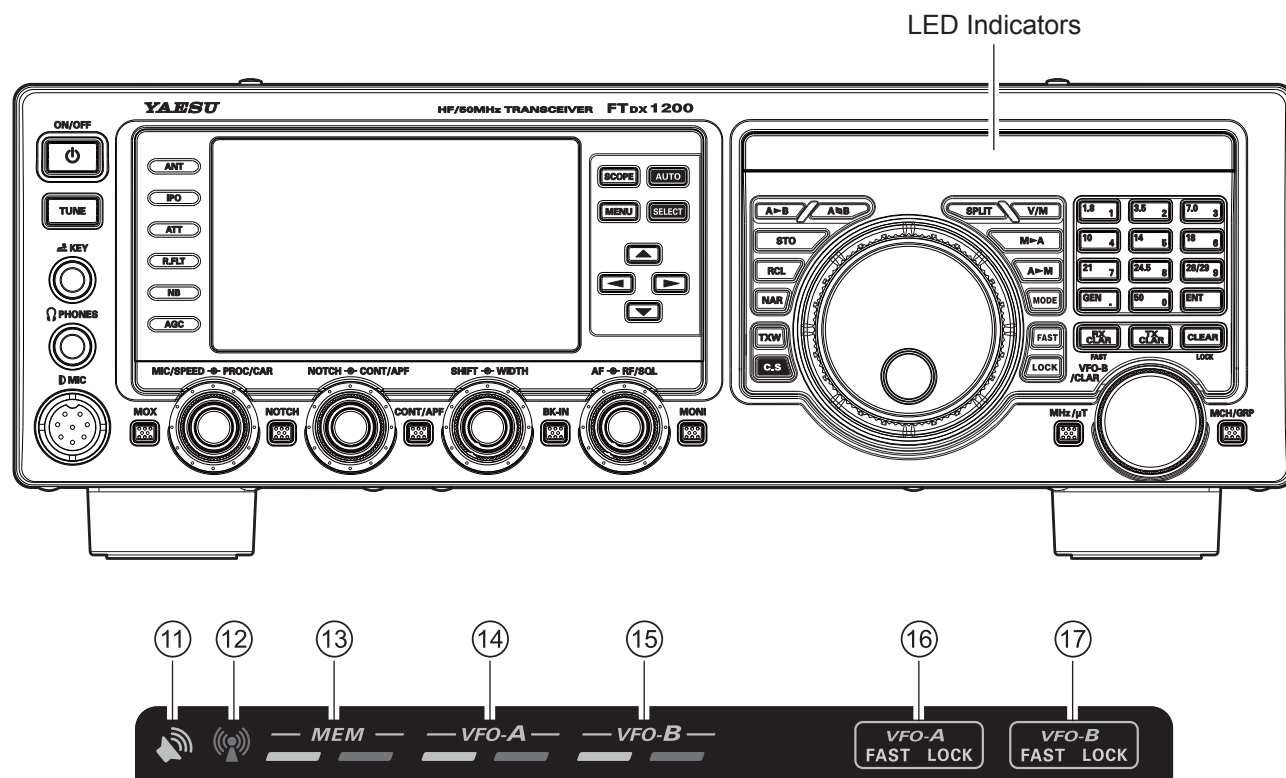

⑪ RX Indicator

This indicator illuminates when the squelch opens.

⑫ TX Indicator

This indicator illuminates during transmission.

⑬ Memory Mode RX/TX Indicators

Green (Left):

This indicator illuminates when the receiver is active on the memory channel.

Red (Right):

This indicator illuminates when the transmitter is active on the memory channel.

⑭ Main Band RX/TX Indicators

Green (Left):

This indicator illuminates when the receiver is active on the main band (VFO-A).

Red (Right):

This indicator illuminates when the transmitter is active on the main band (VFO-A).

⑮ Sub Band RX/TX Indicators

Green (Left):

This indicator illuminates when the receiver is active on the main band (VFO-B).

Red (Right):

This indicator illuminates when the transmitter is active on the main band (VFO-B).

⑯ Main Tuning Dial FAST/LOCK Indicators

FAST:

This indicator appears when the Main Tuning Dial knob tuning rate is set to “fast”.

LOCK:

This indicator appears when the Main Tuning Dial knob is locked.

⑰ [VFO-B/CLAR] Knob FAST/LOCK Indicators

FAST:

This indicator appears when the [VFO-B/CLAR] knob tuning rate is set to “fast”.

LOCK:

This indicator appears when the [VFO-B/CLAR] knob is locked.

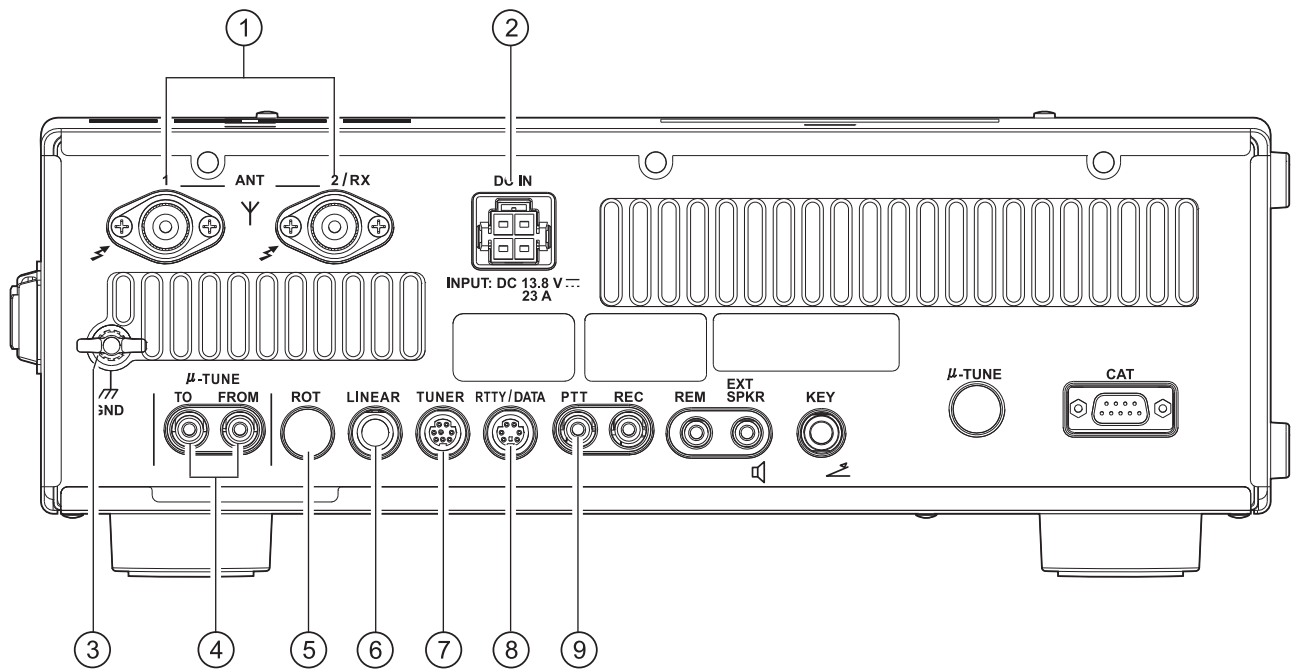

① ANT 1/2 Jacks

Connect your main antenna(s) here, using type-M (PL-259) connectors and coaxial feed lines. The internal antenna tuner affects only the antenna(s) connected here, and only during transmission.

⚠ Warning!

The 100V RF voltage (@100 W/50 Ω) is applied to the TX RF section of the transceiver while transmitting. Do not touch the TX RF section while transmitting.

② DC IN Jack

This is the DC power supply connection for the transceiver. Use the supplied DC cable to connect directly to a DC power supply, which must be capable of supplying at least 23 A @13.8 VDC.

③ GND

Use this terminal to connect the transceiver to a good earth ground, for safety and optimum performance. Use a large diameter, short braided cable for making ground connections, and please refer to page 9 for other notes about proper grounding.



To prevent damage from lightning, atmospheric electricity, electrical shock, etc., be certain to provide a good earth ground.

④ μ-TUNE Jacks

These jacks are used to connect the optional RF μTuning Kit, signal in and signal out.

⑤ ROT Jack

This covered 6-pin MINI-DIN Jack accepts a cable to connect to a YAESU **G-800DXA/-1000DXA/-2800DXA** Antenna Rotator (listed models are current as of early 2013). You may control the antenna azimuth rotation (and rotation speed) using the Function buttons on the front panel.

⑥ LINEAR Jack

This 10-pin output jack provides band selection data, which may be used for control of optional accessories such as the **VL-1000** Solid-state Linear Amplifier.

⑦ TUNER Jack

This 8-pin output jack is used for connection to the **FC-40** External Automatic Antenna Tuner.

⑧ RTTY/DATA Jack

This 6-pin input/output jack accepts AFSK input from a Terminal Node Controller (TNC) or an optional interface unit; it also provides fixed level (100-mV @600 Ohms) receiver audio output, and FSK keying line.

⑨ PTT Jack

This RCA input jack may be used to provide manual transmitter activation using a footswitch or other switching device. Its function is identical to the **[MOX]** button on the front panel. The same line is available at the **RTTY/PKT** jack for TNC control. Open-circuit voltage is +5 VDC, and closed-circuit current is 2 mA.

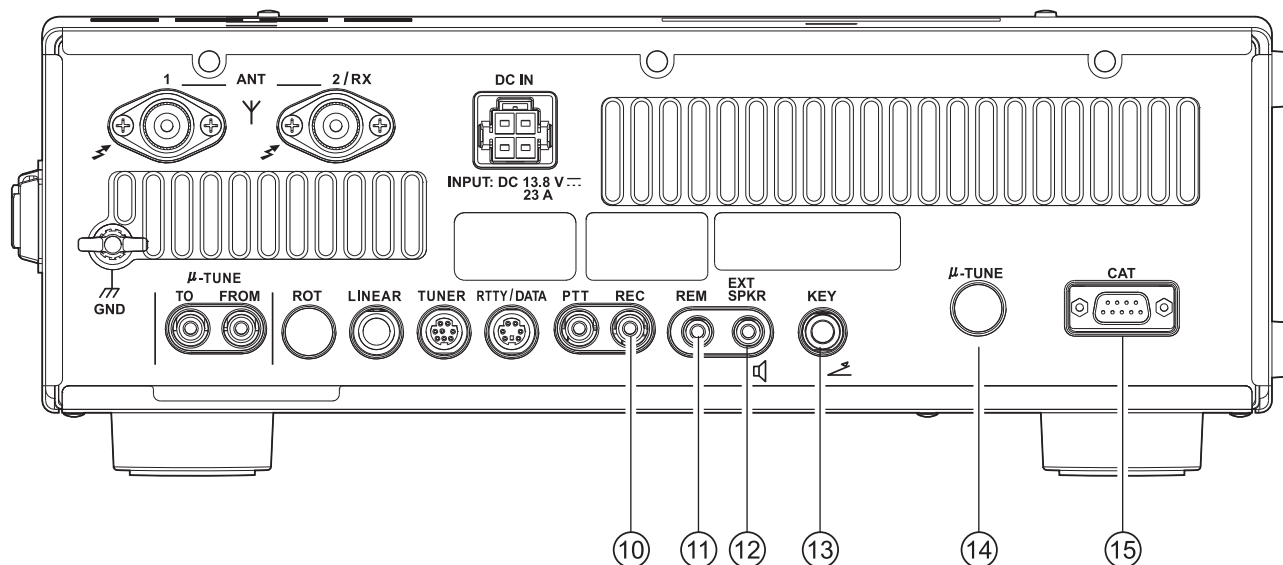

⑩ REC Jack

This 3.5-mm, 3-contact jack provides low-level receiver audio output for recording. It also outputs voice audio during transmission if the “MONI” is turned on.

Peak signal level is 300 mVp-p at 10 k-Ohms. The front panel [AF] knobs do not affect the signals at this jack.

⑪ REM (REMOTE) Jack

By plugging the optional **FH-2** Remote Control Keypad into this gold-plated jack, direct access to the **FTdx1200** CPU is provided for control functions such as contest memory keying, plus frequency and function control.

⑫ EXT SPKR Jack

This 3.5-mm, 2-contact, gold-plated jack provides variable audio output for an external loudspeaker. The audio output impedance at this jack is 4 - 8 Ohms, and the level varies according to the setting of the front panel [AF] knob. Inserting a plug into this jack disables the internal loudspeaker.

⑬ KEY Jack

This 1/4-inch 3-contact jack accepts a CW key or keyer paddle. A two-contact plug cannot be used in this jack. Key-up voltage is +3.3 V DC, and key-down current is 4 mA. This jack may be configured for keyer, “Bug”, “straight key”, or computer keying interface operation via Menu item “O20 R KEYER TYPE”.

⑭ μ-TUNE Jack

This covered 10-pin mini-DIN jack is used for control of the optional RF μTuning Kit.

⑮ CAT Jack

This 9-pin serial DB-9 jack allows external computer control of the **FTdx1200**. Connect a serial cable here and to the RS-232C COM port on your personal computer (no external interface is required).

OPTIONAL FH-2 SWITCHES

The optional Remote Control Keypad **FH-2** can be used to control the optional DVS-6 Voice Memory capability for the SSB/AM/FM modes; the contest memory keyer for the CW mode; and the text memory for the RTTY/DATA modes. Some specific capabilities of the **FH-2** are:

- On SSB/AM/FM modes, five channels of storage and playback of voice memory (20 seconds each), using your own voice for recording (see page 71).
- On CW mode, the **FH-2** provides storage and recall of CW messages for repetitive CQ and contest automatic number transmissions (see page 85).
- On RTTY/DATA mode, the **FH-2** provides storage and recall of TEXT messages for repetitive CQ transmissions (see pages 104, 106).

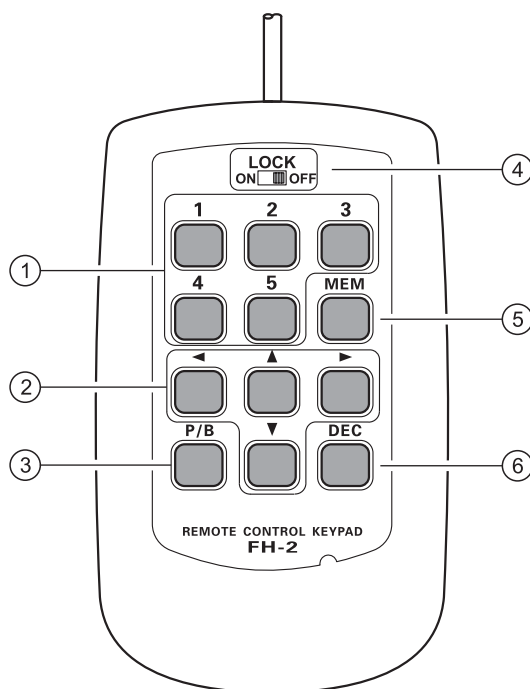

① [1], [2], [3], [4], [5] Switches

These buttons work as the Voice Memory and CW Message Memory Selection Key.

In the case of Voice Memory, up to 20 seconds of audio may be stored on each channel.

For CW Messages and CW Text Messages, up to 50 characters ("PARIS" specification) may be stored into each channel.

② [◀], [▶], [▲], [▼] Switches

Usually, these buttons are used for tuning the VFO frequency. Press the [▲]/[▼] buttons to change the frequency in the same increments as the microphone [UP]/[DWN] switches. Press the [◀]/[▶] buttons to change the frequency by 100 kHz steps.

When programming the Contest Memory Keyer, these buttons are used to move the cursor and select the text characters.

③ [P/B] Switch

This button can be used to insert a space into the position where the cursor is blinking.

④ [LOCK] Switch

This button may be used to lock out the **FH-2** key buttons, to prevent accidental activation of **FH-2** operations.

⑤ [MEM] Switch

Press this button to store either a Voice Memory, or a Contest Keyer Memory.

⑥ [DEC] Switch

When utilizing the sequential contest number capability of the Contest Keyer, press this button to decrement (decrease) the current Contest Number by one digit (i.e. to back up from #198 to #197, etc.).

BASIC OPERATION: RECEIVING ON AMATEUR BANDS

Before turning on the main power, please verify the following items once more.

- Have you made all ground connections securely? See page 9 for details.
- Do you have your antenna(s) connected to the rear-panel Antenna jack(s)? See page 10 for details.
- Is your microphone (and/or key or paddle) connected? See pages 11, 12 for details.
- If using a linear amplifier, have all interconnections been successfully completed? See pages 13, 14 for details.
- Please rotate the **[AF]** control to the fully counter-clockwise position, to avoid a loud blast of audio when the transceiver turns on. See page 19 for details.

BASIC OPERATION: RECEIVING ON AMATEUR BANDS

Here is the typical start-up procedure for normal operation:

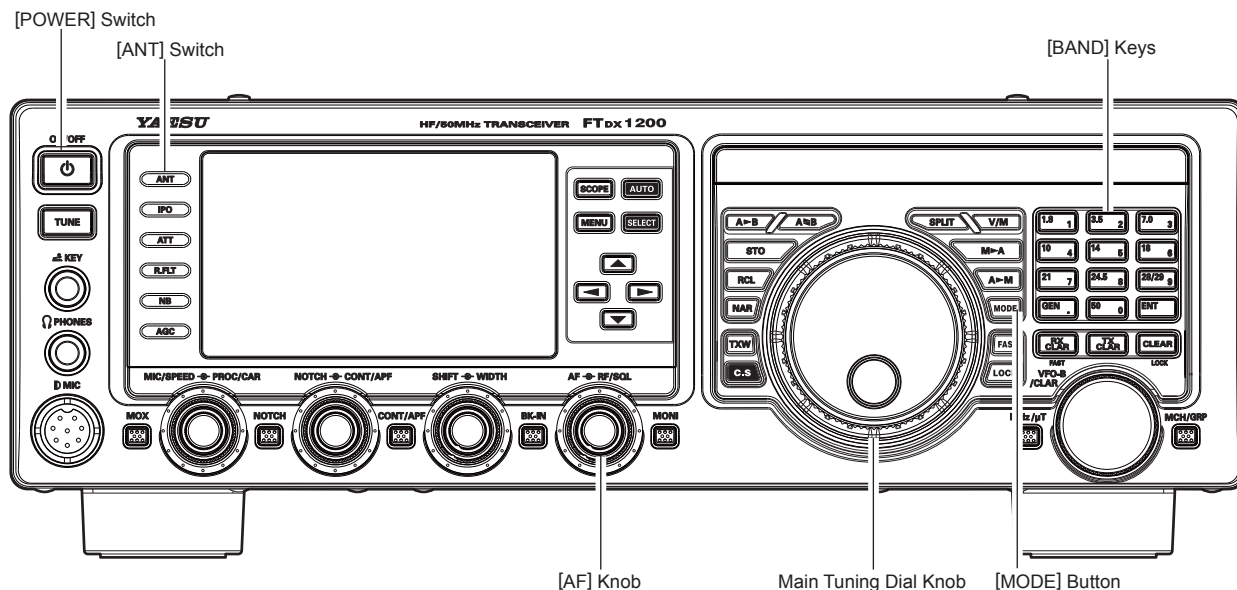

1. Turn on the external DC power supply.
2. Press and hold in the front-panel [ON/OFF] switch until the transceiver turns on. After about five seconds (ten seconds if the optional μ -Tuning Kit is connected), the transceiver is ready for full operation.
3. The transceiver will start up on 7.000.000 MHz LSB, (or the previously used operating frequency) and normal operation may begin.



NOTE:

To turn power off, press and hold in the front panel [ON/OFF] switch for one second.

4. Rotate the [AF] knob to set a comfortable audio level of the incoming signals or noise. Clockwise rotation of the [AF] knob increases the volume level.

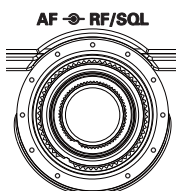

NOTE:

When using headphones, start by rotating the [AF] knob counter-clockwise, then bring the volume level up after you put the headphones on. This will minimize the chance of damage to your hearing caused by an unexpectedly high audio level.

5. Press an appropriate [BAND] key corresponding to the Amateur band on which you wish to begin operation.

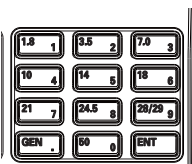

ADVICE:

- One-touch selection of each Amateur band between 1.8 and 50 MHz is provided.
- The FTdx1200 utilizes a triple band-stack VFO selection technique, which permits storing up to three favorite frequencies and modes onto each VFO band register. For example, you may store one frequency each on 14 MHz CW, RTTY, and USB, then recall these frequencies by successive,

momentary presses of the [14] MHz band button. Each Amateur band button may similarly have up to three frequency/mode settings applied.

- When the [MHz/ μ T] button (located to the left of the [VFO-B/CLAR] knob) is pressed, the "MHz" notation will appear in the display, and then rotation of the [VFO-B/CLAR] knob will change the frequency in 1 MHz steps.

6. Press the [ANT] button to select the appropriate antenna for the band in use.

ADVICE:

When you make an antenna selection, that antenna is "remembered" by the microprocessor in conjunction with the VFO register in use.



7. Press the [MODE] button to select the desired operating mode.

Repeated presses of the [MODE] button step through the available selections.

Pressing and holding the [MODE] button will toggle to the alternate mode.

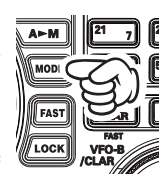

For example, *In the LSB or USB modes*, pressing and holding the [MODE] button toggles between "LSB" and "USB" mode.

ADVICE:

- By convention in the Amateur bands, LSB is used on the 7 MHz and lower bands (with the exception of 60 meters), while USB is utilized on the 14 MHz and higher bands.
- When changing modes from SSB to CW, you will observe a frequency shift on the display. This shift represents the BFO offset between the "zero beat" frequency and the audible CW pitch (tone) you can hear (the pitch is programmed via the Menu item "066 CW FREQ DISPLAY"), even

BASIC OPERATION: RECEIVING ON AMATEUR BANDS

though the actual tone that you hear is not changing.

- When operating on the FM mode, rotate the [RF/SQL] (Squelch) knob clockwise to the point where the background noise is just silenced. This is the point of maximum sensitivity to weak signals. Excessive advancement of the [RF/SQL] knob will decrease the ability of the receiver to detect weak signals.

You may switch the [RF/SQL] knob from the RF Gain Function to the Squelch Function via Menu item “038 RF/SQL VR”.

8. Rotate the Main Tuning Dial knob to tune around the band, and begin normal operation.

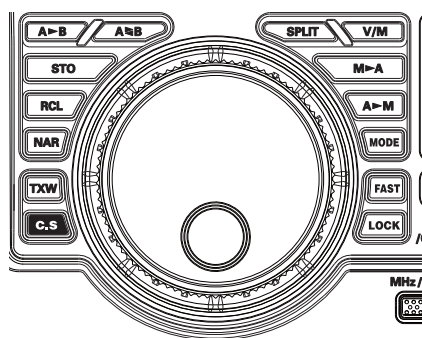

ADVICE:

- Clockwise rotation of the Main Tuning Dial knob increases the operating frequency, one “step” of the synthesizer at a time; similarly, counter-clockwise rotation of the Main Tuning Dial knob will decrease the frequency. Two settings, one “normal” and one “fast”, are available for each operating mode. Pressing the [FAST] button engages the “Fast” tuning selection (see chart below).

- The tuning steps for the Main Tuning Dial knob are set, at the factory, to 10 Hz (SSB, CW, RTTY, DATA) and 100 Hz (AM/FM) per step. Via Menu items “151 CW DIAL STEP” to “155 SSB DIAL STEP”, however, you may change these settings from 10 Hz to 1 or 5 Hz (SSB, CW, RTTY, DATA) and 100 Hz to 10 Hz (AM, FM) instead.

MAIN TUNING DIAL KNOB TUNING RATE

OPERATING MODE	1 STEP	1 DIAL ROTATION
LSB/USB/CW/RTTY/DATA	1 / 5 / 10 Hz (100 Hz)	1 / 5 / 10 kHz (100 kHz)
AM/FM	100 Hz (1 kHz)	100 kHz (1 MHz)

Numbers in parentheses indicate steps when the [FAST] button is On.

- If you want to effect rapid frequency change, there are several techniques available:
 - Direct keyboard entry of the frequency.
 - Use the [VFO-B/CLAR] knob to tune in 1 MHz steps.
 - Use the microphone’s [UP]/[DWN] scanning keys, if your microphone is so equipped.

BASIC OPERATION: RECEIVING ON AMATEUR BANDS

OPERATION ON 60-METER (5 MHz) BAND (U.S. AND U.K. VERSION ONLY)

The recently-released 60-meter band is covered, in the FTdx1200, by fixed memory channels. These channels are set to USB or CW, and they appear between the “last” PMS channel (“P9U”) and the first “regular” memory channel (Channel 1):

1. Press the [V/M] button once to enter the “Memory” mode; the “MEM” icon will appear in the display.
2. Press the [MCH/GRP] button located on the bottom right of the [VFO-B/CLAR] knob. The “MCH” notation and a memory channel number will appear in the display to signify that rotation of the [VFO-B/CLAR] knob will allow selection of the memory channel.
3. Memory channels (“5M-01” through “5M-10”) are pre-programmed, at the factory, with the permitted frequencies in the 5 MHz band, and the USB or CW mode is automatically selected on these channels.
4. To exit from 60-meter operation and return to the VFO mode, just press the [V/M] button.

NOTE:

The frequencies and operating mode for 5 MHz band operation are fixed, and may not be changed.

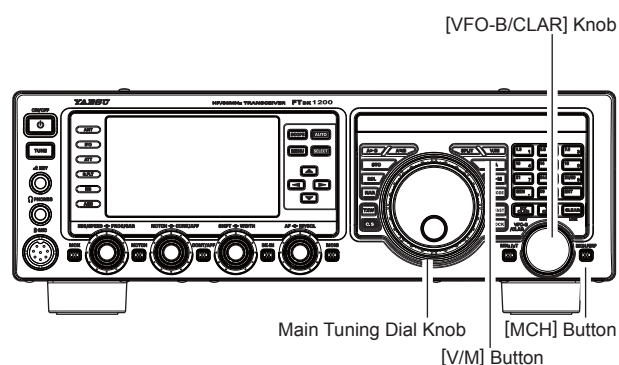

CHANNEL NUMBER	FREQUENCY	
	U.S. VERSION	U.K. VERSION
5M-01	5.332000 MHz	5.260000 MHz
5M-02	5.348000 MHz	5.280000 MHz
5M-03	5.358500 MHz	5.290000 MHz
5M-04	5.373000 MHz	5.368000 MHz
5M-05	5.405000 MHz	5.373000 MHz
5M-06	5.332000 MHz	5.400000 MHz
5M-07	5.348000 MHz	5.405000 MHz
5M-08	5.358500 MHz	-
5M-09	5.373000 MHz	-
5M-10	5.405000 MHz	-

CLAR (CLARIFIER) OPERATION

The [RX CLAR], [TX CLAR], [CLEAR] buttons and [VFO-B/CLAR] knob are used to offset the receive frequency, the transmit frequency, or both, from their settings on the VFO-A frequency. Four small numbers on the TFT Display show the current Clarifier offset. The Clarifier controls on the FTdx1200 are designed to allow you to preset an offset (up to ± 9.99 kHz) without actually retuning, and then to activate it via the Clarifier [RX CLAR] and [TX CLAR] buttons. This feature is ideal for following a drifting station, or for setting the small frequency offsets sometimes utilized in DX “Split” work.

Here is the technique for utilizing the Clarifier:

1. Press the [RX CLAR] button. The “RX” notation will appear in the TFT Display, and the programmed offset will be applied to the receive frequency.
2. Rotation of the [VFO-B/CLAR] knob will allow you to modify your initial offset on the fly. Offsets of up to ± 9.99 kHz may be set using the Clarifier.

To cancel Clarifier operation, press the [RX CLAR] button. The “RX” notation will disappear from the display.

ADVICE:

- Turning the Clarifier off merely cancels the application of the programmed offset from the receive and/or the transmit frequencies. To clear the Clarifier offset, and reset it to “zero,” press the [CLEAR] button. The programmed offset is displayed in the small multi-channel window of the frequency display.
- The Clarifier operation (including the offset frequency) will be memorized independently on each VFO stack of VFO-A and VFO-B.

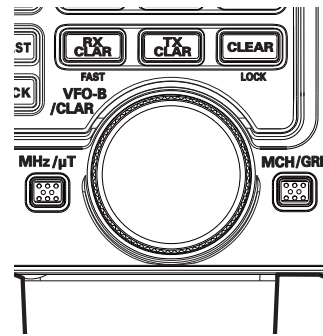
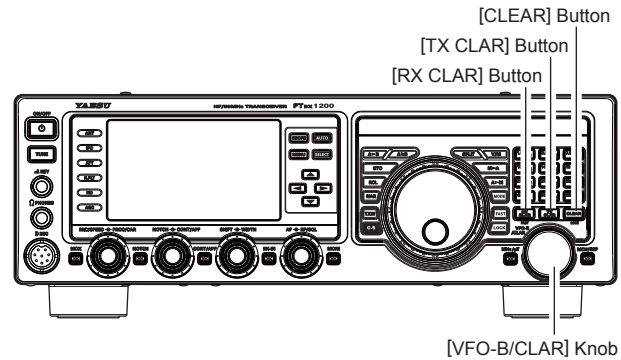

TXCLAR

Alternately, you may apply the Clarifier offset to the transmit frequency, without changing the receive frequency (typically, for “split” DX pile-ups).

The Tuning Offset Indicator provides a graphical representation of the Clarifier offset.

In CW mode the factory default setting of the Tuning Offset Indicator shows the CW Center Tuning, instead of Clarifier Offset. If you wish to change this so that the Clarifier Offset is also displayed on CW, use the following procedure:

1. Press the [MENU] button to enter the Menu mode.
2. Rotate the [VFO-B/CLAR] knob (or press the $\blacktriangle/\blacktriangledown$ button) to select Menu item “011 BAR DISPLAY SELECT”.
3. Press the [SELECT] button, then rotate the [VFO-B/CLAR] knob (or press the $\blacktriangle/\blacktriangledown$ button) to select “CLAR (Clarifier)” (replacing the default “CW TUNE (CW TUNING)” selection).
4. Press the [SELECT] button, then press the [MENU] button to save the new setting and exit to normal operation.

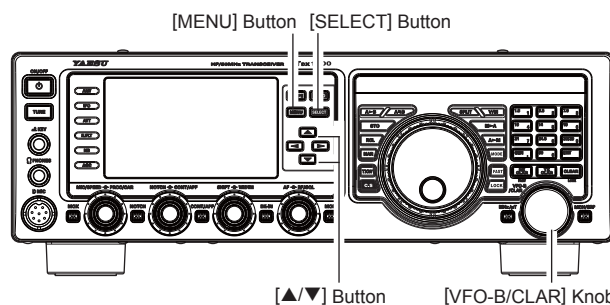
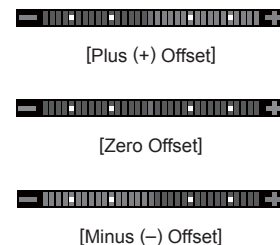

BASIC OPERATION: RECEIVING ON AMATEUR BANDS

LOCK

You may lock the setting of the Main Tuning Dial knob (for VFO-A frequency tuning) and the [VFO-B/CLAR] knob (for VFO-B frequency tuning during Split operation), to prevent accidental frequency change.

Main Tuning Dial Knob Lock

To lock the Main Tuning Dial knob, press the [LOCK] button that is located to the right of the Main Tuning Dial knob. To unlock the Dial setting, and restore normal tuning, press the [LOCK] button once more.

[VFO-B/CLAR] Knob Lock

To lock the [VFO-B/CLAR] knob, press the [CLEAR (LOCK)] button that is located to the upper right of the [VFO-B/CLAR] knob. To unlock the [VFO-B/CLAR] knob, and restore normal tuning, press the [CLEAR (LOCK)] button once more.

ADVICE:

The lock feature will be memorized independently on the Main Tuning Dial knob and the [VFO-B/CLAR] knob.

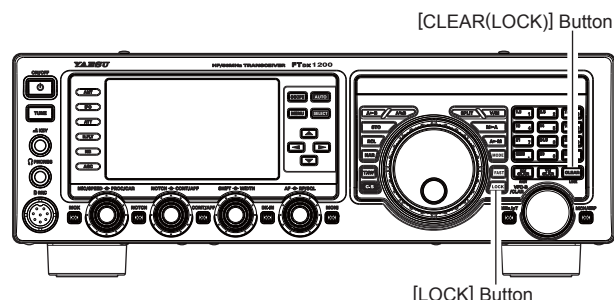

DIMMER

The illumination level of the TFT display and LED indicators (above the Main Tuning Dial knob), may be adjusted via Menu items 009 and 010.

To adjust the illumination level:

1. Press the [MENU] button to enter the Menu mode.
2. Rotate the [VFO-B/CLAR] knob (or press the ▲/▼ button) to select Menu item "009 DIMMER LED" (for LED indicators) or "010 DIMMER TFT" (for TFT display).
3. Press the [SELECT] button then rotate the [VFO-B/CLAR] knob (or press the ▲/▼ button) to select the desired illumination level.
4. Press the [SELECT] button, then press the [MENU] button to save the new setting and exit to normal operation.

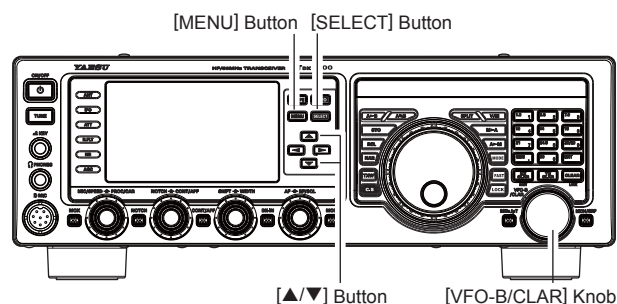

VFO COLOR

The background color of the VFO-A frequency in the TFT display may be selected via Menu item 007.

1. Press the [MENU] button to enter the Menu mode.
2. Rotate the [VFO-B/CLAR] knob (or press the ▲/▼ button) to select Menu item "007 VFO COLOR".
3. Press the [SELECT] button, then rotate the [VFO-B/CLAR] knob (or press the ▲/▼ button) to select from the following colors:
BLUE (default) / SKY BLUE / GREEN / PURPLE / RED / ORANGE / GRAY / BLACK
4. Press the [SELECT] button, then press the [MENU] button to save the new setting and exit to normal operation.

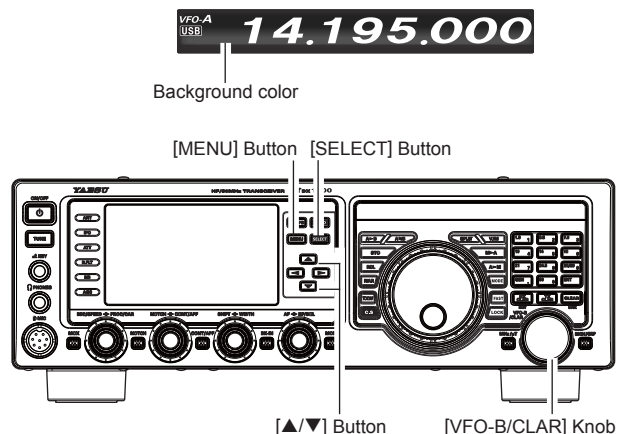

CONVENIENCE FEATURES

BAND STACK OPERATION

The **FTdx1200** utilizes a triple band-stack VFO selection technique, that permits you to store up to three favorite frequencies and modes onto each band's VFO register. For example, you may store one frequency each on 14 MHz CW, RTTY, and USB, then recall these VFOs by successive, momentary presses of the **[14]** MHz band button. Each Amateur band key may similarly have up to three frequency/mode settings applied. Note that only the VFO-A system has the band stacks.

A typical setup, for the 14 MHz band, might be arranged like this:

1. Program 14.025 MHz, CW Mode, then press the **[14]** MHz band button;
2. Program 14.080 MHz, RTTY Mode, then press the **[14]** MHz band button;
3. Program 14.195 MHz, SSB Mode, then press the **[14]** MHz band button.

With this configuration, successive momentary presses of the **[14]** MHz band button will allow you to step sequentially through these three VFOs.

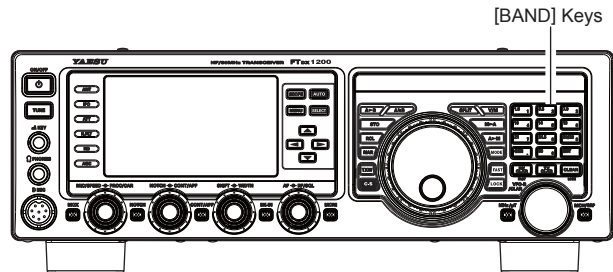
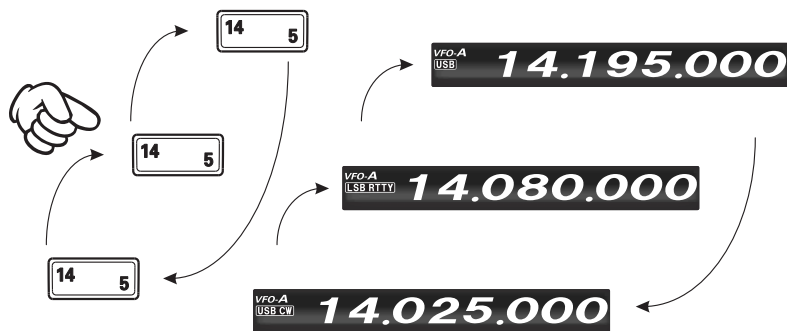

C.S (CUSTOM SWITCH)

The front panel **[C.S]** button may be programmed to directly access an often-used Menu Mode selection.

C.S Setup

1. Press the **[MENU]** button to engage the Menu mode; the Menu list will appear on the display.
2. Rotate the **[VFO-B/CLAR]** knob (or press the **▲/▼** button) to select the Menu item you want to access with the front panel **[C.S]** button.
3. Press the **[C.S]** button to lock in your selection.
4. Press the **[MENU]** button to save the new configuration and exit to normal operation.

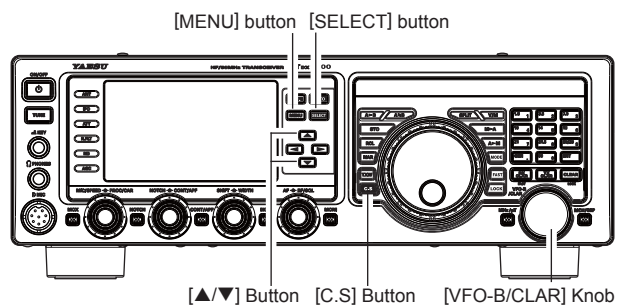

Menu Selection Recall via **[C.S]** button

Press the **[C.S]** button.

The programmed Menu item will appear on the display. Press the **[MENU]** button exit to normal operation.

SCOPE

This function displays a convenient spectrum scope for monitoring the band conditions. Both strong and weak signals can be displayed in an easy-to-understand manner on the TFT screen. This multifunctional scope takes into consideration the operator's preference, by switching between the convenient CENTER mode where the VFO frequency is constantly in the center of the screen (for monitoring conditions on both sides of your operating frequency), and the FIX mode, where the frequency is fixed to the left side of the screen (for convenience in monitoring in the band).

Note: Since the **FTDX1200** has only one receiver the audio will be muted while the spectrum scope is scanning.

1. Select an operating mode for the scope function, either CENTER or FIX mode.

ADVICE:

See the instructions on the next page for details on individual operating modes.

2. Press the [**SCOPE**] button momentarily to display the scope screen.

Five different screens are shown on the TFT display by pressing the [**SCOPE**] button.

ADVICE:

- During continuous sweeping, no audio will be heard.
- Sweep speed can be changed in the Menu item "125 SCOPE SPEED".
- The received sound spectrum is displayed on the AF-FFT screen. Press the [**MONI**] button to display the received station's transmission signal spectrum.
- On the AF-FFT screen, either the "Spectrum Display" or the "Waterfall Display" can be selected in the Menu item "185 FFT DISPLAY MODE".

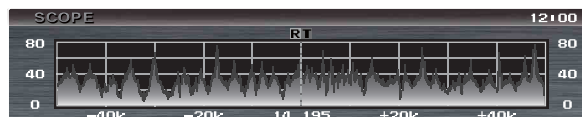

Spectrum scope display

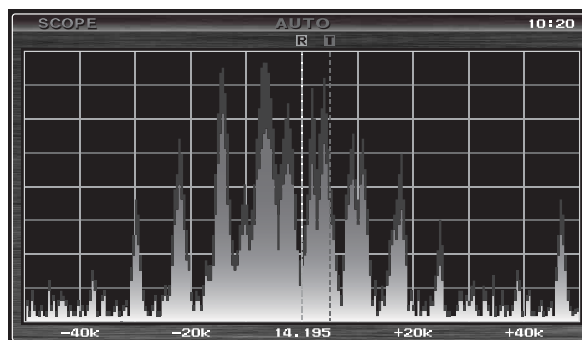

Full screen spectrum scope display



Spectrum scope plus the AF-FFT display
(When the optional FFT unit is installed)

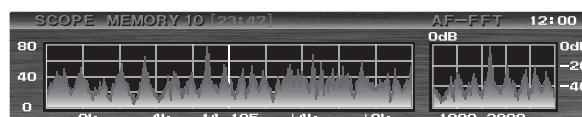

Spectrum scope Memory display
(When the Scope Memory stored)



Sweep Mode

MANUAL mode

Each time the [**SELECT**] button is pressed, a new scan of the spectrum scope is shown on the TFT display.

ASC (Automatic Spectrum-Scope Control) mode

Press the [**AUTO**] button to access the ASC mode. "AUTO" icon is indicated in red on the spectrum scope display. While the MAIN DIAL is turned slowly, the spectrum scope does not change. When the MAIN DIAL is turned quickly the audio is muted and the spectrum scope is scanned continually and displayed on the spectrum scope screen until the MAIN DIAL is completely stopped. When the spectrum scope scanning is stopped, the audio is restored. The last scan is shown on the TFT display. Listen to the station and slowly fine tune the station.

ADVICE:

By setting the "126 SCOPE AUTO TIME" menu mode sweeping can be carried out automatically at the pre-set interval.

Continuous mode

Press the [**AUTO**] button and hold for 1 second. The audio is muted and the spectrum scope is scanned continuously until the [**AUTO**] button is pressed again.

CONVENIENCE FEATURES

SCOPE

CENTER mode

1. Switch operation mode to “CENTER mode”.
See “Switching between CENTER/FIX Modes” below for details on changing operating modes.
2. Press the [**SCOPE**] button momentarily to display the scope screen.
 - The current frequency is displayed in the center.
 - Width of scope display can be set in the Menu item “128 CENTER SPAN FREQ”.

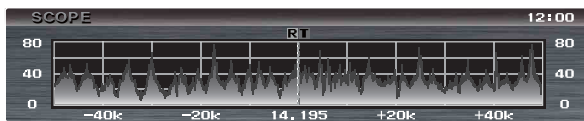

Current Frequency

FIX mode

1. Switch the operation mode to “FIX mode”.
See “Switching between CENTER/FIX Modes” below for details on changing operating modes.
2. Press the [**SCOPE**] button momentarily to display the scope.
 - The frequency set in Menu Mode is displayed at the leftmost start point on the screen.
 - Width of scope display can be set in Menu Mode by individual band (See below).

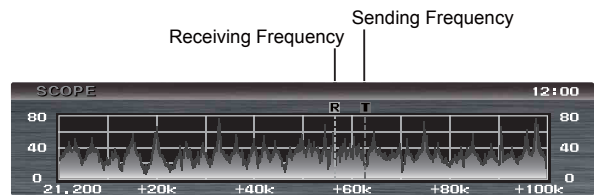

Frequency set in Menu Mode

Example of display in split operation

FREQUENCY	MENU MODE
1.8MHz	130 FIX 1.8MHz SPAN
3.5MHz	132 FIX 3.5MHz SPAN
5MHz	134 FIX 5.0MHz SPAN
7MHz	136 FIX 7.0MHz SPAN
10MHz	138 FIX 10MHz SPAN
14MHz	140 FIX 14MHz SPAN
18MHz	142 FIX 18MHz SPAN
21MHz	144 FIX 21MHz SPAN
24MHz	146 FIX 24MHz SPAN
28MHz	148 FIX 28MHz SPAN
50MHz	150 FIX 50MHz SPAN

Switching Between CENTER/FIX Modes

1. Press the [**MENU**] button to enter the Menu mode.
2. Rotate the [**VFO-B/CLAR**] knob (or press the ▲/▼ button) to select Menu item “124 SCOPE MODE”.
3. Press the [**SELECT**] button, then rotate the [**VFO-B/CLAR**] knob (or press the ▲/▼ button) to select the “CENTER” or “FIX” (Factory default is “CENTER”).
4. Press the [**SELECT**] button, then press the [**MENU**] button to save the new setting and exit to normal operation.

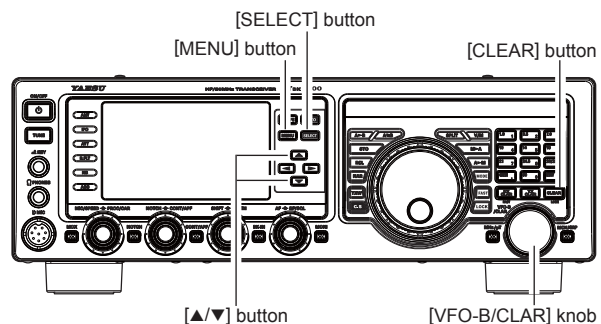

SCOPE

Memorizing the Scope Screen

The **FTdx1200** can memorize the scope screen in up to 10 channels, and recall it later.

How to memorize

Press and hold the **[SELECT]** button for one second to memorize the current scope screen. Up to 10 channels may be memorized. Once all 10 memories have data in them, previous data (starting with channel "1") will be over-written, on a first-in, first-out basis.

Recalling memorized screens

1. Press the **[SCOPE]** button several times until the "Spectrum Scope Memory" screen appears. The last stored scope screen memory will be displayed.

Press the **[SCOPE]** button to display the screens in the following order:

[Multi-Function] screen →
 → **[Spectrum scope]** screen →
 → **[Full screen Spectrum scope]** screen →
 → **[Spectrum scope+AF-FFT]** screen* →
 → **[Spectrum scope Memory]** screen →

*: When the optional FFT unit is installed

2. Press the **[▲]/[▼]/[◀]/[▶]** buttons to recall the memorized screen you wish.

[▲]/[▶] button: Recalls the memory towards the new memory.

1 → 2 → 3 → 4 9 → 10 → 1 → 2 ...

[◀]/[▼] button: Recalls the memory towards the old memory.

10 → 9 → 8 → 7 2 → 1 → 10 → 9 ...

3. To close the scope screen, press the **[SCOPE]** button several times until the desired screen appears.

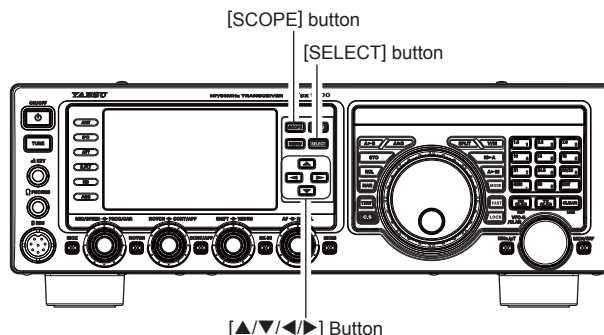

Erasing the memorized screens

1. Recall the scope screen that you wish to erase using the **[▲]/[▼]/[◀]/[▶]** button.
2. Press and hold one of the **[▲]/[▼]/[◀]/[▶]** button for one second to erase the scope screen. The memory channel is deleted, and the channel numbers, for channels with higher numbers, are decremented.

CONVENIENCE FEATURES

ROTATOR CONTROL FUNCTIONS

When using a YAESU model **G-800DXA**, **G-1000DXA**, **G-2800DXA** Antenna Rotator (not supplied), it is possible to control it from the front panel of the **FTdx1200**.

1. Press and hold in the **[ENT]** button (one of the **[BAND]** key switches) for one second. The TFT display will change to the “Rotator Control” configuration.
2. Press either the **[3.5(2)]** button or the **[7(3)]** button to rotate the antenna. Pressing the **[3.5(2)]** button will cause rotation to the left (counter-clockwise) by two degree steps, while pressing the **[7(3)]** button will cause rotation to the right (clockwise) by two degree steps.
3. Press the **[14(5)]** button or the **[18(6)]** button to control the speed of rotation. Pressing the **[14(5)]** button will cause slower rotation, while pressing the **[18(6)]** button will speed up rotation. Usually, you will be using the “100%” speed setting.

When you are through exercising rotator control, press the **[ENT]** button momentarily.

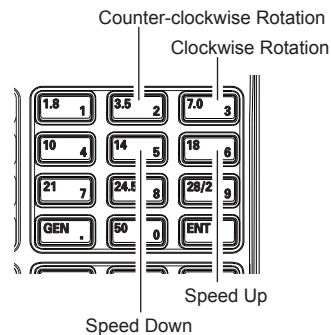
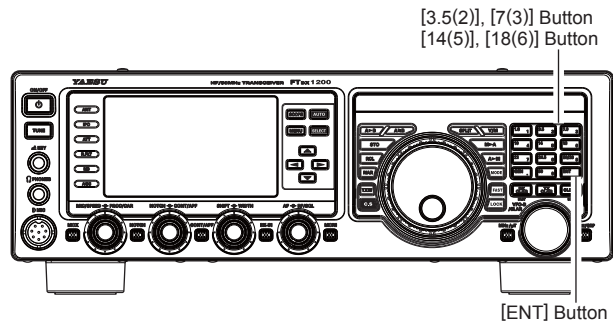

SPEED 100% DIRECTION +180°

Speed (0% -100%) Direction (0° - 360°)
"Overlap" Indicator

IMPORTANT NOTE

- ❑ Set the starting point to match your rotator control indicator needle via the Menu item “014 ROTATOR START UP”. The default setting is zero (north). If your controller starting point is south, the Menu item “014 ROTATOR START UP” must be set to “180”. If not set properly the **FTdx1200** display will not show the correct direction.
- ❑ When the rotator control indicator needle does not indicate the precise antenna direction, calibrate the indicator needle precisely to the antenna direction via the Menu item “015 ROTATOR OFFSET ADJ”.

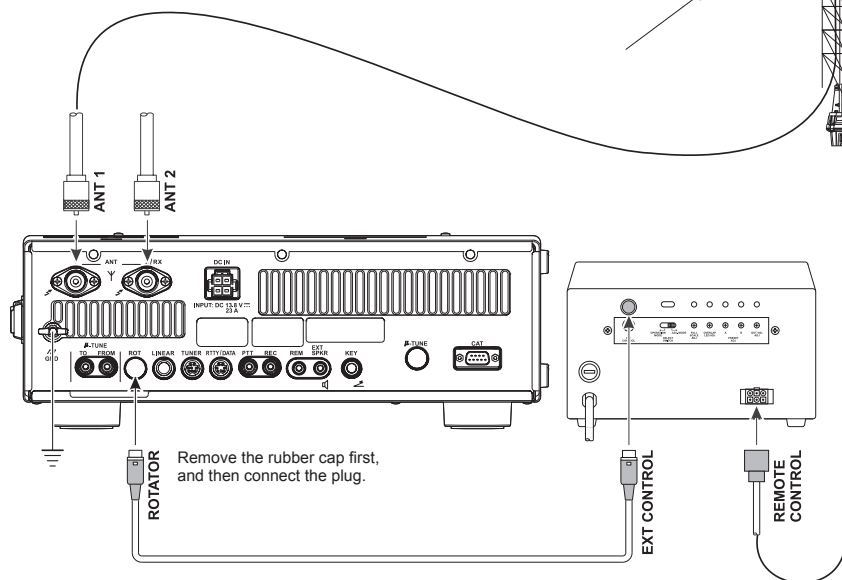
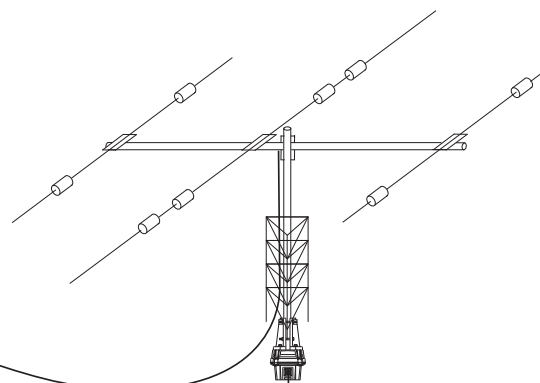

MORE FREQUENCY NAVIGATION TECHNIQUES

Keyboard Frequency Entry

The Operating frequency may be entered directly into the current VFO, using the front panel [BAND] key buttons.

Example: Enter 14.250.00 MHz

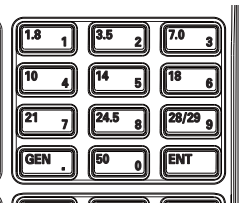
1. Press the [ENT] button to begin the direct frequency entry process. Now, beginning with the first digit of the frequency (the leftmost digit), we will enter the required digits of the frequency.
2. Press, in order, the digits of the operating frequency, using the [BAND] buttons (the frequency entry digit or decimal point is printed on the right side of the buttons). In this example, enter [1.8(1)] → [10(4)] → [GEN(.)] → [3.5(2)] → [14(5)] → [50(0)] → [50(0)] → [50(0)] → [50(0)]

3. Press the [ENT] button once more to complete the operating frequency entry. A short “beep” will confirm that the entry was successful, and the new operating frequency will appear on the display.

ADVICE:

If you attempt to enter a frequency outside the operating range of 30 kHz ~ 56 MHz, the microprocessor will ignore the attempt, and you will be returned to the previous operating frequency. If this happens, please try again, taking care not to repeat the error in the frequency entry process.

Using the [VFO-B/CLAR] knob

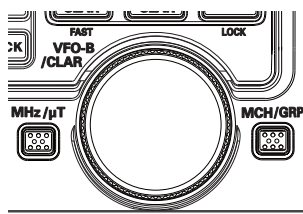
You may change the VFO-A frequency in 1 MHz steps. Press the [MHz/μT] button located at the bottom left of the [VFO-B/CLAR] knob. The 1 MHz steps will be applied to the VFO-A frequency. The “MHz 1MHz” notation will appear in the display.



When tuning in 1 MHz steps, clockwise rotation of the [VFO-B/CLAR] knob will increase the frequency, while counter-clockwise rotation will decrease the frequency.

Using the [UP]/[DWN] buttons of the supplied MH-31B8 Hand Microphone

The [UP]/[DWN] buttons on the supplied MH-31B8 Hand Microphone may also be used to manually scan the frequency upward or downward.

The microphone’s [UP]/[DWN] buttons utilize the tuning steps of the Main Tuning Dial knob.

When the microphone [FST] button is pressed, the tuning rate increases by a factor of ten, in a manner similar to the transceiver front panel [FST] button.

ADVICE:

You may independently set the tuning steps of the [UP]/[DWN] buttons in the AM and FM modes. To set new tuning steps, use Menu items “156 AM CH STEP” and “157 FM CH STEP”.

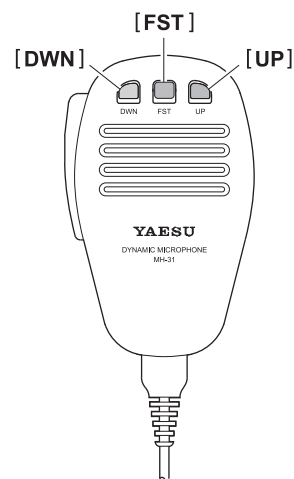

CONVENIENCE FEATURES

ANTENNA SELECTION

You can switch between the two transceiver antennas. In addition, ANT2 can also be used as a dedicated reception antenna.

Every time the [ANT] button is pressed, the antenna terminal (ANT1, ANT2) on the rear panel is switched.

- ❑ The selected antenna as “1” or “2” appears in the Key Function display.
- ❑ When using ANT2 for reception only, set in the Menu item “033 ANT2 SETTING” as below.

SETTING	TX ANTENNA	RX ANTENNA
RX	ANT1	ANT2
TRX	ANT2	

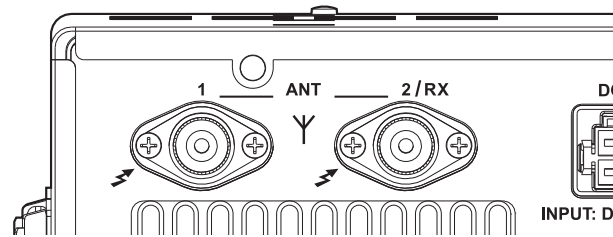
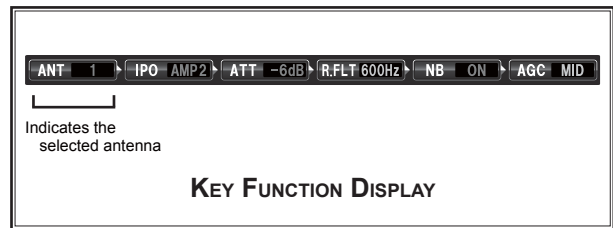
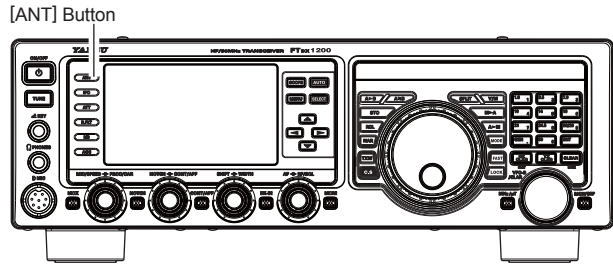

ANTENNA TERMINALS ON THE REAR PANEL

RECEIVER OPERATION (FRONT END BLOCK DIAGRAM)

The **FTdx1200** includes a wide range of special features to suppress the many types of interference that may be encountered on the HF bands. However, real world interference conditions are constantly changing, so optimum setting of the controls is somewhat of an art, requiring familiarity with the types of interference and the subtle effects of some of the controls. Therefore, the following information is provided as a general guideline for typical situations, and a starting point for your own experimentation.

The **FTdx1200** interference-fighting circuitry begins in its “RF” stages, and continues throughout the entire receiver section. **FTdx1200** allows configuration of the features described below.

R. FLT (IF Roofing Filters)

Three Roofing filters, of 15 kHz, 6 kHz, and 3 kHz bandwidths, are provided in the First IF, right after the first mixer. These filters are automatically selected to provide narrow-band selectivity to protect the following IF and DSP stages. The automatically selected filter may be manually changed by the operator, if desired, for special operating circumstances.

CONTOUR Filter

The DSP Contour filter has the unique ability to provide either a null or a peak in tunable segments of the receiver passband. You may suppress interference and excessive frequency components on an incoming signal, or you may peak those tunable frequency segments. The level of the null or peak, and the bandwidth, over which it is applied, are adjustable via the Menu.

IF SHIFT

The passband center frequency of the IF DSP filter may be moved up or down by adjusting this control.

IF WIDTH

The width of the IF DSP filtering may be adjusted using this control.

IF NOTCH

The IF Notch filter is a high-Q notch filter that can eliminate, or significantly reduce an interfering carrier.

DNF (Digital Notch filter)

When multiple interfering carriers are encountered during reception, the Digital Notch Filter can significantly reduce the level of these signals.

DNR (Digital Noise Reduction)

The DSP’s Digital Noise Reduction (DNR) feature utilizes 15 different mathematical algorithms to analyze and suppress different noise profiles encountered on the HF/50 MHz bands. Choose the selection that provides the best noise suppression, and allows the signal to rise up out of the noise.

AGC

The AGC system is highly adaptable to changing signal and fading characteristics, making reception possible under the most difficult conditions.

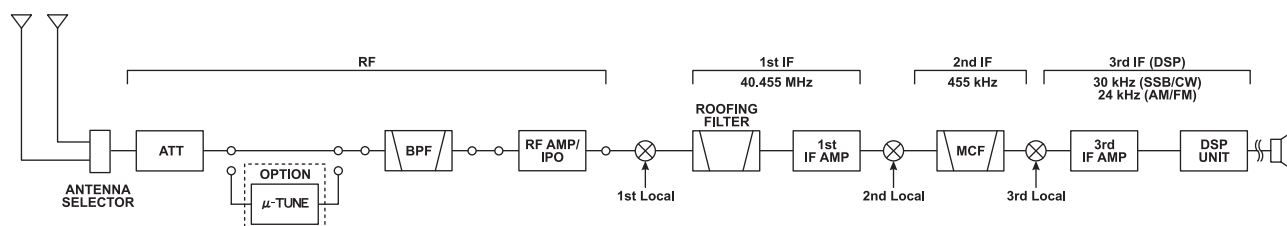

FRONT END BLOCK DIAGRAM

INTERFERENCE REJECTION

ATT

When extremely strong local signals or high noise degrades reception, you can use the **[ATT]** button to insert 6, 12, or 18-dB of RF attenuation in front of the RF amplifier.

1. Press the **[ATT]** button several times to set the desired attenuation level, per the chart below.

OFF: Attenuator is Off

-6dB: The incoming signal power is reduced by 6 dB (Signal voltage reduced by 1/2)

-12dB: The incoming signal power is reduced by 12 dB (Signal voltage reduced to 1/4)

-18dB: The incoming signal power is reduced by 18 dB (Signal voltage reduced to 1/8)

The selected attenuation level will be indicated in the ATT column of the Key Function Display on the TFT display.

2. To restore full signal strength through the Attenuator circuit area, press the **[ATT]** button to restore the ATT display to the “OFF” position.

[ATT] Button

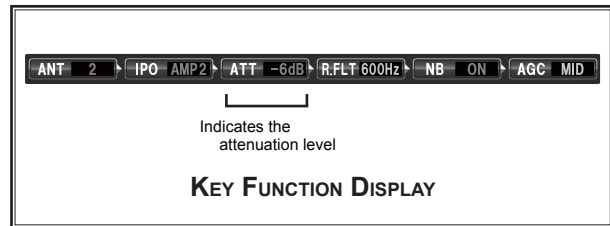
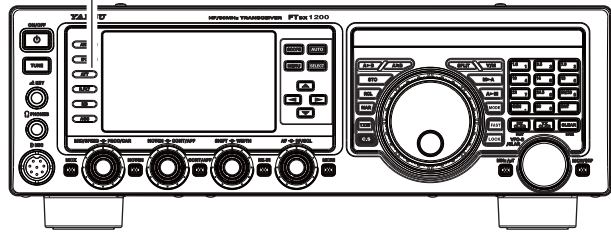

ADVICE:

- If background noise causes a high S-meter indication on clear frequencies, press the **[ATT]** button until the S-meter drops to about “S-1”. This setting optimizes the trade-off between sensitivity, noise, and interference immunity. Also, once you have tuned in a station you want to work, you may want to reduce sensitivity further (add more attenuation) by pressing the **[ATT]** button to a higher setting. This reduces the strength of all signals (and noise) and can make reception more comfortable, important especially during long QSOs. When looking for weak signals on a quiet band, you will want maximum sensitivity, so the IPO should be disabled and the **[ATT]** button should be set to “OFF.” This situation is typical during quiet times on frequencies above 21 MHz, and when using a small or negative-gain receiving antenna on other bands.

μ-TUNE FILTER (REQUIRES THE OPTIONAL RF μ TUNING KIT)

The RF μ Tuning Kit provides ultra-sharp RF selectivity for the front end of the transceiver. Very high Q is made possible by the narrow-band design. Three RF μ Tuning Kits are available. The **MTU-160** covers the 1.8 MHz band. The **MTU-80/40** covers the 3.5 and 7 MHz bands. The **MTU-30/20** covers 10.1 and 14 MHz bands.

When any (or all) of the three optional units are connected, they will be automatically adjusted to center on your operating frequency.

The narrow bandwidth is especially useful on the low bands, when many strong signals are being received via NVIS propagation (Near Vertical-Incidence Signals) within a narrow bandwidth. The added protection for the RF stage is especially helpful in preventing IMD and blocking.

μ-Tune Operation

1. Press and hold in the [MHz/ μ T] button for one second to activate the μ -Tune filter. The “ μ -Tune” will appear on the TFT display. The [VFO-B/CLAR] knob works as the μ -TUNING knob.

ADVICE:

- The μ -Tune circuit will automatically align itself to the operating frequency.
 - Remember that μ -Tune only operates on the 14 MHz and lower bands.
2. Rotate the [VFO-B/CLAR] knob to peak the response (background noise) or reduce interference.

ADVICE:

- You may observe the relative peak point of the μ -Tune filter in the Tuning Offset Indicator on the display, while tuning the [VFO-B/CLAR] knob.
 - The amount of change in the center frequency of the μ -Tune filter, when rotating the [VFO-B/CLAR] knob, can be configured using Menu item “046 μ TUNE DIAL STEP”.
 - If the μ -Tune filter has been manually adjusted away from the center frequency, you may press the [CLEAR] button to re-center the filter response on the current operating frequency.
3. Press and hold in the [MHz/ μ T] button for one second to disengage the μ -Tune filter

ADVICE:

Alternate presses of the [MHz/ μ T] button will switch the μ -Tune filter between on or off.

ADVICE:

- You may change the indication of the Tuning Offset Indicator to display the μ -Tune filter continuously while the μ -Tune filter is activated. This is Menu item “011 BAR DISPLAY SELECT”. See “Changing the Tuning Offset Indicator” on the next page for details of the setting.
- The μ -Tune filters are the most advanced, selective RF preselector filters ever incorporated into an Amateur Radio transceiver. The RF selectivity provided

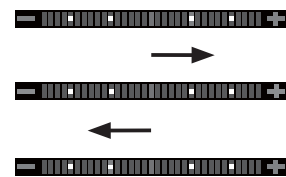
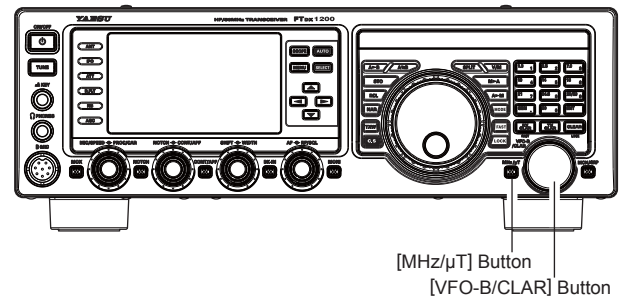

TUNING OFFSET INDICATOR

by μ -Tune can be of tremendous value in ensuring quiet, intermod-free reception even in the most crowded bands on a contest weekend. The μ -Tune filters provide RF selectivity on the order of a few dozen kHz at -6 dB, at the expense of a few dB of system gain on bands where noise figure is seldom an issue. You will notice that the S-meter deflection, when μ -Tune is engaged, is slightly less than when it is out of the circuit; this is normal. If your antenna system gain is so low that you cannot hear the band noise when μ -Tune is engaged (highly unlikely), just switch it out, to eliminate the slight insertion loss.

INTERFERENCE REJECTION

μ -TUNE FILTER (REQUIRES THE OPTIONAL RF μ TUNING KIT)

- As you tune around on an amateur band with μ -Tune engaged, the microprocessor automatically commands the stepper motor driving the toroid core to center the filter on the current operating frequency. However, you may use the [VFO-B/CLAR] knob to skew the filter response to one side or the other of the operating frequency, to deal with heavy interference on one side. To re-center the μ -Tune filter on the operating frequency, and eliminate any offset, press the [CLEAR] button.

Changing the Tuning Offset Indicator

1. Press the [MENU] button to engage the Menu mode.
2. Rotate the [VFO-B/CLAR] knob (or press the \blacktriangle / \blacktriangledown button) to select Menu item "011 BAR DISPLAY SELECT".
3. Press the [SELECT] button.
4. Rotate the [VFO-B/CLAR] knob (or press the \blacktriangle / \blacktriangledown button) to select " μ TUNE (μ -Tune)" (replacing the default "CW TUNE (CW TUNING)" selection).
5. Press the [SELECT] button, then press the [MENU] button to lock in the new setting and exit to normal operation.

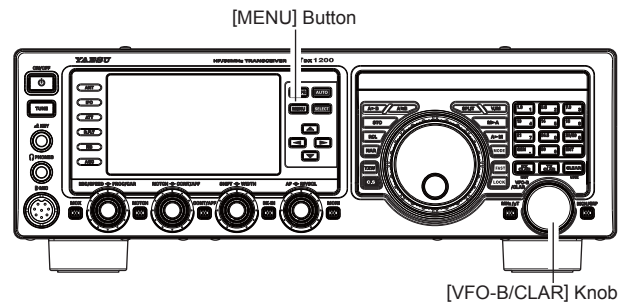

IPO (INTERCEPT POINT OPTIMIZATION)

The IPO feature allows the operator to optimize the characteristics of the receiver front end, depending on the current noise level and the strength of incoming signals.

Press the [IPO] button repeatedly, to set the desired characteristic of the receiver front end, according to the chart below.

- AMP1:** Amplifies the incoming signals, using a low distortion RF preamplifier (gain: approx. 10 dB).
- AMP2:** Amplifies the incoming signals, using a 2-stage low-distortion RF preamplifier (total gain: approx. 20 dB).
- IPO:** Bypasses the RF preamplifier, yielding direct feed to the first mixer.

The selected receiver RF preamplifier will be indicated in the IPO column of the Key Function Display on the TFT display.

ADVICE:

- On the 10 MHz and lower bands, it generally is not necessary to use any preamplifier at all; selecting the "IPO" position as described above will increase the strong-signal-handling capability of the receiver, and generally will result in more pleasant reception due to reduced noise. If you can hear band noise with the preamplifiers disengaged, then a preamplifier is generally not needed.

[IPO] Button

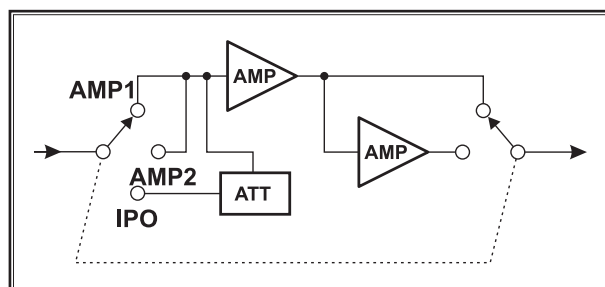
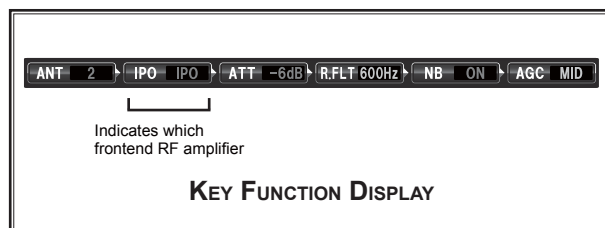
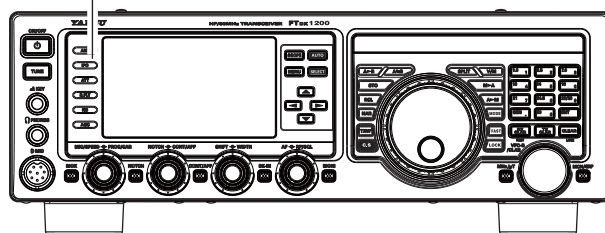

INTERFERENCE REJECTION

R.FLT (ROOFING FILTERS)

Narrow-band Roofing Filters of 15 kHz, 6 kHz, 3 kHz bandwidths are provided in the first IF, right after the first mixer. These filters provide protection for the 2nd mixer, DSP, and other circuitry that follow and can dramatically improve reception on a very crowded band (during a contest, etc.). Typically, the AUTO selection mode is satisfactory for most operating situations.

Press the **[R.FLT]** button to toggle the Roofing Filter selection.

AUTO*¹ → 3 kHz → 6 kHz → 15 kHz → AUTO

*1: The "AUTO" selection mode selects the optimum bandwidth of the Roofing filter for the reception mode.

In this case, the selected bandwidth in the R.FLT column of the Key Function Display glows green (Normally glows blue).

ADVICE:

- In the AM/FM mode, only the 15 kHz Roofing Filter is utilized.
- As you repeatedly press the **[R.FLT]** button, the selected Roofing Filter bandwidth will be displayed in the R.FLT column of the Key Function Display on the TFT display, denoting the Roofing Filter currently in use.
- Typically, this selection will be set to "AUTO."

QUICK POINT:

The "AUTO" selection of the Roofing Filter is based on the operating mode. However, you may override the automatic selection, if band conditions warrant a different (usually, a tighter) selection.

TERMINOLOGY:

A "Roofing Filter," as its name implies, places a "Roof" over the receiver IF system bandwidth. Starting at the first mixer, the Roofing filter protects the circuitry downstream from strong signals, just as a roof on a house protects the contents from rain and snow.

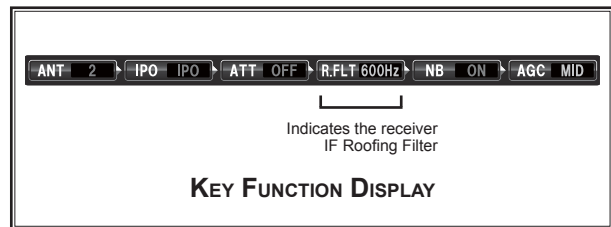
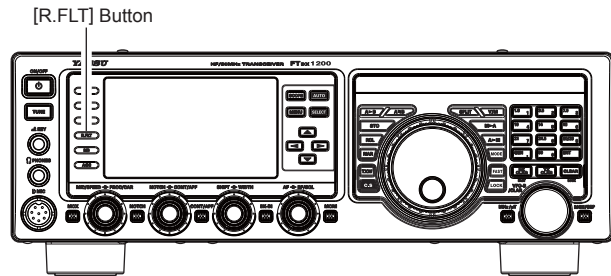

IF NOISE BLANKER (NB) OPERATION

The **FTdx1200** includes an effective IF Noise Blanker, which can significantly reduce noise caused by automotive ignition systems.

1. Press the **[NB]** button briefly to reduce *short duration pulse noise* such as from switching transients, automobile ignitions and power lines. The “**NB ON**” will appear in the display to confirm that the Narrow-NB is operating.
2. Press the **[NB]** button again to reduce *longer-duration man-made pulse noise*. The “**NBW ON**” will appear in the display to confirm that the Wide-NB is operating.
3. If desired, you may adjust the Noise Blanker level via Menu item “034 NB LEVEL” to the point where the offending noise is best reduced or eliminated. See box below for details.
4. To end Noise Blanker operation, press the **[NB]** button once more. The “**NB OFF**” will appear in the display, confirming that the Noise Blanker is no longer in operation.

[NB] Button

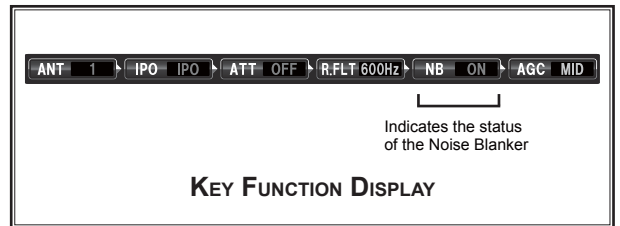
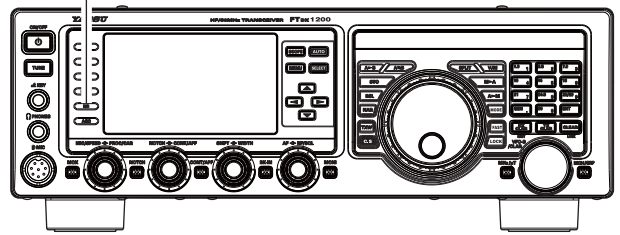

Adjusting the Noise Blanker Level

1. Press the **[MENU]** button to engage the Menu mode.
2. Rotate the **[VFO-B/CLAR]** knob (or press the **▲/▼** button) to select Menu item “034 NB LEVEL”.
3. Press the **[SELECT]** button
4. Rotate the **[VFO-B/CLAR]** knob (or press the **▲/▼** button) to the point where the offending noise is best reduced or eliminated.
5. Press the **[SELECT]** button, then press the **[MENU]** button to lock in the new setting and exit to normal operation.

[MENU] Button

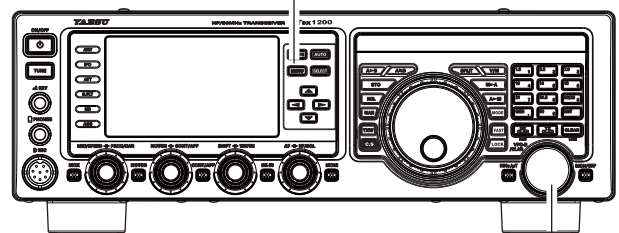

[VFO-B/CLAR] Knob

CONTOUR CONTROL OPERATION

The Contour filter system provides a gentle perturbation of the IF filter passband. The Contour is set to either suppress, or boost specific frequency components, and thus enhances the sound and readability of a received signal.

1. Press the [**CONT/APF**] button to activate the Contour filter. The DSP graphic display will illuminate and the current “null” (or “peak”) position of the Contour filter will appear in the CONTOUR indicator on the display.
2. Rotate the [**CONT/APF**] knob to achieve the most natural-sounding audio reproduction on the incoming signal.

ADVICE:

The display will show the Contour frequency for 3 seconds whenever the [**CONT/APF**] knob is turned.

3. To cancel Contour tuning, press the [**CONT/APF**] button momentarily.

ADVICE:

Alternate presses of the [**CONT/APF**] button will switch the Contour filter between on and off.

ADVICE:

- The Contour filter level (either a null or a peak) may be adjusted using Menu item “108 CONTOUR LEVEL”. The factory default setting is for a null of -15 (dB).
- The bandwidth over which the Contour filter effect is applied may be adjusted using Menu item “109 CONTOUR WIDTH”. The factory default setting is 10. When the set value is increased, the bandwidth becomes wider.

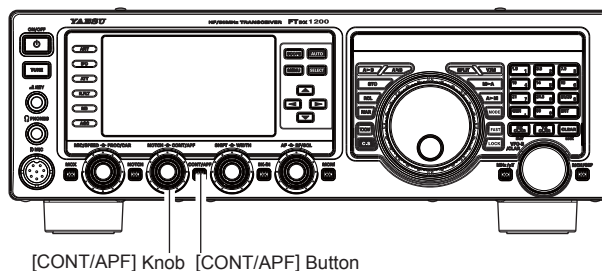

CONTOUR INDICATOR

Refer to Figure “B”, this illustrates an “indentation” of the Contour filter in the center of the passband. The Contour filter places a low-Q “notch” in the passband, per the settings of Menu items “108 CONTOUR LEVEL” and “109 CONTOUR WIDTH” (referenced above). Counterclockwise rotation (to the left) of the [**CONT/APF**] knob causes the notch to move toward a lower frequency within the passband, while clockwise rotation (to the right) causes the notch to move toward a higher frequency within the passband. By removing interference or unwanted frequency components of the incoming signal, it is possible to make the desired signal rise out of the background noise/interference, enhancing intelligibility.

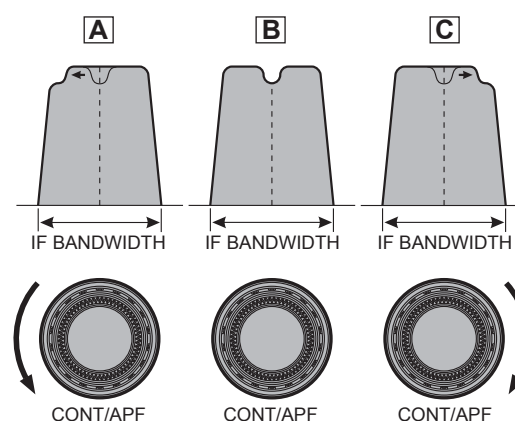

QUICK POINT:

By judicious use of the Contour filter, the “shoulder” of the passband response may be altered, or components may be removed from within the passband, allowing the desired signal to rise above the background noise and interference in a manner not obtainable with other filtering systems.

IF SHIFT OPERATION (SSB/CW/RTTY/PKT MODES)

IF SHIFT allows you to move the DSP filter passband higher or lower, without changing the pitch of the incoming signal, and thus reduces or eliminates interference. Because the carrier tuning frequency is not varied, there is no need to re-tune the operating frequency to eliminate the interference. The total passband tuning range for the IF SHIFT system is ± 1 kHz.

1. Rotate the **[SHIFT]** knob to the left or right to reduce the interference.

ADVICE:

The display will show the shift value of the IF SHIFT for 3 seconds whenever the **[SHIFT]** knob is turned.

Referring to Figure "A", note the depiction of the IF DSP filter as the thick line, with the **[SHIFT]** knob in the 12 o'clock position. In Figure "B", an interfering signal has appeared inside the original passband. In Figure "C", you can see the effect of rotating the **[SHIFT]** knob. The interference level is reduced by moving the filter passband so that the interference is outside of the passband.

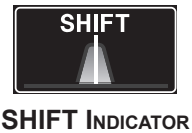
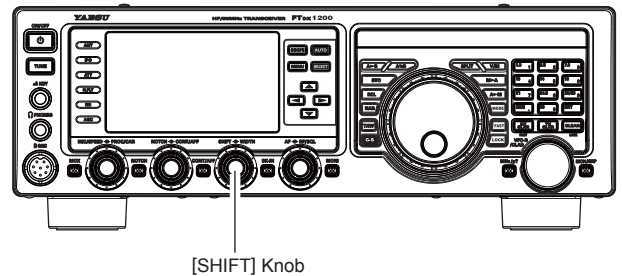
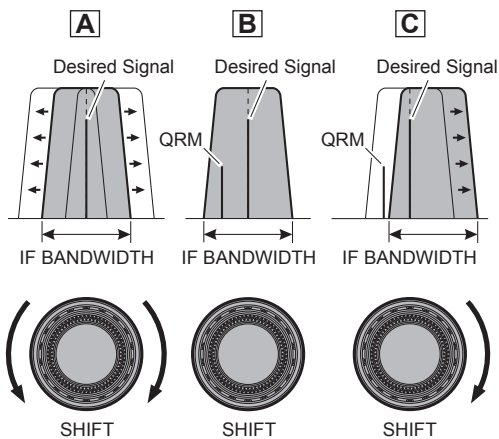

INTERFERENCE REJECTION

WIDTH (IF DSP BANDWIDTH) TUNING (SSB/CW/RTTY/DATA MODES)

The IF WIDTH tuning system allows you to vary the width of the DSP IF passband, to reduce or eliminate interference. Moreover, the bandwidth may actually be *expanded* from its default setting, should you wish to enhance incoming signal fidelity when interference on the band is low.

1. Rotate the [WIDTH] knob to the left or right to reduce the interference.

ADVICE:

The frequency display will show the bandwidth of the IF passband for 3 seconds whenever the [WIDTH] knob is turned.

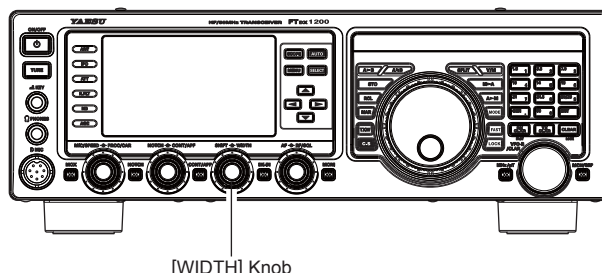

WIDTH INDICATOR

Referring to Figure “B”, you can see the default bandwidth on the SSB mode.

By rotating the [WIDTH] knob to the left, the bandwidth will narrow (see Figure “A”, while rotation of the [WIDTH] knob to the right, as depicted in Figure “C”, will increase the bandwidth.

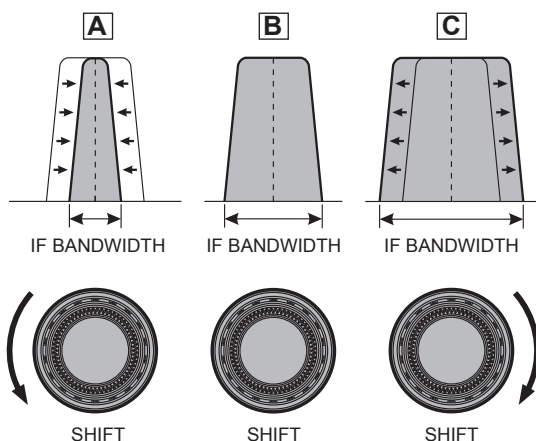

The default bandwidths, and total bandwidth adjustment range, will vary according to the operating mode:

SSB Mode: 1.8 kHz ~ 4.0 kHz (default: 2.4 kHz).
 CW Mode: 500 Hz ~ 2.4 kHz (default: 2.4 kHz)
 RTTY/DATA Modes: 500 Hz ~ 2.4 kHz (default: 500 Hz)

Using IF SHIFT and WIDTH Together

The IF SHIFT and Variable IF WIDTH features together form a very effective interference-fighting filtering system.

For example, in Figure “A”, you can see how interference has appeared both on the high and low sides of the desired signal. Rotate the [WIDTH] knob, the interference from one side can be eliminated (Figure “B”). Next, rotate the [SHIFT] knob to re-position the passband (Figure “C”), the interference on the opposite side can be removed, without re-introducing the interference previously eliminated in Figure “B”.

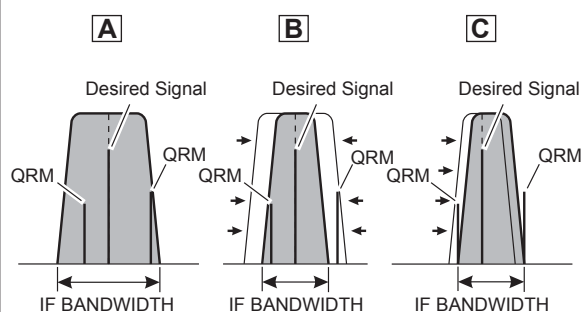

ADVICE:

For best interference reduction, the WIDTH and SHIFT features are the primary tools you should use, after narrowing the bandwidth (WIDTH) and/or adjusting the center of the passband (SHIFT). The Contour control may then yield additional signal-enhancement benefits on the net residual bandwidth. Even more, the IF NOTCH Filter (described later) may also be used, in conjunction with these filter systems, to significant advantage.

NARROW (NAR) ONE-TOUCH IF FILTER SELECTION

Pressing the **[NAR]** button provides one-touch, mode-specific, selection of a narrow IF DSP filter setting that does not require resetting the **[WIDTH]** knob.

Pressing the **[NAR]** button once more returns the bandwidth control to the WIDTH/SHIFT system. The factory default bandwidths are:

OPERATING MODE	[NAR] SWITCH	
	"ON"	"OFF"
SSB	200 Hz ~ 1.8 kHz* (1.8 kHz)	1.8 ~ 4.0 kHz* (2.4 kHz)
CW	50 ~ 500 Hz* (500 Hz)	500 Hz ~ 2.4 kHz* (2.4 kHz)
RTTY/DATA	50 ~ 500 Hz* (500 Hz)	500 Hz ~ 2.4 kHz* (2.4 kHz)
AM	6 kHz	6 kHz
FM (28/50 MHz Bands)	9 kHz	9 kHz

*: Depends on the **[WIDTH]** knob
(): Default Bandwidth

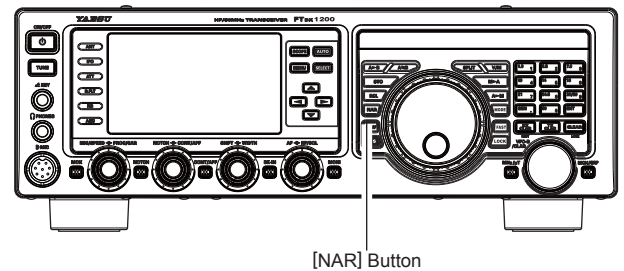

WIDTH INDICATOR

ADVICE:

- When the narrow bandwidth is selected, the "NAR" icon will appear in the display.
- If the **[NAR]** button has been pressed to engage the narrow filter, you may still adjust the narrow IF bandwidth by rotating the **[WIDTH]** knob. The IF SHIFT is also operational. For many applications, you may find that simply pressing the **[NAR]** button instead of adjustment of the **[WIDTH]** knob, may be satisfactory for interference reduction.
- When you press the **[NAR]** button in the FM mode, both transmit and receive bandwidths are narrowed.

INTERFERENCE REJECTION

IF NOTCH FILTER OPERATION (SSB/CW/RTTY/DATA/AM MODES)

The IF NOTCH filter is a highly effective system that allows you to slice out an interfering beat note or other carrier signal from inside the receiver passband.

1. Press the **[NOTCH]** button to activate the Notch filter. The DSP graphic display will illuminate and the current “null” position of the NOTCH filter will appear in the NOTCH indicator on the display. The **[NOTCH]** knob functions as the Notch adjustment knob.
2. Rotate the **[NOTCH]** knob to adjust the “null” position of the Notch filter.

ADVICE:

The frequency display will show the Notch frequency for 3 seconds whenever the **[NOTCH]** knob is turned.

3. To cancel the NOTCH filter, press the **[NOTCH]** button momentarily. The graphic disappears from the NOTCH indicator on the display, confirming that the NOTCH filter is no longer in operation.

ADVICE:

Alternate presses of the **[NOTCH]** button, will switch the NOTCH filter between on and off.

ADVICE:

- The bandwidth of the NOTCH filter (either narrow or wide) may be adjusted using Menu item “111 IF NOTCH WIDTH”. The factory default setting is “WIDE”.

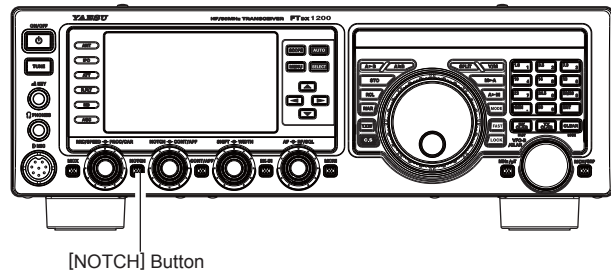

NOTCH INDICATOR

The performance of the IF NOTCH filter is illustrated in Figure “A”, where the effect of rotation of the **[NOTCH]** knob is depicted. In Figure “B” you can see the notching effect of the IF NOTCH filter as you rotate the **[NOTCH]** knob to eliminate the interfering heterodyne.

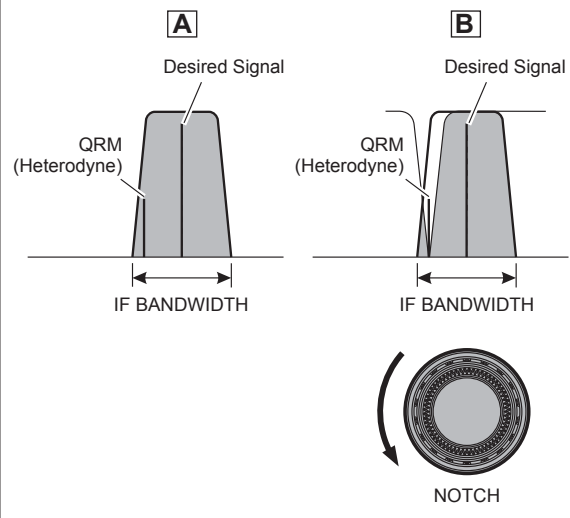

DIGITAL NOTCH FILTER (DNF) OPERATION

The Digital NOTCH Filter (DNF) is an effective beat-canceling filter that can null out a number of interfering beat notes inside the receiver passband. Because this is an Auto-Notch feature, there is no adjustment knob associated with this filter.

ADVICE:

If a very strong interfering carrier is encountered, we recommend you first use the IF NOTCH filter, as it is the most effective notching tool in the receiver section.

1. Press the [▲/▼/◀/▶] button to select the “DNF”.
2. Press the [SELECT] button to choose “ON”. The “DNF” will appear in the display.

To disable the Digital NOTCH Filter, just repeat the above procedure, pressing the [SELECT] button to choose “OFF” in step 2 above. The “DNF” will turn off, confirming that the Digital NOTCH Filter is not active.

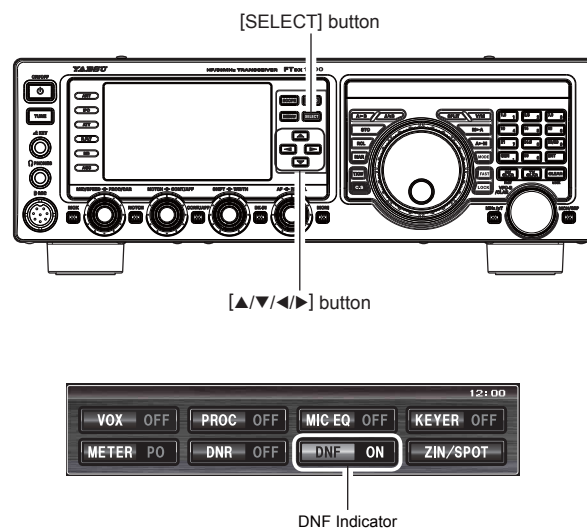

DIGITAL NOISE REDUCTION (DNR) OPERATION

The Digital Noise Reduction (DNR) system is designed to reduce the level of random noise found on the HF and 50 MHz bands, and it is especially effective during SSB operation. By setting the Menu item “110 DNR LEVEL”, any of 15 different noise-reduction algorithms can be selected; each of these algorithms was created for dealing with a different noise profile. You will want to experiment with the DNR system to find the best setting corresponding to the noise currently being experienced.

1. Press the [▲/▼/◀/▶] button to select the “DNR”.
2. Press the [SELECT] button to choose “ON”. The “DNR” will appear in the display.

To disable the DNR system, just repeat the above procedure, pressing the [SELECT] button to choose “OFF” in step 2 above. The “DNR” will turn off, confirming that the DNR system is not active.

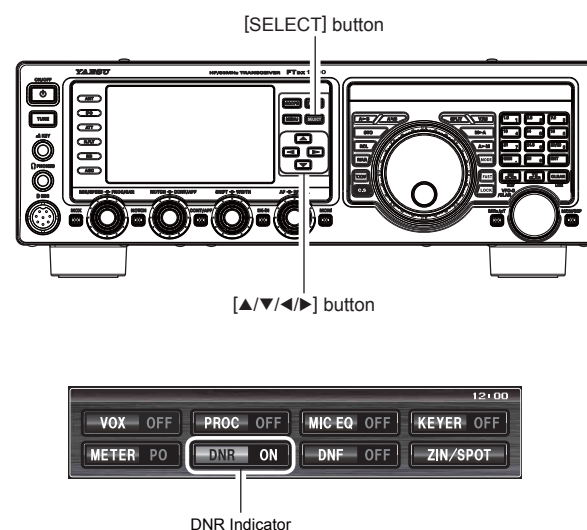

TOOLS FOR COMFORTABLE AND EFFECTIVE RECEPTION

RF GAIN

The RF Gain control provides manual adjustment of the gain levels for the receiver RF and IF stages, to account for noise and signal strength conditions at the moment.

1. The [RF/SQL] knob should, initially, be rotated to the fully clockwise position. This is the point of maximum sensitivity.
2. Counter-clockwise rotation of the [RF/SQL] knob will gradually reduce the system gain.

ADVICE:

- ❑ As the [RF/SQL] knob is rotated counterclockwise to reduce the gain, the S-meter reading will rise. This indicates that the AGC voltage being applied to the receiver is increasing (this causes a *reduction* in receiver gain).
- ❑ Rotating the [RF/SQL] knob control to the fully counter-clockwise position will essentially disable the receiver, as the gain will be greatly reduced. In this case, the S-meter will appear to be “pegged” against the right edge of the analog S-meter scale.

QUICK POINT:

- ❑ Reception frequently can be optimized by rotating the [RF/SQL] knob slightly counter-clockwise to the point where the “stationary” meter indication is set just about the same as the incoming noise level. This will reduce the RF gain to find a level of improved signal to noise ratio.
- ❑ The RF Gain control, along with the IPO and the Attenuator features, all affect the system receiver gain in different ways. The IPO generally should be the first feature engaged when dealing with a high noise level, or a crowded, high-level signal environment. Also, the IPO generally should be the first feature engaged, if the frequency is low enough to allow the preamplifier to be bypassed. Thereafter, the RF Gain and Attenuator features may be employed to provide precise, delicate adjustment of the receiver gain to fully optimize performance.

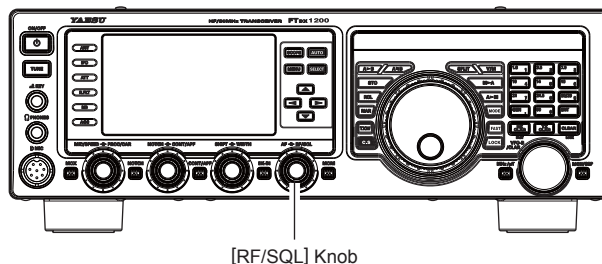

Switching the Knob Functions

You may switch the [RF/SQL] knob from the RF Gain Function to the Squelch Function via Menu item 038.

1. Press the [MENU] button to engage the Menu mode.
2. Rotate the [VFO-B/CLAR] knob (or press the ▲/▼ button) to select Menu item “038 RF/SQL VR”, then press the [SELECT] button.
3. Rotate the [VFO-B/CLAR] knob (or press the ▲/▼ button) to select “SQL” (replacing the default “RF” selection).
4. Press the [SELECT] button, then press the [MENU] button to lock in the new setting and exit to normal operation.

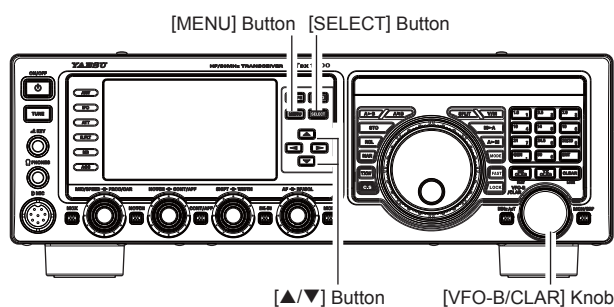

TOOLS FOR COMFORTABLE AND EFFECTIVE RECEPTION

DSP IF FILTER TYPES

Using DSP arithmetic processing and the normal bandwidth characteristics of the DSP IF filter, the sound quality can be made close to a conventional analog filter by rounding the shoulder of the filter, or importance can be placed on the filter cut-off by making the skirt characteristics flat. In addition, an improved filter composition can be enjoyed depending on the mode by combining the passing bandwidth characteristics and attenuation band characteristics.

1. Press the **[MENU]** button to engage the Menu mode.
2. Rotate the **[VFO-B/CLAR]** knob (or press the **▲/▼** button) to select the desired mode. See the tables below for details.
3. Press the **[SELECT]** button.
4. Rotate the **[VFO-B/CLAR]** knob (or press the **▲/▼** button) to adjust the sound quality.
 - When the **[CLEAR]** button is pressed, the values can be returned to their initial values.
5. When the **[SELECT]** button is pressed followed by the **[MENU]** button, the new setting will be confirmed and operation returns to normal.

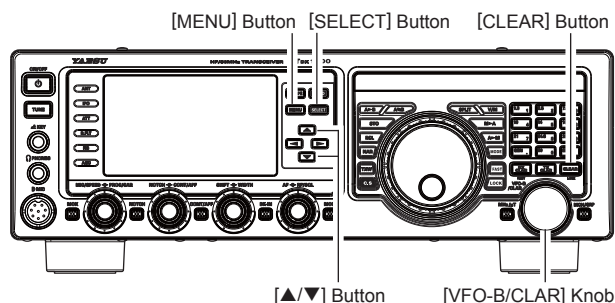

Passing Bandwidth Characteristics

MODE	BAND	MENU ITEM
CW	HF	112 HF CW SHAPE
	50MHz	114 6M CW SHAPE
PSK	HF	116 HF PSK SHAPE
FSK	HF	118 HF FSK SHAPE
SSB	HF	120 HF SSB SHAPE
	50MHz	122 6M SSB SHAPE

The following settings are available.

SHARP: Set the passing bandwidth of the IF filter as amplitude characteristic. Using DSP arithmetic processing, a sharp and ideal shape factor will result.

SOFT: Set the characteristic of the IF filter as a phase characteristic. Using DSP arithmetic processing, the shoulder of the filter will become rounded and the sound quality will become close to that of a conventional analog filter.

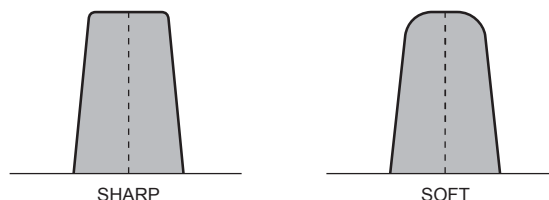

Attenuation Band Characteristics

MODE	BAND	MENU ITEM
CW	HF	113 HF CW SLOPE
	50MHz	115 6M CW SLOPE
PSK	HF	117 HF PSK SLOPE
FSK	HF	119 HF FSK SLOPE
SSB	HF	121 HF SSB SLOPE
	50MHz	123 6M SSB SLOPE

“**STEEP**”, “**MEDIUM**”, and “**GENTLE**” are selectable for the IF filter slope.

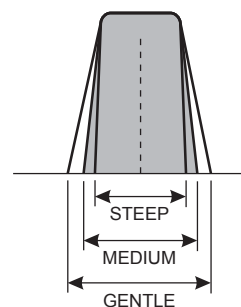

TOOLS FOR COMFORTABLE AND EFFECTIVE RECEPTION

AUDIO PITCH CONTROL (SSB MODE)

The **FTdx1200** permits adjustment of the receiver audio response by shifting the carrier point during SSB operation.

1. Press the **[MENU]** button to enter the Menu mode.
2. Rotate the **[VFO-B/CLAR]** knob (or press the **▲/▼** button) to select Menu item “105 LSB RX CARRIER” or “106 USB RX CARRIER”.
3. Press the **[SELECT]** button.
4. Rotate the **[VFO-B/CLAR]** knob (or press the **▲/▼** button) to adjust the receiver audio response as desired.
5. Press the **[SELECT]** button, then press the **[MENU]** button to save the new setting and exit to normal operation.

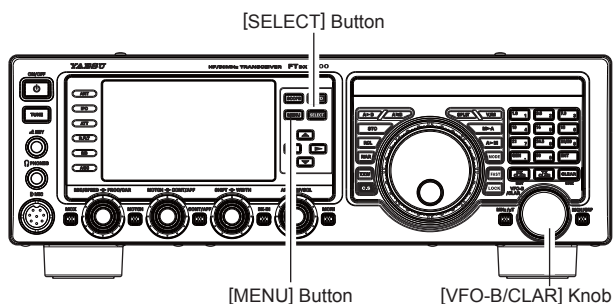

AUDIO PEAK FILTER

1. Press the **[CONT/APF]** button to activate the APF (Audio Peak Filter) which provides a very narrow audio bandwidth.

The “**APF**” indicator will appear in the DSP display.

ADVICE:

When APF is engaged, the peak position of the APF is depicted graphically in the NOTCH indicator on the display.

2. Press the **[CONT/APF]** button to disable the APF.

ADVICE:

The APF may only be activated while the transceiver is in CW mode.

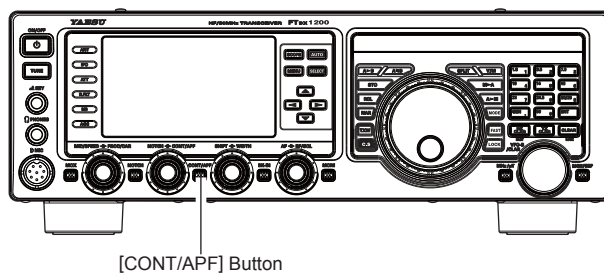

APF INDICATOR

AGC (AUTOMATIC GAIN CONTROL)

The AGC system is designed to help compensate for fading and other propagation effects. The AGC characteristics can be individually set for each operating mode. The basic objective of AGC is to maintain a constant audio output level once a certain minimum threshold of signal strength is achieved.

Press the **[AGC]** button repeatedly to select the desired receiver-recovery time constant. You will observe the AGC status notation in the AGC column of the Key Function Display on the TFT display, denoting the AGC receiver-recovery time currently in use. For most operations, we recommend the “AUTO” mode. Additionally, you may disable the AGC by pressing and holding in the **[AGC]** button for one second.

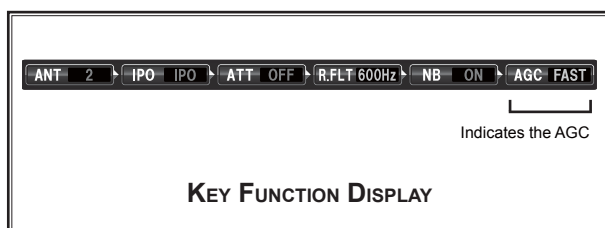

NOTE:

- ❑ The “AUTO” selection mode selects the optimum receiver-recovery time for the reception mode. In this case, the selected receiver-recovery time in the AGC column of the Key Function Display glows green (Normally glows blue).
- ❑ Pressing the **[AGC]** button allows selection of the desired receiver-recovery time constant. Normally, the “AUTO” selection is satisfactory for most situations, but in the event of operation on a crowded band where you wish to receive a weak signal, you may wish to change the setting to FAST. The AUTO mode selections are:

OPERATING MODE	AUTO AGC SELECTION
LSB/USB/AM	SLOW
CW/FM	FAST
RTTY/DATA	MID

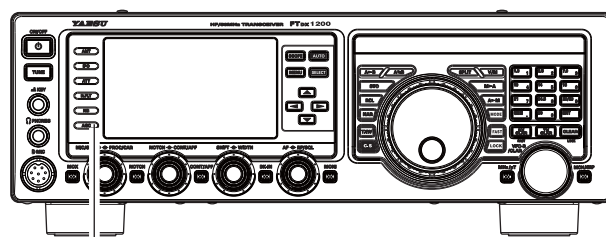

[AGC] Button

ADVICE:

- ❑ If the AGC receiver-recovery time is set to “Off” by pressing and holding in the **[AGC]** button, the S-meter will no longer deflect. Additionally, you will likely encounter distortion on stronger signals, as the IF amplifiers and the following stages are probably being overloaded.

QUICK POINT:

Several aspects of AGC performance may be configured via the Menu. However, because AGC can have such a profound impact on overall receiver performance, we generally do not recommend any changes to the AGC Menu selections until you are thoroughly familiar with the performance of the **FTdx1200**.

TERMINOLOGY:

Automatic Gain Control, or AGC, is a circuit that senses the received signal strength, and then limits the gain of the RF and IF stages to keep the output audio volume at a more-or-less constant level. AGC also protects the RF, IF, Audio, and DSP stages from overload, as it limits the signal strength that is allowed to flow, irrespective of the input signal level.

SLOPED AGC Operation

In traditional AGC systems, the audio output from the transceiver becomes essentially fixed once the threshold for AGC action is reached (usually several dozen dB above the no-signal noise floor). The **FTdx1200**, however, includes an innovative Sloped AGC system on the Main band (VFO-A) receiver, that allows the audio volume to rise and fall slightly according to signal strength. Although the rise/fall slope is not dramatic, it is sufficient to allow you to use your ear to discern and separate signals according to signal strength, not just audio frequency. Using Sloped AGC

1. Press the **[MENU]** button to engage the Menu mode.
2. Rotate the **[VFO-B/CLAR]** knob (or press the **▲/▼** button) to select Menu item “004 AGC SLOPE”.
3. Press the **[SELECT]** button, then rotate the **[VFO-B/CLAR]** knob (or press the **▲/▼** button) to change the setting to “SLOPE”.
4. Press the **[SELECT]** button, then press the **[MENU]** button to lock in the new setting and exit to normal operation. You will now be using the Sloped AGC system.

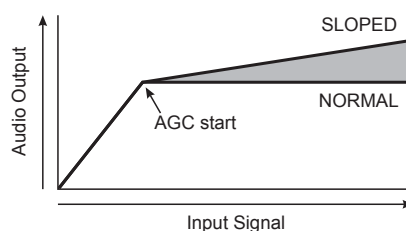

ADJUSTABLE RECEIVER AUDIO FILTER

The **FTdx1200** includes an adjustable receiver audio filter, that provides precise, independent control of the low; and upper audio ranges.

1. Press the **[MENU]** button to enter the Menu mode.
2. Rotate the **[VFO-B/CLAR]** knob (or press the **▲/▼** button) to find Menu items “050” through “053” these parameters apply to the adjustment of the receiver audio filter in the AM mode, Menu items “057” through “060” apply to the adjustment of the RX audio filter in the CW mode, Menu items “073” through “076” apply to the adjustment of the RX audio filter in the DATA mode, Menu items “081” through “084” apply to the adjustment of the RX audio filter in the FM mode, Menu items “090” through “093” apply to the adjustment of the RX audio filter in the RTTY mode, and Menu items “099” through “102” apply to the adjustment of the RX audio filter in the SSB mode
3. Press the **[SELECT]** button.
4. Rotate the **[VFO-B/CLAR]** knob (or press the **▲/▼** button) to adjust the receiver audio response as desired.
5. Press the **[SELECT]** button, then press the **[MENU]** button to save the new setting and exit to normal operation.

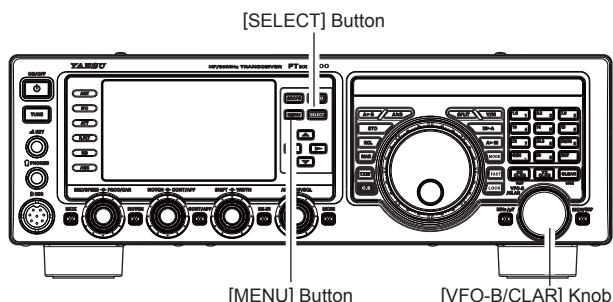

MODE	MENU ITEM	AVAILABLE VALUES
AM	050 AM LCUT FREQ	OFF/100(Hz) ~ 1000(Hz)
	051 AM LCUT SLOPE	6dB/oct / 18dB/oct
	052 AM HCUT FREQ	700(Hz) ~ 4000(Hz)/OFF
	053 AM HCUT SLOPE	6dB/oct / 18dB/oct
CW	057 CW LCUT FREQ	OFF/100(Hz) ~ 1000(Hz)
	058 CW LCUT SLOPE	6dB/oct / 18dB/oct
	059 CW HCUT FREQ	700(Hz) ~ 4000(Hz)/OFF
	060 CW HCUT SLOPE	6dB/oct / 18dB/oct
DATA	073 DATA LCUT FREQ	OFF/100(Hz) ~ 1000(Hz)
	074 DATA LCUT SLOPE	6dB/oct / 18dB/oct
	075 DATA HCUT FREQ	700(Hz) ~ 4000(Hz)/OFF
	076 DATA HCUT SLOPE	6dB/oct / 18dB/oct
FM	081 FM LCUT FREQ	OFF/100(Hz) ~ 1000(Hz)
	082 FM LCUT SLOPE	6dB/oct / 18dB/oct
	083 FM HCUT FREQ	700(Hz) ~ 4000(Hz)/OFF
	084 FM HCUT SLOPE	6dB/oct / 18dB/oct
RTTY	090 RTTY LCUT FREQ	OFF/100(Hz) ~ 1000(Hz)
	091 RTTY LCUT SLOPE	6dB/oct / 18dB/oct
	092 RTTY HCUT FREQ	700(Hz) ~ 4000(Hz)/OFF
	093 RTTY HCUT SLOPE	6dB/oct / 18dB/oct
SSB	099 SSB LCUT FREQ	OFF/100(Hz) ~ 1000(Hz)
	100 SSB LCUT SLOPE	6dB/oct / 18dB/oct
	101 SSB HCUT FREQ	700(Hz) ~ 4000(Hz)/OFF
	102 SSB HCUT SLOPE	6dB/oct / 18dB/oct

SSB/AM MODE TRANSMISSION

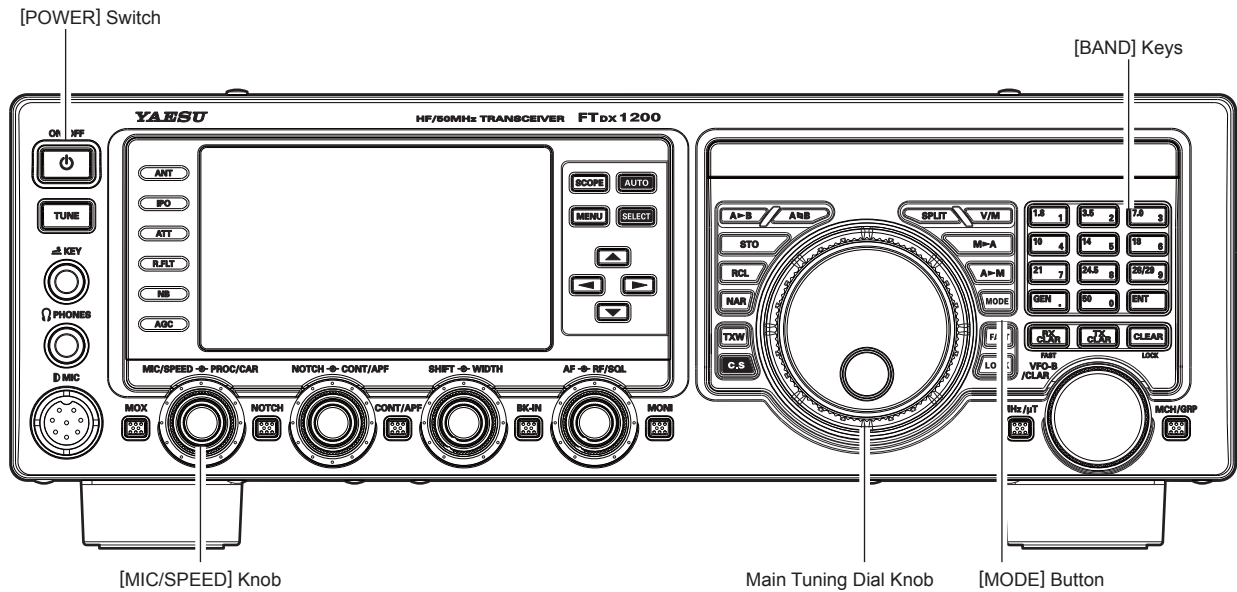

1. Press the **[BAND]** button corresponding to the Amateur band on which you wish to operate.



2. Press the **[MODE]** button to select the operating mode. Press and hold in this button to toggle to the alternate mode.

For example, *In the LSB or USB modes*, pressing and holding in this button toggles between “LSB” and “USB” mode.

ADVICE:

By convention, LSB is used in the 7 MHz and lower Amateur bands for SSB communication, and USB is used on the 14 MHz and higher bands (the 10 MHz band is used for CW and data modes only).

3. Rotate the Main Tuning Dial knob to adjust the operating frequency. Alternately, you may use the **[UP]/[DWN]** scanning buttons on the **MH-31B8** Hand Microphone to sweep up or down the current band.
4. Press the microphone **PTT** (Push To Talk) switch to begin transmission; speak into the microphone in a normal voice level.

ADVICE:

- The “” indicator will light up in the LED indicators area, confirming that transmission is in progress.
- When transmitting in the AM mode, set a maximum (carrier) power output of 25 Watts via the **[PROC/CAR]** knob.



25W

5. Adjust the microphone amplifier gain to match the microphone and your voice level: Press the **[▲/▼/◀/▶]** buttons to select the “**METER**”, then press the **[SELECT]** button to select “**ALC**”.

Close the **PTT** switch, and speak into the microphone in a normal voice level.

In the SSB mode, adjust the **[MIC/SPEED]** knob so that the ALC meter stays within the ALC zone of the meter (up to half scale deflection) on voice peaks.



Adjust to keep under this level

In the AM mode, adjust the **[MIC/SPEED]** knob so that the ALC meter does not deflect at voice peaks.

ADVICE:

The frequency display will show the relative microphone gain level for 3 seconds whenever the **[MIC/SPEED]** knob is turned.

6. Release the **PTT** switch at the end of your transmission. The transceiver will return to the receive mode.

SSB/AM MODE TRANSMISSION

ADVICE:

- ❑ ALC meter deflection may be caused by excessive drive power, but also by reflected power detected in the antenna system. If the impedance presented to the transceiver is other than 50 Ohms, ALC meter action may be observed that is not related to the proper setting of the [MIC/SPEED] knob. Therefore, we recommend that you make the [MIC/SPEED] knob adjustments into a dummy load or antenna system presenting impedance very close to 50 Ohms.
- ❑ **In the SSB mode**, you may set the desired power output via Menu item “177 TX MAX POWER”. The adjustment range is between 5 Watts and 100 Watts. You should always use the minimum power necessary to maintain reliable communications.
- ❑ When performing “on air” tests (such as the setup of microphone gain), be sure to check the frequency before transmitting, to avoid interference to others who may already be using the frequency.

- ❑ Four techniques for exercising Transmit/Receive control are provided on the FTdx1200. You may choose the technique(s) that best suit your operating needs:
 - Pressing the microphone **PTT** switch will engage the transmitter.
 - The rear panel **PTT** jack may be connected to a foot switch or other manual switching device in order to engage the transmitter.
 - Pressing the front panel [MOX] button will lock the transmitter on. Press the [MOX] button again to return to receive.
 - The VOX (Voice Operated Xmit) circuit will engage the transmitter automatically when you speak into the microphone. For details of VOX operation refer to page 73.

Adjusting the SSB TX Power Output

1. Press the [MENU] button to enter the Menu mode.
2. Rotate the [VFO-B/CLAR] knob (or press the ▲/▼ button) to select Menu item “177 TX MAX POWER”.
3. Press the [SELECT] button, then rotate the [VFO-B/CLAR] knob (or press the ▲/▼ button) to adjust the desired power output.

ADVICE:

The value (5 -100) displayed in the Menu list is a relative percentage of the maximum TX power available in the selected mode. It is not the true TX output level.

4. Press the [SELECT] button, then press the [MENU] button to save the new setting and exit to normal operation.

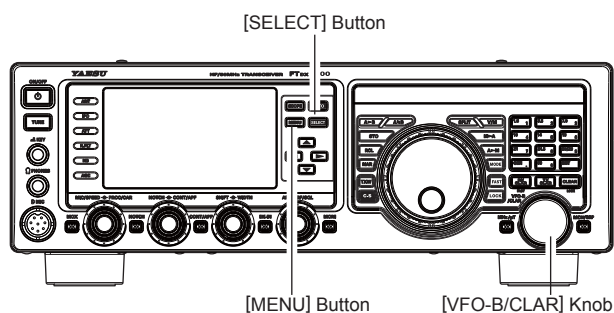

ADVICE:

The TX Power Output setting cannot be stored in any of the memory channels.

USING THE AUTOMATIC ANTENNA TUNER

The Automatic Antenna Tuner (hereinafter referred to as the “ATU”) built into each **FTDx1200** is designed to ensure a 50-Ohm load for the final amplifier stage of the transmitter. We recommend that the ATU be used whenever you operate on the **FTDx1200**.

ADVICE:

- ❑ Because the ATU of the **FTDx1200** is located inside the station, it only adjusts the impedance presented to the transceiver at the station end of your coaxial cable feedline. It does not “tune” the SWR at the antenna feed point itself. When designing and building your antenna system, we recommend that every effort be made to ensure a low SWR at the antenna feed point.
- ❑ The ATU of the **FTDx1200** includes 100 memories for tuning data. Eleven of these memories are allocated, one per Amateur band, so that each band has at least one setting preset for use on that band. The remaining 89 memories are reserved for the 89 most-recent tuning points, for quick frequency change without the need to retune the ATU.
- ❑ The ATU in the **FTDx1200** is designed to match impedances within the range of 16.5 Ohms to 150 Ohms, corresponding to an SWR of 3:1 or less on the 160 through 6 meter amateur bands. Accordingly, simple non-resonant whip antennas, along with random-length wires and the “G5RV” antenna (on most bands) may not be within the impedance matching range of the ATU.

ATU OPERATION

1. Use the Main Tuning Dial knob to set the radio to the desired operating frequency within the Amateur band.
2. Press the [**TUNE**] button momentarily to place the ATU in the transmit line (no adjustment/tuning will occur yet). The “**TUNER**” icon will appear in the display.

QUICK POINT:

The momentary press of the [**TUNE**] button will turn the tuner on, and the microprocessor will automatically select the tuning point closest to the current operating frequency.

3. Press and hold in the [**TUNE**] button for one second to begin automatic tuning. The transmitter will be engaged, and the “**TUNER**” icon will blink while tuning is in progress. When the optimum tuning point has been reached, the radio will return to receive, and the “**TUNER**” icon will again glow steadily (instead of blinking).
4. To disconnect the ATU from the transmit line, press the [**TUNE**] button momentarily. The “**TUNER**” icon will turn off, confirming that the ATU has been turned off. In the “Off” mode, the transceiver will be directly connected to the coaxial cable connected to your antenna, and will respond to whatever impedance is present at the station end of the coax.

ADVICE:

The ATU circuit is located between the final amplifier and the rear-panel antenna jack; reception is not affected by the ATU.

[**TUNE**] Button

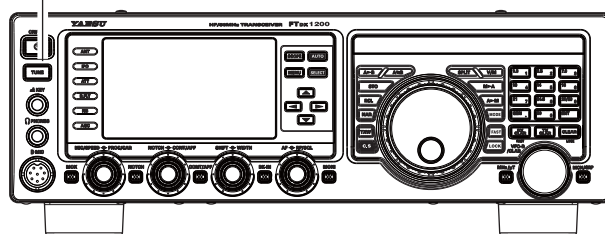

QUICK POINTS:

As shipped from the factory, only one ATU alignment point is saved on each Amateur band. This was memorized during the final alignment and performance verification stages on the production line.

NOTE:

Please check the operating frequency before beginning the tuning process, to be sure you are not interfering with others who may already be using the frequency.

TERMINOLOGY:

Antenna Tuner Memories: The microprocessor of the ATU makes a note of the selected tuning capacitors and inductors, and stores the data for each 10 kHz window in which tuning has occurred. This eliminates the need to re-tune every time you return to a frequency on which you have already completed the tuning process.

USING THE AUTOMATIC ANTENNA TUNER

ABOUT ATU OPERATION

Figure 1 depicts a situation where normal tuning via the ATU has been successfully completed, and the tuning data has been stored in the ATU memory. The antenna system as seen by the transmitter is shown.

In Figure 2, the operator has changed frequency, and the “**HI-SWR**” icon has appeared. The operator presses and holds in the [TUNE] button for two seconds to begin impedance matching using the ATU.

If a high SWR condition exists (above 3:1), corrective action must be taken in the antenna system to bring the impedance closer to 50 Ohms. The ATU will refuse to memorize settings on frequencies where the SWR exceeds 3:1. A High SWR may indicate a mechanical failure in the feed system, and can lead to the generation of spurious signals causing TVI, etc.

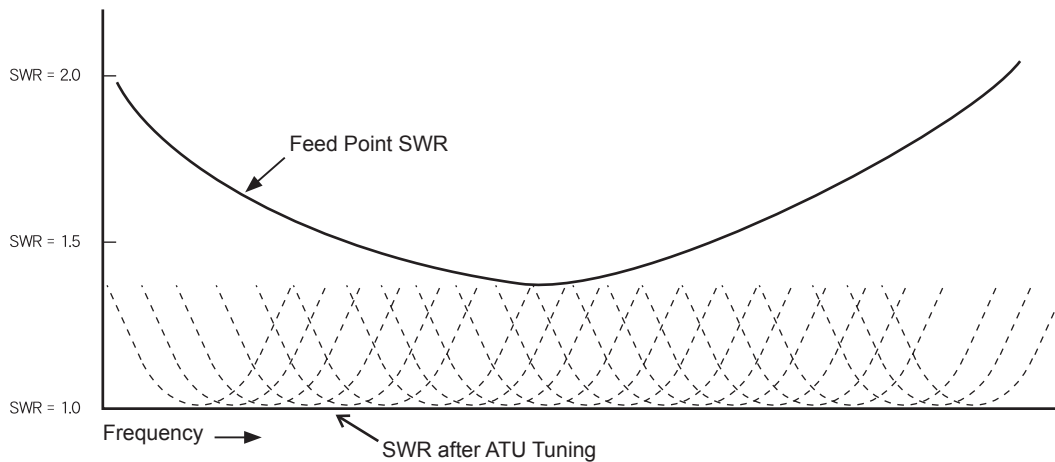

FIGURE 1

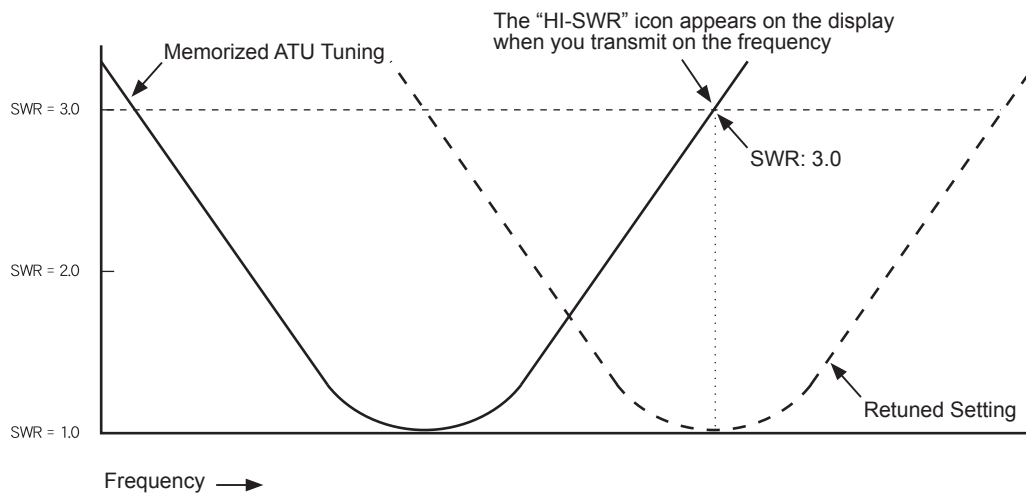

FIGURE 2

About ATU Memories

SWR (After tuning) Less than 1.5:1

The tuner settings are stored in the ATU memory.

SWR (After tuning) Greater than 1.5:1

Tuning data will not be retained in memory. If you return to the same frequency, the tuning process must be repeated.

SWR (After tuning) Greater than 3:1

The “**HI-SWR**” icon will light up, and the tuner settings, if achieved, will not be memorized. Please investigate the high SWR condition and resolve the problem before attempting further operation using this antenna.

ENHANCING TRANSMIT SIGNAL QUALITY

PARAMETRIC MICROPHONE EQUALIZER (SSB/AM/FM MODE)

The **FTdx1200** includes a unique Three-Band Parametric Microphone Equalizer that provides precise, independent control over the low, mid and treble ranges in your voice waveform. You may utilize one group of settings when the speech processor is off and an alternate group of settings when the speech processor is on. The speech processor feature is described in the next chapter.

QUICK POINT:

The Parametric Equalizer is a unique technique for adjusting the signal quality. The three audio ranges may be adjusted so precisely, it is possible to craft an audio response that provides a natural and pleasant sound that you may not have ever experienced before. Alternately, the effective “talk power” can be significantly enhanced.

The aspects of configuration that you may adjust on the Parametric Equalizer are:

Center Frequency: The center frequency of each of the three bands may be adjusted.

Gain: The amount of enhancement (or suppression) within each band may be adjusted.

Q: The bandwidth over which the equalization is applied may be adjusted.

Setup of the Parametric Microphone Equalizer

1. Connect the microphone to the **MIC** jack.
2. Set the RF output power to minimum value via Menu item “177 TX MAX POWER”, so you will not cause interference to other users while making adjustments.

ADVICE:

- We recommend that you connect a dummy load to one of the Antenna jacks, and monitor your signal on a separate receiver, to prevent interference to other users.
 - You will have the best chance of hearing the effects of adjustments if you wear headphones (connected to the monitor receiver) while listening to your transmitted signal.
3. To adjust the Parametric Microphone Equalizer while the speech processor is disabled, press the [**▲/▼/◀/▶**] button to select the “**MIC EQ**”, then press the [**SELECT**] button to select “**ON**”.



To adjust the Parametric Microphone Equalizer with the speech processor engaged, press the [**▲/▼/◀/▶**] button to select the “**PROC**”, then press the [**SELECT**] button to select “**ON**”.



4. Press the [**MONI**] button, if you want to listen on the **FTdx1200** internal monitor.
5. Press the [**MENU**] button. The Menu list will appear in the display.
6. Rotate the [**VFO-B/CLAR**] knob (or press the **▲/▼** button) to find the “**EQ**” Menu area, containing Menu items “159” through “167”; these parameters apply to the adjustment of the Parametric Microphone

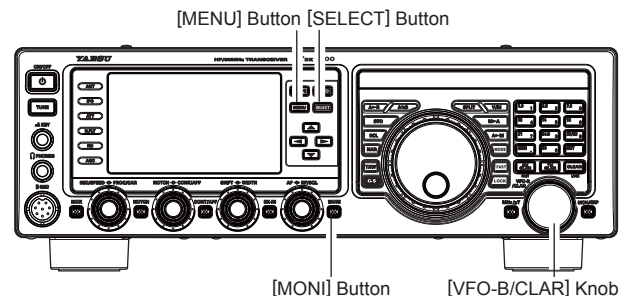

Equalizer when the speech processor is disabled. Menu items “168” through “176” apply to the adjustment of the Parametric Microphone Equalizer when the speech processor is engaged.

7. Press the [**SELECT**] button, then rotate the [**VFO-B/CLAR**] knob (or press the **▲/▼** button) to perform adjustments to a particular Menu item.
8. Close the **PTT** switch, and speak into the microphone while listening to the effect of the changes you are making. Because the overall effect on the sound will change with each adjustment area, to be sure that you are achieving the optimum settings, you should make several passes through each adjustment area.
9. When you have completed all adjustments, press the [**SELECT**] button, then press the [**MENU**] button to save the new settings and exit to normal operation. If you only press the [**MENU**] button momentarily to exit, none of the changes you performed will be stored.

ADVICE:

To roll off excessive bass response in a wide-range studio microphone, try putting a 10 dB null at 100 Hz with a bandwidth of “1” or “2”, do about a 3 dB null centered on 800 Hz with a bandwidth of “3,” and then put an 8 dB peak centered on 2100 Hz with a bandwidth of “1.” These are starting recommendations; each microphone and user’s voice will be different, often requiring different settings.

ENHANCING TRANSMIT SIGNAL QUALITY

PARAMETRIC MICROPHONE EQUALIZER (SSB/AM/FM MODE)

Activating the Parametric Microphone Equalizer

1. Adjust the [MIC/SPEED] knob, as described on page 63.
2. Press the [▲/▼/◀/▶] button to select the “MIC EQ”, then press the [SELECT] button to select “ON”. If you use the Parametric Microphone Equalizer with the speech processor engaged, press the [▲/▼/◀/▶] buttons to select the “PROC”, then press the [SELECT] button to select “ON”. The “MIC EQ” (and “PROC”) will appear in the display, confirming that the Parametric Microphone Equalizer is engaged.
3. Press the PTT switch on the microphone, and speak into the microphone in a normal voice level.
4. To switch the Parametric Microphone Equalizer off, press the [SELECT] button repeatedly until the “MIC EQ” icon disappears.

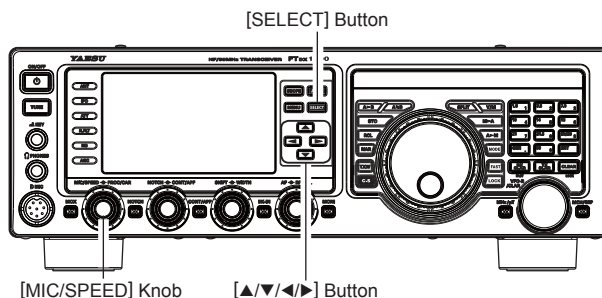

3-STAGE PARAMETRIC EQUALIZER ADJUSTMENTS (SPEECH PROCESSOR: "OFF")		
Center Frequency	"159 PRMTRC EQ1 FREQ"	"100" (Hz) ~ "700" (Hz)
	"162 PRMTRC EQ2 FREQ"	"700" (Hz) ~ "1500" (Hz)
	"165 PRMTRC EQ3 FREQ"	"1500" (Hz) ~ "3200" (Hz)
Parametric Gain	"160 PRMTRC EQ1 LEVEL"	(Low) "-20" (dB) ~ "+10" (dB)
	"163 PRMTRC EQ2 LEVEL"	(Mid) "-20" (dB) ~ "+10" (dB)
	"166 PRMTRC EQ3 LEVEL"	(High) "-20" (dB) ~ "+10" (dB)
Q (Bandwidth)	"161 PRMTRC EQ1 BWTH"	(Low) "1" ~ "10"
	"164 PRMTRC EQ2 BWTH"	(Mid) "1" ~ "10"
	"167 PRMTRC EQ3 BWTH"	(High) "1" ~ "10"

3-STAGE PARAMETRIC EQUALIZER ADJUSTMENTS (SPEECH PROCESSOR: "ON")		
Center Frequency	"168 P-PRMTRC EQ1-FREQ"	"100" (Hz) ~ "700" (Hz)
	"171 P-PRMTRC EQ2-FREQ"	"700" (Hz) ~ "1500" (Hz)
	"174 P-PRMTRC EQ3-FREQ"	"1500" (Hz) ~ "3200" (Hz)
Parametric Gain	"169 P-PRMTRC EQ1-LEVEL"	(Low) "-20" (dB) ~ "+10" (dB)
	"172 P-PRMTRC EQ2-LEVEL"	(Mid) "-20" (dB) ~ "+10" (dB)
	"175 P-PRMTRC EQ3-LEVEL"	(High) "-20" (dB) ~ "+10" (dB)
Q (Bandwidth)	"170 P-PRMTRC EQ1-BWTH"	(Low) "1" ~ "10"
	"173 P-PRMTRC EQ2-BWTH"	(Mid) "1" ~ "10"
	"176 P-PRMTRC EQ3-BWTH"	(High) "1" ~ "10"

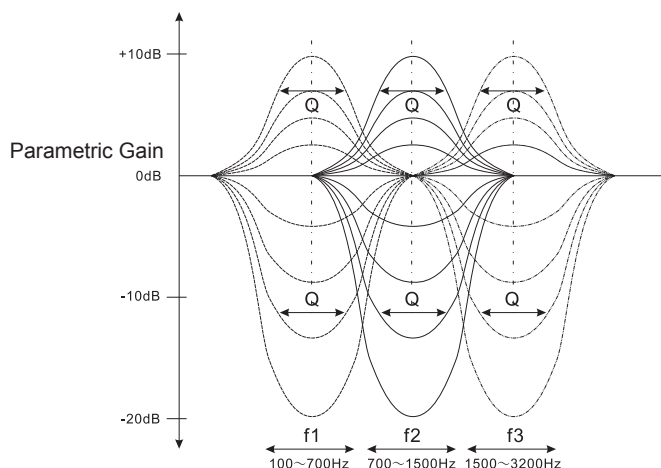

ENHANCING TRANSMIT SIGNAL QUALITY

USING THE SPEECH PROCESSOR (SSB MODE)

The **FTdx1200** Speech Processor is designed to increase “talk power” by increasing the average power output (via a sophisticated compression technique) and adjusting the audio quality to the menu settings (“168 P-PRMTRC EQ1 FREQ”, “171 P-PRMTRC EQ2 FREQ”, “174 P-PRMTRC EQ3 FREQ”). The result is improved intelligibility when conditions are difficult.

1. Adjust the **[MIC/SPEED]** knob, as described on page 63.
2. Press the **[▲/▼/◀/▶]** button to select the “**METER**”, then press the **[SELECT]** button to select “**COMP**” (Compression) meter.
3. Press the **[▲/▼/◀/▶]** button to select the “**PROC**”, then press the **[SELECT]** button to select “**ON**”.
The “**PROC**” will appear in the display, confirming that the Speech Processor is engaged.
4. Press the **PTT** switch on the microphone, and speak into the microphone in a normal voice level.
5. Adjust the **[PROC/CAR]** knob to set the compression level within the 5 dB to 10 dB range.



5 ~ 10dB

6. To switch the Speech Processor off, press the **[SELECT]** button once more. The “**PROC**” will turn off, confirming that the Speech processor is turned off.

ADVICE:

- You may set the RF power output via the Menu item “177 TX MAX PWR”, whether or not the Speech Processor is engaged.
- You may adjust the Parametric Microphone Equalizer when the speech processor is engaged, using Menu Items “168” through “176”. See page 124 for details.

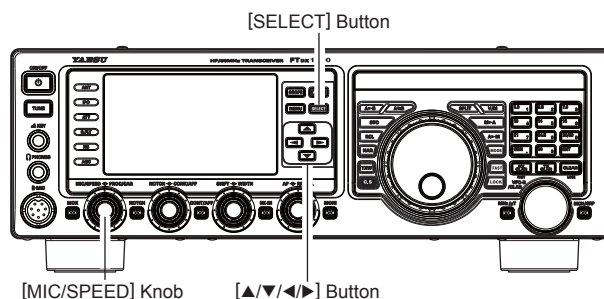

ENHANCING TRANSMIT SIGNAL QUALITY

ADJUSTING THE SSB TRANSMITTED BANDWIDTH (SSB MODE)

For transmission on SSB, a default bandwidth of 2.4 kHz is provided. This bandwidth provides reasonable fidelity along with good talk power, and is typical of the bandwidth used for decades for SSB transmission. The bandwidth may be varied by the operator, to provide different levels of fidelity or talk power, according to your preferences.

Here are the steps to adjust the SSB transmit bandwidth:

1. Press the **[MENU]** button to engage the Menu.
2. Rotate the **[VFO-B/CLAR]** knob (or press the **▲/▼** button) to select Menu item “104 SSB TX BPF”.
3. Press the **[SELECT]** button, then rotate the **[VFO-B/CLAR]** knob (or press the **▲/▼** button) to select the desired bandwidth. The available selections are: 100-3000 Hz, 100-2900 Hz, 200-2800 Hz, 300-2700 Hz, 400-2600 Hz and 3000 WB. The default is 300-2700 Hz. A wider bandwidth will provide greater fidelity. A narrow bandwidth will compress the available transmitter power into less spectrum, resulting in more “talk power” for DX pile-ups.
4. Press the **[SELECT]** button, then press the **[MENU]** button to save the new setting and exit to normal operation.

ADVICE:

The Transmit Monitor function is a very helpful way to confirm the effect that changing the bandwidth will have on fidelity. By Pressing the **[MONI]** button, you will be able to hear the difference in sound quality as you make changes.

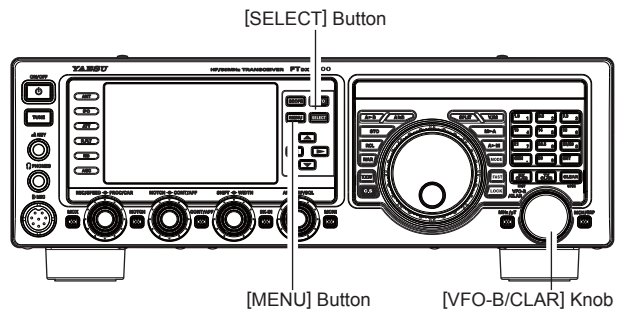

QUICK POINTS:

The higher fidelity associated with wide bandwidth will be particularly enjoyable on the low bands during local rag-chew QSOs.

TRANSMITTER CONVENIENCE FEATURES

VOICE MEMORY (SSB/AM/FM MODES: REQUIRES OPTIONAL DVS-6 AND FH-2)

You may utilize the Voice Memory capability of the FTdx1200 for repetitive messages. The Voice Memory system includes five memories capable of storing up to 20 seconds of voice audio each. The maximum that any memory can hold is 20 seconds.

Voice Memory Operation from the FH-2 Remote Control Keypad

You may also utilize the Voice Memory capability of the FTdx1200 from the optional FH-2 Remote Control Keypad, which plugs into the rear panel's REM jack.

Recording Your Own Voice in Memory

1. Select the LSB, USB, AM, or FM mode using the front panel [MODE] buttons.
2. Adjust the [MIC/SPEED] knob, as described on page 63.
3. Press the [MEM] key on the FH-2. A blinking "REC" icon will appear in the display.

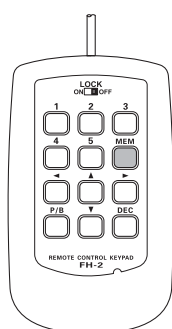

4. Press any of the FH-2's keys numbered [1] through [5] to select that memory storage register.

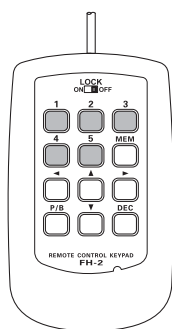

ADVICE:

If you do not press the PTT key (see next step) within five seconds, the memory storage process will be cancelled.

5. Press the microphone's PTT switch momentarily. The "REC" icon will glow steadily and recording will begin.
6. Speak into the microphone in a normal voice level to record the message (such as "CQ DX, CQ DX, this is W 6 Delta X-Ray Charlie, W 6 Delta X-Ray Charlie, Over"). Remember that the time limit for recording any message is 20 seconds.

7. Press the FH-2 [MEM] key to terminate the message storage process.

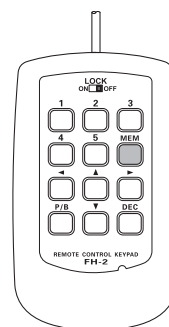

Checking Your Recording

1. Be sure that the front panel [MOX] and [BK-IN] button are "Off".
2. Press the FH-2 [1] ~ [5] key (whichever one you just recorded in). The "PLAY" icon will appear in the display and you will hear the contents of the Voice Memory you just recorded.

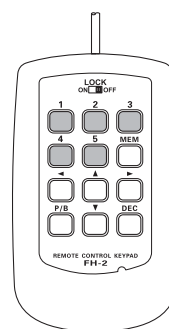

ADVICE:

You may adjust the playback level of the recording via Menu item "016 RX OUT LEVEL".

TRANSMITTER CONVENIENCE FEATURES

VOICE MEMORY (SSB/AM/FM MODES: REQUIRES OPTIONAL DVS-6 AND FH-2)

Transmitting the Recorded Message

1. Select the LSB, USB, AM, or FM mode using the front panel [MODE] buttons.
2. Press the front panel [BK-IN] button.
3. Press the FH-2 [1] ~ [5] key (whichever one you just recorded in). A “PLAY” icon will appear in the display and the message will be transmitted.

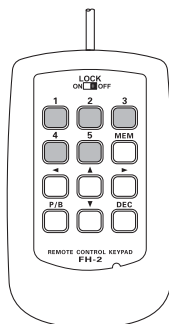

ADVICE:

You may adjust the transmit (audio) level of the recording via Menu item “017 TX OUT LEVEL”.

TRANSMITTER CONVENIENCE FEATURES

VOX (SSB/AM/FM MODES: AUTOMATIC TX/RX SWITCHING USING VOICE CONTROL)

Instead of using the microphone **PTT** switch or the front panel **[MOX]** switch to activate the transmitter, the VOX (Voice Operated TX/RX Control) system provides hands-free, automatic activation of the transmitter, based on voice input into the microphone.

1. Press the **[▲/▼/◀/▶]** button to select the “**VOX**”, then press the **[SELECT]** button to select “**ON**”. The “**VOX**” will appear in the display.
2. Without pressing the **PTT** switch, speak into the microphone in a normal voice level. When you start speaking, the transmitter should be activated automatically. When you finish speaking, the transceiver should return to the receive mode (after a short delay).
3. To cancel VOX and return to **PTT** operation, press the **[SELECT]** button once more. The “**VOX**” will turn off, signifying that the VOX circuitry has been turned off.

ADVICE:

- ❑ The VOX Gain may be adjusted to prevent accidental transmitter activation in a noisy environment. To adjust the VOX Gain:
 - 1) Activate the VOX circuitry, if necessary.
 - 2) Press the **[MENU]** button to engage the Menu mode.
 - 3) Rotate the **[VFO-B/CLAR]** knob (or press the **▲/▼** button) to select Menu item “181 VOX GAIN”, then press the **[SELECT]** button.
 - 4) While speaking into the microphone, rotate the **[VFO-B/CLAR]** knob (or press the **▲/▼** button) to the point where the transmitter is quickly activated by your voice, without background noise causing the transmitter to activate.
 - 5) When you are satisfied with the setting, press the **[SELECT]** button, then press the **[MENU]** button to save the new setting and exit to normal operation.
- ❑ The “Hang-Time” of the VOX system (the transmit/receive delay after the cessation of speech) may also be adjusted via the Menu mode. The default delay is 500 msec. To set a different delay time:
 - 1) Activate the VOX circuitry, if necessary.
 - 2) Press the **[MENU]** button to engage the Menu mode.
 - 3) Rotate the **[VFO-B/CLAR]** knob (or press the **▲/▼** button) to select Menu item “182 VOX DELAY”, then press the **[SELECT]** button.
 - 4) Rotate the **[VFO-B/CLAR]** knob while saying a brief syllable like “Ah” and listening to the hang time for the desired delay.
 - 5) When you are satisfied with the setting, press the **[SELECT]** button, then press the **[MENU]** button to save the new setting and exit to normal operation.
- ❑ The Anti-Trip setting adjusts the level of negative receiver audio feedback to the microphone, to prevent receiver audio from activating the transmitter (via the microphone). This setting can also be adjusted via Menu item “183 ANTI VOX GAIN”.
- ❑ VOX operation may be engaged on either Voice modes (SSB/AM/FM) or on AFSK-based Data modes. Use Menu item “180 VOX SELECT” (the selections are “MIC” and “DATA”).

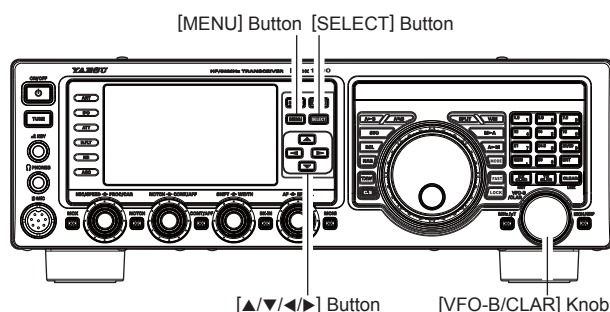

TRANSMITTER CONVENIENCE FEATURES

MONITOR (SSB/AM/FM MODES)

You may listen to the quality of your transmitted signal using the Monitor feature.

1. Press the [**MONI**] button. The “**MONI**” will appear on the TFT display.
2. During transmission, rotate the [**MONI**] knob to adjust the audio level in the Headphones or speaker. Clockwise rotation of this knob will increase the volume level.
3. To switch the Monitor off again, press the [**MONI**] button once more. Confirming that the Monitor is now disengaged.

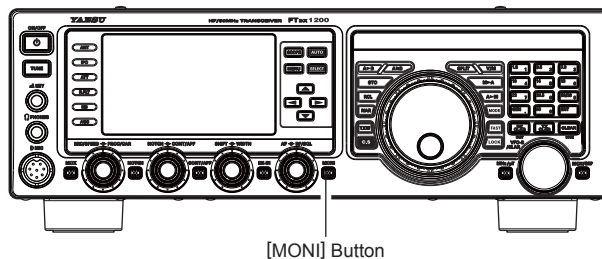

ADVICE:

- Because the Monitor feature samples the transmitter IF signal, it can be very useful for checking the adjustment of the Speech Processor or Parametric Equalizer on SSB, and for checking the general signal quality on AM and FM.

ADVICE:

- To adjust the Monitor level:
 - 1) Activate the MONI circuitry, if necessary.
 - 2) Press and hold in the [**MONI**] button for one second to enter Menu item “036 MONITOR LEVEL”.
 - 3) Press the [**SELECT**] button.
 - 4) While speaking into the microphone, rotate the [**VFO-B/CLAR**] knob (or press the **▲/▼** button) to adjust the monitor level.
 - 5) When you are satisfied with the setting, press the [**SELECT**] button, then press the [**MENU**] button to save the new setting and exit to normal operation.

TRANSMITTER CONVENIENCE FEATURES

SPLIT OPERATION USING THE TX CLARIFIER

For split TX/RX operation in “casual” pile-ups, where the split is less than 10 kHz, the TX Clarifier (Offset Tuning) feature may be utilized.

1. Press the [TX CLAR] button. The “TX” icon will appear in the TFT display.

QUICK POINT:

The Clarifier is frequently used for receiver offset tuning. However, for DX pile-ups where the DX station is using a split of less than 10 kHz, the TX Clarifier function is usually the quickest way to set the transmitter to the desired offset frequency.

2. Rotate the [VFO-B/CLAR] knob to set the desired transmitter offset. A maximum split of ± 9.999 kHz may be set.
3. To exit from TX Clarifier operation, press the [TX CLAR] button once more. The “TX” icon will disappear from the display.

ADVICE:

- ❑ When listening to a “pile-up” calling a DX station, in order to find the station currently being worked, you may press the [RX CLAR] button. Then, use the [VFO-B/CLAR] knob to zero in on the station calling the DX (use the SPOT function on CW for precise alignment of your frequency). You may then press the [RX CLAR] button again to cancel the RX Clarifier, and return to reception on the DX station’s frequency.
- ❑ Just as with receiver Clarifier operation, the amount of offset from the original VFO frequency will appear in the display.
- ❑ As with receiver Clarifier operation, when you turn the TX Clarifier off, the last-used offset is remembered, and will be available if you turn the TX Clarifier back on. To clear the Clarifier offset, press the [CLEAR] button.

QUICK POINT:

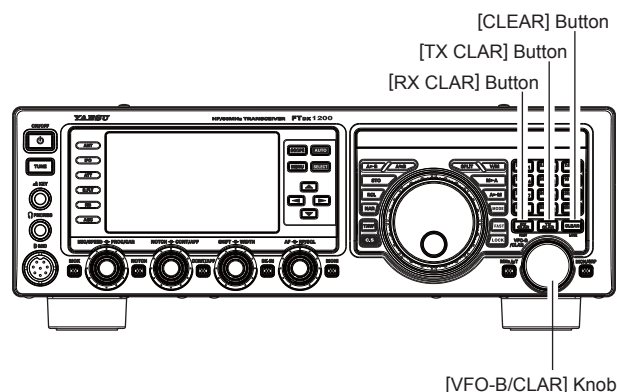

When attempting to work a DX station on CW in a split frequency pile-up, remember that a large number of other stations may also be using Yaesu transceivers with capability similar to that of your FT-DX1200. On the DX side of the pile-up, everyone calling precisely on the same CW frequency will sound like a single tone! So you may have more success if you use the RX Clarifier to find a *hole* in the pile-up, instead of trying to zero-beat the last station worked by the DX station.

Clarifier Offset Indicator

A visual depiction of the relative offset of the Clarifier may be displayed, using the Tuning Offset Indicator.

1. Press the [MENU] button to engage the Menu mode.
2. Rotate the [VFO-B/CLAR] knob (or press the ▲/▼ button) to select Menu item “O11 BAR DISPLAY SELECT”.
3. Press the [SELECT] button, then rotate the [VFO-B/CLAR] knob (or press the ▲/▼ button) to select “CLAR” from the available choices; the factory default is “CW TUNE”.
4. Press the [SELECT] button, then press the [MENU] button to save the new setting and exit to normal operation.



Plus (+) Offset



TX Frequency = RX Frequency



Minus (-) Offset

The powerful CW operating capabilities of the **FTdx1200** permit operation using an electronic keyer paddle, a “straight key”, or a computer-based keying device.

SETUP FOR STRAIGHT KEY (AND STRAIGHT KEY EMULATION) OPERATION

Before starting, connect your key line(s) to the front and/or rear panel **KEY** jack(s). Be sure the **[BK-IN]** button is turned off for now.

1. Press the **[MODE]** button to engage CW operation. The “**USB CW**” icon will appear in the display. The “**MONI**” icon will appear in the TFT display; and the CW monitor is activated.

ADVICE:

If you press and hold the **[MODE]** button, you will engage the “CW Reverse” mode, whereby the “opposite” sideband injection is used, compared to the “normal” sideband. The “**LSB CW**” icon will appear in the display if you select CW Reverse.

2. Rotate the Main Tuning Dial knob to select the desired operating frequency.
3. Press the **[BK-IN]** button to engage automatic activation of the transmitter when you close the CW key. The “**BK-IN**” icon will appear in the TFT display.

ADVICE:

- When you close your CW key, the transmitter will automatically be activated, and the CW carrier will be transmitted. When you release the key, transmission will cease, and after a brief delay, receive will be restored. The delay time is user-programmable per the discussion on page 83.
 - As shipped from the factory, the **FTdx1200** TX/RX system for CW is configured for “Semi-break-in” operation. However, using Menu item “063 CW BK-IN”, you may change this setup for full break-in (QSK) operation, whereby the switching is quick enough to hear incoming signals in the spaces between the dots and dashes of your transmission. This may prove very useful during contest and traffic handling operations.
4. Operation using your CW key may now proceed.

ADVICE:

- You may adjust the CW sidetone audio level setting of Menu item “036 MONITOR LEVEL”.
To adjust the Monitor level:
 - 1) Activate the **MONI** circuitry, if necessary.

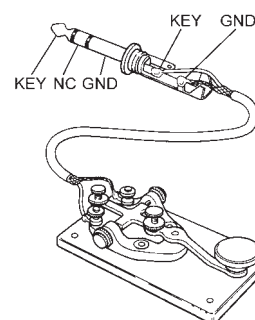
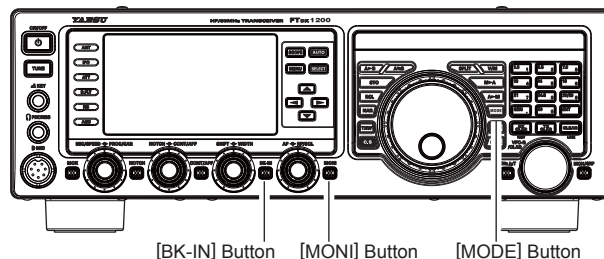

- 2) Press and hold in the **[MONI]** button for one second to enter the Menu item “036 MONITOR LEVEL”.
 - 3) Press the **[SELECT]** button.
 - 4) While keying, rotate the **[VFO-B/CLAR]** knob (or press the **▲/▼** button) to adjust the monitor level.
 - 5) When you are satisfied with the setting, press the **[SELECT]** button, then press the **[MENU]** button to save the new setting and exit to normal operation.
- If you set the **[BK-IN]** button to Off, you may practice sending CW with the sidetone only, without having the signal go out over the air.
 - If you reduce power via the Menu item “177 TX MAX POWER”, the ALC meter reading will increase; this is normal and does not indicate any problem whatsoever (because increased ALC voltage is being used to lower the power).

TERMINOLOGY:

Semi-break-in

This is a pseudo-“VOX” mode used on CW, whereby the closure of the CW key will engage the transmitter, and release of the key will allow the receiver to recover after a short delay. No signals will be heard during the spaces between dots and dashes (unless the sending speed is extremely slow).

Full break-in

Full break-in (also known as “Full QSK”) involves very fast switching between transmit and receive, incoming signals may be heard between the dots and dashes as you send them. This allows you to hear a station that suddenly starts transmitting on your frequency, while you are in the midst of a transmission.

CW MODE OPERATION

USING THE BUILT-IN ELECTRONIC KEYS

Connect the cable from your keyer paddle to the front or rear panel **KEY** jack.

1. Press the **[MODE]** button to engage CW operation. The “**USB CW**” icon will appear in the display. The “**MONI**” icon will appear in the TFT display; and the CW monitor is activated.

ADVICE:

If you press the “CW” mode, you will engage the “CW Reverse” mode, whereby the “opposite” side-band injection is used, compared to the “normal” sideband. The “**LSB CW**” icon will appear in the display if you select CW Reverse.

2. Rotate the Main Tuning Dial knob to select the desired operating frequency.
3. Press the **[▲/▼/◀/▶]** button to select the “**KEYER**”, then press the **[SELECT]** button to select “ON”. The “**KEYER**” will appear in the display, confirming that the built-in Electronic Keyer is now active.
4. Rotate the **[MIC/SPEED]** knob to set the desired sending speed (4 ~ 60 WPM). Clockwise rotation of the **[MIC/SPEED]** knob will increase the keying speed.

ADVICE:

- The display will show the keying speed for 3 seconds whenever the **[MIC/SPEED]** knob is turned.
 - When you press either the “Dot” or “Dash” side of your paddle, the CW keying tone will automatically be generated.
5. Press the **[BK-IN]** button to engage automatic activation of the transmitter when you press either the “Dot” or “Dash” side of your paddle. The “**BK-IN**” icon will appear in the TFT display.
 6. CW operation utilizing your paddle may now commence.

ADVICE:

When you utilize your keyer paddle, the transmitter will automatically be activated, and the CW characters (or a string of dots and dashes) will be transmitted. When you release the keyer paddle contacts, transmission will cease, and reception will be restored after a brief delay. The delay time is user-programmable, per the discussion on page 83.

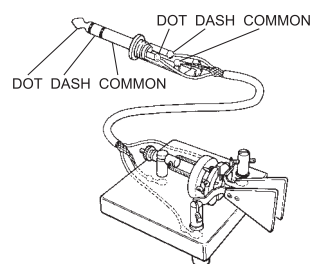
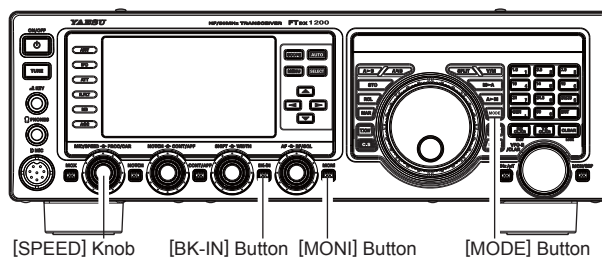

ADVICE:

- You may adjust the CW sidetone audio level setting of Menu item “036 MONITOR LEVEL”.
To adjust the Moni Level:
 - 1) Activate the MONI circuitry, if necessary.
 - 2) Press and hold in the **[MONI]** button for one second to enter the Menu item “036 MONITOR LEVEL”.
 - 3) Press the **[SELECT]** button.
 - 4) While keying, rotate the **[VFO-B/CLAR]** knob (or press the **▲/▼** button) to adjust the monitor level.
 - 5) When you are satisfied with the setting, press the **[SELECT]** button, then press the **[MENU]** button to save the new setting and exit to normal operation.
- If you set the **[BK-IN]** button to Off, you may practice sending CW with the sidetone only, without having the signal go out over the air.
- If you reduce power via the Menu item “177 TX MAX POWER”, the ALC meter reading will increase; this is normal and does not indicate any problem whatsoever (because increased ALC voltage is being used to lower the power).

USING THE BUILT-IN ELECTRONIC KEYS

Full Break-in (QSK) Operation

As shipped from the factory, the **FTdx1200** TX/RX system for CW is configured for “Semi-break-in” operation. However, this setup may be changed to full break-in (QSK) operation using Menu item “063 CW BK-IN”. With full break-in QSK, the TX/RX switching is quick enough to hear incoming signals in the spaces between the dots and dashes of your transmission.

1. Press the **[MENU]** button to engage the Menu.
2. Rotate the **[VFO-B/CLAR]** knob (or press the **▲/▼** button) to select Menu item “063 CW BK-IN”.
3. Press the **[SELECT]** button, then rotate the **[VFO-B/CLAR]** knob (or press the **▲/▼** button) to set this Menu item to “FULL”.
4. When your adjustments are complete, press the **[SELECT]** button, then press the **[MENU]** button to save the new setting and exit to normal operation.

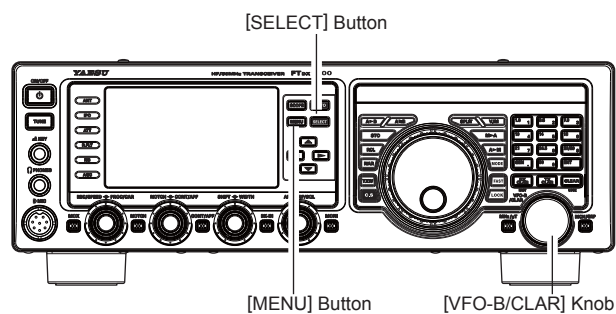

A number of interesting and useful features are available during Electronic Keyer operation.

Setting the Keyer Weight (Dot/Dash) Ratio

This Menu item may be used to adjust the dot/dash ratio for the built-in Electronic Keyer. The default weighting is 3:1 (a dash is three times longer than a dot).

1. Press the **[MENU]** button to engage the Menu.
2. Rotate the **[VFO-B/CLAR]** knob (or press the **▲/▼** button) to select Menu item “023 CW WEIGHT”.
3. Press the **[SELECT]** button, then rotate the **[VFO-B/CLAR]** knob (or press the **▲/▼** button) to set the weight to the desired value. The available adjustment range is a Dot/Dash ratio of 2.5 ~ 4.5 (default value: 3.0).
4. When you are finished, press the **[SELECT]** button, then press the **[MENU]** button to save the new setting and exit to normal operation.

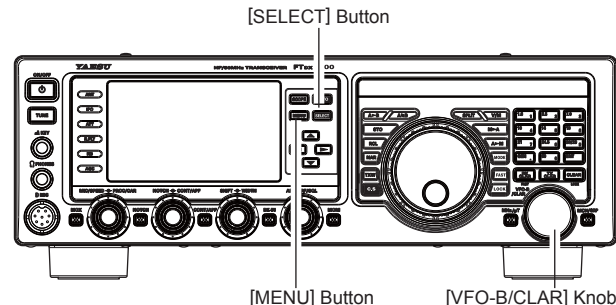

USING THE BUILT-IN ELECTRONIC KEYS

Selecting the Keyer Operating Mode

The configuration of the Electronic Keyer may be customized independently for the front and rear **KEY** jacks of the **FTdx1200**. This permits utilization of Automatic Character Spacing (ACS), if desired. This permits the use of an electronic keyer via the front jack and a straight key or computer-driven keying line via the rear panel jack.

1. Press the **[MENU]** button to engage the Menu.
2. Rotate the **[VFO-B/CLAR]** knob (or press the **▲/▼** button) to select Menu item "018 F KEYSER TYPE" (for the front **KEY** jack) or "020 R KEYSER TYPE" (for the rear-panel **KEY** jack).
3. Press the **[SELECT]** button, then rotate the **[VFO-B/CLAR]** knob (or press the **▲/▼** button) to set the keyer to the desired mode. The available selections are:

OFF: The built-in Electronic Keyer is turned off ("straight key" mode).

BUG: Dots will be generated automatically by the keyer, but dashes must be sent manually.

ELEKEY: Both dots and dashes will be generated automatically when using a paddle.

ACS: Same as "ELEKEY" except that the spacing between characters is precisely set by the keyer to be the same length as a dash (three dots in length)

4. When you are finished, press the **[SELECT]** button, then press the **[MENU]** button to save the new setting and exit to normal operation.

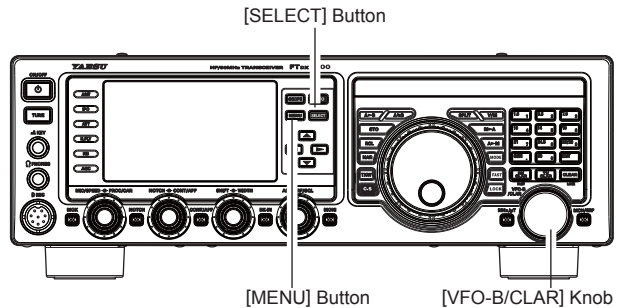

ACS OFF

Morse "E" & "T"

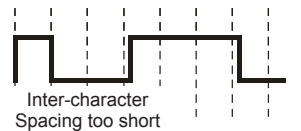

ACS ON

Morse "E" & "T"

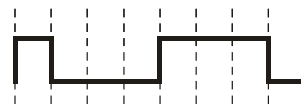

CW SPOTTING (ZERO-BEATING)

“Spotting” (zeroing in on another CW station) is a handy technique to ensure you and the other station are precisely on the same frequency.

The Tuning Offset Indicator in the display may also be moved so you can adjust your receiver frequency to center the incoming station on the pitch corresponding to that of your transmitted signal.

Using the Auto Zeroing System

(Only when the optional FFT unit is installed)

Press the [▲/▼/◀/▶] button to select the “ZIN/SPOT”. Press the [SELECT] switch momentarily to adjust the receiving frequency to the zero-in automatically while receiving the CW signal.

Using the SPOT System

Press the [▲/▼/◀/▶] button to select the “ZIN/SPOT”. Press the [MONI] button, then while pressing the front panel [SELECT] button, the Spot tone will be heard through your speaker. This tone corresponds to the pitch of your transmitted signal. If you adjust the receiver frequency until the pitch of the received CW signal matches that of the Spot tone, your transmitted signal will be precisely matched to that of the other station.

Release the [SELECT] button to turn the Spot tone off.

ADVICE:

- ❑ In a tough DX pile-up, you may actually want to use the SPOT system to find a “gap” in the spread of calling stations, instead of zeroing in precisely on the last station being worked by the DX station. From the DX side, if a dozen or more operators (also using Yaesu’s SPOT system) all call precisely on the same frequency, their dots and dashes merge into a single, long tone that the DX station cannot decipher. In such situations, calling slightly higher or lower in frequency may get your call through.
- ❑ The Tuning Offset Indicator in the display may be utilized for CW frequency adjustment, as well. Its configuration is set via Menu item “011 BAR DISPLAY SELECT” at the factory, and the Tuning Offset Indicator is already set to the “CW TUNE” selection.

QUICK POINTS:

- ❑ The CW Spotting process utilizes the Spot tone or the Tuning Offset Indicator. The actual offset pitch is set by Menu item “056 CW PITCH”. The offset pitch may be set to any frequency between 300 Hz and 1050 Hz, in 50 Hz steps. You can either match tones audibly (using the [SELECT] button) or tune the receiver frequency so that the central red marker on the Tuning Offset indicator lights up. Note that there are 31 “dots” on the Tuning Offset Indicator, and depending on the resolution selected, the incoming CW signal may fall outside the visible range of the bar indicator, if you are not reasonably close to the proper alignment of tones.

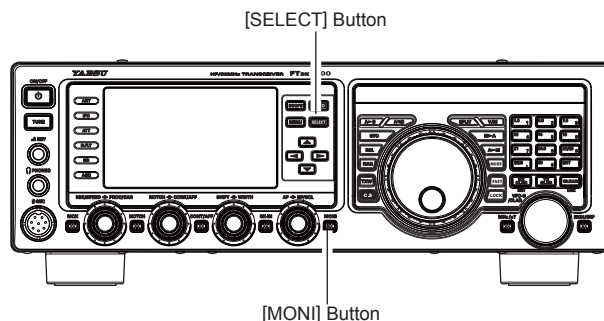

Retune: Shift to Higher Frequency



Retune: Shift to Lower Frequency



Zero-In



- ❑ The displayed frequency on CW normally reflects the “zero beat” frequency of your offset carrier. That is, if you were to listen on USB on 14.100.00 MHz to a signal with a 700 Hz offset, the “zero beat” frequency of that CW carrier would be 14.100.70 MHz; the latter frequency is what the FTdx1200 displays, by default. However, you can change the display to be identical to what you would see on SSB by using Menu item “066 CW FREQ DISPLAY” and setting it to “DIRECT FREQ” instead of the default “PITCH OFFSET” setting.

CW CONVENIENCE FEATURES

USING CW REVERSE

If you experience a difficult interference situation, where an interfering station cannot readily be eliminated, you may wish to try receiving using the opposite sideband. This may move the interfering station's frequency in a direction that may lend itself more readily to rejection.

1. To start, let's use a typical example where you have set the CW mode (using the default "USB" injection).
2. Now be sure your mode selection is still set for VFO-A, and then press and hold in the **[MODE]** button for one second. The "LSB" and "CW" will appear in the display, indicating that the "LSB" injection side has now been selected.
3. To return to the normal (USB) injection side and cancel CW Reverse operation, press and hold in the **[MODE]** button for one second. (the "USB" and "CW" will appear in the display).

NOTES:

- When CW Reverse is engaged, the action of the Tuning Offset Indicator will also be reversed
- When the incoming signal pitch tone is properly aligned, the central red marker lights up whether or not CW Reverse is engaged.

Retune: Shift to Lower Frequency



Retune: Shift to Higher Frequency



Zero-In

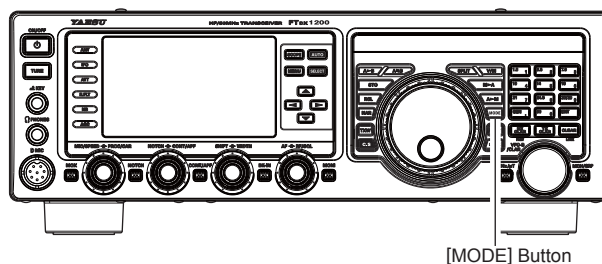

In the illustration, Figure "A" demonstrates the normal CW injection setup, using the USB side. In Figure "B", CW Reverse has been engaged to receive using LSB-side injection and eliminate interference.

The beneficial effect of switching sidebands can be clearly seen in this example.

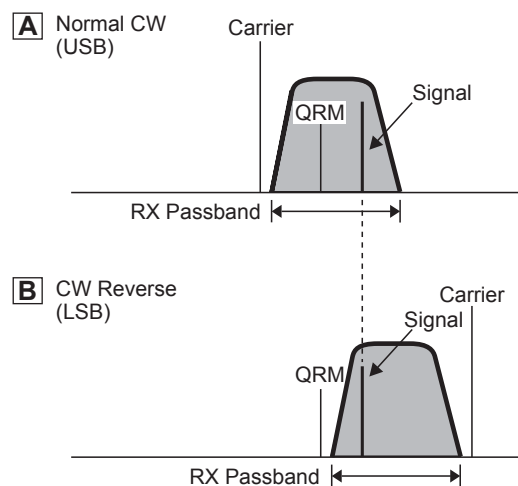

CW CONVENIENCE FEATURES

CW DELAY TIME SETTING

During semi-break-in (not QSK) operation, the hang time of the transmitter, after you have finished sending, may be adjusted to a comfortable value consistent with your sending speed. This is the functional equivalent of the “VOX Delay” adjustment used on voice modes, and the delay may be varied anywhere between 30 msec and 3 seconds via Menu item “064 CW BK-IN DELAY”.

1. Press the **[BK-IN]** button to enable CW transmission (Menu item “063 CW BK-IN” must be set to “SEMI”).
2. Press the **[MENU]** button to enter the Menu mode.
3. Rotate the **[VFO-B/CLAR]** knob (or press the **▲/▼** button) to select Menu item “064 CW BK-IN DELAY”, then press the **[SELECT]** button.
4. Start sending and rotate the **[VFO-B/CLAR]** knob to adjust the hang time, as you prefer for comfortable operation.
5. When you are finished, press the **[SELECT]** button, then press the **[MENU]** button to save the new setting and exit to normal operation.

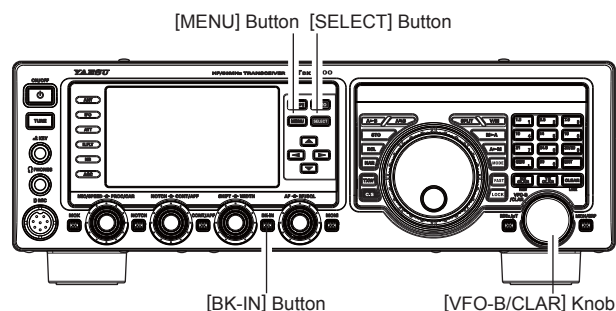

CW PITCH ADJUSTMENT

You may adjust the center frequency of the receiver passband, and change the pitch of your offset CW carrier, to the tone you prefer via Menu item “056 CW PITCH”. The tone may be varied between 300 Hz and 1050 Hz, in 10 Hz steps.

1. Press the **[MENU]** button to enter the Menu mode.
2. Rotate the **[VFO-B/CLAR]** knob (or press the **▲/▼** button) to select Menu item “056 CW PITCH”.
3. Press the **[SELECT]** button, then rotate the **[VFO-B/CLAR]** knob or press the **▲/▼** button to select the desired tone.
4. When you are finished, press the **[SELECT]** button, then press the **[MENU]** button to save the new setting and exit to normal operation.

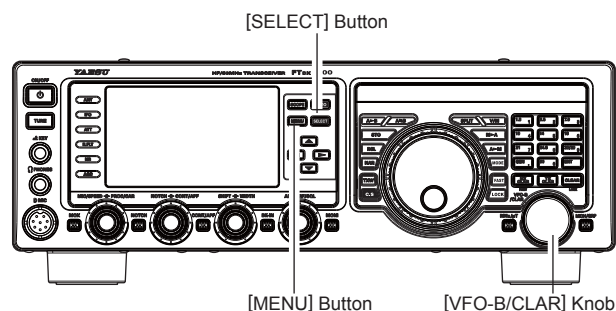

TERMINOLOGY:

CW Pitch: If you tuned to an exact “zero beat” on an incoming CW signal, you could not copy it (“Zero beat” implies a 0 Hz tone). Therefore, the receiver is offset several hundreds of Hz (typically), to allow your ear to detect the tone. The BFO offset associated with this tuning (that produces the comfortable audio tone) is called the CW Pitch.

CW CONVENIENCE FEATURES

CONTEST MEMORY KEYER (USING THE OPTIONAL FH-2 REMOTE CONTROL KEYPAD)

You may also utilize the CW message capability of the FTdx1200 from the optional FH-2 Remote Control Keypad, which plugs into the rear panel REM jack.

Message Memory

Five memory channels capable of retaining 50 characters each are provided (using the PARIS standard for characters and word length).

Example: CQ CQ CQ DE W6DXC K (19 characters)

--- · · · · · --- · · · · · --- · · · · · --- · · · · · --- · · · · ·
(C) (Q) (C) (Q) (C) (Q) (D)(E) (W) (6) (D) (X) (C) (K)

STORING A MESSAGE INTO MEMORY

1. Press the [MENU] button to enter the Menu mode.
2. Rotate the [VFO-B/CLAR] knob (or press the ▲/▼ button) to select the CW Memory Register into which you wish to store the message; for now, we are just setting the message entry technique to (Keyer entry).
027 CW MEMORY 1
028 CW MEMORY 2
029 CW MEMORY 3
030 CW MEMORY 4
031 CW MEMORY 5
3. Press the [SELECT] button, then rotate the [VFO-B/CLAR] knob (or press the ▲/▼ button) to set the selected CW Memory Register to "MESSAGE". If you want to use your keyer paddle for message entry on all memories, set all five Menu items (#027 ~ 031) to "MESSAGE".
4. Press the [SELECT] button, then press the [MENU] button to save the new settings and exit.

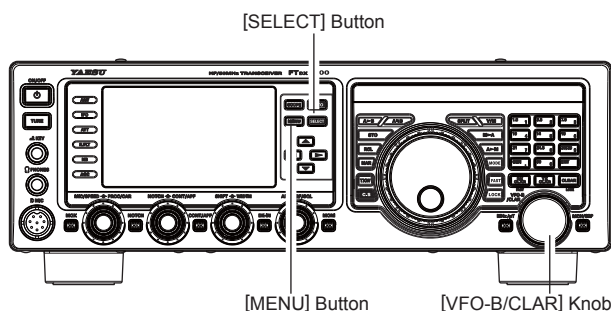

TERMINOLOGY:

PARIS Word Length: By convention among CW and Amateur operators (utilized by ARRL and others), the length of one "word" of CW is defined as the length of the Morse Code characters spelling the word "PARIS". This character (dot/dash/space) length is used for the specific definition of code speed in "words per minute".

NOTE:

You must exercise care in sending to ensure that the spaces between letters and words are accurately done; if your timing is off, the spacing may not come out right in the stored message. For ease in setting up the keyer memories, we recommend you set Menu item "018 F KEYER TYPE" and/or "020 R KEYER TYPE" to "ACS" (Automatic Character Spacing) while you are programming the keyer memories.

Contest Number Programming

Use this process if you are starting a contest, or if you somehow get out of sync with the proper number in the middle of a contest.

1. Press the [MENU] button to enter the Menu mode.
2. Rotate the [VFO-B/CLAR] knob (or press the ▲/▼ button) to select Menu item "026 CONTEST NUMBER". The current contest number appears on the TFT display.
3. Press the [SELECT] button, then rotate the [VFO-B/CLAR] knob (or press the ▲/▼ button) to set the Contest Number to the desired value.

ADVICE:

Press the [CLEAR] button (located at the upper right of the [VFO-B/CLAR] knob) to reset the Contest Number to "1".

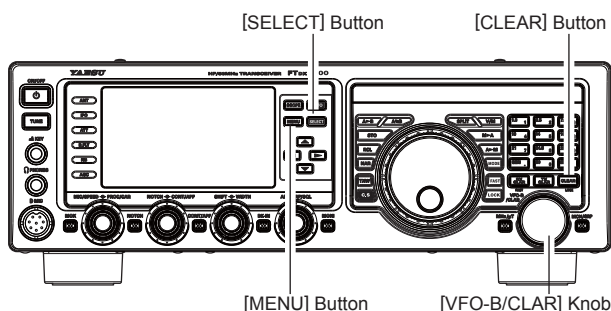

4. Press the [SELECT] button, then press the [MENU] button to store the new number and exit.

CONTEST MEMORY KEYER (USING THE OPTIONAL FH-2 REMOTE CONTROL KEYPAD)

MESSAGE MEMORY PROGRAMMING (USING YOUR PADDLE)

1. Set the operating mode to CW.
2. Set the [BK-IN] button to "Off".
3. Turn the internal Electronic Keyer "On".
4. Press the [MEM] key on the FH-2. A blinking "REC" icon will appear in the display.

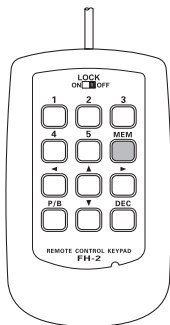

5. Press any of the FH-2 keys numbered [1] through [5] to begin the memory storage process, and the "REC" icon will glow steadily.

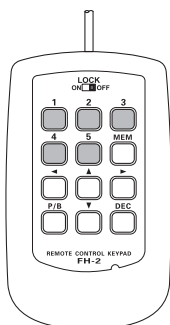

6. Send the desired message using your keyer paddle.

ADVICE:

If you do not start keying within ten seconds, the memory storage process will be cancelled.

7. Press the [MEM] key on the FH-2 once more at the end of your message. Up to 50 characters may be stored in each of the five memories.

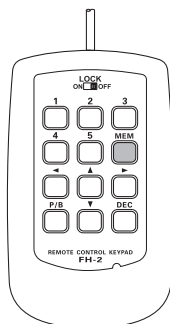

NOTE:

You must exercise care in sending to ensure that the spaces between letters and words are accurately done; if your timing is off, the spacing may not come out right in the stored message. For ease in setting up the keyer memories, we recommend you set Menu item "018 F KEYER TYPE" and/or "020 R KEYER TYPE" to "ACS" (Automatic Character Spacing) while you are programming the keyer memories.

CHECKING THE CW MEMORY CONTENTS

1. Be sure that Break-in is still turned "Off" by the [BK-IN] button.
2. Press the [MONI] button to enable the CW monitor.
3. Press the FH-2 [1] ~ [5] key, whichever memory you just recorded in. You will hear the results in the sidetone monitor, but no RF energy will be transmitted.

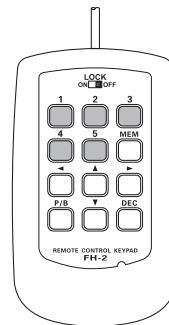

NOTE:

You may adjust the monitor level setting using Menu item "036 MONITOR LEVEL".

ON-THE-AIR CW MESSAGE PLAYBACK

1. Press the [BK-IN] button to enable transmission. Either Full- or Semi-break-in will be engaged, depending on the setting of Menu item "063 CW BK-IN".
2. Press the FH-2 [1] ~ [5] key, depending on which CW Memory Register message you wish to transmit. The programmed message will be transmitted on the air.

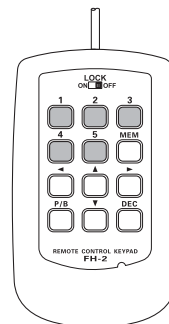

NOTE:

If you subsequently decide to use the "Text Memory" technique for memory storage, please note that a message stored using keyer paddle input will not be transferred over when you select "Text Memory technique" on a particular memory register (the Menu Mode Setting is set to "TEXT").

CW CONVENIENCE FEATURES

CONTEST MEMORY KEYER (USING THE OPTIONAL FH-2 REMOTE CONTROL KEYPAD)

TEXT Memory

The five channels of CW message memory (up to 50 characters each) may also be programmed using a text-entry technique. This technique is somewhat slower than when you send the message directly from your keyer paddle, but accuracy of character spacing is ensured. Be sure to enter the character “}” at the end of texts.

Example 1: CQ CQ CQ DE W6DXC K} (20 characters)

The sequential Contest Number (“Count up”) feature is another powerful feature of the CW Memory Keyer.

Example 2: 599 10 200 # K} (15 characters)

TEXT MEMORY STORAGE

1. Press and hold in the [MENU] button for one second to enter the Menu mode.
2. Rotate the [VFO-B/CLAR] knob or press the ▲/▼ button to select the CW Memory Register into which you wish to store the message; we are now setting the message entry technique to (Text entry).

027 CW MEMORY 1
 028 CW MEMORY 2
 029 CW MEMORY 3
 030 CW MEMORY 4
 031 CW MEMORY 5

ADVICE:

The following texts are programmed to the MEMORY 4 and MEMORY 5 in factory default.

MEMORY 4: DE FTDX1200 K}
 MEMORY 5: R 5NN K}

3. Press the [SELECT] button, then rotate the [VFO-B/CLAR] knob or press the ▲/▼ button to set the selected CW Memory Register to “TEXT”. If you want to use text message entry on all memories, set all five Menu items (#027 ~ 031) to “TEXT”.
4. Press the [SELECT] button, then press the [MENU] button to save the new settings and exit.

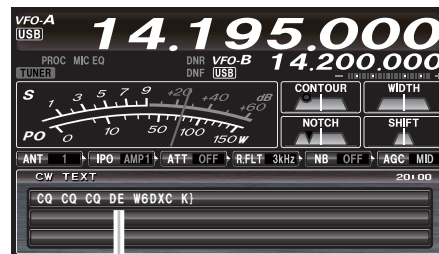

Up to 50 characters

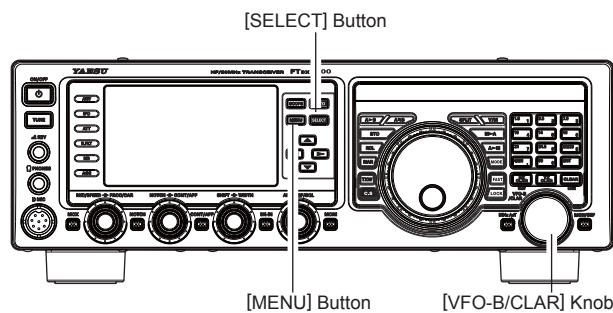

TEXT	CW CODE	TEXT	CW CODE	TEXT	CW CODE	TEXT	CW CODE	TEXT	CW CODE	TEXT	CW CODE
!	SN	&	AS	+	AR	:	OS	?	IMI	^	—
"	AF	'	WG	,	MIM	;	KR	@	@	_	IQ
#	—	(KN	-	DU	<	—	[—	}	—
\$	SX)	KK	.	AAA	=	BT	¥(\)	AL		
%	KA	*	—	/	DN	>	—	}	—		

CONTEST MEMORY KEYS (USING THE OPTIONAL FH-2 REMOTE CONTROL KEYPAD)

TEXT MESSAGE PROGRAMMING

1. Press the **[MODE]** button to set the operating mode to CW.
2. Be sure that Break-in is "Off" by pressing the **[BK-IN]** button, if necessary.
3. Press the **FH-2 [MEM]** key. A blinking "REC" icon will appear in the display.

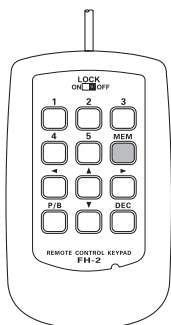

4. Press an **FH-2 [1] ~ [5]** key to select the desired CW Memory Register into which you wish to program the text, the blinking "REC" icon will disappear.

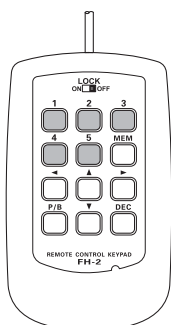

5. Use the **FH-2 [◀]** and **[▶]** keys to set the cursor position and use the **FH-2's [▲]** and **[▼]** keys to choose the letter/number to be programmed in each slot of the memory. In the case of the second example on the previous page the "#" character designates the slot where the Contest Number will appear.

ADVICE:

You may also use the Main Tuning Dial knob and the **[VFO-B/CLAR]** knobs to program the message characters.

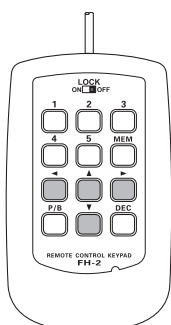

6. When the message is complete, add the "}" character at the end to signify the termination of the message.
7. Press and hold in the **FH-2 [MEM]** key for one second to exit, once all characters (including "}") have been programmed.

CHECKING THE CW MEMORY CONTENTS

1. Be sure that Break-in is still turned "Off" by the **[BK-IN]** key.
2. Press the **[MONI]** button to enable the CW monitor.
3. Press an **FH-2 [1] ~ [5]** key, whichever memory you just recorded in. You will hear the results in the sidetone, but no RF energy will be transmitted.

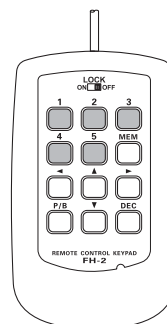

ON-THE-AIR CW MESSAGE PLAYBACK

1. Press the **[BK-IN]** button to enable transmission. Either Full-break-in or Semi-break-in will be engaged, depending on the setting of Menu item "063 CW BK-IN".
2. Press an **FH-2 [1] ~ [5]** key, depending on which CW Memory Register message you wish to transmit. The programmed message will be transmitted on the air.

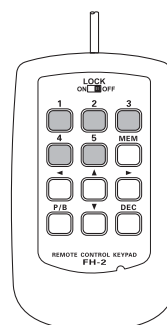

CW CONVENIENCE FEATURES

CONTEST MEMORY KEYER (USING THE OPTIONAL FH-2 REMOTE CONTROL KEYPAD)

NOTE:

If you subsequently decide to use the “Message Memory” technique for memory storage, please note that the contents of a message stored using text input will not be transferred over when you set entry to “Message Memory technique” on a particular memory register (the Menu Mode Setting is set to “MESSAGE”).

Decrementing the Contest Number

Use this process if the current contest number gets slightly ahead of the actual number you want to send (in case of a duplicate QSO, for example).

Press the **FH-2 [DEC]** key momentarily. The current Contest Number will be reduced by one. Press of the **FH-2 [DEC]** key as many times as necessary to reach the desired number. If you go too far, use the “Contest Number Programming” technique described previously.

Transmitting in the Beacon Mode

In “Beacon” mode, it is possible to repeatedly transmit any message programmed, either via paddle input, or via the “Text” input method. The time delay between message repeats may be set anywhere between 1 and 690 seconds (1 ~ 240 sec (1 sec/step) or 270 ~ 690 sec (30 sec/step)) via Menu item “024 BEACON TIME” If you do not wish the message to repeat in a “Beacon” mode, please set this Menu item to “OFF”.

To transmit the message:

1. Press the **[BK-IN]** button to enable transmission. Either Full-break-in or Semi-break-in will be engaged, depending on the setting of Menu item “063 CW BK-IN”.
2. Press an **FH-2 [1] ~ [5]** key. Repetitive transmission of the Beacon message will begin.

CW DECODE

When the optional FFT unit is installed, alphanumeric Morse code can be decoded and displayed as text on the TFT display.

1. Press the **[MODE]** button to set the operating mode to CW.
2. Tune the receiver to a CW signal, then press and hold the **[SCOPE]** switch for one second or longer.

ADVICE:

The CW DECODE screen is displayed, and the decoded message is displayed on the screen.

NOTE:

Interfering signals, noise, phasing, code accuracy, and the like may prevent accurate message copy.

To cancel the CW decode function, press and hold the **[SCOPE]** switch again for one second or longer.

ADVICE:

- If scrambled text is displayed due to noise and clutter, when a CW signal is not being received, turn the **[VFO-B/CLAR]** knob to adjust the threshold level.
- Decoding accuracy will increase if you turn the **[MIC/SPEED]** knob and adjust to a speed close to that of the CW signal being received.

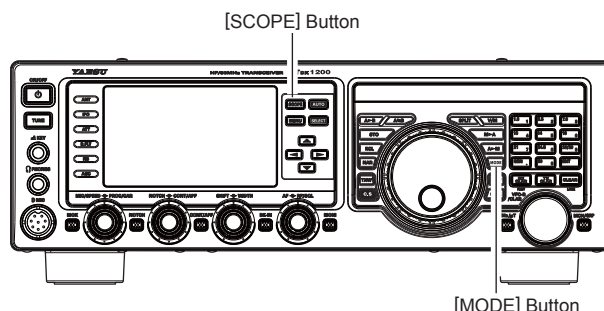

Displays the decoded Morse code.

Displays content written to the Contest Memory Keyer*

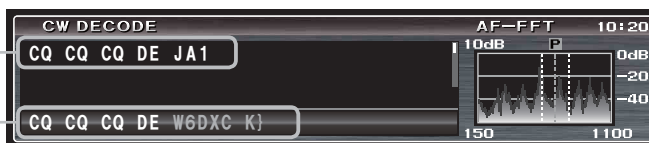

AF-FFT display (see page 40)
("Spectrum" or "Waterfall" display)

※ If you transmit content written to the Contest Memory Keyer (page 84), the transmit CW signal is displayed as text.

Note that transmitted text is displayed in white.

Threshold Level Adjustment

Scrambled text may be displayed due to noise and clutter, when a signal is not being received. You can adjust the threshold level to reduce or eliminate the scrambled text.

Turn the **[VFO-B/CLAR]** knob, and adjust the threshold level (between 0 and 100) so text is not displayed due to noise and the like.

- Note that text will no longer be displayed for weak signals if you increase the level too much.
- You switch between threshold level display and normal display each time you press the **[SELECT]** button.

- The threshold level is displayed in the TFT display.



Threshold level

FM MODE OPERATION

BASIC OPERATION

1. Press the **[MODE]** button repeatedly, until the “**FM**” icon appears in the display, to select the FM operating mode.
2. Rotate the Main Tuning Dial knob to select the desired operating frequency. Pressing the microphone **[UP]** or **[DWN]** buttons will cause frequency change in 5 kHz steps.
3. Press the microphone **PTT** switch (or press the front panel **[MOX]** button) to transmit. Speak into the microphone in a normal voice level. Release the **PTT** or **[MOX]** switch to return to receive.
4. Adjustment of the microphone gain may be accomplished in two ways. At the factory, a default level has been programmed that should be satisfactory for most situations. However, using Menu item “085 FM MIC GAIN”, you may set a different fixed value, or choose the “MCVR” option, which then lets you use the front panel **[MIC/SPEED]** knob to set the microphone gain in the FM mode.

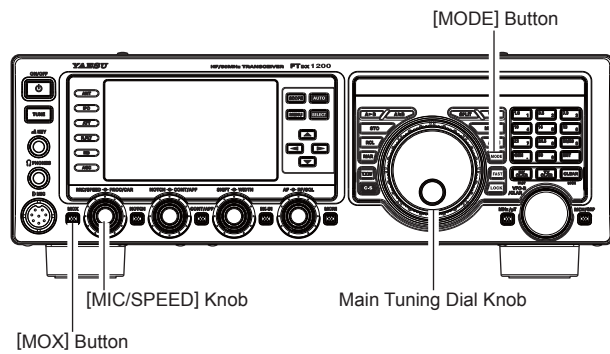

ADVICE:

- You may change the tuning step of the Main Tuning Dial knob via Menu item “153 AM/FM DIAL STEP”.
- You may change the tuning step of the microphone **[UP]/[DWN]** button via the Menu item “157 FM CH STEP”.
- The Transmit Monitor is another helpful way to verify proper adjustment of the FM MIC Gain. By pressing the **[MONI]** button, you will be able to hear the differences in deviation as you make adjustments.
- FM is only used in the 28 MHz and 50 MHz Amateur bands covered by the **FTdx1200**. Please do not use FM on any other bands.

REPEATER OPERATION

The **FTdx1200** may be utilized on 29 MHz and 50 MHz repeaters.

1. Rotate the Main Tuning Dial knob to the output frequency (downlink) from the repeater.
2. If CTCSS Tone operation is desired/needed, press the **▲/▼/◀/▶** button to select "TONE", then press the **[SELECT]** button to engage the CTCSS mode.
3. Press the **[SELECT]** button to select the desired CTCSS mode. If you just need to send the uplink encoding tone, select "ENC." For encode/decode operation, choose "T.SQL" instead. The available choices are

"OFF" → "ENC (Tone Encoder)"
 → "T.SQL (Tone Squelch)" → "OFF"

4. Press and hold in the **[SELECT]** button to enter the Menu item "089 TONE FREQ".
5. Press the **[SELECT]** button, then rotate the **[VFO-B/CLAR]** knob (or press the **▲/▼** button) to select the desired CTCSS Tone to be used. A total of 50 standard CTCSS tones are provided (see the CTCSS Tone Chart).

6. Press the **[SELECT]** button, then press the **[MENU]** button to save the new settings and exit.

7. Press the **▲/▼/◀/▶** button to select "RPT", then press the **[SELECT]** button to select the desired repeater shift direction. The selections are:
 "SIMP" → "+" → "-" → "SIMP"

where "SIMP" represents "Simplex" operation (not used on a repeater).

8. Close the microphone **PTT** switch (or press the **[MOX]** button) to begin transmission. You will observe that the frequency has shifted to correspond to the programming you set up in the previous steps, and a "t" notation will appear on the "10 Hz" frequency digit while transmitting. Speak into the microphone in a normal voice level. Release the **PTT** switch or **[MOX]** button to return to the receive mode.

ADVICE:

- The conventional repeater shift used on 29 MHz is 100 kHz, while on the 50 MHz band the shift may vary between 500 kHz and 1.7 MHz (or more). To program the proper repeater shift, use Menu items "087 RPT SHIFT [28MHz]" (28 MHz) and "088 RPT SHIFT [50MHz]" (50 MHz), as appropriate.

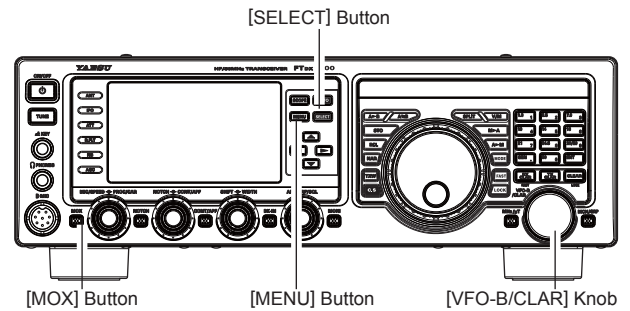

The "t" indicator will appear in this area while transmitting.



CTCSS TONE FREQUENCY (Hz)							
67.0	69.3	71.9	74.4	77.0	79.7	82.5	85.4
88.5	91.5	94.8	97.4	100.0	103.5	107.2	110.9
114.8	118.8	123.0	127.3	131.8	136.5	141.3	146.2
151.4	156.7	159.8	162.2	165.5	167.9	171.3	173.8
177.3	179.9	183.5	186.2	189.9	192.8	196.6	199.5
203.5	206.5	210.7	218.1	225.7	229.1	233.6	241.8
250.3	251.4	-	-	-	-	-	-

FM MODE OPERATION

TONE SQUELCH OPERATION

You may also use “Tone Squelch” whereby your receiver will be kept silent until an incoming signal modulated with a matching CTCSS tone is received. The receiver squelch will then open in response to the reception of the required tone.

1. Rotate the Main tuning Dial to the output frequency (downlink) from the repeater.
2. If CTCSS Tone operation is desired/needed, press the ▲/▼/◀/▶ button to select “TONE”, then press the **[SELECT]** button to engage the CTCSS mode.
3. Press the **[SELECT]** button to choose “T.SQL” from the available choices of
“OFF” → “ENC (Tone Encoder)”
→ “T.SQL (Tone Squelch)” → “OFF”
4. Press and hold in the **[SELECT]** button to enter the Menu item “089 TONE FREQ”.
5. Rotate the **[VFO-B/CLAR]** knob or press the ▲/▼ button to select the desired CTCSS Tone to be used. Fifty standard CTCSS tones are provided (see the CTCSS Tone Chart).
6. Press the **[SELECT]** button to exit from the CTCSS Tone setup mode.
7. A “d” notation on the “1 Hz” frequency digit in the display will indicate that the Tone Decoder is engaged. A “t” notation on the “1 Hz” frequency digit while transmitting will indicate that the Tone Squelch is engaged.

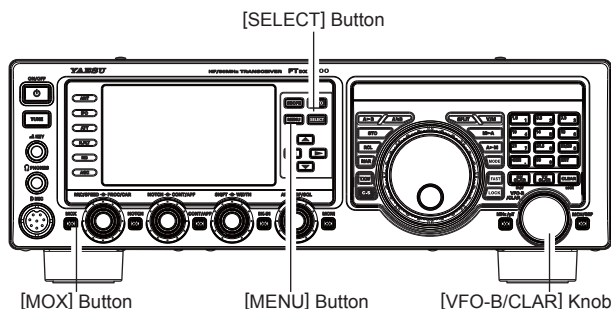

Tone Decoder is engaged



Tone Squelch is engaged

CONVENIENT MEMORY FUNCTIONS

The **FTdx1200** contains ninety-nine regular memories, labeled “01” through “99”, nine special programmed limit memory pairs, labeled “P-1L/P-1U” through “P-9L/P-9U”, and five QMB (Quick Memory Bank) memories, labeled “C-1” through “C-5”. Each stores various settings, in addition to the VFO-A frequency and mode (See below). By default, the 99 regular memories are contained in one group; however, they can be arranged in up to six separate groups, if desired.

QUICK POINT:

The **FTdx1200** memory channels store the following data (not just the operating frequency):

- VFO-A Frequency
- VFO-A Mode
- Clarifier status and its Offset Frequency
- ANT status
- IPO status
- Roofing filter status and its Bandwidth
- Attenuator status
- Noise Blanker status
- IF SHIFT and WIDTH status
- CONTOUR status and its Peak Frequency
- DSP Noise Reduction (DNR) status and its Reduction algorithm selection.
- DSP Notch filter (NOTCH) status
- NAR bandwidth status
- DSP Auto Notch filter (DNF) status
- Repeater Shift Direction and CTCSS Tone Frequency

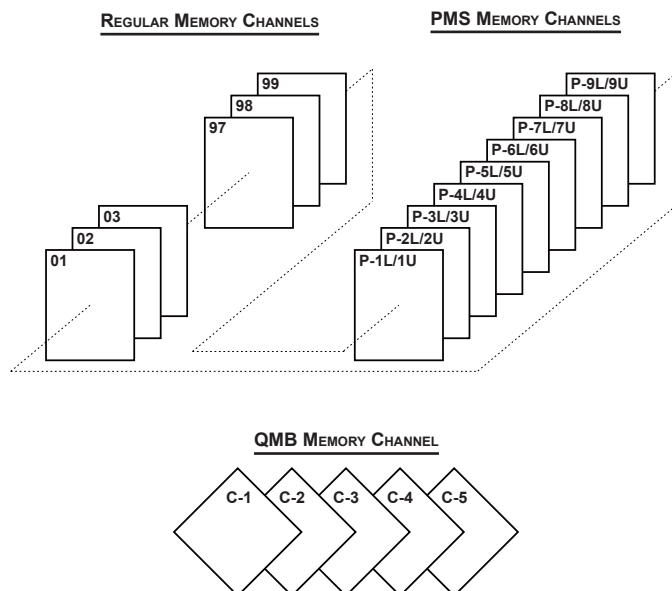

QMB (QUICK MEMORY BANK)

The Quick Memory Bank consists of five memories (labeled “Q-1” through “Q-5”) independent from the regular and PMS memories. These can quickly store operating parameters for later recall.

QMB Channel Storage

1. Tune to the desired frequency on the VFO-A.
2. Press the blue **[STO]** button. The “beep” will confirm that the VFO-A contents have been written to the currently available QMB memory.

If you repeatedly press the **[STO]** button, the QMB memories will be written in the following order:

Q-2 → Q-3 → Q-4 → Q-5 → Q-1.

Once all five QMB memories have data on them, previous data (starting with channel Q-1) will be over-written on a first-in, first-out basis.

QMB Channel Recall

1. Press the blue **[RCL]** button. The current QMB channel data will be shown on the frequency display area. The “**QMB**” icon will also appear and the Memory Mode indicators in the LED indicators area will illuminate.
2. Repeatedly pressing the **[RCL]** button will toggle you through the QMB channels:
Q-2 → Q-3 → Q-4 → Q-5 → Q-1.
3. Press the **[V/M]** button to return to the VFO or Memory mode.

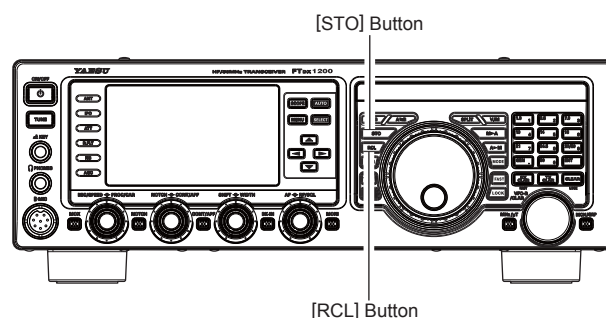

ADVICE:

Rotating the Main Tuning Dial knob, or changing the operating mode, will place the transceiver in the “Memory Tune” mode, which is a temporary “pseudo-VFO” method of tuning off of a stored memory channel. If you do not over-write the contents of the current memory channel, the original contents will not be disturbed by the initiation of Memory Tune operation.

MEMORY OPERATION

STANDARD MEMORY OPERATION

The Standard Memory of the **FTdx1200** allows storage and recall of up to 99 memories, each storing frequency, mode, and a wide variety of status information, detailed previously. Memories may be grouped into as many as six Memory Groups, and additionally you get nine pairs of band-limit (PMS) memories along with five QMB (Quick Memory Bank) memories.

Memory Storage

1. Set VFO-A up with the frequency, mode, and status, the way you want to have it stored.
2. Press the **[A►M]** button momentarily; the current channel number will start blinking in the display and the “**MCK**” notation will appear.
3. Rotate the **[VFO-B/CLAR]** knob to select the memory channel that you wish to store the data on.
4. Press and hold in the **[A►M]** button for one second to store the frequency and other data into the selected memory channel. A double beep will confirm that you have held the **[A►M]** button in long enough.

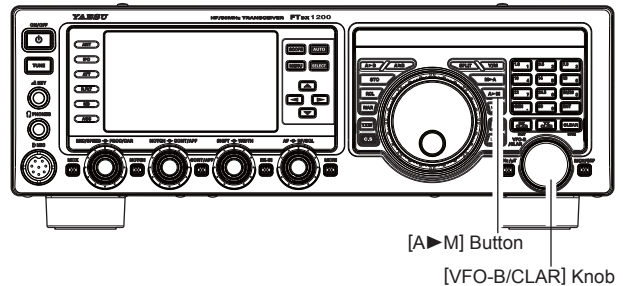

Memory Channel Recall

1. Press the **[V/M]** button, if necessary, to enter the “Memory mode”.
2. Press the **[MCH/GRP]** button. A memory channel number and the “**MCH**” notation will appear in the display.
3. After pressing the **[MCH/GRP]** button, you may rotate the **[VFO-B/CLAR]** knob to select the desired memory channel.

ADVICE:

To work within a particular Memory Group, press and hold the **[MCH/GRP]** button for one second (the “**GRP**” notation will appear on the display), then rotate the **[VFO-B/CLAR]** knob to select the desired Memory Group. Now press the **[MCH/GRP]** button (the “**MCH**” notation will appear instead of the “**GRP**”); you may now choose the memory channel within the selected Memory Group.

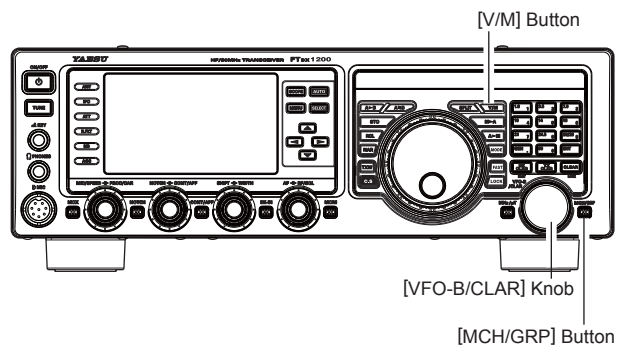

STANDARD MEMORY OPERATION

Labeling Memories

You may wish to append an Alphanumeric “Tag” (label) to a memory or memories, to aid in recollection of the channel’s use (such as a club name, etc.). To do this:

1. Press the **[V/M]** button, if necessary, to enter the “Memory Mode”.
2. Press and hold in the **[V/M]** button.
The data stored in the currently selected memory channel will be displayed on the TFT.
3. Rotate the **[VFO-B/CLAR]** knob to recall the memory channel that you wish to append a label.
4. Press the **[SELECT]** button.
A blinking cursor will appear on the first digit.
5. Use the **[◀]** and **[▶]** keys to set the cursor position and use the **[▲]** and **[▼]** keys to choose the letters, numbers, or symbols of the desired label.

ADVICE:

You may also use the **[VFO-B/CLAR]** knob to program the label.

6. Repeat step 5 to program the remaining letters, numbers, or symbols of the desired label. 18 characters may be used in the creation of a label.
7. When you have completed the creation of the label, press the **[SELECT]** button.
8. Press and hold the **[V/M]** button for one second to save the new setting and return to normal operation.

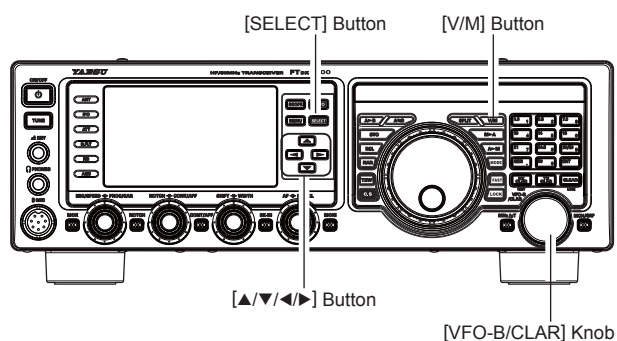

Checking a Memory Channel Status

Before programming a channel into memory, you can check the current contents of that channel without the danger of over-writing the channel accidentally.

1. Press the **[A▶M]** button momentarily.
The data stored in the currently selected memory channel will be displayed on the TFT. However, since you are only checking the contents of the memory channel, your radio will not have moved to the memory channel frequency.
2. Rotate the **[VFO-B/CLAR]** knob to select a different memory channel. To exit from the Memory Check mode, press the **[A▶M]** button momentarily once more.

ADVICE:

- ❑ While the Memory Check function is engaged, the memory channel number will blink in the display.
- ❑ While operating in the VFO mode, using Memory Check, you may store the current VFO frequency into the selected memory by pressing and holding in the **[A▶M]** button for one second (until the double beep). Conversely, if you wish to write the contents of the current memory into the VFO-A register, press and hold in the **[M▶A]** button for one second.

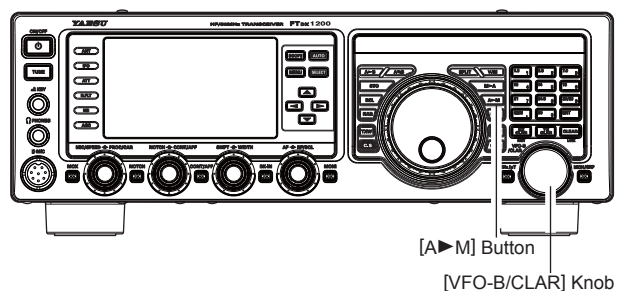

STANDARD MEMORY OPERATION

Erasing Memory Channel Data

1. Press the [V/M] button, if necessary, to enter the VFO mode.
2. Press the [A▶M] button. The data stored in the currently selected memory channel will be displayed in the display.
3. Rotate the [VFO-B/CLAR] knob to select the memory channel that you would like to erase.
4. Press the [LOCK] button to erase the contents of the selected memory channel.

ADVICE:

- ❑ The FTdx1200 can not erase the memory channels “01” (and “5M-01” through “5M-10”: U.S. version).
- ❑ If you make a mistake and wish to restore the memory’s contents, just repeat steps (1) through (4) above.

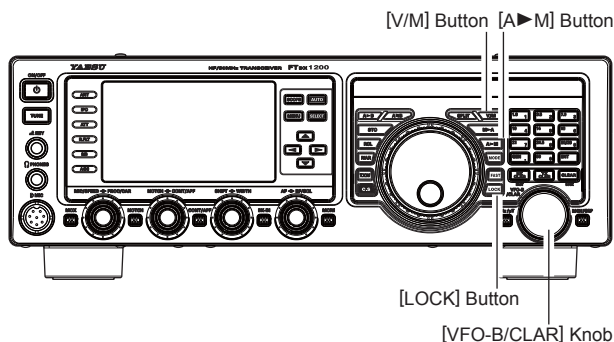

Moving Memory Data to the VFO-A register

You may transfer the contents of the currently selected memory channel into the VFO-A register, if you like.

1. Press the [V/M] button, as necessary, to go to the “Memory” mode.
2. Press the [MCH/GRP] button.
3. Rotate the [VFO-B/CLAR] knob to select the memory channel the contents of which you wish to transfer to VFO-A.
4. Press and hold in the [M▶A] button for one second, until you hear the double beep. The data in the selected memory channel will now be transferred to VFO-A.

ADVICE:

This transfer of data to VFO-A does not affect the original contents of the memory channel; this is a “copy” function that leaves the memory contents unchanged.

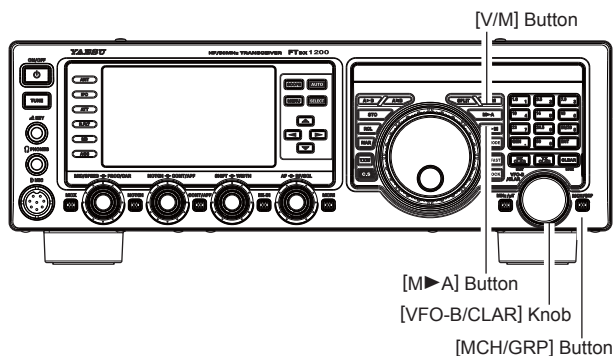

STANDARD MEMORY OPERATION

Memory Tune Operation

You may freely tune off from any memory channel in a “Memory Tune” mode, this is similar to VFO operation. So long as you do not over-write the contents of the current memory, Memory Tune operation will not alter the contents of the memory channel.

1. Press the **[V/M]** button to recall any memory channel.
2. Press the **[MCH/GRP]** button.
3. Rotate the **[VFO-B/CLAR]** knob to select the memory channel.
4. Rotate the Main Tuning Dial knob or press the **[MODE]** button; you will now observe that the memory channel frequency is changing.

ADVICE:

- During Memory Tune operation, you may change operating modes, and engage the offset Clarifier, if desired.
5. Press the **[V/M]** button momentarily to return to the originally memorized frequency of the current memory channel. One more press of the **[V/M]** button will return to VFO operation.

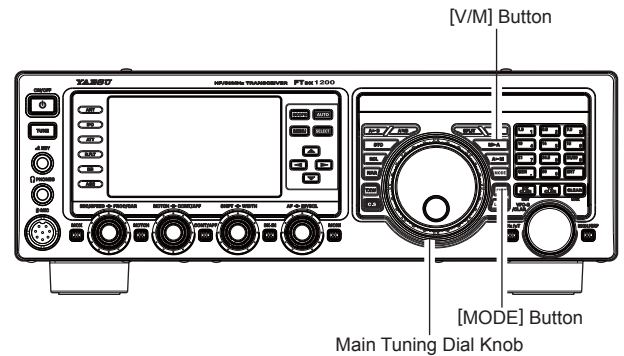

NOTE:

Computer software programs utilizing the CAT system interface port may presume that the transceiver is operating in the VFO mode, for certain features like “band mapping” and/or frequency logging, because the “Memory Tune” mode so closely resembles the VFO mode. Be sure that you have the **FTdx1200** operating in a control mode compatible with your software’s requirements. Use the VFO mode if you’re not sure.

MEMORY GROUPS

Memory channels may be arranged into as many as six convenient groups, for easy identification and selection. For example, you might want to designate memory groups for AM BC stations, short-wave broadcast stations, contest frequencies, repeater frequencies and PMS limits, or any other groupings you like.

Each memory group is capable of holding up to 20 memory channels (except Memory Group 01: it is 19 memory channels, and the Group size is fixed). When a memory channel is grouped, the channel numbers change to correspond to the chart below:

Memory Group Assignment

1. Press the **[MENU]** button to enter the Menu mode.
2. Rotate the **[VFO-B/CLAR]** knob (or press the **▲/▼** button) to select Menu item “042 MEM GROUP”.
3. Press the **[SELECT]** button, then rotate the **[VFO-B/CLAR]** knob (or press the **▲/▼** button) to set this Menu item to “ENABLE” (the default setting is “DISABLE”).
4. Press the **[SELECT]** button, then press the **[MENU]** button to save the new setting and exit. Operation will now be restricted to the six Memory Groups.

To cancel Memory Group operation, repeat steps (1) through (4) above, choosing “DISABLE” in step (3).

ADVICE:

To avoid confusion, note that the PMS memory group and the PMS memories “P-1L” through “P-9U” will be so designated.

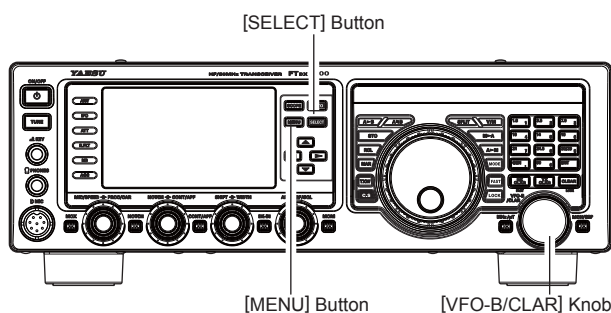

MEMORY CHANNEL NUMBER	
GROUP MEMORY “OFF”	GROUP MEMORY “ON”
01 ~ 19	1-01 ~ 1-19
20 ~ 39	2-01 ~ 2-20
40 ~ 59	3-01 ~ 3-20
60 ~ 79	4-01 ~ 4-20
80 ~ 99	5-01 ~ 5-20
P-1L/1U ~ P-9L/9U	P-1L/1U ~ P-9L/9U
5M-01 ~ 5M-10	US-1 ~ US-5

Choosing the Desired Memory Group

You may recall memories just within a particular Memory Group, if desired.

1. Press the **[V/M]** button, if necessary, to enter the “Memory” mode.
2. Press and hold in the **[MCH/GRP]** button for one second (located to the Lower right of the **[VFO-B/CLAR]** knob). The “GRP” icon will appear on the display.
3. Rotate the **[VFO-B/CLAR]** knob to select the desired Memory Group.
4. Press the **[MCH/GRP]** button. The “MCH” icon will appear on the display.
5. Rotate the **[VFO-B/CLAR]** knob to select the desired Memory Channel within the Selected Memory Group.

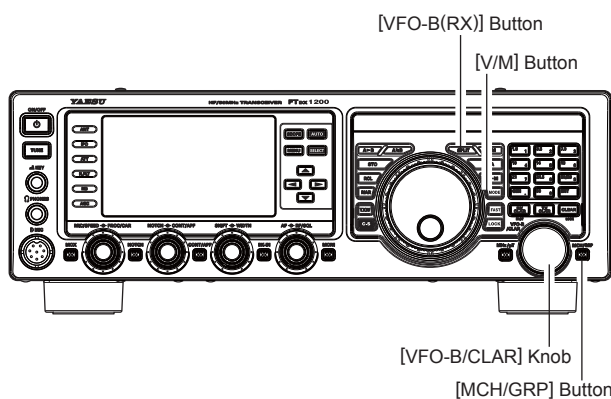

ADVICE:

If no channels have been assigned to a particular Memory Group, you will not have access to that Group.

OPERATION ON ALASKA EMERGENCY FREQUENCY: 5167.5 KHz (U.S. VERSION ONLY)

Section 97.401(d) of the regulations governing amateur radio in the United States permit emergency amateur communications on the spot frequency of 5167.5 kHz by stations in (or within 92.6 km of) the state of Alaska. This frequency is only to be used when the immediate safety of human life and/or property are threatened, and is never to be used for routine communications.

The **FTdx1200** includes the capability for transmission and reception on 5167.5 kHz under such emergency conditions via the Menu system. To activate this feature:

1. Press the **[MENU]** button to enter the Menu mode.
2. Rotate the **[SELECT]** knob (or press the **▲/▼** button) to select Menu item “184 EMERGENCY FREQ TX”.
3. Press the **[SELECT]** button, then rotate the **[VFO-B/CLAR]** knob (or press the **▲/▼** button) to select “ENABLE.”
4. Press the **[SELECT]** button, then press the **[MENU]** button to save the new setting and exit to normal operation. Emergency communication on this spot frequency is now possible.
5. Press the **[V/M]** button, as necessary, to enter the Memory mode. Press the **[MCH/GRP]** button, then rotate the **[VFO-B/CLAR]** knob to select the emergency channel (“EMERGENCY”), which is found between channels “5M-10” and “01”.

NOTE:

- ❑ The receive-mode CLARIFIER functions normally while using this frequency, but variation of the transmit frequency is not possible. The full specifications of the **FTdx1200** are not necessarily guaranteed on this frequency, but power output and receiver sensitivity should be fully satisfactory for the purpose of emergency communication.
- ❑ If you wish to disable operation capability on the Alaska Emergency Frequency, repeat the above procedures, but set the Menu item “184 EMERGENCY FREQ TX” to “DISABLE” in step 3.
- ❑ In an emergency, note that a half-wave dipole cut for this frequency should be approximately 45'3" on each leg (90'6" total length). Emergency operation on 5167.5 kHz is shared with the Alaska-Fixed Service. This transceiver is not authorized for operation, under the FCC Part 87, for aeronautical communications.

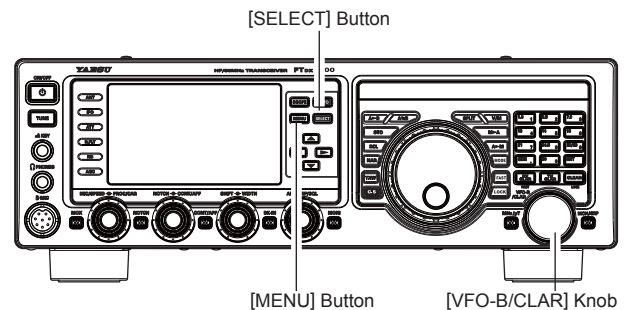

VFO AND MEMORY SCANNING

You may scan either the VFO or the memories of the **FTDx1200**, and the radio will halt scanning on any frequency with a signal strong enough to open the receiver squelch.

VFO SCANNING

1. Set the VFO-A to the frequency on which you would like to begin scanning.
2. Rotate the **[RF/SQL]** knob so that the background noise is just silenced.
3. Press and hold in the microphone **[UP]** or **[DWN]** key for one second to start scanning in the specified direction on the VFO frequency.
4. If the scanner halts on an incoming signal, the decimal point between the “MHz” and “kHz” digits of the frequency display will blink.

ADVICE:

- If the incoming signal disappears, scanning will resume in about five seconds.
 - On the SSB/CW and SSB-based Data modes, the scanner will pause on a received signal, then will step across the signal very slowly, giving you time to stop the scan, if you like. In these modes on the VFO, the scanner does not stop, however.
5. To cancel scanning, press the **[PTT]** switch.

ADVICE:

- If you press the microphone **PTT** switch during scanning, the scanner will halt at once. However, pressing the **PTT** switch during scanning will not cause transmission.
- You may select the manner in which the scanner resumes while it has paused on a signal, using Menu item “048 MIC SCAN RESUME”. The default “TIME” (5 sec) setting will cause the scanner to resume scanning after five seconds; you may change it, however, to resume only after the carrier has dropped out.

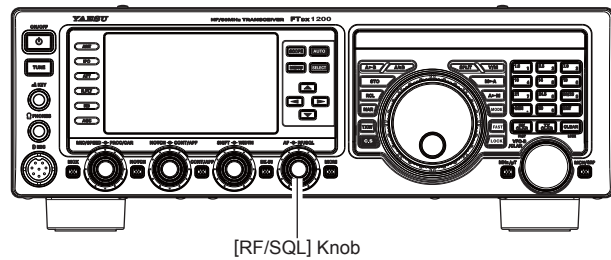

MEMORY SCAN

1. Set the transceiver up in the “Memory” mode by pressing the **[V/M]** button, if necessary.
2. Rotate the **[RF/SQL]** knob so that the background noise is just silenced.
3. Press and hold in the microphone **[UP]** or **[DWN]** key for one second to start scanning in the specified direction.

ADVICE:

- If the scanner halts on an incoming signal, the decimal point between the “MHz” and “kHz” digits of the frequency display will blink.
 - If the incoming signal disappears, scanning will resume in about five seconds.
4. To cancel scanning, press the **[PTT]** witch.

ADVICE:

- During Memory Group operation, only the channels within the current Memory Group will be scanned.
- If the scan has paused on a signal, pressing the microphone **[UP]** or **[DWN]** key will cause scanning to resume instantly.
- If you press the microphone **PTT** switch during scanning, the scanner will halt at once. However, pressing the **PTT** switch during scanning will not cause transmission.
- You may select the manner in which the scanner resumes while it has paused on a signal, using Menu item “048 MIC SCAN RESUME”. During memory scanning, the default “TIME” (5 sec) setting will cause the scanner to resume scanning after five seconds. However, you may change this setting to resume only after the carrier has dropped out, if you like.

QUICK POINT:

If you have no interest in scanning, and wish to prohibit the microphone **[UP]**/**[DWN]** keys from initiating scanning, you may disable scanning control from the microphone using Menu item “047 MIC SCAN” (set it to “DISABLE”).

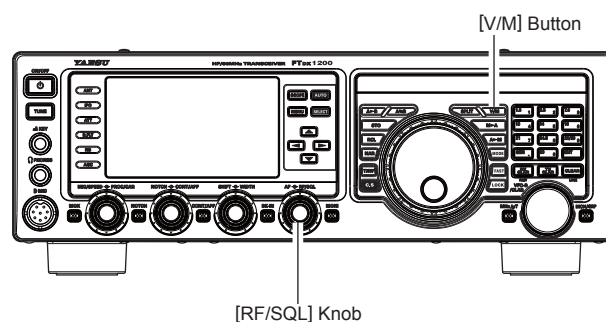

PMS (PROGRAMMABLE MEMORY SCANNING)

To limit scanning (and manual tuning) within a particular frequency range, you can use the Programmable Memory Scanning (PMS) feature, which utilizes nine special-purpose memory pairs (“P-1L/P-1U” through “P-9L/P-9U”). The PMS feature is especially useful in helping you to observe any operating sub-band limits, which apply to your Amateur license class.

1. Store the Lower and Upper tuning/scanning limit frequencies into the memory pair “P-1L” and “P-1U”, respectively, or any other “L/U” pair of memories in the special PMS memory area. See page 94 for details regarding memory storage.
2. Press the **[V/M]** button to enter the “Memory” mode.
3. Press the **[MCH/GRP]** button momentarily. The LEDs indicating the Memory mode will illuminate.
4. Rotate the **[VFO-B/CLAR]** knob to select memory channel “P-1L” or “P-1U”.
5. Rotate the **[RF/SQ]** knob so that the background noise is just silenced.
6. Turn the Main Tuning Dial knob slightly (to activate memory tuning). Tuning and scanning are now limited to the range within the P-1L/P-1U limits until you press the **[V/M]** button to return to memory channel or VFO operation.
7. Press and hold in the microphone **[UP]** or **[DWN]** key for one second to start scanning in the specified direction.

ADVICE:

- ❑ If the scanner halts on an incoming signal, the decimal point between the “MHz” and “kHz” digits of the frequency display will blink.
 - ❑ If the incoming signal disappears, scanning will resume in about five seconds.
 - ❑ On the SSB/CW and SSB-based Data modes, the scanner will pause on a received signal, then will step across the signal very slowly, giving you time to stop the scan, if you like. However, in these modes on the VFO, the scanner does not stop.
 - ❑ If the scan has paused on a signal, pressing the microphone **[UP]** or **[DWN]** key will cause scanning to resume instantly.
8. If you rotate the Main Tuning Dial knob in the opposite direction from the current scanning direction (in other words, you rotate the dial to the left when scanning toward a higher frequency), the direction of the scan will reverse.
 9. If you press the microphone **PTT** switch during scanning, the scanner will halt at once. Pressing the **PTT** switch *during scanning* will not cause transmission.

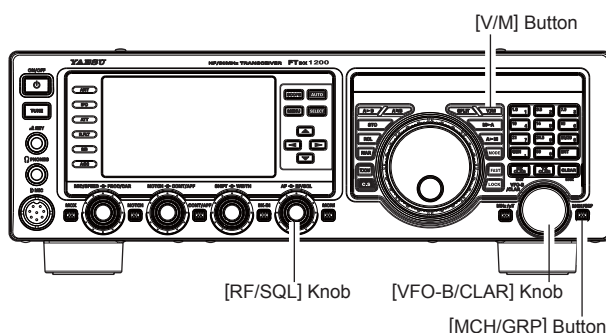

RTTY (RADIO TELETYPE) OPERATION

The **FTDx1200** has the capability of a RTTY decode function when the optional FFT unit is installed. You can easily synchronize by aligning the marker displayed on the AF-FFT screen, together with the decode screen while receiving a signal. Mark frequency (2125 Hz), SHIFT width (170 Hz), and baudot code (US) can be changed in Menu Mode.

RTTY DECODE (WITH OPTIONAL FFT UNIT)

1. Before operating, set the Menu items in the chart to the right.
2. Press the **[MODE]** switch, set the operating mode to “**RTTY LSB**”.

ADVICE:

- Press and hold the **[MODE]** switch for approximately one second to switch back and forth between “**RTTY USB**” and “**RTTY LSB**”.
 - Generally, amateur band stations operate RTTY in LSB.
3. Tune to a RTTY signal, press and hold the **[SCOPE]** switch for one second or longer.
The RTTY DECODE screen displays, and the decoded text is displayed on the screen.

ADVICE:

- Align the peak of the received signal with the mark frequency and shift frequency marker of the AF-FFT screen.
- If text is displayed due to noise and band clutter, when a RTTY signal is not being received, turn the **[VFO-B/CLAR]** knob to adjust and threshold level.

MENU ITEM	AVAILABLE VALUES
094 POLARITY-R	NOR (normal) / REV (reverse)
095 POLARITY-T	NOR (normal) / REV (reverse)
097 RTTY SHIFT	170 / 200 / 425 / 850 (Hz)
098 RTTY MARK FREQ	1275/2125 (Hz)

NOTE:

- Cross talk, noise, phasing, and the like may prevent correct display.
- If continuously sending for more than a few minutes or if sending time is longer than receiving time, reduce transmit power output to between 1/2 and 1/3 using Menu item “177 TX MAX POWER”.

To cancel the RTTY decode function, press and hold the **[SCOPE]** switch again for one second or longer.

Displays the decoded RTTY signal.

Displays content written to the RTTY text memory*



AF-FFT display (see page 40)
("Spectrum" or "Waterfall" display)

* If you transmit content written to the RTTY text memory (page 104), the transmitted RTTY signal is displayed as text.

Note that transmitted text is displayed in white.

Threshold Level Adjustment

Scrambled text may be displayed due to noise and band clutter, when a signal is not being received. You can adjust the threshold level so the scrambled text is not displayed.

Turn the **[VFO-B/CLAR]** knob, and adjust the threshold level (between 0 and 100) so scrambled text is not displayed.

- Note that text will no longer be displayed for weak signals if you increase the level too much.
- You switch between threshold level display and normal display each time you press the **[SELECT]** button.

- The threshold level is displayed in the TFT display.

LVL 20

Threshold level

RTTY (RADIO TELETYPE) OPERATION

RTTY TEXT MEMORY (WITH OPTIONAL FFT UNIT)

Phrases (up to 50 characters) frequently used in RTTY transmission can be memorized by connecting the optional **FH-2** Remote Control Keypad to the rear panel REM jack. Five phrases can be stored, and the memorized content can be transmitted by operations on the **FH-2**.

TEXT MESSAGE PROGRAMMING

1. Press the **[MODE]** button to set the operating mode to RTTY.
2. Press the **FH-2 [MEM]** key. A blinking “**REC**” icon will appear in the display.
3. Press an **FH-2 [1] ~ [5]** key to select the desired RTTY Text Memory Register into which you wish to program the text, the blinking “**REC**” icon will disappear.
4. Use the **FH-2 [◀]** and **[▶]** keys to set the cursor position and use the **FH-2 [▲]** and **[▼]** keys to choose the letter/number to be programmed in each slot of the memory.

ADVICE:

You may also use the **[VFO-B/CLAR]** knob to program the message characters.

5. When the message is complete, add the “**↵**” character at the end to signify the termination of the message.
6. Press and hold in the **FH-2 [MEM]** key for one second to exit, once all characters (including “**↵**”) have been programmed.

ON-THE-AIR RTTY TEXT MESSAGE PLAYBACK

Press the **FH-2 [1] ~ [5]** key, depending on which RTTY Text Memory Register message you wish to transmit. The programmed message will be transmitted on the air.

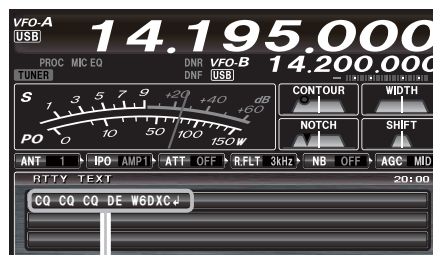

RTTY TEXT

EXAMPLE OF CONNECTING RTTY COMMUNICATIONS DEVICE

Connect the RTTY communications TU (Terminal Unit) to the rear panel RTTY/PKT terminal. Be sure to read the instructions manual of the device to connect when connecting.

See page 132 for details on the connections and settings to use the optional USB Interface Unit “**SCU-17**”.

ADVICE:

You can adjust RTTY data output level using Menu item “**096 RTTY OUT LEVEL**”.

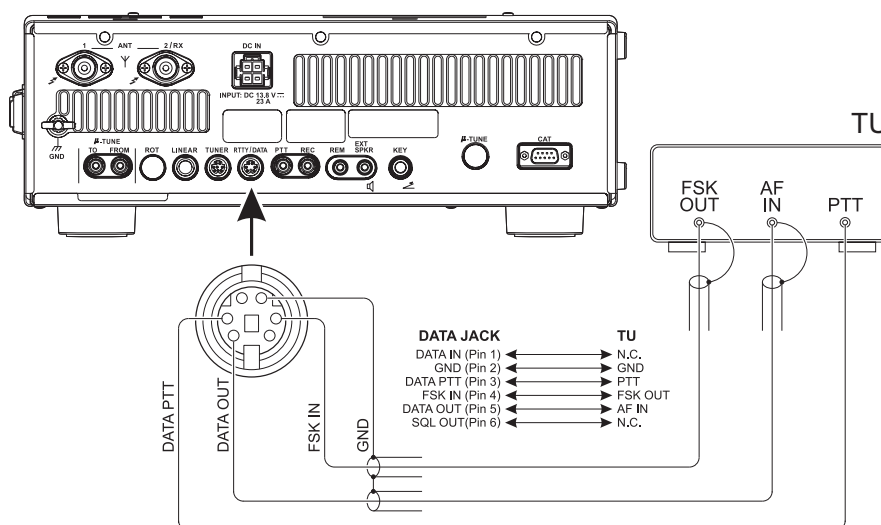

DATA (PSK) OPERATION

The **FTDX1200** has a capability of a PSK decode function when the optional FFT unit is installed. You can easily synchronize by aligning the marker on the AF-FFT screen display, together with the decode screen while receiving a signal. Decoding with this transceiver supports both general BPSK and QPSK that have error correction functions.

PSK DECODE (WITH OPTIONAL FFT UNIT)

1. Press the [MODE] switch, set the operating mode to "DATA USB".

ADVICE:

Press and hold the [MODE] switch for approximately one second to switch back and forth between "DATA USB" and "DATA LSB".

2. When you have configured Menu item "069 DATA MODE" to "PSK", and "194 PSK MODE" to "BPSK" or "QPSK".
3. Receive a PSK signal, and press and hold the [SCOPE] switch for one second or longer. The PSK DECODE screen displays, and the decoded text is displayed on the screen.

ADVICE:

- Align the peak of the received signal with the marker of the AF-FFT screen.
- If text is displayed due to noise and band clutter, when a PSK signal is not being received, turn the [VFO-B/CLAR] knob to adjust and threshold level.

NOTE:

- Cross talk, noise, phasing, and the like may prevent reliable decoding of the message.
- You can set the data output level of data communications (PSK31, SSTV, etc.) using Menu item "078 DATA OUT LEVEL".
- If continuously sending for more than a few minutes or if sending time is longer than receiving time, reduce the transmit power output to between 1/2 and 1/3 using Menu item "177 TX MAX POWER".

To cancel the PSK decode function, press and hold the [SCOPE] switch again for one second or longer.

Displays the decoded PSK signal.

Displays content written to the PSK text memory*



AF-FFT display (see page 40)
("Spectrum" or "Waterfall" display)

※ If you transmit content written to the PSK text memory (page 106), the transmitted PSK signal is displayed as text.

Note that transmitted text is displayed in white.

Threshold Level Adjustment

Scrambled text may be displayed due to noise and band clutter, when a signal is not being received. You can adjust the threshold level so scrambled text is not displayed.

Turn the [VFO-B/CLAR] knob, and adjust the threshold level (between 0 and 100) so scrambled text is not displayed due to noise.

- Note that text will no longer be displayed for weak signals if you increase the level too much.
- You switch between threshold level display and normal display each time you press the [SELECT] button.

- The threshold level is displayed in the TFT display.

LVL 20

Threshold level

DATA (PSK) OPERATION

PSK TEXT MEMORY (WITH OPTIONAL FFT UNIT)

Phrases (up to 50 characters) frequently used in PSK transmissions can be recorded by connecting the optional **FH-2** Remote Control Keypad to the rear panel REM jack. 5 memory channels may be recorded, and the memorized content can be transmitted by operations on the **FH-2**.

TEXT MESSAGE PROGRAMMING

1. Press the **[MODE]** button to set the operating mode to DATA.
2. Press the **FH-2 [MEM]** key. A blinking “**REC**” icon will appear in the display.
3. Press an **FH-2 [1] ~ [5]** key to select the desired PSK Text Memory Register into which you wish to program the text, the blinking “**REC**” icon will disappear.
4. Use the **FH-2 [◀]** and **[▶]** keys to set the cursor position and use the **FH-2 [▲]** and **[▼]** keys to choose the letter/number to be programmed in each slot of the memory.

ADVICE:

You may also use the **[VFO-B/CLAR]** knob to program the message characters.

5. When the message is complete, add the “**↵**” character at the end to signify the termination of the message.
6. Press and hold in the **FH-2 [MEM]** key for one second to exit, once all characters (including “**↵**”) have been programmed.

ON-THE-AIR PSK TEXT MESSAGE PLAYBACK

Press the **FH-2 [1] ~ [5]** key, depending on which PSK Text Memory Register message you wish to transmit. The programmed message will be transmitted on the air.

ADVICE:

You can adjust the PSK transmit ALC by turning the **[MIC/SPEED]** knob.

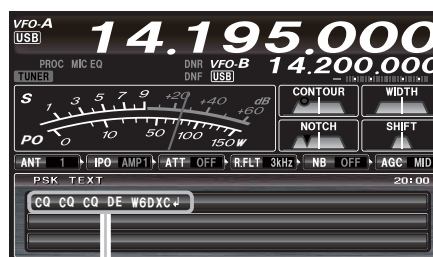

PSK TEXT

EXAMPLE OF DATA COMMUNICATIONS DEVICE

You can use commercial and free computer software for PSK data communications. See the illustration below for connection to your computer.

Be sure to read the instruction manual of the device to be connected to the radio and computer.

See page 132 for details on the connections and settings to use the optional USB Interface Unit “**SCU-17**”.

ADVICE:

- You can set the data output level for data communications (PSK31, SSTV, etc.) using Menu item “078 DATA OUT LEVEL”.
- You can set VOX DELAY in VOX operation for data communications (PSK31, SSTV, etc.) using Menu item “080 DATA VOX DELAY”. You can also set data input VOX gain using Menu item “079 DATA VOX GAIN”.

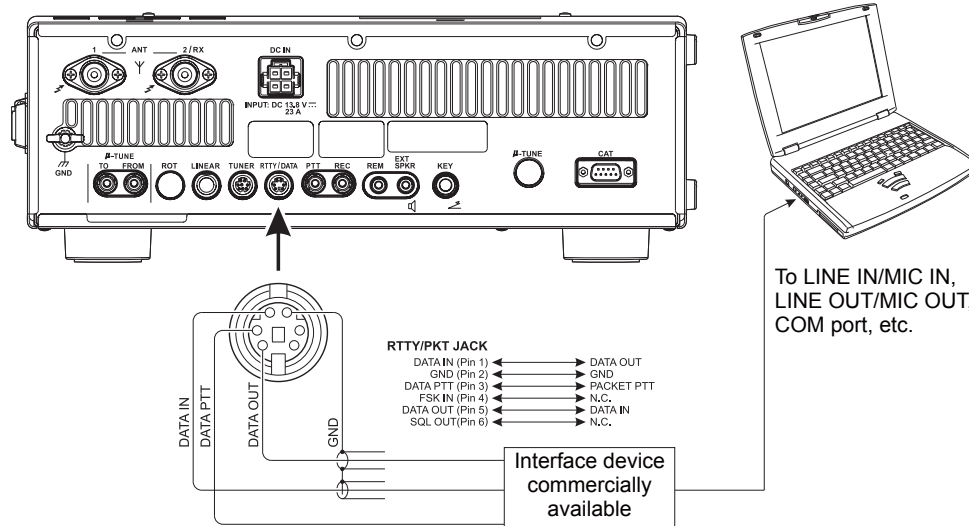

The Menu system of the **FTdx1200** provides extensive customization capability, so you can set up your transceiver just the way you want to operate it. The Menu items are grouped by general utilization category, and are numbered from “001 AGC” to “196 E/D PSK”.

Using the Menu

1. Press the **[MENU]** button to engage the Menu mode.
The display will show the Menu Number, the Menu Group Name and the Menu Item.
2. Rotate the **[VFO-B/CLAR]** knob (or press the **▲/▼** button) to select the Menu item you wish to modify.
3. Press the **[SELECT]** button, then rotate the **[VFO-B/CLAR]** knob (or press the **▲/▼** button) to change the current setting of the selected Menu item.

ADVICE:

Press the **[CLEAR]** button (located on the upper right of the **[VFO-B/CLAR]** knob) momentarily to reset the selected Menu item to the factory default value.

4. When you have finished making your adjustments, press the **[SELECT]** button, then press the **[MENU]** button to save the new setting and exit to normal operation. If you only *momentarily* press the **[MENU]** button, the new settings will *not* be retained.

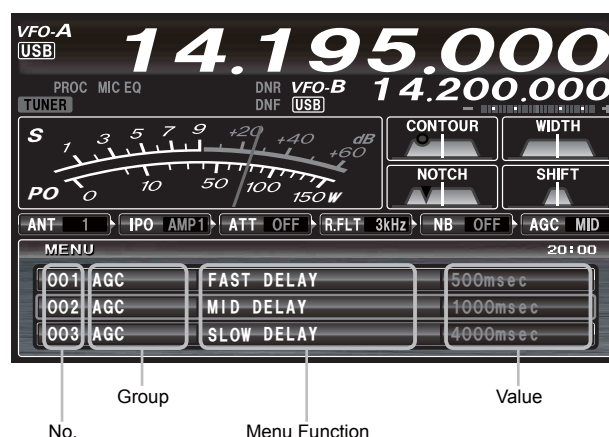
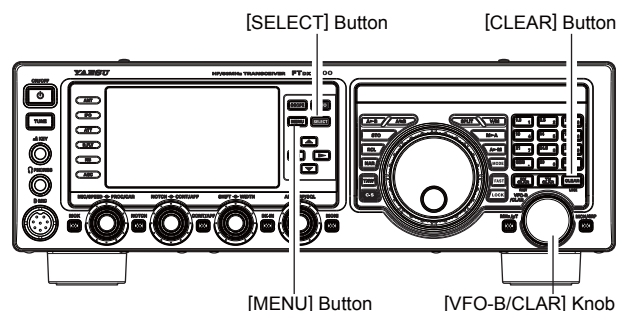

MENU MODE RESET

You may reset all the Menu settings to their original factory defaults, if desired.

1. Turn the front panel **[POWER]** switch off.
2. Press and hold in the **[MENU]** button, and while holding it in, press the **[POWER]** switch to turn the transceiver back on. Now release the **[MENU]** button.

MENU MODE

Group	No. Menu Function	Available Values	Default Setting
AGC	001 FAST DELAY	20 ~ 4000 (20msec/step)	500msec
AGC	002 MID DELAY	20 ~ 4000 (20msec/step)	1000msec
AGC	003 SLOW DELAY	20 ~ 4000 (20msec/step)	4000msec
AGC	004 AGC SLOPE	NORMAL/SLOPE	NORMAL
DISPLAY	005 MY CALL	Max 12 characters	FTDX1200
DISPLAY	006 MY CALL TIME	OFF ~ 5 (sec)	1sec
DISPLAY	007 VFO COLOR	BLUE/SKY BLUE/GREEN/PURPLE/RED/ ORANGE/GRAY/BLACK	BLUE
DISPLAY	008 TFT LAYOUT	TYPE1/TYPE2	TYPE1
DISPLAY	009 DIMMER LED	1 / 2	2
DISPLAY	010 DIMMER TFT	0 ~ 15	8
DISPLAY	011 BAR DISPLAY SELECT	CLAR/CW TUNE/ μ TUNE	CW TUNE
DISPLAY	012 METER TYPE SELECT	ANALOG/BAR	ANALOG
DISPLAY	013 BAR MTR PEAK HOLD	OFF/0.5/1.0/2.0 (sec)	OFF
DISPLAY ^{*1}	014 ROTATOR START UP	0/90/180/270 (degree)	0
DISPLAY ^{*1}	015 ROTATOR OFFSET ADJ	-30 ~ 0	0
DVS ^{*2}	016 RX OUT LEVEL	0 ~ 100	50
DVS ^{*2}	017 TX OUT LEVEL	0 ~ 100	50
KEYER	018 F KEYER TYPE	OFF/BUG/ELEKEY/ACS	ELEKEY
KEYER	019 F CW KEYER	NOR/REV	NOR
KEYER	020 R KEYER TYPE	OFF/BUG/ELEKEY/ACS	ELEKEY
KEYER	021 R CW KEYER	NOR/REV	NOR
KEYER	022 ELEKEY TYPE	ELEKEY-A/ELEKEY-B	ELEKEY-B
KEYER	023 CW WEIGHT	2.5 ~ 3.0 ~ 4.5	3.0
KEYER	024 BEACON TIME	OFF/1 ~ 690 (sec)	OFF
KEYER	025 NUMBER STYLE	1290/AUNO/AUNT/A2NO/A2NT/12NO/12NT	1290
KEYER	026 CONTEST NUMBER	0 ~ 9999	1
KEYER	027 CW MEMORY 1	TEXT/MESSAGE	MESSAGE
KEYER	028 CW MEMORY 2	TEXT/MESSAGE	MESSAGE
KEYER	029 CW MEMORY 3	TEXT/MESSAGE	MESSAGE
KEYER	030 CW MEMORY 4	TEXT/MESSAGE	TEXT
KEYER	031 CW MEMORY 5	TEXT/MESSAGE	TEXT
GENERAL	032 ANT SELECT	BAND/STACK	BAND
GENERAL	033 ANT2 SETTING	TRX / R2/1	TRX
GENERAL	034 NB LEVEL	0 ~ 100	50
GENERAL	035 BEEP LEVEL	0 ~ 100	50
GENERAL	036 MONITOR LEVEL	0 ~ 100	50
GENERAL	037 MOX	ENABLE/DISABLE	ENABLE
GENERAL	038 RF/SQL VR	RF/SQL	RF
GENERAL	039 CAT RATE	4800/9600/19200/38400 (bps)	4800bps
GENERAL	040 CAT TIME OUT TIMER	10/100/1000/3000 (msec)	10msec
GENERAL	041 CAT RTS	ENABLE/DISABLE	ENABLE
GENERAL	042 MEM GROUP	ENABLE/DISABLE	DISABLE
GENERAL	043 QUICK SPLIT FREQ	-20 ~ +20 (kHz)	5kHz
GENERAL	044 TXW DIAL SELECT	VFO-A/VFO-B	VFO-B
GENERAL	045 TX TIME OUT TIMER	OFF/1 ~ 30 (min)	OFF
GENERAL ^{*3}	046 μ TUNE DIAL STEP	DIAL STEP-2/DIAL STEP-1	DIAL STEP-1
GENERAL	047 MIC SCAN	ENABLE/DISABLE	ENABLE
GENERAL	048 MIC SCAN RESUME	PAUSE/TIME	TIME
GENERAL	049 FREQ ADJ	-25 ~ 0 ~ +25	0
MODE-AM	050 AM LCUT FREQ	OFF/100Hz ~ 1000Hz (50Hz/step)	OFF
MODE-AM	051 AM LCUT SLOPE	6dB/oct / 18dB/oct	6dB/oct
MODE-AM	052 AM HCUT FREQ	700Hz ~ 4000Hz (50Hz/step) / OFF	OFF

※ 1: Requires optional Antenna Rotator.

※ 2: Requires optional DVS-6 Voice Memory Unit.

※ 3: Requires optional RF μ Tuning Kit.

Group	No. Menu Function	Available Values	Default Setting
MODE-AM	053 AM HCUT SLOPE	6dB/oct / 18dB/oct	6dB/oct
MODE-AM	054 AM MIC GAIN	MCVR/FIX (0 ~ 100)	30
MODE-AM	055 AM MIC SEL	FRONT/DATA	FRONT
MODE-CW	056 CW PITCH	300 ~ 1050 (10Hz/step)	700Hz
MODE-CW	057 CW LCUT FREQ	OFF/100 ~ 1000 (50Hz/step)	250Hz
MODE-CW	058 CW LCUT SLOPE	6dB/oct / 18dB/oct	18dB/oct
MODE-CW	059 CW HCUT FREQ	700 ~ 4000 (50Hz/step) / OFF	1200Hz
MODE-CW	060 CW HCUT SLOPE	6dB/oct / 18dB/oct	18dB/oct
MODE-CW	061 CW AUTO MODE	OFF/50M/ON	OFF
MODE-CW	062 CW BFO	USB/LSB/AUTO	USB
MODE-CW	063 CW BK-IN	SEMI/FULL	SEMI
MODE-CW	064 CW BK-IN DELAY	30 ~ 3000 (msec)	200msec
MODE-CW	065 CW WAVE SHAPE	1/2/4/6 (msec)	4msec
MODE-CW	066 CW FREQ DISPLAY	DIRECT FREQ/PITCH OFFSET	PITCH OFFSET
MODE-CW	067 PC KEYING	OFF/ON	OFF
MODE-CW	068 QSK	15/20/25/30 (msec)	15msec
MODE-DATA	069 DATA MODE	PSK/OTHERS	PSK
MODE-DATA	070 PSK TONE	1000/1500/2000 (Hz)	1000Hz
MODE-DATA	071 OTHER DISP (SSB)	-3000 ~ 0 ~ +3000 (10Hz/step)	0Hz
MODE-DATA	072 OTHER SHIFT (SSB)	-3000 ~ 0 ~ +3000 (10Hz/step)	1000Hz
MODE-DATA	073 DATA LCUT FREQ	OFF/100 ~ 1000 (50Hz/step)	300Hz
MODE-DATA	074 DATA LCUT SLOPE	6dB/oct / 18dB/oct	18dB/oct
MODE-DATA	075 DATA HCUT FREQ	700 ~ 4000 (50Hz/step) / OFF	3000Hz
MODE-DATA	076 DATA HCUT SLOPE	6dB/oct / 18dB/oct	18dB/oct
MODE-DATA	077 DATA MIC GAIN	MCVR/FIX (0 ~ 100)	MCVR
MODE-DATA	078 DATA OUT LEVEL	0 ~ 100	50
MODE-DATA	079 DATA VOX GAIN	0 ~ 100	50
MODE-DATA	080 DATA VOX DELAY	30 ~ 300 ~ 3000 (msec)	300msec
MODE-FM	081 FM LCUT FREQ	OFF/100 ~ 1000 (50Hz/step)	250Hz
MODE-FM	082 FM LCUT SLOPE	6dB/oct / 18dB/oct	18dB/oct
MODE-FM	083 FM HCUT FREQ	700 ~ 4000 (50Hz/step) / OFF	OFF
MODE-FM	084 FM HCUT SLOPE	6dB/oct / 18dB/oct	6dB/oct
MODE-FM	085 FM MIC GAIN	MCVR/FIX (0 ~ 100)	30
MODE-FM	086 FM MIC SEL	FRONT/DATA	FRONT
MODE-FM	087 RPT SHIFT (28MHz)	0 ~ 100 ~ 1000 (10kHz/step)	100kHz
MODE-FM	088 RPT SHIFT (50MHz)	0 ~ 100 ~ 1000 ~ 4000 (10kHz/step)	1000kHz
MODE-FM	089 TONE FREQ	67.0 ~ 254.1 (Hz)	67.0Hz
MODE-RTTY	090 RTTY LCUT FREQ	OFF/100 ~ 1000 (50Hz/step)	300Hz
MODE-RTTY	091 RTTY LCUT SLOPE	6dB/oct / 18dB/oct	18dB/oct
MODE-RTTY	092 RTTY HCUT FREQ	700 ~ 4000 (50Hz/step) / OFF	3000Hz
MODE-RTTY	093 RTTY HCUT SLOPE	6dB/oct / 18dB/oct	18dB/oct
MODE-RTTY	094 POLARITY-R	NOR/REV	NOR
MODE-RTTY	095 POLARITY-T	NOR/REV	NOR
MODE-RTTY	096 RTTY OUT LEVEL	0 ~ 100	50
MODE-RTTY	097 RTTY SHIFT	170/200/425/850 (Hz)	170Hz
MODE-RTTY	098 RTTY MARK FREQ	1275/2125 (Hz)	2125Hz
MODE-SSB	099 SSB LCUT FREQ	OFF/100 ~ 1000 (50Hz/step)	200Hz
MODE-SSB	100 SSB LCUT SLOPE	6dB/oct / 18dB/oct	6dB/oct
MODE-SSB	101 SSB HCUT FREQ	700 ~ 4000 (50Hz/step) / OFF	3000Hz
MODE-SSB	102 SSB HCUT SLOPE	6dB/oct / 18dB/oct	18dB/oct
MODE-SSB	103 SSB MIC SEL	FRONT/DATA	FRONT
MODE-SSB	104 SSB TX BPF	100-3000Hz/100-2900Hz/200-2800Hz/ 300-2700Hz/400-2600Hz/3000WB	300-2700Hz
MODE-SSB	105 LSB RX CARRIER	-200 ~ 0 ~ +200 (10Hz/step)	0Hz
MODE-SSB	106 USB RX CARRIER	-200 ~ 0 ~ +200 (10Hz/step)	0Hz

MENU MODE

Group	No. Menu Function	Available Values	Default Setting
RX DSP	107 APF WIDTH	NARROW/MEDIUM/WIDE	MEDIUM
RX DSP	108 CONTOUR LEVEL	-40 ~ 0 ~ 20	-15
RX DSP	109 CONTOUR WIDTH	1 ~ 11	10
RX DSP	110 DNR LEVEL	1 - 15	3
RX DSP	111 IF NOTCH WIDTH	NARROW/WIDE	WIDE
RX DSP	112 HF CW SHAPE	SOFT/SHARP	SOFT
RX DSP	113 HF CW SLOPE	STEEP/MEDIUM/GENTLE	MEDIUM
RX DSP	114 6M CW SHAPE	SOFT/SHARP	SOFT
RX DSP	115 6M CW SLOPE	STEEP/MEDIUM/GENTLE	MEDIUM
RX DSP	116 HF PSK SHAPE	SOFT/SHARP	SHARP
RX DSP	117 HF PSK SLOPE	STEEP/MEDIUM/GENTLE	MEDIUM
RX DSP	118 HF FSK SHAPE	SOFT/SHARP	SHARP
RX DSP	119 HF FSK SLOPE	STEEP/MEDIUM/GENTLE	MEDIUM
RX DSP	120 HF SSB SHAPE	SOFT/SHARP	SHARP
RX DSP	121 HF SSB SLOPE	STEEP/MEDIUM/GENTLE	MEDIUM
RX DSP	122 6M SSB SHAPE	SOFT/SHARP	SOFT
RX DSP	123 6M SSB SLOPE	STEEP/MEDIUM/GENTLE	MEDIUM
SCOPE	124 SCOPE MODE	CENTER/FIX	CENTER
SCOPE	125 SCOPE SPEED	FAST/SLOW	FAST
SCOPE	126 SCOPE AUTO TIME	OFF/3/5/10/30/60 (sec)	OFF
SCOPE	127 START DIAL SPEED	0.5/1/2/4/8/16 (kHz/sec)	8kHz/sec
SCOPE	128 CENTER SPAN FREQ	20/50/100/200/500/1000 (kHz)	100kHz
SCOPE	129 FIX 1.8MHz	1800 ~ 1999 (1kHz/step)	1800kHz
SCOPE	130 FIX 1.8MHz SPAN	20/50/100/200/500/1000 (kHz)	200kHz
SCOPE	131 FIX 3.5MHz	3500 ~ 3999 (1kHz/step)	3500kHz
SCOPE	132 FIX 3.5MHz SPAN	20/50/100/200/500/1000 (kHz)	500kHz
SCOPE	133 FIX 5.0MHz	5250 ~ 5499 (1kHz/step)	5250kHz
SCOPE	134 FIX 5.0MHz SPAN	20/50/100/200/500/1000 (kHz)	200kHz
SCOPE	135 FIX 7.0MHz	7000 ~ 7299 (1kHz/step)	7000kHz
SCOPE	136 FIX 7.0MHz SPAN	20/50/100/200/500/1000 (kHz)	500kHz
SCOPE	137 FIX 10MHz	10100 ~ 10149 (1kHz/step)	10100kHz
SCOPE	138 FIX 10MHz SPAN	20/50/100/200/500/1000 (kHz)	50kHz
SCOPE	139 FIX 14MHz	14000 ~ 14349 (1kHz/step)	14000kHz
SCOPE	140 FIX 14MHz SPAN	20/50/100/200/500/1000 (kHz)	500kHz
SCOPE	141 FIX 18MHz	18000 ~ 18199 (1kHz/step)	18068kHz
SCOPE	142 FIX 18MHz SPAN	20/50/100/200/500/1000 (kHz)	100kHz
SCOPE	143 FIX 21MHz	21000 ~ 21449 (1kHz/step)	21000kHz
SCOPE	144 FIX 21MHz SPAN	20/50/100/200/500/1000 (kHz)	500kHz
SCOPE	145 FIX 24MHz	24800 ~ 24989 (1kHz/step)	24890kHz
SCOPE	146 FIX 24MHz SPAN	20/50/100/200/500/1000 (kHz)	100kHz
SCOPE	147 FIX 28MHz	28000 ~ 29699 (1kHz/step)	28000kHz
SCOPE	148 FIX 28MHz SPAN	20/50/100/200/500/1000 (kHz)	1000kHz
SCOPE	149 FIX 50MHz	50000 ~ 53999 (1kHz/step)	50000kHz
SCOPE	150 FIX 50MHz SPAN	20/50/100/200/500/1000 (kHz)	1000kHz
TUNING	151 CW DIAL STEP	1/5/10 (Hz)	10Hz
TUNING	152 DATA DIAL STEP	1/5/10 (Hz)	5Hz
TUNING	153 AM/FM DIAL STEP	10/100 (Hz)	100Hz
TUNING	154 RTTY DIAL STEP	1/5/10 (Hz)	5Hz
TUNING	155 SSB DIAL STEP	1/5/10 (Hz)	10Hz
TUNING	156 AM CH STEP	2.5/5/9/10/12.5 (kHz)	5kHz
TUNING	157 FM CH STEP	5/6.25/10/12.5/20/25 (kHz)	5kHz
TUNING	158 1MHz/100kHz SELECT	1MHz/100kHz	1MHz
TX AUDIO	159 PRMTRC EQ1 FREQ	100/200/300/400/500/600/700	200
TX AUDIO	160 PRMTRC EQ1 LEVEL	-20 ~ 0 ~ +10	0
TX AUDIO	161 PRMTRC EQ1 BWTH	1 ~ 10	1

Group	No. Menu Function	Available Values	Default Setting
TX AUDIO	162 PRMTRC EQ2 FREQ	700 ~ 1500 (100 Hz/step)	800
TX AUDIO	163 PRMTRC EQ2 LEVEL	-20 ~ 0 ~ +10	0
TX AUDIO	164 PRMTRC EQ2 BWTH	1 ~ 10	1
TX AUDIO	165 PRMTRC EQ3 FREQ	1500 ~ 3200 (100 Hz/step)	2100
TX AUDIO	166 PRMTRC EQ3 LEVEL	-20 ~ 0 ~ +10	5
TX AUDIO	167 PRMTRC EQ3 BWTH	1 ~ 10	1
TX AUDIO	168 P-PRMTRC EQ1 FREQ	100 ~ 700 (100 Hz/step)	200
TX AUDIO	169 P-PRMTRC EQ1 LEVEL	-20 ~ 0 ~ +10	-3
TX AUDIO	170 P-PRMTRC EQ1 BWTH	1 ~ 10	2
TX AUDIO	171 P-PRMTRC EQ2 FREQ	700 ~ 1500 (100 Hz/step)	800
TX AUDIO	172 P-PRMTRC EQ2 LEVEL	-20 ~ 0 ~ +10	0
TX AUDIO	173 P-PRMTRC EQ2 BWTH	1 ~ 10	1
TX AUDIO	174 P-PRMTRC EQ3 FREQ	1500 ~ 3200 (100 Hz/step)	2100
TX AUDIO	175 P-PRMTRC EQ3 LEVEL	-20 ~ 0 ~ +10	5
TX AUDIO	176 P-PRMTRC EQ3 BWTH	1 ~ 10	1
TX GNRL	177 TX MAX POWER	5 ~ 100	100
TX GNRL	178 EXT AMP TUNING PWR	10/20/50/100	100W
TX GNRL	179 TUNER SELECT	INTERNAL/EXTERNAL	INTERNAL
TX GNRL	180 VOX SELECT	MIC/DATA	MIC
TX GNRL	181 VOX GAIN	0 ~ 100	50
TX GNRL	182 VOX DELAY	30 ~ 3000 (msec)	500msec
TX GNRL	183 ANTI VOX GAIN	0 ~ 100	50
TX GNRL	184 EMERGENCY FREQ TX	ENABLE/DISABLE	DISABLE
AF SCOPE	185 FFT DISPLAY MODE	SPECTRUM/WATER FALL	SPECTRUM
AF SCOPE	186 FFT ATT	0/10/20 (dB)	10dB
DEC CW	187 CW DECODE BW	25/50/100/250 (Hz)	100Hz
E/D RTTY	188 RX USOS	ENABLE/DISABLE	ENABLE
E/D RTTY	189 TX USOS	ENABLE/DISABLE	ENABLE
E/D RTTY	190 RX NEW LINE CODE	CR,LF,CR+LF/CR+LF	CR,LF,CR+LF
E/D RTTY	191 TX AUTO CR+LF	ENABLE/DISABLE	ENABLE
E/D RTTY	192 TX DIDDLE	OFF/BLANK/LTRS	BLANK
E/D RTTY	193 BAUDOT CODE	CCITT/US	US
E/D PSK	194 PSK MODE	BPSK/QPSK	BPSK
E/D PSK	195 DECODE AFC RANGE	8/15/30 (Hz)	15Hz
E/D PSK	196 QPSK POLARITY REV	RX-N,TX-N / RX-R,TX-N / RX-N,TX-R RX-R,TX-R	RX-N,TX-N

AGC GROUP

001 FAST DELAY

Function: Sets the delay time for the AGC FAST mode.
Available Values: 20 ~ 4000 msec (20 msec/step)
Default Setting: 500 msec

002 MID DELAY

Function: Sets the delay time for the AGC MID mode.
Available Values: 20 ~ 4000 msec (20 msec/step)
Default Setting: 1000 msec

003 SLOW DELAY

Function: Sets the delay time for the AGC SLOW mode.
Available Values: 20 ~ 4000 msec (20 msec/step)
Default Setting: 4000 msec

004 AGC SLOPE

Function: Select the gain curve of the AGC amplifier.
Available Values: NORMAL/SLOPE
Default Setting: NORMAL
NORMAL: The AGC output level will follow a linear response to the antenna input level, while AGC is activated.
SLOPE: The AGC output level will increase at 1/10 the rate of the antenna input level, while AGC is activated.

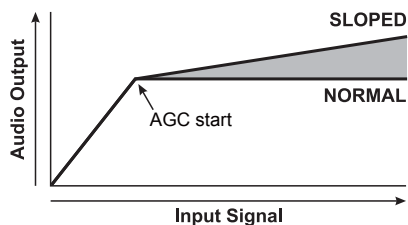

DISPLAY GROUP

005 MY CALL

Function: Programs your Call Sign.
Available Values: Max 12 characters
Default Setting: FTDX1200

006 MY CALL TIME

Function: Programs the display period of your Call Sign.
Available Values: OFF ~ 5 sec
Default Setting: 1 sec

007 VFO COLOR

Function: Selects the VFO-A frequency background color.
Available Values: BLUE / SKY BLUE / GREEN / PURPLE / RED / ORANGE / GRAY / BLACK
Default Setting: BLUE

008 TFT LAYOUT

Function: Set the positions of the frequency display and meter display.
Available Values: TYPE1 / TYPE2
Default Setting: TYPE1
TYPE1: Displays the frequency display at the top of the TFT display.
TYPE2: Displays the frequency display below the S/PO meter and the DSP display.

009 DIMMER LED

Function: Sets the indicator illumination level.
Available Values: 1 / 2
Default Setting: 2
Adjusts the illumination level of the indicator located on the above of the Main Tuning Dial knob. You may observe the effects of the changes as you adjust the level setting. The higher the setting, the brighter the illumination becomes.

010 DIMMER TFT

Function: Setting of the TFT display brightness level.
Available Values: 0 ~ 15
Default Setting: 8

011 BAR DISPLAY SELECT

Function: Selects one of three parameters to be viewed on the Tuning Offset Indicator.
Available Values: CLAR/CW TUNE/uTUNE
Default Setting: CW TUNE
CLAR: Displays relative clarifier offset.
CW TUNE: Displays relative tuning offset between the incoming signal and transmitted frequency while in CW operation.
uTUNE: Displays the peak position of the optional u-TUNE filter.

012 METER TYPE SELECT

Function: Selects the meter display type.
Available Values: ANALOG/BAR
Default Setting: ANALOG
ANALOG: Displays relative clarifier offset.
BAR: Displays relative tuning offset between the incoming signal and transmitted frequency while in CW operation.

013 BAR MTR PEAK HOLD

Function: Selects the peak hold time of the BAR meter.
Available Values: OFF/0.5/1.0/2.0 sec
Default Setting: OFF

014 ROTATOR START UP

Function: Selects the starting point of your rotator controller's indicator needle.
Available Values: 0/90/180/270°
Default Setting: 0°
Advice: If the optional Antenna Rotator is not connected, this adjustment has no effect.

015 ROTATOR OFFSET ADJ

Function: Adjusts the indicator needle precisely to the starting point set in menu item "014 ROTATOR START UP".

Available Values: $-30^{\circ} \sim 0^{\circ}$ ($2^{\circ}/\text{step}$)

Default Setting: 0°

Advice: If the optional Antenna Rotator is not connected, this adjustment has no effect.

DVS GROUP

016 RX OUT LEVEL

Function: Sets the audio output level from the optional DVS-6 Voice Memory Unit.

Available Values: 0 ~ 100

Default: 50

Advice:

If the optional DVS-6 Voice Memory Unit is not connected, this adjustment has no effect.

017 TX OUT LVL

Function: Sets the microphone input level to the optional DVS-6 Voice Memory Unit

Available Values: 0 ~ 100

Default: 50

Advice:

If the optional DVS-6 Voice Memory Unit is not connected, this adjustment has no effect.

KEYER GROUP

018 F KEYER TYPE

Function: Selects the desired keyer operation mode for the device connected to the front panel KEY jack.

Available Values: OFF/BUG/ELEKEY/ACS

Default Setting: ELEKEY

OFF: Disables the front panel keyer ("straight key" mode for use with external keyer or computer-driven keying interface).

BUG: Mechanical "bug" keyer emulation. One paddle produces "dits" automatically, while the other paddle manually produces "dahs".

ELEKEY: Iambic keyer with ACS (Automatic Character Spacing) disabled.

ACS: Iambic keyer with ACS (Automatic Character Spacing) enabled.

019 F CW KEYER

Function: Selects the keyer paddle wiring configuration for the KEY jack on the front panel.

Available Values: NOR/REV

Default Setting: NOR

NOR: Tip = Dot, Ring = Dash, Shaft = Ground

REV: Tip = Dash, Ring = Dot, Shaft = Ground

020 R KEYER TYPE

Function: Selects the desired keyer operation mode for the device connected to the rear panel KEY jack.

Available Values: OFF/BUG/ELEKEY/ACS

Default Setting: ELEKEY

OFF: Disables the rear panel keyer ("straight key" mode for use with external keyer or computer-driven keying interface).

BUG: Mechanical "bug" keyer emulation. One paddle produces "dits" automatically, while the other paddle manually produces "dahs".

ELEKEY: Iambic keyer with ACS (Automatic Character Spacing) disabled.

ACS: Iambic keyer with ACS (Automatic Character Spacing) enabled.

021 R CW KEYER

Function: Selects the keyer paddle wiring configuration for the KEY jack on the rear panel.

Available Values: NOR/REV

Default Setting: NOR

NOR: Tip = Dot, Ring = Dash, Shaft = Ground

REV: Tip = Dash, Ring = Dot, Shaft = Ground

022 ELEKEY TYPE

Function: Selects the operation mode of the internal keyer.

Available Values: ELEKEY-A/ELEKEY-B

Default Setting: ELEKEY-B

023 CW WEIGHT

Function: Sets the Dot:Dash ratio for the built-in electronic keyer.

Available Values: (1:) 2.5 ~ 4.5

Default Setting: 3.0

024 BEACON TIME

Function: Sets the interval time between repeats of the beacon message.

Available Values: OFF/1 ~ 240 sec (1 sec/step)/270 ~ 690 sec (30 sec/step)

Default Setting: OFF

025 NUMBER STYLE

Function: Selects the Contest Number “Cut” format for an imbedded contest number.

Available Values: 1290/AUNO/AUNT/A2NO/A2NT/12NO/12NT

Default Setting: 1290

1290: Does not abbreviate the Contest Number

AUNO: Abbreviates to “A” for “One”, “U” for “Two”, “N” for “Nine”, and “O” for “Zero”.

AUNT: Abbreviates to “A” for “One”, “U” for “Two”, “N” for “Nine”, and “T” for “Zero”.

A2NO: Abbreviates to “A” for “One”, “N” for “Nine”, and “O” for “Zero”.

A2NT: Abbreviates to “A” for “One”, “N” for “Nine”, and “T” for “Zero”.

12NO: Abbreviates to “N” for “Nine”, and “O” for “Zero”.

12NT: Abbreviates to “N” for “Nine”, and “T” for “Zero”.

026 CONTEST NUMBER

Function: Enters the initial contest number that will increment/decrement after sending during contest QSOs.

Available Values: 0 ~ 9999

Default Setting: 1

027 CW MEMORY 1

Function: Permits entry of the CW message for message register 1.

Available Values: TEXT/MESSAGE

Default Setting: MESSAGE

TEXT: You may enter the CW message from the FH-2.

MESSAGE: You may enter the CW message from the CW keyer.

028 CW MEMORY 2

Function: Permits entry of the CW message for message register 2.

Available Values: TEXT/MESSAGE

Default Setting: MESSAGE

TEXT: You may enter the CW message from the FH-2.

MESSAGE: You may enter the CW message from the CW keyer.

029 CW MEMORY 3

Function: Permits entry of the CW message for message register 3.

Available Values: TEXT/MESSAGE

Default Setting: MESSAGE

TEXT: You may enter the CW message from the FH-2.

MESSAGE: You may enter the CW message from the CW keyer.

030 CW MEMORY 4

Function: Permits entry of the CW message for message register 4.

Available Values: TEXT/MESSAGE

Default Setting: TEXT

TEXT: You may enter the CW message from the FH-2.

MESSAGE: You may enter the CW message from the CW keyer.

031 CW MEMORY 5

Function: Permits entry of the CW message for message register 5.

Available Values: TEXT/MESSAGE

Default Setting: TEXT

TEXT: You may enter the CW message from the FH-2.

MESSAGE: You may enter the CW message from the CW keyer.

GENERAL GROUP

032 ANT SELECT

Function: Sets the method of antenna selection.

Available Values: BAND/STACK

Default Setting: BAND

BAND: The antenna is selected in accordance with the operating band.

STACK: The antenna is selected in accordance with the band stack (different antennas may be utilized on the same band, if so selected in the band stack).

033 ANT2 SETTING

Function: Selects the operation mode of the ANT 2 connector.

Available Values: TRX / R2/1

Default Setting: TRX

TRX: ANT2 used for TX and RX

R2/1: ANT2 used for RX only

034 NB LEVEL

Function: Adjusts the noise blanking level of the IF Noise Blanker for short duration pulse noise.

Available Values: 0 ~ 100

Default Setting: 50

035 BEEP LEVEL

Function: Sets the beep level.

Available Values: 0 ~ 100

Default Setting: 50

036 MONITOR LEVEL

Function: Sets the Monitor level.

Available Values: 0 ~ 100

Default Setting: 50

037 MOX

Function: Enables/disables the MOX operation.

Available Values: ENABLE/DISABLE

Default Setting: ENABLE

038 RF SQL VR

Function: Selects the operation mode of the RF/SQL knob.

Available Values: RF/SQL

Default Setting: RF

039 CAT RATE

Function: Sets the transceiver computer-interface circuitry for the CAT baud rate to be used.

Available Values: 4800/9600/19200/38400 bps

Default Setting: 4800 bps

040 CAT TIME OUT TIMER

Function: Sets the Time-Out Timer countdown time for a CAT command input.

Available Values: 10/100/1000/3000 msec

Default Setting: 10 msec

The Time-Out Timer shuts off the CAT data input after a continuous transmission of the programmed time.

041 CAT RTS

Function: Enables/Disables the RTS port of the CAT jack.

Available Values: ENABLE/DISABLE

Default Setting: ENABLE

042 MEM GRP

Function: Enables/Disables Memory Group Operation.

Available Values: ENABLE/DISABLE

Default Setting: DISABLE

043 QUICK SPLIT FREQ

Function: Selects the tuning offset for the Quick Split feature.

Available Values: -20 ~ 0 ~ +20 kHz (1 kHz Step)

Default Setting: +5 kHz

044 TXW DIAL SELECT

Function: Selects the knob for tuning of the TXW frequency during SPLIT operation.

Available Values: VFO-A/VFO-B

Default Setting: VFO-B

VFO-A: The TX frequency is tuned with the Main Tuning Dial knob.

VFO-B: The TX frequency is tuned with the [VFO-B/CLAR] knob.

045 TX TIME OUT TIMER

Function: Sets the Time-Out Timer countdown time.

Available Values: OFF/1 ~ 30 min

Default Setting: OFF

The Time-Out Timer shuts off the transmitter after continuous transmission of the programmed time.

046 μ TUNE DIAL STEP

Function: Selects the μ -TUNE mode.

Available Values: DIAL STEP-1/DIAL STEP-2

Default Setting: DIAL STEP-1

DIAL STEP-1: Activates the μ -TUNE system using “COARSE” steps of the [VFO-B/CLAR] knob (2 steps/click) on the 7 MHz and lower amateur bands. On the 10/14 MHz bands, “FINE” [VFO-B/CLAR] knob steps will be used (1 step/click).

DIAL STEP-2: Activates the μ -TUNE system using “FINE” steps of the [VFO-B/CLAR] knob (1 step/click) on the 14 MHz and lower amateur bands.

Advice: If an optional RF μ Tuning Kit is not connected, this adjustment has no effect.

047 MIC SCAN

Function: Enables/disables scanning access via the microphone [UP]/[DWN] keys.

Available Values: ENABLE/DISABLE

Default Setting: ENABLE

048 MIC SCAN RESUME

Function: Selects the Scan Resume mode.

Available Values: PAUSE/TIME

Default Setting: TIME

PAUSE: The scanner will hold until the signal disappears, then will resume after one second.

TIME: The scanner will hold for five seconds, then resume whether or not the other station is still transmitting.

049 FREQ ADJ

Function: Adjusts the reference oscillator.

Available Values: -25 ~ 0 ~ +25

Default Setting: 0

To calibrate the frequency of your radio, you will need a frequency counter or set your receiver to one of the time standard frequencies such as WWV or WWVH.

The following example describes a calibration method while receiving the WWVH time standard frequency in Hawaii.

1. Turn off both RX CLAR and TX CLAR function, before adjustment.
2. Tune the radio to 15,000.00 MHz with CW-USB mode, then adjust the AF knob to comfortable listening level.
3. Enter Set Menu Item “049 FREQ ADJ”, and then adjust the [VFO-B/CLAR] knob so that the BAR display is illumination in the center on the meter.

MODE-AM GROUP

050 AM LCUT FREQ

Function: Selects the cutoff frequency of the lower side of the RX audio filter in the AM mode.

Available Values: OFF/100 ~ 1000 Hz (50 Hz/step)

Default Setting: OFF

051 AM LCUT SLOPE

Function: Selects the filter slope of the lower side of the RX audio filter in the AM mode.

Available Values: 6dB/oct / 18dB/oct

Default Setting: 6dB/oct

052 AM HCUT FREQ

Function: Selects the cutoff frequency of the upper side of the RX audio filter in the AM mode.

Available Values: OFF/700 ~ 4000 Hz (50 Hz/step)

Default Setting: OFF

053 AM HCUT SLOPE

Function: Selects the filter slope of the upper side of the RX audio filter in the AM mode.

Available Values: 6dB/oct / 18dB/oct

Default Setting: 6dB/oct

054 AM MIC GAIN

Function: Sets the microphone gain for the AM mode.

Available Values: MVCR/0 ~ 100

Default Setting: 30

When this menu is set to "MCVR", you may adjust the microphone gain using the front panel [MIC/SPEED] knob.

055 AM MIC SEL

Function: Selects the microphone to be used in the AM mode.

Available Values: FRONT / DATA

Default Setting: FRONT

FRONT: Selects the microphone connected to the front panel MIC jack while using the AM mode.

DATA: Selects the microphone connected to pin 1 of the PACKET Jack while using the AM mode.

MODE-CW GROUP

056 CW PITCH

Function: Adjusts your preferred CW tone pitch.

Available Values: 300 ~ 1050 Hz (10 Hz/step)

Default Setting: 700 Hz

057 CW LCUT FREQ

Function: Selects the cutoff frequency of the lower side of the RX audio filter in the CW mode.

Available Values: OFF/100 ~ 1000 Hz (50 Hz/step)

Default Setting: 250

058 CW LCUT SLOPE

Function: Selects the filter slope of the lower side of the RX audio filter in the CW mode.

Available Values: 6dB/oct / 18dB/oct

Default Setting: 18dB/oct

059 CW HCUT FREQ

Function: Selects the cutoff frequency of the upper side of the RX audio filter in the CW mode.

Available Values: OFF/700 ~ 4000 Hz (50 Hz/step)

Default Setting: 1200

060 CW HCUT SLOPE

Function: Selects the filter slope of the upper side of the RX audio filter in the CW mode.

Available Values: 6dB/oct / 18dB/oct

Default Setting: 18dB/oct

061 CW AUTO MODE

Function: Enables/disables CW keying while operating on SSB.

Available Values: OFF/50M/ON

Default Setting: OFF

OFF: Disables CW keying while operating on SSB.

50: Enables CW keying only while operating SSB on 50 MHz (but not HF).

On: Enables CW keying while operating on SSB (all TX bands).

062 CW BFO

Function: Sets the CW carrier oscillator injection side for the CW mode.

Available Values: USB/LSB/AUTO

Default Setting: USB

USB: Injects the CW carrier oscillator on the USB side.

LSB: Injects the CW carrier oscillator on the LSB side.

AUTO: Injects the CW carrier oscillator on the LSB side while operating on the 7 MHz band and below, and the USB side while operating on the 10 MHz band and up.

063 CW BK-IN

Function: Sets the CW “break-in” mode.

Available Values: SEMI/FULL

Default Setting: SEMI

SEMI: The transceiver will operate in the semi break-in mode. The delay (receiver recovery) time is set via the Menu item “064 CW BK-IN DELAY”.

FULL: The transceiver will operate in the full break-in (QSK) mode.

064 CW BK-IN DELAY

Function: Adjusts the Keying Delay (receiver recovery) time on the CW mode.

Available Values: 30 ~ 3000 msec (10 msec/step)

Default Setting: 200 msec

065 CW WAVE SHAPE

Function: Selects the CW carrier wave-form shape (rise/fall times).

Available Values: 1/2/4/6 msec

Default Setting: 4 msec

066 CW FREQ DISPLAY

Function: Selects the frequency Display Format for the CW mode.

Available Values: DIRECT FREQ/PITCH OFFSET

Default Setting: PITCH OFFSET

DIRECT FREQ: Displays the receiver carrier frequency, without any offset added. When changing modes between SSB and CW, the frequency display remains constant.

PITCH OFFSET: This frequency display reflects the added BFO offset.

067 PC KEYING

Function: Enables/disables CW keying from the “DATA RTTY” terminal (pin 3) of the RTTY/DATA jack on the rear panel, while operating on the CW mode.

Available Values: OFF/ON

Default Setting: OFF

068 QSK

Function: Selects the time delay between when the PTT is keyed and the carrier is transmitted during QSK operation when using the internal keyer.

Available Values: 15/20/25/30 msec

Default Setting: 15 msec

MODE-DATA GROUP

069 DATA MODE

Function: Selects the operation mode of the DATA mode.

Available Values: PSK/OTHER

Default Setting: PSK

070 PSK TONE

Function: Selects the PSK tone frequency.

Available Values: 1000/1500/2000 Hz

Default Setting: 1000 Hz

071 OTHER DISP (SSB)

Function: Sets the packet frequency display offset.

Available Values: -3000 ~ 0 ~ +3000 Hz (10 Hz/step)

Default: 0 Hz

072 OTHER SHIFT (SSB)

Function: Sets the carrier point during the SSB packet operation.

Available Values: -3000 ~ 0 ~ +3000 Hz (10 Hz/step)

Default: 1000 Hz (typical center frequency for PSK31, etc.)

073 DATA LCUT FREQ

Function: Selects the cutoff frequency of the lower side of the RX audio filter in the DATA mode.

Available Values: OFF/100 ~ 1000 Hz (50 Hz/step)

Default Setting: 300

074 DATA LCUT SLOPE

Function: Selects the filter slope of the lower side of the RX audio filter in the DATA mode.

Available Values: 6dB/oct / 18dB/oct

Default Setting: 18dB/oct

075 DATA HCUT FREQ

Function: Selects the cutoff frequency of the upper side of the RX audio filter in the DATA mode.

Available Values: OFF/700 ~ 4000 Hz (50 Hz/step)

Default Setting: 3000

076 DATA HCUT SLOPE

Function: Selects the filter slope of the upper side of the RX audio filter in the DATA mode.

Available Values: 6dB/oct / 18dB/oct

Default Setting: 18dB/oct

077 DATA MIC GAIN

Function: Sets the data input level from the TNC to the AFSK modulator.

Available Values: MCVR/0 ~ 100

Default Setting: MCVR

When this menu is set to "MCVR", you may adjust the microphone gain using the front panel [MIC/SPEED] knob.

078 DATA OUT LEVEL

Function: Sets the AFSK data output level at the output port (pin 5) of the RTTY/PKT jack.

Available Values: 0 ~ 100

Default Setting: 50

079 DATA VOX GAIN

Function: Adjusts the "VOX" Gain in the DATA mode.

Available Values: 0 ~ 100

Default Setting: 50

080 DATA VOX DELEY

Function: Adjusts the "VOX" Delay (receiver recovery) time in the DATA mode.

Available Values: 30 ~ 3000 msec (10 msec/step)

Default Setting: 300 msec

MODE-FM GROUP

081 FM LCUT FREQ

Function: Selects the cutoff frequency of the lower side of the RX audio filter in the FM mode.

Available Values: OFF/100 ~ 1000 Hz (50 Hz/step)

Default Setting: 250

082 FM LCUT SLOPE

Function: Selects the filter slope of the lower side of the RX audio filter in the FM mode.

Available Values: 6dB/oct / 18dB/oct

Default Setting: 18dB/oct

083 FM HCUT FREQ

Function: Selects the cutoff frequency of the upper side of the RX audio filter in the FM mode.

Available Values: OFF/700 ~ 4000 Hz (50 Hz/step)

Default Setting: OFF

084 FM HCUT SLOPE

Function: Selects the filter slope of the upper side of the RX audio filter in the FM mode.

Available Values: 6dB/oct / 18dB/oct

Default Setting: 6dB/oct

085 FM MIC GAIN

Function: Sets the microphone gain for the FM mode.

Available Values: MCVR/0 ~ 100

Default Setting: MCVR

When this menu is set to "MCVR", you may adjust the microphone gain using the front panel [MIC/SPEED] knob.

086 FM MIC SEL

Function: Selects the microphone to be used on the FM mode.

Available Values: FRONT / DATA

Default Setting: FRONT

FRONT: Selects the microphone connected to the front panel MIC jack while using the FM mode.

DATA: Selects the microphone connected to pin 1 of the PACKET Jack while using the FM mode.

087 RPT SHIFT (28MHz)

Function: Sets the magnitude of the repeater shift on the 28 MHz band.

Available Values: 0 ~ 1000 kHz (10 kHz/step)

Default Setting: 100 kHz

088 RPT SHIFT (50MHz)

Function: Sets the magnitude of the repeater shift on the 50 MHz band.

Available Values: 0 ~ 4000 kHz (10 kHz/step)

Default Setting: 1000 kHz

089 TONE FREQ

Function: Select the desired CTCSS Tone. A total of 50 standard CTCSS tones are provided (see the CTCSS Tone Chart on Page 91).

Available Values: 67.0 ~ 254.1 Hz

Default Setting: 67.0 Hz

MODE-RTTY GROUP

090 RTTY LCUT FREQ

Function: Selects the cutoff frequency of the lower side of the RX audio filter in the RTTY mode.

Available Values: OFF/100 ~ 1000 Hz (50 Hz/step)

Default Setting: 300

091 RTTY LCUT SLOPE

Function: Selects the filter slope of the lower side of the RX audio filter in the RTTY mode.

Available Values: 6dB/oct / 18dB/oct

Default Setting: 18dB/oct

092 RTTY HCUT FREQ

Function: Selects the cutoff frequency of the upper side of the RX audio filter in the RTTY mode.

Available Values: OFF/700 ~ 4000 Hz (50 Hz/step)

Default Setting: 3000

093 RTTY HCUT SLOPE

Function: Selects the filter slope of the upper side of the RX audio filter in the RTTY mode.

Available Values: 6dB/oct / 18dB/oct

Default Setting: 18dB/oct

094 POLARITY-R

Function: Selects normal or reverse Mark/Space polarity for RTTY receive operation.

Available Values: NOR/REV

Default Setting: NOR

095 POLARITY-T

Function: Selects normal or reverse Mark/Space polarity for RTTY transmit operation.

Available Values: NOR/REV

Default Setting: NOR

096 RTTY OUT LEVEL

Function: Sets the RTTY (AFSK) data output level at the output port (pin 5) of the RTTY/PKT jack.

Available Values: 0 ~ 100

Default Setting: 50

097 RTTY SHIFT

Function: Selects the frequency shift for RTTY (AFSK) operation.

Available Values: 170/200/425/850 Hz

Default Setting: 170 Hz

098 RTTY MARK FREQ

Function: Selects the Mark tone for RTTY operation.

Available Values: 1275/2125 Hz

Default Setting: 2125 Hz

MODE-SSB GROUP

099 SSB LCUT FREQ

Function: Selects the cutoff frequency of the lower side of the RX audio filter in the SSB mode.

Available Values: OFF/100 ~ 1000 Hz (50 Hz/step)

Default Setting: 200

100 SSB LCUT SLOPE

Function: Selects the filter slope of the lower side of the RX audio filter in the SSB mode.

Available Values: 6dB/oct / 18dB/oct

Default Setting: 6dB/oct

101 SSB HCUT FREQ

Function: Selects the cutoff frequency of the upper side of the RX audio filter in the SSB mode.

Available Values: OFF/700 ~ 4000 Hz (50 Hz/step)

Default Setting: 3000

102 SSB HCUT SLOPE

Function: Selects the filter slope of the upper side of the RX audio filter in the RTTY mode.

Available Values: 6dB/oct / 18dB/oct

Default Setting: 18dB/oct

103 SSB MIC SEL

Function: Selects the microphone to be used on the SSB mode.

Available Values: FRONT / DATA

Default Setting: FRONT

FRONT: Selects the microphone connected to the front panel MIC jack while using the SSB mode.

DATA: Selects the microphone connected to pin 1 of the PACKET Jack while using the SSB mode.

104 SSB TX BPF

Function: Selects the audio passband of the DSP modulator on the SSB mode.

Available Values: 100-3000/100-2900/200-2800/300-2700/400-2600/3000WB

Default Setting: 300 ~ 2700 (Hz)

105 LSB RX CARRIER

Function: Adjusts the receiver carrier point for the LSB mode.

Available Values: -200 Hz ~ 0 ~ +200 Hz (10 Hz steps)

Default Setting: 0

106 USB RX CARRIER

Function: Adjusts the receiver carrier point for the USB mode.

Available Values: -200 Hz ~ 0 ~ +200 Hz (10 Hz steps)

Default Setting: 0

RX DSP GROUP

107 APF WIDTH

Function: Selects the Bandwidth of the Audio Peak Filter.

Available Values: NARROW/MEDIUM/WIDE

Default Setting: MEDIUM

108 CONTOUR LEVEL

Function: Adjusts the gain of the Contour filter.

Available Values: -40 ~ 0 ~ 20 dB

Default Setting: -15

109 CONTOUR WIDTH

Function: Adjusts the Q-factor of the Contour filter.

Available Values: 1 ~ 11

Default Setting: 10

110 DNR LEVEL

Function: Set the Digital Noise Reduction response.

Available Values: 1 ~ 11

Default Setting: 3

111 IF NOTCH WIDTH

Function: Selects the bandwidth of the DSP NOTCH filter.

Available Values: NARROW / WIDE

Default Setting: WIDE

112 HF CW SHAPE

Function: Selects the passband characteristics of the DSP filter for the CW mode on the HF band.

Available Values: SOFT / SHARP

Default Setting: SOFT

SOFT: Primary importance is attached to the phase of the filter factor.

SHARP: Primary importance is attached to the amplitude of the filter factor.

113 HF CW SLOPE

Function: Selects the shape factor of the DSP filter for the CW mode on the HF band.

Available Values: STEEP / MEDIUM / GENTLE

Default Setting: MEDIUM

114 6M CW SHAPE

Function: Selects the passband characteristics of the DSP filter for the CW mode on the 50 MHz band.

Available Values: SOFT / SHARP

Default Setting: SOFT

SOFT: Primary importance is attached to the phase of the filter factor.

SHARP: Primary importance is attached to the amplitude of the filter factor.

115 6M CW SLOPE

Function: Selects the shape factor of the DSP filter for the CW mode on the 50 MHz band.

Available Values: STEEP / MEDIUM / GENTLE

Default Setting: MEDIUM

116 HF PSK SHAPE

Function: Selects the passband characteristics of the DSP filter for the PSK mode on the HF band.

Available Values: SOFT / SHARP

Default Setting: SHARP

SOFT: Primary importance is attached to the phase of the filter factor.

SHARP: Primary importance is attached to the amplitude of the filter factor.

117 HF PSK SLOPE

Function: Selects the shape factor of the DSP filter for the PSK mode on the HF band.

Available Values: STEEP / MEDIUM / GENTLE

Default Setting: MEDIUM

118 HF FSK SHAPE

Function: Selects the passband characteristics of the DSP filter for the FSK mode on the HF band.

Available Values: SOFT / SHARP

Default Setting: SHARP

SOFT: Primary importance is attached to the phase of the filter factor.

SHARP: Primary importance is attached to the amplitude of the filter factor.

119 HF FSK SLOPE

Function: Selects the shape factor of the DSP filter for the PSK mode on the HF band.

Available Values: STEEP / MEDIUM / GENTLE

Default Setting: MEDIUM

120 HF SSB SHAPE

Function: Selects the passband characteristics of the DSP filter for the SSB mode on the HF band.

Available Values: SOFT / SHARP

Default Setting: SHARP

SOFT: Primary importance is attached to the phase of the filter factor.

SHARP: Primary importance is attached to the amplitude of the filter factor.

121 HF SSB SLOPE

Function: Selects the shape factor of the DSP filter for the SSB mode on the HF band.

Available Values: STEEP / MEDIUM / GENTLE

Default Setting: MEDIUM

122 6M SSB SHAPE

Function: Selects the passband characteristics of the DSP filter for the SSB mode on the 50 MHz band.

Available Values: SOFT / SHARP

Default Setting: SOFT

SOFT: Primary importance is attached to the phase of the filter factor.

SHARP: Primary importance is attached to the amplitude of the filter factor.

123 6M SSB SLOPE

Function: Selects the shape factor of the DSP filter for the SSB mode on the 50 MHz band.

Available Values: STEEP / MEDIUM / GENTLE

Default Setting: MEDIUM

SCOPE GROUP

124 SCOPE MODE

Function: Selects the operation mode of the Band Scope Monitor (CENTER mode or FIX mode).

Available Values: CENTER / FIX

Default Setting: CENTER

125 SCOPE SPEED

Function: Selects the Sweep Speed of the Band Scope Monitor.

Available Values: FAST / SLOW

Default Setting: FAST

126 SCOPE AUTO TIME

Function: Selects the Start cycle of the Auto Scope feature.

Available Values: OFF / 3 / 5 / 10 / 30 / 60 sec

Default Setting: OFF

127 START DIAL SPEED

Function: Selects the start condition of the Dial Auto Scope feature.

Available Values: 0.5 / 1 / 2 / 4 / 8 / 16 kHz/sec

Default Setting: 8 kHz/sec

128 CENTER SPAN FREQ

Function: Selects the desired frequency span of the CENTER mode Spectrum Scope.

Available Values: 20 / 50 / 100 / 200 / 500 / 1000 kHz

Default Setting: 100 kHz

129 FIX 1.8MHz

Function: Selects the scan start frequency of the FIX mode Spectrum Scope while monitoring on the 160 m amateur band.

Available Values: 1800 ~ 1999 kHz (1 kHz steps)

Default Setting: 1800 kHz

130 FIX 1.8MHz SPAN

Function: Selects the desired frequency span of the FIX mode Spectrum Scope while monitoring on the 160 m amateur band.

Available Values: 20 / 50 / 100 / 200 / 500 / 1000 kHz

Default Setting: 200 kHz

131 FIX 3.5MHz

Function: Selects the scan start frequency of the FIX mode Spectrum Scope while monitoring on the 80 m amateur band.

Available Values: 3500 ~ 3999 kHz (1 kHz steps)

Default Setting: 3500 kHz

132 FIX 3.5MHz SPAN

Function: Selects the desired frequency span of the FIX mode Spectrum Scope while monitoring on the 80 m amateur band.

Available Values: 20 / 50 / 100 / 200 / 500 / 1000 kHz

Default Setting: 500 kHz

133 FIX 5.0MHz

Function: Selects the scan start frequency of the FIX mode Spectrum Scope while monitoring on the 60 m amateur band.

Available Values: 5250 ~ 5499 kHz (1 kHz steps)

Default Setting: 5250 kHz

134 FIX 5.0MHz SPAN

Function: Selects the desired frequency span of the FIX mode Spectrum Scope while monitoring on the 60 m amateur band.

Available Values: 20 / 50 / 100 / 200 / 500 / 1000 kHz

Default Setting: 200 kHz

135 FIX 7.0MHz

Function: Selects the scan start frequency of the FIX mode Spectrum Scope while monitoring on the 40 m amateur band.

Available Values: 7000 ~ 7299 kHz (1 kHz steps)

Default Setting: 7000 kHz

136 FIX 7.0MHz SPAN

Function: Selects the desired frequency span of the FIX mode Spectrum Scope while monitoring on the 40 m amateur band.

Available Values: 20 / 50 / 100 / 200 / 500 / 1000 kHz

Default Setting: 500 kHz

137 FIX 10MHz

Function: Selects the scan start frequency of the FIX mode Spectrum Scope while monitoring on the 30 m amateur band.

Available Values: 10100 ~ 10149 kHz (1 kHz steps)

Default Setting: 10100 kHz

138 FIX 10MHz SPAN

Function: Selects the desired frequency span of the FIX mode Spectrum Scope while monitoring on the 30 m amateur band.

Available Values: 20 / 50 / 100 / 200 / 500 / 1000 kHz

Default Setting: 50 kHz

139 FIX 14MHz

Function: Selects the scan start frequency of the FIX mode Spectrum Scope while monitoring on the 20 m amateur band.

Available Values: 14000 ~ 14349 kHz (1 kHz steps)

Default Setting: 14000 kHz

140 FIX 14MHz SPAN

Function: Selects the desired frequency span of the FIX mode Spectrum Scope while monitoring on the 20 m amateur band.

Available Values: 20 / 50 / 100 / 200 / 500 / 1000 kHz

Default Setting: 500 kHz

141 FIX 18MHz

Function: Selects the scan start frequency of the FIX mode Spectrum Scope while monitoring on the 17 m amateur band.

Available Values: 18000 ~ 18199 kHz (1 kHz steps)

Default Setting: 18068 kHz

142 FIX 18MHz SPAN

Function: Selects the desired frequency span of the FIX mode Spectrum Scope while monitoring on the 17 m amateur band.

Available Values: 20 / 50 / 100 / 200 / 500 / 1000 kHz

Default Setting: 100 kHz

143 FIX 21MHz

Function: Selects the scan start frequency of the FIX mode Spectrum Scope while monitoring on the 15 m amateur band.

Available Values: 21000 ~ 21449 kHz (1 kHz steps)

Default Setting: 21000 kHz

144 FIX 21MHz SPAN

Function: Selects the desired frequency span of the FIX mode Spectrum Scope while monitoring on the 15 m amateur band.

Available Values: 20 / 50 / 100 / 200 / 500 / 1000 kHz

Default Setting: 500 kHz

145 FIX 24MHz

Function: Selects the scan start frequency of the FIX mode Spectrum Scope while monitoring on the 12 m amateur band.

Available Values: 24800 - 24989 kHz (1 kHz steps)

Default Setting: 24890 kHz

146 FIX 24MHz SPAN

Function: Selects the desired frequency span of the FIX mode Spectrum Scope while monitoring on the 12 m amateur band.

Available Values: 20 / 50 / 100 / 200 / 500 / 1000 kHz

Default Setting: 100 kHz

147 FIX 28MHz

Function: Selects the scan start frequency of the FIX mode Spectrum Scope while monitoring on the 10 m amateur band.

Available Values: 28000 ~ 29699 kHz (1 kHz steps)

Default Setting: 28000 kHz

148 FIX 28MHz SPAN

Function: Selects the desired frequency span of the FIX mode Spectrum Scope while monitoring on the 10 m amateur band.

Available Values: 20 / 50 / 100 / 200 / 500 / 1000 kHz

Default Setting: 1000 kHz

149 FIX 50MHz

Function: Selects the scan start frequency of the FIX mode Spectrum Scope while monitoring on the 6 m amateur band.

Available Values: 50000 ~ 53999 kHz (1 kHz steps)

Default Setting: 50000 kHz

150 FIX 50MHz SPAN

Function: Selects the desired frequency span of the FIX mode Spectrum Scope while monitoring on the 6 m amateur band.

Available Values: 20 / 50 / 100 / 200 / 500 / 1000 kHz

Default Setting: 1000 kHz

TUNING GROUP

151 CW DIAL STEP

Function: Setting of the Main Tuning Dial knob and the [VFO-B/CLAR] knob tuning speed in the CW mode.

Available Values: 1/5/10 Hz

Default Setting: 10 Hz

152 DATA DIAL STEP

Function: Setting of the Main Tuning Dial knob and the [VFO-B/CLAR] knob tuning speed in the DATA mode.

Available Values: 1/5/10 Hz

Default Setting: 10 Hz

153 AM/FM DIAL STEP

Function: Setting of the Main Tuning Dial knob and the [VFO-B/CLAR] knob tuning speed in the AM and FM mode.

Available Values: 10/100 Hz

Default Setting: 100 Hz

154 RTTY DIAL STEP

Function: Setting of the Main Tuning Dial knob and the [VFO-B/CLAR] knob tuning speed in the RTTY mode.

Available Values: 1/5/10 Hz

Default Setting: 5 Hz

155 SSB DIAL STEP

Function: Setting of the Main Tuning Dial knob and the [VFO-B/CLAR] knob tuning speed in the SSB mode.

Available Values: 1/5/10 Hz

Default Setting: 10 Hz

156 AM CH STEP

Function: Selects the tuning steps for the microphone's [UP]/[DWN] keys in the AM mode.

Available Values: 2.5/5/9/10/12.5 kHz

Default Setting: 5 kHz

157 FM CH STEP

Function: Selects the tuning steps for the microphone's [UP]/[DWN] keys in the FM mode.

Available Values: 5/6.25/10/12.5/20/25 kHz

Default Setting: 5 kHz

158 1MHz/100kHz SELECT

Function: Selects the tuning steps for the [VFO-B/CLAR] knob when the [MHz/uT] button is pressed.

Available Values: 1MHz/100kHz

Default Setting: 1MHz

TX AUDIO GROUP

159 PRMTRC EQ1 FREQ

Function: Selects the center frequency of the lower range for the parametric microphone equalizer.

Available Values: 100 ~ 700 Hz (100 Hz/step)

Default Setting: 200

You may adjust the equalizer gain and Q-factor at this selected audio frequency via menu items "160 PRMTRC EQ1 LEVEL" and "161 PRMTRC EQ1 BWTH".

160 PRMTRC EQ1 LEVEL

Function: Adjusts the equalizer gain of the low range of the parametric microphone equalizer.

Available Values: -20 ~ 0 ~ +10

Default Setting: 0

161 PRMTRC EQ1 BWTH

Function: Adjusts the Q-factor of the low range of the parametric microphone equalizer.

Available Values: 1 ~ 10

Default Setting: 1

162 PRMTRC EQ2 FREQ

Function: Selects the center frequency of the middle range for the parametric microphone equalizer.

Available Values: 700 ~ 1500 Hz (100 Hz/step)

Default Setting: 800

You may adjust the equalizer gain and Q-factor at this selected audio frequency via menu items "163 PRMTRC EQ2 LEVEL" and "164 PRMTRC EQ2 BWTH"

163 PRMTRC EQ2 LEVEL

Function: Adjusts the equalizer gain of the middle range of the parametric microphone equalizer.

Available Values: -20 ~ 0 ~ +10

Default Setting: 0

164 PRMTRC EQ2 BWTH

Function: Adjusts the equalizer gain of the middle range of the parametric microphone equalizer.

Available Values: 1 ~ 10

Default Setting: 1

165 PRMTRC EQ3 FREQ

Function: Selects the center frequency of the high range for the parametric microphone equalizer.

Available Values: 1500 ~ 3200 Hz (100 Hz/step)

Default Setting: 2100

You may adjust the equalizer gain and Q-factor in this selected audio frequency via menu items “166 PRMTRC EQ3 LEVEL” and “167 PRMTRC EQ3 BWTH”.

166 PRMTRC EQ3 LEVEL

Function: Adjusts the equalizer gain of the high range of the parametric microphone equalizer.

Available Values: -20 ~ 0 ~ +10

Default Setting: +5

167 PRMTRC EQ3 BWTH

Function: Adjusts the Q-factor of the high range of the parametric microphone equalizer.

Available Values: 1 ~ 10

Default Setting: 10

168 P-PRMTRC EQ1 FREQ

Function: Selects the center frequency of the lower range for the parametric microphone equalizer when the speech processor is activated.

Available Values: 100 ~ 700 Hz (100 Hz/step)

Default Setting: 200

You may adjust the equalizer gain and Q-factor at this selected audio frequency via menu items “169 P-PRMTRC EQ1 LEVEL” and “170 P-PRMTRC EQ1 BWTH”.

169 P-PRMTRC EQ1 LEVEL

Function: Adjusts the equalizer gain of the low range of the parametric microphone equalizer.

Available Values: -20 ~ 0 ~ +10

Default Setting: -3

170 P-PRMTRC EQ1 BWTH

Function: Adjusts the Q-factor of the low range of the parametric microphone equalizer.

Available Values: 1 ~ 10

Default Setting: 2

171 P-PRMTRC EQ2 FREQ

Function: Selects the center frequency of the middle range for the parametric microphone equalizer when the speech processor is activated.

Available Values: 700 ~ 1500 Hz (100 Hz/step)

Default Setting: 800

You may adjust the equalizer gain and Q-factor at this selected audio frequency via menu items “172 P-PRMTRC EQ2 LEVEL” and “173 P-PRMTRC EQ2 BWTH”.

172 P-PRMTRC EQ2 LEVEL

Function: Adjusts the equalizer gain of the middle range of the parametric microphone equalizer.

Available Values: -20 ~ 0 ~ +10

Default Setting: 0

173 P-PRMTRC EQ2 BWTH

Function: Adjusts the Q-factor of the middle range of the parametric microphone equalizer.

Available Values: 1 ~ 10

Default Setting: 1

174 P-PRMTRC EQ3 FREQ

Function: Selects the center frequency of the high range for the parametric microphone equalizer when the speech processor is activated.

Available Values: 1500 ~ 3200 Hz (100 Hz/step)

Default Setting: 2100

You may adjust the equalizer gain and Q-factor at this selected audio frequency via menu items “175 P-PRMTRC EQ3 LEVEL” and “176 P-PRMTRC EQ3 BWTH”.

175 P-PRMTRC EQ3 LEVEL

Function: Adjusts the equalizer gain of the low range of the parametric microphone equalizer.

Available Values: -20 ~ 0 ~ +10

Default Setting: +5

176 P-PRMTRC EQ3 BWTH

Function: Adjusts the Q-factor of the low range of the parametric microphone equalizer.

Available Values: 1 ~ 10

Default Setting: 1

TX GNRL GROUP

177 TX MAX POWER

Function: Sets a transmitter output level.

Available Values: 5 ~ 100

Default Setting: 100

178 EXT AMP TUNING PWR

Function: Selects a maximum output power limit for driving the input circuit of an external linear RF amplifier while tuning (while using the Remote Control function of the linear RF amplifier).

Available Values: 10/20/50/100

Default Setting: 100

179 TUNER SELECT

Function: Enable/disable the optional FC-40 Antenna Tuner.

Available Values: INTERNAL/EXTERNAL

Default Setting: INTERNAL

INTERNAL: The [TUNE] button will activate the internal Antenna Tuner.

EXTERNAL: The [TUNE] button will activate the optional FC-40 Antenna Tuner.

180 VOX SELECT

Function: Selects the audio input source for triggering TX during VOX operation.

Available Values: MIC/DATA

Default Setting: MIC

MIC: The VOX function will be activated by microphone audio input.

DATA: The VOX function will be activated by data audio input port (pin 1) of the RTTY/PKT Jack.

181 VOX GAIN

Function: Adjusts the "VOX" Gain on the SSB/AM/FM modes.

Available Values: 0 ~ 100

Default Setting: 50

182 VOX DELEY

Function: Adjusts the "VOX" Delay (receiver recovery) time on the SSB/AM/FM modes.

Available Values: 30 ~ 3000 msec (10 msec/step)

Default Setting: 500 msec

183 ANTI VOX GAIN

Function: Adjusts the Anti-VOX Trip Gain, which is the level of negative AF feedback of receiver audio to the microphone, to prevent receiver audio from activating the transmitter (via the microphone) during VOX operation.

Available Values: 0 ~ 100

Default Setting: 50

184 EMERGENCY FREQ TX

Function: Enables Tx/Rx operation on the Alaska Emergency Channel, 5167.5 kHz.

Available Values: ENABLE/DISABLE

Default Setting: DISABLE

When this Menu Item is set to "ENABLE", the spot frequency of 5167.5 kHz will be enabled. The Alaska Emergency Channel will be found between the Memory channels "P-1" and "01 (or 1-01)".

Important: The use of this frequency is restricted to stations operating in or near Alaska, and only for emergency purposes (never for routine operations). See § 97.401(c) of the FCC regulations for details.

AF SCOPE GROUP

185 FFT DISPLAY MODE

Function: Selects the operation mode of the Audio Scope Monitor.

Available Values: SPECTRUM/WATER FALL

Default Setting: SPECTRUM

SPECTRUM: The Audio Scope Monitor shows the audio signal on the Spectrum display.

WATER FALL: The Audio Scope Monitor shows the audio signal on the Water Fall display.

186 FFT ATT

Function: Selects the attenuation level of the Audio Scope Monitor.

Available Values: 0/10/20 dB

Default Setting: 10 dB

DEC CW

187 CW DECODE BW

Function: Selects the bandwidth of the AFC feature.

Available Values: 25/50/100/250 Hz

Default Setting: 100 Hz

E/D RTTY GROUP

188 RX USOS

Function: Enables/Disables the RX USOS feature.

Available Values: ENABLE/DISABLE

Default Setting: ENABLE

189 TX USOS

Function: Enables/Disables the TX USOS feature.

Available Values: ENABLE/DISABLE

Default Setting: ENABLE

190 RX NEW LINE CODE

Function: Selects the command code used for the Carriage Return during RTTY receive.

Available Values: CR,LF,CR+LF / CR+LF

Default Setting: CR,LF,CR+LF

191 TX AUTO CR+LF

Function: Enables/Disables the sending of the Carriage Return (CR+LF) Code while transmitting in RTTY.

Available Values: ENABLE/DISABLE

Default Setting: ENABLE

192 TX DIDDLE

Function: Selects the transmission code when there is not a character to be transmitted.

Available Values: OFF/BLANK/LTRS

Default Setting: BLANK

193 BAUDOT CODE

Function: Selects the Baudot Code used for the RTTY mode.

Available Values: CCITT/US

Default Setting: US

E/D PSK GROUP

194 PSK MODE

Function: Selects the operation mode of the PSK mode.

Available Values: BPSK/QPSK

Default Setting: BPSK

195 DECODE AFC RANGE

Function: Selects the operation range (or bandwidth) of the AFC feature.

Available Values: 8/15/30

Default Setting: 15

196 QPSK POLARITY REV

Function: Selects normal or reverse phase shift for the QPSK mode.

Available Values: RX-N, TX-N / RX-R, TX-N /

RX-N, TX-R / RX-R, TX-R

Default Setting: RX-N, TX-N

INSTALLATION OF OPTIONAL ACCESSORIES

FFT UNIT (FFT-1)

1. Turn the **FTDx1200**'s [**POWER**] switch "OFF", and turn off the external DC power supply.
2. Disconnect all the cables from the **FTDx1200**.
3. Referring to Figure 1, remove the 18 screws attaching the bottom case, then remove the bottom case.
4. Refer to Figure 2 for the mounting location for the **FFT-1**.
5. Place the **FFT-1** (component side up), and then secure the corners of the **FFT-1** with the 4 screws.
6. Referring to Figure 3, connect appropriate cables to the 4-pin and 14-pin connectors on the **FFT-1** respectively.
7. Replace the bottom case and 18 screws.
8. Connect the antenna and DC power supply to the **FTDx1200**.

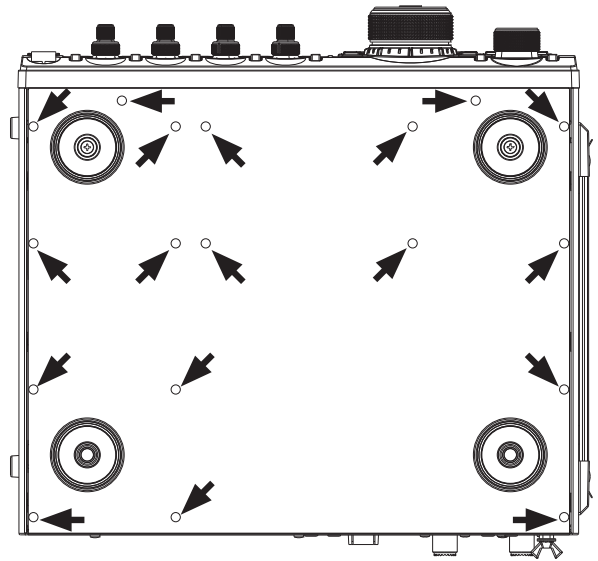

FIGURE 1

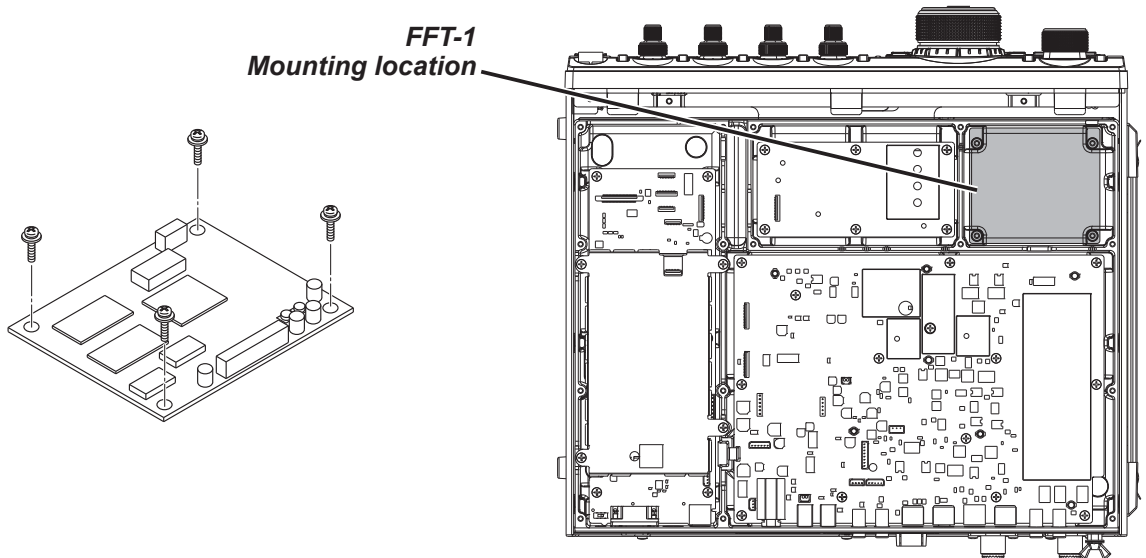

FIGURE 2

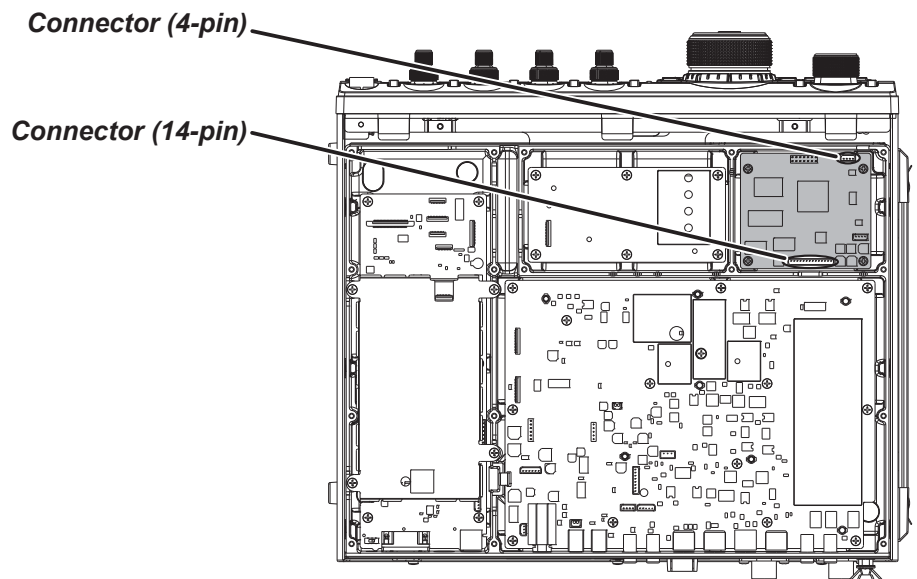

FIGURE 3

INSTALLATION OF OPTIONAL ACCESSORIES

VOICE MEMORY UNIT (DVS-6)

1. Turn the **FTdx1200**'s **[POWER]** switch "OFF", and turn off the external DC power supply.
2. Disconnect all the cables from the **FTdx1200**.
3. Referring to Figure 1, remove the 18 screws attaching the bottom case, then remove the bottom case.
4. Refer to Figure 2 for the mounting location for the **DVS-6**.
5. Push the **DVS-6** (component side up) onto the pins corresponding to its assigned mounting location on the transceiver. Gently press the board down until it is firmly seated on the connectors.
6. Replace the bottom case and 18 screws.
7. Connect the antenna and DC power supply to the **FTdx1200**.

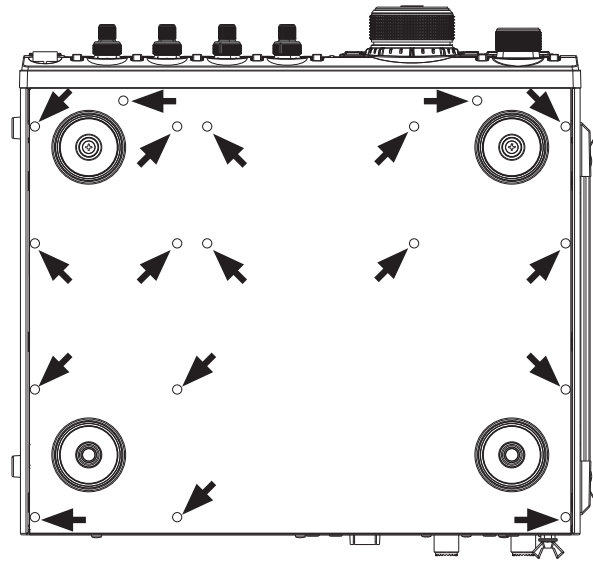

FIGURE 1

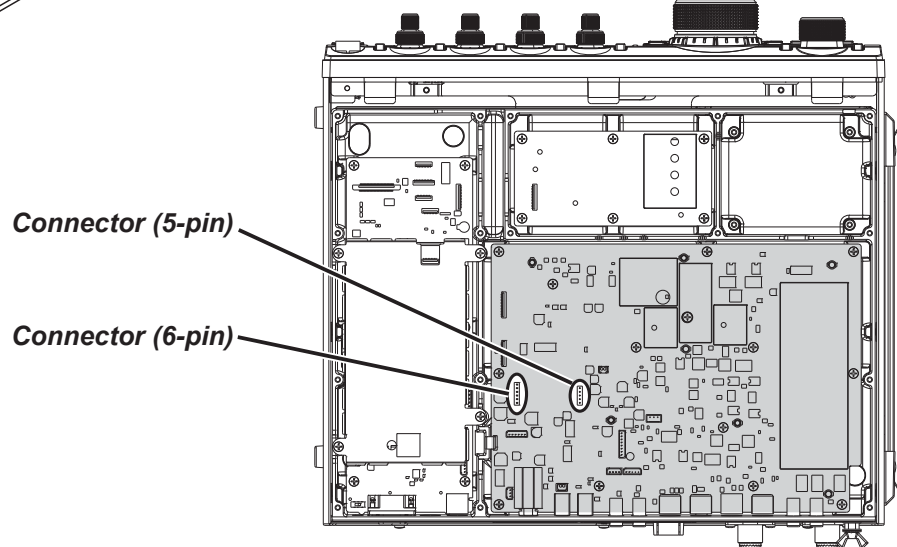
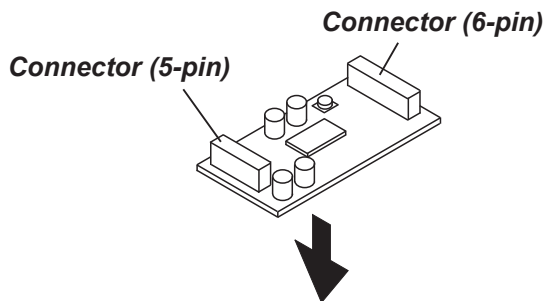

FIGURE 2

INSTALLATION OF OPTIONAL ACCESSORIES

RF μ TUNING KIT

The RF μ Tuning Kits provide ultra-sharp RF selectivity for the front end of the transceiver. A Very high Q tuned circuit makes possible the narrow-band design. Three RF μ Tuning Kits are available. The **MTU-160** covers the 1.8 MHz band. The **MTU-80/40** covers the 3.5 and 7 MHz bands. The **MTU-30/20** covers 10.1 and 14 MHz bands.

The narrow bandwidth is especially useful on the low bands, when many strong signals are being received via NVIS propagation (Near Vertical-Incidence Signals) within a narrow bandwidth. The added protection for the receiver RF stages is especially helpful in preventing IMD and blocking.

Installation

Assemble the RF μ Tuning Unit according to the “RF μ Tuning Kit Installation Manual” supplied with the RF μ Tuning Kit.

Interconnections to FTdx1200

Connect each cable (supplied with the RF μ Tuning Unit) between the RF μ Tuning Unit and the **FTdx1200** Transceiver.

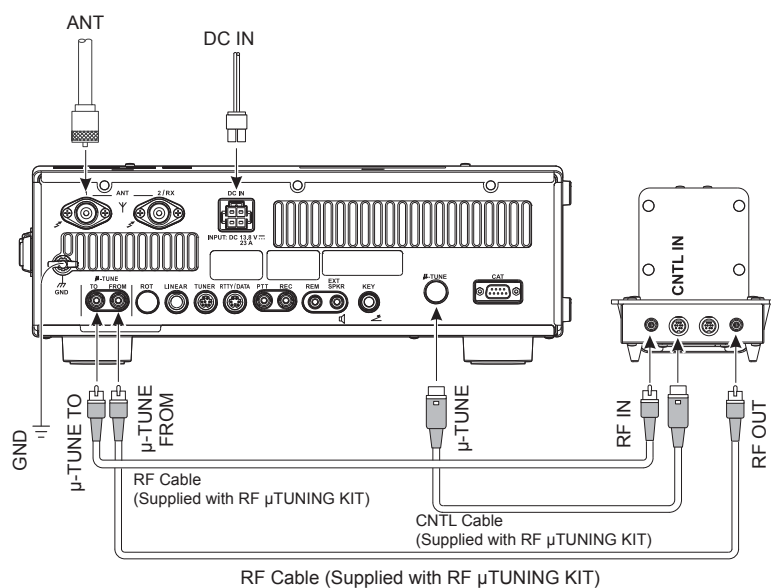

SINGLE CONNECTION

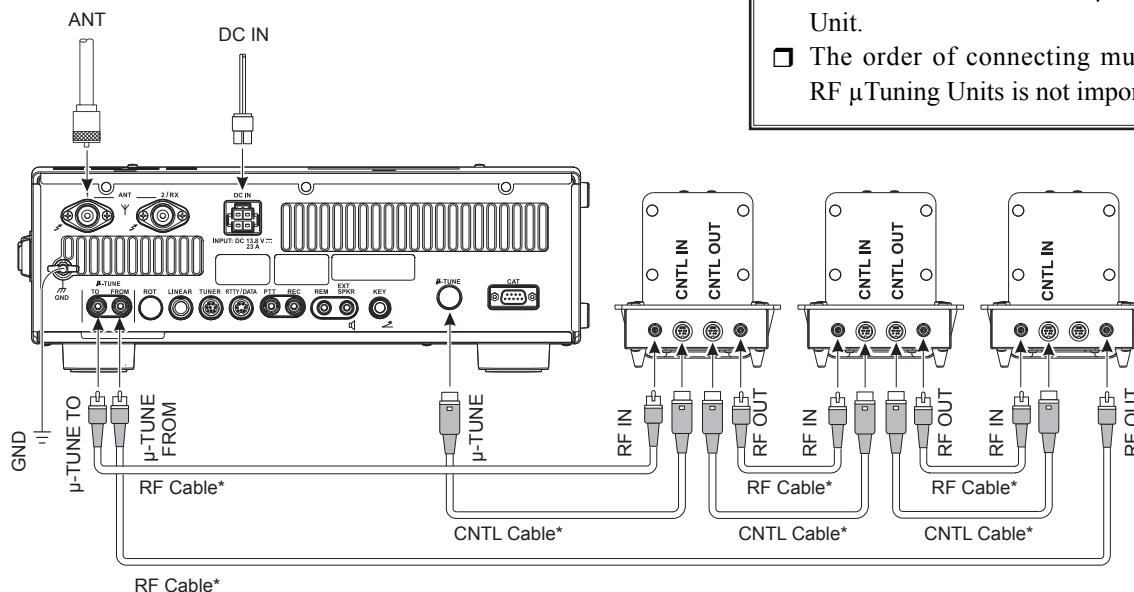

*: Supplied with RF μ TUNING KIT

MULTI CONNECTION

Advice

- ❑ The RF connecting cables are color coded (black and gray) to assist in properly connecting the RF IN and RF OUT jacks. (See illustration)
- ❑ An improper connection will not damage the RF μ Tuning Kit. However, improper operation may occur.
- ❑ Connect the color-coded control cable(s) between the CNTL OUT and CNTL IN jacks (see illustration). Confirm all connections before turning on the transceiver.
- ❑ If the **FTdx1200** does not operate and the frequency display blinks sometimes, confirm and correct the “CNTL IN” and “CNTL OUT” connections on the RF μ Tuning Unit.
- ❑ The order of connecting multiple RF μ Tuning Units is not important.

INSTALLATION OF OPTIONAL ACCESSORIES

FC-40 EXTERNAL AUTOMATIC ANTENNA TUNER (FOR WIRE ANTENNA)

The **FC-40** makes use of the control circuitry built into the transceiver, which allows the operator to control and monitor automatic operation of the **FC-40**, which mounts near the antenna feedpoint. The **FC-40** uses specially selected, thermally stable components, and is housed in a waterproof case to withstand severe environmental conditions with high reliability.

A carefully-chosen combination of solid-state switching components and high-speed relays allows the **FC-40** to match a wide variety of antennas to within a 2:1 SWR on any amateur band frequency (160 through 6 meters), typically in less than eight seconds. Transmitter power required for matching may be as little as 4 - 60 Watts, and matching settings are automatically stored in memory for instant recall when the same frequency range is selected later.

Please see the **FC-40** Operating Manual for detailed information.

Interconnections to FTdx1200

After mounting the **FC-40**, connect the cables from the **FC-40** to the ANT and TUNER jacks on the rear panel of the **FTdx1200** Transceiver.

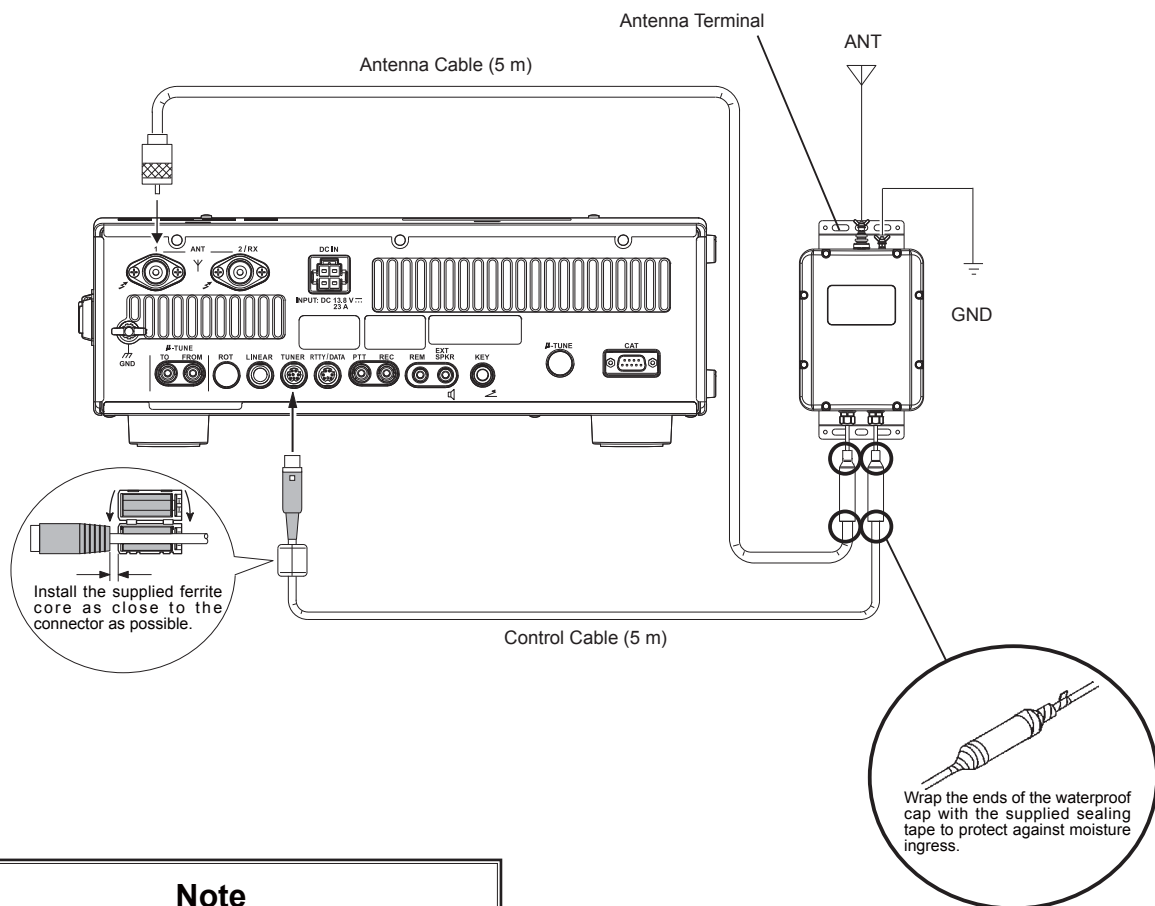

Note

When the **FC-40** is connected to the **FTdx1200**, TX GND (pin 2) of the TUNER jack and the LINEAR jack (pin 2) are common circuits. Therefore, the maximum voltage at TX GND (pin 2) of the LINEAR jack must not exceed +5V.

INSTALLATION OF OPTIONAL ACCESSORIES

FC-40 EXTERNAL AUTOMATIC ANTENNA TUNER (FOR WIRE ANTENNA)

Setup the FTdx1200

The optional **FC-40** Automatic Antenna Tuner provides automatic tuning of a coaxial line to present nominal 50-ohm impedance to the **FTdx1200**'s ANT jack.

Before operation can begin, you must instruct the **FTdx1200** microprocessor that the **FC-40** is being used. This is done using the Menu Mode:

1. Press the **[MENU]** button to enter the Menu mode.
2. Rotate the **[VFO-B/CLAR]** knob (or press the **▲/▼** button) to select the Menu Item "179 TUNER SELECT".
3. Press the **[SELECT]** button, then rotate the **[VFO-B/CLAR]** knob (or press the **▲/▼** button) to select "EXTERNAL".
4. Press the **[SELECT]** button.
5. Press the **[MENU]** button to save the new setting and exit to normal operation.

Operation

1. Press the **[TUNE]** button briefly to activate the Automatic Antenna Tuner.
2. The "TUNER" icon will appear in the TFT display.
3. Press and hold the **[TUNE]** button for one second to begin automatic tuning. The transmitter will be engaged, and the "TUNER" icon will blink while tuning is in progress.
4. Tuning will stop automatically when a low SWR is achieved. You may Press and hold the **[TUNE]** button for one second while tuning is in progress, to cancel the automatic tuning.
5. To disable the Automatic Antenna Tuner, press the **[TUNE]** button briefly again.

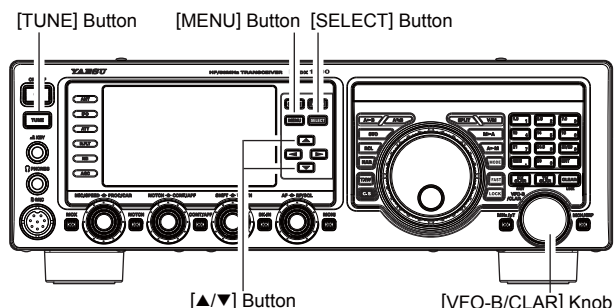

NOTE:

- Be sure to connect a good earth ground to the GND terminal of the **FC-40**.
- The carrier signal transmits continuously while tuning is in progress. Please monitor the operating frequency before beginning the tuning process. Be sure you are not interfering with others who may already be using the frequency.
- It is normal to hear the sound of the relays while tuning is in progress.
- If the impedance cannot be matched by the **FC-40** better than 2:1, and the "TUNER" icon blinks, the microprocessor will not retain the tuning data for that frequency, as the **FC-40** presumes that you will want to adjust or repair your antenna system to correct the high SWR condition.

INSTALLATION OF OPTIONAL ACCESSORIES

SCU-17 USB INTERFACE UNIT

Commercial and free computer software is available for use in RTTY, DATA (PSK) and CAT (Computer Aided Transceiver) system communications. See the illustration below for connection to your computer.

NOTE:

☐ Refer to the **SCU-17** Manual for specification details.

Setting Up for RTTY, DATA (PSK) Operation

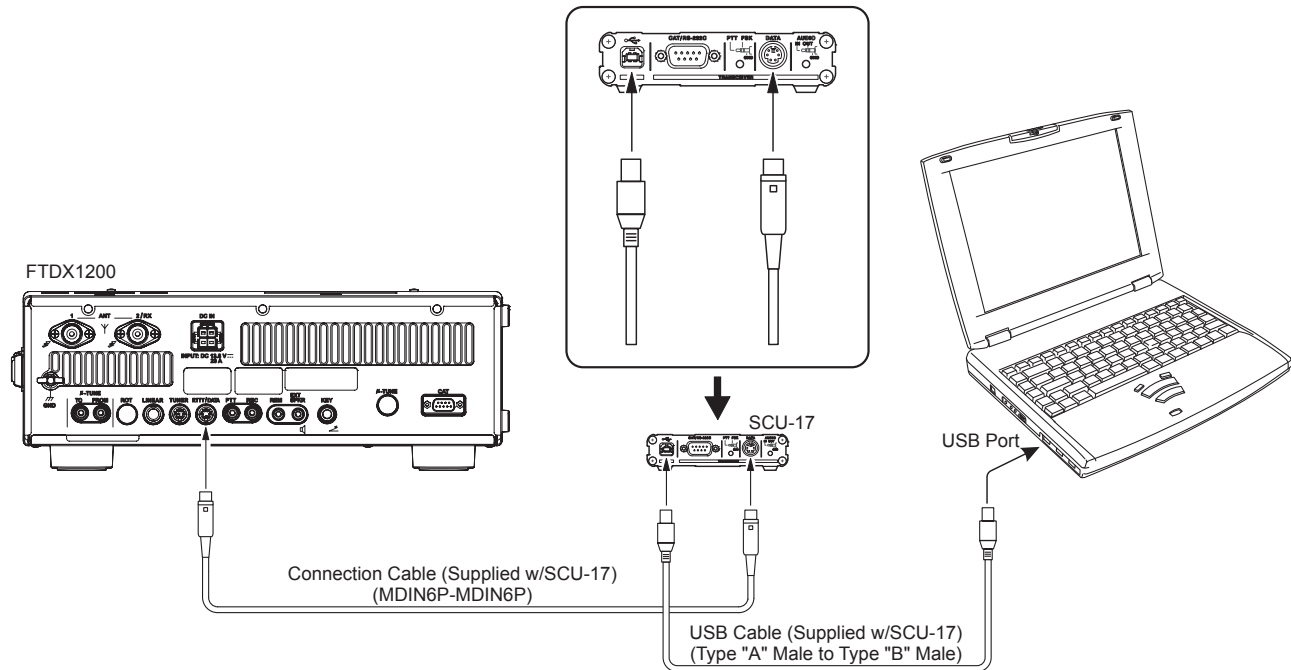

Setting Up for CAT Operation

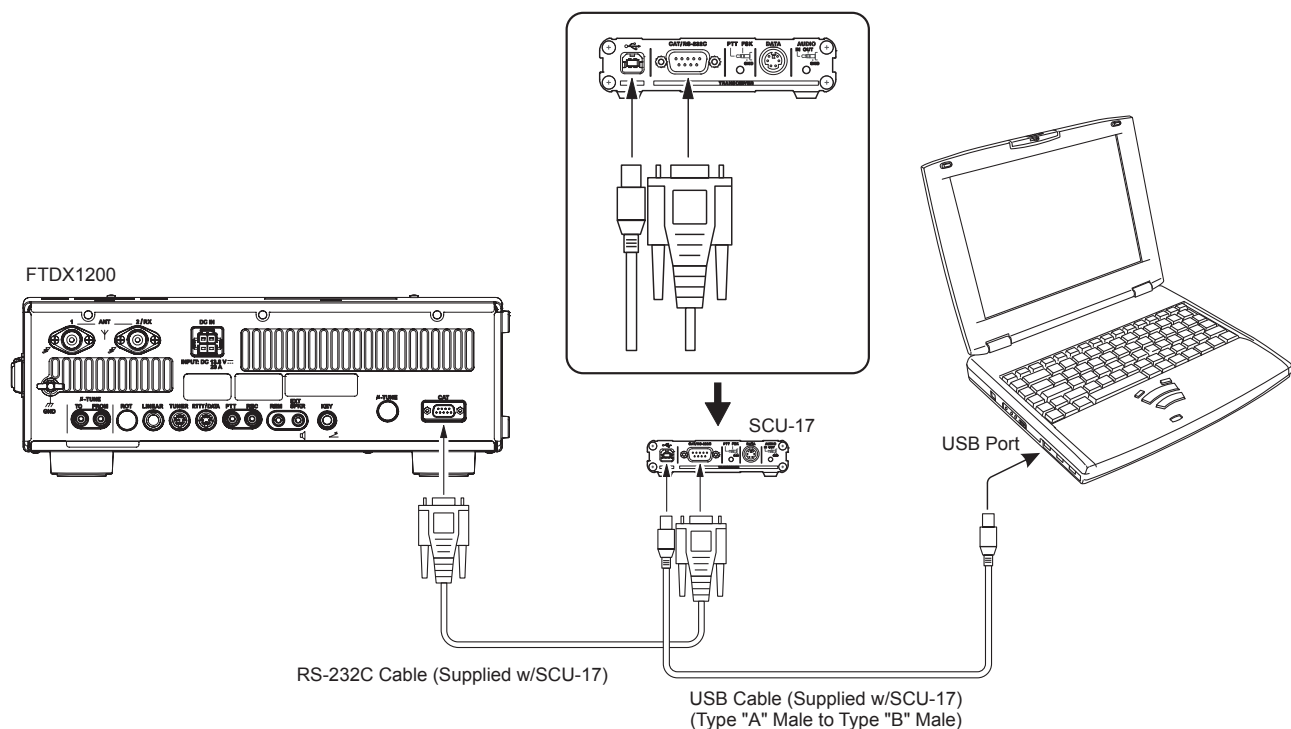

INSTALLATION OF OPTIONAL ACCESSORIES

SCU-17 USB INTERFACE UNIT

How to Confirm the Installation, and the COM Port Number

With the **SCU-17** and computer connected, confirm whether the virtual COM driver has been installed successfully.

The example below is for Windows® 7.

1. Click the Windows® “Start” button → Right-click “Computer” → Click “Properties (R)”.
2. Click “Device Manager” on the window that appears.
3. On the Device Manager screen, double-click “Port (COM & LPT)”.

The **SCU-17** provides two virtual COM ports: an Enhanced COM Port and a Standard COM Port. These ports offer the following functions.

- CAT communications Enhanced COM Port
- PTT control (RTS) Standard COM Port
- FSK control (DTR) Standard COM Port

Select the COM port numbers that were confirmed using the above procedure when performing software port configuration.

When operating RTTY, set the Sound Card (input) setting to “USB Audio CODEC”.

When operating DATA, PSK or AFSK modes, set the Sound Card (input and output) settings to “USB Audio CODEC”.

Caution:

- If a “!” or “X” is displayed for the port on the Device Manager, uninstall and reinstall the virtual COM driver.
- If an SCU-17 with a different serial number is connected and turned on, different COM port numbers will be assigned to it, making it possible to perform individual COM port configurations for an additional **SCU-17**.
- When using the USB cable to perform TX control, the transceiver may switch to transmit mode when the computer is started.
- Always shut down the application on the computer before disconnecting the USB cable.

SPECIFICATIONS

General

Rx Frequency Range:	30 kHz - 56 MHz (operating) 1.8 MHz - 54 MHz (specified performance, Amateur bands only)
Tx Frequency Ranges:	1.8 MHz - 54 MHz (Amateur bands only)
Frequency Stability:	±0.5 ppm (after 1 minute @+14 °F to +140 °F [-10 °C to +60 °C])
Operating Temperature Range:	+14 °F to +122 °F (-10 °C to +50 °C)
Emission Modes:	A1A (CW), A3E (AM), J3E (LSB, USB), F3E (FM), F1B (RTTY), G1B (PSK31)
Frequency Steps:	1/5/10 Hz (SSB, CW, & AM), 100 Hz (FM)
Antenna Impedance:	50 Ohms, unbalanced 16.7 - 150 Ohms, unbalanced (1.8 MHz - 29.7 MHz) 25 - 100 Ohms, unbalanced (50 MHz - 54 MHz) (Tuner ON, 1.8 MHz - 50 MHz Amateur bands, TX only)
Power Consumption (Approx.):	Rx (no signal) 1.8 A Rx (signal present) 2.1 A Tx (100 W) 23 A
Supply Voltage:	DC 13.8 V ± 10% (Negative Ground)
Dimensions (WxHxD):	14.4" x 4.5" x 12.3" (365 x 115 x 312 mm)
Weight (Approx.):	20.9 lbs (9.5 kg)

Transmitter

Power Output:	5 - 100 watts (2.5 - 25 watts AM carrier)
Modulation Types:	J3E (SSB): Balanced, A3E (AM): Low-Level (Early Stage), F3E (FM): Variable Reactance
Maximum FM Deviation:	±5.0 kHz/±2.5 kHz
Harmonic Radiation:	Better than -60 dB (1.8 MHz - 29.7 MHz Amateur bands: Harmonics) Better than -50 dB (1.8 MHz - 29.7 MHz Amateur bands: Others) Better than -60 dB (50 MHz Amateur band)
SSB Carrier Suppression:	At least 60 dB below peak output
Undesired Sideband Suppression:	At least 60 dB below peak output
3rd-order IMD:	-31 dB @14 MHz 100 watts PEP
Bandwidth:	3 kHz (LSB/USB), 500 Hz (CW), 6 kHz (AM), 16 kHz (FM)
Audio Response (SSB):	Not more than -6 dB from 300 to 2700 Hz
Microphone Impedance:	600 Ohms (200 to 10 kOhms)

Receiver

Circuit Type:	Triple-conversion Superheterodyne															
Intermediate Frequencies:	40.455 MHz 455 kHz 30 kHz (SSB, CW, RTTY, PSK31, PACKET) 24 kHz (AM, FM, PACKET-FM)															
Sensitivity:	SSB/CW (BW: 2.4 kHz, 10 dB S+N/N) 0.16 μ V (1.8 - 30 MHz) (RF AMP 2 "ON") 0.125 μ V (50 - 54 MHz) (RF AMP 2 "ON") AM (BW: 6 kHz, 10 dB S+N/N, 30 % modulation @400 Hz) 2 μ V (0.5 - 1.8 MHz) (RF AMP 2 "ON") 2 μ V (1.8 - 30 MHz) (RF AMP 2 "ON") 1 μ V (50 - 54 MHz) (RF AMP 2 "ON") FM (BW: 15 kHz, 12 dB SINAD) 0.5 μ V (28 - 30 MHz) (RF AMP 2 "ON") 0.35 μ V (50 - 54 MHz) (RF AMP 2 "ON") There is no specification for frequency ranges not listed.															
Selectivity (WIDTH: Center):	<table><thead><tr><th>Mode</th><th>-6 dB</th><th>-60 dB</th></tr></thead><tbody><tr><td>CW/RTTY/PSK31</td><td>0.5 kHz or better</td><td>750 Hz or less</td></tr><tr><td>SSB</td><td>2.4 kHz or better</td><td>3.6 kHz or less</td></tr><tr><td>AM</td><td>6 kHz or better</td><td>15 kHz or less</td></tr><tr><td>FM</td><td>12 kHz or better</td><td>30 kHz or less</td></tr></tbody></table>	Mode	-6 dB	-60 dB	CW/RTTY/PSK31	0.5 kHz or better	750 Hz or less	SSB	2.4 kHz or better	3.6 kHz or less	AM	6 kHz or better	15 kHz or less	FM	12 kHz or better	30 kHz or less
Mode	-6 dB	-60 dB														
CW/RTTY/PSK31	0.5 kHz or better	750 Hz or less														
SSB	2.4 kHz or better	3.6 kHz or less														
AM	6 kHz or better	15 kHz or less														
FM	12 kHz or better	30 kHz or less														
Image Rejection:	70 dB or better (1.8 MHz - 28 MHz Amateur bands) 60 dB or better (50 MHz - 54 MHz Amateur band)															
Maximum Audio Output:	2.5 W into 4 Ohms with 10% THD															
Audio Output Impedance:	4 to 8 Ohms (4 Ohms: nominal)															
Conducted Radiation:	Less than 4 nW															

Specifications are subject to change, in the interest of technical improvement, without notice or obligation, and are guaranteed only within the amateur bands.

NOTE

This equipment has been tested and found to comply with the limits for a Class B digital device, pursuant to Part 15 of the FCC Rules. These limits are designed to provide reasonable protection against harmful interference in a residential installation. This equipment generates, uses and can radiate radio frequency energy and, if not installed and used in accordance with the instructions, may cause harmful interference to radio communications. However, there is no guarantee that interference will not occur in a particular installation.

If this equipment does cause harmful interference to radio or television reception, which can be determined by turning the equipment off and on, the user is encouraged to try to correct the interference by one or more of the following measures:

- Increase the separation between the equipment and receiver.
- Connect the equipment into an outlet on a circuit different from that to which the receiver is connected.
- Consult the dealer or an experienced radio/TV technician for help.

1. Changes or modifications to this device not expressly approved by YAESU MUSEN could void the user's authorization to operate this device.
2. This device complies with part 15 of the FCC Rules. Operation is subject to the following two conditions; (1) this device may not cause harmful interference, and (2) this device must accept any interference including interference that may cause undesired operation.
3. The scanning receiver in this equipment is incapable of tuning, or readily being altered, by the User to operate within the frequency bands allocated to the Domestic public Cellular Telecommunications Service in Part 22.

This device complies with Industry Canada licence-exempt RSS standard(s). Operation is subject to the following two conditions: (1) this device may not cause interference, and (2) this device must accept any interference, including interference that may cause undesired operation of the device.

Le présent appareil est conforme aux CNR d'Industrie Canada applicables aux appareils radio exempts de licence. L'exploitation est autorisée aux deux conditions suivantes : (1) l'appareil ne doit pas produire de brouillage, et (2) l'utilisateur de l'appareil doit accepter tout brouillage radioélectrique subi, même si le brouillage est susceptible d'en compromettre le fonctionnement.

DECLARATION BY MANUFACTURER

The scanner receiver is not a digital scanner and is incapable of being converted or modified into a digital scanner receiver by any user.

WARNING: MODIFICATION OF THIS DEVICE TO RECEIVE CELLULAR RADIOTELEPHONE SERVICE SIGNALS IS PROHIBITED UNDER FCC RULES AND FEDERAL LAW.

CAN ICES-3 (B) / NMB-3 (B)

Disposal of your Electronic and Electric Equipment

Products with the symbol (crossed-out wheeled bin) cannot be disposed as household waste. Electronic and Electric Equipment should be recycled at a facility capable of handling these items and their waste by products.

In EU countries, please contact your local equipment supplier representative or service center for information about the waste collection system in your country.



YAESU

The radio

Copyright 2013
YAESU MUSEN CO., LTD.
All rights reserved

No portion of this manual
may be reproduced without
the permission of
YAESU MUSEN CO., LTD.

Printed in Japan

1306T·AY

