

# FTDX9000D

## Operation Manual



  
**YAESU**  
*Choice of the World's top DX'ers*



# GENERAL DESCRIPTION

We wish to take this opportunity to thank you for your purchase of the FT DX 9000D Transceiver!

The FT DX 9000D is the culmination of a four-year design project. But it also is the product of our company's fifty years of engineering, design, and manufacturing know how. As pioneers in the development of SSB, we have led the technological advances in Amateur Radio communications over the last half century. And now, with the introduction of the FT DX 9000D, we again lead the way with a no-compromise 21st-century design that will make your operating dreams come true. More importantly, it is a radio that will let your skills and experience find expression, as you harness the excitement of HF operating like you've never done before!

---

---

## ABOUT THIS MANUAL. . .

---

---

The FT DX 9000D is a leading-edge transceiver with a number of new and exciting features, some of which may be unfamiliar to you. In order to gain the most enjoyment and operating efficiency from your FT DX 9000D, we recommend that you read this manual in its entirety, and keep it handy for reference as you explore the many capabilities of your new transceiver.

Before using your FT DX 9000D, be sure to read and follow the instructions in the "Before You Begin" section of this manual.

---

---

## CONVENTIONS USED IN THIS MANUAL

---

---

Please note the conventions, described below, for operational commands and texts included in this manual.

**[ ](#○)**..... This refers to a switch or knob used for controlling a particular function. The name or number inside the brackets designate the name of the switch/knob, or its reference number within this manual

**[ ]**..... This is the name of a switch or knob.

**[ ]**..... This indicates one of the [F1] ~ [F8] "Soft Keys" below the TFT display.

**[XX]**..... In the texts, you may be advised to press a button momentarily, or press and hold it in for a time interval (such as two seconds). Please be sure to observe the proper procedure when pressing a button.

**[OO]**..... This indicates the pressing of a button when a "momentary" press is the only selection available.

**『Note』**..... This is used for a note as to a particular point of interest.

**『Advice』**..... This is used to amplify or expand on instructions, so as to recommend a way to gain maximum benefit from a feature or function.

**『Example』**..... This is used to demonstrate an example of how a feature or function should work or be programmed.

**『Quick Note』/『Quick Point』** This is used for a brief explanation of a particular aspect of operation.

**『Terminology』**..... An explanation of a term or expression used in this manual.

---

---

## ABOUT THE TFT DISPLAY

---

---

In the FT DX 9000 Series, a large 6.5" (800 x 480 dot) TFT is built into the FT DX 9000D version, and is optional on other versions. Please see the separate TFT Operation Manual for details regarding TFT operation.

○ The TFT is a precision-designed, advanced display unit. You may observe, inside the TFT panel, a black point, or a luminescent point or points; these are normal, and do not indicate a defective TFT. Please note.

○ If you turn on the FT DX 9000 (with the TFT) in a cold environment, or if the transceiver itself is very cold, it may require several minutes for the TFT to warm up to full brilliance of color and full illumination. This is a normal condition, and does not indicate a breakdown.

○ There may be times when the TFT display illumination appears not to be uniform, but this is a normal condition.

This device is designed for Amateur Radio operation only. Operation on the Amateur Radio bands requires a license, in accordance with the telecommunications statutes in your country. The discussions in this manual presume that you possess the fundamental knowledge consistent with your status as a licensed Amateur Radio operator.

# TABLE OF CONTENTS

<b>General Description</b> .....	<b>1</b>	More Frequency Navigation Techniques .....	57
About This Manual. . .	1	ANTENNA SELECTION .....	58
Conventions Used in This Manual .....	1	Changing the Speaker Output Configuration .....	59
About the TFT Display .....	1	Receiver Operation (Front End Block Diagram) .....	60
<b>Before You Begin.</b> . . .	<b>4</b>	IPO (Intercept Point Optimization) .....	61
1. Connecting AC Power .....	4	ATT .....	62
2. Setting Your Local Time .....	4	RF Gain (SSB/CW/AM Modes) .....	63
3. Configuring Your FT DX 9000 Using the Menu .....	4	<b>Advanced Interference-</b>	
4. Connecting and Selecting the Microphone .....	5	<b>Suppression Features</b> .....	<b>64</b>
5. Extending the Front Feet .....	5	Using the $\mu$ -Tune Feature .....	64
6. Adjusting the Main Dial Torque .....	6	Using the VRF (Variable RF Front-end Filter) .....	66
7. Restarting Power after a Voltage Fluctuation .....	6	<b>Interference Rejection</b> .....	<b>67</b>
8. Resetting the Microprocessor .....	7	R.FLT (Roofing Filters) .....	67
Resetting Memories (Only) .....	7	CONT (Contour) Control Operation .....	68
Menu Resetting .....	7	IF SHIFT Operation (SSB/CW/RTTY/PKT/AM Modes) .....	69
Full Reset .....	7	WIDTH (IF DSP Bandwidth) Tuning	
<b>Features</b> .....	<b>8</b>	(SSB/CW/RTTY/PKT Modes) .....	70
<b>Accessories</b> .....	<b>10</b>	Using IF Shift and Width Together .....	70
<b>Options</b> .....	<b>11</b>	IF Notch Filter Operation (SSB/CW/RTTY/PKT/AM Modes) .....	71
<b>Installation and Interconnections</b> .....	<b>12</b>	Digital Noise Reduction (DNR) Operation .....	72
Antenna Considerations .....	12	NARROW (NAR) One-Touch IF Filter Selection .....	73
About Coaxial Cable .....	12	Digital Notch Filter (DNF) Operation .....	74
Grounding .....	13	IF Noise Blanker (NB) Operation .....	74
Connection of Antenna and Power Cables .....	14	<b>Tools for Comfortable and</b>	
Connection of Microphone, Headphones and		<b>Effective Reception</b> .....	<b>75</b>
FH-2 Remote Control Keypad .....	15	AGC (Automatic Gain Control) .....	75
Key, Keyer, and Computer-Driven Keying Interconnections .....	16	SLOPED AGC Operation .....	76
VL-1000 Linear Amplifier Interconnections .....	17	Mute Feature Main (VFO-A) Band .....	77
Interfacing to Other Linear Amplifiers .....	18	Audio Limiter (AFL) Feature .....	77
<b>Plug/Connector Pinout Diagrams</b> .....	<b>19</b>	Adjacent Channel Monitor (ACM) CW Mode Only .....	78
<b>Front Panel Controls</b> .....	<b>20</b>	<b>SSB/AM Mode Transmission</b>	
<b>Rear Panel</b> .....	<b>36</b>	(Let's Look at the Transmitter. . .) .....	<b>80</b>
<b>Frequency Display</b> .....	<b>39</b>	Phantom Voltage for Condenser Microphones .....	81
<b>TFT Feature/Control Details</b> .....	<b>40</b>	<b>Using the Automatic Antenna Tuner</b> .....	<b>82</b>
<b>FH-2 Operation</b> .....	<b>41</b>	ATU Operation .....	82
<b>Basic Operation:</b>		About ATU Operation .....	83
<b>Receiving on Amateur Bands</b> .....	<b>42</b>	Lithium Battery Replacement .....	84
Operation .....	43	<b>SSB/AM Mode Transmission</b> .....	<b>86</b>
Operation on 60-Meter (5 MHz) Band (U.S. version only) .....	45	Using the Speech Processor - SSB, AM Mode - .....	86
CLAR (Clarifier) Operation on Main (VFO-A) .....	46	Adjusting the SSB Transmitted Bandwidth .....	87
LOCK .....	47	Signal Quality Enhancement Using the	
DIM .....	47	Parametric Microphone Equalizer .....	88
B-DISP OFF .....	47	Low-Distortion CLASS-A Operation .....	90
<b>Convenient Features</b> .....	<b>48</b>	Voice Memory .....	92
Dual Receive .....	48	<b>Convenient Transmitter Accessories</b> .....	<b>94</b>
P.BACK (Audio Playback) from Main (VFO-A) Receiver .....	52	VOX: Automatic TX/RX Switching using Voice Control	
"MY Bands" Operation .....	53	SSB/AM/FM Modes .....	94
Band Stack Operation .....	54	Using the MONITOR .....	94
Dial Swap Configuration (AF/RF GAIN controls) .....	55	Split Operation Using the TX Clarifier (VFO-A Operation) .....	95
C.S (Custom Switch) .....	56	Clarifier Offset Bar Indicator .....	95
		Split-Frequency Operation .....	96
		Quick Split Operation .....	97
		Full Duplex Operation .....	98



# TABLE OF CONTENTS

<b>CW Mode Operation .....</b>	<b>100</b>	<b>Memory Operation .....</b>	<b>115</b>
Setup for Straight Key (and Straight Key emulation) Operation ....	100	Memory Storage .....	115
Using the Built-in Electronic Keyer .....	101	Memory Channel Recall .....	115
Full Break-in (QSK) Operation .....	101	Checking a Memory Channel's Status .....	116
Setting the Keyer Weight (Dot/Space:Dash ) Ratio .....	102	Erasing Memory Channel Data .....	116
Selecting the Keyer Operating Mode .....	102	Moving Memory Data to the Main (VFO-A) Band .....	117
<b>CW Convenience Features .....</b>	<b>103</b>	Memory Tune Operation .....	117
CW Spotting (Zero-Beating) .....	103	Operation on Alaska Emergency Frequency:	
Using CW Reverse .....	104	5167.5 kHz (U.S. Version Only) .....	118
CW Delay Time Setting .....	105	Operation on the 60-Meter Band (U.S. Version) .....	119
CW Pitch Adjustment .....	105	<b>VFO and Memory Scanning .....</b>	<b>120</b>
Contest Memory Keyer .....	106	VFO Scanning .....	120
Message Memory .....	106	Memory Scan .....	120
TEXT Memory .....	108	<b>PMS .....</b>	<b>121</b>
<b>FM Mode Operation .....</b>	<b>110</b>	<b>Packet Operation .....</b>	<b>122</b>
Operation .....	110	<b>RTTY (Radio TeleType) Operation .....</b>	<b>123</b>
Repeater Operation .....	111	<b>Miscellaneous AFSK-based Data Modes .....</b>	<b>124</b>
<b>Convenient Memory Functions .....</b>	<b>112</b>	<b>Menu Mode .....</b>	<b>126</b>
<b>QMB (Quick Memory Bank) .....</b>	<b>113</b>	Using the Menu .....	126
QMB Channel Storage .....	113	Menu Mode Reset .....	126
QMB Channel Recall .....	113	Menu Mode Setting Table .....	127
<b>Memory Groups .....</b>	<b>114</b>	Menu Mode Setting .....	131
Memory Group Assignment .....	114	<b>Specifications .....</b>	<b>148</b>
Choosing the Desired Memory Group .....	114		

# Before You Begin. . .

## 1. Connecting AC Power

There are two power switches on this transceiver, one each on the rear and front panels. If the rear panel's Power switch is not turned on, the front panel Power switch will not function.

- Push the rear panel's Power switch to the **【 I 】** position to apply power from the power supply to the OCXO (Reference Crystal Oven) and to enable the front panel power switch.
- Press and hold in the front panel Power switch for two seconds to turn the transceiver on.

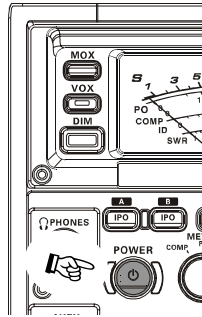
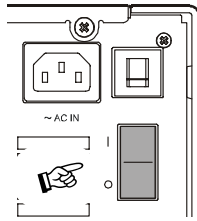

### 『Note』

The opening screen will appear on the TFT display, and the self-check function of the CPU inside the radio will begin. Then, the  $\mu$ -Tuning circuitry will receive the data from the CPU, and it will perform its own self-check, and will preset itself to the proper settings for the current operating frequency.

While the  $\mu$ -Tuning circuitry is obtaining the data, the drive mechanism will move from one end of its range to the other end (fast), and this will cause a temporary "motor" noise that can be heard; this, does not represent any trouble or problem.

When the radio is turned on for the first time, it takes about 50 seconds (from turning the radio on to completing the self-check) until the radio becomes ready to use; however, from the next time you turn it on, it will take around 10 seconds until the transceiver is ready for full operation.

## 2. Setting Your Local Time

When first turning on the FT DX 9000, be sure to set the local time to match your location's time zone. If you do not do this, several functions will not work correctly, including the World Clock, Great Circle Map, etc.; please see the appropriate section of the TFT Operating Manual for details on Local Time Setup.

## 3. Configuring Your FT DX 9000 Using the Menu

The FT DX 9000 is configured, at the factory, with its various functions set up in a manner typical for most operation. Via the "Menu" system, you may change these settings to match the way you want your transceiver to operate.

Menu programming is enabled by pressing the **【MNU】** (Menu) key momentarily. You may then rotate the **【Main】** Tuning Dial to display the desired Menu item, in the menu list, on the TFT. Each of the settings can be changed or customized via the **【CLAR/VFO-B】** knob, as you like, in this mode.

Once you have made a change to the configuration of a Menu item or items, you must press **and hold in** the **【MNU】** (Menu) key for **two seconds** to save the new settings and exit to normal operation.

If you wish to cancel a change to a Menu item or items, just press the **【MNU】** key momentarily. If you do not press and hold in the **【MNU】** key in for two seconds, any changes you have made will not be saved.

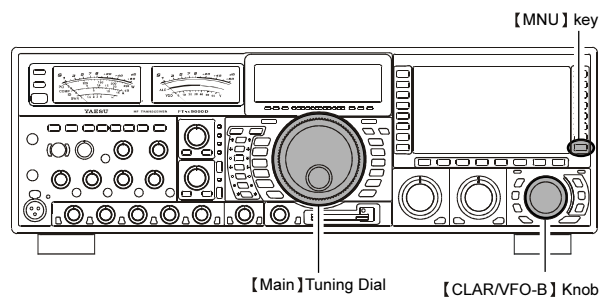

# Before You Begin...

## 4. Connecting and Selecting the Microphone

The FT DX 9000D comes equipped with two microphone connectors: the front panel includes a “Canon” (XLR) three-pin connector, while the rear panel provides an eight-pin (round) connector.

As shipped from the factory, the front panel XLR connector is engaged for operation, and the rear panel 8-pin microphone jack is not connected. If you wish to enable the 8-pin connector instead of the XLR connector, use the Menu to accomplish this. Note that you may leave microphones connected to both jacks, and may select the microphone you want for operation on a particular operating mode (SSB, AM, FM, etc.), as well!

- Press the **[MNU]** (Menu) key momentarily to enter the Menu Mode.
- Rotate the **[Main]** Tuning Dial to select Menu Item #69, located within the “MODE SSB” group: SSB MIC SELECT.
- Rotate the **[CLAR/VFO-B]** knob to change the setting of Menu #069 from “FRONT” to “REAR.”
- Press **and hold in** the **[MNU]** (Menu) key for *two seconds* to save the new setting and exit to normal operation.
- In a similar manner, you may use Menu #040 (AM MIC SEL) in the MODE-AM Menu Group to select the microphone jack to be used during AM operation, and Menu #059 (FM MIC SEL) in the MODE-FM Menu Group to select the microphone to be used during FM transmission.

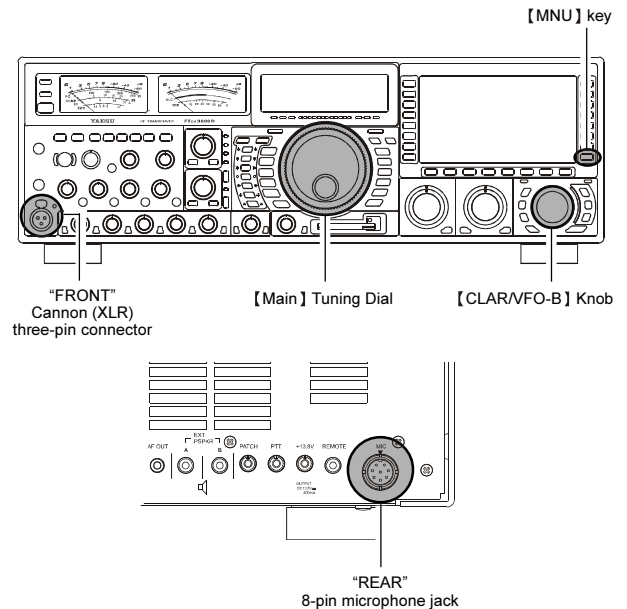

## 5. Extending the Front Feet

In order to elevate the front panel for easy viewing, the front left and right feet of the bottom case may be extended.

- Pull the front legs outward from the bottom panel.
- Rotate the legs counter-clockwise to lock them in the extended position. Be sure the legs have locked securely in place, because the transceiver is quite heavy and an unlocked leg could result in damage, should the transceiver move suddenly.

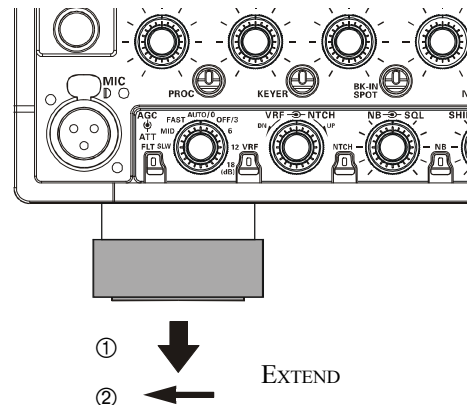

### Retracting the Front Feet

- Rotate the legs clockwise, and push them inward while rotating to the right.
- The front feet should now be locked in the retracted position.

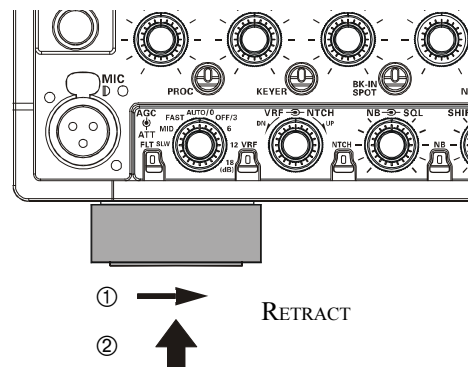

# Before You Begin. . .

## 6. Adjusting the Main Dial Torque

The torque (drag) of the Main Tuning Dial may be adjusted according to your preferences. Simply hold down the rear skirt of the knob, and while holding it in place rotate the Main Dial itself to the right to reduce the drag, or to the left to increase the drag.

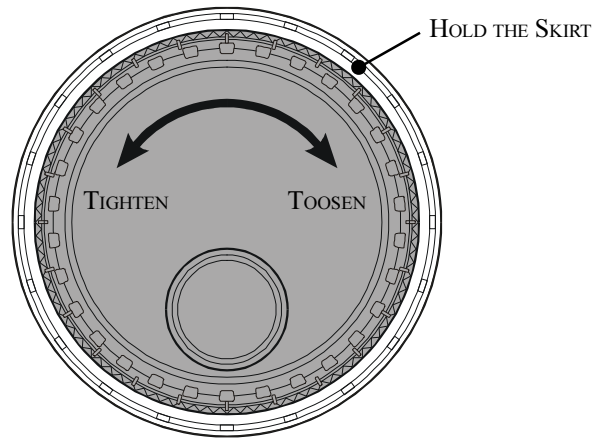

## 7. Restarting Power after a Voltage Fluctuation

If your AC mains power should suffer a significant fluctuation or interruption, we recommend that you go through a complete power-up cycle, in order to ensure that all circuits are properly initialized. To do this, be sure the front panel Power switch is turned off, then set the rear-panel Power switch to the "O" position. Now unplug the AC cable from the rear panel of the transceiver, and wait ten seconds. Plug the AC cable back in, set the rear-panel Power switch to "O," and now press and hold in the front-panel Power switch for two seconds to turn the transceiver on. After about 50 seconds, all circuits will be initialized, and normal operation may resume.

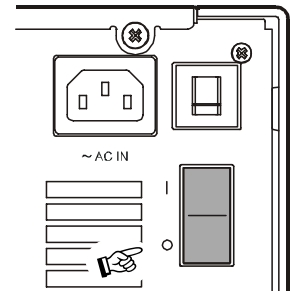

# Before You Begin...

## 8. Resetting the Microprocessor

### Resetting Memories (Only)

Use this procedure to reset (clear out) the Memory channels previously stored, without affecting any configuration changes you may have made to the Menu settings.

1. Press the front panel's **[POWER]** switch to turn the transceiver off.
2. Press and hold in the **[A▶M]** switch; while holding it in, press and hold in the front panel's **[POWER]** switch to turn the transceiver on. Once the transceiver comes on, you may release the **[A▶M]** switch.

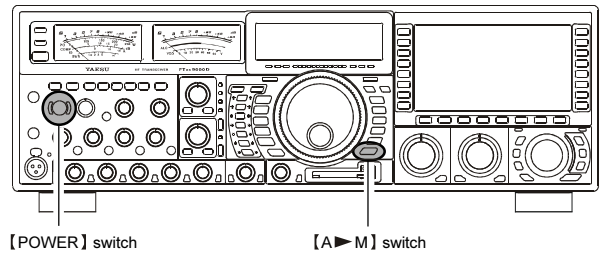

### Menu Resetting

Use this procedure to restore the Menu settings to their factory defaults, without affecting the memories you have programmed.

1. Press the front panel's **[POWER]** switch to turn the transceiver off.
2. Press and hold in the **[MNU]** (Menu) key; while holding it in, press and hold in the front panel's **[POWER]** switch to turn the transceiver on. Once the transceiver comes on, you may release the **[MNU]** (Menu) key.

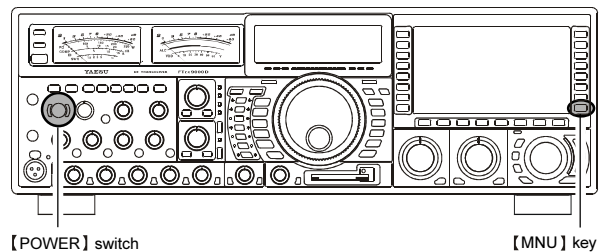

### Full Reset

Use this procedure to restore all Menu and Memory settings to their original factory defaults. All Memories will be cleared out by this procedure.

1. Press the front panel's **[POWER]** switch to turn the transceiver off.
2. Press and hold in the **[FAST]** and **[LOCK]** switches; while holding them in, press and hold in the front panel's **[POWER]** switch to turn the transceiver on. Once the transceiver comes on, you may release the other two switches.

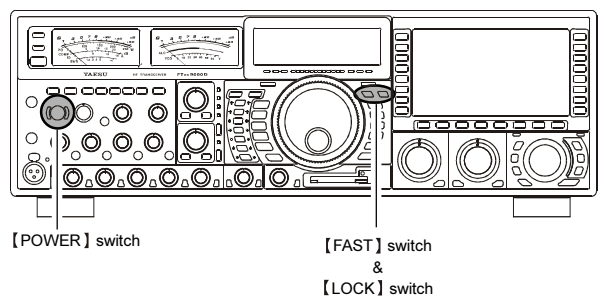

Downloaded by  
RadioAmateur.EU

# FEATURES

## Superior Visibility and Logical, Fatigue-reducing Panel Layout

The front panel layout is logically crafted, with the large-aperture main frequency display squarely in the middle of the front panel; the two large S-meters to the left providing instant recognition of signal strength.

Just as in an aircraft cockpit, the panel meters and the TFT are canted slightly toward the center for maximum visibility.

## Large, Multi-colored VFD Fluorescent Display

A proprietary, high-brightness VFD (fluorescent) display is incorporated in the FT DX 9000D, providing outstanding visibility (superior even to the TFT) and easy reading of the important frequency information, whether in dim or bright lighting environments.

## Function-Indicating LEDs

The many function status indications on the front panel are clearly identified by the operator, thanks to the innovative multi-color LEDs incorporated in design. A Red LED indicates that a function is engaged on the Main Band, while an Orange LED shows that the function is engaged on the Sub Band.

## Indirect Illumination

For ease of nighttime operation, the controls on the front panel are indirectly illuminated, thanks to carefully-positioned lamps in the frame underneath the meters and TFT (depending on model).

## Aluminum-Die-Cast Oversized Main Tuning Dial

The Main Tuning Dial is a large-diameter (3.2"/81 mm) dial directly coupled to the magnetic rotary encoder which drives the HRDDS via microprocessor control. Its heavy weight (7 oz./200 g) and quality mounting and construction provide a smooth "flywheel" effect during operation, ideal for quick cruising up and down a band.

## Oversized Knobs for Most Important Functions

The concentric AF/RF Gain, SHIFT/WIDTH, and CLAR/VFO-B knobs are conveniently located right below the TFT, for ease of access to these important controls.

## World's First 400 MHz HRDDS Local Oscillator

So as to optimize spurious-free dynamic range in a multi-signal environment, Yaesu's engineers have introduced the world's first HRDDS (High Resolution Direct Digital Synthesizer) as the first local oscillator of the FT DX 9000D. Dividing directly from this high frequency, this local oscillator design ensures extraordinarily low noise, resulting in improved weak-signal reception even on a crowded band during a weekend contest.

## New-design Large-area OCXO Reference Oscillator

Serving as the master reference oscillator for the transceiver, the 10 MHz OCXO (Oven Controlled Crystal Oscillator) is a large-area (50 x 50 mm/2" x 2") oven-stabilized oscillator operating at high temperature, for industry-leading frequency stability rated at 0.03 ppm over the temperature range -10° to +60° C (-14° to +140° F).

## Triple-conversion Design with Optimized Gain Distribution

Taking into account the most efficient transceiver design concept consistent with high performance we have adopted a triple-conversion IF structure, utilizing a first IF at 40 MHz, a second IF at 455 kHz, and the third IF at 30 kHz (for FM, the 3rd IF is at 24 kHz). Gain distribution through all stages is carefully optimized, for preservation of high system dynamic range.

## Ultra-strong Receiver Front End

YAESU's outstanding RF-stage filtering establishes a clean performance that allows the rest of the receiver to perform at a high level. By reducing the ingress of energy from very strong sources like Shortwave Broadcast, local AM/FM/TV stations, and other signal sources, the overall purity of the spectrum delivered to the RF Amplifier first mixer, and subsequent stages is maintained, and the system Blocking Dynamic Range is also enhanced.

## Large, Multi-function Color TFT Display

The 800 x 480 dot, 6.5" TFT display is loaded with information that enhances operation of your FT DX 9000D. Besides general status information, the TFT includes an Audio Scope (both audio spectrum and "Waterfall" displays) and Oscilloscope page, an RF Spectrum Scope, a Log Book, Swept-Frequency SWR along with PA Temperature, Bias Level, and Voltage, Memory Channel List, World Clock with Grey Line display, and a Great Circle Map centered on your location, plus direction indication and control of Yaesu Rotators!

## Compact Flash (CF) Card for Data Management

A Compact Flash card is supplied with every FT DX 9000D, for preservation of transceiver configuration settings along with Log Book archival data.

## Professional-Grade Cannon (XLR) Microphone Connector

The FT DX 9000D incorporates, for the first time ever in an Amateur Radio transceiver, a balanced-input "Cannon" (XLR) microphone connector on the front panel, for use with studio-grade professional microphones. A round 8-pin microphone jack is also provided on the rear panel.

## Two High-precision Analog Meters (Page 29)

The FT DX 9000D incorporates two large (3.4"/86 mm) high-precision analog meters, for the utmost accuracy in measuring transceiver performance. Visibility is enhanced by the oversized meter scales, making the meters easy to read at all times.

## **Separated Clarifier Display (Page 46, 95)**

A clearly-separated display window within the main frequency display area contains receiver and/or transmitter frequency offset ("Clarifier") data, for quick comprehension by the operator.

## **YAESU Custom-designed 32-Bit Floating Point IF DSP (Page 60)**

The new IF DSP system, utilizing a TI TMS320C6711 device, is a high-speed 32-bit floating point circuit designed with a unique objective: to do away with the "digital" sound of many DSP filtering systems, and emulate the "Analog Sound" so familiar and comfortable to HF DX and Contest operators. The result is a leading-edge receiver that has the "feel" of a traditional analog receiver, but with the flexibility and superb filtering capability of a modern digital filtering system.

## **New Mu ( $\mu$ ) Narrow-bandwidth High-Q RF Filters Using Large-Diameter (28 mm) Coils (Page 64)**

On the 14 MHz and lower Amateur bands, Yaesu's breakthrough " $\mu$ -Tuning" RF preselector filters provide the greatest level of RF protection ever incorporated into an Amateur Radio transceiver. Utilizing a 1.1" (28 mm) ferrite core stack, driven through a coil structure,  $\mu$ -Tuning provides greatly improved RF selectivity, even compared to our VRF (Variable RF Filter) preselector, resulting in an ultra-strong front end. Insertion of the  $\mu$ -Tuning filter improves the 3rd-Order Intercept Point by at least 4 dB, and you can operate on a very crowded band with the utmost confidence in your receiver.

## **VRF (Variable RF Filter) Preselector Filter (Page 66)**

On the 18 MHz and higher Amateur bands, and on 1.8 - 50 MHz on the Sub (VFO-B) band, Yaesu's robust VRF (Variable RF Filter) preselector provides a relay-selected RF selectivity much tighter than that afforded by traditional bandpass filter networks. Sealed relays select heavy-duty inductors and capacitors, providing a tracking RF filter that protects the RF amplifier and following stages from strong out-of-band energy.

## **First IF 3 kHz Roofing Filter (Page 25, 67)**

In the 40 MHz 1st IF, three selectable roofing filters are provided, in bandwidths of 3 kHz, 6 kHz, and 15 kHz, to protect the following stages from strong signals that could degrade dynamic range in the first IF amplifier and subsequent stages. The roofing filters are automatically assigned according to the operating mode, but the operator may override the automatic selections on the fly.

## **CONTOUR Filter Enhances "Analog Feeling" of DSP Filters (Page 25, 68)**

The DSP-based Contour system is a unique five-band filter that may be used to roll off or peak the IF response. It is chiefly useful for modifying the response of the ultra-sharp DSP filters, allowing you to roll off (or emphasize) certain frequency components. Oftentimes, the result is that a difficult-to-understand signal suddenly will pop out of the background noise as solid copy.

## **SLOPED AGC Circuitry (Page 76)**

In traditional AGC systems, all signals rising above a certain RF level are then clamped together at the same audio output, so as to prevent distortion throughout the IF and AF stages. In the FT DX 9000D, however, you can engage the "Sloped" AGC capability to provide an AGC response whereby ever-increasing signal strength results in a slightly-louder audio response, still without accompanying distortion. This lets you use your brain to sort out weak signals from strong ones more effectively.

## **Receiver AF Limiter Circuit (Page 33, 77)**

Occasionally a noise burst or a sudden transmission from a loud station may startle you if you have the AF Gain turned up, and may even damage your hearing temporarily. The FT DX 9000D provides an AF Limiter (AFL) circuit which, once engaged, clamps an upper limit on the available audio output power, much like the AGC circuit does in the RF and IF stages.

## **"Adjacent Channel Encroachment" S-Meter Monitor (Page 33, 78)**

When operating CW in a narrow bandwidth like 300 Hz, you may not be aware of the presence of strong stations that may be making it difficult for others to hear you. In these situations, the "ACM" (Adjacent Channel Monitor) will take over the Sub Receiver, center it on the Main Receiver frequency, and display  $\pm 1.2$  kHz of signal activity on the Sub Receiver's S-meter (without feeding the interfering audio through). This alerts you to the situation, and you can QSY or ask the other station to QSY.

## **Rugged, High-Output Final Amplifier Design (Page 91)**

The final amplifier stage of the FT DX 9000D utilizes push-pull SD2931 MOS FET devices in a conservative, high-stability design. The large-area die-cast aluminum heat sink is monitored thermostatically, and a quiet cooling fan will engage when the heat sink temperature rises during long periods of high-power transmission.

## **Ultra-linear Class-A Operation Capability (Page 90)**

The FT DX 9000D's Class-A capability provides ultra-linear amplifier operation at 75 Watts of power output. Typically, 3rd-order IMD products are suppressed more than 50 dB, while 5th- and higher-order distortion products are at least 70 dB down during Class-A operation.

## **Parametric Microphone Equalizer Circuit (Page 88)**

For unmatched flexibility in tailoring your microphone's audio to match your voice, Yaesu's engineers have incorporated the industry's first Three-Band Parametric Microphone Equalizer, which allows you to enhance or suppress frequency components in three different audio bands. Equalization may be applied independently to microphones attached to the front and rear panel microphone jacks.

# ACCESSORIES

## SUPPLIED ACCESSORIES

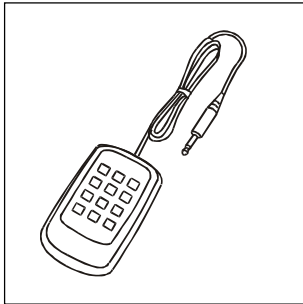

**FH-2**

Remote Control Keypad

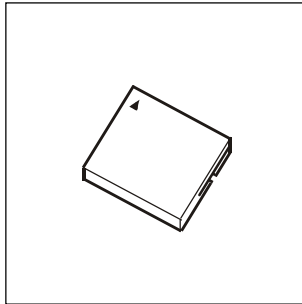

**CF Card**

(64 MB: Q9000838)

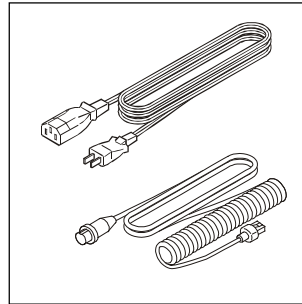

**AC Power Cord\*1**

**Microphone Extend Cable\*2**  
(8 Pin ⇄ Modular)

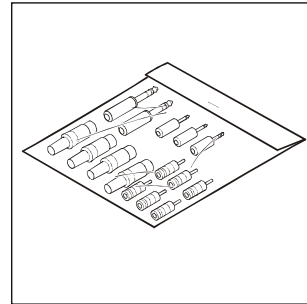

**Plugs**

- Operating Manual
- Warranty Card

※2: AC Power Cord

USA: T9017882

Europe: T9013285

Australia: T9013283A

UK: T9013285

※2: This microphone cable (T9101549) is for use with the optional MD-200A8X, MD-100A8X, or MH-31B8 microphones.

### Plug Details and Part Numbers

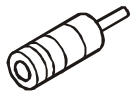

**RCA Plug (P0091365)**  
6 pcs

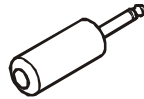

**3.5 mm 2-contact Plug (P0090034)**  
2 pcs



**3.5 mm 3-contact Plug (P0091046)**  
1 pc

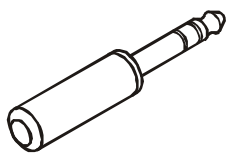

**1/4-inch 3-contact Plug (P0090008)**  
2 pcs

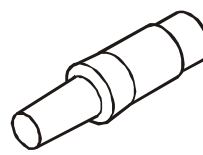

**4-pin DIN Plug (P0091004) 1 pc**  
**5-pin DIN Plug (P0091006) 1 pc**  
**7-pin DIN Plug (P0091419) 1 pc**  
**8-pin DIN Plug (P0090651) 1 pc**

Items are shown for illustrative purposes only, and may vary slightly in appearance.



## AVAILABLE OPTIONS

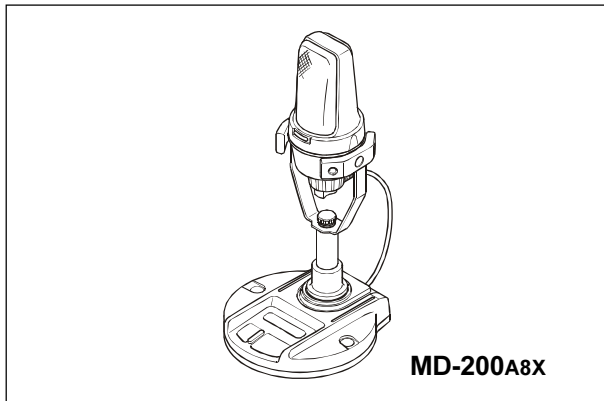

**Ultra-High-Fidelity Desk-Top Microphone  
MD-200A8X**  
**Desk-Top Microphone  
MD-100A8X**



**Lightweight Stereo Headphones  
YH-77STA**

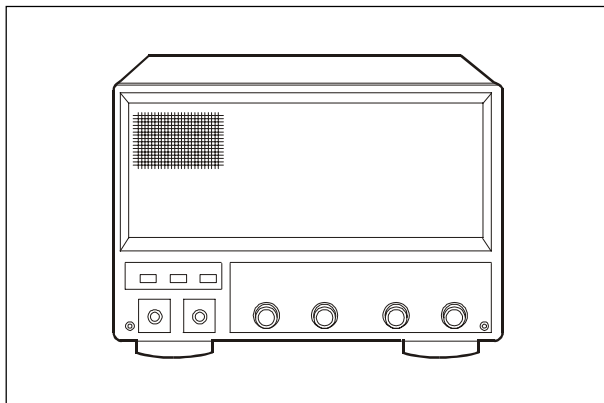

**External Speaker with Dual Speakers and Audio Filter  
SP-9000**

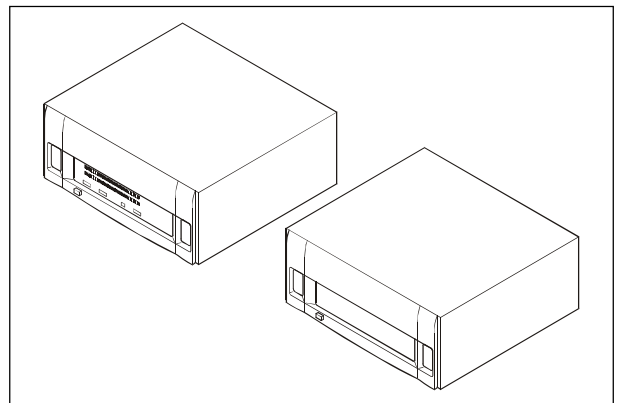

**Linear Amplifier / AC Power Supply  
VL-1000 / VP-1000**

# INSTALLATION AND INTERCONNECTIONS

## ANTENNA CONSIDERATIONS

The FT DX 9000D is designed for use with any antenna system providing a 50 Ohm resistive impedance at the desired operating frequency. While minor excursions from the 50-Ohm specification are of no consequence, the transceiver's Automatic Antenna Tuner may not be able to reduce the impedance mismatch to an acceptable value if the Standing Wave Ratio (SWR) present at the Antenna jack is greater than 3:1.

Every effort should, therefore, be made to ensure that the impedance of the antenna system utilized with the FT DX 9000D be as close as possible to the specified 50-Ohm value.

Any antenna to be used with the FT DX 9000D must, ultimately, be fed with 50 Ohm coaxial cable. Therefore, when using a "balanced" antenna such as a dipole, remember that a balun or other matching/balancing device must be used so as to ensure proper antenna performance.

The same precautions apply to any additional (receive-only) antennas connected to the RX ANT jack; if your receive-only antennas do not have an impedance near 50 Ohms at the operating frequency, you may need to install an external antenna tuner to obtain optimum performance.

## ABOUT COAXIAL CABLE

Use high-quality 50-Ohm coaxial cable for the lead-in to your FT DX 9000D transceiver. All efforts at providing an efficient antenna system will be wasted if poor quality, lossy coaxial cable is used. This transceiver utilizes standard "M" ("PL-259") type connectors, except for the "RX OUT" BNC connectors used for special filters, etc.



Typical PL-259 Installation

# INSTALLATION AND INTERCONNECTIONS

## GROUNDING

The FT<sub>DX</sub> 9000D HF transceiver, like any other HF communications apparatus, requires an effective ground system for maximum electrical safety and best communications effectiveness. A good ground system can contribute to station efficiency in a number of ways:

- It can minimize the possibility of electrical shock to the operator.
- It can minimize RF currents flowing on the shield of the coaxial cable and the chassis of the transceiver; such currents may lead to radiation which can cause interference to home entertainment devices or laboratory test equipment.
- It can minimize the possibility of erratic transceiver/accessory operation caused by RF feedback and/or improper current flow through logic devices.

An effective earth ground system make take several forms; for a more complete discussion, see an appropriate RF engineering text. The information below is intended only as a guideline.

Typically, the ground connection consists of one or more copper-clad steel rods, driven into the ground. If multiple ground rods are used, they should be positioned in a “V” configuration, and bonded together at the apex of the “V” which is nearest the station location. Use a heavy, braided cable (such as the discarded shield from type RG-213 coaxial cable) and strong cable clamps to secure the braided cable(s) to the ground rods. Be sure to weatherproof the connections to ensure many years of reliable service. Use the same type of heavy, braided cable for the connections to the station ground bus (described below).

Inside the station, a common ground bus consisting of a copper pipe of at least 25 mm (1”) diameter should be used. An alternative station ground bus may consist of a wide copper plate (single-sided circuit board material is ideal) secured to the bottom of the operating desk. Grounding connections from individual devices such as transceivers, power supplies, and data communications devices (TNCs, etc.) should be made directly to the ground bus using a heavy, braided cable.

Do not make ground connections from one electrical device to another, and thence to the ground bus. This so-called “Daisy-Chain” grounding technique may nullify any attempt at effective radio frequency grounding. See the drawing below for examples of proper grounding techniques.

Inspect the ground system - inside the station as well as outside - on a regular basis so as to ensure maximum performance and safety.

Besides following the above guidelines carefully, note that household or industrial gas lines must never be used in an attempt to establish an electrical ground. Cold water pipes may, in some instances, help in the grounding effort, but gas lines represent a significant explosion hazard, and must never be used.

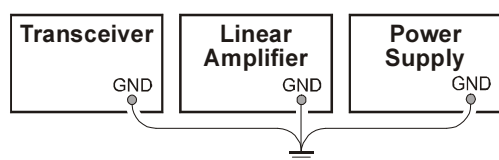

**PROPER GROUND CONNECTION**

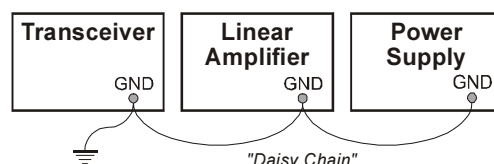

**IMPROPER GROUND CONNECTION**

# INSTALLATION AND INTERCONNECTIONS

## CONNECTION OF ANTENNA AND POWER CABLES

Please follow the outline in the illustration regarding the proper connection of antenna coaxial cables, as well as the AC power cable.

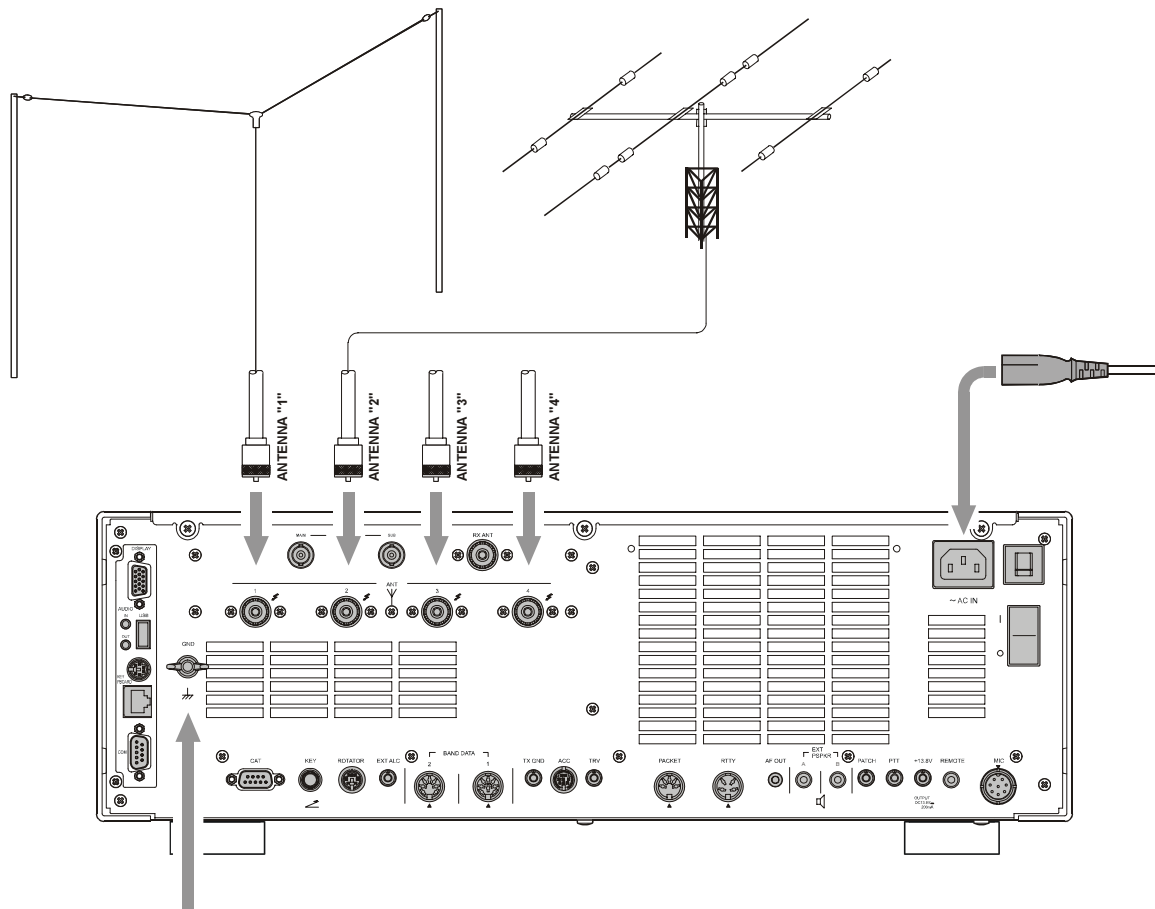

Use a short, thick, braided cable to connect your station equipment to the buried ground rod (or alternative earth ground system).

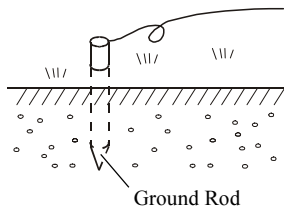

### 『Advice』

- Do not position this apparatus in a location with direct exposure to sunshine.
- Do not position this apparatus in a location exposed to dust and/or high humidity.
- Ensure adequate ventilation around this apparatus, so as to prevent heat build-up and possible reduction of performance due to high heat.
- Do not install this apparatus in a mechanically-unstable location, or where objects may fall onto this product from above.
- To minimize the possibility of interference to home entertainment devices, take all precautionary steps including separation of TV/FM antennas from Amateur transmitting antennas to the greatest extent possible, and keep transmitting coaxial cables separated from cables connected to home entertainment devices.
- Ensure that the AC power cord is not subject to undue stress or bending, which could damage the cable or cause it to be accidentally unplugged from the rear panel AC input jack.
- Be absolutely certain to install your transmitting antenna(s) such that they cannot possibly come in contact with TV/FM radio or other antennas, nor with outside power or telephone lines.

# INSTALLATION AND INTERCONNECTIONS

## CONNECTION OF MICROPHONE, HEADPHONES AND FH-2 REMOTE CONTROL KEYPAD

This transceiver was shipped from the factory in configuration for a microphone input via the **Front Panel XLR connector**. To use the **Rear Panel microphone** with an 8-pin round connector, please change the microphone set up via the Menu.

1. To do this, first press the **[MNU]** key located on the bottom right corner of the TFT display.
2. The Menu list will appear on the TFT display screen.
3. Rotate the **[Main]** tuning dial (VFO-A) to select menu item #069 (MODE-SSB 069 SSB MIC SELECT).
4. Now rotate the **[CLAR/VFO-B]** knob to change the setting to **Rear**.  
Available selections are FRONT-REAR-DATA-PC.
5. To save the set-up, press and hold in the **[MNU]** key for 2 seconds.  
If the **[MNU]** key is not held for 2 seconds, the set-up will not be saved.

**[Note]:** To use the AM or FM mode, please select Menu items 040 for AM and 059 for FM, and follow the same procedure above.

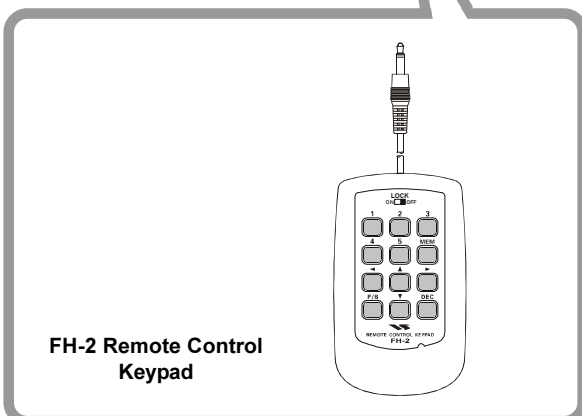
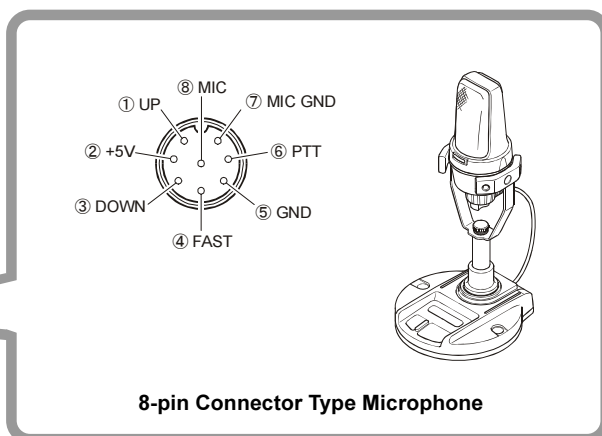
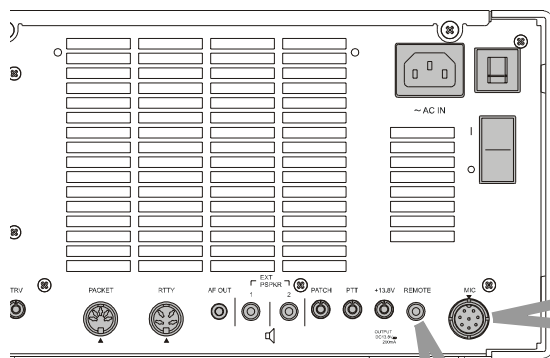
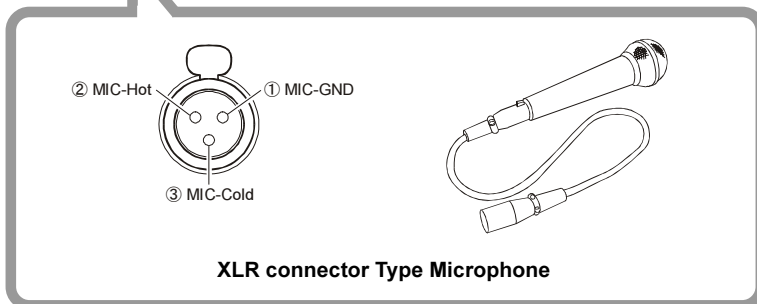
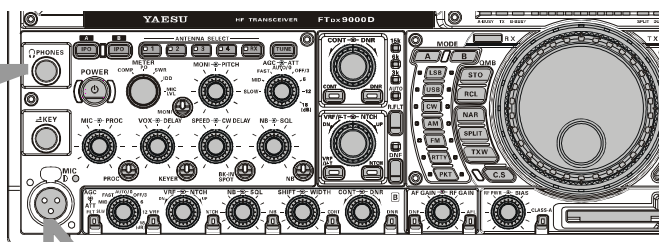
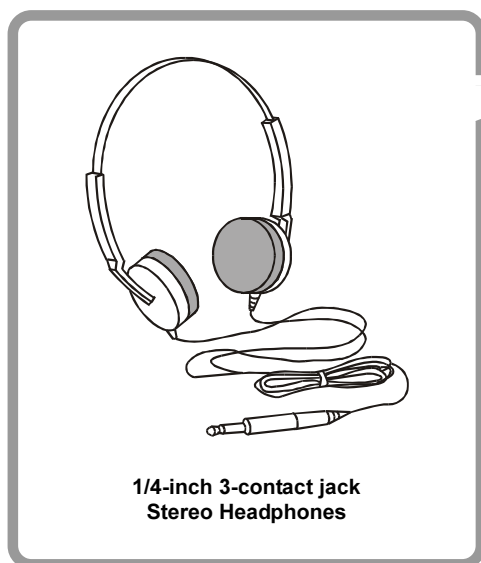

# INSTALLATION AND INTERCONNECTIONS

## KEY, KEYSER, AND COMPUTER-DRIVEN KEYING INTERCONNECTIONS

The FT DX 9000D includes a host of features for the CW operator, the functions of which will be detailed in the “Operation” section later. Besides the built-in Electronic Keyer, two key jacks are provided, one each on the front and rear panels, for convenient connection to keying devices.

The Menu system allows you to configure the front and rear panel KEY jacks according to the device you wish to connect. For example, you may connect your keyer paddle to the front panel KEY jack, and use Menu #041 for paddle input, while connecting the rear panel’s KEY jack to the keying line from your personal computer (which emulates a “straight key” for connection purposes), and configure the rear panel jack using Menu #43.

Both KEY jacks on the FT DX 9000D utilize “Positive” keying voltage. Key-up voltage is approximately +5V DC, and key-down current is approximately 1 mA.

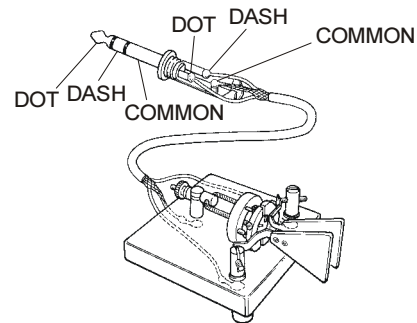
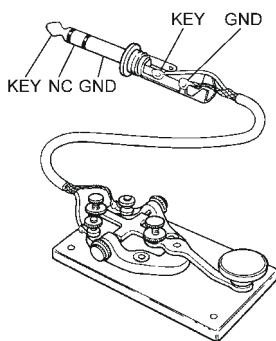
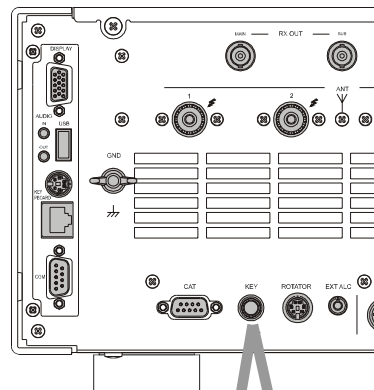
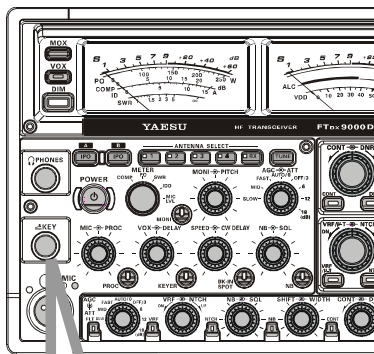

### 『Advice』

When connecting a key or other device to the KEY jacks, use only a 3-pin (“stereo”) 1/4” phone plug; a 2-pin plug will place a short between the ring and (grounded) shaft of the plug, resulting in a constant “key-down” condition in some circumstances.

## CONNECTING A GPS RECEIVER

If you connect a properly-equipped after-market GPS receiver (not supplied) to the COM port on the back of the transceiver, the “Rotator” page on the TFT display will automatically include a Great Circle map centered on your location.

Connect a GPS receiver capable of output of NMEA-0183 data to the COM port. The data line connects to Pin 2, and the ground shield connects to Pin 5.

This transceiver can support the GGA, GLL, and RMC Data Sentences from the GPS unit.

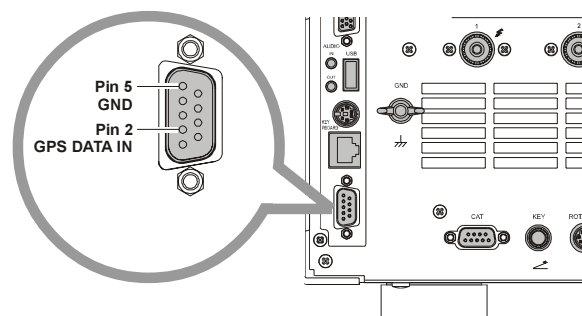

# INSTALLATION AND INTERCONNECTIONS

## VL-1000 LINEAR AMPLIFIER INTERCONNECTIONS

Be sure that both the FT DX 9000D and VL-1000 are turned off, then follow the installation recommendations contained in the illustration.

On the rear panel of the VL-1000, please set the "ATT" switch to the "ON" position. The 200-Watt power output from the FT DX 9000D is far in excess of what is required to drive the VL-1000 to its full rated output.

### 『Note』

- Please refer to the VL-1000 Operating Manual for details regarding amplifier operation.
- Please do not attempt to connect or disconnect coaxial cables when your hands are wet.

### Control Cable Modification

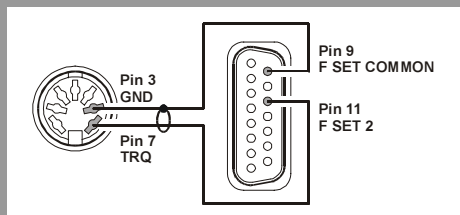

Please cut off the RCA connector on one end of the CONTROL Cable supplied with the VL-1000, and install a 7-pin DIN connector in its place, according to the illustration.

### About the CONTROL Cable

The VL-1000 may be operated with the FT DX 9000D whether or not the CONTROL Cable is connected; however, the CONTROL Cable allows you to tune up the amplifier automatically by just pressing the [F SET] or [TUNE] key on the VL-1000, so as to transmit a carrier for tuning purposes.

To link the FT DX 9000D and VL-1000 Power switches, set the VL-1000 REMOTE switch to the ON position.

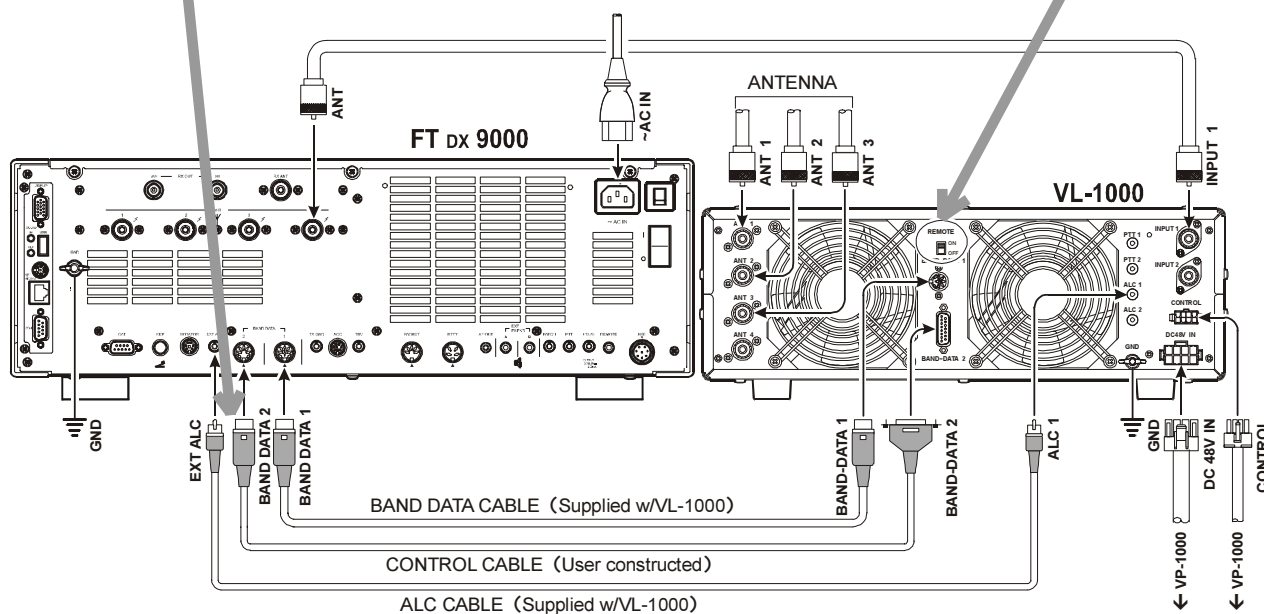

# INSTALLATION AND INTERCONNECTIONS

## INTERFACING TO OTHER LINEAR AMPLIFIERS

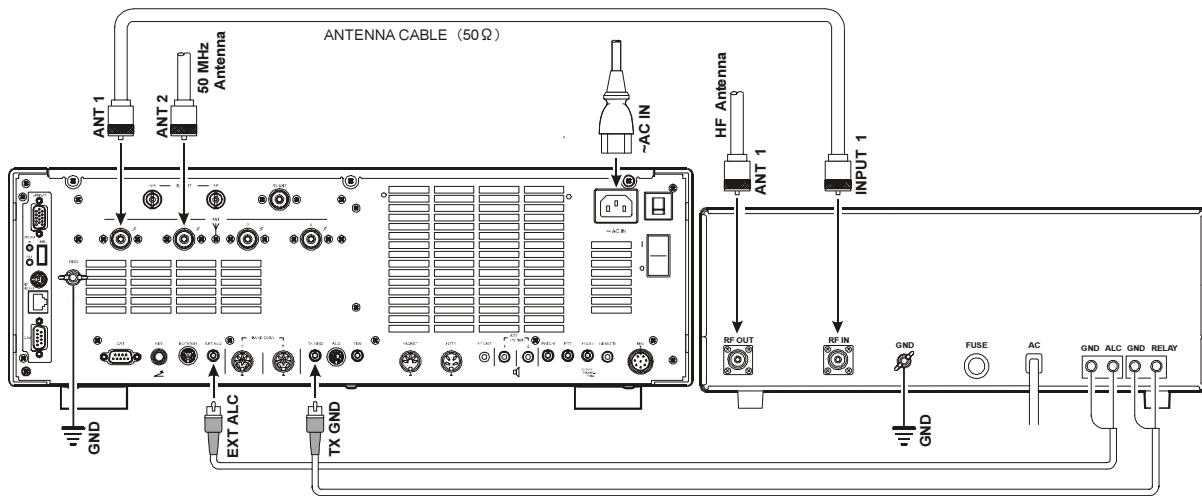



### 『Note』

- The TX/RX switching in the linear amplifier is controlled by switching components in the transceiver. The relay circuit of the FT DX 9000D used for this switching is capable of switching AC voltage of 100 Volts at up to 300 mA, or DC voltages or 60 V at 200 mA or 30 V at up to 1 Amp. In order to engage the switching relay, use Menu “TX GNRL 156 EXT AMP TX-GND” within the “TX GNRL” Menu Group; set this Menu selection to “ENABLE” to activate the amplifier switching relay.
- The specified range for ALC voltage to be used with the FT DX 9000D is 0 to -4 Volts DC.
- Amplifier systems utilizing different voltages will not work correctly with the FT DX 9000D, and their ALC lines must not be connected if this is the case.

Downloaded by  
RadioAmateur.EU

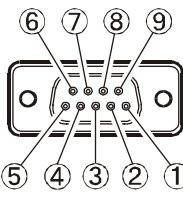
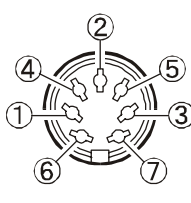
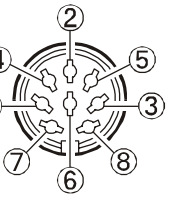
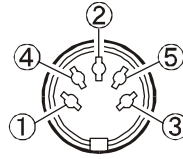
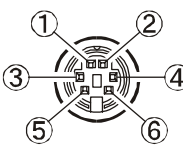
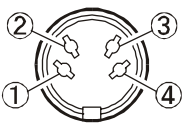
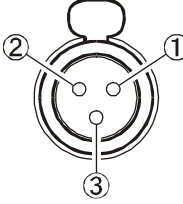
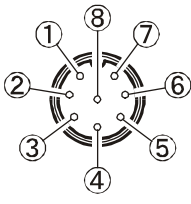
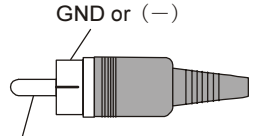
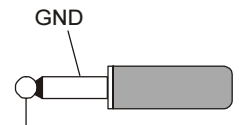
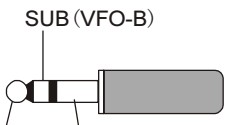
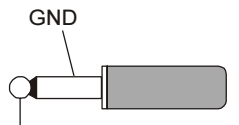
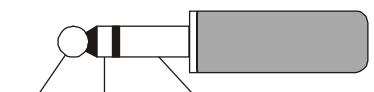
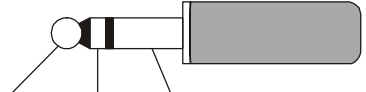
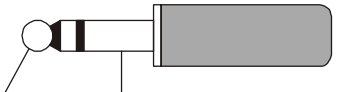

# PLUG/CONNECTOR PINOUT DIAGRAMS

CAT	BAND DATA1	BAND DATA2
 <p>① N/A ② SERIAL OUT ③ SERIAL IN ④ N/A ⑤ GND ⑥ N/A ⑦ N/A ⑧ N/A ⑨ NC</p> <p>(as viewed from rear panel)</p>	 <p>① EXT ALC ② TX GND ③ GND ④ NC ⑤ NC ⑥ TXINH ⑦ FSET</p> <p>(as viewed from rear panel)</p>	 <p>① +13V ② TX GND ③ GND ④ BAND DATA A ⑤ BAND DATA B ⑥ BAND DATA C ⑦ BAND DATA D ⑧ LINEAR</p> <p>(as viewed from rear panel)</p>
PACKET	ROTATOR	RTTY
 <p>① DATA IN ② GND ③ PTT ④ DATA OUT ⑤ BUSY</p> <p>(as viewed from rear panel)</p>	 <p>① RT1 ② RT2 ③ RT3 ④ RT4 ⑤ GND ⑥ NC</p> <p>(as viewed from rear panel)</p>	 <p>① RX OUT ② PTT ③ GND ④ SHIFT</p> <p>(as viewed from rear panel)</p>
MIC (XLR)	MIC	RCA PLUG
 <p>① MIC-GND ② MIC-Hot ③ MIC-Cold</p> <p>(as viewed from front panel)</p>	 <p>① UP ② +5V ③ DOWN ④ FAST ⑤ GND ⑥ PTT ⑦ MIC GND ⑧ MIC</p> <p>(as viewed from rear panel)</p>	 <p>GND or (-) SIGNAL or (+)</p>
REMOTE	AF OUT	EXT SPKR
 <p>GND SIGNAL</p>	 <p>SUB (VFO-B) MAIN (VFO-A) GND</p>	 <p>GND SIGNAL</p>
PHONE	KEY	
 <p>MAIN SUB GND</p>	<p><i>For Internal Keyer</i></p>  <p>DOT DASH COMMON</p>	<p><i>For Straight Key</i></p>  <p>KEY GND</p> <p> Do not use 2-conductor type plug</p>

# FRONT PANEL CONTROLS

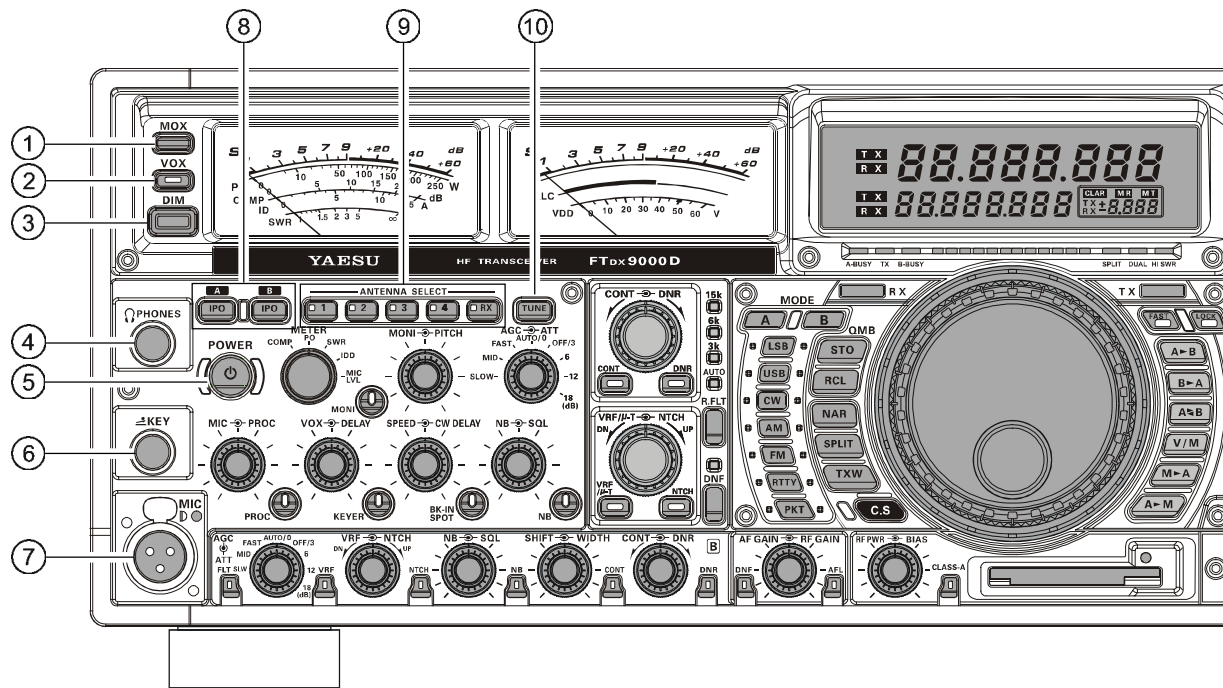

## ① MOX Switch

Pressing this button engages the PTT (Push to Talk) circuit, to activate the transmitter. It must be in the undepressed position for reception. This switch replicates the action of the Push to Talk (PTT) switch on the microphone. When engaging the **[MOX]** switch, or otherwise causing a transmission to be started, be certain you have either an antenna or 50-Ohm dummy load connected to the selected Antenna jack.

## ② VOX Switch

**VOX Operation:** This button enables automatic voice-actuated transmitter switching in the SSB, AM, and FM modes. While activated, the LED inside this button glows red. The controls affecting VOX operation are the front panel's **[VOX]** and **[DELAY]** knobs (see section (17) below. By proper adjustment of these controls, hands-free voice-actuated operation is possible.

## ③ DIM Switch

Press this button to lower the illumination intensity of the analog meters, the frequency display, and the TFT. Press it once more to restore full brightness.

### 『Advice』

Menu Items “DISPLAY 014 DIMMER-METER” and “DISPLAY 015 DIMMER-VFD” allow you to configure the dimming levels for the analog meters and the frequency display/TFT independently, so you can customize the brightness levels.

## ④ PHONES Jack

A 1/4-inch, 3-contact jack accepts either monaural or stereo headphones with 2- or 3-contact plugs. When a plug is inserted, the loudspeaker is disabled. With stereo headphones such as the optional YH-77STA, you can monitor both Main (VFO-A) and Sub (VFO-B) receiver channels at the same time during Dual Receive operation.

Note: When wearing headphones, we recommend that you turn the AF Gain levels down to their lowest settings before turning power on, to minimize the impact on your hearing caused by audio “pops” during switch-on.

## ⑤ POWER Switch

Press and hold in this switch for two seconds to turn the transceiver on, after first setting the rear panel Power switch to the “**I**” position. Press and hold in this switch for two seconds, similarly, to turn the transceiver off. If the rear panel's Power switch is set to the “**O**” position, the front panel **[POWER]** switch will not function.

### 『Advice』

This is the actual power On/Off switch for turning on the transceiver. When the rear panel's Power switch is set to the “**I**” position, power is supplied to the OCXO to stabilize the reference oscillator, and the remainder of the transceiver is set in a “stand-by” mode, awaiting the command for the transceiver to switch on via the front panel **[POWER]** switch. For further information on the rear panel Power switch, please see the discussion on page 36.

## ⑥ KEY Jack

This 1/4-inch, 3-contact jack accepts a CW key or keyer paddles (for the built-in electronic keyer), or output from an external electronic keyer. Pinout is shown on page 16. Key up voltage is 5 V, and key down current is 1 mA. This jack may be configured for keyer, “Bug,” “straight key,” or computer keying interface operation via Menu Selection “MODE-CW 041 F-KEYER TYPE (see page 135).” There is another jack with the same name on the rear panel, and it may be configured independently for Internal Keyer or pseudo-straight-key operation.

### 『Note』

You cannot use a 2-contact plug in this jack (to do so produces a constant “key down” condition).

## ⑦ Cannon (“XLR”) Microphone Connector

This Cannon-type (XLR) connector accepts input from the Microphone or other XLR-equipped microphone system. MIC connector pinout is shown on page 15. Proper microphone input impedance is 500 ~ 600 Ohms.

If you are using a condenser microphone requiring 48 Volts DC, you may enable this voltage to appear on the microphone line; see page 81. When the 48-volt supply line has been enabled, the LED adjacent to the MIC jack will glow red.

To disconnect the microphone plug, draw out the microphone plug while pressing and holding in the silver push-button.

## ⑧ IPO (Intercept Point Optimization) Switch

The **【IPO(A)】** Lamp-button may be used to set the optimum receiver front end characteristics of the main receiver circuit for a very strong-signal environment. Selecting IPO bypasses the front end RF amplifier and feeds the received signals directly to the first mixer of the main band (VFO-A) receiver circuit. While the IPO feature is activated, this button will remain illuminated.

The **【IPO(B)】** Lamp-button, similarly, allows direct feed of the received signals to the first mixer of the sub band (VFO-B) receiver circuit. While the IPO feature is activated on the sub receiver, this button will be lit.

### 『Advice』

The FT DX 9000D’s first mixer is an active type, using four SST310 Junction FETs. This mixer design provides gain to the receiver chain, so the noise figure of the receiver is fundamentally lower than with some other designs. Therefore, it frequently is not necessary to utilize the RF preamplifier, and the receiver Intercept Point will be substantially increased by engaging IPO, so as to feed the incoming signals directly to the first (active) mixer. We recommend that IPO be switched on whenever possible.

## ⑨ ANTENNA SELECT Switches

These momentary buttons select the antenna jack on the rear panel, with the selection indicated by the LED in each button. When an antenna has been selected for operation on the main band (VFO-A), the LED in the button glows red. When an antenna has been selected for operation on the sub band (VFO-B), the LED in the button glows amber.

## ⑩ TUNE Switch

This is the on/off switch for the FT DX 9000D’s Automatic Antenna Tuner.

Pressing this button momentarily places the antenna tuner in line between the transmitter final amplifier and the antenna jack (the LED will become illuminated). Reception is not affected.

Pressing and holding in this button for 1/2 second, while receiving in an amateur band, activates the transmitter for a few seconds while the automatic antenna tuner rematches the antenna system impedance for minimum SWR. The resulting setting is automatically stored in one of the antenna tuner’s 100 memories, for instant automatic recall later when the receiver is tuned near the same frequency.

Pressing this button momentarily, while the Tuner is engaged, will take the Automatic Antenna tuner out of the transmit line.

### 『Note』

When the Automatic Antenna tuner is tuning itself, a signal is being transmitted. Therefore, be absolutely certain that an antenna or dummy load is connected to the selected antenna jack before pressing and holding in the **【TUNE】** button to start antenna tuning.

# FRONT PANEL CONTROLS

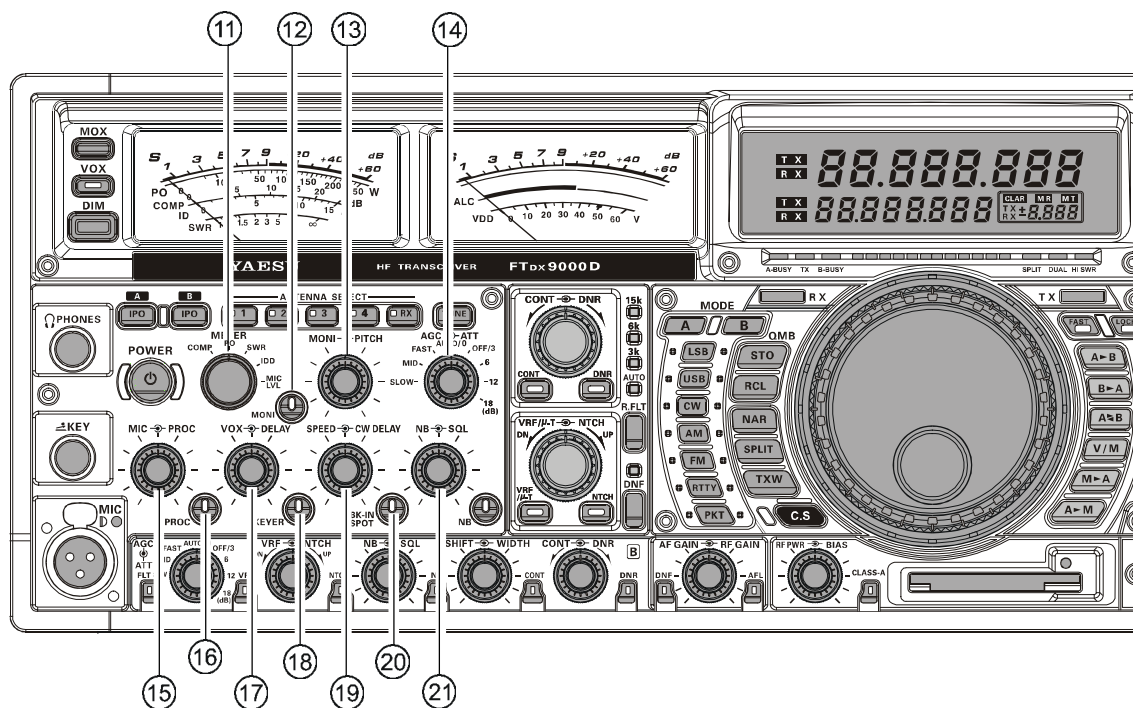

## 11 METER Switch

This control switch determines the function of the Main Meter during transmission.

**COMP:** Indicates the RF speech compressor level (SSB modes only).

**PO:** Indicates the power output level.

**SWR:** Indicates the Standing Wave Ratio (Forward: Reflected).

**IDD:** Indicates the final amplifier drain current.

**MIC LVL:** Indicates the relative microphone level.

## 12 MONI (Monitor) Switch

This button enables the transmit (RF) monitor in all modes (except CW, in which the monitor function is always on, to produce the sidetone). While activated, the LED in this button glows red. Adjustment of the Monitor level is accomplished using the **[MONI]** knob, located just to the right of the **[MONI]** switch.

### 『Advice』

When using headphones, the Monitor is highly useful for making adjustments to the Parametric Equalizer or other voice quality adjustments, because the voice quality heard in the headphones is such a “natural” reproduction of the transmitted audio quality.

## 13 MONI → PITCH Knobs

### MONI Knob

The inner **[MONI]** knob adjusts the audio level of the transmit RF monitor during transmission (relative to the AF GAIN control), when activated by the **[MONI]** button (above).

### PITCH Knob

The outer **[PITCH]** knob selects your preferred CW tone pitch (from 300 ~ 1000 Hz, in 50 Hz increments). The Tx sidetone, receiver IF passband, and display offset from the BFO (carrier) frequency are all affected simultaneously. The Pitch control setting also affects the operation of the CW Tuning Indicator, as the center frequency of the CW Tuning Indicator will follow the setting of this control.

## 14 AGC → ATT Knobs

### AGC Knobs

This switch selects the AGC characteristics for the Main (VFO-A) band receiver.

### ATT Knobs

This switch selects the degree of attenuation, if any, to be applied to the Main (VFO-A) receiver input.

### 『Advice』

The Attenuator may be used in conjunction with the IPO switch (#8) above) to provide two stages of signal reduction when an extremely strong signal is being received.

## ⑮ MIC → PROC Knobs

### MIC Knob

The inner **[MIC]** knob adjusts the microphone input level for (non-processed) SSB transmission.

#### 『Advice』

If you adjust the MIC Gain while speaking in a louder-than-normal voice level and watching the ALC level on the right-side meter, adjust the MIC Gain so that the ALC reaches over to the right edge of the ALC scale. Then, when you speak in a more normal voice level, you'll be certain not to be over-driving the mic amplifier stage.

### PROC Knob

The outer **[PROC]** knob sets the compression (input) level of the transmitter RF speech processor in the SSB and modes, when activated by the button with the same name (see next section).

## ⑯ PROC (Processor) Switch

This button enables the RF speech processor for SSB transmission. Processing level is set by the outer control with the same name (see previous section). While activated, the LED in this button glows red.

#### 『Advice』

The Speech Processor is a tool for increasing the average power output through a compression technique. However, if the PROC level control is advanced too far, the increase in compression becomes counter-productive, as intelligibility will suffer. We recommend that you monitor the sound of your signal using the Monitor (with headphones), and watch the Oscilloscope page on the TFT while transmitting (Monitor must be on), then advance the PROC level only as far as required to obtain a useful increase in average power output.

## ⑰ VOX → DELAY Knobs

### VOX Knob

The inner **[VOX]** knob sets the gain of the VOX circuit, to set the level of microphone audio needed to activate the transmitter during voice operation while the **[VOX]** button is engaged. The **[VOX]** switch (#② above) must be switched On to engage the VOX circuit.

### DELAY Knob

The outer **[DELAY]** knob sets the hang time of the VOX circuit, between the moment you stop speaking, and the automatic switch from transmit back to receive. Adjust this for smooth VOX operation, so the receiver is only activated when your transmission is ended and you wish to receive.

For CW operation, you can adjust the keying delay separately; see control #⑲ below.

## ⑱ KEYER Switch

This button toggles the internal CW keyer on and off. While activated, the LED in this button glows red. The Keyer sending speed, and the CW Hang Time are adjusted via the controls described in the next section.

## ⑲ SPEED → CW DELAY Knobs

The internal Electronic Keyer is activated by the **[KEYER]** switch, described in the previous section.

### SPEED Knob

The inner **[SPEED]** knob adjusts the keying speed of the internal CW keyer. Clockwise rotation increases the sending speed.

### CW DELAY Knob

This outer **[CW DELAY]** knob sets the hang time of the CW “VOX” circuit, between the moment you stop sending, and the automatic switch from transmit back to receive during “Semi-break-in” operation. Adjust this just long enough to prevent the receiver from being restored during word spaces at your preferred sending speed. Clockwise rotation increases the hang time.

#### 『Note』

The SSB VOX hang time is adjusted via the **[DELAY]** control described in section ⑰ above.

## ⑳ BK-IN/SPOT Switches

This button turns the full break-in (QSK) CW capability on and off. While QSK is activated, the LED in this button glows red.

The **[SPOT]** button turns on the CW receiver spotting tone; by matching the SPOT tone to that of the incoming CW signal (precisely the same pitch), you will be “zero beating” your transmitted signal on to the frequency of the other station.

## ㉑ NB/SQL Knobs

### NB Knob

The inner **[NB]** knob adjusts the noise blanking level when the (analog) IF noise blanker is activated by pressing the **[NB]** button. The Noise Blanker is activated via the **[NB]** switch, described in the next section.

### SQL Knob

The outer **[SQL]** knob sets the signal level threshold at which main (VFO-A) receiver audio is muted, in all modes. It is very useful during local rag-chews, to eliminate noise between incoming transmissions. This control is normally kept fully counter-clockwise (off), except when scanning and during FM operation.



# FRONT PANEL CONTROLS

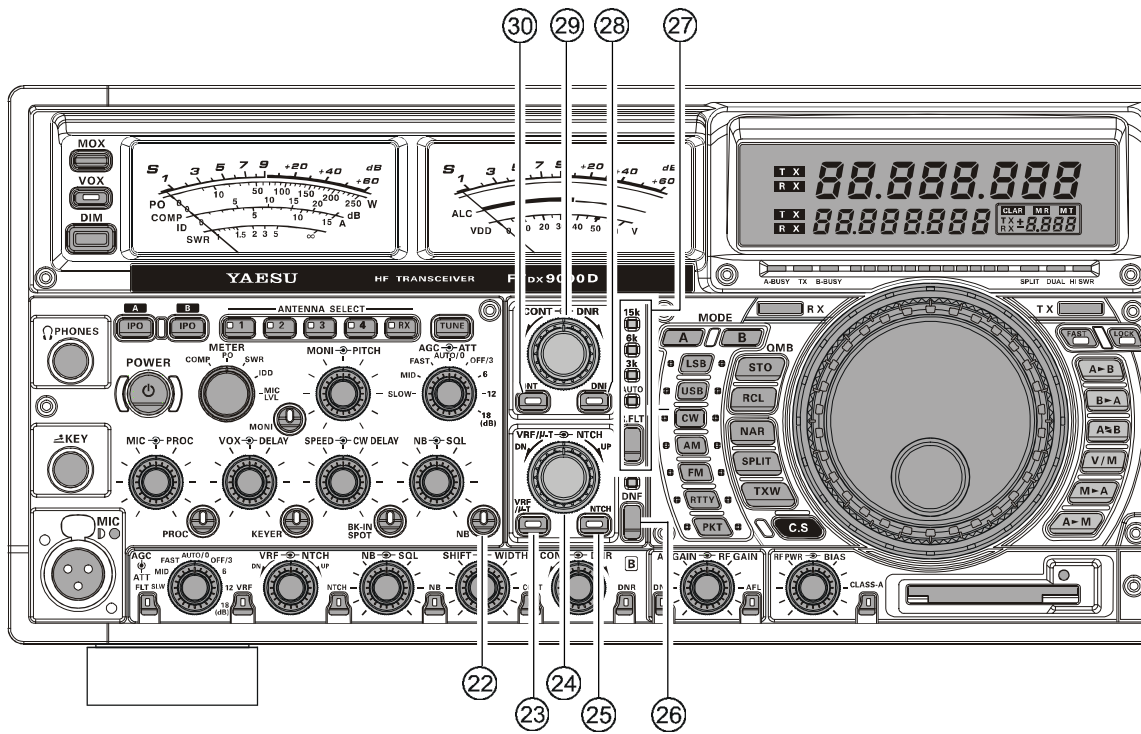

## 22 NB Switch

Pressing this button activates the (analog) IF Noise Blanker, which may help reduce many different types of man-made impulse noise (but not atmospheric). When the Noise Blanker is activated, the LED inside the button will glow red. Adjustment of the Noise Blanker level is accomplished via the **[NB]** knob, described in the previous section.

## 23 VRF/μ-T Switch

This button turns the main band (VFO-A) receiver's VRF filter or μ-TUNE filter on and off. While activated, the LED inside the button will glow red.

## 24 VRF/μ-T/NTCH Knobs

### VRF/μ-T Knob

The inner **[VRF/μ-T]** knob tunes the passband of the main band (VFO-A) receiver's RF filter (18 MHz and higher Amateur bands) or μ-TUNE filter (Narrowbandwidth High-Q RF Filter) (14 MHz and lower Amateur bands) for maximum receiver sensitivity (and out-of-band interference rejection). On the 18 MHz and higher Amateur bands, this knob provides adjustment of the VRF (Variable RF Filter) preselector circuit.

### 『Advice』

- It is possible to use the Menu to de-select the μ-Tune module, and utilize VRF instead, on bands where a μ-Tune module is installed. However, the superior selectivity of the μ-Tune circuit is preferred for most applications.
- The μ-Tune circuitry automatically tracks your operating frequency, and adjustment of its center frequency is normally not required. However, if a

very strong signal within several dozen kHz is causing you problems, you may use the **[VRF/μ-T]/**[NTCH]**** knob to skew the tuning to one side of the other of your current frequency, to roll off the strength of the interfering station.

- If you wish to reset the tuning of the **[VRF/μ-T]/**[NTCH]**** knob to its original (centered) setting, just press and hold in the **[VRF/μ-T]** switch (#23 above) for two seconds. The μ-Tune circuit will not revert to its normal (automatically tuned) position, centered on your current frequency.
- There is a slight increase in receiver path insertion loss when the μ-Tune circuit is engaged. On the frequencies where μ-Tune is used, this is seldom a problem. If the slight signal loss presents a problem, just turn the **[VRF/μ-T]** switch (#23 above) Off.
- Rotation of the **[VRF/μ-T]/**[NTCH]**** knob to adjust the μ-Tune circuit should be performed only to optimize the signal or reduce interference. The μ-Tune circuit tuning is surprisingly sharp. If you are adjusting VRF, however, the tuning is much more broad, and we believe that VRF adjustment will seldom be required.
- The relative position of the μ-Tune or VRF passband can be observed on the TFT display.

### NTCH Knob

The outer **[NTCH]** knob adjusts the center frequency of the main band (VFO-A) IF notch filter. The Notch Filter is engaged via the **[NTCH]** switch, described in the next section.

## ②5 NTCH Switch

This button turns the main band (VFO-A) IF notch filter on and off. When the IF notch filter is activated, the LED inside the button will glow red. The Notch Filter center frequency is adjusted via the **【NTCH】** knob, described in the previous section.

### 『Advice』

- The width of the notch may be set to either “Wide” or “Narrow” via Menu item “RX DSP 082 IF-NOTCH-WIDTH” in the RX DSP Menu Group. Setting this selection to “Narrow” will provide a very sharp notch, with minimal disturbance to the incoming signal wave-form.
- The tuning rate of the Notch Filter being rather slow, it frequently is useful to use the Audio Scope of the TFT (either the Audio Spectrum Scope or the Waterfall display) to adjust the center frequency of the IF Notch Filter. In the Waterfall display mode, the notched area will appear more white than the background screen, while on the Audio Spectrum Scope screen the notched area will appear as a “hole” in the noise.

## ②6 DNF Switch

This button turns the main band (VFO-A) Digital Notch Filter on and off. When the Digital Notch Filter is activated, the LED indicator will glow red. This is an automatic circuit, and there is no adjustment knob for the DNF.

## ②7 R.FLT Switch

This button selects the bandwidth for the main band (VFO-A) receiver's first IF Roofing Filter. Available selections are 3 kHz, 6 kHz, 15 kHz, or Auto, and the LED indicator will change according to the bandwidth selected.

### 『Advice』

Because the roofing filter is in the first IF, the protection it provides against interference is quite significant. When set to AUTO, the SSB bandwidth is 6 kHz, while CW is 3 kHz and FM/RTTY are 15 kHz. On a crowded SSB band, however, you may wish to select the 3 kHz filter, for the maximum possible interference rejection.

## ②8 DNR Switch

This button turns the Main band (VFO-A) Digital Noise Reduction circuit on and off. When the Digital Noise Reduction is activated, the LED inside the button will glow amber. Adjustment of the Noise Reduction level is provided by the **【DNR】** knob, described in the next section.

## ②9 CONT DNR Knob

### CONT Knob

The inner **【CONT】** knob selects the desired sub band (VFO-B) CONTOUR filter response. The CONTOUR filter is engaged via the **【CONT】** switch, described in the next section.

### DNR Knob

The outer **【DNR】** knob selects the optimum Main Band (VFO-A) Digital Noise Reduction response. The Noise Reduction circuit is engaged via the **【DNR】** switch, described in section ②8 above.

## ③0 CONT Button

This button turns the sub band (VFO-B) CONTOUR filter on and off. When the CONTOUR filter is activated, the LED inside the button will glow amber. Adjustment of the CONTOUR filter's center frequency is provided by the **【CONT】** knob, described in section ②9 above.

### 『Quick Note』

There are times, when you're trying to remove interference with a sharp DSP filter, that the remaining signal has a somewhat unnatural sound. This is caused by the cutting of some frequency components, leaving other components in excess. The CONTOUR filter allows you (especially) to roll off certain frequency components inside the remaining passband, but in a smooth manner that helps restore a natural sound and/or raise intelligibility.

### 『Advice』

- The action of the CONTOUR filter (either nulling or peaking of frequency components as you adjust the center frequency) may be adjusted via Menu item “RX DSP 079 MAIN-CONTOUR-WIDTH.” The adjustment range includes settings of -15 dB (nulling) to +10 dB (peaking).
- The Audio Spectrum Scope (including the Waterfall displays) on the Oscilloscope page of the TFT can be particularly useful when adjusting the **【CONT】** control (see section ②9 above), as you can observe the position of the null or peak in the audio passband.

# FRONT PANEL CONTROLS

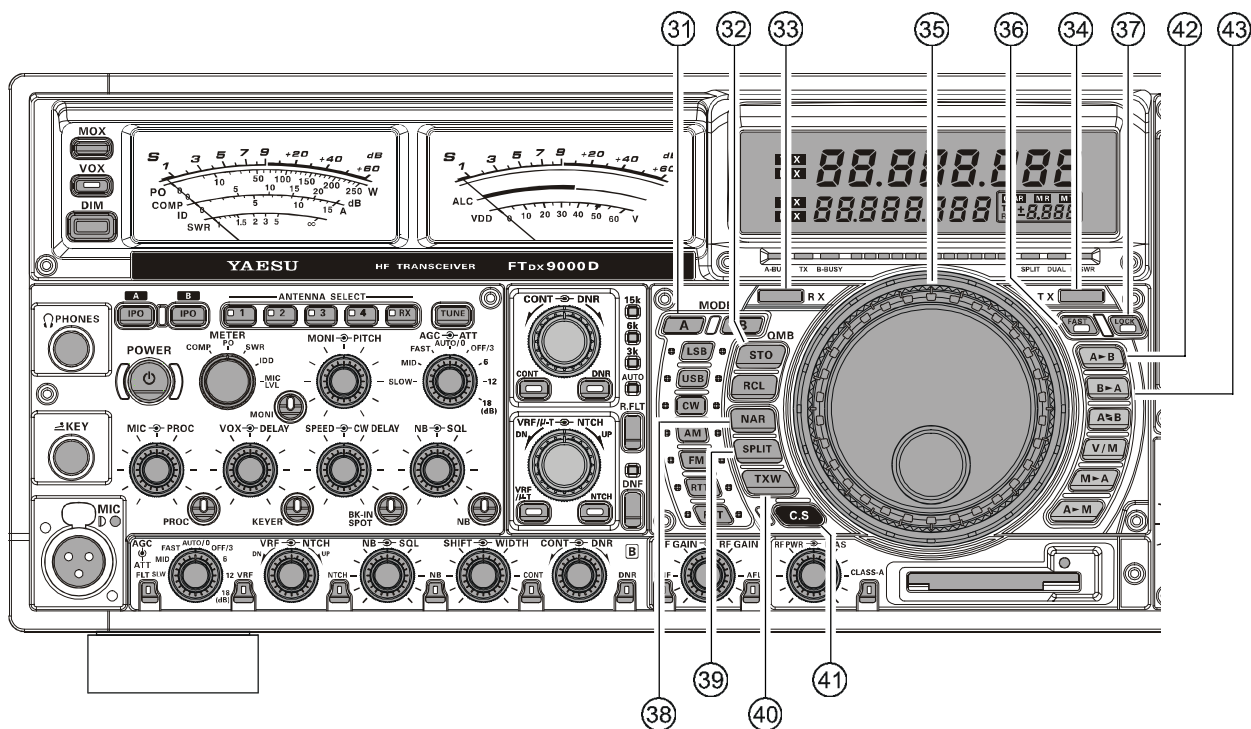

## 31 MODE Switches

### A, B Button

Pressing the [A] or [B] switch will illuminate the respective indicator imbedded within the switch, allowing adjustment of the operating mode on the Main (VFO-A) or Sub (VFO-B) band. Pressing the [A] switch causes the indicator to glow Red, signifying Main (VFO-A) band is being adjusted. Similarly, pressing the [B] switch will cause its indicator to glow Orange, signifying Sub (VFO-B) Band adjustment.

### 『Advice』

When changing bands, be sure to press the [A] or [B] switch first, then press the appropriate Band selector switch, so as to change operating frequencies on the proper (Main or Sub) band.

### LSB, USB, CW, AM, FM, RTTY, PKT Button

Pressing the [LSB], [USB], [CW], [AM], [FM], [RTTY], or [PKT] button will select the operating mode. Pressing the [CW], [AM], [RTTY], or [PKT] button multiple times will switch between the alternate operating features that can be used on these modes (covered later). Also, when you press and hold in the [PKT] button for one second, the user-programmed custom function setting mode will be activated.

## 32 QMB (Quick Memory Bank) Switch

### STO (Store) Button

Pressing this button copies operating information (frequency, mode, bandwidth, and also repeater direction/shift frequency and CTCSS functions on the FM mode) into consecutive QMB Memories.

### RCL (Recall) Button

Pressing this button recalls one of up to five Quick Memory Bank memories for operation.

## 33 RX Indicator/Switch

This switch, when pressed, engages the Main (VFO-A) band receiver; the indicator will glow Green when the Main receiver is active.

When the Main (VFO-A) receiver is active, pressing this button momentarily will mute the receiver, and the indicator will blink. Pressing the button once more will restore receiver operation, and the indicator will glow Green steadily.

## 34 TX Indicator/Switch

When this button is pushed, the indicator will glow Red, and the transmitter will be engaged on the same frequency and mode as was set up for the Main (VFO-A) band (subject to any Clarifier offset, of course).

### 『Advice』

If this indicator is not illuminated, it means that the Sub (VFO-B) TX indicator has been selected (it will be glowing Red). In this case, transmission will be effected on the frequency and mode programmed for the Sub (VFO-B) band.



## 35 Main Dial Knob

This large knob adjusts the operating frequency of the Main (VFO-A) Band or a recalled memory. Clockwise rotation of this knob increases the frequency. Default tuning increments are 10 Hz (100 Hz in AM and FM modes); when the **[FAST]** switch is pressed, the tuning steps increase. The available steps are:

Operating Mode	1 Step*	1 Dial Rotation
LSB/USB/CW/RTTY/PKT(LSB)	10 Hz (100 Hz)	10 kHz (100 kHz)
AM/FM/PKT(FM)	100 Hz (1 kHz)	100 kHz (1 MHz)

\* Numbers in parentheses indicate steps when the **[FAST]** switch is On.

### 『Advice』

The tuning steps for the **[Main]** Dial (described in this section) are set, at the factory, to 10 Hz per step. Via Menu item “TUNING 129 MAIN DIAL STEP,” however, you may change this setting from 10 Hz to 1 Hz instead. When 1 Hz basic steps are selected, the action of the **[FAST]** button will be changed to 1/10 of the values listed above.

## 36 FAST Switch

Pressing this button will increase or decrease the tuning rate of the **[Main]** Tuning Knob by a factor of ten, as mentioned in the previous section.

When this function is activated, the LED inside the button will glow red.

## 37 LOCK Switch

This button toggles locking of the main tuning knob, to prevent accidental frequency changes. When the button is active, the **[Main]** Tuning Knob can still be turned, but the frequency will not change, and the LED inside the button will glow green.

## 38 NAR (Narrow) Switch

In the SSB/CW mode, this button is used to set the bandwidth of the DSP IF filters to a user-programmed bandwidth (default values are SSB: 1.8 kHz, CW/RTTY/PSK: 300 Hz, AM: 6 kHz). When **[NAR]** has been engaged, the **[WIDTH]** knob will be disabled. In the AM mode, this button is used to toggle the receiver’s bandwidth between wide (9 kHz) and narrow (6 kHz).

In the FM mode on the 28 MHz and 50 MHz bands, this button is used to toggle the FM deviation/bandwidth between wide ( $\pm 5.0$  kHz Dev./25.0 kHz BW) and narrow ( $\pm 2.5$  kHz Dev./12.5 kHz BW).

Pressing the **[A]** or **[B]** button (located above the MODE selection buttons) will select either the main band (VFO-A) or sub band (VFO-B) for individual bandwidth setting.

### 『Advice』

When **[NAR]** has been engaged, the **[WIDTH]** knob will be disabled, although IF Shift still works normally.

## 39 SPLIT Switch

Pressing this button to activates split frequency operation between the main band (VFO-A), used for transmission and sub band (VFO-B), used for reception. The same name LED located at the right of the main tuning knob glows orange while this function is active.

If you press and hold in the **[SPLIT]** switch for two seconds, the “Quick Split” feature will be engaged, whereby the Sub (VFO-B) band VFO will automatically be set to a frequency 5 kHz higher than the Main (VFO-A) band frequency, and the transceiver will be placed in the Split mode.

## 40 TXW “TX Watch” Switch

Pressing this key lets you monitor the transmit frequency when split frequency operation is engaged. When receiving on the transmit frequency, the LED indicator will glow green. Press this key again to return to normal operation.

## 41 C.S Switch

Press this button momentarily to recall a favorite Menu Selection directly.

To program a Menu selection as the short-cut, press the **[MNU]** key to enter the Menu, then select the item you want to set as the short-cut. Now press and hold in the **[C/S]** key for two seconds; this will lock in the selected Menu item as the short-cut.

## 42 A► B Switch

Press this button momentarily to transfer data from the main band (VFO-A) frequency (or a recalled memory channel) to the sub band (VFO-B), overwriting any previous contents in the sub band (VFO-B). Use this key to set both main band (VFO-A) and sub band (VFO-B) receivers to the same frequency and mode.

## 43 B► A Switch

Press this button momentarily to transfer data from the sub band (VFO-B) frequency to the main band (VFO-A), overwriting any previous contents in the main band (VFO-A). Use this key to set both main band (VFO-A) and sub band (VFO-B) receivers to the same frequency and mode.

# FRONT PANEL CONTROLS

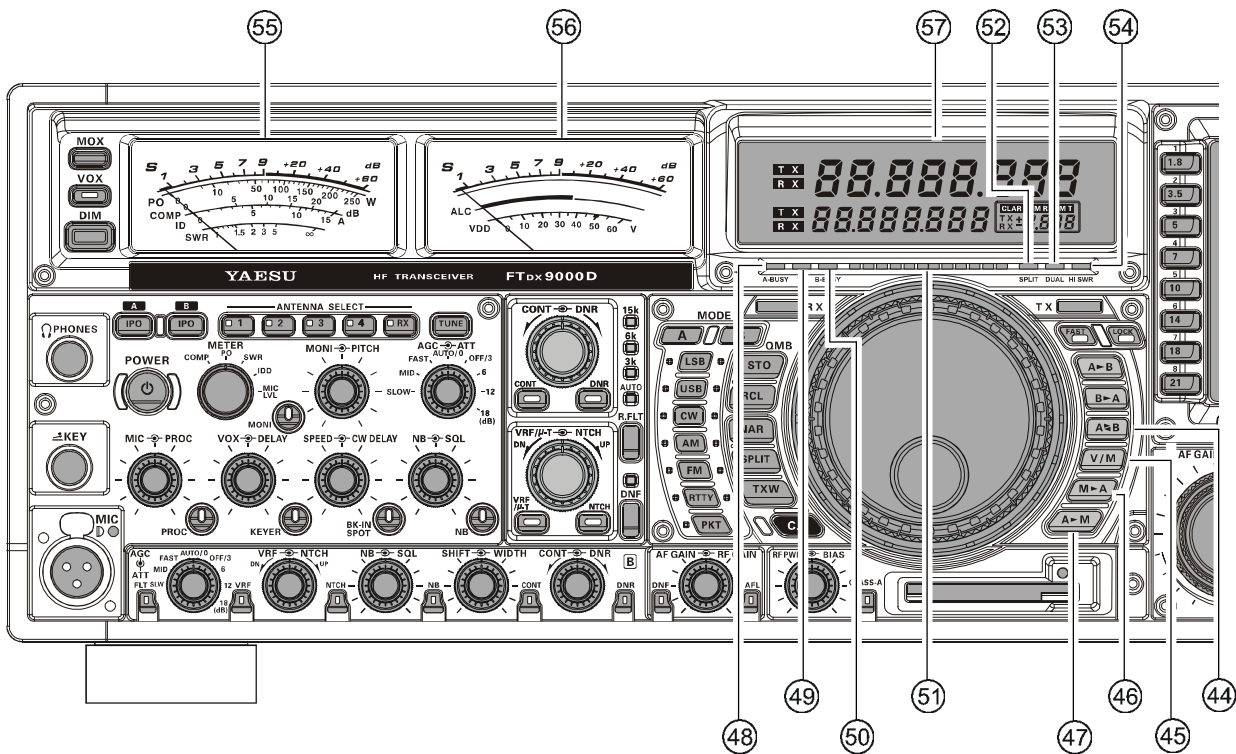

## 44 A>B Switch

Pressing this button momentarily exchanges the contents of the main band (VFO-A) (or a recalled memory channel) and the sub band (VFO-B).

## 45 V/M Switch

This button toggles main band (VFO-A) receiver operation between the memory system and the VFO. Either “VFO,” “MEM,” or “M TUNE” will be displayed to the left of the main frequency display field to indicate the current selection. If you have tuned off of a Memory channel frequency (M TUNE), pressing this button returns the display to the original memory contents (MEM), and pressing it once more returns operation to the Main VFO.

## 46 M>A Switch

Pressing this button momentarily displays the contents of the currently-selected memory channel for three seconds.

Holding this button in for 2 seconds copies the data from the currently-selected memory to the Main VFO (VFO-A), as two beeps sound. Previous data in the Main VFO will be overwritten.

## 47 A>M Switch

Pressing and holding in this key for 1/2 second (until the double beep) copies the current operating data from the main band (VFO-A) into the currently selected memory channel, overwriting any previous data stored there.

Also, pressing and holding in this button after recalling a memory, without first retuning, causes the memory channel to be “masked,” and repeating the process restores the masked memory.

## 48 A-BUSY Indicator

This LED glows green whenever the Main band (VFO-A) receiver squelch is open. If this indicator is not illuminated, and reception seems to have been “lost” on the Main receiver for no apparent reason, check the position of the **[SQL]** control (#21), described previously) and rotate it fully counter-clockwise to restore reception.

## 49 TX Indicator

This indicator glows Red during transmission. If you attempt to transmit while operating outside of an Amateur band, this indicator will blink Red, indicating an “out of band” condition.

## 50 B-BUSY Indicator

This LED glows green whenever the Sub band (VFO-B) receiver squelch is open. If this indicator is not illuminated, and reception seems to have been “lost” on the Sub receiver for no apparent reason, check the position of the SUB (VFO-B) **[SQL]** control (#63, described later) and rotate it fully counter-clockwise to restore reception.

## 51 Tuning Offset Indicator

This is a tuning scale that, as configured from the factory, provides a visual CW tuning indication of the incoming signal’s offset from your transceiver’s CW carrier frequency, as programmed by the position of the **[PITCH]** control (#13, described previously).

## 52 SPLIT Indicator

This indicator glows Red when the “Split” mode is engaged (with the Main and Sub bands operating on different frequencies).

## ⑤③ DUAL Indicator

This indicator glows Green when Dual Receive is engaged.

## ⑤④ HI SWR Indicator

This indicator glows Red if the directional coupler and microprocessor detect an abnormally high SWR condition (over 3.0:1) that cannot be resolved by the Automatic Antenna Tuner.

### 『Note』

If this indicator lights up, check to be sure that you have the correct antenna selected on the current operating band. If so, you will need to check the condition of the antenna, its coaxial cable, and/or the connectors on the cable so as to locate and correct the fault.

## ⑤⑤ S-Meter (Main Receiver)

There are five functions on the main multi-meter. The bottom five selections in the list below are transmit functions, determined by the position of the **【METER】** switch (#①①), described previously):

**S:** Indicates the received signal strength on the main band (VFO-A), from S-0 to S9 +60 dB.

**PO:** Indicates the RF Power Output, from 0 to 250 Watts on transmit.

**COMP:** Indicates the compression level of the speech processor, from 0 to 20 dB.

**IC:** Indicates the final amplifier drain current (ID), from 0 to 15 A.

**SWR:** Indicates the antenna system observed standing wave ratio (SWR), from 1.0 to 5.0.

**MIC LVL:** Indicates the relative level of modulation from the microphone amplifier stage (affected by the setting of the **【MIC】** knob).

## ⑤⑥ S-Meter (Sub Receiver)

On receive, this meter displays signal strength of incoming signals as received on the Sub (VFO-B) band receiver.

On transmit, this meter serves as the ALC meter. The function of this meter, on transmit, can be changed to indication or PA Voltage (VDD) via Menu item “DISPLAY 019 RIGHT TX METER.”

**ALC:** Display of relative ALC voltage. On SSB, the ALC level is chiefly controlled via the MIC Gain control, #①⑤ (described previously).

**VDD:** Final amplifier FET Drain Voltage (nominal value: 50 V).

## ⑤⑦ Frequency Display (See Page 37)

The upper large display field indicates the current operating frequency on the main band (VFO-A), and its TX/RX status.

The lower small display field indicates the current operating frequency on the sub band (VFO-B), and its TX/RX status.

# FRONT PANEL CONTROLS

## 『Advice』

Sections ⑤⑧ (R.FLT) through ⑦① (AF GAIN → RF GAIN) below pertain to operations associated with the Sub (VFO-B) band. Because their function is basically identical to that explained with respect to the Main (VFO-A) band, please see the Main (VFO-A) band discussions for detailed explanations of these controls, switches, and indicators.

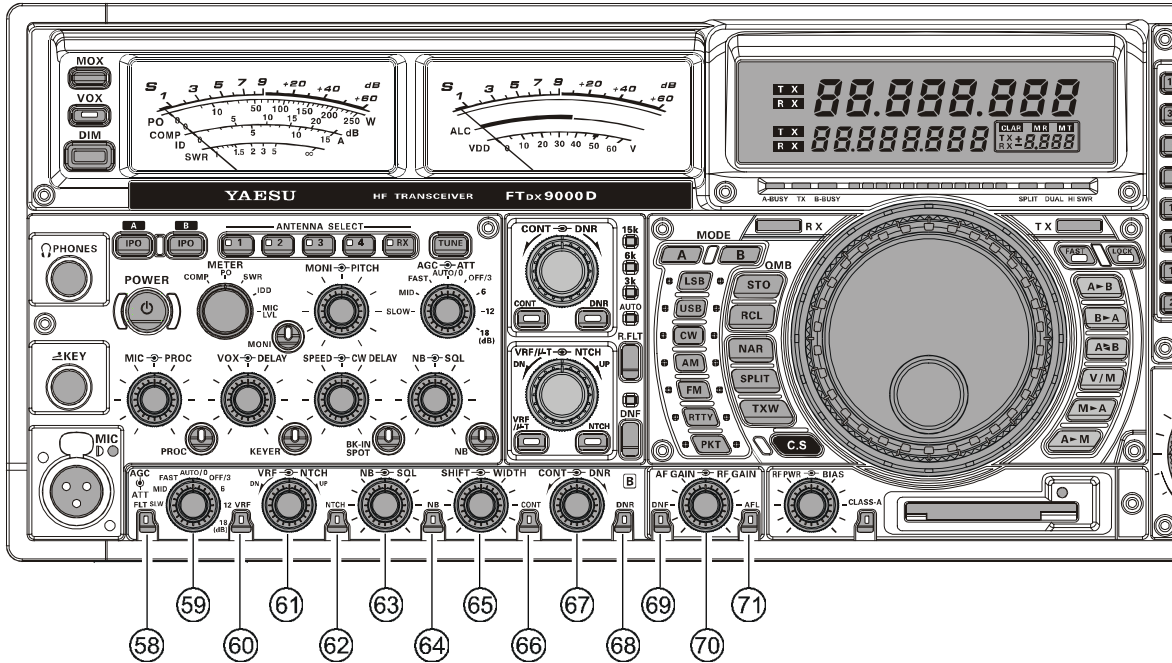

### ⑤⑧ R.FLT Switch

(Refer to Main (VFO-A): ②⑦)

This switch allows selection of the Sub (VFO-B) band Roofing filter.

### ⑤⑨ AGC → ATT Switch

(Reference: Main (VFO-A): ①④)

#### AGC Switch

This switch selects the AGC characteristics for the Sub (VFO-B) band receiver.

#### ATT Switch

This switch selects the degree of attenuation, if any, to be applied to the Sub (VFO-B) receiver input.

### ⑥① VRF Switch

(Refer to Main (VFO-A): ②③)

When the Sub (VFO-B) band VRF is engaged by this switch, the 【VRF】 switch will glow orange.

#### 『Note』

The  $\mu$ -Tuning system is not available for use on the Sub (VFO-B) band.

### ⑥① VRF → NTCH Knobs

#### VRF Knob

This adjusts the center frequency of the Sub (VFO-B) band VRF filter, when engaged by the 【VRF】 switch (described in section ⑥① above).

#### NTCH Knob

This adjusts the center frequency of the Sub (VFO-B) band IF Notch filter, when engaged by the 【NTCH】 switch (described in the next section).

### ⑥② NTCH Switch

This switch turns the Sub (VFO-B) manual IF Notch filter On and Off. Adjustment of the center frequency of the Notch filter is provided by the 【NTCH】 knob, described in the previous section.

## 63 NB SQL Knobs

(Refer to Main (VFO-A): 21)

### NB Knob

This adjusts the Sub (VFO-B) band receiver's IF Noise Blanker level, when the Noise Blanker is engaged via the [NB] switch, described below.

### SQL Knob

This knob provides adjustment of the Sub (VFO-B) band receiver's noise Squelch system.

## 64 NB Switch (except on FM mode)

(Refer to Main (VFO-A): 22)

This switch engages the Sub (VFO-B) band IF Noise Blanker. Adjustment of the Noise Blanker level is provided by the [NB] knob, described in the previous section.

## 65 SHIFT WIDTH Knobs (except on FM mode)

(Refer to Main (VFO-A): 78)

### SHIFT Knob

This knob adjusts the center frequency of the Sub (VFO-B) band receiver's DSP filter, with an adjustment range of  $\pm 1$  kHz.

### WIDTH Knob

This knob varies the width of the IF DSP filter for the Sub (VFO-B) band receiver.

## 66 CONT Switch

(Refer to Main (VFO-A): 30)

This is the On/Off switch for the Sub (VFO-B) band receiver's CONTOUR filter. When engaged, the [CONT] LED will glow Orange. Adjustment of the Sub (VFO-B) band CONTOUR filter's frequency is provided by the [CONT] knob (described in the next section).

## 67 CONT DNR

(Refer to Main VFO-A): 29)

### CONT (Contour)

This knob provides adjustment of the Sub (VFO-B) band receiver's CONTOUR filter frequency.

### 『Advice』

Use the Menu items "RX DSP 080 SUB-CONTOUR-LEVEL" and "RX DSP 081 SUB-CONTOUR-WIDTH" to configure the Sub (VFO-B) band receiver's CONTOUR filter.

### DNR Knob

This knob is used to select one of the 16 available noise reduction parameters for the Sub (VFO-B) band receivers's Digital Noise Reduction system.

## 68 DNR Switch

(Refer to Main (VFO-A): 28)

This button turns the sub band (VFO-B) Digital Noise Reduction circuit on and off. When the Digital Noise Reduction is activated, the LED inside the button will glow amber. Adjustment of the Noise Reduction level is provided by the [DNR] knob, described in the next section.

## 69 DNF Switch (Refer to Main (VFO-A): 26)

This switch is the On/Off switch for the Sub (VFO-B) band receiver's Digital Notch Filter. When turned On, the associated LED glows Orange.

## 70 AF GAIN RF GAIN

(Refer to Main (VFO-A): 75)

### AF GAIN Knob

This is the Sub (VFO-B) band receiver's Volume (AF GAIN) control.

### RF GAIN Knob

This is the Sub (VFO-B) band receiver's RF GAIN control, which adjusts the gain of the receiver's RF and IF amplifier stages. This control is normally left in the fully clockwise position.

## 71 AFL Switch

Pressing this button activates the Audio (AF) Limiter circuit of the Sub (VFO-B) band receiver. This will protect the audio amplifier from distortion, and protect your ears from high audio levels, caused by sudden peaks in audio input when the AGC is set to "OFF." When the Audio Limiter circuit is activated, the LED inside the button will glow orange.



# FRONT PANEL CONTROLS

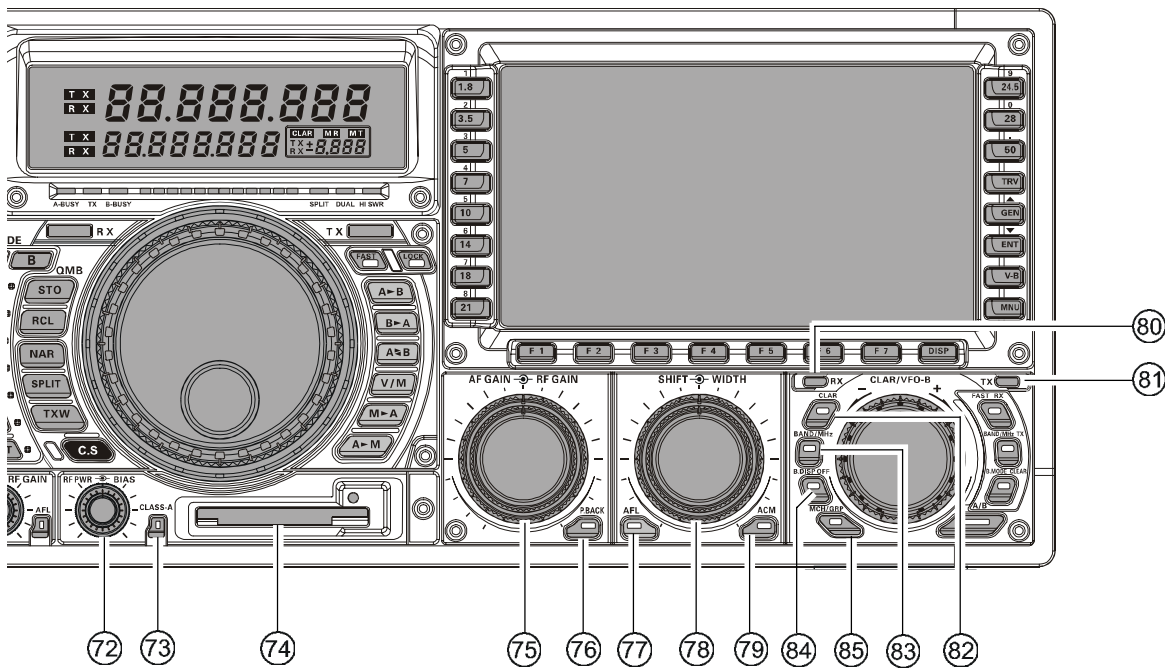

## 72 RF PWR $\rightarrow$ BIAS Knobs

### RF PWR Knob

This is the main RF Power output control for the transceiver, active in all operating modes. Clockwise rotation increases the power output. Adjust this control for the desired power output from the FT DX 9000D, or for the desired system output when using a linear amplifier or transverter.

### BIAS Knob

During SSB operation, pressing the **[CLASS-A]** button will lower the power output to a maximum of 75 Watts, and the **[BIAS]** control will then provide adjustment of the final amplifier Bias level between classes AB and A. Full Class-A operation provides an ultra-clean SSB wave-form. Because Class A is a high-bias, low-efficiency mode, you should monitor the heat sink temperature (using the “SWR” page on the TFT periodically to ensure that the operating temperature is within the safe range, and you may adjust the Bias level more toward the “AB” side if the heat sink gets too warm. The power output will not change if you adjust the setting of the **[BIAS]** control.

## 73 CLASS-A Switch

Pressing this switch engages the Class-A capability for the transmitter. The power output will be reduced to a maximum of 75 Watts, and the Bias level may be adjusted using the BIAS control, described in the previous section. When Class-A operation is engaged, the Red LED inside this switch will light up. Press this switch once more to return to Class AB operation at a maximum power output of 200 Watts; the Red LED will shut off to confirm Class AB operation.

## 74 CF Card Slot

This slot accepts the supplied Compact Flash (CF) Card, which allows storage, transfer, and recall of transceiver configuration data and operator preferences, along with Log Book data, etc. When the CF Card is successfully inserted, the Red LED by the slot will light up.

To remove the card out from slot, press the small push-button at the right hand side of the slot.

### 『Advice』

If you get the [PLEASE CHECK A DISK] error message to the right of the MEM CARD indication on the TFT, check the position of the CF Card in the slot for proper alignment.

## 75 AF GAIN $\rightarrow$ RF GAIN Knobs

### AF GAIN Knob

Clockwise rotation of this control increases the Volume level. Typically, you will operate with this control set past the 9 o'clock to 10 o'clock position.

### RF GAIN Knob

This is the control that adjusts the gain of the Main (VFO-A) band receiver's RF and IF stages. Clockwise rotation increases the gain level, and this control typically is left in the fully clockwise position, which provides maximum receiver gain.

Using the Menu, it is possible to change the **[RF GAIN]** control (for the Main (VFO-A) band) to serve as the Sub (VFO-B) **[AF GAIN]** control. In this case, the Menu Item “GENERAL 038 AF/RF DIAL SWAP” will move the Main (VFO-A) **[RF GAIN]** control function to the knob normally utilized for the Sub (VFO-B) receiver's **[AF GAIN]** control. In this way, both the Main and Sub receiver **[AF GAIN]** controls will be on the same shaft, as will the two receivers' **[RF GAIN]** controls.

## 76 P.BACK Switch

Press and hold in this button for 2 seconds to activate the recording feature of the internal Digital Voice Recorder. The Voice Recorder allows you to record the main band (VFO-A) receiver audio for the most-recent 30 seconds. While you're recording the receiver audio, the LED in this button glows red.

Press and hold in this button for 2 seconds once more to stop the recording, then press this button momentarily again to play back the receiver audio for the most-recent 30 seconds of reception before you stopped the recording.

While playing back the receiver audio, the LED inside button will glow amber.

Press and hold in this button for 2 seconds again to resume recording.

## 77 AFL Switch

Pressing this button activates the Audio (AF) Limiter circuit of the Main (VFO-A) band receiver. This will protect the audio amplifier from distortion, and protect your ears from high audio levels, caused by sudden peaks in audio input when the AGC is set to "OFF." When the Audio Limiter circuit is activated, the LED inside the button will glow orange.

## 78 SHIFT WIDTH Knobs (except on FM mode)

### SHIFT Knob

This knob provides adjustment of the IF DSP passband, using 20 Hz steps for precise adjustment and easy reduction of interference on either side of your operating frequency. The total adjustment range is  $\pm 1$  kHz.

The normal operating setting for this knob is straight up, in the 12 o'clock position.

### WIDTH Knob

The outer [WIDTH] knob, when turned to the 12 o'clock position, sets the overall IF bandwidth of the main band (VFO-A) receiver to its maximum bandwidth. Turning the [WIDTH] knob either direction, reduces the overall IF bandwidth of the main band (VFO-A) receiver.

When the NAR (Narrow) filter selection is engaged, this control is disabled. The [SHIFT] control, however, is still fully functional.

Use this control to narrow the IF DSP passband, as necessary, to reduce interference. The [SHIFT] control may be used to re-center the passband response on the incoming signal, and you may find that the CONTOUR and IF NOTCH filters may also help improve intelligibility and/or reduce interference. See also the discussions of control #29 (CONT  DNR) and #24 (VRF/ $\mu$ -T/NTCH), described previously.

### 『Advice』

When the #38 [NAR] switch has been pushed, the [WIDTH] control no longer functions. The IF SHIFT system is still fully operational, however.

## 79 ACM (Adjacent Channel monitor) Switch (CW Mode)

When using a narrow bandwidth, such as 300 Hz, on the Main (VFO-A) band receiver in the CW mode, pressing the ACM switch will take over the Sub (VFO-B) band receiver, and utilize it for monitoring the signal strength of any signals being received inside a 2.4 kHz window centered on your current operating frequency. You will not hear any of the interfering signals, but their signal strength will appear on the Sub (VFO-B) band S-meter.

## 80 RX Indicator/Switch

This is the switch that turns the Sub (VFO-B) receiver On and Off. When this button is pressed to make the Sub (VFO-B) receiver active, the Green LED imbedded within the switch will light up. Pressing the switch again will disable this receiver, and the imbedded Green LED will turn off.

## 81 TX Indicator/Switch

This is the switch that turns the Sub (VFO-B) transmitter On and Off. When this button is pressed to transfer transmitter control to the Sub (VFO-B) frequency and mode, the Red LED imbedded within the switch will light up. Pressing this switch once more will transfer frequency/mode control back to the Main (VFO-A) side, and the Red LED imbedded within this switch will turn off.

## 82 CLAR (Clarifier) Switch

When this switch is pushed, the [CLAR/VFO-B] knob (#86, described later) will be enabled for the purpose of utilizing the [CLAR/VFO-B] as an "Offset tuning" control to allow tuning away from the Main (VFO-A) frequency.

## 83 BAND/MHz Switch

### BAND Switch

Pressing this button momentarily allows you to select the main (VFO-A) operating band (Amateur bands) using the [CLAR/VFO-B] knob.

### MHz Switch

Pressing and holding in this button for 2 seconds allows you to tune the main band (VFO-A) frequency down or up in 1 MHz increments, using the [CLAR/VFO-B] knob.

## 84 B-DISP OFF Switch

Pressing this button causes the sub band (VFO-B) frequency to be blanked out, for local rag-chews or other occasions when the additional display information is not needed. When this function is activated, the LED inside the button will glow green.

## 85 MCH/GRP Switch

### MCH Switch

Pressing this button momentarily allows you to select the memory channel using the [CLAR/VFO-B] knob.

### GRP Switch

Pressing and holding in this button for 2 seconds allows you to select the memory group using the [CLAR/VFO-B] knob.

# FRONT PANEL CONTROLS

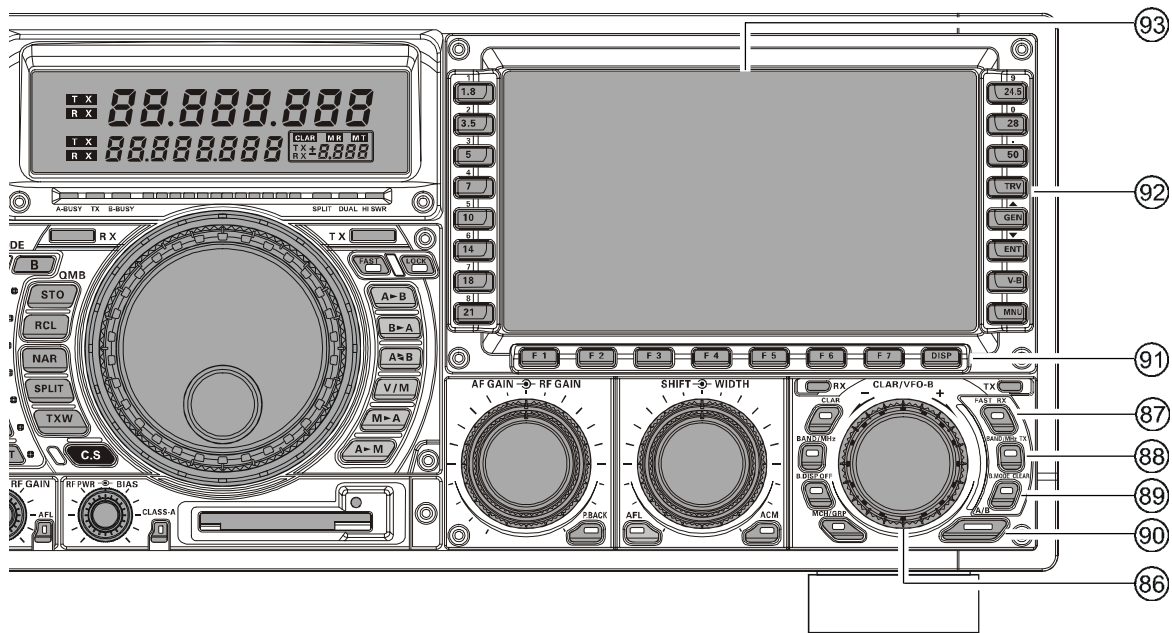

## 86 CLAR/VFO-B Knob

Depending on the status of the [A/B] switch (#90), described later) the CLAR/VFO-B is used for functions associated with the Main (VFO-A) or Sub (VFO-B) frequency control registers.

### Advice

#### Functions Associated with Main (VFO-A) Control

In the case of Main (VFO-A) control, this knob is used for Clarifier tuning, as well as Up/Down selection of the Amateur band, Memory Channels, 1 MHz tuning steps, or Memory Groups. For Main (VFO-A) control, be sure that the Orange lamp beside this control is not illuminated. If the Orange lamp is turned on, press the [A/B] switch (#90) to turn it off.

#### Clarifier Operation

When the [CLAR] switch (#82) above) is pushed, this knob may be used to program an offset of up to  $\pm 9.99$  kHz from the Main (VFO-A) frequency. This offset is only applied, however, to the receive or transmit frequency if the [FAST/RX] key (#87) and/or [BAND/MHz / TX] key (#88), respectively, have been pushed.

To apply the programmed frequency offset to the Receive frequency, press the [FAST/RX] key (#87) momentarily. To return to the Main-VFO-A frequency, without the offset, press the [FAST/RX] key once more.

To apply the programmed frequency offset to the Transmit frequency, press the [BAND/MHz / TX] key (#88) momentarily. To return the transmitter to the Main-VFO-A frequency, without the offset, press the [BAND/MHz / TX] key once more.

To reset the Clarifier frequency to "0" offset, press the [B-MODE/CLEAR] switch (#89).

#### Functions Associated with Sub (VFO-B) Operation

When the [A/B] switch (#90) is pressed, the Orange lamp to the right of the [CLAR/VFO-B] knob will light up, and this knob will now be exercising control functions associated with the Sub (VFO-B) frequency control register. If the Orange lamp is not illuminated, please press the [A/B] switch (#90). Rotation of the knob will now control the Sub (VFO-B) frequency.

#### Sub (VFO-B) FAST Tuning

When the [FAST/RX] switch (#87) is pressed, the imbedded LED will light up, and tuning of the Sub (VFO-B) frequency will increase by a factor of 10. Press the [FAST/RX] button once more to return to the normal tuning rate.

#### Sub (VFO-B) BAND/MHz Up/Down Control

If you press the [BAND/MHz / TX] switch momentarily, the imbedded LED will light up, and this knob may now be used for selection of the desired Amateur band. Pressing the [BAND/MHz / TX] switch once again will cancel Up/Down Band selection, and the LED will turn off.

If you press and hold in the [BAND/MHz / TX] switch for 2 seconds, the imbedded LED will light up, and this knob may now be

#### BAND/MHz Up/Down Control

When the [BAND/MHz] key (#83) is pressed momentarily, the Red LED imbedded in the switch will light up, and you may then use this knob for selecting the desired Amateur band. If you have engaged the "My Bands" feature via Menu #135, this knob will select from among just the Amateur bands that you have included in the "My Bands" list.

If you press and hold in the [BAND/MHz] key (#83) for 2 seconds, the imbedded LED will glow Orange, and this knob may now be used for rapid tuning in 1 MHz frequency steps.

#### Memory Channel/Memory Group Control

Pressing the [MCH/GRP] key (#85) momentarily will enable the use of this knob for selection of the desired Memory Channel.

Pressing and holding in the [MCH/GRP] key for two seconds will enable the use of this knob for selecting the desired Memory Group.

used for Up/Down tuning of the Sub (VFO-B) frequency in 1 MHz steps. Press the [BAND/MHz / TX] switch momentarily to cancel Up/Down tuning; the imbedded LED will turn off.

#### Sub (VFO-B) Mode Selection

When the [B-MODE/CLEAR] switch is pressed, the imbedded LED will light up, and this knob may now be used for selection of the operating mode for Sub (VFO-B) band operation. Pressing the [B-MODE/CLEAR] key once more will cancel mode selection, and the imbedded LED will turn off.

#### 『Note』

Mode selection may also be accomplished by pressing the [A/B] key (#90), then pressing the appropriate Mode switch (#31) to the left of the Main tuning Dial.



## ⑧7 **FAST/RX Switch**

### **FAST Switch**

When the **[A/B]** switch (#90) is pushed, and the Orange lamp to the right of the **[CLAR/VFO-B]** knob lights up, the **[CLAR/VFO-B]** knob (#86) will be controlling the Sub (VFO-B) frequency; pressing the **[FAST/RX]** switch will increase the tuning rate by a factor of 10.

### **RX Switch**

When the **[CLAR]** switch (#82) is pressed (and its imbedded LED is illuminated), pressing the **[FAST/RX]** switch applies the programmed Clarifier offset to the Main (VFO-A) receive frequency. Press the **[FAST/RX]** switch once more to return the Main receiver to the frequency shown on the main frequency display field; the Clarifier offset will still be present, though, in case you want to use it again. To cancel the Clarifier offset, press the **[B.MODE/CLEAR]** switch (see details in #89 below).

## ⑧8 **BAND/MHz / TX Switch**

### **BAND/MHz**

When the **[A/B]** switch (#90) is pressed, and the Orange lamp to the right of the **[CLAR/VFO-B]** knob lights up, pressing the **[BAND/MHz]** switch allows you to rotate this knob for selection of the Amateur band to be used for the Sub (VFO-B) band.

### **TX Switch**

When the **[CLAR]** switch (#82) is pressed (and its imbedded LED is illuminated), pressing the **[BAND/MHz / TX]** switch applies the programmed Clarifier offset to the Main (VFO-A) transmit frequency. Press the **[FAST/RX]** switch once more to return the transmitter to the Main (VFO-A) frequency shown on the main frequency display field; the Clarifier offset will still be present, though, in case you want to use it again. To cancel the Clarifier offset, press the **[B-MODE/CLEAR]** switch (see details in #89 below).

## ⑧9 **B.MODE/CLEAR Switch**

### **B.MODE Switch**

When the **[A/B]** switch (#90) is pressed, and the Orange lamp to the right of the **[CLAR/VFO-B]** knob lights up, pressing the **[B.MODE/CLEAR]** switch allows you to rotate this knob for selection of the operating mode to be used on the Sub (VFO-B) band.

### **CLEAR Switch**

When the **[CLAR]** switch (#82) is pressed (and its imbedded LED is illuminated), pressing the **[B.MODE/CLEAR]** switch clears out any frequency offset you have programmed into the Clarifier register (thereby setting the offset to “Zero”).

## ⑨0 **A/B Switch**

The **[A/B]** switch controls the determines whether the actions of the **[CLAR/VFO-B]** knob will be applied to the Main (VFO-A) band (“CLAR” option), or the Sub (VFO-B) band (“VFO-B option”).

Pressing this switch once causes the Orange lamp to the right of the **[CLAR/VFO-B]** knob (#86) to light up; in this case, rotation of the **[CLAR/VFO-B]** knob affects operation on the Sub (VFO-B) band (tuning, etc.). Pressing the **[A/B]** switch once more causes the Orange lamp to turn off; in this instance, rotation of the **[CLAR/VFO-B]** knob affects operations associated with the Main (VFO-B) band (Clarifier function, etc.).

## ⑨1 **[F1] ~ [F7]/DISP Keys**

### **[F1] ~ [F7] Key**

These keys are used for selection of a variety of functions, depending on the TFT operation page selected. The actual selection available at any given time is shown on the TFT, just above the function key.

### **DISP (Display) Key**

This key is used for selection of the desired TFT operation page.

## ⑨2 **BAND Key**

These keys allow one-touch selection of the desired Amateur band (1.8 ~ 50 MHz).

What's more, the [0] ~ [9] keys may be used for direct entry of a desired operating frequency during VFO operation.

## ⑨3 **TFT Display (see page 40)**

This 6.5-inch TFT display is used for viewing and control of a variety of features, and it includes pages including a World Map, World Clock, Spectrum Scope, SWR and Transmitter Status, Log Book, Audio Scope and Oscilloscope, Memory Channel listing, and Menu listings, plus much more.

# REAR PANEL

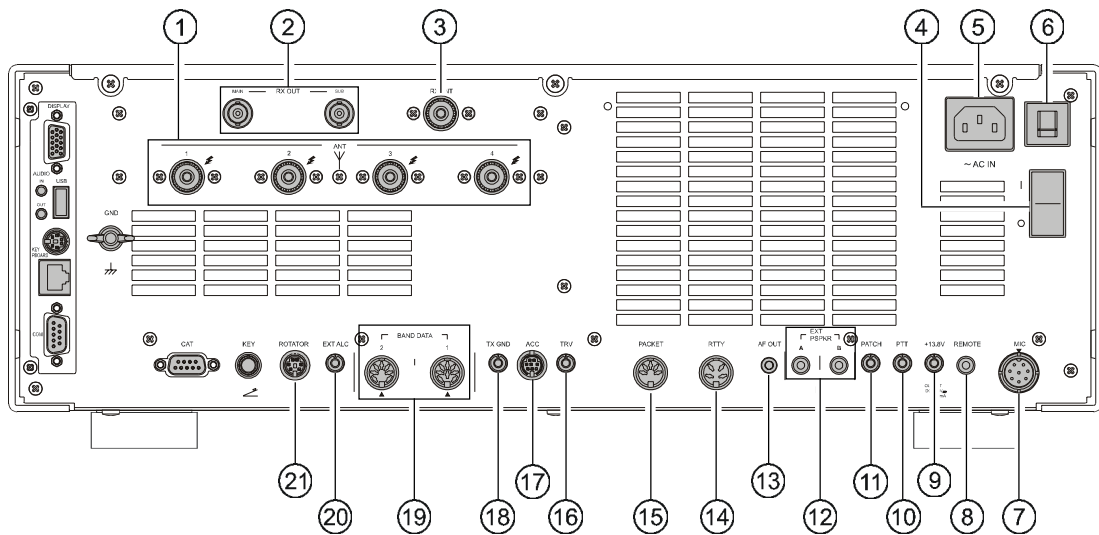

## ① ANT

Connect your main antenna(s) here, using a type-M (PL-259) plug and coaxial feedline for each. These antenna ports are always used for transmission, and also are used for reception unless a separate receive antenna is also used for the main receiver. The internal antenna tuner affects only the antenna(s) connected here, and only during transmission. These connectors utilize Teflon<sup>®</sup> insulation for extreme durability and to ensure stable impedance over the entire frequency range.

## ② RX OUT

These BNC jacks provide output of the receiver signal lines from the Antenna jacks which are connected to the Main (VFO-A) and sub (VFO-B) front ends.

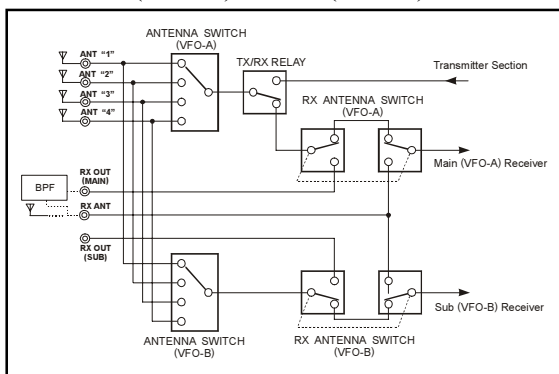

## ③ RX ANT

This type-M jack is for a separate receive-only antenna. An antenna connected here can be used, by both the main (VFO-A) and sub (VFO-B) receivers, when the **[RX ANT]** button on the front panel is pressed. If you want to use some special kind of external bandpass filter or preamplifier, you may connect it between the RX OUT and RX ANT jacks, as shown in the illustration.

## ④ Main Power Switch

This is main power On (I)/Off (O) switch of the FT DX 9000. Always turn this switch on before turning on the front panel's POWER button.

If this switch is not turned On, the front panel Power switch will not function.

Turning this Main Power switch On supplies voltage to the OCXO (Crystal Oven), ensuring that frequency stability is always maintained even when the transceiver is turned off via the front panel's Power switch.

## ⑤ AC IN

Connect the supplied 3-wire AC line cord to this socket. AC voltages of 100-240 V may be accommodated by the FT DX 9000D without any sort of modification (universal voltage input).

## ⑥ CIRCUIT BREAKER Switch

This circuit breaker shuts off in the event of dangerously high current consumption by the transceiver.

### 『Advice』

If the Circuit Breaker interrupts power, by all means try to determine the cause of the over-current condition before re-applying power. To restore the Circuit Breaker after verifying that all is normal, push this switch in until you hear a "click."

## ⑦ MIC

This 8-pin jack accepts input from a microphone utilizing a traditional YAESU HF-transceiver pinout.

## ⑧ REMOTE

By plugging in the supplied FH-2 Remote Control Keypad to this gold-plated jack, direct access to the FT DX 9000D CPU is provided for control functions such as contest memory keying, plus frequency and function control. This jack may also be also used for remote control of the VL-1000 Linear Amplifier, if used.

## ⑨ +13.8V

This gold-plated output jack provides regulated, separately fused 13.8 VDC at up to 200 mA, to power an external device such as a packet TNC. Make sure your device does not require more current (if it does, use a separate power source).

## ⑩ PTT

This gold-plated input jack may be used to provide manual transmitter activation using a footswitch or other switching device. Its function is identical to the **【MOX】** button on the front panel. The same line is available at the PACKET and RTTY jacks for TNC control. Open-circuit voltage is +13.5 VDC, and closed-circuit current is 5 mA.

## ⑪ PATCH

This gold-plated RCA input jack accepts transmitter audio - either AFSK or voice - for transmission. This line is mixed with the microphone audio input line, so the microphone should be disconnected if using this jack and mixing is not desired. The optimum impedance is 500 ~ 600 Ohms, and the nominal input level should be 1 mV.

## ⑫ EXT SPKR

The EXT SPKR two-contact output jacks are gold plated, providing audio from the Main (VFO-A) and Sub (VFO-B) receivers for an external loudspeaker or speakers, such as the SP-8. Inserting a plug into one of these jacks disables the corresponding internal loudspeaker. Impedance is 4 ~ 8 Ohms.

## ⑬ AF OUT

This gold-plated 3-contact jack provides dual-channel low-level receiver output, for recording or external amplification. Peak signal level is 3 Vrms at 10 k-Ohms. Main band (VFO-A) receiver audio is on the left channel (tip), and sub band (VFO-B) receiver audio is on the right channel (ring). A stereo amplifier or recorder is recommended, to record each receiver's audio separately when dual reception is enabled (audio from either receiver, or both, may be used via this jack). The front panel **【AF GAIN】** knobs do not affect the signals at this jack.

## ⑭ RTTY

This 4-pin input/output jack provides connections for an RTTY terminal unit. Pinout is shown on page 123. The receiver audio level at this jack is at a constant 100-mV (@600 Ohms) level. FSK keying at this jack is accomplished by a closure of the SHIFT line to ground by the terminal unit.

## ⑮ PACKET

This 5-pin input/output jack provides receiver audio and squelch signals, and accepts transmit (AFSK) audio and PTT control, from an external Packet TNC. Pinout is shown on page 122. The receiver audio level at this jack is approximately 100 mV (@600 Ohms).

## ⑯ TRV

This gold-plated RCA jack provides a low level RF output for use with a transverter. Maximum output is approximately -20 dBm (0.01 mW) at 50 Ohms.

## ⑰ ACC

This is an accessory jack which is used at the factory for adjustment of the radio. Please do not connect any cable or accessory to this terminal.

## ⑱ TXGND

This jack's center pin is closed to ground while the transceiver's transmitter is engaged. It may be used for control of a peripheral device, most typically a linear amplifier. To enable this jack, please set Menu item "TX GNRL 157 EXT AMP TX-GND" to the "ENABLE" selection. This RCA connector is gold-plated, and the specifications are shown below.

## ⑲ BAND DATA

### BAND DATA1

This 7-pin output jack used for control of the VL-1000 Solid-state Linear Amplifier.

### BAND DATA2

This 8-pin output jack provides band selection data which may be used for control of optional accessories such as the VL-1000 Solid-state Linear Amplifier.

## ⑳ EXT ALC

This gold-plated RCA input jack accepts negative-going external ALC (Automatic Level Control) voltage from a linear amplifier, to prevent over-excitation by the transceiver. Acceptable input voltage range is 0 to -4 VDC.

## ㉑ ROTATOR

This 5-pin MINI-DIN Jack accepts a cable connected to a YAESU G-800DXA/-1000DXA/-2800DXA Antenna Rotator. You may control the antenna azimuth rotation (and rotation speed) using the Function buttons on the front panel. (Listed models are current as of early 2005).

# REAR PANEL

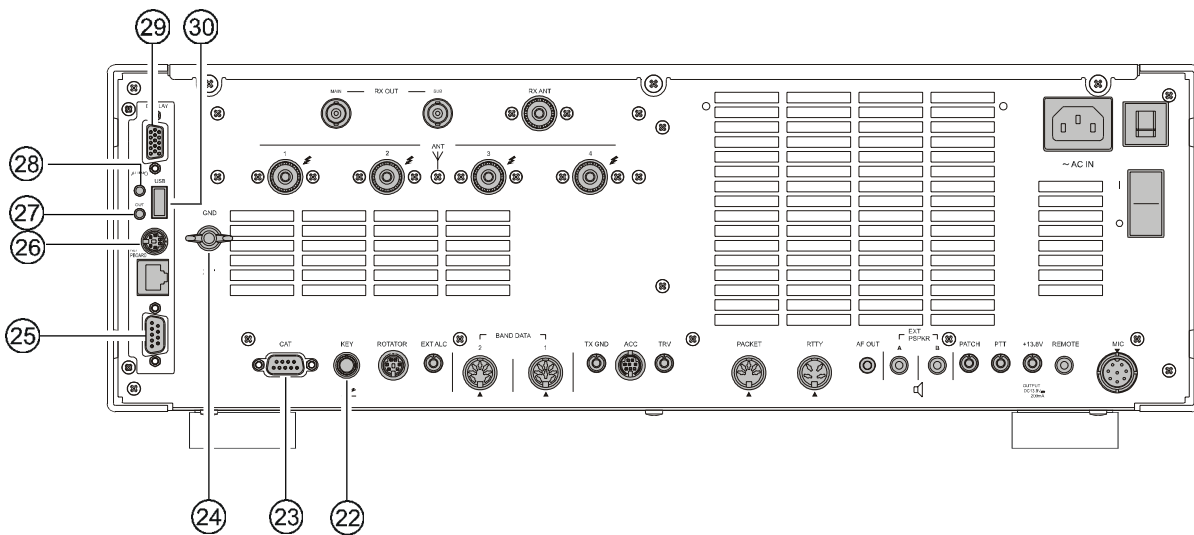

## 22 KEY

This 1/4-inch gold-plated phone jack accepts a CW key or keyer paddle. A 2-contact plug cannot be used in this jack. Key-up voltage is +5 V, and key-down current is 1 mA. Plug wiring is shown on page 16, and this jack may be configured for keyer, “Bug,” “straight key,” or computer keying interface operation via Menu item “MODE-CW 043 R-KEYER TYPE” (see page 135).

## 23 CAT

This 9-pin serial DB-9 jack allows external computer control of the FT DX 9000D. Connect a serial cable here and to the RS-232C COM port on your personal computer (no external interface is required).

## 24 GND

Use this terminal to connect the transceiver to a good earth ground, for safety and optimum performance. Use a large diameter, short braided cable for making ground connections, and please refer to page 13 for other notes about proper grounding.

## 25 COM

Connect a GPS receiver capable of supplying NMEA data (not supplied) to this jack. When you connect the GPS receiver to this jack, the FT DX 9000D will automatically set your current location automatically into the “World Map” page of the TFT monitor.

## 26 KEY BOARD

Connect your keyboard (not supplied) to one of these jacks in accordance with your keyboard type (“USB” or “PS/2”) to use the Smart Memory Card for storage of logbook data, and for input of your location when setting up the World Clock.

## 27 AUDIO OUT

This terminal is for future expansion of the transceiver’s capabilities. It is designed for connection to a computer’s sound card input, but at this time it is not supported.

## 28 AUDIO IN

This terminal is for future expansion of the transceiver’s capabilities. It is designed for connection to a computer’s sound card output, but at this time it is not supported.

## 29 DISPLAY

Connect an external monitor (not supplied) to this jack. An external monitor makes TFT display information available on a much larger screen, for ease of viewing.

## 30 USB Jack

This jack supports the USB 1.1 protocol, for connection of a USB keyboard.

### 『Note』

Other types of USB-related accessories (other than a keyboard) are not supported by this jack, and must not be connected here.

Downloaded by  
RadioAmateur.EU

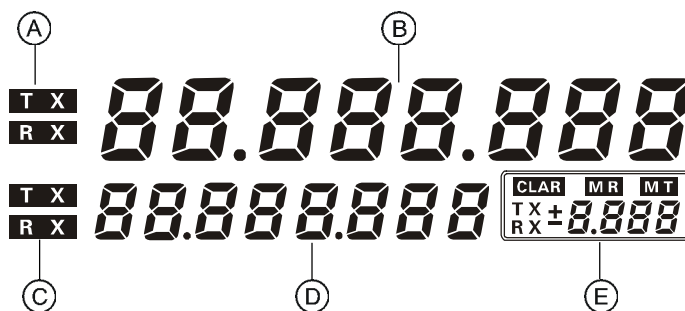

**(A) Main (VFO-A) Band TX/RX Indicators**

These combination lamp-buttons select and indicate the transmit/receive status of the Main (VFO-A) band. When the green “RX” lamp is lit, the receiving frequency is under control of the **【Main】** Tuning Knob and display (either VFO-A or a recalled memory channel). When the red “TX” lamp is lit, the transmitting frequency is under control of the **【Main】** Tuning Knob and display. Thus, for “normal” (non-split) operation, both the red and green lamps associated with the **【Main】** Tuning Knob will be illuminated.

**(B) Main (VFO-A) Frequency Display**

This is the Main (VFO-A) band frequency display.

**『Advice』**

When setting the CTCSS frequency for Encoding or Tone Squelch operation, the tone information will appear in this area during setup.

**(C) Sub (VFO-B) Band TX/RX Indicators**

These combination lamp-buttons select and indicate the transmit/receive status of the Sub (VFO-B) band.

**(D) Sub (VFO-B) Band Frequency Display**

This is the Sub (VFO-B) band frequency display.

**『Advice』**

The Tone Encoder/Decoder frequency is indicated during the setup process.

**(E) Multi-Panel**

This field within the frequency display area provides several indications, depending on the frequency control mode in use:

**CLAR (Clarifier)**

This window displays the Clarifier frequency offset from the Main (VFO-A) band frequency. The Clarifier is engaged when the CLAR LED is illuminated.

**MR (Memory Recall)**

When the **【MCH/GRP】** switch is pushed, the currently-selected Memory channel or Memory Group number will be displayed in this window.

**MT (Memory Tune)**

If you rotate the Main Tuning Dial (or change the mode) during memory operation, the transceiver will change into the “Memory tune” mode to indicate that the memory contents have been temporarily changed; “**MT**” lights up to confirm this change.

**Repeater Shift Data**

During FM operation, the Repeater Shift will be indicated in this window.

A Negative frequency shift will be indicated by “-” while a Positive frequency shift will be indicated by “+” in the window. During Simplex operation (no shift), “S” will be displayed.

# TFT FEATURE/CONTROL DETAILS

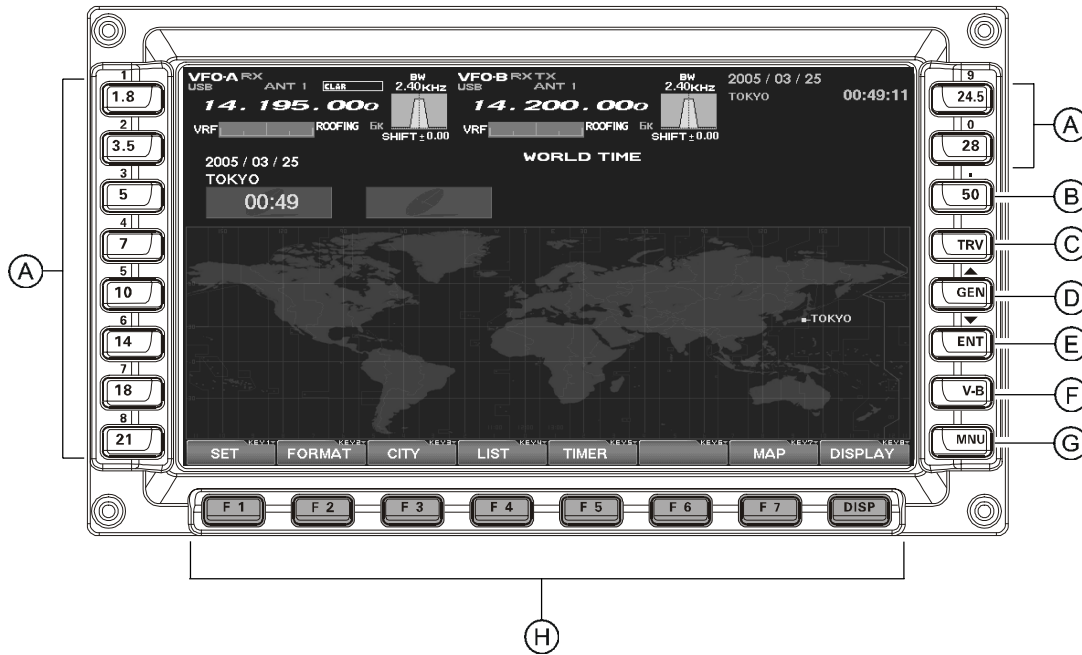

- Ⓐ Pressing any of these keys provides one-touch access to the Amateur bands from 1.8 ~ 28 MHz. When the **【ENT】** key has been pressed first, these keys then serve as the frequency entry digits (“1” ~ “0”) during direct frequency entry.
- Ⓑ Pressing this key provides one-touch access to the 50 MHz Amateur band. When the **【ENT】** key has been pushed first, to engage direct frequency entry, pressing this key sets the decimal point after the “MHz” portion of the frequency.
- Ⓒ This key turns the 28 MHz low-level (0 dBm) output from the rear-panel’s **【TRV】** jack ON or OFF. When the Transverter function is turned on, both the TFT and the main frequency display will show the converted frequency’s last two digits of the “MHz” field, according to the band programmed via Menu #034 (for example, if your transverted frequency is 144.200.00 MHz, the display will show “44.200.00” as the operating frequency).
- Ⓓ Pressing this key selects the “General Coverage” VFO register, for reception outside the Amateur bands.
- Ⓔ Pressing this key momentarily engages the “direct frequency entry” mode of operation, whereby the keys described in the (A) and (B) sections above are used for directly programming the operating frequency. Once the frequency has been successfully entered, press the **【ENT】** key once more to exit to the newly-selected frequency.

- Ⓕ For entering a frequency directly into the Sub (VFO-B) register, press this key. Then use the keys described in sections (A) and (B) above for entering the digits of the desired frequency; when done, press the **【V-B】** key once more to lock the newly-selected frequency into the Sub (VFO-B) register.
  - Ⓖ This key is used for gaining access to the Menu system, for configuring various transceiver characteristics. Menu operation is described in detail, in this manual, beginning on page 126.
- Important note:**  
pressing this key momentarily activates the Menu, and the Menu selections will appear on the TFT screen; once you are finished, you must press and hold in the **【MNU】** key for two seconds to save any configuration changes (momentarily pressing **【MNU】** to exit will not save the changes).
- Ⓗ These are the “Function” keys for the various functions associated with each page of the TFT’s operational capability. The exact function of each key will depend on the page selected.



The supplied Remote Control Keypad “FH-2” can be used to control the voice memory capability for the SSB/AM/FM modes, and the contest memory keyer for the CW mode. You can also play back up to 30 seconds of incoming received audio, as well, for verification of a missed callsign or other purposes. Among the specific capabilities of the FH-2 are:

- Five channels of storage and playback of voice memory (20 seconds each), using your own voice for recording (see page 92).
- Playback of the last 30 seconds of incoming receiver audio (see page 52).
- On CW, the FH-2 provides storage and recall of CW messages for repetitive CQ and contest number transmissions (see page 106).

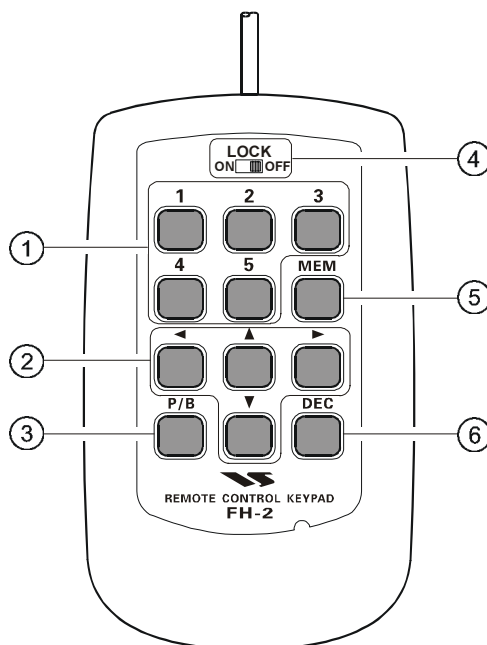

## ① Voice Memory/CW Message Memory Selection Keys (5 Channels)

In the case of Voice Memory, up to 20 seconds of audio may be stored on each channel.

For CW messages and CW Text messages, up to 50 characters (“PARIS” specification) may be stored into each channel.

## ② Text Memory Programming Keys

These keys are used for navigation when selecting text characters for the programming of Contest and Text memories.

## ③ Playback Key

This key replicates the action of the [P.BACK] (“Playback”) switch on the front panel of the transceiver, and is used for playing back the last 30 seconds of recorded receiver audio.

## ④ LOCK Switch

This switch may be used to lock out the FH-2’s keys, to prevent accidental activation of FH-2 operation.

## ⑤ MEM Key

This key is pressed for the purpose of storing either a Voice Memory or a Contest Keyer Memory channel’s contents.

## ⑥ DEC Key

When utilizing the sequential contest number capability of the Contest Keyer, press this key to decrement (back up) the current Contest Number by one digit (i.e. to back up from #198 to #197, etc.).

# BASIC OPERATION: RECEIVING ON AMATEUR BANDS

---

Before turning on main power, please verify the following items once more.

- Have you made all ground connections securely? See page 13 for details.
- Do you have your antenna(s) connected to the rear-panel Antenna jack(s)? See page 14 for details.
- Is your microphone (and/or key or paddle) connected? See page 15 and 16 for details.
- If using a linear amplifier, have all interconnections been successfully completed? See page 17 and 18 for details.
- Please rotate both **[AF GAIN]** controls to their fully counter-clockwise positions, to avoid a loud blast of audio when the transceiver turns on. See page 32 for details.
- Rotate the **[RF PWR]** control fully counter-clockwise, to set minimum power at first. See page 32 for details.
- Before attempting voice transmissions, you must be certain that the microphone you intend to use is plugged into an “Active” microphone jack. On the front panel is a 3-pin “Cannon” (XLR) connector, and on the rear panel you’ll find a “traditional” 8-pin round connector. At the factory, the XLR connector is selected, but you may easily change this using the Menu item designated “MODE-SSB 069 SSB MIC SELECT;” please confirm that this Menu item is configured appropriately.

**『Note』**

If the wrong microphone jack is selected, voice transmission will not be possible.

- Once AC power is applied, please refer to the “TFT Operation Manual” and perform the setup for the Local Time. If this setup procedure is not performed, the World Clock and Logbook functions will not operate correctly.
- If your AC mains power should suffer a significant fluctuation or interruption, we recommend that you go through a complete power-up cycle, in order to ensure that all circuits are properly initialized. To do this, be sure the front panel Power switch is turned off, then set the rear-panel Power switch to the “**●**” position. Now unplug the AC cable from the rear panel of the transceiver, and wait ten seconds. The start-up procedure is described on the next page.



# BASIC OPERATION: RECEIVING ON AMATEUR BANDS

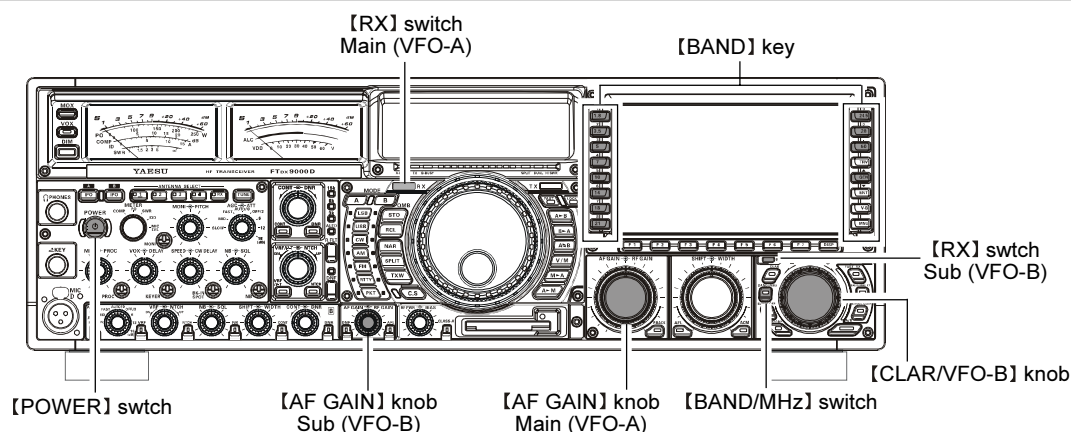

1. Plug the AC cable back in, set the rear-panel Power switch to "I."
2. Press and hold in the front-panel Power switch for two seconds to turn the transceiver on.
3. After about 50 seconds, all circuits will be initialized. The transceiver will start up on 7.000.00 MHz LSB, and normal operation may resume.

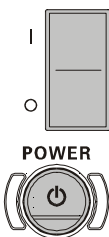

### 『Note』

To turn power off, press and hold in the front panel **[POWER]** switch for two seconds.

### 『Quick Note』

The opening screen on the TFT will be gray, and some text notes advising status during the boot-up sequence may appear. When the radio is turned on for the first time, it takes about 50 seconds (from turning the radio on to completing the self-check) until the radio becomes ready to use; however, from the next time you turn it on, it will take around 10 seconds until the transceiver is ready for full operation.

4. Rotate the **[AF GAIN]** knob (#75) to set a comfortable audio level on incoming signals or noise. Clockwise rotation of the **[AF GAIN]** knob increases the volume level.

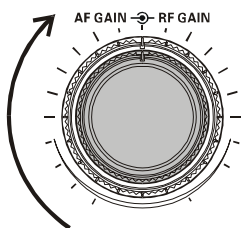

### 『Note』

When using headphones, start by rotating the **[AF GAIN]** control counter-clockwise, then bring the volume level up after you put the headphones on. This will minimize the chance of damage to your hearing caused by an unexpectedly-high audio level.

5. Press the **[MAIN RX]** switch (#33) to engage the Main (VFO-A) receiver, the imbedded LED will glow Green.

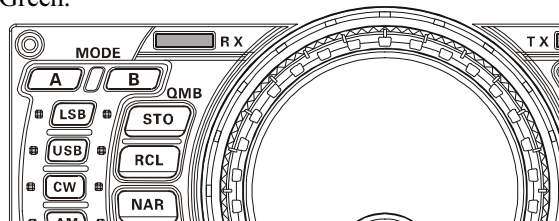

### 『Advice』

If you press the **[MAIN RX]** key (#33) when the imbedded LED is already glowing Green, the LED will now blink on and off; this indicates that the Main (VFO-A) receiver is temporarily muted. Just press the **[MAIN RX]** key once more to restore Main (VFO-A) receiver operation.

Press the **[SUB RX]** switch (#80) to engage Dual Reception (using Sub the (VFO-B) receiver in addition to the Main (VFO-A) receiver). When you press the **[SUB RX]** key, its imbedded LED will glow green; pressing this key once more will turn off the Sub (VFO-B) receiver, and the imbedded LED will glow dark. Use the Sub Receiver's **[AF GAIN]** knob (#70) to adjust the Sub (VFO-B) receiver volume level.

6. Press the **[A]** switch (#31) to enable the capability to change the operation for the Main (VFO-A) band the imbedded LED will glow Red.

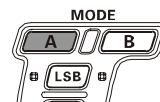

7. Surrounding the TFT are the band selection keys; press the **[BAND]** key corresponding to the Amateur band on which you wish to begin operation.

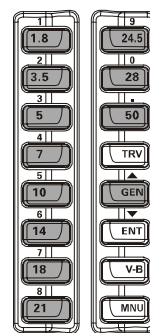

### 『Advice』

- One-touch selection of each Amateur band between 1.8 and 50 MHz is provided.
- If you press the **[BAND/MHz]** key (#83) momentarily, the **[CLAR/VFO-B]** knob (#86) may be used as a band selection knob. If the **[CLAR/VFO-B]** knob is pressed and held in for two seconds, rotation of the **[BAND/MHz]** key allows frequency navigation in 1 MHz steps.
- When the **[BAND/MHz]** key's imbedded LED is illuminated, the **[CLAR/VFO-B]** knob controls the functions associated with the **[BAND/MHz]** key.

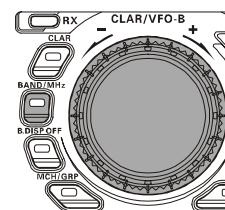

# BASIC OPERATION: RECEIVING ON AMATEUR BANDS

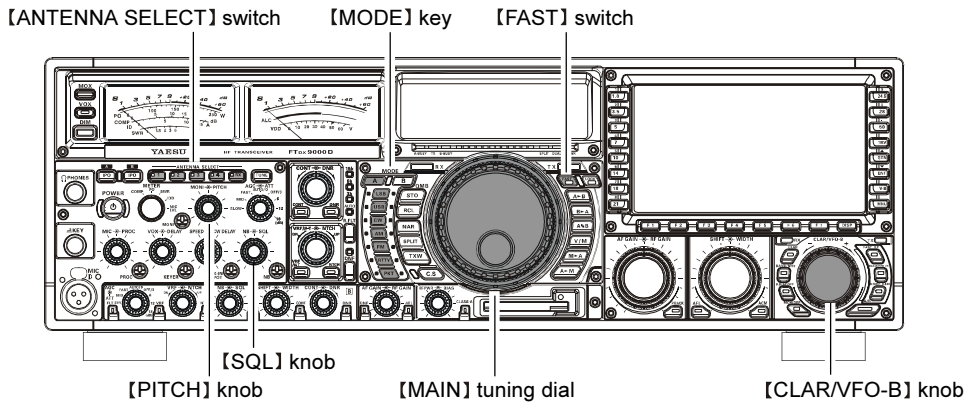

**『Advice』**

- Depending on the setting of the [A/B] switch (#90), the function of the [CLAR/VFO-B] knob (#86) will change. Please see page 34 for more details.
  - The FT DX 9000D utilizes a triple band-stack VFO selection technique, that permits you to store up to three favorite frequencies and modes onto each band's VFO register. For example, you may store one frequency each on 14 MHz CW, RTTY, and USB, then recall these VFOs by successive, momentary presses of the [14] MHz band key. Each Amateur band key may similarly have up to three frequency/mode settings applied.
8. Press one of the [ANTENNA SELECT (1~4)] switches to select the appropriate antenna for the band in use; alternatively, if one is connected, you may also press the [RX] antenna selection switch. Up to four TX/RX antennas may be connected, or one RX-only antenna.



**『Advice』**

Once you have made your antenna selection, that antenna is “remembered” by the microprocessor in conjunction with the VFO register (frequency and mode) in use when you chose that particular antenna.

9. Press the appropriate [MODE] key (#31) to select the desired operating mode.

**『Advice』**

- By convention in the Amateur bands, LSB is used on the 7 MHz and lower bands (with the exception of 60 meters), while USB is utilized on the 14 MHz and higher bands.
- When changing modes from SSB to CW, you will observe a frequency shift on the display. This shift represents the BFO offset between the “zero beat” frequency and the audible CW pitch (tone) you can hear (the pitch is programmed by the [PITCH] control), even though the actual tone that you hear is not changing. If you do not want this frequency shift to appear when changing modes from (for example) USB to CW, use the Menu item “MODE-CW 050 CW FREQ DISPLAY,” described on page 136.
- When operating on the FM mode, rotate the [SQL] (Squelch) control (#21) clockwise just to the point where the background noise is just silenced. This is the point of maximum sensitivity to weak signals. Excessive advancement of the [SQL] control will degrade the ability of the receiver to detect weak signals. Adjustment of the Sub (VFO-B) band Squelch is accomplished using the Sub [SQL] control (#63); see page 31.

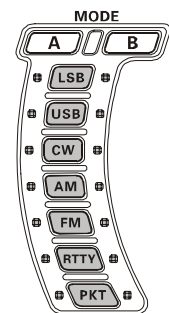

# BASIC OPERATION: RECEIVING ON AMATEUR BANDS

10. Rotate the **[Main]** Tuning Dial knob to tune around the band, and begin normal operation.

## 『Quick Note』

- Clockwise rotation of the Main tuning Dial increases the operating frequency, one “step” of the synthesizer at a time; similarly, counter-clockwise rotation of the **[Main]** tuning Dial will decrease the frequency.

Two steps, one “normal” and one “fast,” are available on each operating mode. Pressing the **[FAST]** key engages the “Fast” tuning selection.

Operating Mode	1 Step	1 Dial Rotation
LSB, USB, CW, RTTY, PKT(LSB)	10 Hz [100 Hz]	10 kHz [100 kHz]
AM, FM, PKT(FM)	100 Hz [1 kHz]	100 kHz [1 MHz]

[ ]: **[FAST]** switch set to “ON”

- It is possible to separate the frequency change over one dial rotation, while operating solely on the CW mode, using the Menu items “TUNING 129 MAIN DIAL STEP,” and “TUNING 130 MAIN DIAL CW FINE” See page 144.
- If you want to navigate quickly, so as to effect rapid frequency change, there are several techniques available:
  - Direct keyboard frequency entry of the frequency (see page 57).
  - Use the **[CLAR/VFO-B]** knob to tune in 1 MHz steps (see page 57).
  - Use the microphone’s Up/Down scanning keys, if your microphone is so equipped.

## OPERATION ON 60-METER (5 MHz) BAND (U.S. VERSION ONLY)

The FT DX 9000D includes the capability for transmission and reception on the five spot frequencies assigned to the Amateur Service in the United States. To operate on the 5 MHz band:

1. Press the **[V/M]** key (#45) once to enter the “Memory” mode (a memory channel number “USX” will appear on the display in the Multi-Panel on the TFT display).
2. Memory channels “US1” through “US5” are pre-programmed, at the factory, with the permitted frequencies in the 5 MHz band, and the USB mode is automatically selected on these channels.
3. To exit from 60-meter operation and return to the VFO mode, just press the **[V/M]** key.

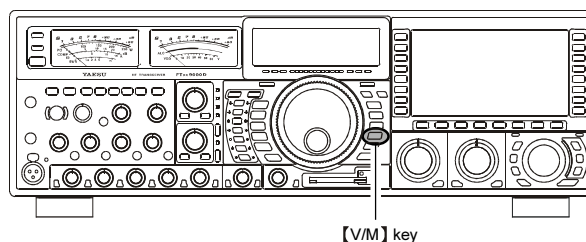

## 『Note』

The frequencies and operating mode for 5 MHz band operation are both fixed, and may not be changed.

# BASIC OPERATION: RECEIVING ON AMATEUR BANDS

## CLAR (CLARIFIER) OPERATION ON MAIN (VFO-A)

The **[CLAR]** button and **[CLAR/VFO-B]** knob are used to offset either the receive, transmit, or both frequencies from their settings on the main band (VFO-A) frequency (the Clarifier does not affect the sub band (VFO-B), however). The four small numbers on the Multi Display Window show the current Clarifier offset. The Clarifier controls on the FT DX 9000 are designed to allow you to preset an offset (up to  $\pm 9.999$  kHz) without actually retuning, and then to activate it via the Clarifier's RX (FAST RX) and TX (BAND/MHz TX) buttons. This feature is ideal for following a drifting station, or for setting small frequency offsets sometimes utilized in DX "Split" work.

Here is the technique for utilizing the Clarifier:

1. Press the **[CLAR]** switch (#82). The LED imbedded in the switch will glow Red to signify that rotation of the **[CLAR/VFO-B]** knob (#86) will allow setting of a frequency offset.
2. Press the **[FAST/RX]** switch (#87). On the display, "CLAR" and "RX" will appear, and the programmed offset will be applied to the receive frequency.
3. Rotation of the **[CLAR/VFO-B]** knob will allow you to modify your initial offset on the fly. Offsets of up to  $\pm 9.99$  kHz may be set using the Clarifier.

To cancel the application of the offset to the receiver frequency temporarily, press the **[FAST/RX]** switch. The "CLAR RX" notation will disappear from the display.

To cancel Clarifier operation, press the **[CLAR]** switch.

### 『Advice』

Turning the Clarifier Off simply cancels the application of the programmed offset from the receive and/or transmit frequencies. To clear out the programmed Clarifier offset altogether, and reset it to "zero," press the **[CLAR]** switch (#82). The programmed offset is displayed in the small multi-channel window of the frequency display.

### 『Note』

If the Clarifier seems not to be operating, check to see if the Orange lamp to the right of the **[CLAR/VFO-B]** knob (#86) is illuminated. If so, pressing the **[A/B]** switch (#90) will cause the Orange lamp to the right of the **[CLAR/VFO-B]** knob to go out. Now press the **[CLAR]** switch (#82) to begin Clarifier operation.

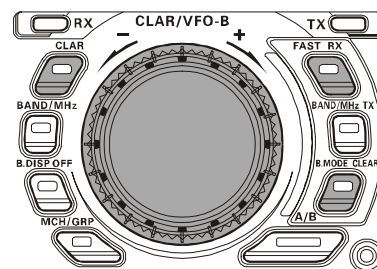
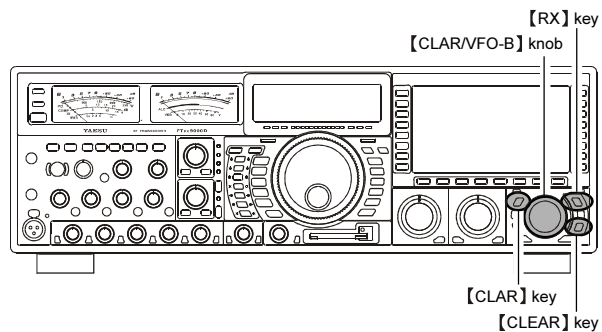

### TXCLAR

Without changing the receive frequency, you may alternatively apply the Clarifier offset to the transmit frequency (typically, for "split" DX pile-ups). See page 95 for details.

The LED Bar Display provides a graphical representation of the Clarifier offset.

On CW, the Bar Display field is used for CW Center Tuning, instead of Clarifier Offset, as the transceiver is configured at the factory. If you wish to change this, so that the Clarifier Offset is also displayed on CW, use the following procedure:

1. Press the **[MNU]** key (#92) to enter the Menu mode.
2. Rotate the Main Tuning Dial to select Menu item "DISPLAY 016 BAR DISPLAY SELECT."
3. Rotate the **[CLAR/VFO-B]** knob (#86) to select "CLAR" (replacing the default "CW-TUNE" selection).
4. Press and hold in the **[MNU]** key for two seconds to save the new setting and exit to normal operation.

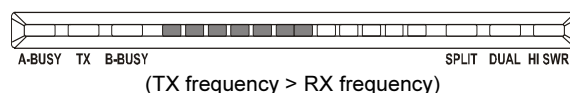
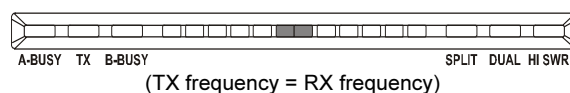
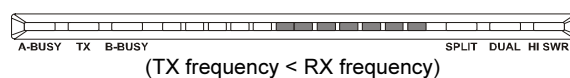

# BASIC OPERATION: RECEIVING ON AMATEUR BANDS

## LOCK

You may lock the setting of the **【Main】** Tuning Dial, to prevent accidental frequency change.

To lock out the **【Main】** Tuning Dial (#35), just press the **【LOCK】** switch (#37) that is located to the right of the Dial. To unlock the Dial setting, and restore normal tuning, just press the **【LOCK】** switch once more.

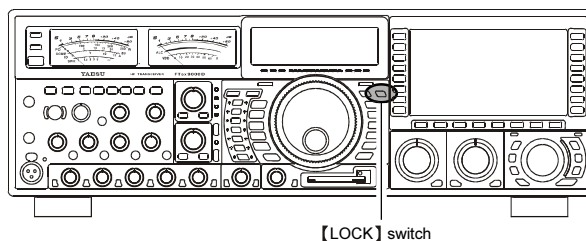

## DIM

The illumination level of the analog meters, main frequency display, and the TFT may be reduced, if you are using the transceiver in a dark environment where high brightness is not desired.

To reduce the illumination level, press the **【DIM】** switch (#3), located to the left of the leftmost analog meter. To restore full brightness, press the **【DIM】** switch once more.

You may also customize the amount of brightness reduction engaged by the pressing of the **【DIM】** switch, and may use different brightness levels for different front panel areas. Menu item “DISPLAY 14 DIMMER-METER” adjusts the brightness level of the analog meters, while menu item “DISPLAY 15 DIMMER-VFD” sets the brightness levels of the main frequency display and the TFT (these settings are effective only when the **【DIM】** switch is pressed).

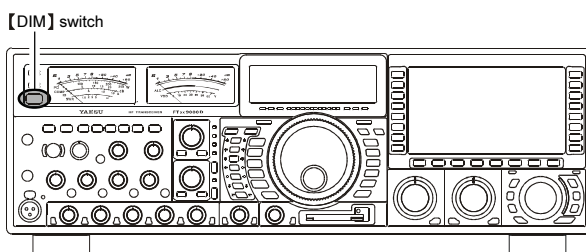

## B-DISP OFF

During monoband operation, you may wish to disable (temporarily) the display of the Sub (VFO-B) band frequency.

To do this, press the **【B.DISP OFF】** switch (#84), found at the lower left side of the **【CLAR/VFO-B】** knob (#86).

Press the **【B.DISP OFF】** switch once more to restore the Sub (VFO-B) band frequency display.

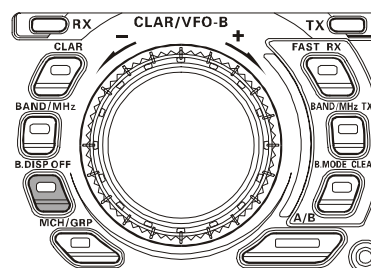
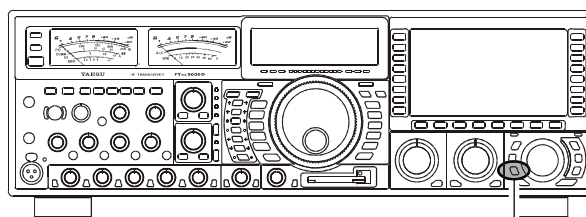
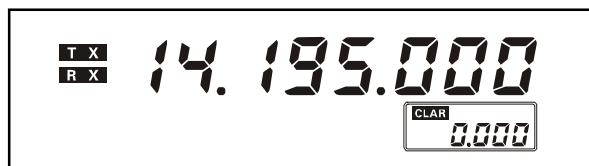



# CONVENIENT FEATURES

## DUAL RECEIVE

The FT DX 9000D is capable of simultaneous reception, using the Main (VFO-A) and Sub (VFO-B) receivers, in what is called the Dual Receive mode. Especially useful for DX work, here is the operating procedure for Dual Receive operation.

1. While receiving on the Main (VFO-A) band, engage the Sub (VFO-B) receiver by pressing the **【SUB RX】** key (#80). You will now be receiving on the two frequencies shown on the main frequency display.
2. Adjusting the volume:  
To adjust the Main (VFO-A) audio level, rotate the Main **【AF GAIN】** control (#75). To adjust the Sub (VFO-B) audio level, rotate the Sub **【AF GAIN】** control (#70). In both cases, clockwise rotation of the knob will increase the volume level.
3. Press the **【B】** switch (#31) to enable the capability to change the operating mode for the Sub (VFO-B) band.
4. Having pressed the **【B】** key in the previous step, you may also press the **【BAND】** keys surrounding the TFT to select the operating band on which you want to set up the Sub (VFO-B) receiver.
5. After you have set up the band and mode for the Sub (VFO-B) band, you should now select the proper antenna, using the **【ANTENNA SELECT 1 ~ 4】** switches (#9), or, for receive-only capability, the **【RX】** (Antenna) switch (#9).
6. Rotate the **【MAIN】** tuning dial (#35) to adjust the Main (VFO-A) frequency, and rotate the **【CLAR/VFO-B】** tuning dial (#86) to adjust the Sub (VFO-B) frequency.
7. To cancel Dual Receive operation, and receive just on the Main (VFO-A) receiver, press the **【RX】** switch (#80); the Orange LED to the right of the **【CLAR/VFO-B】** knob will go out, and monoband operation on the Main (VFO-A) receiver will resume.

### 『Note』

Please remember that, so long as the **【B】** Mode switch (#31) is illuminated, any mode or band changes will still be applied to the Sub (VFO-B) band, whether or not Dual Receive is engaged.

### 『Quick Note』

By convention in the Amateur bands, LSB is used on the 7 MHz and lower bands (with the exception of 60 meters), while USB is utilized on the 14 MHz and higher bands.

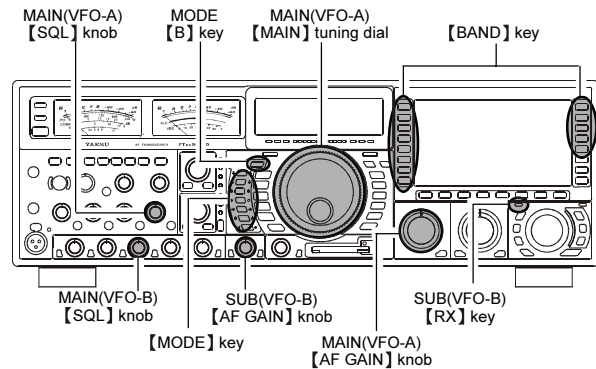

### 『Advice』

- When operating in Dual Receive, the manner in which the audio is fed to the left and right sides of your headphones (Stereo, Monaural, or Mixed) may be configured using Menu item “RX AUDIO 076 HEADPHONE MIX” (see page 139).
- When changing modes from SSB to CW, you will observe a frequency shift on the display. This shift represents the BFO offset between the “zero beat” frequency and the audible CW pitch (tone) you can hear (the pitch is programmed by the **【PITCH】** control: #13), even though the actual tone that you hear is not changing. If you do not want this frequency shift to appear when changing modes from (for example) USB to CW, use the Menu item “MODE-CW 050 CW FREQ DISPLAY,” described on page 136.
- When operating on the FM mode on the Sub (VFO-B) band, rotate the Sub (VFO-B) **【SQL】** (Squelch) control (#63) clockwise just to the point where the background noise is just silenced. This is the point of maximum sensitivity to weak signals. Excessive advancement of the **【SQL】** control will degrade the ability of the receiver to detect weak signals. Adjustment of the Main (VFO-A) band Squelch is accomplished using the Main **【SQL】** control (#21).

Downloaded by  
RadioAmateur.EU

---

## DUAL RECEIVE: FULL DUPLEX OPERATION

---

The FT DX 9000D includes a unique capability among HF transceivers: the ability to operate in a full duplex environment, where by you can transmit on the Main (VFO-A) band while simultaneously tuning around, on a different band, on the Sub (VFO-B) band. This affords the contest operator extra tuning time in search of new contacts and multipliers while calling CQ on the “run” band. This yields “SO2R” (Single Operator, Two Radio) operating capability while using only one transceiver!

To engage Full Duplex crossband operation, set Menu item “TX GNRL 158 FULL DUP” to “DUP” instead of the default “SIMP” selection. To return to normal (non-duplex) operation, return Menu to SIMP.

When Full duplex operation is engaged, you may receive on the Sub (VFO-B) band frequency while transmitting, during dual receive operation, on a different band on the Main (VFO-A) band. This allows you to tune for contacts on 15 meters, for example, while calling CQ on 20 meters during a slow time in a contest. Press the Sub (VFO-B) band **【TX】** Button/LED (#81) to switch transmit control to that VFO to call a station, then press the Main (VFO-A) band **【TX】** Button/LED (#34) to return to the “run” band and continue your “CQ” process.

This capability within a single transceiver is a unique feature of the FT DX 9000D. It relieves you of the need to run separate key, PTT, and other control lines to two different radios from your logging computer.

### 『Note』

Full Duplex operation within the same band (e.g. both Main and Sub VFOs on 20 meters) is not possible.

### Important Guidelines for Full Duplex Operation

Remember that, at your station location, the capability exists for damaging RF voltage to be conducted from your transmitting antenna into your receiving antenna during full duplex operation. The exact amplitude will depend on the operating frequency, proximity and polarization alignment of the antennas, and the transmitting power level (including your linear amplifier, if used).

Accordingly, you should take some time, in assembling your station, to ensure that proper isolation exists between your station antenna systems. One way to do this is to connect the “receive” antenna coaxial cable to the “Transmitter” jack of low-power Wattmeter, and connect the “Antenna” jack of the Wattmeter to a 50-Ohm Dummy load. Now transmit on the “TX” antenna you will be using, and observe the deflection (if any) on the low-power Wattmeter connected to the “receive” antenna. For safe operation of the FT DX 9000D, you should observe “10 mW” or less on the Wattmeter.

# CONVENIENT FEATURES

## DUAL RECEIVE: FULL DUPLEX OPERATION

### Using Headphones for Dual Receive

To take advantage of dual reception, you will want to connect stereo headphones to the PHONES jack. Like the AF GAIN control, headphone audio mixing can also be configured as desired from Menu Selection “RX AUDIO 076 HEADPHONE MIX.” Three audio mixing schemes are selectable as follows:

- OFF:** Audio from the Main band (VFO-A) receiver is heard only in the left ear, and Sub band (VFO-B) receiver audio solely in the right ear.
- MID:** Audio from both Main (VFO-A) and Sub (VFO-B) band receivers can be heard in both ears, but Sub band (VFO-B) audio is attenuated in the left ear and Main band (VFO-A) audio is attenuated in the right ear.
- FULL:** Audio from both Main (VFO-A) and Sub (VFO-B) band receivers is combined and heard equally in both ears (“Monaural” mode).

### Sideband Diversity Reception

Here you receive a single AM signal through the two receivers, each receiving the opposite sideband. Skywave-propagated signals often show phase distortion in this mode, but it gives you a view of the entire passband, from which you can then select the best sideband for listening (or for SWL Dx’ing, you may want to listen to both sidebands at the same time, to get the best copy). On groundwave signals, where the phase of the sidebands is likely to be the same, there is an interesting sense of depth to the signal.

To tune in a signal using this mode, you should have stereo headphones connected to the front panel PHONES jack or an external stereo speaker connected to the rear panel EXT SP jacks.

- Set the main band (VFO-A) to either LSB or USB mode, and tune for zero beat on the desired signal.
- Press the **[A▶B]** button (#42) to copy this mode and frequency into the sub band (VFO-B), then press the mode button to select the opposite sideband for the main band (VFO-A).
- If using headphones, set the headphone mixing scheme to the “COMBINE-1” mode via the Menu Selection 76: Head Phone Mix , and activate dual reception.
- Adjust the **[AF GAIN]** knob(s) to balance the volume of the two receivers.

If interference is present on one of the channels, you may have to turn its AF GAIN control to suppress that channel (or press the green “RX” LED/button to disable the receiver with the sideband experiencing interference). Otherwise, try changing the headphone audio mixing scheme to “FULL” or “OFF” in the Menu Selection “RX AUDIO 076 HEADPHONE MIX” for different effects (or try settings with similar effects on your external amplifier). Although you don’t get the “stereophonic” effect in the monaural mode, the two signals are still mixed, offering the potential for much better copy than in regular AM or even single-sideband ECSS modes.

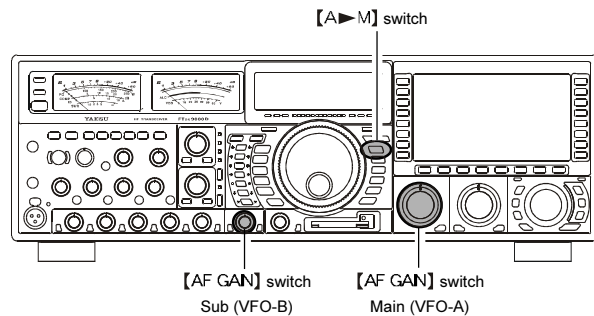



## DUAL RECEIVE: FULL DUPLEX OPERATION

### Bandwidth Diversity Reception

This mode involves receiving the same signal through two different bandpass filters. The frequency and mode of both the Main band (VFO-A) and Sub band (VFO-B) are the same. The main band (VFO-A) can be set up for a narrow bandpass, and the Sub band (VFO-B) for a wide bandpass, using the **【WIDTH】** knobs, resulting in a spatial perception of the channel. Although any mode (except FM) can be used, CW offers the widest array of choices, and perhaps the most startling effects on crowded channels.

Stereo headphones or an external stereo speaker are recommended for this mode. To set up the transceiver for bandwidth diversity reception:

- Select the desired mode on the Main band (VFO-A).
- Tune to the signal of interest.
- Press the **【A▶M】** button (#47) to copy this mode and frequency into the Sub band (VFO-B).
- If using headphones, set the headphone mixing scheme to the “MID” mode via the Menu Selection “RX AUDIO 076 HEADPHONE MIX” and activate dual reception.
- Adjust the **【AF GAIN】** knob(s) (#75 and 70) to balance the volume of the two receivers.
- Now try manipulating the **【SHIFT】** and **【WIDTH】** controls (on both main band (VFO-A) (#78) and sub band (VFO-B) (#65) receivers) to observe the interesting effects of bandwidth diversity.

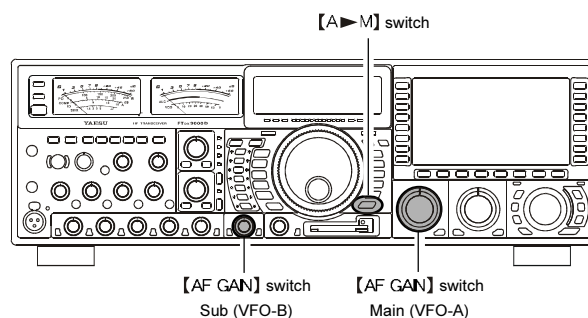

### Polarity Diversity

Similar in concept to the bandwidth diversity capability just described, another interesting capability of the FTDX9000 is the ability to use two different antennas on the same frequency, using dual reception. For example, you might have a horizontal Yagi on the main band, and a vertical antenna on the sub band, then lock the two frequencies together and engage dual reception.

Frequently, the fading observed on the HF bands is not so much a change in ionization level, but rather a shift in the polarization of the signal as it travels to and from the ionosphere. Having an opposite-polarization antenna available can fill in the signal during deep fades, and you may then transmit on whichever antenna is providing the strongest signal at the moment (see the discussion below on Split Frequency operation).

# CONVENIENT FEATURES

## P.BACK (AUDIO PLAYBACK) FROM MAIN (VFO-A) RECEIVER

Once engaged by the operator, the FT DX 9000D begins the automatic recording of the last 30 seconds of incoming receiver audio on the Main (VFO-A) band. This capability is especially useful for confirming a call sign that may have been difficult to copy due to noise or QRM, etc.

### Recording

Press and hold in the **[P.BACK]** key (#76) for two seconds to initiate recording; an LED imbedded in the switch will light up to confirm that recording is in progress. The recorder will store up to 15 seconds of the Main (VFO-A) band received audio, and will retain the most-recent 30 seconds of audio on a running basis.

Pressing the **[P.BACK]** switch once more will halt the recording, and the LED imbedded in the switch will go out.

### 『Note』

When the transceiver is turned off, the contents of the recording memory are erased!

### Playback

Press the **[P.BACK]** key (#76) momentarily, after recording has been halted, to begin playback of the recorded audio. The last 15 seconds of audio will be heard in the speaker or headphones. If you do not intervene, the entire 15 seconds will be played back repeatedly by pressing the **[P.BACK]** key momentarily again. The next time you press the **[P.BACK]** key, it will pick up the playback where you left off.

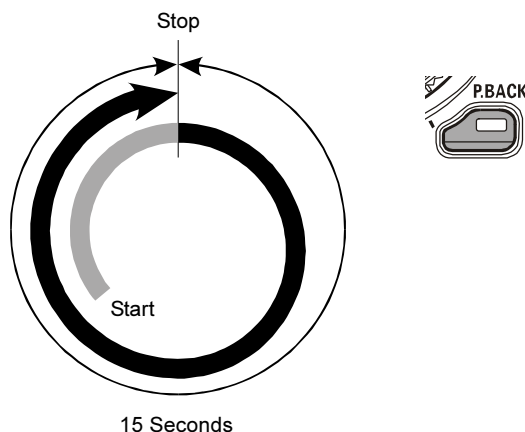
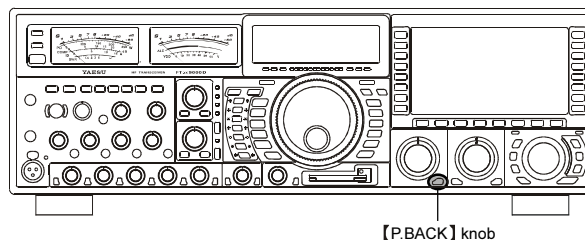

The **[P/B]** key of the supplied FH-2 Keypad can also serve as a remote-control recording/playback switch. Operation is described below.

### Recording

Press and hold in the FH-2's **[P/B]** key for two seconds to initiate recording.

The front panel **[P.BACK]** switch's LED will light up to confirm that recording is in progress.

Press the FH-2's **[P/B]** key momentarily to halt recording; the front panel's LED will go out.

You may also press the front panel's **[P.BACK]** key (momentarily) to halt recording, as well.

When the transceiver is turned off, the contents of the recording memory are erased.

### Playback

Press the FH-2's **[P/B]** key momentarily, after recording has been halted, to begin playback of the recorded audio. The last 15 seconds of audio will be heard in the speaker or headphones. If you do not intervene, the entire 15 seconds will be played back, after which the playback will stop automatically. To halt playback at any time, just press the **[P/B]** key momentarily again. The next time you press the **[P.BACK]** key, it will pick up the playback where you left off. You may also press the front panel's **[P.BACK]** key (momentarily) to play back the recorded audio, as well.

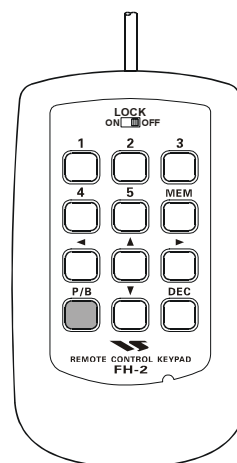

## “MY BANDS” OPERATION

When operating on an Amateur Band on the Main (VFO-A) register, it is possible to use the **[BAND/MHz]** switch (#83) to engage the use of the **[CLAR/VFO-B]** knob (#86) for Amateur band selection. The “My Bands” feature allows you to select several Amateur bands, and make only those bands available for selection via the **[CLAR/VFO-B]** tuning knob. This feature can be very useful in a contest, where the 10/18/24 MHz band are not used, or if you do not have antennas for some bands.

### “My Bands” Setup

1. Press the **[MNU]** key (#92) to engage the Menu mode; the Menu list will appear on the TFT.
2. Rotate the **[Main]** Tuning Dial (#35) to select Menu item “TUNING 135 MY BAND”.
3. Rotate the **[CLAR/VFO-B]** knob (#86) to choose a band that you wish to skip (omit) from the band-selection loop (when using the **[CLAR/VFO-B]** knob for band selection). The available choices are 1.8/3.5/7/10/14/18/21/24/28/50/GEN/TRV, and the factory-default selection is TRV (only).
4. Press the **[ENT]** key (#92) to set the omission command to ON.
5. Repeat steps 3 and 4 to select/deselect as many bands as you like.

#### 『Note』

The “ON” command sets the selected band to be skipped, while the “OFF” command sets the selected band to be included in the band-selection list.

6. Press and hold in the **[MNU]** key for two seconds to lock in the new configuration and exit to normal operation.

### “My Bands” Operation

1. Press the **[BAND/MHz]** switch (#83); the imbedded LED will glow Red.
2. Rotate the **[CLAR/VFO-B]** knob (#86) to choose the Amateur band on which you wish to operate. Only those Amateur bands that have not been skipped will appear as you scroll through the bands.

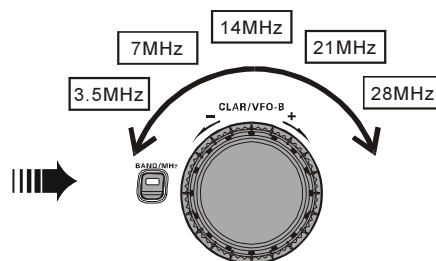
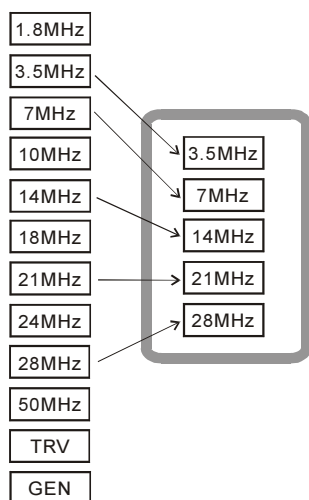
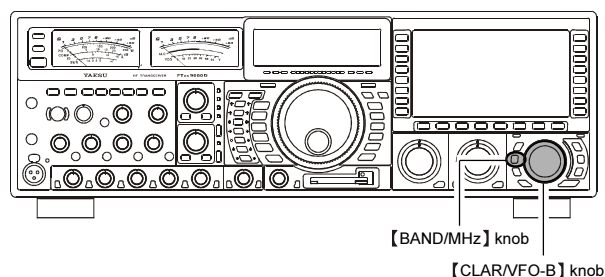
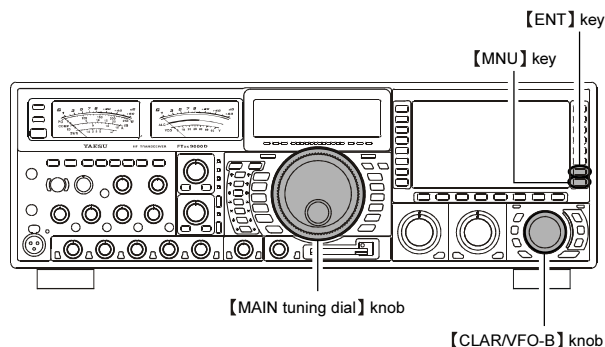

# CONVENIENT FEATURES

## BAND STACK OPERATION

The FT DX 9000D utilizes a triple band-stack VFO selection technique, that permits you to store up to three favorite frequencies and modes onto each band's VFO register. For example, you may store one frequency each on 14 MHz CW, RTTY, and USB, then recall these VFOs by successive, momentary presses of the [14] MHz band key. Each Amateur band key may similarly have up to three frequency/mode settings applied. Both the Main (VFO-A) and Sub (VFO-B) systems have their own, independent, band stacks.

A typical setup, for the 14 MHz band, might be arranged like this:

1. Program 14.0250 MHz, CW Mode, then press the [14] MHz **[BAND]** key (#92);
2. Program 14.080 MHz, RTTY Mode, then press the [14] MHz **[BAND]** key;
3. Program 14.195 MHz, SSB Mode, then press the [14] MHz **[BAND]** key.

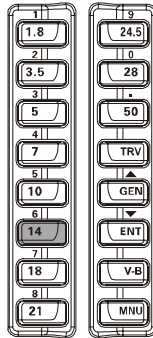

With this configuration, successive momentary presses of the [14] MHz **[BAND]** key will allow you to toggle sequentially through these three VFOs.

BAND Key	Band Stack1		Band Stack2		Band Stack3	
	Frequency (MHz)	MODE	Frequency (MHz)	MODE	Frequency (MHz)	MODE
1.8	1.800000	CW	1.800000	CW	1.800000	CW
3.5	3.500000	LSB	3.500000	LSB	3.500000	LSB
5	5.000000	USB	5.000000	USB	5.000000	USB
7	7.000000	LSB	7.000000	LSB	7.000000	LSB
10	10.100000	CW	10.100000	CW	10.100000	CW
14	14.100000	USB	14.100000	USB	14.100000	USB
18	18.068000	USB	18.068000	USB	18.068000	USB
21	21.000000	USB	21.000000	USB	21.000000	USB
24	24.890000	USB	24.890000	USB	24.890000	USB
28	28.000000	USB	28.000000	USB	28.000000	USB
50	50.000000	USB	50.000000	USB	50.000000	USB
GEN	15.000000	USB	15.000000	USB	15.000000	USB

## DIAL SWAP CONFIGURATION (AF/RF GAIN CONTROLS)

Using the Menu, it is possible to change the **[RF GAIN]** control (for the Main (VFO-A) band) to serve as the Sub (VFO-B) **[AF GAIN]** control. In this case, the Menu Item “GENERAL 038 AF/RF DIAL SWAP” will move the Main (VFO-A) **[RF GAIN]** control function to the knob normally utilized for the Sub (VFO-B) receiver’s **[AF GAIN]** control. In this way, both the Main and Sub receiver **[AF GAIN]** controls will be on the same shaft, as will the two receivers’ **[RF GAIN]** controls, and this may be particularly useful during Dual Receive operation.

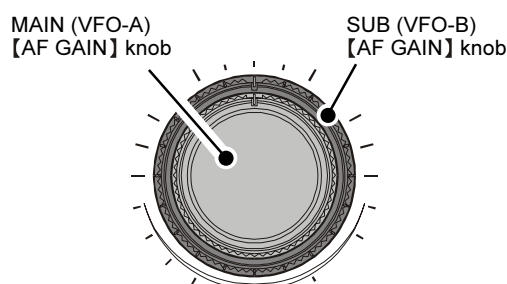
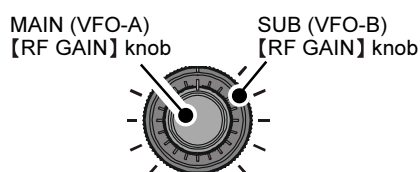
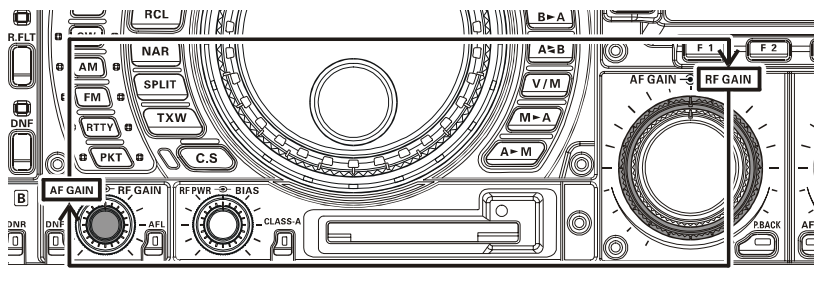

### Dial Swap Setup

1. Press the **[MNU]** key (#92) to engage the Menu mode; the Menu list will appear on the TFT.
2. Rotate the **[Main]** Tuning Dial (#35) to select Menu item “GENERAL 038 AF/RF DIAL SWAP.”
3. Rotate the **[CLAR/VFO-B]** knob (#86) so as to select “SWAP” instead of the factory-default “NORMAL” selection.
4. Press and hold in the **[MNU]** key for two seconds to save the new configuration and exit to normal operation.

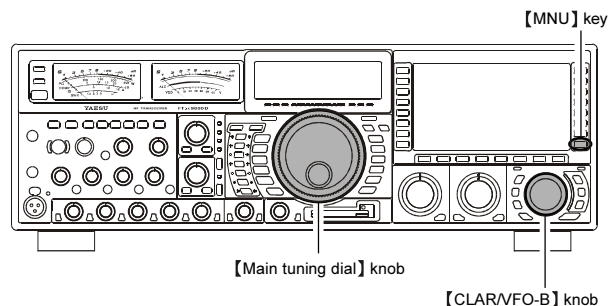

### 『Quick Point』

If the Dial Swap function has been engaged, the Main (VFO-A) **AF GAIN** → **RF GAIN** control (#75) will be reconfigured so that it now operates as **AF GAIN** (MAIN) → **AF GAIN** (SUB); the Sub (VFO-B) band’s **AF GAIN** → **RF GAIN** control (#70) will now be configured as **RF GAIN** (MAIN) → **RF GAIN** (SUB).

# CONVENIENT FEATURES

## C.S (CUSTOM SWITCH)

An often-used Menu mode selection may be brought out to the front panel's **[C.S]** key

### C.S Setup

1. Press the **[MNU]** key (#92) to engage the Menu mode; the Menu list will appear on the TFT.
2. Rotate the Main tuning dial to select the Menu item you want to be able to access via the **[C.S]** key (#41).
3. Press and hold in the **[C.S]** key for two seconds to lock in your selection.
4. Press and hold in the **[MNU]** key for two seconds to save the new configuration and exit to normal operation.

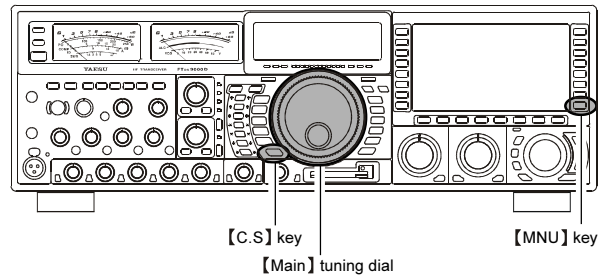

### Menu Selection Recall via **[C.S]** Switch

Press the **[C.S]** switch (#41).

On the TFT, the programmed Menu item will appear. You may now rotate the **[CLAR/VFO-B]** knob (#86) to change the setting of this menu item. Press the **[MNU]** key (#92) for two seconds, when you are done, to save the new configuration and exit to normal operation.

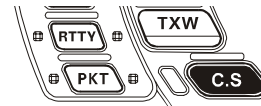
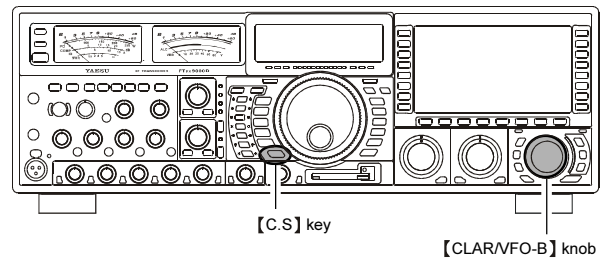



## MORE FREQUENCY NAVIGATION TECHNIQUES

### Keyboard Frequency Entry (#92)

You may enter operating frequencies, for either the Main (VFO-A) or Sub (VFO-B) bands, using the front panel band/frequency selection keys.

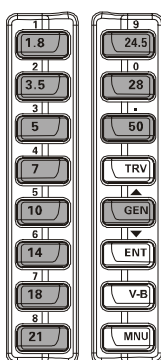

### Example 1:

#### Enter 14.250.00 MHz into the Main (VFO-A) band:

1. Press the [ENT] key to engage the direct frequency entry process. Now, beginning with the “10 MHz” digit of the frequency (the leftmost digit), we will enter the required digits of the frequency.
2. Press, in order, the digits of the operating frequency, using the [BAND] keys (which have the frequency-entry digit or decimal point on the right side of the slash bar). In this example, enter

[1.8/1] → [7/4] → [50/.] → [3.5/2] → [10/5]  
[28/0] → [28/0] → [28/0] → [28/0]

The decimal point after the “MHz” portion of the frequency must be entered, but no decimal point is required after the “kHz” portion.

3. Press the [ENT] key once more. A short “beep” will confirm that the frequency entry was successful, and the new operating frequency will appear on the Main (VFO-A) frequency display fields.

### Example 2:

#### Enter 7.100.000 MHz into the Sub (VFO-B) band:

1. Press the [V/B] key.
2. Press the [ENT] key to engage the direct frequency entry process. Now, beginning with the “10 MHz” digit of the frequency (the leftmost digit), we will enter the required digits of the frequency to be entered into the Sub (VFO-B) band register.
3. Press, in order, the digits of the operating frequency, using the [BAND] keys (which have the frequency-entry digit or decimal point on the right side of the slash bar). In this example, enter

[18/7] → [50/.] → [1.8/1] → [28/0]  
[28/0] → [28/0] → [28/0] → [28/0]

4. Press the [ENT] key once more. A short “beep” will confirm that the frequency entry was successful, and the new operating frequency will appear on the Main (VFO-A) frequency display fields.

### 『Advice』

- In the above examples, you will notice that the trailing “zero” digits of the frequency were not entered. It is not necessary to enter these trailing zeroes; just press the [ENT] to terminate frequency entry, and they will be entered automatically.
- If you attempt to enter a frequency outside the operating range of 30 kHz ~ 60 MHz, the microprocessor will ignore the attempt, and you will be returned to your previous operating frequency. If this happens, please try again, taking care not to repeat the error in the frequency entry process.

- Using the [CLAR/VFO-B] knob (#86), you may change the Main (VFO-A) band frequency in 1 MHz

steps. If you first press and hold in the [BAND/MHz] key for two seconds, the 1 MHz steps will be applied to the Sub (VFO-B) band instead. The imbedded LED in the [BAND/MHz] key will glow Red in the latter case.

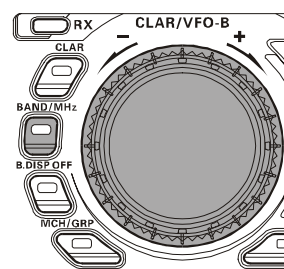

When tuning in 1 MHz steps, clockwise rotation of the [CLAR/VFO-B] knob will increase the frequency, while counter-clockwise rotation will decrease the frequency.

- Using the UP/DOWN switches of the optional MD-200A8X Base Station Microphone

The UP/DOWN switches on the optional MD-200A8X Base Station Microphone may also be used for manually scanning upward or downward in frequency, respectively.

The microphone’s UP/DOWN switches utilize the tuning steps of the [Main] Tuning Dial (#35); moreover, when the microphone’s [FAST] key is pressed, the tuning rate increases by a factor of ten, in a manner similar to the effect of the transceiver’s front-panel [FAST] key.

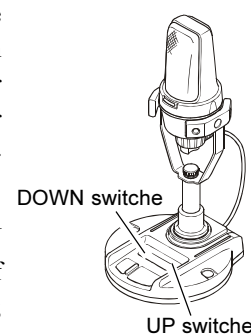

MODE	UP	DWN	FST+UP	FST+DWN
LSB, USB, CW, RTTY, PKT(LSB)	+10Hz	-10Hz	+100Hz	-100Hz
AM, FM, PKT(FM)	+5kHz	-5kHz	+50kHz	-50kHz

### 『Advice』

In the Am and FM modes, you may independently set the tuning steps when using the UP/DOWN switches. To set new tuning steps, use Menu items “TUNING 132 AM CH STEP” and “TUNING 133 FM CH STEP.”

# CONVENIENT FEATURES

## ANTENNA SELECTION

Four main antenna jacks, available for both transmission and reception, are provided on the rear panel of the transceiver. What's more, a receive-only jack is provided, and the incoming signal path may also have a special after-market filter or preamplifier inserted, if desired, with one-touch access.

Selection of the desired TX/RX antenna is accomplished by pressing the appropriate [1] ~ [4] Antenna Selection switch (#9) on the front panel.

To engage the RX-only antenna, press the [RX] switch within the Antenna Selection switch group (#9) on the front panel. The RX-only antenna must be connected to the corresponding "RX ANT" antenna jack on the rear panel.

The antenna currently selected for use on the Main (VFO-A) band will be designated by a Red LED.

The antenna currently selected for use on the Sub (VFO-B) band will be designated by an Orange LED.

If both the Main and Sub bands are utilizing the same antenna, both the Red and Orange LEDs will light up on the same antenna location.

[ANTENNA SELECT] switch

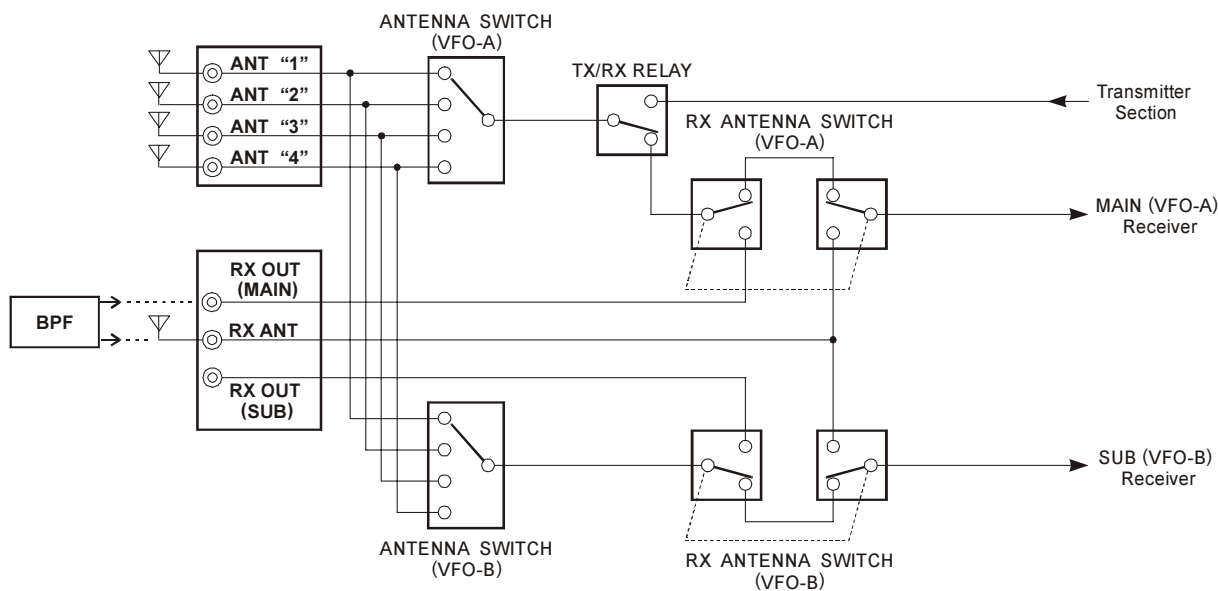
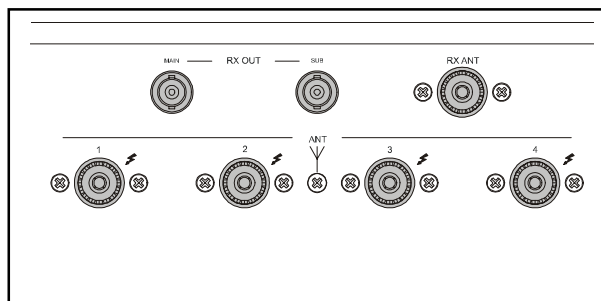
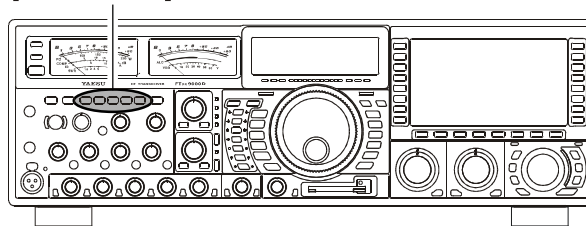

Downloaded by  
RadioAmateur.EU

## CHANGING THE SPEAKER OUTPUT CONFIGURATION

An internal switch, and the menu, allow you to configure the way audio is fed to the two internal speakers (either “stereo” or “monaural” modes are available).

### 『Advice』

At the factory, the audio signals from both the Main and Sub receivers are combined, and the resulting monaural audio takes advantage of the combined aperture of the two speakers. For most operation, this configuration results in beautiful audio reproduction, and is to be preferred. If you wish to leave the speaker setup as is, you may skip the remainder of this section.

		SPEAKER SELECT SWITCH	
		COM	SEP
MENU SELECTION 77 SPEAKER MIX	COMBINE	Main (VFO-A) and Sub (VFO-B) audio will be mixed in the two internal speakers.	Main (VFO-A) and Sub (VFO-B) audio will be mixed but heard only from the “A” internal speaker.
	SEPARATE	Main (VFO-A) audio will be heard from internal speaker “A.” For listening to audio from the Sub (VFO-B) receiver, connect an external speaker to rear-panel terminal “B.”	Main (VFO-A) audio will be heard from internal speaker “A,” and Sub (VFO-B) audio will be heard from internal speaker “B.”

With respect to the switch on the Speaker Unit, the left position is 【SEP】 and the right position is 【COM】.

### Speaker Selection Switch Configuration

1. Set the front panel’s Main Power switch to the Off (“O”) position to turn the radio off.
2. Turn the rear panel Power switch off, and unplug the AC cable from the rear-panel [~AC IN] jack.
3. Remove the eight screws from the left and right faces of the outer case, then remove the three remaining screws that are affixing the top case, and remove the top case from the transceiver.
4. Refer to the illustration, and change the position of the speaker selection switch (the default setting is “COM” which combines the audio; “SEP” separates the Main and Sub receiver audio into the Left and Right speakers).
5. Replace the three screws on the top case, then replace the eight screws previously removed from the left and right sides of the transceiver.
6. Speaker re-configuration is now complete. You may now plug in the AC cable, and turn the rear panel and front panel Power switches back on (in that order), to resume operation.

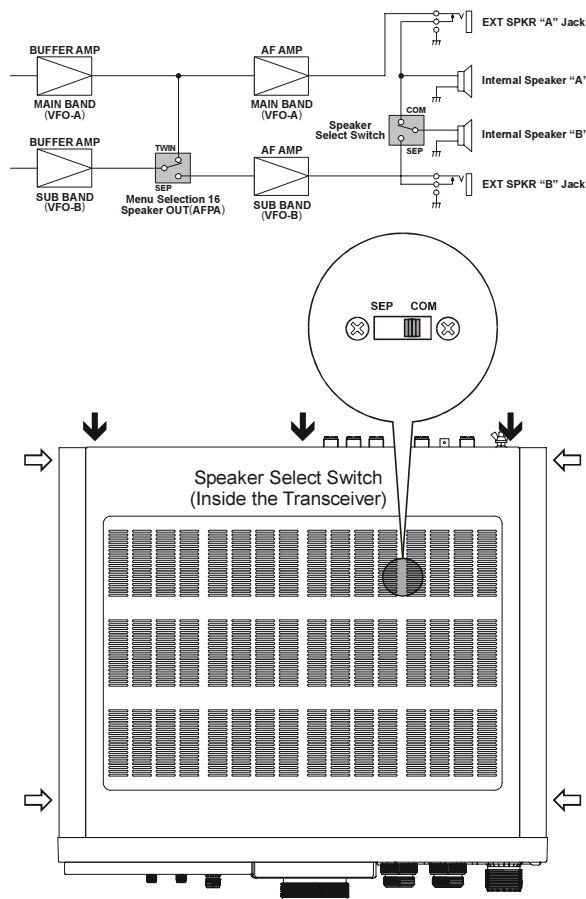

### 『Quick Point』

#### High-Quality Internal Speaker Details!

Two large-aperture, high quality speakers are incorporated into the FT DX 9000D, for outstanding reproduction of the incoming audio signals. Sporting a combined aperture of 7” (184 mm), the twin 3-5/8” (92 mm) speakers are designed to enhance your operating experience with their rich tonal quality and ultra-low distortion characteristics.

# CONVENIENT FEATURES

## RECEIVER OPERATION (FRONT END BLOCK DIAGRAM)

The FT DX 9000D includes a wide range of special features to suppress the many types of interference that may be encountered on the HF bands. However, real world interference conditions are constantly changing, so optimum setting of the controls is somewhat of an art, requiring familiarity with the types of interference and the subtle effects of some of the controls. Therefore, the following information is provided as a general guideline for typical situations, and a starting point for your own experimentation.

The FT DX 9000D's interference-fighting circuitry begins in its "RF" stages, and continues throughout the entire receiver section. The FT DX 9000D allows configuration of the features described below independently on the main band (VFO-A) and sub band (VFO-B), except for the  $\mu$ -TUNE (Narrow-bandwidth High-Q RF Filter) feature; the sub band (VFO-B) receiver does not have provision for a  $\mu$ -TUNE module or modules.

### $\mu$ -Tune Filters (See page 64)

The  $\mu$ -Tune filters provide ultra-sharp RF selectivity on the 1.8 ~ 14 MHz Amateur bands on the Main (VFO-A) receiver. Automatic tuning of the  $\mu$ -Tune filters is provided via a precision motor drive.

### VRF (See page 66)

On the 18 MHz and higher Amateur bands on the Main (VFO-A) receiver, and on all Amateur bands on the Sub (VFO-B) receiver, Yaesu's powerful VRF (Variable RF Filter) preselector circuit provides excellent suppression of out-of-band interference, with a passband much narrower than that provided by traditional fixed bandpass filters.

### R. FLT (IF Roofing Filters) (See page 67)

Three automatically-selected Roofing filters, in bandwidths of 15 kHz, 6 kHz, and 3 kHz, are provided in the 40 MHz First IF, right after the first mixer. These filters provide narrow-band selectivity to protect the following IF and DSP stages, and the filters' automatically-selected bandwidths may be manually changed by the operator, if desired, for special operating circumstances.

### CONTOUR Filter (See page 68)

The Contour filter is a unique capability of the FT DX 9000D, providing either nulling or peaking of tunable segments of the receiver passband, so as to suppress interference or excessive frequency components on an incoming signal, or to peak those tunable frequency segments. The amount of nulling/peaking, and the bandwidth over which it is applied, are adjustable via the Menu.

### IF SHIFT (See page 69)

The passband center frequency response of the IF DSP filtering may be adjusted using this control.

### IF WIDTH (See page 70)

The width of the IF DSP filtering may be carried using this control.

### IF NOTCH (See page 71)

The IF Notch filter is a high-Q notch filter that can significantly reduce, if not eliminate, an interfering carrier. The Q (sharpness) of the filter may be adjusted using the Menu, and the exact tuning of the filter may be monitored visually using the Audio Scope page on the TFT (especially useful is the "Waterfall" display).

### DNR (Digital Noise Reduction) (See page 72)

The DSP's Digital Noise Reduction (DNR) feature utilizes sixteen different mathematical algorithms to analyze and suppress different noise profiles encountered on the HF/50 MHz bands. Choose the selection that provides the best noise suppression, which concurrently will allow the signal to rise up out of the noise.

### DNF (Digital Notch filter) (See page 74)

When multiple interfering carriers are encountered during reception, the Digital Notch Filter can significantly reduce the level of these signals.

### AGC (See page 75)

The AGC system is highly adaptable to changing signal and fading characteristics, making reception possible under the most difficult conditions.

### SLOPED AGC (See page 76)

The Sloped AGC system, instead of clamping a fixed upper bound on audio output across a wide range of input signals, actually allows the audio output to rise, very gently, with ever-increasing signal strength. This capability allows you to separate signals, using your brain, according to signal strength in addition to slight frequency differences.

### IF Filter Quality Adjustment (See page 140)

The "Q" (quality factor) of the IF DSP filters may be adjusted independently for the Main (VFO-A) and Sub (VFO-B) receiver IF DSP filters, using the Menu.

### Variable IF Filter Shape Factor (See page 140)

You may adjust the shape factor of the Main (VFO-A) and Sub (VFO-B) receiver IF DSP filters, using the Menu.

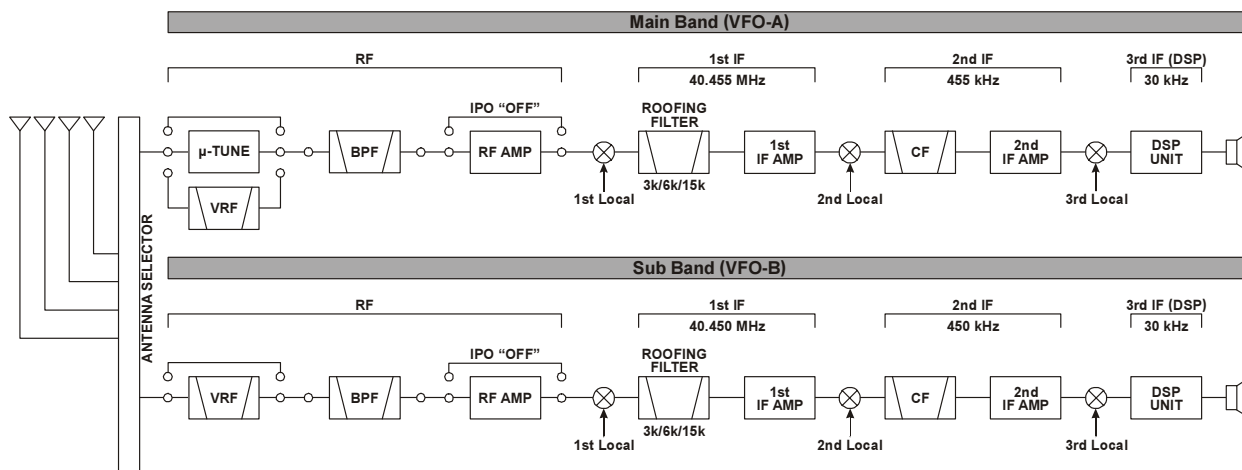

## IPO (INTERCEPT POINT OPTIMIZATION)

Normally, the front-end FET RF amplifiers provide maximum sensitivity for weak signals. During typical conditions on lower frequencies (where strong signals and high noise are common), the RF amplifiers can be bypassed by pressing the **[IPO]** button so that the button's illumination is lit. This improves the IMD (intermodulation distortion) rejection characteristics of the receiver, with only a slight reduction of sensitivity. On frequencies below about 10 MHz, you generally will want to keep the **[IPO]** button engaged at all times, as the preamplifiers are usually not needed at these frequencies unless you are using a Beverage or other lossy receive antenna.

### 『Quick Note』

The FT DX 9000D's first mixer is an active type, using four SST310 Junction FETs. This mixer design provides gain to the receiver chain, so the noise figure of the receiver is fundamentally lower than with some other designs. Therefore, it frequently is not necessary to utilize the RF preamplifier, and the receiver Intercept Point will be substantially increased by engaging IPO, so as to feed the incoming signals directly to the first (active) mixer. We recommend that IPO be switched on whenever possible.

### Main (VFO-A) IPO Setup

Press the Main (VFO-A) side's **[A-IPO]** switch key (#8) to engage the IPO on the Main (VFO-A) band.

A Red LED imbedded in the switch will light up, and the preamplifier for the Main (VFO-A) receiver will be bypassed. The system gain and sensitivity will be reduced.

To cancel IPO operation and restore full system gain and sensitivity, press the **[A-IPO]** key once more.

### SUB(VFO-B) IPO Setup

Press the Sub (VFO-B) side's **[B-IPO]** switch key (#8) to engage the IPO on the Sub (VFO-B) band.

An Orange LED imbedded in the switch will light up, and the preamplifier for the Sub (VFO-B) receiver will be bypassed. The system gain and sensitivity will be reduced.

To cancel IPO operation and restore full system gain and sensitivity, press the **[B-IPO]** key once more.

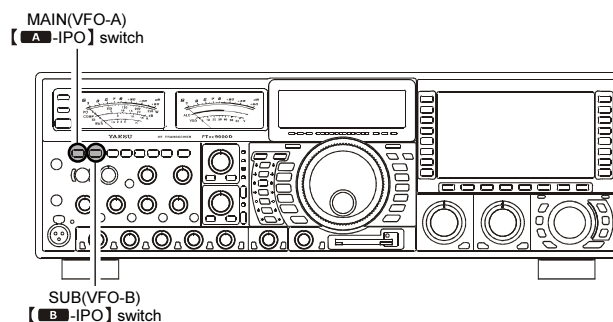

# CONVENIENT FEATURES

## ATT

Even with the IPO function on, extremely strong local signals or high noise can still degrade reception. In such situations, you can use the **【ATT】** knob to insert 3, 6, 12, or 18-dB of RF attenuation in front of the RF amplifier.

### Main (VFO-A) Attenuator Setup

Rotate the Main (VFO-A) side's **【ATT】** switch (#14) to set the desired attenuation level, per the chart below.

To restore full signal strength through the Attenuator circuit area, set the **【ATT】** switch to the "0" position.

### Sub (VFO-B) Attenuator Setup

Rotate the Sub (VFO-B) side's **【ATT】** switch (#59) to set the desired attenuation level, per the chart below.

To restore full signal strength through the Attenuator circuit area, set the **【ATT】** switch to the "0" position.

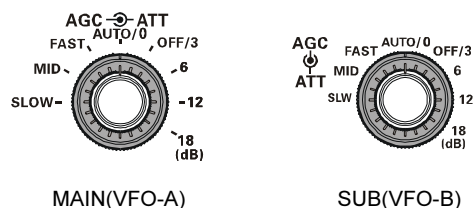
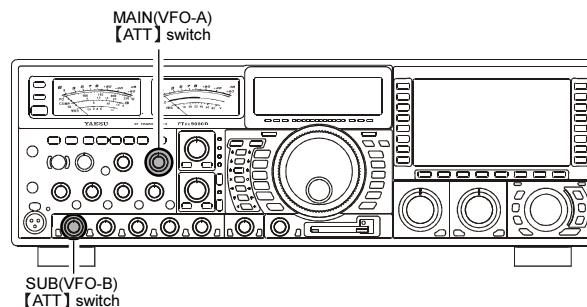

0 dB	Attenuator is Off
3 dB	The incoming signal power is reduced by 3 dB (signal voltage reduced by 1/1.4)
6 dB	The incoming signal power is reduced by 6 dB (signal voltage reduced by 1/2)
12 dB	The incoming signal power is reduced by 12 dB (signal voltage reduced by 1/4)
18 dB	The incoming signal power is reduced by 18 dB (signal voltage reduced by 1/8)

### 『Advice』

If background noise causes the S-meter to deflect on clear frequencies, turn the **【ATT】** knob clockwise until the S-meter drops to about "S-1." This setting optimizes the trade-offs between sensitivity, noise, and interference immunity. Also, once you have tuned in a station you want to work, you may want to reduce sensitivity further (or add more attenuation) by turning the **【ATT】** knob to a more clockwise setting. This reduces the strength of all signals (and noise) and can make reception more comfortable, important especially during long QSOs.

When looking for weak signals on a quiet band, you will want maximum sensitivity, so the IPO should be disabled and the **【ATT】** knob should be set to "0." This situation is typical during quiet times on frequencies above 21 MHz, and when using a small or negative-gain receiving antenna on other bands.



## RF GAIN (SSB/CW/AM MODES)

The RF Gain controls provide manual adjustment of the gain levels for the receiver RF and IF stages, to account for noise and/or signal strength conditions at the moment.

### Main (VFO-A) RF Gain Adjustment

The Main (VFO-A) **【RF GAIN】** control (#75) should, initially, be rotated to the fully clockwise position. This is the point of maximum sensitivity, and counter-clockwise rotation will gradually reduce the system gain.

- As the **【RF GAIN】** control is rotated counterclockwise to reduce the gain, the S-meter reading will rise. This indicates that the AGC voltage being applied to the receiver (to reduce the gain) is increasing.
- Rotating the **【RF GAIN】** control to the fully counterclockwise position will essentially disable the receiver, as the gain will be greatly reduced. In this case, as well, the S-meter will appear to be “pegged” against the right edge of the analog S-meter scale.
- The sub (VFO-B) receiver’s **【RF GAIN】** control (#70) operates identically to the Main (VFO-A) band **【RF GAIN】** control. The effects of counter-clockwise rotation of the Sub receiver’s **【RF GAIN】** control may be observed visually on the Sub (VFO-B) band S-meter.

### 『Advice』

Reception frequently can be optimized by rotating the RF Gain control slightly counter-clockwise to the point where the incoming noise level is just about the same as the “stationary” meter needle position as set by the adjustment of the **【RF GAIN】** control. This setting ensures that excessive gain is not being utilized, without so much gain reduction that incoming signals cannot be heard.

### 『Quick Point』

The RF Gain control, along with the IPO and Attenuator features, all affect the system receiver gain in different ways. As a first step in dealing with high noise or a crowded, high-level signal environment, the IPO generally should be the first feature engaged, if the frequency is low enough to allow the preamplifier to be bypassed. Thereafter, the RF Gain and Attenuator features may be employed to provide precise, delicate adjustment of the receiver gain so as to optimize performance fully.

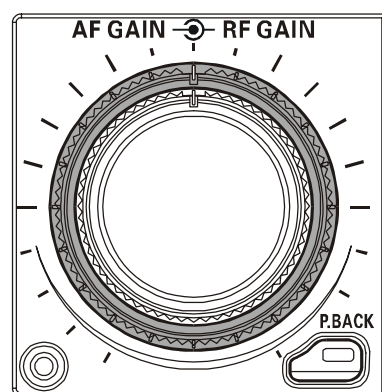
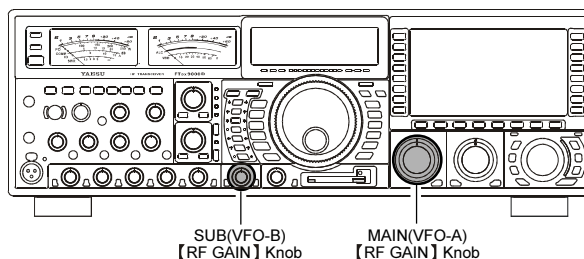

MAIN (VFO-A)

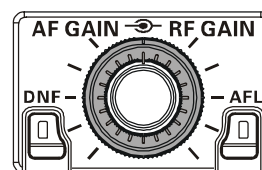

SUB (VFO-B)

# ADVANCED INTERFERENCE-SUPPRESSION FEATURES: RF FRONT END

The FT DX 9000D includes an unmatched array of RF selectivity-enhancing features. Please study the material below carefully, so as to understand the various features complete.

## USING THE $\mu$ -TUNE FEATURE

The  $\mu$ -Tune system is an advanced preselector for the RF front end of the Main (VFO-A) receiver, providing a much narrower passband than the VRF circuit. The Q of the  $\mu$ -Tune filter is so tight as to provide significant suppression of signals little more than 10 kHz away from your current operating frequency, and manual adjustment of the  $\mu$ -Tune filter's center frequency allows you to position the shoulder of the filter in such a way as to enhance interference rejection to one side or another of your current frequency. Because the insertion loss of the  $\mu$ -Tune is somewhat higher than that of the VRF, we have also provided the capability to disengage  $\mu$ -Tune, and engage VRF, should your antenna and noise environment lead to system noise figure concerns when using  $\mu$ -Tune. The FT DX 9000D's Main (VFO-A) band receiver is equipped with  $\mu$ -Tune modules covering the 1.8 ~ 14 MHz Amateur bands. On the 18 ~ 50 MHz bands on the Main (VFO-A) receiver, and on all bands on the Sub (VFO-B) side, the VRF circuit is provided.

### $\mu$ -Tune Operation on the Main (VFO-A) Receiver

1. Press the **[VRF/ $\mu$ -T]** switch (#23). The imbedded Red LED will light up.
  - The  $\mu$ -Tune circuit will automatically align itself onto your operating frequency.
  - Remember that  $\mu$ -Tune only operates on the Main (VFO-A) band on the 14 MHz and lower bands.
2. Now rotate the **[VRF/ $\mu$ -T]** knob (#24) to peak the response (background noise) or reduce interference.
  - A pictorial representation of the tuning position of the  $\mu$ -Tune filter will appear on the bar graph on the TFT.
  - The amount of change in the center frequency of the  $\mu$ -Tune filter, when rotating the **[VRF/ $\mu$ -T]** knob by one click, can be configured using Menu item "GENERAL 035  $\mu$ TUNE DIAL STEP."
  - If you have performed manual adjustment of the  $\mu$ -Tune filter's center frequency, you may press and hold in the **[VRF/ $\mu$ -T]** key for two seconds to re-center the filter response on your current operating frequency.
3. Press the **[VRF/ $\mu$ -T]** switch (momentarily) once more to disengage the  $\mu$ -Tune filter; the imbedded Red LED will switch off. In this mode, only the fixed bandpass filter for the current band will be engaged.

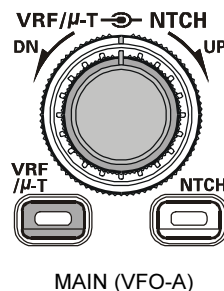
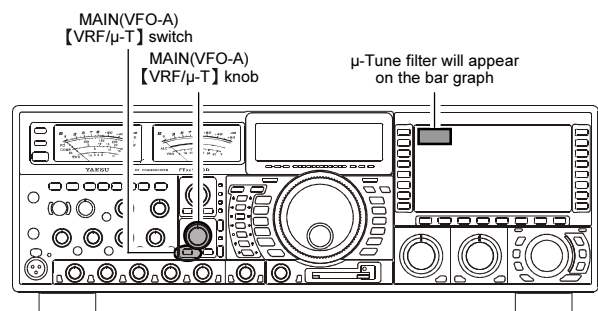

μ-Tune filter will appear on the bar graph

### 『Quick Note』

The permeability-tuning concept utilized in the  $\mu$ -Tune circuit dates back many decades, as it was incorporated in such classic transceivers as the FT-101 and FT-901 series, in addition to the FT DX 400 and similar models. The  $\mu$ -Tune circuit in the FT DX 9000D is the highest development of this circuit concept ever employed in an Amateur transceiver.

### 『Advice』

- The  $\mu$ -Tune filters are the most advanced, selective RF preselector filters ever incorporated into an Amateur Radio transceiver. The RF selectivity provided by  $\mu$ -Tune can be of tremendous value in ensuring quiet, intermod-free reception even in the most crowded bands on a contest weekend. The  $\mu$ -Tune filters provide RF selectivity on the order of a few dozen kHz at -6 dB, at the expense of a few dB of system gain on bands where noise figure is seldom an issue. You will notice that the S-meter deflection, when  $\mu$ -Tune is engaged, is slightly less than when it is out of the circuit; this is normal. If your antenna system gain is so low as to make it impossible to hear band noise when  $\mu$ -Tune is engaged (highly unlikely), just switch it out or revert to the VRF system, which has slightly less insertion loss.
- As you tune around on an amateur band with  $\mu$ -Tune engaged, the microprocessor automatically commands the stepper motor driving the toroid core stack to center the filter on your current operating frequency. You may, however, use the **[VRF/ $\mu$ -T]** knob (#24) to skew the filter response to one side or the other from your operating frequency, to deal with heavy interference on one side. To re-center the  $\mu$ -Tune filter on your operating frequency, and eliminate any offset, press and hold in the **[VRF/ $\mu$ -T]** switch (#23) for two seconds.
- A pictorial representation of the tuning position of the  $\mu$ -Tune filter will appear on the bar graph on the TFT.
- While  $\mu$ -Tune is a superior RF preselection circuit, it may be disabled via the Menu; if this is done, the VRF circuit will engage when the **[VRF/ $\mu$ -T]** switch is pressed. To disable  $\mu$ -Tune, go to Menu item "GENERAL 035  $\mu$ TUNE DIAL STEP" and set the selection to "OFF."

## USING THE $\mu$ -TUNE FEATURE

### $\mu$ -Tune and VRF: Comparisons to Fixed Bandpass Filters

#### $\mu$ -Tune

Inspection of the illustrations to the right will demonstrate the profound advantage of the  $\mu$ -Tune circuit. In illustration [A], the gray area represents the passband of a typical fixed bandpass filter covering the 1.8 ~ 3 MHz range; this is typical of the kind of bandpass filter found in many high-quality HF receivers today. Note also the hypothetical distribution of signals across the 160-meter band.

In illustration [B], note the narrow white segment within the gray passband of the fixed BPF. This narrow segment represents the typical bandwidth of the  $\mu$ -Tune filter, and one can see that the passband has been reduced from about 750 kHz (in the case of the fixed BPF) to a few dozen kHz when  $\mu$ -Tune is engaged. The vast majority of the incoming signals are outside the passband of the high-Q  $\mu$ -Tune filter, and they will not impinge on any of the RF/IF amplifiers, the mixers, or the DSP. Very strong out-of-band signals like this can cause Intermodulation, blocking, and an elevated noise floor for a receiver.

#### VRF

In this example, illustration [a] depicts a typical fixed bandpass filter covering 14.5 to 22 MHz, and once again the gray shaded area depicts the fixed bandpass filter's frequency coverage. The vertical lines in the illustration, once again, represent hypothetical signals throughout this frequency range.

Figure [b] shows the same fixed BPF, with the white area representing the typical passband of the VRF filter operating in the same frequency range. Although the selectivity of the VRF is not as tight as that of the  $\mu$ -Tune filter, the RF selectivity of the VRF preselector is still magnitudes better than that of the usual fixed bandpass filter, affording significant protection against the ingress of high signal voltage from strong out-of-band signals.

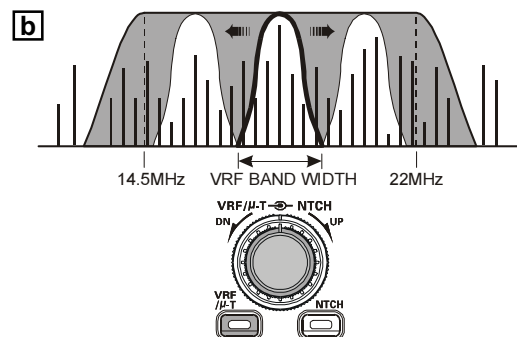
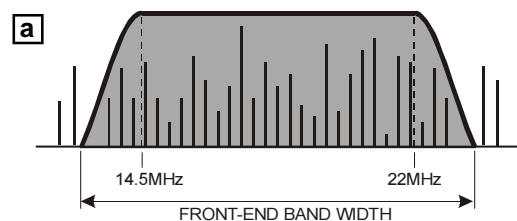
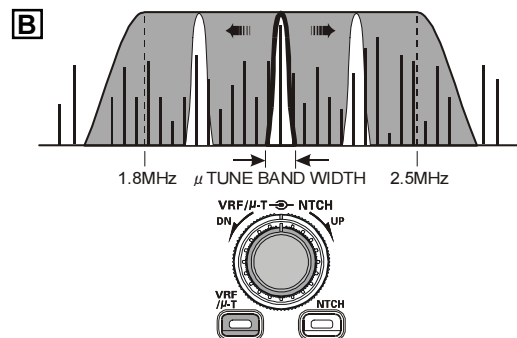
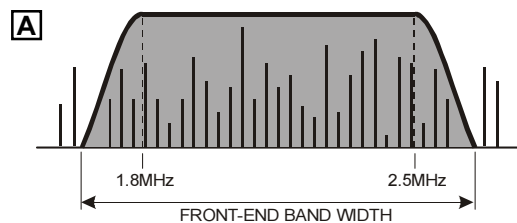

#### 『Advice』

With  $\mu$ -Tuning, the center frequency of the filter is continuously adjustable throughout its operating range, and the quality L/C components ensure a tight passband due to the high Q of the circuit. The RF preselection design task involves not only the selection of quality L/C components, but the crafting of a tuning mechanism and tuning concept that preserves system Q (thus assuring a tight bandwidth) while providing a wide operating frequency range and consistent, automated tuning. The smooth tuning is achieved by varying the inductance over a wide range; this is accomplished by motor-driving a large 1.1" (28 mm) ferrite core stack through a 2" high (50 mm) coil structure. Three  $\mu$ -Tune modules provide coverage of the 1.8, 80/40, and 30/20 meter bands on the FT DX 9000D, and the Q of this circuit, being over 300, yields unmatched RF selectivity for outstanding rejection of undesired signals.

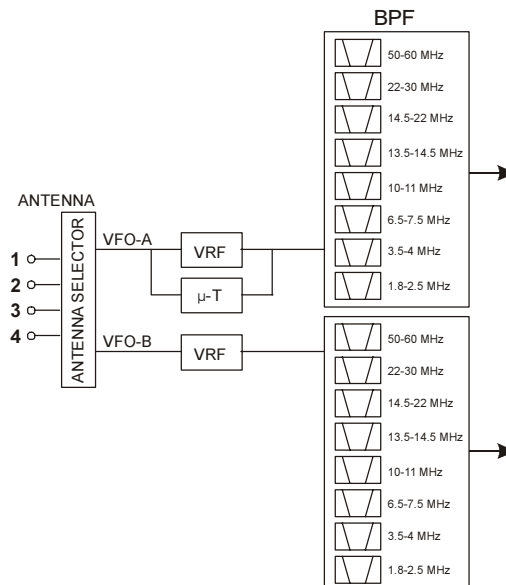

# ADVANCED INTERFERENCE-SUPPRESSION FEATURES: RF FRONT END

## USING THE VRF (VARIABLE RF FRONT-END FILTER)

The VRF system is a high-performance RF front-end preselector that has lower Q and lower insertion loss than the  $\mu$ -Tune circuit. VRF provides outstanding rejection of out-of-band signals, and if low gain in your antenna system causes insertion loss to be a critical factor, you may wish to use VRF, instead of  $\mu$ -Tune, on the bands below 14 MHz.

### VRF on the Main (VFO-A) Band Frequency

1. Press the **[VRF/ $\mu$ -T]** switch (#23) momentarily. The LED inside the switch will become illuminated, and the VRF system will be engaged, centered on your current Amateur band.
2. You may rotate the **[VRF/ $\mu$ -T]** knob (#24) to skew the position of the VRF system relative to your operating frequency. Because the VRF system is relatively broad, although still much narrower than the fixed bandpass filter, you may not hear much difference in the background noise or signal quality when you make minor adjustments. However, if you have receiving problems associated by a very strong signal, rotation of the **[VRF/ $\mu$ -T]** knob may help reduce the strength of the interfering station, allowing improved reception of the desired signal.
  - After moving the passband of the VRF system manually, you may re-center it on the current Amateur band by pressing and holding in the **[VRF/ $\mu$ -T]** switch for two seconds.
  - To switch VRF off, press the **[VRF/ $\mu$ -T]** switch momentarily again. The LED imbedded in the switch will go out, and the VRF circuit will be removed from the incoming received signal path.

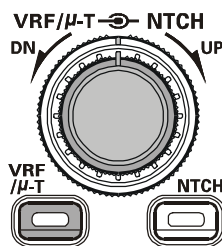
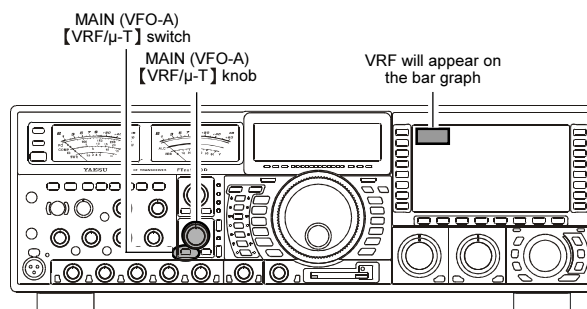

MAIN (VFO-A)



VRF will appear on the bar graph

### Using VRF on the Sub (VFO-B) Band Frequency

1. Press the Sub (VFO-B) **[RX]** switch (#89) to engage Dual Receive operation.
2. Press the Sub (VFO-B) band's **[VRF]** switch (#60) to engage the VRF. The LED imbedded in the switch will light up, confirming that VRF is now in the signal path for the Sub (VFO-B) receiver.
  - The settings of the VRF are set and held in memory independently for each Amateur band, so any custom settings will be maintained despite any band changes you perform.
3. Rotation of the **[VRF]** knob (#61) allows adjustment of the center frequency of the VRF circuit.
  - If you have made adjustments to the VRF circuit's center frequency, press and hold in the **[VRF/ $\mu$ -T]** button for two seconds to re-center the VRF on the center of the Amateur band on which you currently are operating.
  - To switch VRF off, press the **[VRF/ $\mu$ -T]** switch momentarily again. The LED imbedded in the switch will go out, and the VRF circuit will be removed from the Sub (VFO-B) receiver's incoming signal path.

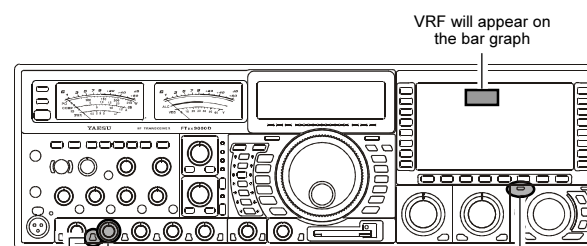

SUB (VFO-B) [VRF] switch

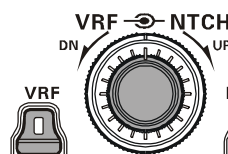

SUB (VFO-B)



VRF will appear on the bar graph

### 『Quick Point』

The VRF filter, utilizing high-quality coils and capacitors that provide high Q, yields a passband that is approximately 20% to 30% the width of a traditional, fixed bandpass filter. As a result, significantly more unwanted signal rejection is provided. Within each Amateur band, 64 adjustment steps are provided (50 MHz: 8 steps), if you wish to skew the response in a particular direction so as to enhance interference rejection even more.

# INTERFERENCE REJECTION (SIGNALS OFF FREQUENCY BY JUST A FEW KHZ)

## R.FLT (ROOFING FILTERS)

Narrow-band Roofing Filters of 15 kHz, 6 kHz, and 3 kHz bandwidths are provided in the first IF, right after the first mixer. These filters provide protection for the 2nd mixer, DSP, and other circuitry that follow and can dramatically improve reception on a very crowded band (during a contest, etc.). Typically, the AUTO selection mode is satisfactory for most operating situations, but in an extremely crowded phone band you may wish to select, for example, the 3 kHz roofing filter for SSB operation.

### Main Band Roofing Filter Operation

Press the Main (VFO-A) band's **[R.FLT]** switch (#27) to toggle the Roofing Filter selection.

AUTO → 15 kHz → 6 kHz → 3 kHz → AUTO

- As you repeatedly press this switch, you will observe different LEDs lighting up in the Roofing Filter area of the front panel, denoting the Roofing Filter currently in use. Also, the selected Roofing Filter bandwidth will be indicated on the TFT.
- Typically, this selection will be set to "AUTO."
- The Roofing Filter selection will be memorized independently on each VFO in the VFO stack.

### Sub (VFO-B) Band Roofing Filter Operation

1. Pressing the Sub (VFO-B) band's **[RX]** switch will engage Dual Receive operation.

When the imbedded LED grows green, this is your confirmation that Dual Receive is in operation.

2. Press the Sub (VFO-B) band's **[R.FLT]** switch (#58) to toggle the Roofing Filter selection.

AUTO → 15 kHz → 6 kHz → 3 kHz → AUTO

- As you repeatedly press the **[RX]** switch (#58), the selected bandwidth will appear on the TFT.
- Typically, this selection will be set to "AUTO."
- When "AUTO" is selected, the LED imbedded in the switch will go out (there always is a roofing filter in the receiver path).
- The Roofing Filter selection will be memorized independently on each VFO in the VFO stack.

### 『Quick Point』

- The "AUTO" selection of the Roofing Filter is based on the operating mode. However, you may override the automatic selection, if band conditions warrant a different (usually, a tighter) selection.
- The AUTO mode Roofing Filter selections are shown below:

AM/FM/FM-PKT	15 kHz
LSB/USB/PKT	6 kHz
CW/RTTY	3 kHz

- When the Roofing filter mode is set to "AUTO" and the Noise Blanker is turned On, the Roofing Filter bandwidth will automatically be set to 15 kHz, as this setting provides the most effective noise blanking. However, you still may override the automatic setting, and select a more narrow Roofing Filter. Noise blanking may be compromised, however, with a tighter Roofing Filter in the line.

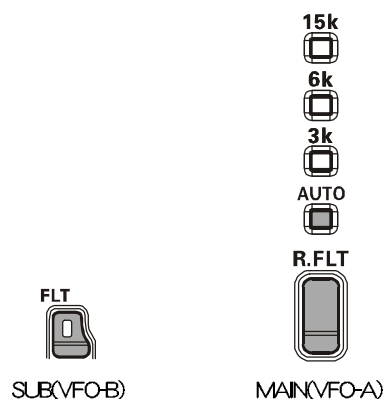
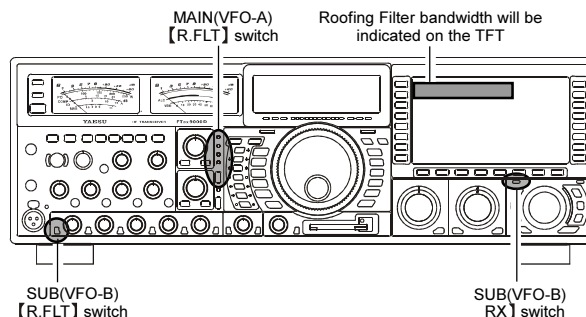

Roofing Filter bandwidth will be indicated on the TFT



Roofing Filter bandwidth will be indicated on the TFT

### 『Terminology』

A "Roofing Filter," as its name implies, places a "Roof" over the receiver's IF system bandwidth. This "Roof" protects the circuitry downstream from the first mixer from interference, just as a roof on a house protects the contents from rain and snow.



# INTERFERENCE REJECTION (SIGNALS WITHIN 3 KHZ)

## CONT (CONTOUR) CONTROL OPERATION

The Contour filtering system provides a gentle perturbation of the IF filter passband, so as to suppress or enhance certain frequency components modestly, so as to enhance the natural-sounding received signal.

### Using Contour on the Main (VFO-A) Receiver

1. Press the Main (VFO-A) **【CONT】** switch (#30). The LED imbedded in the switch will glow Red to confirm that the Contour filter is engaged.
2. Rotate the Main (VFO-A) **【CONT】** knob (#29) to achieve the most natural-sounding audio reproduction on the incoming signal. To cancel Contour tuning, press the Main (VFO-A) **【CONT】** switch once more.

### Using Contour on the Sub (VFO-B) Receiver

1. Pressing the Sub (VFO-B) band's **【RX】** switch will engage Dual Receive operation. When the imbedded LED grows green, this is your confirmation that Dual Receive is in operation.
2. Press the Sub (VFO-B) **【CONT】** switch (#66). The LED imbedded in the switch will glow Orange, confirming that the Contour filter is engaged.
3. Rotate the Sub (VFO-B) **【CONT】** knob (#67) to achieve the most natural-sounding audio reproduction on the incoming signal. To cancel Contour tuning, press the Sub (VFO-B) **【CONT】** switch once more.

### Advice

- The TFT's Audio Scope (on the "Oscilloscope" page) is particularly useful when adjusting the Contour control. Not only can you see the effect of the notch/peak of the Contour system, but you also can see the position of the notch/peak with respect to frequency components of interest on the incoming signal. You may then observe (on the Audio Scope) the effect of the Contour control while listening to the effect on the signal, and this will help build your intuition on how best to use Contour tuning in the future.
- The Width of the Contour filter effect, and the degree of nulling or peaking, may be adjusted using the menu.
  - The Contour filter's level (either nulling or peaking) may be adjusted using Menu Item "RX DSP 078 MAIN-CONTOUR-LEVEL" for Main (VFO-A) Band and "RX DSP 080 SUB-CONTOUR-LEVEL" for Sub (VFO-B) Band. The factory default setting is -15.
  - The bandwidth over which the Contour filter effect is applied may be adjusted using Menu Item "RX DSP 079 MAIN-CONTOUR-WIDTH" for Main (VFO-A) Band and "RX DSP 081 SUB-CONTOUR-WIDTH" for Sub (VFO-B) Band. The factory default setting is 10.

Downloaded by  
RadioAmateur.EU

### Quick Point

The steep slopes of the DSP filtering can, when adjusted aggressively, impart an unnatural sound to an incoming signal. Oftentimes, though, a narrow bandwidth is not the key to improving copy; the incoming signal itself may have undesirable or excessive frequency components, especially in the low-frequency range around 400 Hz. By judicious use of the Contour filter, the "shoulder" of the passband response may be altered, or components removed from within the passband, allowing the desired signal to rise above the background noise and interference in a manner not obtainable with other filtering systems.

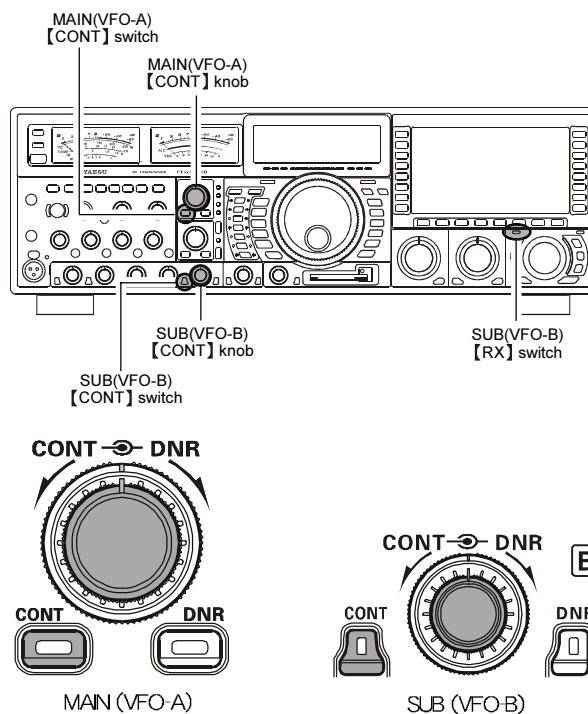

With reference to Figure (B), note the initial position (12 o'clock) of the **【CONT】** control when the **【CONT】** switch is pushed. You may observe the "indentation" in the receiver passband where the Contour filter is placing a low-Q "notch" (per the setting of Menu #078, referenced above). Counter-clockwise rotation (to the left) of the Contour knob causes the indentation to move toward a lower frequency within the passband, while clockwise rotation (to the right) causes the indentation to move toward a higher frequency within the passband. By removing interference or unwanted frequency components on the incoming signal, it is possible to make the desired signal rise out of the background noise/interference, enhancing intelligibility.

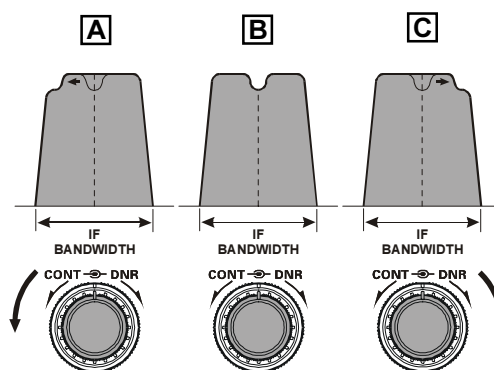



# INTERFERENCE REJECTION (SIGNALS WITHIN 3 KHZ)

## IF SHIFT OPERATION (SSB/CW/RTTY/PKT/AM MODES)

IF Shift allows you to vary the DSP filter passband higher or lower, without changing the pitch of the incoming signal, so as to reduce or eliminate interference. Because the carrier tuning frequency is not varied, there is no need to re-tune the operating frequency when eliminating the interference. The total passband tuning range for the IF Shift system is  $\pm 1$  kHz.

### Main (VFO-A) Band IF Shift Operation

Rotate the Main (VFO-A) band's **【SHIFT】** (#78) control to the left or right to reduce the interference.

### Sub (VFO-B) Band IF Shift Operation

1. Press the Sub (VFO-B) band's **【RX】** switch (#80) to engage Dual Receive operation.
2. Rotate the Sub (VFO-B) band's **【SHIFT】** (#65) control to the left or right to reduce the interference.

### 『Advice』

The position of the IF Shift system may be observed on the TFT.

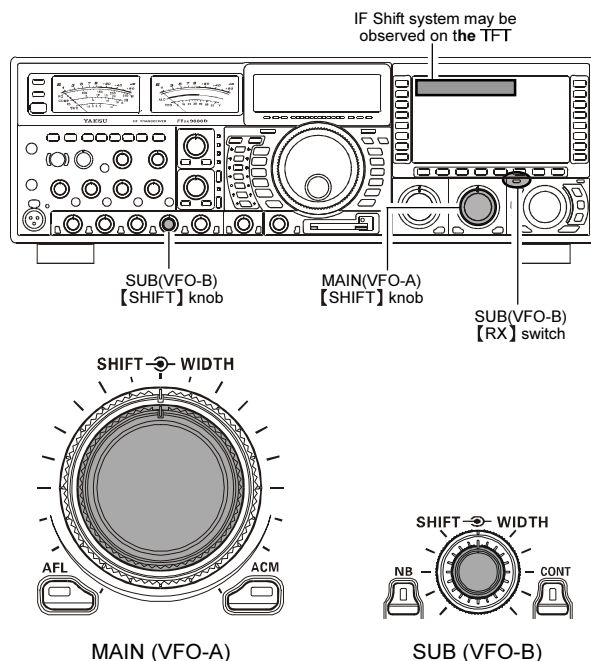

MAIN(VFO-A)  
IF Shift system may be observed on the TFT



SUB(VFO-B)  
IF Shift system may be observed on the TFT

Referring to Figure (A), note the depiction of the IF DSP filter as the thick line, with the **【SHIFT】** control in the 12 o'clock position. In Figure (B), an interfering signal has appeared inside the original passband. In Figure (C), you can see the effect of rotating the **【SHIFT】** control so as to reduce the interference level by moving the filter passband so that the interference is outside of the passband.

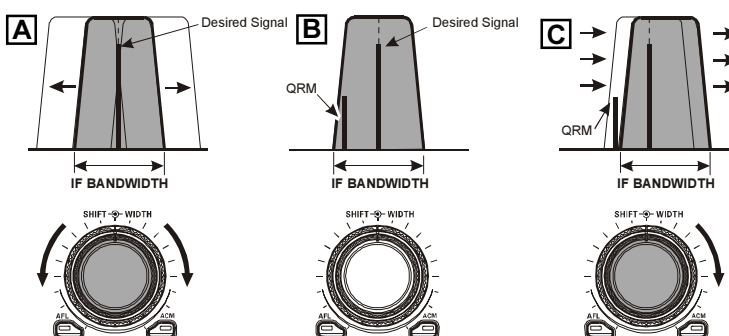

# INTERFERENCE REJECTION (SIGNALS WITHIN 3 KHZ)

## WIDTH (IF DSP BANDWIDTH) TUNING (SSB/CW/RTTY/PKT MODES)

The IF Width tuning system allows you to vary the width of the DSP IF passband, so as to eliminate interference. Moreover, the bandwidth may actually be expanded from its default setting, should you wish to enhance incoming signal fidelity when interference on the band is low.

### Main (VFO-A) Band IF Width Operation

Rotate the Main (VFO-A) **[WIDTH]** knob (#78) to adjust the bandwidth. Counter-clockwise rotation reduces the bandwidth, while clockwise rotation increases the bandwidth.

### Sub (VFO-B) Band IF Width Operation

1. Press the Sub (VFO-B) band's **[RX]** switch to engage Dual Receive operation.
2. Rotate the Sub (VFO-B) **[WIDTH]** knob (#65) to adjust the bandwidth. Counter-clockwise rotation reduces the bandwidth, while clockwise rotation increases the bandwidth.

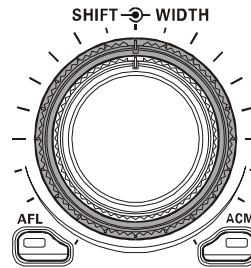
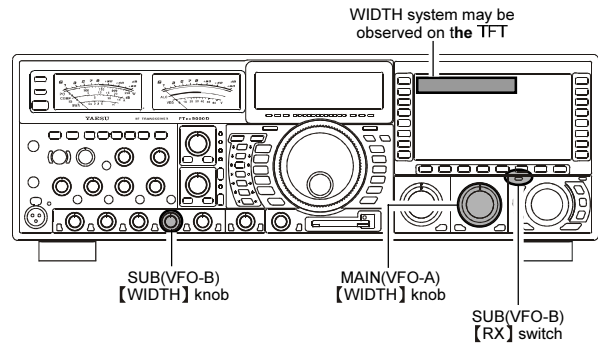

MAIN (VFO-A)

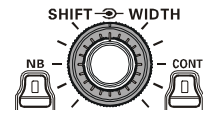

SUB (VFO-B)

Referring to Figure B, you can see the default bandwidth with the **[WIDTH]** control set to the 12 o'clock position.

By rotating the **[WIDTH]** knob to the left, the bandwidth will narrow (see Figure (A)), while rotation of the **[WIDTH]** knob to the right, as depicted in Figure (C), will widen the bandwidth. The default bandwidths, and total bandwidth adjustment range, will vary according to the operating mode:

#### SSB Mode

200 Hz ~ 4.0 kHz (bandwidth at 12 o'clock position of **[WIDTH]**: 2.4 kHz).

#### CW/RTTY/PKT Modes

25 Hz ~ 2.4 kHz (bandwidth at 12 o'clock position of **[WIDTH]**: 500 Hz).

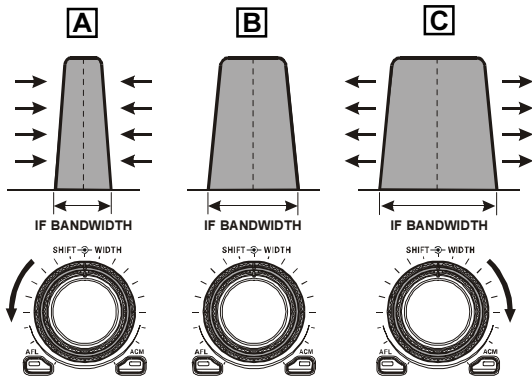

MAIN(VFO-A) WIDTH (BW) ctrl may be observed on the TFT



SUB(VFO-B) WIDTH (BW) ctrl may be observed on the TFT



### 『Advice』

You may observe the effects of adjustment of the **[WIDTH]** control on the TFT.

### Using IF Shift and Width Together

The IF Shift and Variable IF Width features together form a very effective interference-fighting filtering system.

For example, in Figure (A) you can see how interference has appeared both on the high and low sides of the desired signal. By rotating the **[WIDTH]** control, as shown in Figure (B), the interference from one side can be eliminated, and by re-positioning the **[SHIFT]** control (Figure (C)), the interference on the opposite side can be removed, without re-introducing the interference previously eliminated in Figure (B).

### 『Advice』

For best interference reduction, the Width and Shift features are the primary tools you should use. After narrowing the bandwidth (Width) and/or adjusting the center of the passband (Shift), the Contour control may also yield additional signal-enhancement benefits on the net residual bandwidth. What's more, the IF Notch Filter (see the next section) may also be utilized, in conjunction with the three other filter systems, to significant advantage.

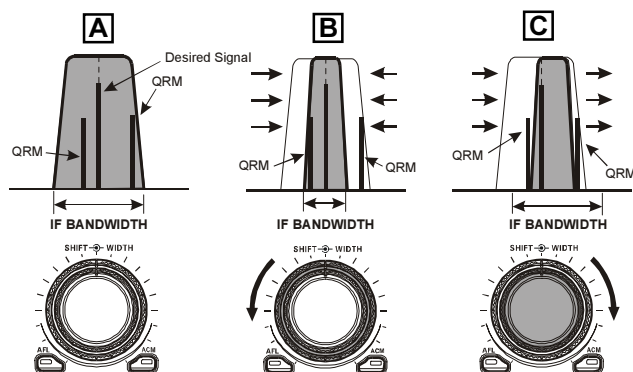

# INTERFERENCE REJECTION (SIGNALS WITHIN 3 KHZ)

## IF NOTCH FILTER OPERATION (SSB/CW/RTTY/PKT/AM MODES)

The IF Notch filter is a highly-effective system that allows you to slice out an interfering beat note or other carrier signal from inside the receiver passband.

### Main (VFO-A) Band IF Notch Operation

1. Press the Main (VFO-A) band **[NOTCH]** switch (#25).  
The LED imbedded in the switch will glow Red to confirm that the IF Notch filter has been engaged.
2. Rotate the Main (VFO-A) band's **[NOTCH]** knob (#24) to null out the interfering carrier.

To switch the IF Notch filter off, press the Main (VFO-A) band's **[NOTCH]** switch once more. The LED imbedded in the switch will turn off, confirming that the IF Notch filter is no longer operating.

### Sub (VFO-B) Band IF Notch Operation

1. Press the Sub (VFO-B) band's **[RX]** switch (#80) to engage Dual Receive operation.
2. Press the Sub (VFO-B) band **[NOTCH]** switch (#62).  
The LED imbedded in the switch will glow Orange to confirm that the IF Notch filter has been engaged.
3. Rotate the Sub (VFO-B) band's **[NOTCH]** knob (#61) to null out the interfering carrier.

To switch the IF Notch filter off, press the Sub (VFO-B) band's **[NOTCH]** switch once more. The LED imbedded in the switch will turn off, confirming that the IF Notch filter is no longer operating.

### 『Advice』

- The effect of the IF Notch filter may be observed on the Audio Scope of the TFT (on the “Oscilloscope” page). The Notch will be observed as a “dip” in the noise platform observed. What's more, the “Waterfall” display may be used to observe the effect of the IF Notch filter, which will appear as a white area in the colored background area. The tuning rate for the IF Notch is somewhat slow, allowing precise adjustment, so the use of the Waterfall display to confirm proper adjustment is highly recommended.
- The width of the IF Notch null may be adjusted using Menu Item “RX DSP 082 IF-NOTCH-WIDTH.” Both “Wide” and “Narrow” selections are available, with “Narrow” providing the least disruption of the “desired” signal.
- Under the frequency display, you may also use the Bar Display to show the position of the IF Notch. Use Menu Item “DISPLAY 016 BAR DISPLAY SELECT” to engage this function.

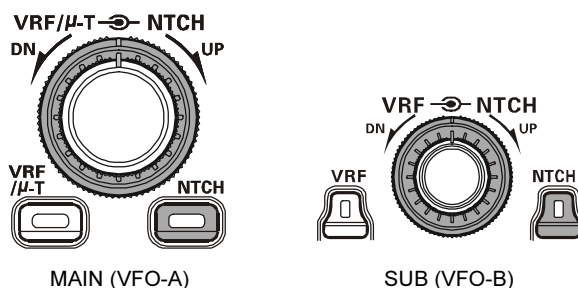
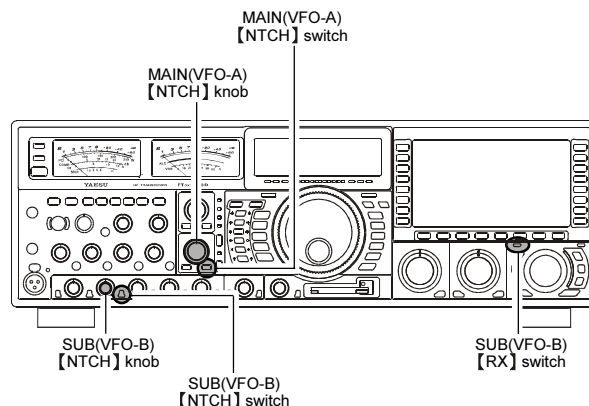

### 『Note』

When the **[NOTCH]** switch is pressed and held in for two seconds, the center of the notch action will be reset to the positions described below (mode-sensitive):

SSB/AM: The Notch will center at 1.5 kHz (center of the receiver passband).

CW: The Notch will center on the frequency programmed by the **[PITCH]** knob (#13).

The performance of the IF Notch filter is shown in Figure (A), where the effect of rotation of the **[NOTCH]** knob is depicted. In Figure (B) you can see the notching effect of the IF Notch filter as you rotate the **[NOTCH]** knob to eliminate the incoming interference.

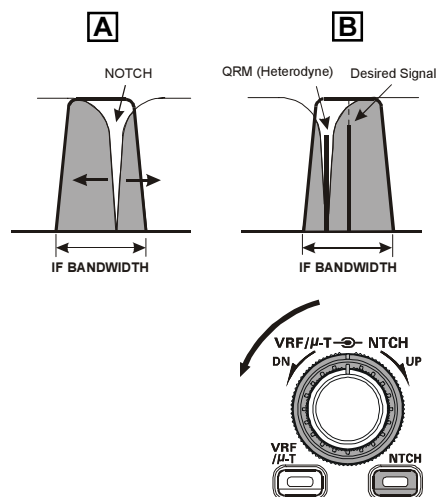

# INTERFERENCE REJECTION (SIGNALS WITHIN 3 KHZ)

## DIGITAL NOISE REDUCTION (DNR) OPERATION

The Digital Noise Reduction (DNR) system is designed to reduce the level of random noise found on the HF and 50 MHz bands, and it is especially effective during SSB operation. By rotating the **[DNR]** knob, any of sixteen different noise-reduction algorithms can be selected; each of these algorithms was create for dealing with a different noise profile, and you will want to experiment with the DNR system to find the best setting according to the noise currently being experienced.

### Main (VFO-A) Band DNR Operation

1. Press the Main (VFO-A) band's **[DNR]** switch (#28). The LED imbedded in the switch will glow Red, confirming that the DNR system is engaged.
2. Rotate the Main (VFO-A) band's **[DNR]** knob (#29) to select the setting that most effectively reduces the noise level.

To disable the DNR system, press the Main (VFO-A) band's **[DNR]** switch once more. The imbedded LED will turn off, confirming that the DNR system is not active.

### Sub (VFO-B) Band DNR Operation

1. Press the Sub (VFO-B) band's **[RX]** switch (#80) to engage Dual Receive operation.
2. Press the Sub (VFO-B) band's **[DNR]** switch (#68). The LED imbedded in the switch will glow Orange, confirming that the DNR system is engaged.
3. Rotate the Sub (VFO-B) band's **[DNR]** knob (#67) to select the setting that most effectively reduces the noise level.

To disable the DNR system, press the Sub (VFO-B) band's **[DNR]** switch once more. The imbedded LED will turn off, confirming that the DNR system is not active.

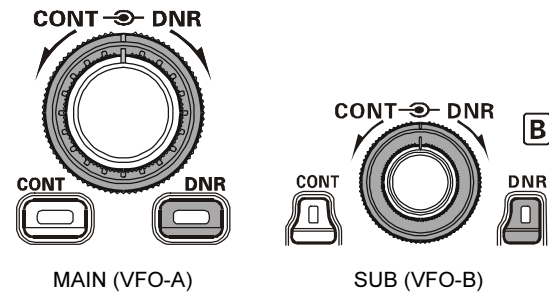
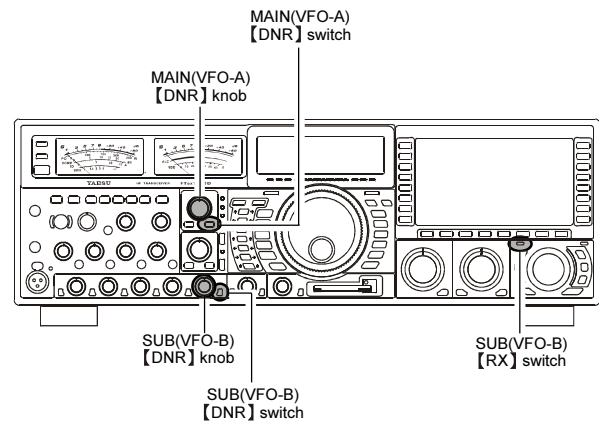

# INTERFERENCE REJECTION (SIGNALS WITHIN 3 KHZ)

## NARROW (NAR) ONE-TOUCH IF FILTER SELECTION

Pressing the **[NAR]** switch provides one-touch, mode-specific selection of a narrow IF DSP filter setting that does not depend on the setting of the Width control. Pressing the **[NAR]** switch once more returns the bandwidth control to the Width/Shift system. The factory default bandwidths are:

### SSB Mode

Pressing the **[NAR]** switch (#38) selects a bandwidth of 1.8 kHz.

### CW/RTTY/PKT Modes

Pressing the **[NAR]** switch (#38) selects a bandwidth of 300 Hz.

### AM Mode

Pressing the **[NAR]** switch (#38) selects a bandwidth of 6 kHz.

### FM Mode (28/50 MHz Bands)

Pressing the **[NAR]** switch (#38) selects a bandwidth of 9 kHz.

### 『Advice』

- The bandwidth applied when the **[NAR]** switch is pressed may be adjusted using the Menu. This allows you to customize a quick-switch “Narrow” bandwidth matching your operating needs (in examples below the default setting is underlined).

### SSB

Main (VFO-A)

**RX DSP 094 MAIN-SSB-NARROW**

200/400/600/850/1100/1350/1500/  
1650/1800/1950/2100/2250 Hz

Sub (VFO-B)

**RX DSP 106 SUB-SSB-NARROW**

200/400/600/850/1100/1350/1500/  
1650/1800/1950/2100/2250 Hz

### CW

Main (VFO-A)

**RX DSP 085 MAIN-CW-NARROW**

25/50/100/200/300/400 Hz

Sub (VFO-B)

**RX DSP 097 SUB-CW-NARROW**

25/50/100/200/300/400 Hz

### PSK

Main (VFO-A)

**RX DSP 088 MAIN-PSK-NARROW**

25/50/100/200/300/400 Hz

Sub (VFO-B)

**RX DSP 100 SUB-PSK-NARROW**

25/50/100/200/300/400 Hz

### RTTY

Main (VFO-A)

**RX DSP 91 MAIN-RTTY-NARROW**

25/50/100/200/300/400 Hz

Sub (VFO-B)

**RX DSP 103 SUB-RTTY-NARROW**

25/50/100/200/300/400 Hz

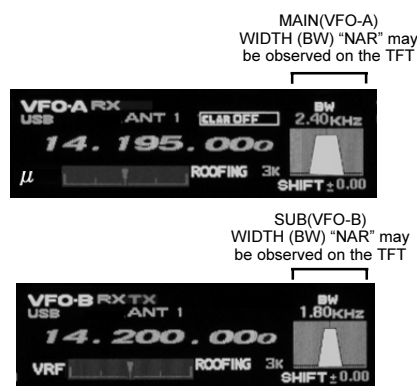
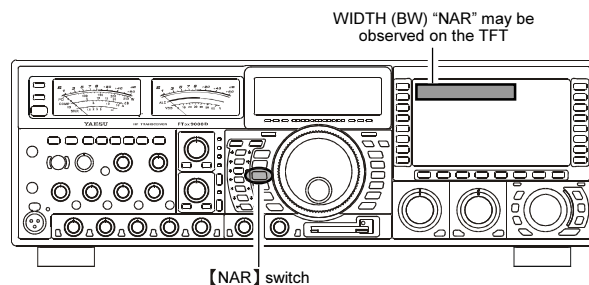

### 『Advice』

- When the **[NAR]** button has been pushed so as to engaged the narrow filter, the Width control will be disabled, but IF Shift still is operational. For many applications, you may find that simple adjustment of the **[WIDTH]** control, instead of engaging the Narrow filter, may be satisfactory for interference reduction.
- When you press the **[NAR]** button in the FM mode, both the transmit and receive bandwidths are narrowed.

### 『Note』

When the **[NAR]** button is pressed, the **[WIDTH]** control no longer functions.



# INTERFERENCE REJECTION (SIGNALS WITHIN 3 KHZ)

## DIGITAL NOTCH FILTER (DNF) OPERATION

The Digital Notch Filter (DNF) is an effective beat-cancelling filter that can null out a number of interfering beat notes inside the receiver passband. Because this is an Auto-Notch feature, there is no adjustment knob associated with this filter.

### 『Advice』

If a very strong interfering carrier is encountered, we recommend you first use the IF Notch filter, as it is the most effective notching tool in the receiver section.

### Main (VFO-A) Band DNF Operation

Press the Main (VFO-A) band's **【DNF】** switch (#26) to engage the Digital Notch filter. The LED imbedded in the switch will glow Red, to confirm that the DNF circuit is engaged.

To cancel DNF operation, press the Main (VFO-A) band's **【DNF】** switch once more. The imbedded LED will go out, confirming that the Digital Notch Filter is no longer in operation.

### Sub (VFO-B) Band DNF Operation

1. Press the Sub (VFO-B) band's **【RX】** switch (#80) to engage Dual Receive operation.
2. Press the Sub (VFO-B) band's **【DNF】** switch (#69) to engage the Digital Notch filter. The LED imbedded in the switch will glow Red, to confirm that the DNF circuit is engaged.

To cancel DNF operation, press the Sub (VFO-B) band's **【DNF】** switch once more. The imbedded LED will go out, confirming that the Digital Notch Filter is no longer in operation.

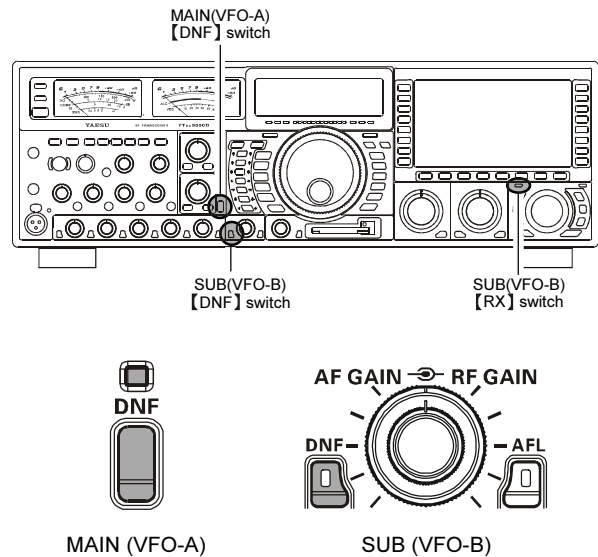



# INTERFERENCE REJECTION (SIGNALS WITHIN 3 KHZ)

## IF NOISE BLANKER (NB) OPERATION

The FT DX 9000D includes an effective IF Noise Blanker, which can significantly reduce noise caused by automotive ignition systems.

### Main (VFO-A) Band NB Operation

1. Press the Main (VFO-A) band's **【NB】** switch (#22) momentarily to reduce a short pulse noise such as from switching transients, automobile ignitions and power lines. The LED imbedded in the switch will glow Red to confirm that the Narrow-NB is operating. Press and hold the Main (VFO-A) band's **【NB】** switch for two seconds to reduce a longer duration man-made pulse noise. The LED imbedded in the switch will glow Yellow to confirm that the Wide-NB is operating.
2. Advance the Main (VFO-A) band's **【NB】** control (#21) to the point where the offending ignition noise is best reduced or eliminated.

To end Noise Blanker operation, press the Main (VFO-A) band's **【NB】** switch once more. The LED imbedded in the switch will turn off, confirming that the Noise Blanker is no longer in operation.

### Sub (VFO-B) Band NB Operation

1. Press the Sub (VFO-B) band's **【RX】** switch (#80) to engage Dual Receive operation.
2. Press the Sub (VFO-B) band's **【NB】** switch (#64) momentarily to reduce a short pulse noise such as from switching transients, automobile ignitions and power lines. The LED imbedded in the switch will glow Umber to confirm that the Narrow-NB is operating. Press and hold the Sub (VFO-B) band's **【NB】** switch (#64) switch for two seconds to reduce a longer duration man-made pulse noise. The LED imbedded in the switch will glow Yellow to confirm that the Wide-NB is operating.
3. Advance the Sub (VFO-B) band's **【NB】** control (#63) to the point where the offending ignition noise is best reduced or eliminated.

To end Noise Blanker operation, press the Sub (VFO-B) band's **【NB】** switch once more. The LED imbedded in the switch will turn off, confirming that the Noise Blanker is no longer in operation.

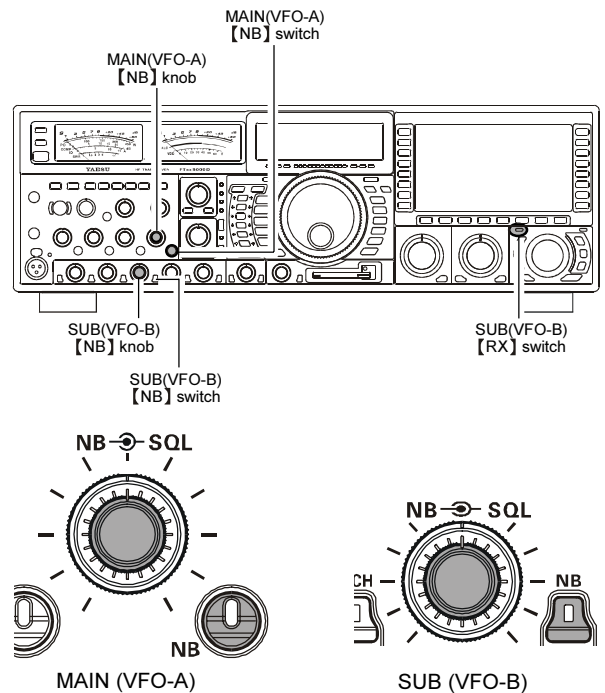

### 『Advice』

When the Roofing filter mode is set to “AUTO” and the Noise Blanker is turned On, the Roofing Filter bandwidth will automatically be set to 15 kHz.

# TOOLS FOR COMFORTABLE AND EFFECTIVE RECEPTION

## AGC (AUTOMATIC GAIN CONTROL)

The AGC system is designed to help compensate for fading and other propagation effects, with characteristics that can be of particular value on each operating mode. The basic objective of AGC is to maintain a constant audio output level once a certain minimum threshold of signal strength is achieved.

### Main (VFO-A) Band AGC Selection

Rotate the Main (VFO-A) band's **【AGC】** switch (#14) to select the desired receiver-recovery time constant. For most operation, we recommend the "AUTO" mode.

### Sub (VFO-B) Band AGC Selection

1. Press the Sub (VFO-B) band's **【RX】** switch (#80) to engage Dual Receive operation.
2. Rotate the Sub (VFO-B) band's **【AGC】** switch (#59) to select the desired receiver-recovery time constant.

Rotation of the **【AGC】** switch allows selection of the desired receiver-recovery time constant. Normally, the "AUTO" selection is satisfactory for most situations, but in the event of operation on a crowded band where you wish to receive a weak signal, you may wish to change the setting (to FAST, for example). The AUTO mode selections are:

Operation Mode	AUTO AGC Selection
LSB	SLOW
USB	SLOW
CW	FAST
AM	FAST
FM	FAST
RTTY	SLOW
PKT(FM)	FAST
PKT(LSB)	SLOW

### 『Advice』

If the **【AGC】** switch is set to the "Off" position, the S-meter will no longer deflect. Additionally, you will likely encounter distortion on stronger signals, as the IF amplifiers and the following stages are probably being overloaded.

### 『Quick Point』

Several aspects of AGC performance may be configured via the Menu. However, because AGC can have such a profound impact on overall receiver performance, we generally do not recommend any changes to the AGC Menu selections.

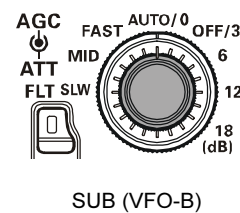
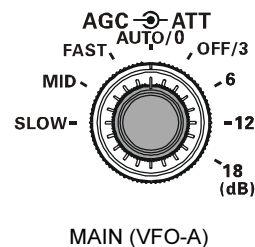
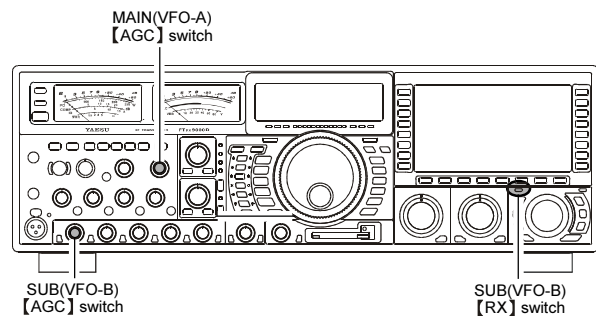

### 『Terminology』

Automatic Gain Control, or AGC, is a circuit that senses the incoming signal strength, and then limits the gains of the RF and IF stages so as to keep the output audio volume at a more-or-less constant level. AGC also protects the RF, IF, Audio, and DSP stages from overload, as it limits the signal strength that is allowed to flow, irrespective of the input signal level.

# TOOLS FOR COMFORTABLE AND EFFECTIVE RECEPTION

## AGC (AUTOMATIC GAIN CONTROL)

### SLOPED AGC Operation

In traditional AGC systems, the audio output from the transceiver becomes essentially fixed once the threshold for AGC action is reached (usually several dozen dB above the no-signal noise floor). The FT DX 9000D, however, includes an innovative Sloped AGC system, that allows the audio volume to rise and fall slightly according to signal strength. Although the rise/fall are not dramatic, they are sufficient to allow you to use your ear to discern and separate signals according to signal strength, not just audio frequency.

#### Using Sloped AGC

1. To the bottom right side of the TFT, press the **【MNU】** (Menu) key (#92) momentarily to enter the Menu mode; the Menu will appear on the TFT.
2. Use the **【Main】** Tuning Dial (#35) to select Menu Item “RX AUDIO 075 AGC-SLOPE.”
3. Rotate the **【CLAR/VFO-B】** knob (#86) to change the setting to “SLOPE.”
4. Press and hold in the **【MNU】** key for two seconds to save the new setting and exit to normal operation. You will now be using the Sloped AGC system.

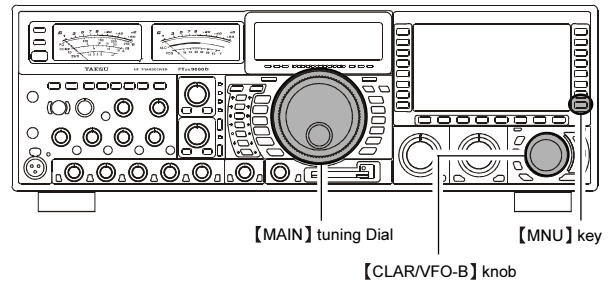
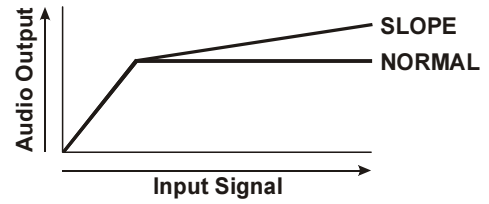

# TOOLS FOR COMFORTABLE AND EFFECTIVE RECEPTION

## MUTE FEATURE MAIN (VFO-A) BAND

There may be occasions, during Dual Receive operation, when you want to silence the Main (VFO-A) receiver temporarily so as to concentrate on what's being received on the Sub (VFO-B) receiver. The Mute feature makes this simple to accomplish.

Press the Main (VFO-A) band's **[RX]** LED/switch (#33).

The Main (VFO-A) receiver will be silenced, and the green LED in the **[RX]** switch will blink. To restore reception on the Main (VFO-A) receiver, just press the blinking **[RX]** switch/LED once more.

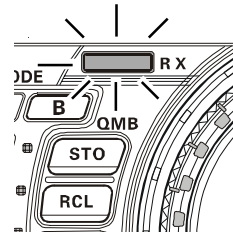
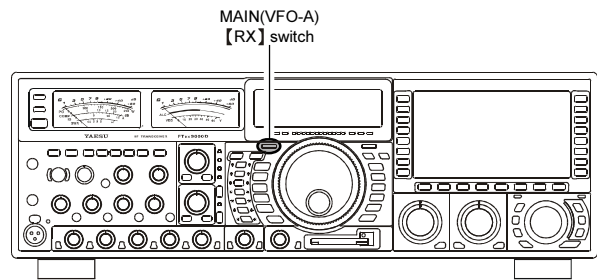

## AUDIO LIMITER (AFL) FEATURE

Particularly when the AGC is off, you may desire to limit the level of audio output that is permitted to flow to the speaker or earphones. For these circumstances, the AFL (Audio Limiter) feature will provide the desired cap on the audio output.

### Main (VFO-A) Band AFL Setup

Press the Main (VFO-A) band's **[AFL]** switch (#77) to turn on the Audio Limiter. The imbedded LED in the button will glow red. To disable the Audio limiter, press the **[AFL]** switch once more; the imbedded LED will turn off.

### 『Advice』

Because the AFL feature will generally reduce the overall audio level, we recommend that it be left Off unless special operating conditions warrant its use.

### Sub (VFO-B) Band AFL Setup

1. Press the Sub (VFO-B) band's **[RX]** switch to engage Dual Receive operation.
2. Press the Sub (VFO-B) band's **[AFL]** switch (#77) to turn on the Audio Limiter. The imbedded LED in the button will glow red. To disable the Audio limiter, press the **[AFL]** switch once more; the imbedded LED will turn off.

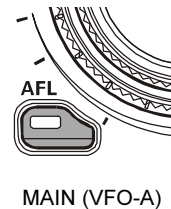
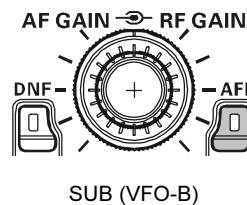
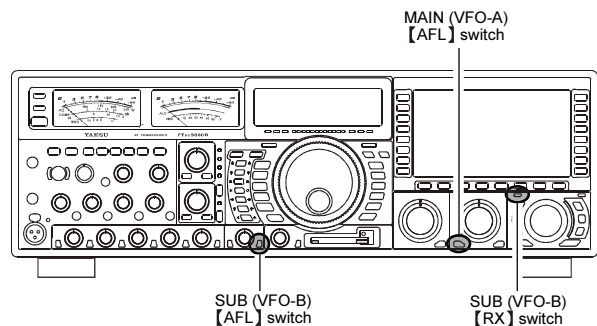

Downloaded by  
RadioAmateur.EU

# TOOLS FOR COMFORTABLE AND EFFECTIVE RECEPTION

## ADJACENT CHANNEL MONITOR (ACM) CW MODE ONLY

While operating on CW on the Main (VFO-A) band, the ACM feature provides a visual indicator of encroachment by another station (someone you may not be able to hear because of the tight DSP filter in your FT DX 9000D). The presence of a nearby strong signal will be displayed on the Sub-receiver's S-meter. The Sub (VFO-B) receiver is taken over by the ACM, when engaged, and reception on the Sub (VFO-B) band is not possible while ACM is turned on.

To activate the Adjacent Channel Monitor, press the **[ACM]** switch (#79). The LED imbedded in the switch will glow Red.

### 『Advice』

- If you do not have Dual Receive engaged, turning on the ACM feature will cause the **[RX]** LED associated with the Sub (VFO-B) receiver to become illuminated.
- When ACM is turned on, the frequency of the Sub (VFO-B) receiver will automatically be set to match that of the Main (VFO-A) receiver.
- When operating on Dual Receive, engaging the ACM feature automatically sets the Sub (VFO-B) receiver to the same frequency as the Main (VFO-A) receiver, and by inverting the DSP filter the Sub receiver is used for monitoring (visually) for activity outside your current receiver passband on the Main receiver.

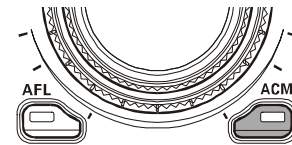
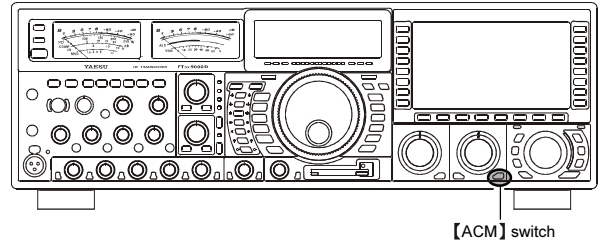

When ACM is turned on during Dual Receive operation, the audio from the Sub (VFO-B) receiver will disappear. A typical operating circumstance where ACM can help is when you are running stations during a contest in a 250 Hz bandwidth. If stations suddenly stop calling you, it may be because another strong station has started calling CQ near your frequency. By engaging ACM, your Sub-receiver S-meter will display the strongest station on the area  $\pm 1.2$  kHz from your current operating frequency; if the encroaching station is sufficiently close, you might want to ask him or her kindly to QSY.

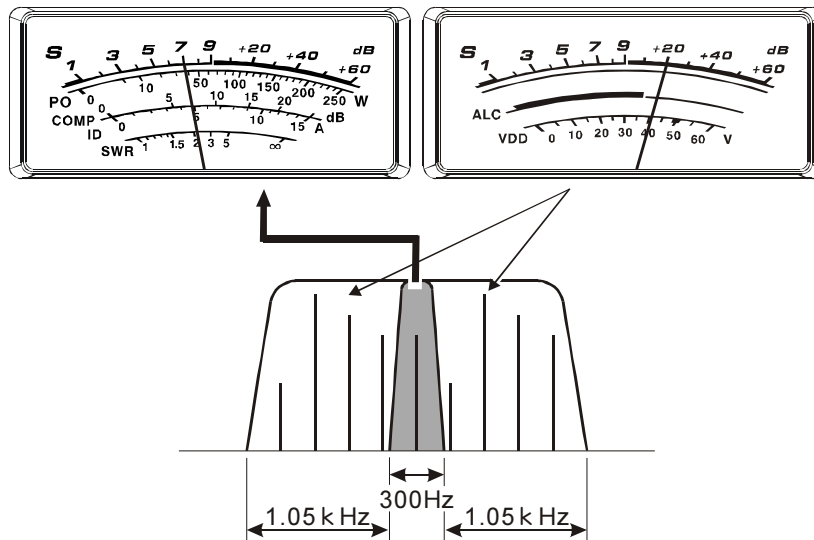

# SSB/AM MODE TRANSMISSION

## 1. Selecting the Operating Mode

The operating mode is selected using the **[MODE]** switches (#31) to the left of the **[Main]** Tuning Dial knob (#35), and the VFO (A or B) to which the selection is applied is selected by pressing the **[A]** or **[B]** switch above the **[MODE]** keys. Press the **[A]** or **[B]** key to select the desired VFO, then press the **[LSB]** or **[USB]** key to select one of the SSB modes. For AM operation, press the **[AM]** key.

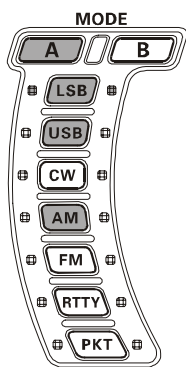

### 『Quick Point』

By convention, LSB is used in the 7 MHz and lower Amateur bands for SSB communication, and USB is used on the 14 MHz and higher bands (the 10 MHz band is used for CW and data modes only).

2. Rotate the **[Main]** Tuning Dial knob to adjust the operating frequency. Alternatively, if using the optional MD-200A8X Desktop Microphone, you may use the Up/Down scanning buttons to sweep up or down the current band.

### 『Advice』

Be sure to verify that the microphone you are using is enabled for operation via the Menu. There are two microphone jacks (the front panel's three-pin XLR ("Cannon") connector, and the rear panel's 8-pin round connector), and either jack may be chosen independently for SSB, AM, and FM operation. See the Menu list below for details of the associated Menu Item:

3. Press the microphone's PTT (Push To Talk) switch to begin transmission; speak into the microphone in a normal voice level.

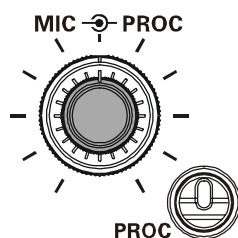

- The "TX" indicator will light up in the frequency display area, confirming that transmission is in progress.
- When transmitting in the AM mode, rotate the **[RF PWR]** control (#72) so as to set a maximum (carrier) power output of 50 Watts.
- Release the PTT switch at the end of your transmission. The transceiver will return to the receive mode.

4. To adjust the microphone amplifier gain to match the microphone and your voice level, close the PTT switch, speak into the microphone in a normal voice level, and adjust the **[MIC]** (gain) control (#15) as follows:

### SSB Mode

Adjust the **[MIC]** control so that the ALC voltage (displayed on the right meter) stays within the ALC zone of the meter (up to 2/3 or full scale deflection) on voice peaks.

For AM, the **[MIC]** control should not be advanced to the point where the ALC meter deflects. In many cases, the same setting as used on SSB will be satisfactory.

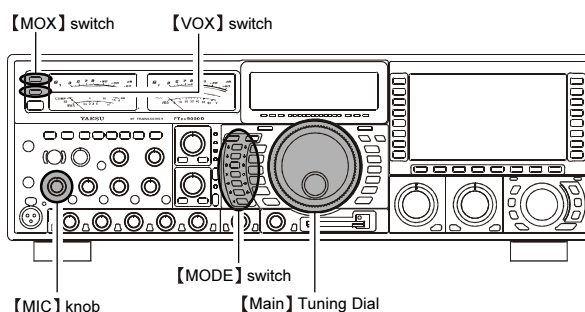

Please adjust the **[MIC]** gain control to set the ALC within this range.

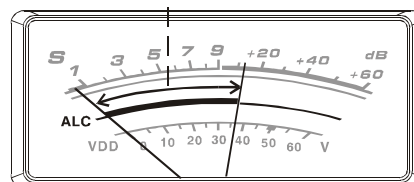

### 『Advice』

- ALC meter deflection may be caused by excessive drive power, but also by reflected power detected in the antenna system. If the impedance presented to the transceiver is different from 50 Ohms, ALC meter action may be observed that is not related to the proper setting of the **[MIC]** gain control. Therefore, we recommend that you make **[MIC]** gain adjustments into a dummy load or antenna system presenting an impedance very close to 50 Ohms.
- Rotate the **[RF PWR]** control to set the desired power output. Clockwise rotation of the **[RF PWR]** control will increase the power. The adjustment range is between 5 Watts and 200 Watts, and you should always use the minimum power necessary for maintaining reliable communications.
- When performing tests (such as the setup of the **[MIC]** or **[RF PWR]** controls), be sure to check the frequency before transmitting, so as to avoid interference to others who may already be using the frequency.
- Four techniques for exercising Transmit/Receive control are provided on the FT dx 9000D, and you may choose the technique(s) that best suit your operating needs:

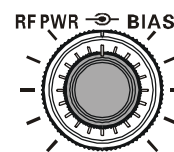

- Pressing the microphone's PTT switch will engage the transmitter.
- The rear panel PTT jack may be connected to a foot switch or other manual switching device in order to engage the transmitter.

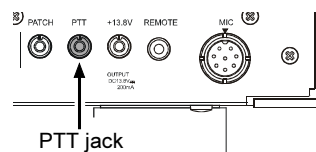

- Pressing the front panel **[MOX]** switch (#1) will lock the transmitter on. Press the **[MOX]** switch (a latching type) to return to receive.
- The VOX (Voice Operated Xmit) circuit will engage the transmitter automatically when you speak into the microphone. For details of VOX operation, see page 94.





# SSB/AM MODE TRANSMISSION

## PHANTOM VOLTAGE FOR CONDENSER MICROPHONES

For powering a studio-quality condenser microphone connected to the front panel's XLR ("Canon") connector, it is possible to enable a 48-volt DC line connected to that jack. Because the improper enabling of this voltage could cause damage to other microphone types, the simple process for enabling the voltage has been made somewhat complicated, so as to prevent the voltage from being enabled by accident.

1. Turn the front and rear panel power switches Off.
2. Unplug the AC cable from the rear panel [AC IN] jack.
3. Referring to Figure 1, remove the eight screws from the sides of the transceiver case.
4. Now remove the six screws shown in Figure 1 from the bottom case.
5. Referring to Figure 2, locate jack J28 on the AF Unit, and remove the jumper plug which is connected across pins 2 and 3 of J28.
6. Connect the just-removed jumper plug so that it now is connected across pins 1 and 2 of J28 (instead of the original position across pins 2 and 3).
7. Replace the six screws to affix the bottom case, and replace the eight screws from the sides of the transceiver (these screws were removed in steps 3 and 4 above).
8. Connect the AC cable to the rear panel's [AC IN] jack.
9. Turn the rear panel's power switch on, then turn the front panel power switch on.
10. If the above process has been successfully completed, you will observe that a small red LED just above and to the right of the XLR connector is now illuminated. If this LED is not glowing red, please check the status of the jumper plug once more.
11. If the red LED is glowing properly, the modification to enable the phantom 48 Volt line is now complete.

### 『Note』

- *When opening/closing the case, take care with your screwdriver not to short out internal components, or touch them in a way that will cause them to short out against other components.*
- *Avoid touching internal components with your hand, as static electricity can cause damage to certain components if appropriate anti-static bench techniques are employed.*
- *Only engage the phantom power when you have no alternative but to use a condenser microphone requiring such voltage. The wide availability of studio-grade Dynamic microphones (that do not require the phantom voltage) generally makes the use of the phantom voltage unnecessary over the life of the transceiver. Because damage can occur if the phantom voltage is enabled on a microphone not requiring it, we strongly recommend that the jumper plug at J28 (AF Unit) be left in its original position across pins 2 and 3.*
- *The phantom voltage capability of the FT DX 9000D is disabled at the factory, and the lack of this voltage is not a "defect" or other condition covered by the Limited Warranty on this product. Accordingly, if you do not feel capable of enabling the phantom voltage and ask a service shop to do so on your behalf, a service fee may apply.*

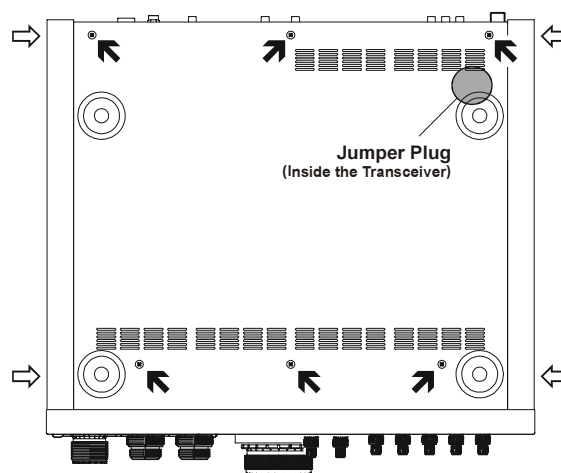

Figure 1

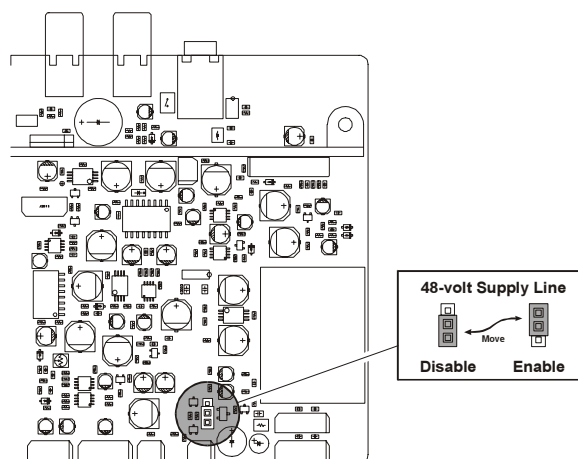

Figure 2

### 『Terminology』

#### Phantom Voltage

Phantom Voltage is a term describing the voltage (48 Volts at 10 mA max.) provided via the front panel's XLR ("Canon") microphone connector, for use with a studio-grade condenser microphone. Although disabled at the factory, enabling of the voltage only requires that the position of an internal jumper plug be moved.

# USING THE AUTOMATIC ANTENNA TUNER

The Automatic Antenna Tuner (hereinafter referred to as the “ATU”) built into each FT DX 9000D is crafted to ensure a 50-Ohm load for the final amplifier stage of the transmitter. We recommend that the ATU be used whenever you operate on the FT DX 9000D.

## 『Advice』

- The ATU of the FT DX 9000D, being located inside the station, only adjusts the impedance presented to the transceiver at the station end of your coaxial cable feedline. It does not “tune” the SWR at the antenna feedpoint itself. When designing and building your antenna system, we recommend that every effort be made to ensure a low SWR at the antenna feedpoint.
- The ATU of the FT DX 9000D includes 100 memories for tuning data. Eleven of these memories are allocated, one per Amateur band, so that each band has at least one setting preset for use on that band. The remaining 89 memories are reserved for the 89 most-recent tuning points, for quick frequency change without the need to retune the ATU.
- The ATU in the FT DX 9000D is designed to match impedances within the range of 16.5 Ohms to 150 Ohms, corresponding to an SWR of 3:1 or less. Accordingly, simple non-resonant whip antennas, along with random-length wires and the “G5RV” antenna (on most bands) may not be within the impedance matching range of the ATU.

## ATU OPERATION

1. Rotate the **【RF PWR】** control (#72) fully clockwise (to the right).
2. Use the **【Main】** Tuning Dial knob (#35) to set the radio to desired operating frequency within the Amateur band.
3. Press the **【TUNE】** switch (#10) momentarily to place the ATU in the transmit line (no adjustment/tuning will occur yet). An LED inside the **【TUNE】** switch will glow red continuously.

### Quick Point

The momentary press of the **【TUNE】** switch will turn the tuner on, and the microprocessor will automatically select the tuning point closest to the current operating frequency.

4. Press and hold in the **【TUNE】** switch for two seconds to begin automatic tuning. The transmitter will be engaged, and the red LED imbedded in the **【TUNE】** switch will blink while tuning is in progress. When the optimum tuning point has been reached, the radio will return to receive, and the red LED will again glow steadily (instead of blinking).
5. While tuning around the band using the Main tuning dial, you will observe that the **【TUNE】** LED blinks momentarily every 10 kHz. This momentary blinking indicates that a new tuning window has been entered. If you want to save tuning data associated with this 10 kHz window, repeat step 4 (above) for each such window. On bands like 1.8 MHz where the impedance may change rapidly, the storage of a number of tuning points is recommended.
6. To disconnect the ATU from the transmit line, press the **【TUNE】** switch momentarily. The red LED imbedded in the **【TUNE】** switch will go out, confirming that the ATU has been turned off. In the “Off” mode, the transceiver will be directly connected to the coaxial cable connected to your antenna, and will operate based on whatever impedance is present at the station end of the coax.

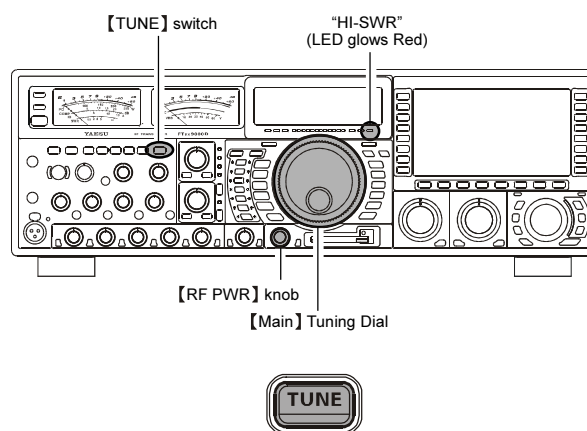

## 『Advice』

The ATU is connected both to the transmitter and the receiver, and its natural RF selectivity has a beneficial effect in rejecting out-of-band energy during reception. Accordingly, we recommend that the ATU be left “On” at all times.

## 『Quick Point』

- As shipped from the factory, only one ATU alignment point is saved on each Amateur band. This was memorized during the final alignment and performance verification stages on the production line.
- The momentary flickering of the **【TUNE】** switch’s LED occurs whenever you cross over into a new 10 kHz ATU memory window.

## 『Note』

Although transmitter power is decreased to 100 Watts (maximum) during tuning, by all means please check the operating frequency before beginning the tuning process, to be sure you are not interfering with others who may already be using the frequency.

## 『Terminology』

### Antenna Tuner Memories

The microprocessor of the ATU makes a note of the positions of the tuning capacitors and the selected inductors, and stores the data for each 10 kHz window in which tuning has occurred. This eliminates the need to re-tune every time you return to a frequency on which you already have completed the tuning process.

# USING THE AUTOMATIC ANTENNA TUNER

## ABOUT ATU OPERATION

Figure 1 depicts a situation where normal tuning via the ATU has been successfully completed, and the tuning data has been stored in the ATU memory. The antenna system as seen by the transmitter is shown.

In Figure 2, the operator has changed frequency, and the HI SWR LED has become illuminated. The operator presses and holds in the **[TUNE]** switch for two seconds to begin impedance matching using the ATU.

If a high SWR condition exists (above 3:1), corrective action must be taken in the antenna system to bring the impedance closer to 50 Ohms. Besides the fact that the ATU will refuse to memorize settings on frequencies where the SWR exceeds 3:1, the high SWR may indicate a mechanical failure in the feed system, and such failures can lead to the generation of spurious signals causing TVI, etc.

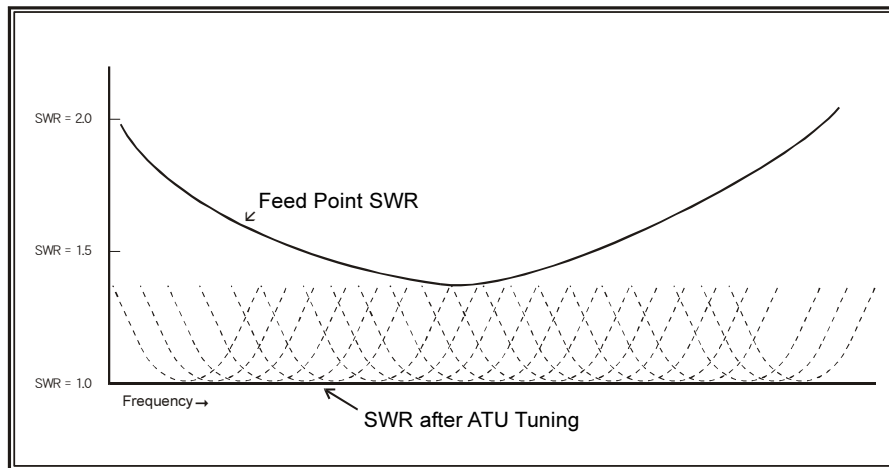

Figure 1

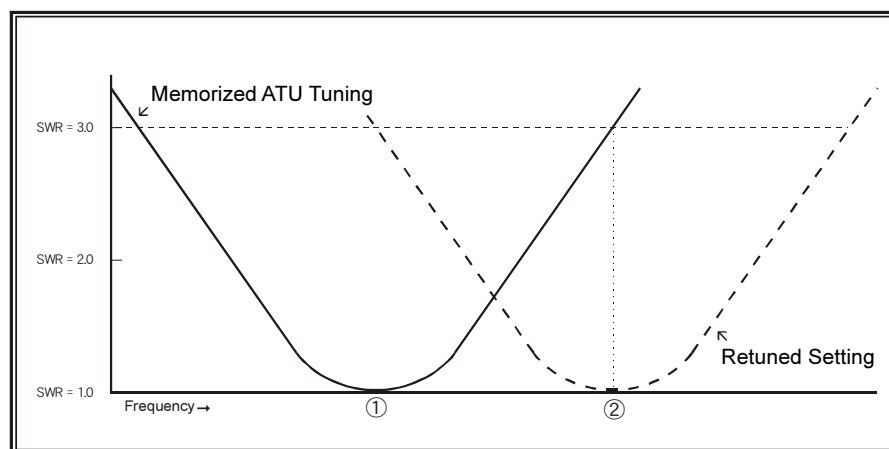

Figure 2

### About ATU Memories

#### **SWR (Post-tuning) Less than 1.5:1**

The tuning settings are committed to the ATU memory.

#### **SWR (Post-tuning) Greater than 1.5:1**

Tuning data will not be retained in memory. If you return to the same frequency, the tuning process must be repeated.

#### **SWR (Post-tuning) Greater than 3:1**

The HI SWR LED will light up, and tuning settings, if achieved, will not be memorized. Please investigate and resolve the high SWR condition before attempting further operation using this antenna. The high SWR may indicate a mechanical failure in the feed system, and such failures can lead to the generation of spurious signals causing TVI, etc.

# USING THE AUTOMATIC ANTENNA TUNER

## LITHIUM BATTERY REPLACEMENT

The memories for the ATU are backed up by a common Lithium backup battery (type CR2032 or equivalent). After two or more years of heavy use, you may notice that the tuner memories are not being maintained, and that you have to re-tune when returning to a frequency on which you had previously stored tuning data.

In this case, please replace the ATU Backup Battery using the following procedure:

1. Turn the transceiver's main power switch Off.
2. Unplug the AC cable from the rear panel's (~AC IN) jack.
3. Referring to Figure 1, remove the eight screws (↔) from the side of the transceiver, along with the six screws (←) affixing the bottom case; remove the bottom case.
4. Now remove the three screws affixing the top case, and remove the top case (Figure 2).
5. Referring to Figure 3, remove the screws (←) at the top left and top right that hold the front panel assembly in place, and loosen the two screws (↔) at the bottom left and bottom right, so they can hold the front panel as it is folded forward.
6. Refer to Figure 4, and slide the front panel diagonally upward and outward, then fold the front panel forward to expose the Control Unit behind it.
7. Locate the Lithium battery on the left side of the Control Unit (Figure 5)
8. Follow the guidelines in Figure 6, and remove the old battery, replacing it with a new one of the identical type.
9. Restore the front panel to its original position, and replace the two screws (one from each side, near the top) and tighten the two lower screws that were loosened in step 5. Replace the top and bottom covers, re-installing all the screws removed in steps 3 and 4. Replace the eight screws removed from the sides of the transceiver.
10. Replace the top and bottom covers, re-installing all the screws removed in steps 3 and 4.
11. ATU Backup Battery replacement is now complete.

### 『Quick Point』

When the ATU Backup Battery is replaced, all tuner memories will be erased, and new sets of tuning data will have to be stored.

### 『Note』

- Use care in the handling and storage of the Lithium battery. It is small, and presents a choking hazard to small children; therefore keep such batteries out of the reach of children at all times. Do not dispose of Lithium batteries in fire, and do not attempt to re-charge them under any circumstances.
- When opening/closing the case, take care with your screwdriver not to short out internal components, or touch them in a way that will cause them to short out against other components.
- The exhaustion of the ATU backup battery of the FT DX 9000D is a normal "wear and tear" situation, and the loss of the backup voltage is not a "defect" or other condition covered by the Limited Warranty on this product. Accordingly, if you do not feel capable of replacing the battery, and ask a service shop to do so on your behalf, a service fee may apply.

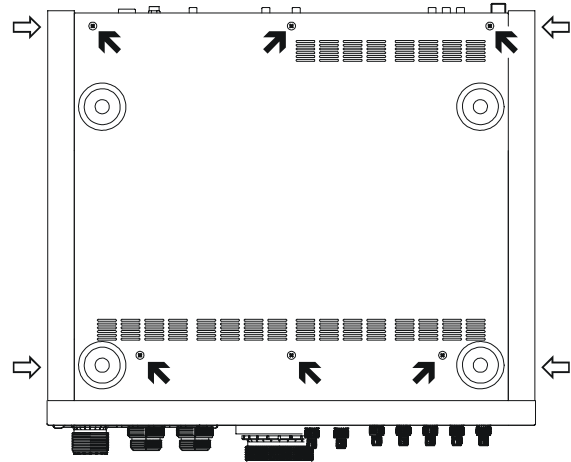

Figure 1

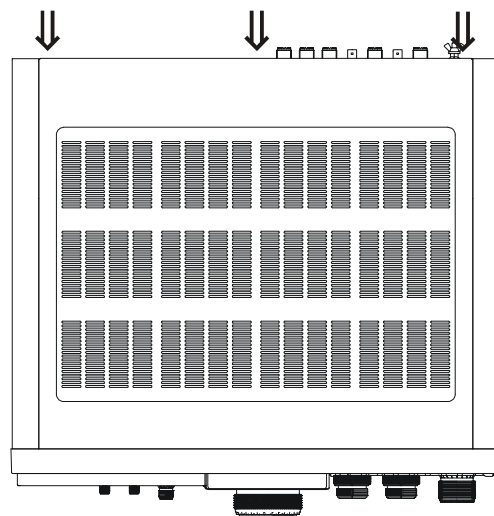

Figure 2

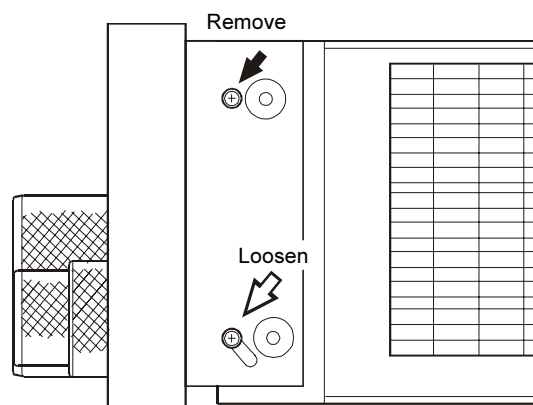

Figure 3

# USING THE AUTOMATIC ANTENNA TUNER

## LITHIUM BATTERY REPLACEMENT

Slide the front panel diagonally upward and outward.

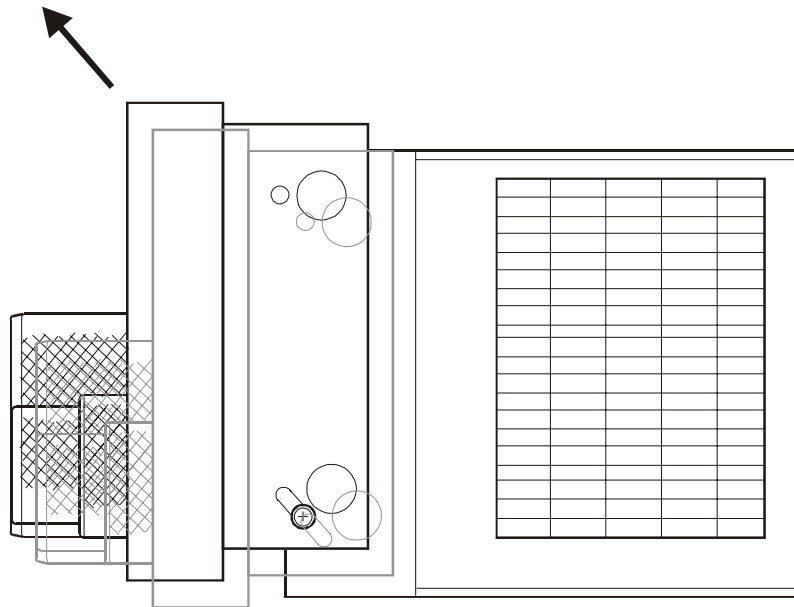

Figure 4

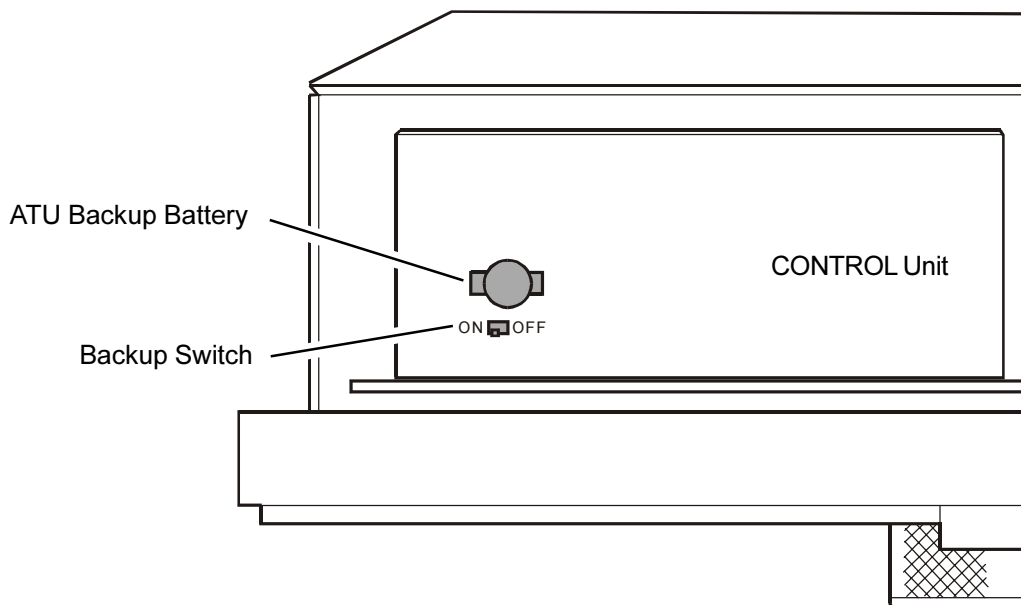
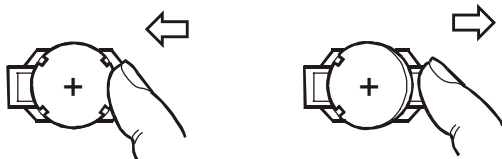

Figure 5

**Removal of the Lithium Backup Battery**  
After pushing in the direction of the arrow,  
move your finger upward.



**Inserting the Lithium Backup Battery**  
Use your fingertip to push in the  
indicated direction.

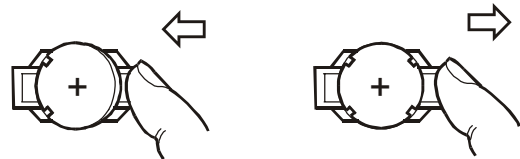

Figure 6

# SSB/AM MODE TRANSMISSION (ENHANCING TRANSMIT SIGNAL QUALITY)

## USING THE SPEECH PROCESSOR - SSB, AM MODE -

The Speech Processor is designed to increase “talk power” by increasing the average power output via a sophisticated compression technique. The result is improved intelligibility when conditions are difficult.

1. Adjust the **[MIC]** gain control (#15) for SSB use, as described on page 80.
2. Rotate the **[METER]** switch (#11) fully to the left, so as to select “COM” (Compression).
3. Press the **[PROC]** switch (#16) momentarily. The Red LED imbedded in the switch will light up, confirming that the Speech Processor is engaged.
4. Press the **[PTT]** switch on the microphone, and speak into the microphone in a normal voice level. Observe the deflection of the meter needle on the COMP meter scale.
5. Rotate the **[PROC]** control (#15) so that the meter needle deflects to not more than “10 dB” on the COMP scale.

To switch the Speech Processor off, press the **[PROC]** switch once more. The Red LED imbedded in the switch will go out, confirming that the Speech processor is turned off.

### 『Advice』

Excessive advancement of the **[COMP]** control will result in a degradation of the transmitted signal’s signal-to-noise ratio, thereby reducing intelligibility at the other end of the circuit.

- You may observe the effect of your COMP level adjustments by viewing the wave-form on the “Oscilloscope” page on the TFT.
- The Transmit Monitor is another helpful way of verifying proper adjustment of the Compression level. By Pressing the **[MONI]** switch (#12) and adjusting the **[MONI]** control (#13) for a comfortable listening level while you are transmitting, you will be able to hear the difference in sound quality as you make adjustments.
- The **[RF PWR]** control (#72) still controls the RF power output, whether or not the Speech Processor is engaged.

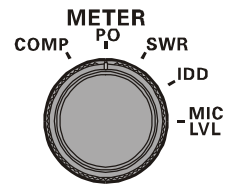
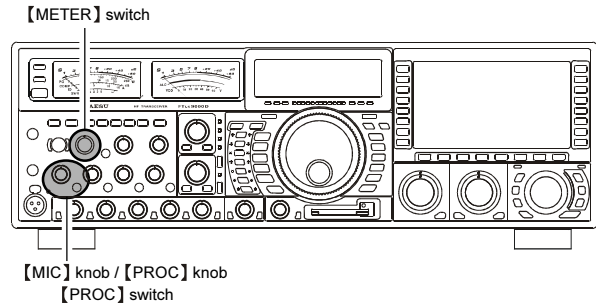

**[METER] switch**

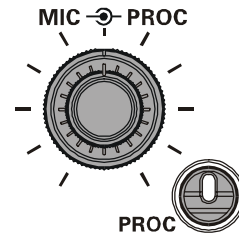

**[MIC] knob / [PROC] knob**  
**[PROC] switch**



# SSB/AM MODE TRANSMISSION (ENHANCING TRANSMIT SIGNAL QUALITY)

## ADJUSTING THE SSB TRANSMITTED BANDWIDTH

For transmission on SSB, a default bandwidth of 2.4 kHz is provided. This bandwidth provides reasonable fidelity along with good talk power, and is typical of the bandwidth used for decades during SSB transmission. However, the bandwidth may be varied by the operator, so as to provide different levels of fidelity or talk power, according to your preferences. Here's how to adjust the transmitted bandwidth on SSB:

1. Press the **[MNU]** switch (#92) to engage the Menu.
2. Rotate the **[Main]** Tuning Dial knob (#35) so as to select Menu Item "MODE SSB 070 SSB-TX-BPF."
3. Rotate the **[CLAR/VFO-B]** knob (#86) to select the desired bandwidth. The available selections are  
3000WB/50-3000/100-2900/200-2800/  
300-2700/400-2600,  
and the default is 300-2700 Hz.
4. Press and hold in the **[MNU]** switch for two seconds to save the new setting and exit to normal operation.

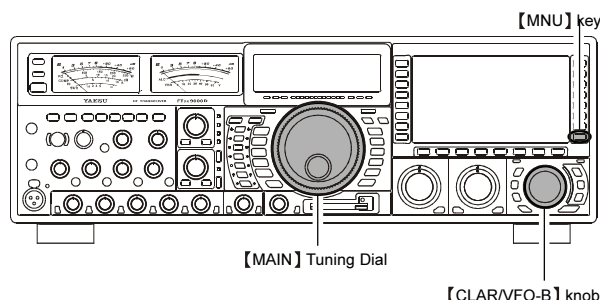

### 『Advice』

- You may verify the effect of your adjustments of the transmitted bandwidth by observing the Audio Scope on the "Oscilloscope" page of the TFT.
- The Transmit Monitor is another helpful way of verifying the effects on fidelity of changing the bandwidth. Press the **[MONI]** switch (#12), then adjusting the **[MONI]** control (#13) for a comfortable listening level while you are transmitting, you will be able to hear the difference in sound quality as you make changes.

### 『Quick Point』

- The higher fidelity associated with wide bandwidth will be particularly enjoyable on the low bands, during local rag-chew QSOs.
- The "3000WB" setting is a special hi-fidelity setting, whereby the transmitted bandwidth is in excess of 3 kHz. This selection, in conjunction with judicious adjustment of the Parametric Microphone Equalizer (see next chapter) can provide truly outstanding fidelity and very natural-sounding audio.
- When using the wider bandwidth selections (especially "3000WB"), the apparent power output from the transmitter may seem lower. This is because the available power from the transmitter is being distributed over a wider bandwidth, and the power detection circuitry does not compensate for the effect of the bandwidth selection (it is calibrated in the default 2.4 kHz bandwidth).

# SSB/AM MODE TRANSMISSION (ENHANCING TRANSMIT SIGNAL QUALITY)

## SIGNAL QUALITY ENHANCEMENT USING THE PARAMETRIC MICROPHONE EQUALIZER

The FT DX 9000D includes a unique Three-Band Parametric Microphone Equalizer, that provides precise, independent control over the low-, mid-, and treble-ranges in your voice wave-form.

### 『Quick Point』

- The Parametric Equalizer is a unique technique for adjusting the signal quality. Because the three ranges may be adjusted so precisely, it is possible to craft a response that provides a more natural and pleasant sound than you have ever experienced before.
- The Parametric Equalizer adjustments are applied independently to the front XLR (“Canon”) and rear (8-pin) microphone jacks, so you can connect different microphones and customize the audio response that best suits each microphone.

The aspects of configuration that you may adjust on the Parametric Equalizer are:

**Center Frequency:** The center frequency of each of the three bands may be adjusted.

**Gain:** The amount of enhancement (or suppression) within each band may be adjusted.

**Q:** The bandwidth over which the equalization is performed may be adjusted.

1. Connect the microphone to the front or rear microphone jack.
2. Set the **【RF PWR】** control (#72) to its minimum value, so as not to cause interference to other users during adjustment.

### 『Advice』

- Because the setup of the Parametric Equalizer for both front and rear microphone jacks may take some time, we recommend you consider connecting a dummy load to one of the Antenna jacks, and monitor your signal on a separate receiver, so as to prevent interference to other users.
  - You will have the best chance of hearing the effects of adjustments if you wear headphones while monitoring your transmitted signal.
3. Press the **【MONI】** switch (#12).
  4. Press the **【MNU】** switch (#92) momentarily. The Menu list will appear on the TFT.
  5. Rotate the **【Main】** Tuning Dial knob (#35) to find the “EQ” Menu area, containing Menu Items 136 through 153; these pertain to the adjustment of the Parametric Microphone Equalizer.
  6. Rotate the **【CLAR/VFO-B】** knob (#86) to perform adjustments to a particular Menu item.
  7. Close the PTT switch, and speak into the microphone while listening to the effects of the changes you are making (in step 6). Because the overall effect on the sound will change with each adjustment you make, you should make several passes through each adjustment area, to be sure that you are achieving the optimum setting.
  8. When you have completed all adjustments, press and hold in the **【MNU】** switch for two seconds to save the new settings and exit to normal operation. If you only press the **【MNU】** key momentarily to exit, any changes you performed will not be stored.

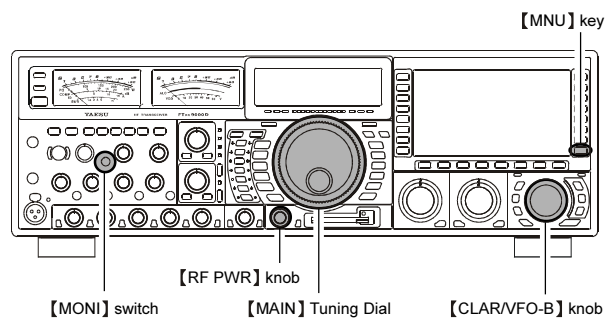

Downloaded by  
RadioAmateur.EU

# SSB/AM MODE TRANSMISSION (ENHANCING TRANSMIT SIGNAL QUALITY)

## SIGNAL QUALITY ENHANCEMENT USING THE PARAMETRIC MICROPHONE EQUALIZER

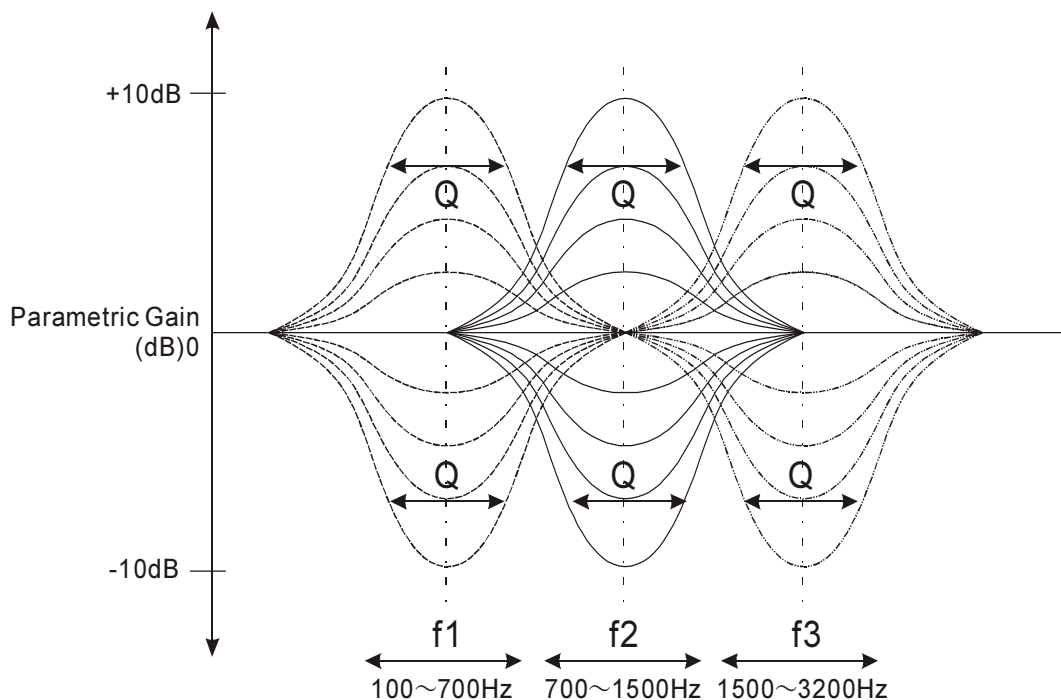

### 3-Stage Parametric Equalizer Adjustments: Front Panel Microphone Jack

Center Frequency	TX AUDIO 136 F-PRMTRC EQ1-FREQ	“100” (Hz) ~ “700” (Hz)
	TX AUDIO 139 F-PRMTRC EQ2-FREQ	“700” (Hz) ~ “1500” (Hz)
	TX AUDIO 142 F-PRMTRC EQ3-FREQ	“1500” (Hz) ~ “3200” (Hz)
Parametric Gain	TX AUDIO 137 F-PRMTRC EQ1-LEVEL	(Low) “-10” (-10dB) ~ “+10” (+10dB)
	TX AUDIO 140 F-PRMTRC EQ2-LEVEL	(Mid) “-10” (-10dB) ~ “+10” (+10dB)
	TX AUDIO 143 F-PRMTRC EQ3-LEVEL	(High) “-10” (-10dB) ~ “+10” (+10dB)
Q (Bandwidth)	TX AUDIO 138 F-PRMTRC EQ1-BWTH	(Low) “1” ~ “10”
	TX AUDIO 141 F-PRMTRC EQ2-BWTH	(Mid) “1” ~ “10”
	TX AUDIO 144 F-PRMTRC EQ3-BWTH	(High) “1” ~ “10”

### 3-Stage Parametric Equalizer Adjustments: Rear Panel Microphone Jack

Center Frequency	TX AUDIO 145 R-PRMTRC EQ1-FREQ	“100” (Hz) ~ “700” (Hz)
	TX AUDIO 148 R-PRMTRC EQ2-FREQ	“700” (Hz) ~ “1500” (Hz)
	TX AUDIO 151 R-PRMTRC EQ3-FREQ	“1500” (Hz) ~ “3200” (Hz)
Parametric Gain	TX AUDIO 146 R-PRMTRC EQ1-LEVEL	(Low) “-10” (-10dB) ~ “+10” (+10dB)
	TX AUDIO 149 R-PRMTRC EQ2-LEVEL	(Mid) “-10” (-10dB) ~ “+10” (+10dB)
	TX AUDIO 152 R-PRMTRC EQ3-LEVEL	(High) “-10” (-10dB) ~ “+10” (+10dB)
Q (Bandwidth)	TX AUDIO 147 R-PRMTRC EQ1-BWTH	(Low) “1” ~ “10”
	TX AUDIO 150 R-PRMTRC EQ2-BWTH	(Mid) “1” ~ “10”
	TX AUDIO 153 R-PRMTRC EQ3-BWTH	(High) “1” ~ “10”

# SSB/AM MODE TRANSMISSION (LOW-DISTORTION CLASS-A OPERATION)

## LOW-DISTORTION CLASS-A OPERATION

Class-A operation of the FT DX 9000D transmitter is provided, yielding ultra-low distortion products during SSB operation. Power output during Class-A operation is 75 Watts.

To engage Class-A operation, press the **【CLASS-A】** switch (#73). The imbedded Red LED will light up, confirming that Class-A operation has been selected.

Engaging the “Class-A” mode actually places the transceiver in a condition whereby the Bias level may be adjusted, using the **【BIAS】** control (#72), to set the transceiver for operation anywhere between Class A and Class AB (which has lower heat dissipation but higher distortion products). Clockwise rotation of the **【BIAS】** control increases the Bias, and fully clockwise rotation of the **【BIAS】** control will place the transmitter in fully Class-A operation. Counter-clockwise rotation of the **【BIAS】** control will move the transmitter toward Class AB operation.

To exit from the CLASS-A mode, press the **【CLASS-A】** switch once more. The Red LED imbedded in the switch will go out, confirming that the CLASS-A mode has been disengaged.

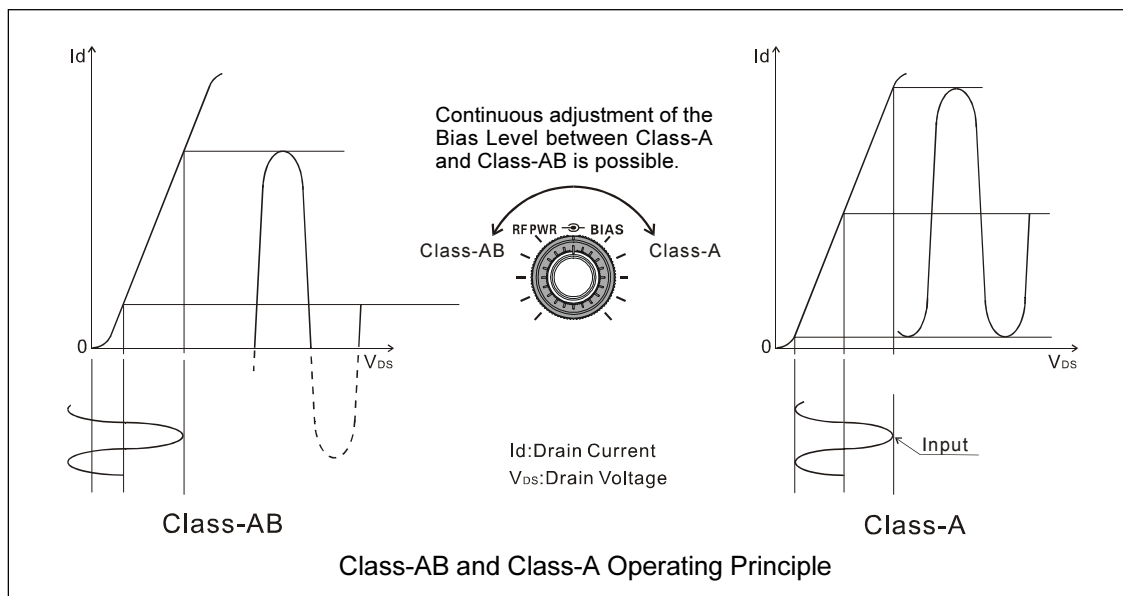
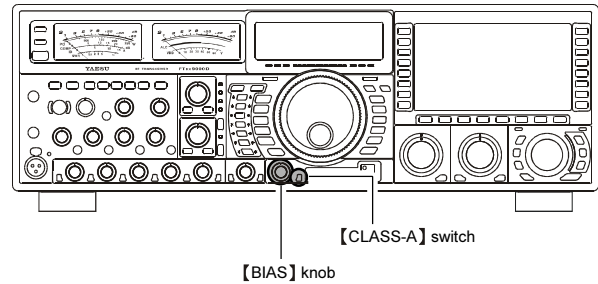
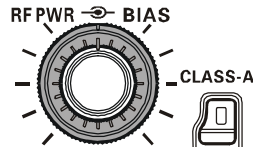
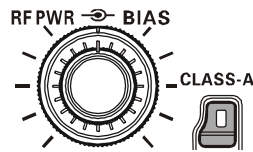

### 『Advice』

- During Class-A operation, ten Amps of Bias current will be flowing, regardless of the modulation level that leads to actual power output. Therefore, if the ambient temperature in your operation location is high, the transceiver temperature may rise as well, due to the high bias level (which must be dissipated as heat). Depending on the temperature, you may wish to reduce the setting of the **【BIAS】** control, so as to reduce the amount of heat being generated.
- Because you can monitor the heat sink temperature on the TFT, you can always be aware of a rise in temperature during Class-A operation. Normally, the temperature is below 80°C; if it rises to near or above this value, however, we recommend you adjust the **【BIAS】** control toward Class AB (more to the left) so as to reduce the heat being dissipated.
- An innovative aspect of the “Class-A” mode is that the actual power output is always limited to 75 Watts. So even though you might adjust the **【BIAS】** control in the direction of Class-AB operation, the power output will not rise; this eliminates the need, for example, to re-tune your linear amplifier, if used.

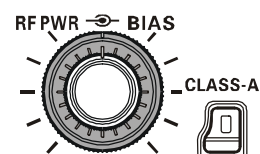

# SSB/AM MODE TRANSMISSION (LOW-DISTORTION CLASS-A OPERATION)

## LOW-DISTORTION CLASS-A OPERATION

### 『Quick Point』

- Class-A operation provides a significant improvement in transmitter distortion suppression. During Class-A, the 3rd-order IMD products are typically suppressed 50 dB, while the 5th- and higher-order IMD products (that can cause “splatter” that interferes with others) will typically be suppressed 70 dB or more.
- If you are using a linear amplifier such as the VL-1000, the low distortion produced by the FT DX 9000D’s transmitter means that these intermodulation distortion products will not exist to be amplified by your linear.

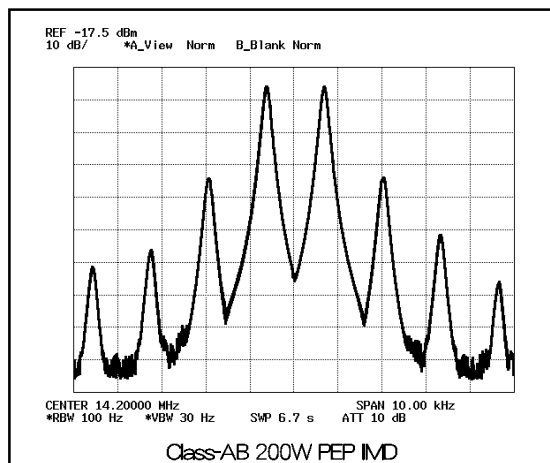
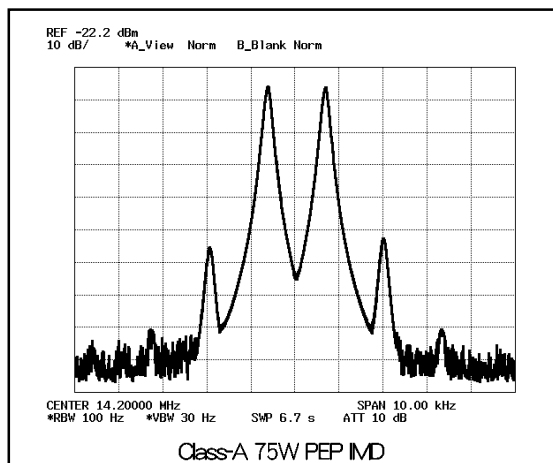

### ○ High-Power 200-Watt Final Amplifier Stage

The final amplifier stage of the FT DX 9000D utilizes a pair of ST Micro Electronics Corp. SD2931 MOSFET devices operating at 50 Volts. The push-pull configuration provides low distortion along with high power output. The 120 mm thermostatically-controlled cooling fan directs forced air across the heat sink, should the heat sink temperature exceed the temperature that will trigger the thermostat.

# SSB/AM MODE TRANSMISSION

## VOICE MEMORY

You may utilize the Voice Memory capability of the FT DX 9000D by plugging in the supplied FH-2 Remote Control Keypad into the rear panel's **[REMOTE]** jack.

The Voice Memory system includes five memories capable of storing up to 20 seconds of voice audio each. The maximum that any memory can hold is 20 seconds. Please see the diagram depicting connection of the FH-2 Remote Control Keypad on page 15.

### Recording Your Own Voice in Memory

1. Select the LSB, USB, AM, or FM mode using the front panel Mode selector switches.
2. Press the **[MEM]** key on the FH-2.

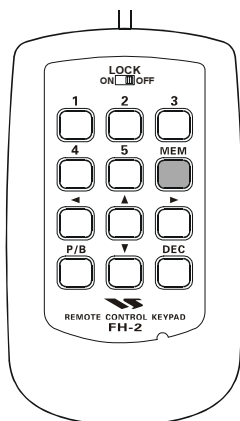

3. Press any of the keys numbered **[1]** through **[5]** to select that memory storage register. If you do not press the PTT key (see next step) within five seconds, the memory storage process will be cancelled.

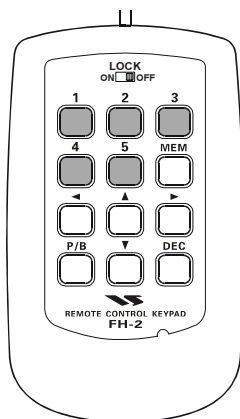

4. Press the microphone's PTT switch, and speak into the microphone in a normal voice level to record the message (such as "CQ DX, CQ DX, this is W 6 Delta X-Ray Charlie, W 6 Delta X-Ray Charlie, Over"). Remember that the time limit for recording any message is 20 seconds.
5. Press the FH-2 **[MEM]** key to terminate the message storage process.

### Checking Your Recording

1. Be sure that the front panel **[MOX]** switch (#①) is Off (not pushed in).
2. Press the **[1]** ~ **[5]** key (whichever one you just recorded in), and you will hear the contents of the voice memory you just recorded.

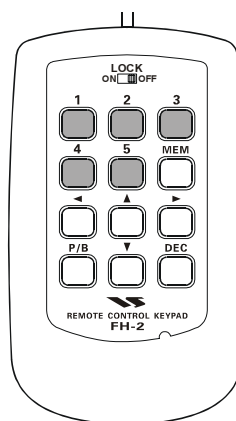

### 『Advice』

You may rotate the Main (VFO-A) band **[AF GAIN]** control (#⑦⑤) to adjust the playback level of the recording.

### Transmitting the Recorded Message

1. Select the LSB, USB, AM, or FM mode using the front panel **[MODE]** selector switches (#③①).
2. Press the front panel's **[BK-IN/SPOT]** switch (#②⑨).
3. Press the FH-2 **[1]** ~ **[5]** key, depending on which memory register's message you wish to transmit. If you hit the key again during playback, the message will be terminated.

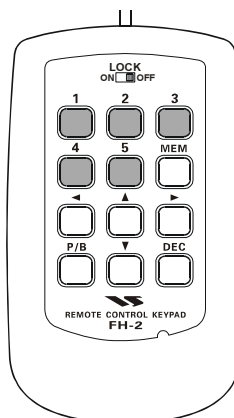





# CONVENIENT TRANSMITTER ACCESSORIES

## VOX: AUTOMATIC TX/RX SWITCHING USING VOICE CONTROL SSB/AM/FM MODES

Instead of using the microphone's PTT switch or the front panel **【MOX】** switch to activate the transmitter, the VOX (Voice Operated TX/RX Control) system provides hands-free, automatic activation of the transmitter, based on voice input into the microphone. Setup of the VOX system takes only a few seconds.

1. To start, set the **【DELAY】** and **【VOX】** controls (#17) fully counter-clockwise (to the left).
2. Press the **【VOX】** switch (#2) to engage VOX operation.
3. Speak into the microphone in a normal voice level, and rotate the **【VOX】** knob clockwise (to the right) until the point where your voice input activates the transmitter.
  - Do not advance the setting of the **【VOX】** control too much, because to do so will make the transmitter respond to minor background noises in your station.
4. Now stop speaking, and note the amount of time it takes for the receiver to recover. If the hang time is too long or too short; rotate the **【DELAY】** knob, while speaking briefly into the microphone and then pausing, so as to set the desired hang time. Clockwise rotation of the **【DELAY】** control will increase the hang time.
5. To exit from VOX operation, press the **【VOX】** switch once more. We recommend doing this if you are going to leave your station, to prevent inadvertent activation of the VOX system by a ringing nearby telephone, speaker audio from a TV, etc.

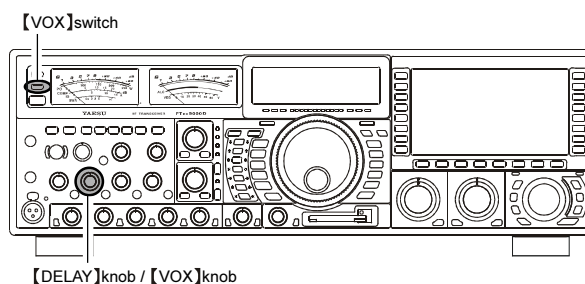

### 『Advice』

VOX operation may be engaged on either Voice modes (SSB/AM/FM) and on AFSK-based Data modes. Use Menu item "TX GNRL 159 VOX SELECT" (the selections are "MIC" and "DATA").

## USING THE MONITOR

You may listen to the quality of your transmitted signal using the Monitor feature.

1. Press the **【MONI】** switch (#12). The imbedded Red LED will light up, indicating that the Monitor is turned on.
2. During transmission, rotate the **【MONI】** knob (#13) to adjust the audio level from the Monitor. Clockwise rotation of this knob will increase the volume level.
3. To switch the Monitor off again, press the **【MONI】** switch once more. The Red LED will go out, confirming that the Monitor is now disengaged.

### 『Advice』

- If you are using the speaker for monitoring, instead of headphones, excessive advancement of the **【MONI】** control can cause feedback to occur. Additionally, this feedback can cause the VOX system to hang up in a loop, making it impossible to return to receive. Therefore, we recommend the use of headphones, if at all possible, or the minimum usable setting of the **【MONI】** control, if the speaker must be used.
- Because the Monitor feature utilizes a sampling of the transmitter's IF signal, it can be very useful for checking the adjustment of the Speech Processor or Parametric Equalizer on SSB, and for checking the general signal quality on AM and FM.

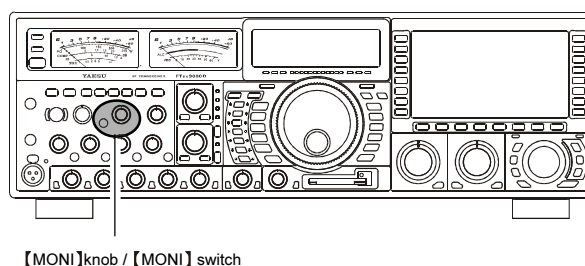

# CONVENIENT TRANSMITTER ACCESSORIES

## SPLIT OPERATION USING THE TX CLARIFIER (VFO-A OPERATION)

For split TX/RX operation in “casual” pile-ups, where the split is less than 10 kHz, the TX Clarifier (Offset Tuning) feature may be utilized.

1. Press the **【CLAR】** switch (#82). The Red LED imbedded in the switch will light up. The **【CLAR/VFO-B】** knob (#86) will now be enabled for offset tuning of the transmitter.

### 『Advice』

- Please verify that the lamp to the right of the **【CLAR/VFO-B】** knob is not lit up in Orange. If so, this indicates that this knob is currently engaged for Sub (VFO-B) band tuning. If the Orange lamp is lit, press the **【A/B】** switch (#90), then press the **【CLAR】** switch, to engage Clarifier operation.

### 『Quick Point』

- The Clarifier is frequently used for receiver offset tuning. However, for DX pile-ups where the DX station is using a split of less than 10 kHz, the TX Clarifier function is usually the quickest way to set the transmitter to the desired offset frequency.
2. Press the **【BAND/MHz TX】** switch (#88), located above and to the right of the **【CLAR/VFO-B】** knob. The “CLAR” and “TX” notation will appear on the frequency display.
  3. Rotate the **【CLAR/VFO-B】** switch to set the desired transmitter offset. A maximum split of  $\pm 9.99$  kHz may be set.

To disengage the transmit Clarifier temporarily, press the **【TX】** switch once more. The “CLAR TX” indication will disappear from the frequency display area.

To exit from Clarifier operation, press the **【CLAR】** switch once more. The “CLAR” indication will disappear from the TFT.

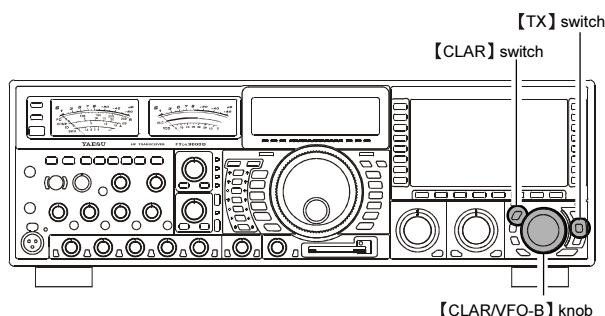

### 『Advice』

- To listen to the pile-up calling the DX station, so as to find the station currently being worked, you may press the **【RX】** switch (#80: above and to the left of the **【CLAR/VFO-B】** knob). Once you have zeroed in on the station calling the DX (use the SPOT function on CW for precise alignment of your frequency), you may then press the **【RX】** switch again to cancel the RX Clarifier, and return to reception on the DX station's frequency.
- Just as with receiver Clarifier operation, the amount of offset from the original VFO frequency will appear in the small display window.
- As with receiver Clarifier operation, when you turn the TX Clarifier off the last-used offset is not lost, and will be available if you turn the TX Clarifier back on. To clear the Clarifier offset, press the **【CLAR】** switch.

## Clarifier Offset Bar Indicator

A visual depiction of the relative offset of the Clarifier may be displayed, using the Bar Indicator.

1. Press the **【MNU】** key (#92); the Menu list will appear on the TFT.
2. Rotate the **【Main】** Tuning Dial knob (#35) to select Menu item “DISPLAY 016 BAR DISPLAY SELECT.”
3. Rotate the **【CLAR/VFO-B】** (#86) control to select “CLAR” from the available choices; the factory default is “CW-TUNE.”
4. Press and hold in the **【MNU】** key for two seconds to save the new setting and exit to normal operation.

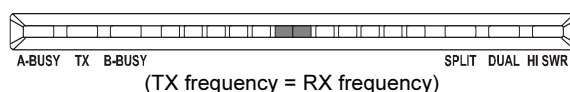
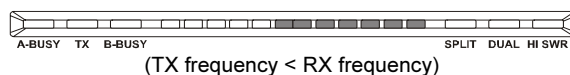
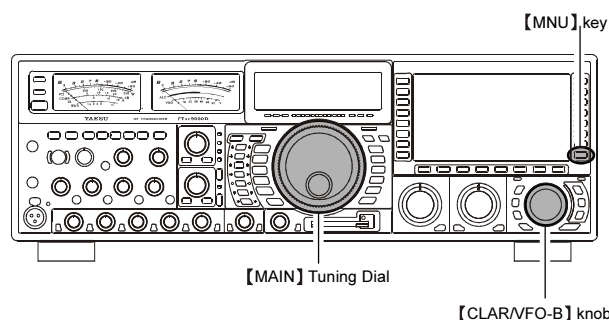

# CONVENIENT TRANSMITTER ACCESSORIES

## SPLIT-FREQUENCY OPERATION

A powerful capability of the FT DX 9000D is its flexibility in Split Frequency operation, using the Main (VFO-A) and Sub (VFO-B) frequency registers. This makes the FT DX 9000D especially useful for high-level DX-pedition use, as the Split operation capability is very advanced and easy to use.

1. Set the Main (VFO-A) frequency as desired.
2. Set the Sub (VFO-B) frequency.
3. Now press the **[SPLIT]** switch (#39). The “Split” mode will be engaged, and the front panel switch/LEDs will look like this:

MAIN(VFO-A)

**[RX]** switch (#33) “ON” (LED glows Green)

**[TX]** switch (#34) “OFF” (LED Off)

SUB(VFO-B)

**[RX]** switch (#80) “OFF” (LED Off)

**[TX]** switch (#81) “ON”(LED glows Red)

During Split operation, the Main (VFO-A) register will be used for reception, while the Sub (VFO-B) register will be used for transmission. If you press the **[SPLIT]** switch once more, Split operation will be cancelled.

You may also press the **[TX]** switch located above and to the left of the Main tuning Dial to return transmit frequency control to the Main (VFO-A) side, and thereby cancel Split operation.

### 『Advice』

- During normal (non-split) VFO-A operation, you may simply press the Sub (VFO-B) **[TX]** switch (located above and to the right of the **[CLAR/VFO-B]** knob: #86) to engage Split operation. The **[TX]** indicator will glow Red when you press the switch.
- During Split operation, pressing the **[A↔B]** switch (#44) will reverse the contents of the Main and Sub VFOs. Press the **[A↔B]** switch once more to return to the original frequency alignment.
- During Split operation, if you press the **[RX]** switch above and to the right of the **[CLAR/VFO-B]** knob, you will engage Dual Receive operation, and now can listen to both sides of the DX pile-up, while transmitting on the Sub (VFO-B) frequency. This is very useful for maintaining the timing of your calls, while also monitoring both sides of the pile-up.
- During Split operation, you may also press the **[TXW]** switch (#40; below and to the left of the Main Tuning Dial) to listen to the TX frequency temporarily.
- It is possible to set different operating modes (for example, LSB and USB) on the two VFOs used during Split operation.
- During Split operation, it also is possible to set the Main and Sub VFOs to different Amateur bands, and it also is possible to engage Crossband Full Duplex operation for multiplier hunting while calling CQ on the “TX” band. See page 98 for a discussion of full duplex operation.

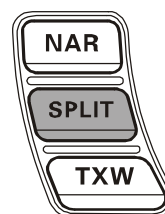
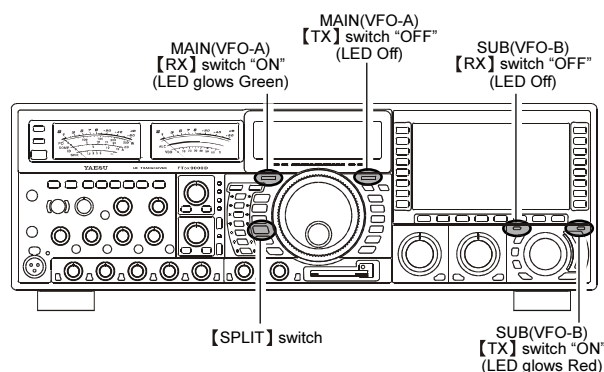

# CONVENIENT TRANSMITTER ACCESSORIES

## SPLIT-FREQUENCY OPERATION

### Quick Split Operation

The Quick Split feature allows you to set a one-touch offset of +5 kHz to be applied to your radio's transmit frequency on the Sub VFO, compared to the Main (VFO-A) frequency.

1. Start with regular transceiver operation on the Main (VFO-A) band.

#### MAIN(VFO-A)

【RX】 switch (#33) "ON" (LED glows Green)

【TX】 switch (#34) "ON" (LED glows Red)

#### SUB(VFO-B)

【RX】 switch (#80) "OFF" (LED Off)

【TX】 switch (#81) "OFF" (LED Off)

2. Press and hold in the 【SPLIT】 switch (#39) for two seconds to engage the Quick Split feature, and apply a frequency 5 kHz above the Main (VFO-A) frequency to the Sub (VFO-B) frequency register. Press and hold in the 【SPLIT】 switch for two seconds to increment the Main (VFO-A) frequency to +5 kHz.

The VFO configuration will then be:

#### MAIN(VFO-A)

【RX】 switch "ON" (LED glows Green)

【TX】 switch "OFF" (LED Off)

#### SUB(VFO-B)

【RX】 switch "OFF" (LED Off)

【TX】 switch "ON" (LED glows Red)

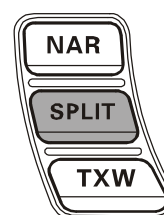
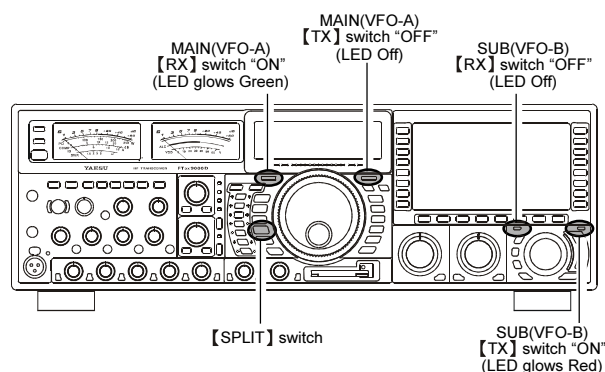

#### 『Quick Point』

- The operating mode applied to the Sub (VFO-B) register will be the same as that in use on the Main (VFO-A) register.
- The offset of the Sub VFO from the Main VFO is programmed via the Menu, and is set to +5 kHz at the factory. Other offsets may be selected, however, using the following procedure:

1. Press the 【MNU】 switch (#92) to enter the Menu mode.
2. Rotate the 【Main】 Tuning Dial knob (#35) to select Menu item "GENERAL 032 QUICK SPLIT FREQ."
3. Rotate the 【CLAR/VFO-B】 knob (#86) to select the desired offset.  
The available selections are  
-10 kHz ~ 0 kHz ~ +20 kHz  
(factory default: +5 kHz).
4. When you have completed all adjustments, press and hold in the 【MNU】 switch for two seconds to save the new setting and exit to normal operation. If you only press the 【MNU】 key momentarily to exit, any changes you performed will not be stored.

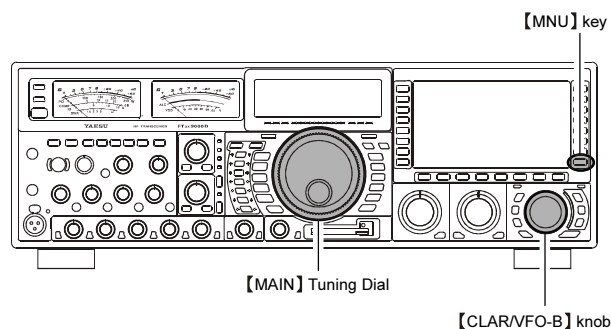

# CONVENIENT TRANSMITTER ACCESSORIES

## FULL DUPLEX OPERATION

The FT DX 9000D includes a unique capability among HF transceivers: the ability to operate in a full duplex environment, where by you can transmit on the Main band (VFO-A) while simultaneously tuning around, on a different band, on the Sub band (VFO-B). This affords the contest operator extra tuning time in search of new contacts and multipliers while calling CQ on the “run” band. This yields “SO2R” (Single Operator, Two Radio) operating capability while using only one transceiver!

To engage Full Duplex crossband operation, set Menu item “TX GNRL 158 FULL DUP” to “DUP” instead of the default “SIMP” selection. To return to normal (non-duplex) operation, return Menu #158 to SIMP.

When Full duplex operation is engaged, you may receive on the Sub (VFO-B) band frequency while transmitting, during dual receive operation, on a different band on the Main band (VFO-A). This allows you to tune for contacts on 15 meters, for example, while calling CQ on 20 meters during a slow time in a contest. Press the Sub (VFO-B) band “TX” Button/LED to switch transmit control to that VFO to call a station, then press the Main (VFO-A) band “TX” Button/LED to return to the “run” band and continue your “CQ” process.

This capability within a single transceiver is a unique feature of the FT DX 9000D. It relieves you of the need to run separate key, PTT, and other control lines to two different radios from your logging computer.

### 『Note』

Full Duplex operation within the same band (e.g. both Main and Sub VFOs on 20 meters) is not possible.

### Important Guidelines for Full Duplex Operation

Remember that, at your station location, the capability exists for damaging RF voltage to be conducted from your transmitting antenna into your receiving antenna during full duplex operation. The exact amplitude will depend on the operating frequency, proximity and polarization alignment of the antennas, and the transmitting power level (including your linear amplifier, if used).

Accordingly, you should take some time, in assembling your station, to ensure that proper isolation exists between your station antenna systems. One way to do this is to connect the “receive” antenna coaxial cable to the “Transmitter” jack of low-power Wattmeter, and connect the “Antenna” jack of the Wattmeter to a 50-Ohm Dummy load. Now transmit on the “TX” antenna you will be using, and observe the deflection (if any) on the low-power Wattmeter connected to the “receive” antenna. For safe operation of the FT DX 9000D, you should observe “10 mW” or less on the Wattmeter.

Repeat this test for each band and antenna combination that exists at your station. The low bands like 160 and 80 meters should be checked with particular care, as the physical sizes of antennas used on these bands can present very high RF voltages to the front end of a receiver. Remember to rotate directional antennas, and engage all “Upper” and “Lower” combinations in Yagi stacks, so as to account for different possibilities of mutual coupling between antennas.

If excessive power is being induced onto the “Receive” antenna, you will need to investigate and install suitable bandpass filters and/or stubs in order to reduce the induced power to a safe level. Suitable information may be found in radio handbooks, and an excellent treatise is available in the book “Managing Intersection Interference - Coaxial Stubs and Filters” by George Cutsogeorge, W2VJN; information may be found at [www.qth.com/inrad/book.htm](http://www.qth.com/inrad/book.htm).

Downloaded by  
RadioAmateur.EU





# CW MODE OPERATION

The powerful CW operating capabilities of the FT DX 9000D include operation using both an electronic keyer paddle and a “straight key” or emulation thereof, as is provided by a computer-based keying device.

## SETUP FOR STRAIGHT KEY (AND STRAIGHT KEY EMULATION) OPERATION

Before starting, connect your key line to the front and/or rear panel **[KEY]** jack, and be sure the **[KEYER]** switch on the left side of the front panel is turned off for now.

1. Press the **[CW]** mode switch (#31) to engage CW operation.

- The operating mode is selected using the **[MODE]** switches to the left of the **[Main]** Tuning Dial (#35), and the VFO (A or B) to which the selection is applied is selected by pressing the **[A]** or **[B]** switch above the Mode keys. Please be sure you are engaging CW on the right VFO.
- The LED associated with your VFO and (CW) Mode selection will light up.
- If you press the **[CW]** key once more, after initially selecting CW, you will engage the “CW Reverse” mode (see page 104), whereby the “opposite” sideband injection is used, compared to the “normal” sideband. The CW LED will blink for three seconds if you select CW Reverse.

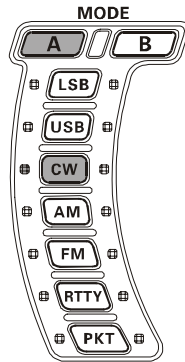

2. Rotate the **[Main]** Tuning Dial (#35) to select the desired operating frequency.

3. Press the **[BK-IN/SPOT]** key (#20) momentarily to engage automatic activation of the transmitter when you close the CW key. The LED imbedded in the **[BK-IN/SPOT]** switch will light up.

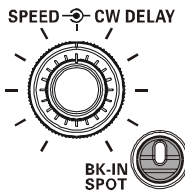

- When you close your CW key, the transmitter will automatically be activated, and the CW carrier will be transmitted. When you release the key, transmission will cease after a brief delay; the delay time is user-programmable, per the discussion on page 105.
- As shipped from the factory, the FT DX 9000D TX/RX system for CW is configured for “Semi-break-in” operation. However, using Menu item “MODE-CW 047 CW BK-IN,” you may change this setup for full break-in (QSK) operation, whereby the switching is quick enough to hear incoming signals in the spaces between the dots and dashes of your transmission. This may prove very useful during contest and traffic-handling operations.

4. Operation using your CW key may now proceed.

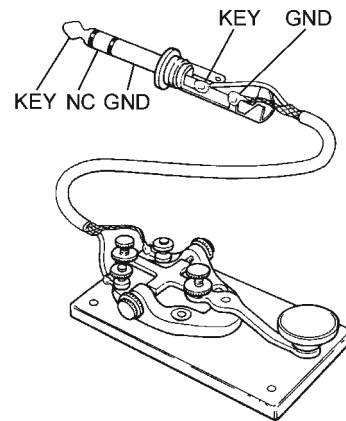
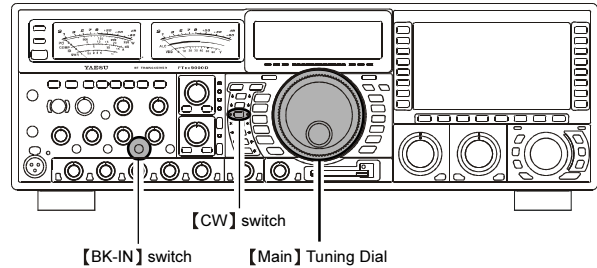

### 『Advice』

- You can monitor your sending by pressing the **[MONI]** key (#12), and adjust the **[MONI]** control (#13) for a comfortable listening level on the CW sidetone.
- If you set the **[VOX]** (#2) and **[BK-IN]** switches (#20) to Off, you may practice your sending without having the signal go out over the air (sidetone only).

### 『Terminology』

- **Semi-break-in**

This is a pseudo- “VOX” mode used on CW, whereby the closure of the CW key will engage the transmitter, and release of the key will allow the receiver to receive after a short delay. No signals will be heard between the spaces between dots and dashes (unless the sending speed is extremely slow).

- **Full break-in**

Full break-in (Also known as “Full QSK”) involves very fast switching between transmit and receive, such that incoming signals may be heard between the dots and dashes as you send them. This allows you to hear a station that suddenly starts transmitting on your frequency, while you are in the midst of a transmission.

## USING THE BUILT-IN ELECTRONIC KEYS

Connect the cable from your keyer paddle to the front or rear panel **[KEY]** jack.

1. Press the **[CW]** mode switch (#31) to engage CW operation.

If you press the **[CW]** key once more, after initially selecting CW, you will engage the “CW Reverse” mode (see page 104), whereby the “opposite” sideband injection is used, compared to the “normal” sideband. The CW LED will blink for three seconds if you select CW Reverse.

2. Rotate the **[Main]** Tuning Dial (#35) to select the desired operating frequency.

3. Press the **[KEYER]** switch (#18).

The LED imbedded in the switch will light up, confirming that the built-in Electronic Keyer is now active.

4. Rotate the **[SPEED]** control (#19) to set the desired sending speed. Clockwise rotation of the **[SPEED]** control will increase the keying speed.

○ When you press either the “Dot” or “Dash” side of your paddle, the transmitter will automatically be activated.

5. If you press the **[BK-IN/SPOT]** key (#20) momentarily, “semi-break-in” operation (discussed previously) will be engaged.

6. CW operation utilizing your paddle may now commence.

○ When you utilize your keyer paddle, the transmitter will automatically be activated, and the CW characters (or a string of dots and dashes) will be transmitted. When you release the keyer paddle contacts, transmission will cease after a brief delay; the delay time is user-programmable, per the discussion on page 105.

### 『Advice』

If you reduce power using the **[RF PWR]** control (#72), the ALC meter reading will increase; this is normal and does not indicate any problem whatsoever (because increased ALC voltage is being used to lower the power).

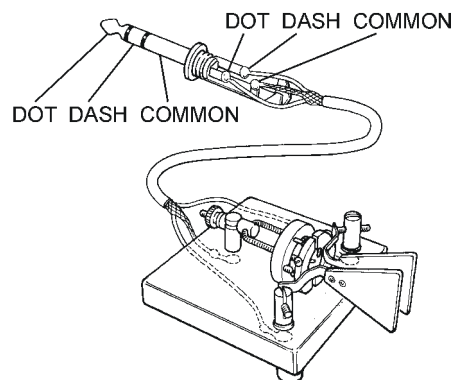
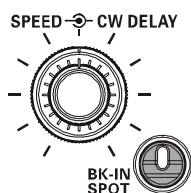
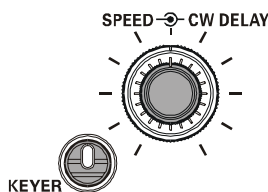
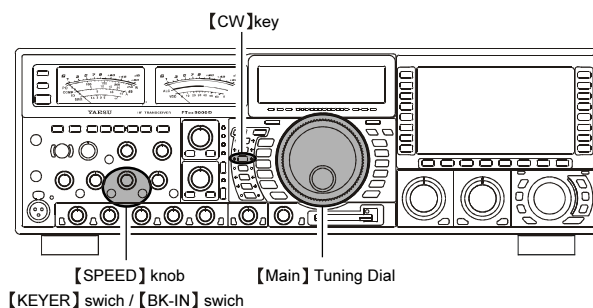
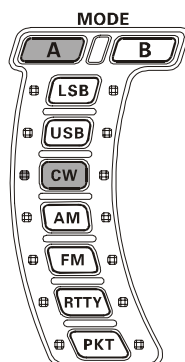

### Full Break-in (QSK) Operation

As shipped from the factory, the FT DX 9000D TX/RX system for CW is configured for “Semi-break-in” operation. However, using Menu item “MODE-CW 047 CW BK-IN,” you may change this setup for full break-in (QSK) operation, whereby the switching is quick enough to hear incoming signals in the spaces between the dots and dashes of your transmission.

1. Press the **[MNU]** key (#92) to open the Menu.
2. Rotate the **[Main]** Tuning Dial knob (#35) to select Menu item “MODE-CW 047 CW BK-IN.”
3. Rotate the **[CLAR/VFO-B]** knob (#86) to set this Menu item to “FULL.”
4. Press and hold in the **[MNU]** key for two seconds to save the new setting and exit.

# CW MODE OPERATION

## USING THE BUILT-IN ELECTRONIC KEYS

A number of interesting and useful features are available during Electronic Keyer operation.

### Setting the Keyer Weight (Dot/Space:Dash ) Ratio

The Menu may be used to adjust the Weight for the built-in Electronic Keyer. The default weighting is 3:1 (a dash is three times longer than a dot or space).

1. Press the **[MNU]** key (#92) to enter the Menu mode.
2. Rotate **[the Main]** Tuning Dial knob (#35) to select Menu item "MODE-CW 049 CW WEIGHT."
3. Rotate the **[CLAR/VFO-B]** key (#86) to set the weight to the desired value. The available adjustment range is for a Dot/Space:Dash ratio of 2.5 ~ 4.5 (default value: 3.0).
4. When you are finished, press and hold in the **[MNU]** key for two seconds to save the new setting and exit to normal operation.

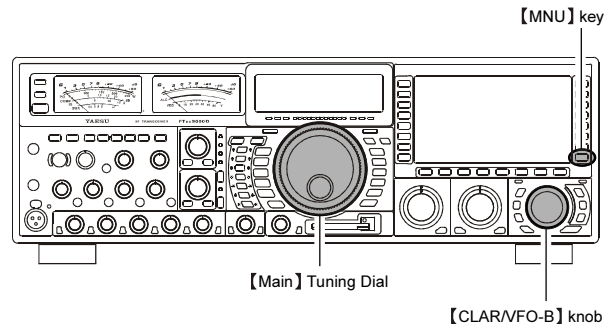

### Selecting the Keyer Operating Mode

The configuration of the Electronic Keyer may be customized independently for the front and rear **[KEY]** jacks of the FT DX 9000D. This permits utilization of Automatic Character Spacing (ACS), if desired, as well as the use of the electronic keyer via the front jack and a straight key or computer-driven keying line via the rear panel.

1. Press the **[MNU]** key (#92) to enter the Menu mode.
2. Rotate the **[Main]** Tuning Dial knob (#35) to select Menu item **MODE-CW 041 F-KEYER TYPE** (for the front **[KEY]** jack) or **MODE-CW 043 R-KEYER TYPE** (for the rear-panel's **[KEY]** jack).
3. Rotate the **[CLAR/VFO-B]** knob (#86) to set the keyer to the desired mode. The available selections are:
  - OFF:** The built-in Electronic Keyer is turned off ("straight key" mode.)
  - BUG:** Dots will be generated automatically by the keyer, but dashes must be sent manually.
  - ELEKEY:** Both dots and dashes will be generated automatically when you use your paddle.
  - ACS:** Same as "ELEKEY" except that the spacing between characters is precisely set by the keyer to be the same length as a dash (three dots in length.)
4. When you are finished, press and hold in the **[MNU]** key for two seconds to save the new setting and exit to normal operation.

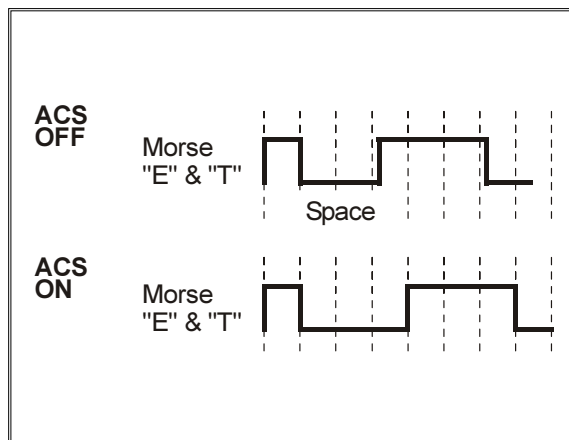
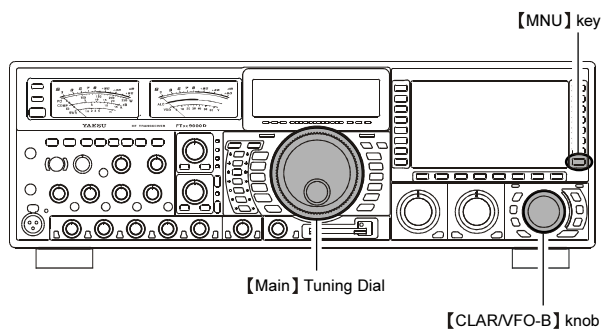

# CW CONVENIENCE FEATURES

## CW SPOTTING (ZERO-BEATING)

“Spotting” (zeroing in on another CW station) is a handy technique for ensuring that you and the other station are precisely on the same frequency.

For everyday operation, the (CW) **[PITCH]** control (#13) allows you to set the center of the receiver passband, as well as the offset pitch of your CW carrier signal, to the tone pitch you prefer to listen to.

The front panel’s Tuning Meter may also be moved so you can adjust your receiver frequency to center the incoming station on the pitch corresponding to that of your transmitted signal.

### Using the SPOT System

If you press and hold in the front panel’s **[BK-IN/SPOT]** key (#20), the Spot tone will be heard. This tone corresponds to the pitch of your transmitted signal, and if you adjust the receiver frequency to match the pitch of the received CW signal to that of the Spot tone, your transmitted signal will be precisely matched to that of the other station.

### 『Advice』

- In a tough DX pile-up, you may actually want to use the SPOT system to find a “gap” in the spread of calling stations, instead of zeroing in precisely on the last station being worked by the DX station. From the DX side, if a dozen or more operators (also using Yaesu’s SPOT system) all call precisely on the same frequency, their dots and dashes merge into a single, long tone that the DX station cannot decipher. In such situations, calling slightly higher or lower may get your call through.
- The bar indicator on the front panel may be utilized for CW frequency adjustment, as well. Its configuration is set via Menu item “DISPLAY 016 BAR DISPLAY SELECT;” at the factory, the bar indicator is already set up for the “CW TUNE” selection.

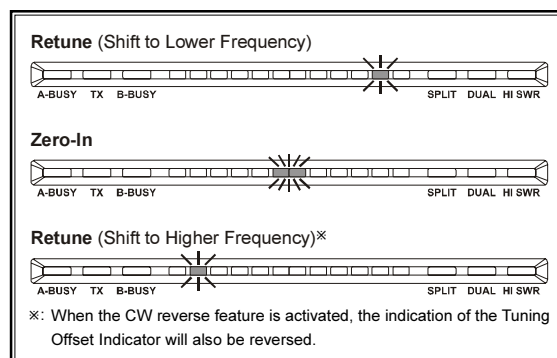

**[PITCH]** knob

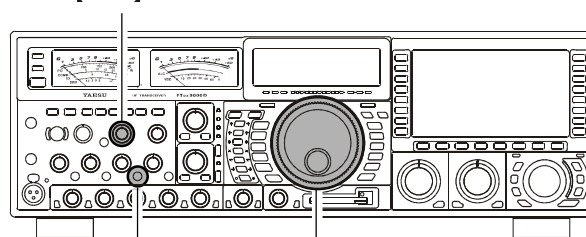

**[BK-IN/SPOT]** switch

**[Main]** Tuning Dial

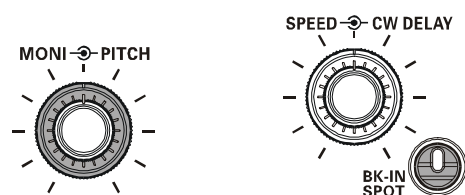

**[PITCH]** knob

**[BK-IN/SPOT]** switch

### 『Quick Point』

- The CW Spotting process utilizes the Spot tone or the bar indicator, with the actual offset pitch being set by the (CW) **[PITCH]** control on the front panel. The offset pitch may be set to any frequency between 300 Hz and 1050 Hz, in 50 Hz steps, and you can either match tones audibly (using the **[BK-IN/SPOT]** key) or align the receiver frequency so that the central LED on the bar indicator lights up. Note that there are 51 “dots” on the bar indicator, and depending on the resolution selected, the incoming CW signal may fall outside the visible range of the bar indicator, if you are not reasonably close to the proper alignment of tones.
- The displayed frequency, on CW, normally reflects the “zero beat” frequency of your offset carrier. That is, if you were to listen on USB on 14.100.00 MHz to a signal with a 700 Hz offset, the “zero beat” frequency of that CW carrier would be 14.000.70 MHz; the latter frequency is what the FT DX 9000D displays, by default. However, you can change the display to be identical to that of what you would see on SSB by using Menu item “MODE-CW 050 CW-FREQ DISPLAY” and setting it to “FREQ” instead of its default “PITCH” setting.

# CW CONVENIENCE FEATURES

## USING CW REVERSE

If you experience a difficult interference situation, where an interfering station cannot readily be eliminated, you may wish to try receiving using the opposite sideband. This may throw the interfering station's frequency in a direction that may lend itself more readily to rejection.

To start, let's use a typical example where you have set the CW mode (using the default "USB" injection) onto the Main (VFO-A) receiver.

- Now be sure your mode selection is still set for the Main (VFO-A) register, and press the **[CW]** mode key (#31) once more. The "LSB" LED will blink for three seconds, indicating that the "LSB" injection side has now been selected.
- When using Dual Receive, just press the **[B]** Mode key (#31), then press the **[CW]** key to engage CW Reverse on the Sub (VFO-B) receiver, in exactly the same way as for the Main receiver.

Press the **[CW]** mode key once more to return to the normal (USB) injection side and cancel CW Reverse operation.

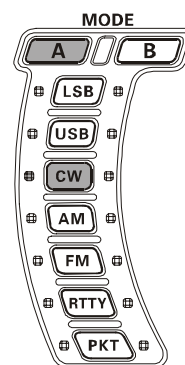
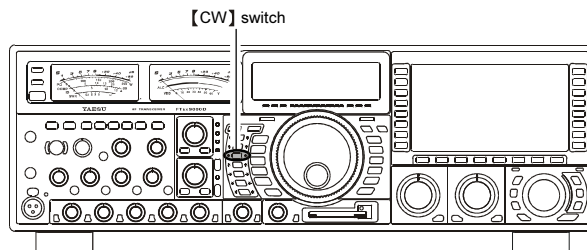

In the illustration, Figure A demonstrates the normal CW injection setup, using the USB side. In Figure B, CW Reverse has been engaged, so as to receive using LSB-side injection to eliminate interference.

The beneficial effect of switching sidebands can clearly be seen in this example.

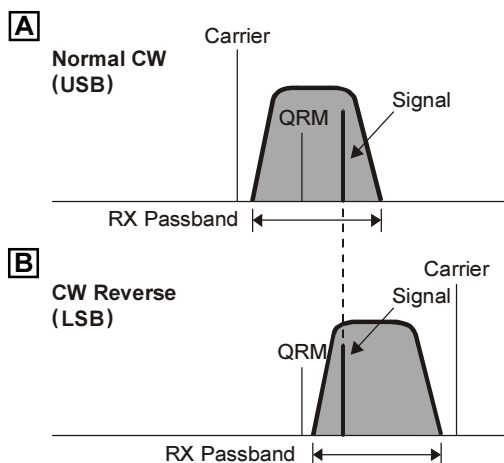

### 『Note』

When CW Reverse is engaged, the Tuning Meter action will concurrently be reversed as to its indication.

When the incoming signal pitch tone is properly aligned, the central LED lights up whether or not CW Reverse is engaged.

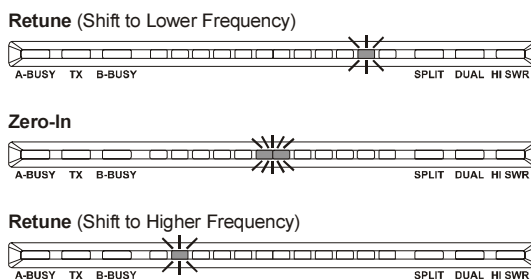



# CW CONVENIENCE FEATURES

## CW DELAY TIME SETTING

During semi-break-in (not QSK) operation, the hang time of the transmitter, after you have finished sending, may be adjusted to a comfortable value consistent with your sending speed. This is the functional equivalent to the “VOX Delay” adjustment used on voice modes; however, this is an independent adjustment used on CW, so you don’t have to change the delay when changing from Voice to CW.

The delay may be varied anywhere between 0 seconds ([CW DELAY] knob set fully counter-clockwise) to 5 seconds (fully clockwise).

1. Press the **[BK-IN/SPOT]** key (#20) momentarily to enable CW transmission (Menu item “MODE-CW 047 CW BK-IN” must be set to “SEMI”).
2. Start sending, and adjust the **[CW DELAY]** knob (#19) so that the hang time is as you prefer for comfortable operation.

### 『Quick Point』

The CW Delay feature is the functional equivalent to the “VOX Delay” adjustment used on voice modes; however, this is an independent adjustment used on CW, so you don’t have to change the delay when changing from Voice to CW.

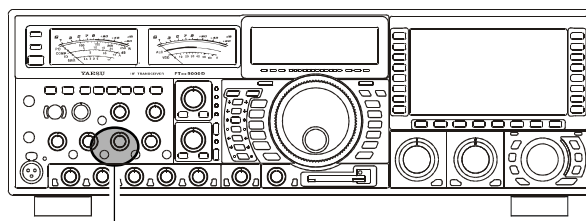

[KEYER] Switch / [CW DELAY] knob

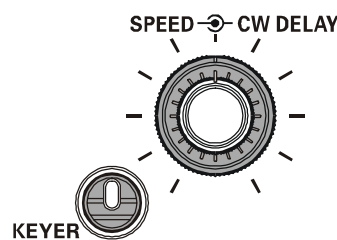

## CW PITCH ADJUSTMENT

Rotation of the front panel’s **[CW PITCH]** control (#13) will allow adjustment of the center frequency of the receiver passband, as well as the pitch of your offset CW carrier, to the tone you prefer. The tone may be varied between 300 Hz and 1050 Hz, in 50 Hz steps.

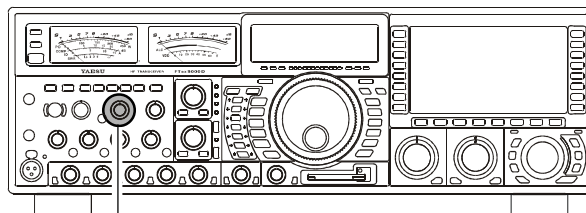

[PITCH] knob

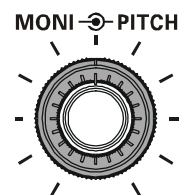

### 『Terminology』

#### CW Pitch

If you tuned to an exact “zero beat” on an incoming CW signal, you could not copy it (“Zero beat” implies a 0 Hz tone). Therefore, the receiver is offset several hundreds of Hz (typically), so as to allow your ear to detect the tone. The BFO offset associated with this tuning (that produces the comfortable audio tone) is called the CW Pitch.



# CW CONVENIENCE FEATURES

## CONTEST MEMORY KEYER

### Message Memory Programming (Using Your Paddle)

1. Press the **[CW]** mode switch (#31) to engage CW operation.
2. Set the **[BK-IN/SPOT]** switch (#20) to Off.
3. Turn the internal Electronic Keyer On by pressing the **[KEYER]** switch (#18), if necessary.

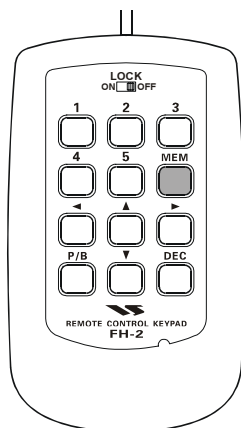

4. Press the FH-2's **[MEM]** key.
5. Press the **[1] ~ [5]** key on the FH-2 to begin the memory storage process.

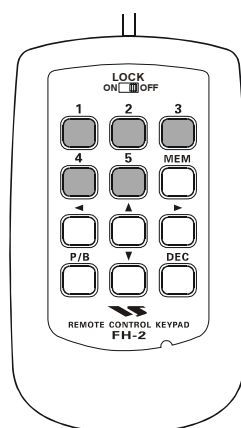

6. Send the desired message using your keyer paddle.
7. Press the **[MEM]** key on the FH-2 once more at the end of your message. Up to 50 characters may be stored among the five memories.

#### 【Note】

You must exercise care in sending to ensure that the spaces between letters and words are accurately done; if your timing is off, the spacing may not come out right in the stored message.

For ease in setting up the keyer memories, we recommend you set Menu item “MODE-CW 041 F-KEYER TYPE” (KEYER FRONT) and/or “MODE-CW 043 R-KEYER TYPE” (KEYER REAR)” to “ACS” (Automatic Character Spacing) while you are programming the keyer memories.

### Checking the CW Memory Contents

1. Be sure that Break-in is still turned Off.
2. Press the FH-2's **[1] ~ [5]** key to check your work. You will hear the results in the sidetone, but no RF energy will be transmitted.

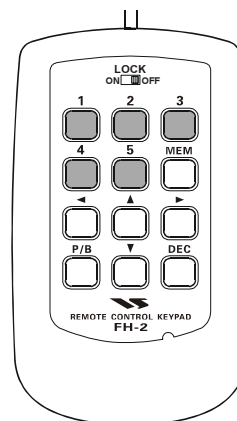

### On-The-Air CW Message Playback

1. Press the **[BK-IN/SPOT]** key (#20) to enable transmission. Either Full- or Semi-break-in will be engaged, depending on the setting of Menu item “MODE-CW 047 CW BK-IN.”
2. Press the FH-2's **[1] ~ [5]** key to transmit the programmed message.

#### 【Note】

If you subsequently decide to use the “Text” technique for memory storage, please note that the contents of a message stored using keyer paddle input will not be transferred over when you select “TEXT” on a particular memory register.

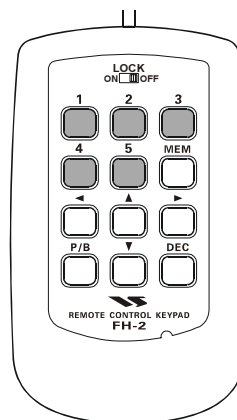

### Transmitting in the Beacon Mode

It is possible to transmit, repetitively in a “Beacon” mode, any message programmed either via paddle input or via the “Text” input method. The time delay between message repeats may be set anywhere between 0 and 255 seconds via Menu item “FH-2 SET 021 BEACON TIME.” If you do not wish the message to repeat in a “Beacon” mode, please set this Menu item to “Off.” Press the **[1] ~ [5]** key, depending on the register into which the Beacon message is stored. Repetitive transmission of the Beacon message will begin. Press one of these keys once more to halt the Beacon transmissions.

# CW CONVENIENCE FEATURES

## CONTEST MEMORY KEYS

### TEXT Memory

The five channels of CW message memory (up to 50 characters total) may also be programmed using a text-entry technique. This technique is somewhat slower than when you send the message directly from your keyer paddle, but accuracy of character spacing is ensured.

『Example 1』: CQ CQ CQ DE W6DXC K} (20 characters)

Now we will utilize another powerful feature of the CW Memory Keyer, the sequential contest number (“Countup”) feature.

『Example 2』: 599 10 200 # K} (15 characters)

### Text Memory Storage

1. Press the **[MNU]** key (#92) to enter the Menu mode.
2. Rotate the **[Main]** Tuning Dial knob (#35) to select the CW Memory Register into which you wish to store the message; we are now selecting the message entry technique (Text entry).  
 FH-2SET 023 CW MEMORY 1  
 FH-2SET 024 CW MEMORY 2  
 FH-2SET 025 CW MEMORY 3  
 FH-2SET 026 CW MEMORY 4  
 FH-2SET 027 CW MEMORY 5
3. Rotate the **[CLAR/VFO-B]** knob (#86) to set the selected Memory Register to “TEXT.”
4. Press and hold in the **[MNU]** key for two seconds to save the new settings and exit.

### 『Advice』

By referring to the chart, you may view the characters available for message entry (both capital and small letters, plus numbers and a few punctuation marks, are available).

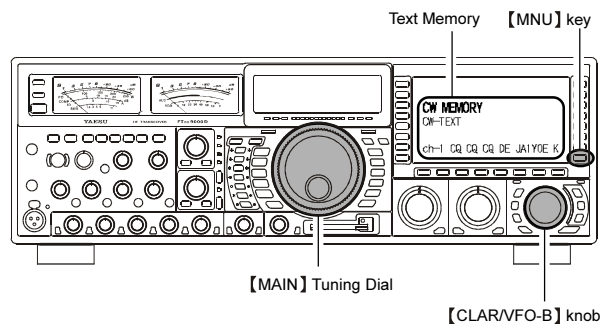

TEXT	CW	TEXT	CW
!	SN	.	AAA
"	AF	/	DN
\$	SX	:	OS
%	KA	;	KR
&	AS	=	BT
'	WG		SK
(	KN	?	IMI
)	KK	\	HH
+	AR	¥	AL
,	MIM	-	IQ
-	DU		

Note that some punctuation and other marks ( { ^ ] [ > < \* ) are listed, but they are displayed only and cannot be transmitted.

### Contest Number Programming

Use this process if you are starting a contest, or if you somehow get out of sync with the proper number in the middle of a contest.

1. Press and hold in the FH-2's **[DEC]** key for two seconds. The current Contest Number will be displayed on the TFT.
2. Rotate the Main Tuning Dial to set the Contest Number to the desired value.
3. Press the **[DEC]** key once more to store the new number.

### Decrementing the Contest Number

Use this process if the current contest number gets slightly ahead of the actual number you want to send (in case of a duplicate QSO, for example).

Press the FH-2's **[DEC]** key. The current Contest Number will be reduced by one. Press the **[DEC]** key as many times as necessary to reach the desired number. If you go too far, use the “Contest Number Programming” technique described above.

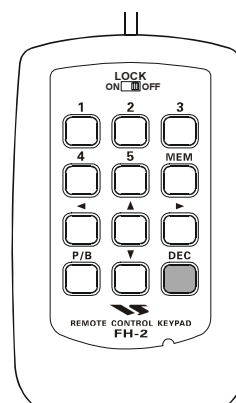

# CW CONVENIENCE FEATURES

## CONTEST MEMORY KEYS

### Text Message Programming

1. Press the **CW】** mode switch (#31) to engage CW operation.
2. Be sure that Break-in is Off by pressing the **【BK-IN/SPOT】** key (#20), if necessary.
3. Press the FH-2's **【MEM】** key.

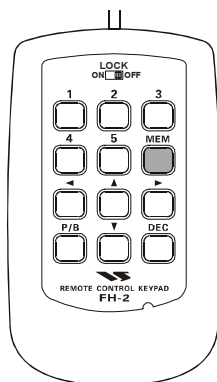

4. Press the FH-2's **【1】 ~ 【5】** key to select the desired Message Memory Register into which you wish to program the text.

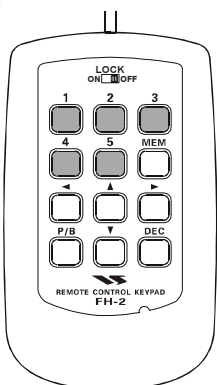

5. Use the FH-2's **【◀】** and **【▶】** keys to set the cursor position and use the **【▲】** and **【▼】** keys to choose the letter/number to be programmed in each slot of the memory. In the case of the second example above, the “}” character designates the slot where the Contest Number will appear.

#### 『Advice』

You may also use the **【Main】** Tuning Dial (#35) and the **【CLAR/VFO-B】** knobs (#86) to program the message characters.

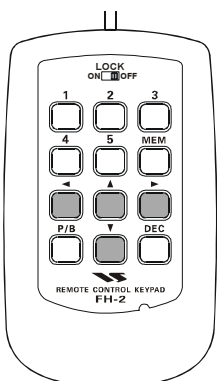

6. Press the FH-2's **【MEM】** key again once all characters have been programmed.

### Checking the CW Memory Contents

1. Be sure that Break-in is still turned Off.
2. Press the FH-2's **【1】 ~ 【5】** key to check your work. You will hear the results in the sidetone, but no RF energy will be transmitted.

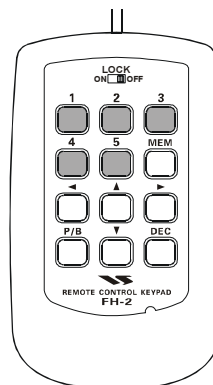

### On-The-Air CW Message Playback

1. Press the **【BK-IN/SPOT】** key to enable transmission. Either Full- or Semi-break-in will be engaged, depending on the setting of Menu item “MODE-CW 047 CW BK-IN.”
2. Press the FH-2's **【1】 ~ 【5】** key to transmit the programmed message.

#### 『Note』

If you subsequently decide to use the “MESSAGE” technique for memory storage, please note that the contents of a message stored using text input will not be transferred over when you select “MESSAGE” on a particular memory register.

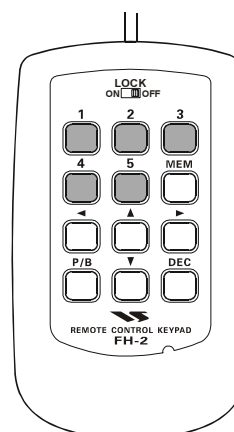

### Correcting/Editing Previously-Stored Characters

Use the **【Main】** Tuning Dial (#35) to select the letter/number to be corrected, then rotate the **【CLAR/VFO-B】** knob (#86) to choose the revised letter/number to be utilized in this slot.

### Deleting Previously-stored Characters

Use the **【Main】** Tuning Dial (#35) to select the last correct letter in the message. Now rotate the **【CLAR/VFO-B】** knob (#86) to select the “}” character; everything after the “}” character will be deleted.

# FM MODE OPERATION

1. Press the **[FM]** mode key (#31) to select the FM operating mode.
  - Be sure that the FM mode is being selected on the proper VFO; check the status of the **[A]** and **[B]** switches above the mode selection keys before making your mode selection.
  - The LED (Red or Orange) corresponding to the VFO on which you selected FM (Main or Sub, respectively), will light up.
2. Rotate the **[Main]** Tuning Dial knob (#35) (in the case of Main (VFO-A) operation) to select the desired operating frequency. If using the optional MD-200A8X Desk Microphone, pressing the **[UP]** or **[DOWN]** button will cause frequency change in 5 kHz steps.
3. Press the microphone's PTT switch (or press the front panel **[MOX]** switch (#1)) to transmit. Speak into the microphone in a normal voice level. Release the PTT or **[MOX]** switch to return to receive.
4. Adjustment of the microphone gain may be accomplished in two ways. At the factory, a default level has been programmed that should be satisfactory for most situations. However, using Menu item "MODE-FM 058 FM MIC GAIN," you may set a different fixed value, or choose the "MCVR" option, which then lets you use the front panel **[MIC]** control (#15) to set the microphone gain in the FM mode. The microphone gain should be set such that deflection of the ALC meter goes all the way to the right side of the ALC meter scale.

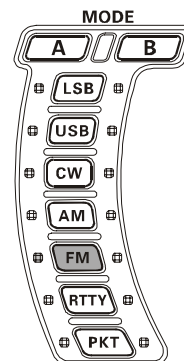
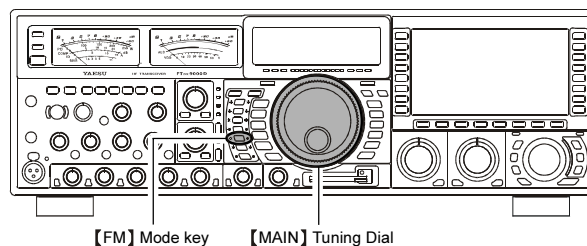

## 『Advice』

- The FH-2 may be used, in the FM mode, for storage of voice memory messages. See page 92.
- FM is only used in the 28 MHz and 50 MHz Amateur bands covered in the FT DX 9000D. Please do not use FM on any other bands.
- Reduction of the setting of the **[RF PWR]** knob (#72) will cause the deflection of the ALC meter to increase; this is normal.



## REPEATER OPERATION

The FT DX 9000D may be utilized on 29 MHz and 50 MHz repeaters.

1. Rotate the **【Main】** Tuning Dial knob (#35) to the output frequency (downlink) from the repeater.
2. If CTCSS Tone operation is desired/needed, press and hold in the **【FM】** Mode key (#31) for two seconds to engage the CTCSS mode.
3. Rotate the **【Main】** Tuning Dial knob to select the desired CTCSS mode. If you just need to send the up-link encoding tone, select “tn.” For encode/decode operation, choose “ts” instead.

The available choices are

“OFF” → “tn” → “ts” → “OFF.”

4. Rotate the **【CLAR/VFO-B】** knob (#86) to select the desired CTCSS Tone to be used. A total of 50 standard CTCSS tones are provided (see the CTCSS Tone Chart).
5. Press the **【FM】** Mode key to select the desired repeater shift direction.

The selections are

“S” → “+” → “-” → “S”

where “S” represents “Simplex” operation (not used on a repeater).

6. Press and hold in the **【FM】** Mode key for two seconds to exit from the repeater setup mode.
7. Close the microphone's PTT switch (or press the **【MOX】** switch (#1)) to begin transmission. You will observe that the frequency has shifted to correspond to the programming you set up in the previous steps. Speak into the microphone in a normal voice level, and release the PTT or **【MOX】** switch to return to the receive mode.

### 『Advice』

The conventional repeater shift used on 29 MHz is 100 kHz, while on the 50 MHz band the shift may vary between 500 kHz and 1.7 kHz (or more). To program the proper repeater shift, use Menu items “MODE-FM 060 RPT SHIFT” (28 MHz) and “MODE-FM 061 RPT SHIFT” (50 MHz), as appropriate.

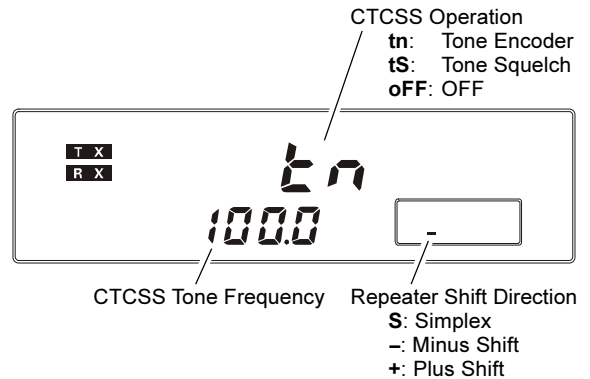
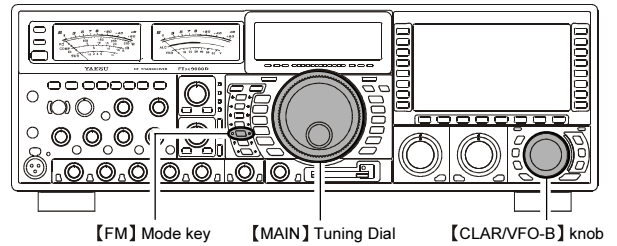

CTCSS Tone Frequency (Hz)							
67.0	69.3	71.9	74.4	77.0	79.7	82.5	85.4
88.5	91.5	94.8	97.4	100.0	103.5	107.2	110.9
114.8	118.8	123.0	127.3	131.8	136.5	141.3	146.2
151.4	156.7	159.8	162.2	165.5	167.9	171.3	173.8
177.3	179.9	183.5	186.2	189.9	192.8	196.6	199.5
203.5	206.5	210.7	218.1	225.7	229.1	233.6	241.8
250.3	254.1	—	—	—	—	—	—

You may also use “Tone Squelch” whereby your receiver will be kept silent until an incoming signal bearing a matching CTCSS tone is received. Your receiver’s squelch will then open in response to the reception of the required tone.

1. Rotate the **【Main】** Tuning Dial knob (#35) to the output frequency (downlink) from the repeater.
2. Press and hold in the **【FM】** Mode key (#31) for two seconds to engage the CTCSS mode.
3. Rotate the **【Main】** Tuning Dial knob to choose “ts.” The available choices are  
“OFF” → “tn” → “ts” → “OFF.”
4. Rotate the **【CLAR/VFO-B】** knob (#86) to select the desired CTCSS Tone to be used. A total of 50 standard CTCSS tones are provided (see the CTCSS Tone Chart).
5. Press and hold in the **【FM】** Mode key for two seconds. On the display, just below the “1 Hz” frequency digit, a small “d” will indicate that the Tone Decoder is engaged.

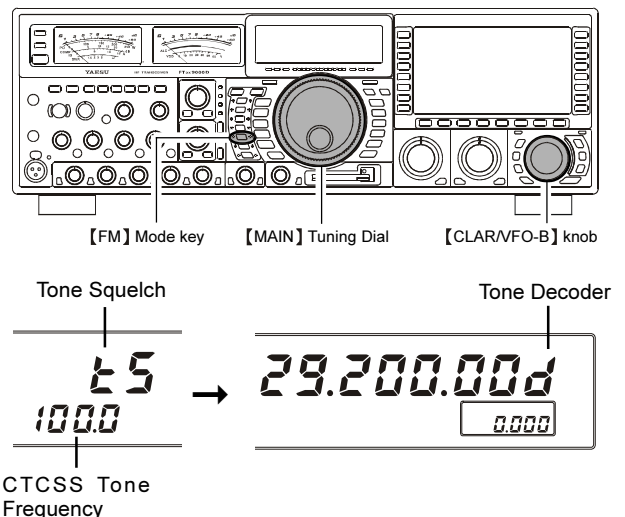

# CONVENIENT MEMORY FUNCTIONS

The FT DX 9000D contains ninety-nine regular memories, labeled 01 through 99, nine special programmed limit memory pairs, labeled P-1L/1U through P-9L/9U, and five QMB (Quick Memory Bank) memories, labeled C1 ~ C5. Each stores various settings, not only the main band's (VFO-A) frequency and mode (See below). By default, the 99 regular memories are contained in one group; however, they can be arranged in up to six separate groups, if desired.

## 『Quick Point』

The FT DX 9000D's memory channels store the following data (not just the operating frequency):

- Frequency
- Mode
- Clarifier status and its Offset Frequency
- ANT status
- IPO status
- Roofing filter status and its Bandwidth
- Noise Blanker status
- CONTOUR status and its Peak Frequency
- DSP Noise Reduction (DNR) status and its Reduction algorithm selection.
- DSP Notch filter (NTCH) status
- NAR bandwidth status
- DSP Auto Notch filter (DNF) status
- Repeater Shift Direction and Shift Frequency
- CTCSS status and Tone Frequency

Memory channels may be grouped into as many as six convenient batches, for easy identification and selection. For example, you might want to set aside memory groups for AM BC stations, shortwave broadcast stations, contest frequencies, repeater frequencies, and PMS limits, or any other groupings you like.

Each memory group is capable of holding up to 22 memory channels (the Group size is fixed). When a memory channel is grouped, the channel numbers change to correspond to the chart below:

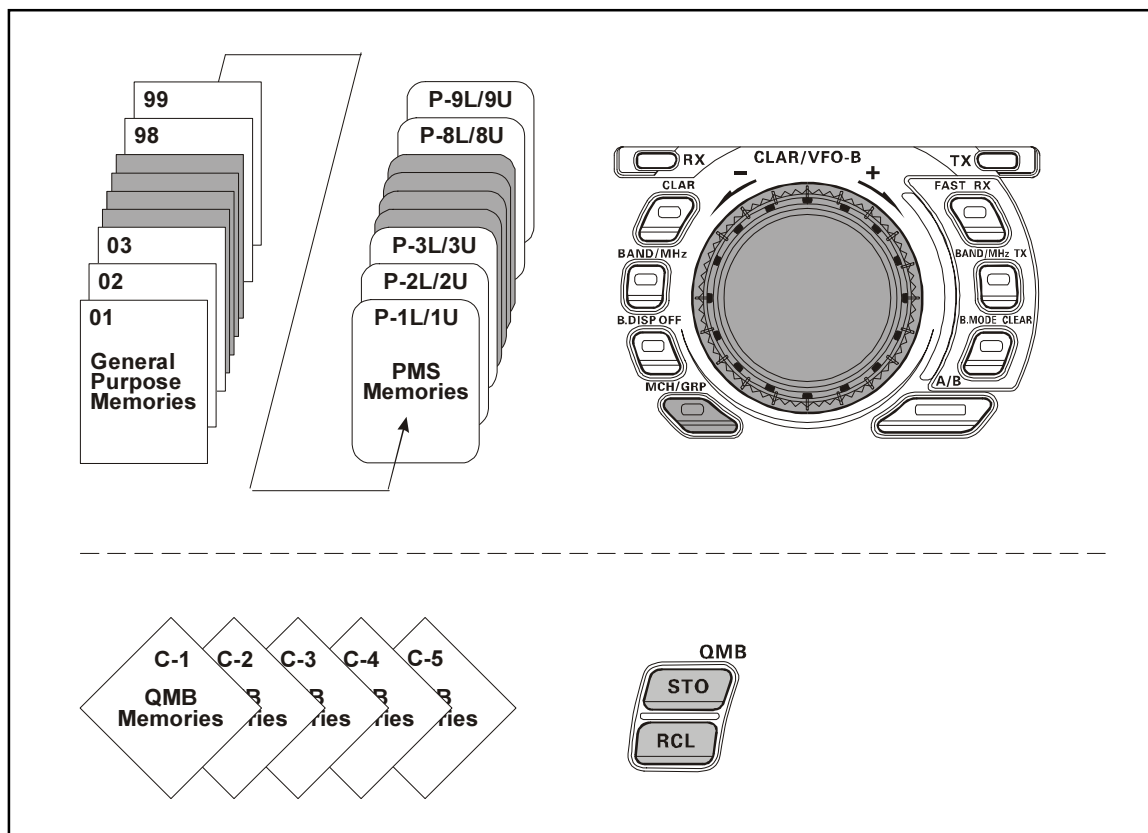

# QMB (QUICK MEMORY BANK)

The Quick Memory Bank is comprised of five memories (labeled C1 ~ C5) independent from the regular and PMS memories. These can quickly store operating parameters for later recall.

## QMB CHANNEL STORAGE

1. Tune to the desired frequency on the Main (VFO-A) band.
2. Press the blue (QMB) **【STO】** key (#32). The “beep” will confirm that the contents of the Main (VFO-A) band have been written to the currently-available QMB memory.

If you repeatedly press the (QMB) **【STO】** key, the QMB memories will be written in the following order:

C-2 → C-3 → C-4 → C-5 → C-1

Once all five QMB memories have data on them, previous data (starting with channel C1) will be over-written on a first-in, first-out basis.

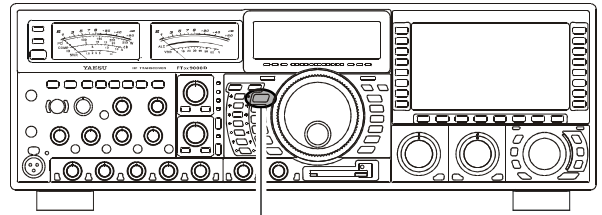

[QMB STO] key

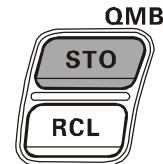

## QMB CHANNEL RECALL

1. Press the (QMB) **【RCL】** key (#32). The display will indicate “QMB” and the current QMB channel's data will be shown on the main frequency display field.
2. Repeatedly pressing the (QMB) **【RCL】** key will toggle you through the QMB channels:

C-2 → C-3 → C-4 → C-5 → C-1

### 『Advice』

You may change the QMB channel's frequency by rotating the **【Main】** Tuning Dial (#35) (Memory Tune Operation, described details on page 117).

- “**MT**” will replace “**MR**” in the multi-panel window, indicating you are in the “Memory Tune” mode.
- During Memory Tune operation, you may change operating modes, and engage and offset the Clarifier, if desired.  
Press the **【V/M】** switch momentarily to return to the originally-memorized frequency of the current memory channel. One more press of the **【V/M】** key will return you to VFO operation.

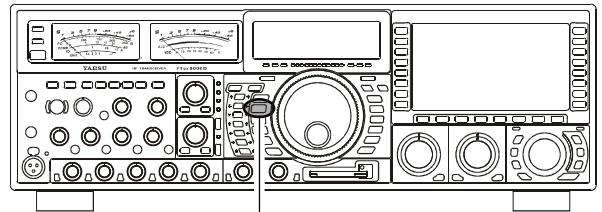

[QMB RCL] key

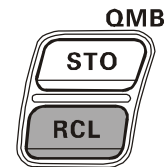

# MEMORY GROUPS

## MEMORY GROUP ASSIGNMENT

1. Press the **【MNU】** key (#92) to enter the Menu mode.
2. Rotate the **【Main】** Tuning Dial knob (#35) to select Menu item “GENERAL 031 MEM GROUP.”  
Rotate the **【CLAR/VFO-B】** knob (#86) to set this Menu item to “ENABLE” (the default setting is “DISABLE”).
3. Press and hold in the **【MNU】** key for two seconds to save the new setting and exit. Operation will now be restricted to the six Memory Groups.  
To cancel Memory Group operation, repeat steps (1) through (3) above, choosing “DISABLE” in step (2).

### 『Advice』

Note that for the PMS memory group, the PMS memories “P1L” through “P9U” will be so designated, so as to avoid confusion.

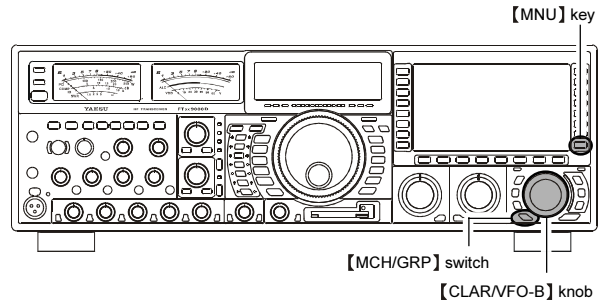

Memory Channel Number	
Groups Memory “OFF”	Groups Memory “ON”
01 ~ 19	1-01 ~ 1-19
20 ~ 39	2-01 ~ 2-20
40 ~ 59	3-01 ~ 3-20
60 ~ 79	4-01 ~ 4-20
80 ~ 99	5-01 ~ 5-20
P-1L/1U ~ P-9L/9U	P-1L/1U ~ P-9L/9U

## CHOOSING THE DESIRED MEMORY GROUP

You may recall memories just within a particular Memory Group, if desired.

1. Press the **【V/M】** key (#45), if necessary, to enter the Memory mode.
2. Press and hold in the **【MCH/GRP】** key (#85) (below and to the left of the **【CLAR/VFO-B】** knob (#86)) for two seconds. The imbedded LED inside the switch will light up.
3. Rotate the **【CLAR/VFO-B】** knob to select the desired Memory Group.

To exit from Memory Group operation, press and hold in the **【MCH/GRP】** key for two seconds once more.

### 『Advice』

- You will now be operating using memories only within the selected Memory Group.
- If no channels have been assigned to a particular Memory Group, you will not have access to that Group.

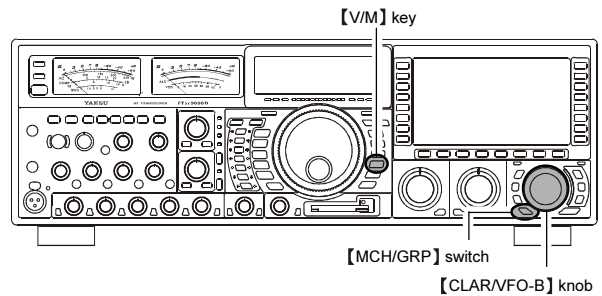

# MEMORY OPERATION

The memory system of the FT DX 9000D allows storage and recall of up to 99 memories, each storing frequency, mode, and a wide variety of status information detailed previously. Memories may be grouped into as many as six Memory Groups, and additionally you get nine pairs of band-limit (PMS) memories along with five QMB (Quick Memory Bank) memories.

## MEMORY STORAGE

1. Set the Main (VFO-A) band up with all frequency, mode, and status the way you want to have it stored.
2. Press the **[A▶M]** button (#47) momentarily (the current channel number will start blinking); the contents of the current memory channel will be shown on the Sub (VFO-B) display field.
3. Press the **[MCH/GRP]** key (#85) momentarily. When you press the **[MCH/GRP]** switch, the Red LED imbedded within the switch should light up, indicating that you are ready to choose a channel into which to store the data.

### 『Advice』

- If the Red LED imbedded in the **[MCH/GRP]** switch does not light up, check to be sure that the orange lamp to the right of the **[CLAR/VFO-B]** knob (#86) is not illuminated. It is, press the **[A/B]** switch (#90) to make it go out, then press the **[MCH/GRP]** key again.
4. Rotate the **[CLAR/VFO-B]** knob to select the memory channel onto which you wish to store the data. If you have selected a channel on which data is already stored, that frequency will appear on the Sub (VFO-B) band's frequency display field.
  5. Press and hold in the **[A▶M]** key for two seconds to store the frequency and other data into the selected memory channel. A double beep will confirm that you have held the **[A▶M]** key in long enough.

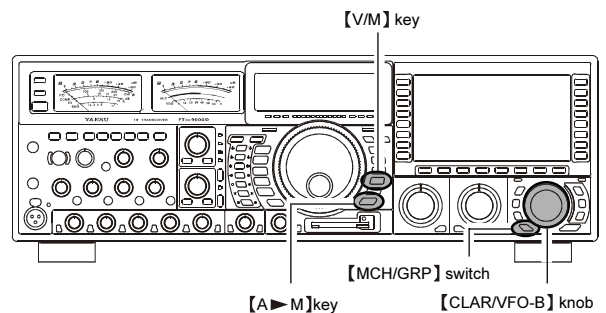

## MEMORY CHANNEL RECALL

1. Press the **[V/M]** switch (#45), if necessary, to enter the Memory mode. A memory channel number will appear in the multi-panel window.
2. Press the **[MCH/GRP]** key (#85) momentarily. The Red LED inside the switch will light up, indicating that you are ready to recall a memory channel.

### 『Advice』

- If the Red LED imbedded in the **[MCH/GRP]** switch does not light up, check to be sure that the orange lamp to the right of the **[CLAR/VFO-B]** knob (#86) is not illuminated. It is, press the **[A/B]** switch (#90) to make it go out, then press the **[MCH/GRP]** key again.
3. After pressing the **[MCH/GRP]** key, you may rotate the **[CLAR/VFO-B]** knob to select the desired memory channel.

### 『Advice』

To work within a particular Memory Group, press and hold in the **[MCH/GRP]** key for two seconds. The imbedded LED will glow Orange; now press the **[MCH/GRP]** key momentarily, and the LED will change to Red; you may now choose the channel within the selected Memory Group.

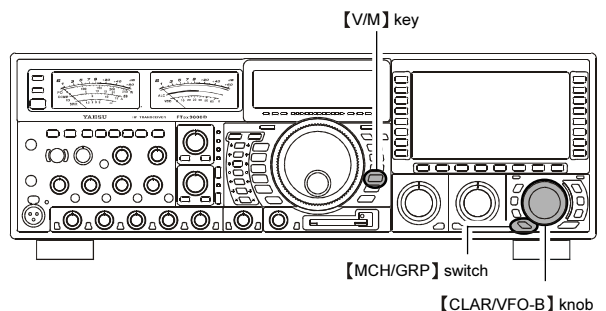

# MEMORY OPERATION

## Checking a Memory Channel's Status

Before programming a channel into memory, you can check the current contents of that channel without the danger of over-writing the data accidentally.

1. Press the **[MCH/GRP]** key (#85) momentarily. The imbedded LED will glow Red, indicating that you are now ready to view memory channel contents.

### Advice

If the Red LED imbedded in the **[MCH/GRP]** switch does not light up, check to be sure that the orange lamp to the right of the **[CLAR/VFO-B]** knob (#86) is not illuminated. If it is, press the **[A/B]** switch (#90) to make it go out, then press the **[MCH/GRP]** key again.

2. Press the **[A▶M]** key (#47). The data stored in the currently-selected memory channel will be displayed in the Sub (VFO-B) band frequency field. However, since you are only checking the contents of the memory channel, your radio will not have moved to the memory channel's frequency.
3. Rotate the **[CLAR/VFO-B]** knob to select other memory channels. To exit from the Memory Check mode, press the **[A▶M]** key once more.

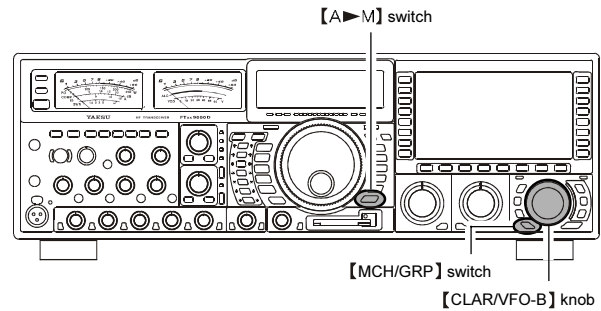

### Advice

- While the Memory Check function is engaged, the memory channel number will blink.
- While operating in the VFO mode, using Memory Check, you may store the current contents of the VFO into the selected memory by pressing and holding in the **[A▶M]** key for two seconds (until the double beep). Conversely, if you wish to write the contents of the current memory into the Main (VFO-A) register, press and hold in the **[M▶A]** key (#46) for two seconds.

## ERASING MEMORY CHANNEL DATA

1. Press the **[MCH/GRP]** key (#85) momentarily. The imbedded LED will glow Red, indicating that you are now ready to view memory channel contents.

### Advice

- If the Red LED imbedded in the **[MCH/GRP]** switch does not light up, check to be sure that the orange lamp to the right of the **[CLAR/VFO-B]** knob (#86) is not illuminated. If it is, press the **[A/B]** switch (#90) to make it go out, then press the **[MCH/GRP]** key again.

2. Press the **[A▶M]** key (#47). The data stored in the currently-selected memory channel will be displayed in the Sub (VFO-B) band frequency field.
3. Rotate the **[CLAR/VFO-B]** knob (#86) to select the memory channel that you would like to erase.
4. Press the **[LOCK]** switch (#37) to erase the contents of the selected memory channel.

### Advice

- After erasure, only the memory channel number will remain; the frequency data will disappear from the display.
- If you make a mistake and wish to restore the memory's contents, just repeat steps (1) through (3) above.

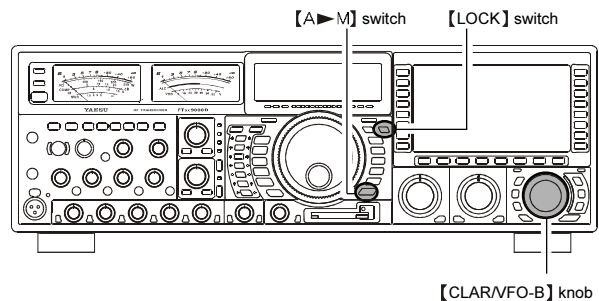



## MOVING MEMORY DATA TO THE MAIN (VFO-A) BAND

You may transfer the contents of the currently-selected memory channel into the Main (VFO-A) band register, if you like.

1. Press the **[V/M]** switch (#45), as necessary, to go to the Memory mode. The memory channel number will appear in the multi-panel window.
2. Press the **[MCH/GRP]** key (#85) momentarily. The Red LED inside the switch will light up, indicating that you are ready to recall a memory channel.

### 『Advice』

If the Red LED imbedded in the **[MCH/GRP]** switch does not light up, check to be sure that the orange lamp to the right of the **[CLAR/VFO-B]** knob (#86) is not illuminated. If is, press the **[A/B]** switch (#90) to make it go out, then press the **[MCH/GRP]** key again.

3. Rotate the **[CLAR/VFO-B]** knob (#86) to select the memory channel the contents of which you wish to transfer to the Main (VFO-A) band.
4. Press and hold in the **[M▶A]** key (#46) for two seconds, until you hear the double beep. The data in the selected memory channel will now be transferred to the Main (VFO-A) band.

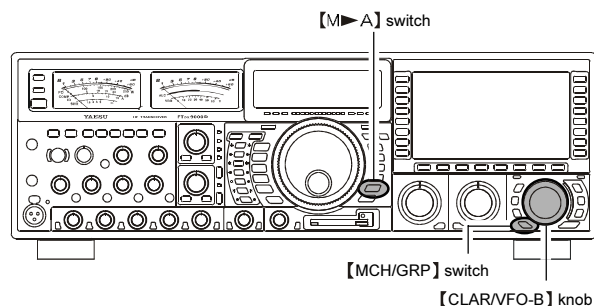

### 『Advice』

This transfer of data to the Main (VFO-A) band does not affect the original contents of the memory channel; this is a “copy” function that leaves the memory contents unchanged.

## Memory Tune Operation

You may freely tune off of any memory channel in a “Memory tune” mode that is similar to VFO operation. So long as you do not over-write the contents of the current memory, Memory tune operation will not alter the contents of the memory channel.

1. Press the **[V/M]** switch (#45) to recall any memory channel.
2. Rotate the **[Main]** Tuning Dial knob (#35); you will now observe that the memory channel’s frequency is changing.
  - “**MT**” will replace “**MR**” in the multi-panel window, indicating you are in the “Memory Tune” mode.
  - During Memory Tune operation, you may change operating modes, and engage and offset the Clarifier, if desired. Press the **[V/M]** switch momentarily to return to the originally-memorized frequency of the current memory channel. One more press of the **[V/M]** key will return you to VFO operation.

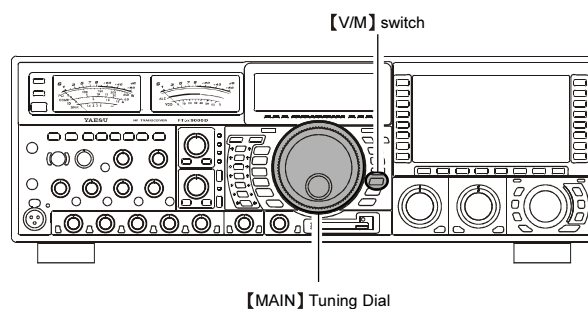

### 『Note』

Computer software programs utilizing the CAT system interface port may presume that the transceiver is operating in the VFO mode for certain features like “band mapping” and/or frequency logging. Because the “Memory Tune” mode so closely resembles the VFO mode, be sure that you have the FT DX 9000D operating in a control mode compatible with your software’s requirements. Use the VFO mode if you’re not sure.

# OPERATION ON ALASKA EMERGENCY FREQUENCY: 5167.5 kHz (U.S. VERSION ONLY)

Section 97.401(d) of the regulations governing amateur radio in the United States permit emergency amateur communications on the spot frequency of 5167.5 kHz by stations in (or within 92.6 km of) the state of Alaska. This frequency is only to be used when the immediate safety of human life and/or property are threatened, and is never to be used for routine communications.

The FT DX 9000D includes the capability for transmission and reception on 5167.5 kHz under such emergency conditions via the Menu system. To activate this feature:

1. Press the **【MNU】** key (#92), located at the bottom right side of the TFT display.
2. Rotate the **【Main】** Tuning Dial knob (#35) to select “TX GNRL 160 EMERGENCY FREQ TX.”
3. Rotate the **【CLAR/VFO-B】** knob (#86) select “ENABLE.”
4. Press and hold in the **【MNU】** key for 2 second to save the new setting and exit to normal operation. Emergency communication on this spot frequency is now possible.
5. Press the **【V/M】** key (#45), as necessary, to enter the Memory mode, then rotate the **【CLAR/VFO-B】** knob to select the emergency channel (M-EMG), which is found between channels “P-9U” and “01.”

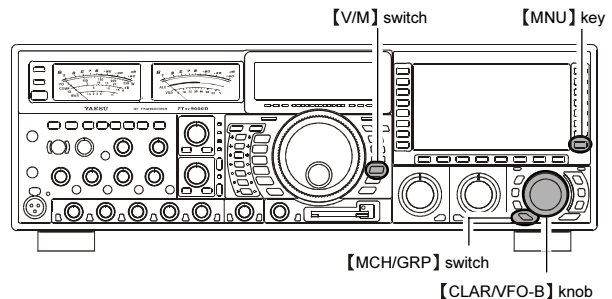

Note that the receive-mode CLARIFIER functions normally while using this frequency, but variation of the transmit frequency is not possible. Activation of “TX GNRL 160 EMERGENCY FREQ TX” does not enable any other out-of-amateur-band capability on the transceiver. The full specifications of the FT DX 9000D are not necessarily guaranteed on this frequency, but power output and receiver sensitivity should be fully satisfactory for the purpose of emergency communication.

If you wish to disable operation capability on the Alaska Emergency Frequency, repeat the above procedures, but set “TX GNRL 160 EMERGENCY FREQ TX” to “OFF” in step 3.

In an emergency, note that a half-wave dipole cut for this frequency should be approximately 45’3” on each leg (90’6” total length). Emergency operation on 5167.5 kHz is shared with the Alaska-Fixed Service. This transceiver is not authorized for operation, under the FCC’s Part 87, for aeronautical communications.

Downloaded by  
RadioAmateur.EU

# OPERATION ON THE 60-METER BAND (U.S. VERSION)

The recently-released 60-meter band is covered, in the FT DX 9000D, by five special, fixed memory channels. These channels are set to USB, and they appear between the “last” PMS channel (“P9U”) and the first “regular” memory channel (Channel 1).

The five channels are:

Channel Number	Frequency
US1	5.332.000 MHz
US2	5.348.000 MHz
US3	5.368.000 MHz
US4	5.373.000 MHz
US5	5.405.000 MHz

To operate on the 60-meter band channels, press the **【V/M】** key (#45), if necessary, to enter the Memory mode, then rotate **【CLAR/VFO-B】** knob (#86) to select the desired channel from the above selections.

Be sure to observe all current regulations regarding Effective Radiated Power (E.R.P.) while operating on the 60-meter band.

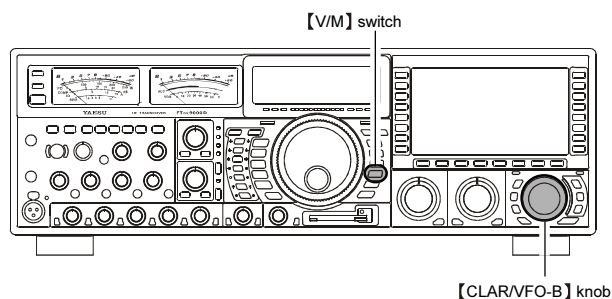

# VFO AND MEMORY SCANNING

You may scan with the VFO or the memories of the FT DX 9000D, and the radio will halt the scan on any station with a signal strong enough to open the receiver's squelch.

## VFO SCANNING

1. Press the **[A]** or **[B]** switch (#31) to select the VFO to be scanned.
2. Set the VFO to the frequency on which you would like to begin scanning.
3. Rotate the **[SQL]** control (#21) for Main (VFO-A) band scan, #63 for Sub (VFO-B) band scan so that the background noise is just silenced.
4. Press and hold in the microphone's **[UP]** or **[DOWN]** key for 2 second to start scanning in the specified direction.
  - If the scanner halts on an incoming signal, the decimal point between the "MHz" and "kHz" digits of the frequency display will blink.
  - If the incoming signal disappears, scanning will resume in about five seconds.
  - On the SSB/CW and SSB-based Data modes, the scanner will pause on a received signal, then will step across the signal very slowly, giving you time to stop the scan, if you like. In these modes on the VFO, the scanner does not stop, however.

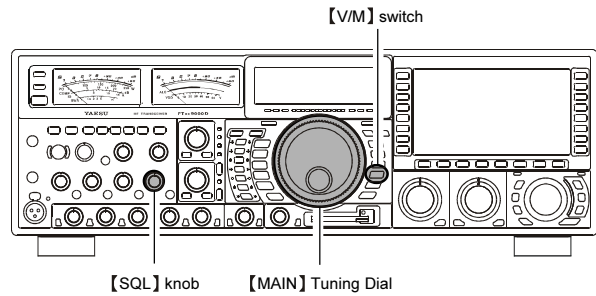

## MEMORY SCAN

1. Set the transceiver up in the memory mode by pressing the **[V/M]** key, if necessary.
2. Rotate the Main (VFO-A) receiver's **[SQL]** control (#21) so that the background noise is just silenced.
3. Press and hold in the microphone's **[UP]** or **[DOWN]** key for 2 second to start scanning in the specified direction.
  - If the scanner halts on an incoming signal, the decimal point between the "MHz" and "kHz" digits of the frequency display will blink.
  - If the incoming signal disappears, scanning will resume in about five seconds.

### 『Advice』

- During Memory Group operation, only the channels within the current Memory Group will be scanned.
- If the scan has paused on a signal, pressing the microphone's **[UP]** or **[DOWN]** key will cause scanning to resume instantly.
- If you press the microphone's PTT switch during scanning, the scanner will halt at once. Pressing the PTT switch during scanning will not cause transmission, however.
- You may select the manner in which the scanner resumes while it has paused on a signal, using Menu item "GENERAL 037 MIC SCAN RESUME." During memory scanning, the default "TIME" setting will cause the scanner to resume scanning after five seconds; you may change it, however, to resume only after the carrier has dropped out, if you like See page 134.

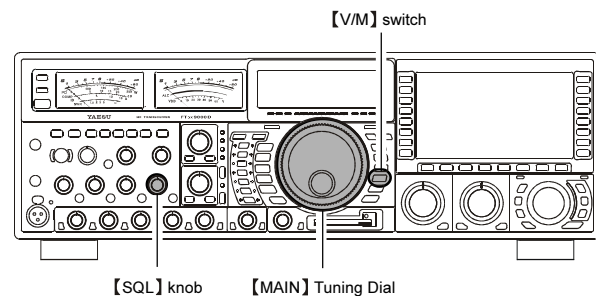

### 『Quick Point』

If you have no interest in scanning, and wish to prohibit the microphone's **[UP]**/**[DOWN]** keys from initiating scanning, you may disable scanning control from the microphone using Menu Item "GENERAL 036 MIC SCAN" (set it to "DISABLE").

To limit scanning (and manual tuning) within a particular frequency range, you can use the Programmable Memory Scanning (PMS) feature, which utilizes nine special-purpose memory pairs (“P-1L/P-1U” through “P-9L/P-9U”). The PMS feature is especially useful in helping you to observe any operating sub-band limits which apply to your Amateur license class.

1. Store the Lower and Upper tuning/scanning limit frequencies into the memory pair “P1L” and “P1U,” respectively, or any other “L/U” pair of memories in the special PMS memory area. See page 115 for details regarding memory storage.
2. Press the **[V/M]** key (#45) to enter the Memory mode.
3. Press the **[MCH/GRP]** key (#85) momentarily. When you press the **[MCH/GRP]** switch, the Red LED imbedded within the switch should light up, indicating that you are ready to choose a channel into which to store the data.

### 『Advice』

- If the Red LED imbedded in the **[MCH/GRP]** switch does not light up, check to be sure that the orange lamp to the right of the **[CLAR/VFO-B]** knob (#86) is not illuminated. If is, press the **[A/B]** switch (#90) to make it go out, then press the **[MCH/GRP]** key again.
4. Rotate the **[CLAR/VFO-B]** knob to elect memory channel “P1L” or “P1U.”
  5. Rotate the Main (VFO-A) receiver’s **[SQL]** control (#21) so that the background noise is just silenced.
  6. Turn the **[Main]** Tuning Dial knob (#35) slightly (to activate memory tuning). Tuning and scanning are now limited to the range within the P1L/P1U limits until you press the **[V/M]** key to return to memory channel or Main band (VFO-A) operation.
  7. Press and hold in the microphone’s **[UP]** or **[DOWN]** key for 2 second to start scanning in the specified direction.
    - If the scanner halts on an incoming signal, the decimal point between the “MHz” and “kHz” digits of the frequency display will blink.
    - If the incoming signal disappears, scanning will resume in about five seconds.
    - On the SSB/CW and SSB-based Data modes, the scanner will pause on a received signal, then will step across the signal very slowly, giving you time to stop the scan, if you like. In these modes on the VFO, the scanner does not stop, however.
    - If the scan has paused on a signal, pressing the microphone’s **[UP]** or **[DOWN]** key will cause scanning to resume instantly.
    - If you rotate the Main Tuning Dial in the opposite direction from the current scanning direction (in other words, you rotate the dial to the left when scanning toward a higher frequency), the direction of the scan will reverse.

If you press the microphone’s PTT switch during scanning, the scanner will halt at once. Pressing the PTT switch during scanning will not cause transmission, however.

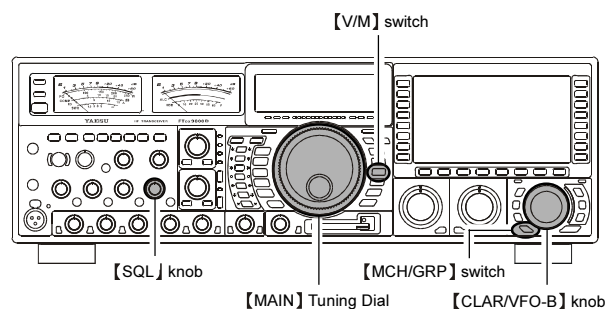

# PACKET OPERATION

Packet operation is easily accomplished on the FT DX 9000D by connecting your TNC (Terminal Node Controller) to the transceiver, per the illustration. “Packet” operation also applies to SSB-based AFSK data modes, such as PSK31, etc.

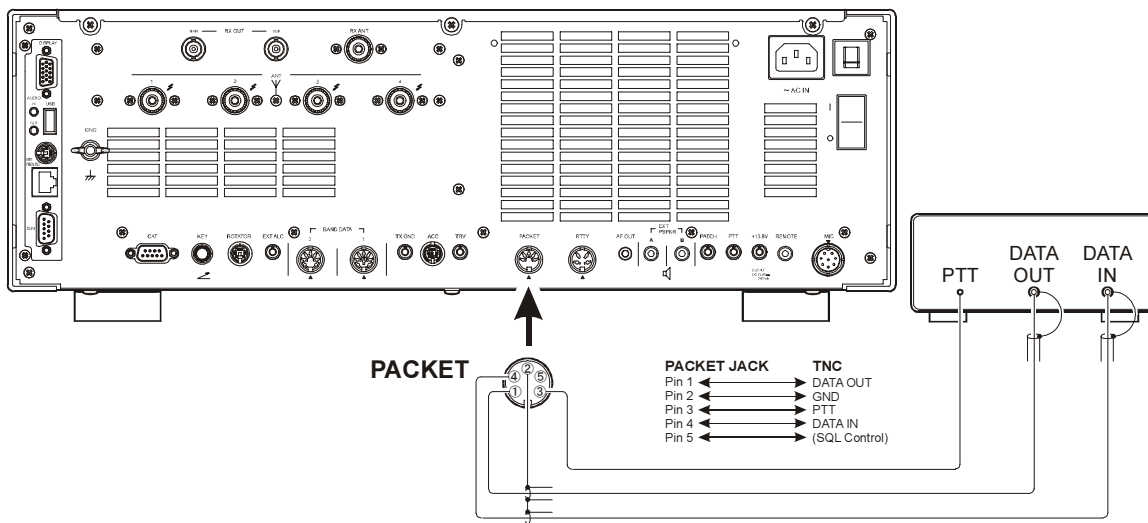

## PACKET SETUP (INCLUDING SUBCARRIER FREQUENCY)

Before operation can commence, some basic setup procedures must be performed, using the Menu, to configure your radio for the data mode to be used.

Menu Mode	Setup
MODE-PKT 062 PKT DISP	0Hz
MODE-PKT 063 PKT GAIN	128
MODE-PKT 064 PKT SHIFT	1000Hz

## BASIC SETUP

- Press the **【PKT】** Mode switch (#31).
  - For HF operation, SSB-based Data operation is generally used. One press of the **【PKT】** switch will engage Packet operation in the “LSB” mode (by default). Both the “PKT” and “LSB” LEDs will become illuminated.
  - If you need to do FM-based 1200-baud packet on the 29/50 MHz bands, press the **【PKT】** switch once more to engage the “PKT-FM” mode. The “PKT” and “FM” LEDs will both become illuminated.
- When the “transmit” command is received from the TNC, the transmitter of the FT DX 9000D will automatically be engaged. Likewise, the command to return to receive will cause the radio to revert to the receive mode.
  - If you need to adjust the output level from the radio from the “DATA OUT” pin of the **【PACKET】** jack (pin 4), please do so at the TNC side. For the input level from the TNC, as applied to the DATA IN pin of the **【PACKET】** jack (pin 1), please use Menu item “MODE-PKT 063 PKT GAIN.”
  - During Packet operation via the rear panel’s **【PACKET】** jack, the front and rear panel MIC jacks are both cut off, so you won’t have a “live microphone” problem during data operation.

### 【Note】

If you anticipate making data transmissions of longer than a few minutes, we recommend that you use the **【RF PWR】** control to reduce the transmitter power to 1/2 ~ 1/3 of its normal maximum.

### 【Quick Point】

#### PACKET Jack Specifications

- DATA IN (Pin 1)**  
Input Level: 17mVrms  
Input Impedance: 10 kOhms
- DATA OUT (Pin 4)**  
(Pin 4: Fixed level, does not respond to setting of AF GAIN or SQL control.)  
Output Level: 700 mVp-p max.  
Output Impedance: 10 kOhms



# RTTY (RADIO TELETYPE) OPERATION

Most RTTY operation today is accomplished using a TNC or other computer-based system that utilizes AFSK tones. As such, the previous discussion on LSB-mode “Packet” operation will apply for Baudot operation, as well. For RTTY operation using a Terminal Unit (TU) or the “FSK” output from a TNC, please see the discussion below. See also the illustration for details regarding connection to your TU.

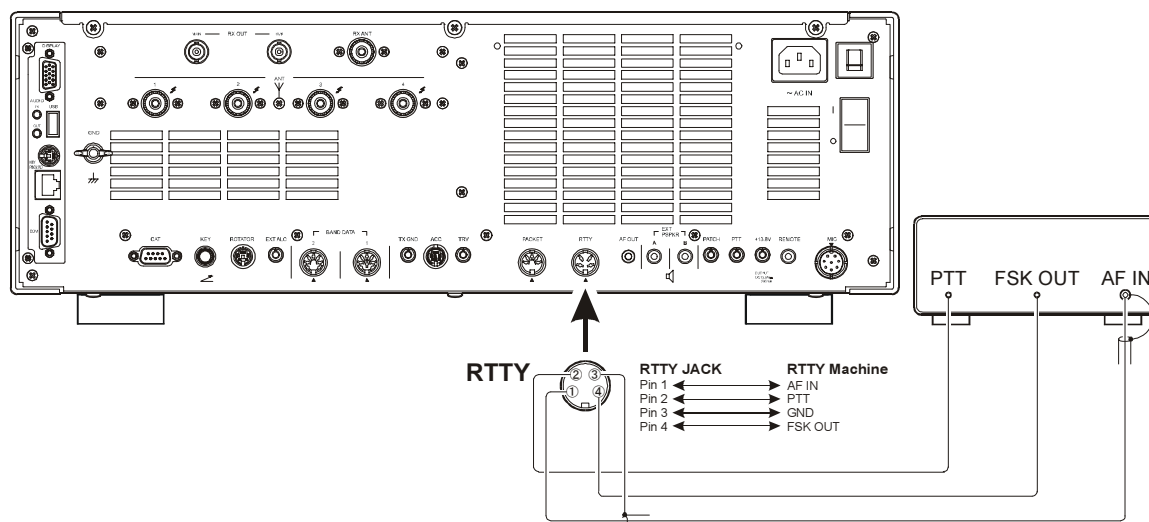

## SETTING UP FOR RTTY OPERATION

Before commencing RTTY operation, please direct your attention to the setup steps below.

Menu Mode	Setup
MODE-RTY 065 POLARITY-R	NOR/REV
MODE-RTY 066 POLARITY-T	NOR/REV
MODE-RTY 067 RTTY SHIFT	170Hz
MODE-RTY 068 RTTY TONE	2125Hz

## BASIC SETUP

- Press the **[RTTY]** Mode switch (#31) to enter the RTTY mode.
  - One press of the **[RTTY]** Mode switch will engage RTTY operation using “LSB” injection, which is generally used in the Amateur service. In this mode, both the “RTTY” and “LSB” LEDs will light up.
  - To switch to USB-side injection in RTTY, press the **[RTTY]** mode switch once more. Both the “RTTY” and “USB” LEDs will now be illuminated. Repeatedly pressing the **[RTTY]** button will toggle between LSB and USB injection on RTTY.
- When you begin typing on your TU or computer keyboard, the command to transmit should automatically be sent to the transceiver, causing it to enter the transmit mode.

### 『Note』

- If you anticipate making data transmissions of longer than a few minutes, we recommend that you use the **[RF PWR]** control (#72) to reduce the transmitter power to 1/2 ~ 1/3 of its normal maximum.

### 『Advice』

- There is no adjustment of the receiver output level from Pin 2 (“RX OUT”) of the **[RTTY]** jack on the rear panel; please make any needed level adjustments at the TU side.
- The Mark/Space Shift utilized in most Amateur RTTY operation is 170 Hz. Other shifts may be configured, however, using Menu item “MODE-RTY 067 RTTY SHIFT.”

- The FT DX 9000D is set up for “high tone” operation (centered on 2125 Hz) by default, but you may configure it for low tone (1275 Hz) operation using Menu item “MODE-RTY 068 RTTY TONE.”
- You may find that you are unable to decode some RTTY stations, even if they are of sufficient signal strength. If this is observed, there may be a Mark/Space polarity problem between your station and the other station. If so, try setting Menu item “MODE-RTY 065 POLARITY-R” to “REV” (“Reverse”) to see if that permits copy. A separate Menu item permits reversal of your transmitter's Mark/Space polarity: “MODE-RTY 066 POLARITY-T.”

### 『Quick Point』

In the FT DX 9000D, “RTTY” is a mode defined as being an “FSK” mode, whereby the closing and opening of a keying line (to ground) causes the Mark/Space tones to alternate. The RTTY mode is not an AFSK based mode in this transceiver, and the AFSK output tones from a TNC will not cause Mark/Space shifting to occur. Use the “Packet” mode for AFSK-based Baudot and other data modes.

# MISCELLANEOUS AFSK-BASED DATA MODES

The FT DX 9000D may also be used for a host of other SSB-based Data modes. Please set up your system using the illustration as a guideline.

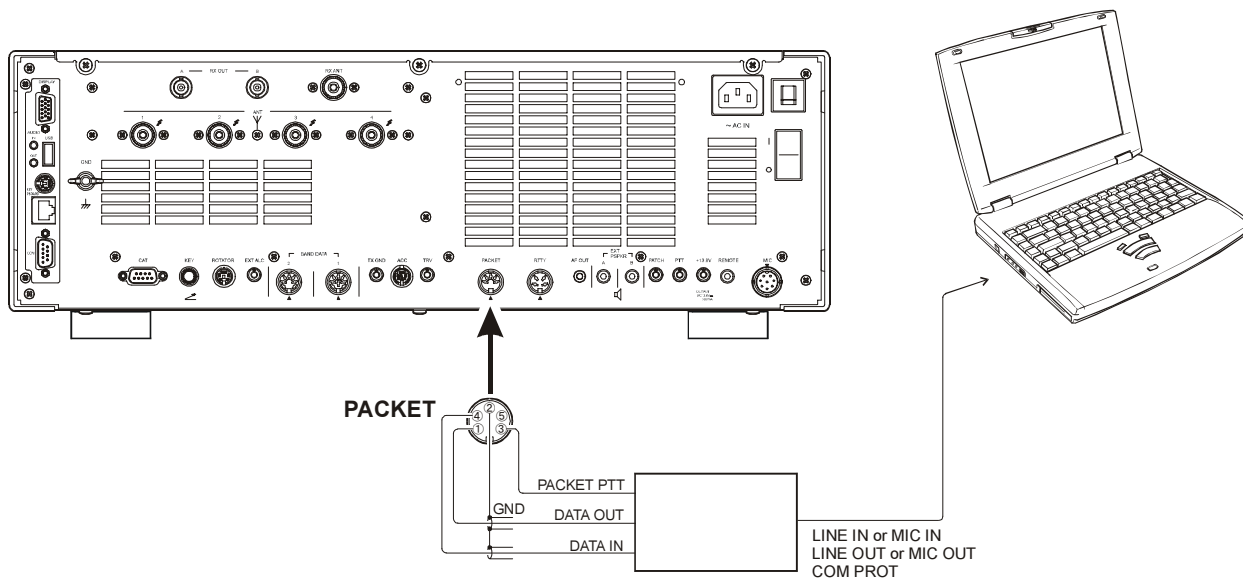

## 『Quick Point』

When you have configured Menu item “TX GNRL 159 VOX SELECT” to “DATA,” the transceiver will operate in a “VOX” mode, and it is not necessary to connect a “PTT” line. This makes for very convenient interfacing to computer Sound Cards, etc.



# MENU MODE

The Menu system of the FT DX 9000D provides extensive customization capability, so you can set up your transceiver just the way you want to operate it. The Menu items are grouped by general utilization category, and are numbered from “AGC 1” to “TX GNRL 160.”

## USING THE MENU

1. Press the **[MNU]** key (#92) momentarily. The Menu list will appear on the TFT, and you will see the Menu Groups, Menu Items and the current settings for each item displayed on the TFT.
2. Rotate the **[Main]** Tuning Dial (#35) (or press the TFT’s **[F6]** and **[F7]** keys) to select the Menu item you wish to work on.
3. Rotate the **[CLAR/VFO-B]** knob (#86) (or use the TFT’s **[F4]** and **[F5]** keys) to change the current setting of the selected Menu item.
4. When you have finished making your adjustments, press and hold in the **[MNU]** key for two seconds to save the new setting and exit to normal operation. If you only momentarily press the **[MNU]** key, the new settings will not be retained.

### 『Advice』

It is possible to retain your Menu settings in the CF (Compact Flash) card for archives purposes. Please see the separate TFT Manual for details.

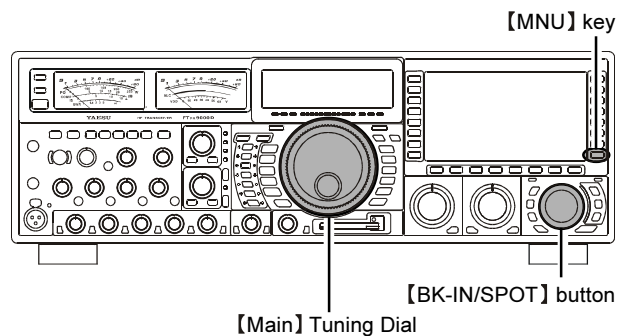

## Menu Mode Reset

You may reset all the Menu settings to their original factory defaults, if desired.

1. Turn the front panel **[POWER]** switch (#5) off.
2. Press and hold in the **[MNU]** key (#92), and while holding it in, press the **[POWER]** switch to turn the transceiver back on. Now release the **[MNU]** key.

# MENU MODE

Groupe	No.	MenuFunction	Available Values	Default Setting
AGC	001	MAIN-FAST-DELAY	20 ~ 4000 msec (20 msec Step)	300 msec
AGC	002	MAIN-FAST-HOLD	0 ~ 2000 msec (20 msec Step)	0 msec
AGC	003	MAIN-MID-DELAY	20 ~ 4000 msec (20 msec Step)	700 msec
AGC	004	MAIN-MID-HOLD	0 ~ 2000 msec (20 msec Step)	0 msec
AGC	005	MAIN-SLOW-DELAY	20 ~ 4000 msec (20 msec Step)	2000 msec
AGC	006	MAIN-SLOW-HOLD	0 ~ 2000 msec (20 msec Step)	0 msec
AGC	007	SUB-FAST-DELAY	20 ~ 4000 msec (20 msec Step)	300 msec
AGC	008	SUB-FAST-HOLD	0 ~ 2000 msec (20 msec Step)	0 msec
AGC	009	SUB-MID-DELAY	20 ~ 4000 msec (20 msec Step)	700 msec
AGC	010	SUB-MID-HOLD	0 ~ 2000 msec (20 msec Step)	0 msec
AGC	011	SUB-SLOW-DELAY	20 ~ 4000 msec (20 msec Step)	2000 msec
AGC	012	SUB-SLOW-HOLD	0 ~ 2000 msec (20 msec Step)	0 msec
DISPLAY	013	TFT COLOR	COOL BLUE / CONTRAST BLUE / FLASH WHITE / CONTRAST UMBER / UMBER	*
DISPLAY	014	DIMMER-METER	0 ~ 15	4
DISPLAY	015	DIMMER-VFD	0 ~ 15	8
DISPLAY	016	BAR DISPLAY SELECT	CLAR / CW TUNE / VRF- $\mu$ TUNE / NOTCH	CW TUNE
DISPLAY	017	ROTATOR START UP	0 / 90 / 180 / 270 (°)	0 (°)
DISPLAY	018	ROTATOR OFFSET ADJ	-30 ~ 0	0
DISPLAY	019	RIGHT TX METER	ALC / VDD	ALC
DISPLAY	020	QMB MARKER	ENABLE / DISABLE	ENABLE
FH-2 SET	021	BEACON TIME	OFF / 1 ~ 255 sec	OFF
FH-2 SET	022	CONTEST NUMBER	1290 / AUNO / AUNT / A2NO / A2NT / 12NO / 12NT	1290
FH-2 SET	023	CW MEMORY 1	TEXT / MESSAGE	MESSAGE
FH-2 SET	024	CW MEMORY 2	TEXT / MESSAGE	MESSAGE
FH-2 SET	025	CW MEMORY 3	TEXT / MESSAGE	MESSAGE
FH-2 SET	026	CW MEMORY 4	TEXT / MESSAGE	MESSAGE
FH-2 SET	027	CW MEMORY 5	TEXT / MESSAGE	MESSAGE
GENERAL	028	ANT SELECT	BAND / STACK	BAND
GENERAL	029	BEEP LEVEL	0 ~ 255	50
GENERAL	030	CAT RATE	4800 / 9600 / 38400 bps	4800 bps
GENERAL	031	MEM GROUP	ENABLE / DISABLE	DISABLE
GENERAL	032	QUICK SPLIT FREQ	-20 ~ 0 ~ 20 kHz (1kHz Step)	5 kHz
GENERAL	033	TIME OUT TIMER	OFF / 5 / 10 / 15 / 20 / 25 / 30 min	OFF
GENERAL	034	TRV OFFSET	30 ~ 49 MHz	44 MHz
GENERAL	035	$\mu$ TUNE DIAL STEP	DIAL STEP-2 / DIAL STEP-1 / OFF	DIAL STEP-1
GENERAL	036	MIC SCAN	ENABLE / DISABLE	ENABLE
GENERAL	037	MIC SCAN RESUME	PAUSE / TIME	TIME
GENERAL	038	AF/RF DIAL SWAP	NORMAL / SWAP	NORMAL
MODE-AM	039	AM MIC GAIN	MCVR / 0 ~ 255	160
MODE-AM	040	AM MIC SELECT	FRONT / REAR / DATA / PC	FRONT
MODE-CW	041	F-KEYER TYPE	OFF / BUG / ELEKEY / ACS	ELEKEY
MODE-CW	042	F-CW KEYER	NOR / REV	NOR
MODE-CW	043	R-KEYER TYPE	OFF / BUG / ELEKEY / ACS	ELEKEY
MODE-CW	044	R-CW KEYER	NOR / REV	NOR
MODE-CW	045	CW AUTO MODE	OFF / 50M / ON	OFF
MODE-CW	046	CW BFO	USB / LSB / AUTO	USB
MODE-CW	047	CW BK-IN	SEMI / FULL	SEMI
MODE-CW	048	CW WAVE SHAPE	1 / 2 / 4 / 6 msec	4 msec
MODE-CW	049	CW WEIGHT	2.5 ~ 4.5	3.0
MODE-CW	050	CW FREQ DISPLAY	DIRECT FREQ / PITCH OFFSET	PITCH OFFSET
MODE-CW	051	PC KEYING	ENABLE / DISABLE	DISABLE
MODE-CW	052	QSK	15 / 20 / 25 / 30 msec	15 msec

\*: Unmber Display Color: UNMBER, Light Blue Display Color: COOL BLUE

# MENU MODE

Groupe	No.MenuFunction	Available Values	Default Setting
MODE-DAT	053 DATA IN SELECT	DATA / PC	DATA
MODE-DAT	054 DATA GAIN	0 ~ 255	128
MODE-DAT	055 DATA OUT	VFO-a / VFO-b	VFO-a
MODE-DAT	056 DATA VOX DELAY	30 ~ 3000 msec	300 msec
MODE-DAT	057 DATA VOX GAIN	0 ~ 255	128
MODE-FM	058 FM MIC GAIN	MCVR / 0 ~ 255	160
MODE-FM	059 FM MIC SELECT	FRONT / REAR / DATA / PC	FRONT
MODE-FM	060 RPT SHIFT(28MHz)	0 ~ 1000 kHz (10 kHz Step)	100 kHz
MODE-FM	061 RPT SHIFT(50MHz)	0 ~ 4000 kHz (10 kHz Step)	1000 kHz
MODE-PKT	062 PKT DISP	-3000 ~ 0 ~ 3000Hz (10 Hz Step)	0 Hz
MODE-PKT	063 PKT GAIN	0 ~ 255	128
MODE-PKT	064 PKT SHIFT	-3000 ~ 0 ~ 3000Hz (10 Hz Step)	1000 Hz
MODE-RTY	065 POLARITY-R	NOR / REV	NOR
MODE-RTY	066 POLARITY-T	NOR / REV	NOR
MODE-RTY	067 RTTY SHIFT	170 / 200 / 425 / 850 Hz	170 Hz
MODE-RTY	068 RTTY TONE	1275 / 2125 Hz	2125 Hz
MODE-SSB	069 SSB MIC SELECT	FRONT / REAR / DATA / PC	FRONT
MODE SSB	070 SSB-TX-BPF	50-3000 / 100-2900 / 200-2800 / 300-2700 / 400-2600 (Hz) / 3000WB	300-2700 (Hz)
MODE-SSB	071 LSB RX-CARRIER	-200 ~ 0 ~ 200 Hz (10Hz Step)	0Hz
MODE-SSB	072 LSB TX-CARRIER	-200 ~ 0 ~ 200 Hz (10Hz Step)	0Hz
MODE-SSB	073 USB RX-CARRIER	-200 ~ 0 ~ 200 Hz (10Hz Step)	0Hz
MODE-SSB	074 USB TX-CARRIER	-200 ~ 0 ~ 200 Hz (10Hz Step)	0Hz
RX AUDIO	075 AGC-SLOPE	NORMAL / SLOPE	NORMAL
RX AUDIO	076 HEADPHONE MIX	SEPARATE / COMBINE-1 / COMBINE-2	SEPARATE
RX AUDIO	077 SPEAKER OUT	SEPARATE / COMBINE	COMBINE
RX DSP	078 MAIN-CONTOUR-LEVEL	-20 ~ 0 ~ 10	-15
RX DSP	079 MAIN-CONTOUR-WIDTH	1 ~ 11	10
RX DSP	080 SUB-CONTOUR-LEVEL	-20 ~ 0 ~ 10	-15
RX DSP	081 SUB-CONTOUR-WIDTH	1 ~ 11	10
RX DSP	082 IF-NOTCH-WIDTH	NARROW / WIDE	WIDE
RX DSP	083 MAIN-CW-SHAPE	SOFT / SHARP	SHARP
RX DSP	084 MAIN-CW-SLOPE	STEEP / MEDIUM / GENTLE	MEDIUM
RX DSP	085 MAIN-CW-NARROW	25 / 50 / 100 / 200 / 300 / 400 (Hz)	300 (Hz)
RX DSP	086 MAIN-PSK-SHAPE	SOFT / SHARP	SHARP
RX DSP	087 MAIN-PSK-SLOPE	STEEP / MEDIUM / GENTLE	MEDIUM
RX DSP	088 MAIN-PSK-NARROW	25 / 50 / 100 / 200 / 300 / 400 (Hz)	300 (Hz)
RX DSP	089 MAIN-RTTY-SHAPE	SOFT / SHARP	SHARP
RX DSP	090 MAIN-RTTY-SLOPE	STEEP / MEDIUM/GENTLE	MEDIUM
RX DSP	091 MAIN-RTTY-NARROW	25 / 50 / 100 / 200 / 300 / 400 (Hz)	300 (Hz)
RX DSP	092 MAIN-SSB-SHAPE	SOFT / SHARP	SHARP
RX DSP	093 MAIN-SSB-SLOPE	STEEP / MEDIUM / GENTLE	MEDIUM
RX DSP	094 MAIN-SSB-NARROW	200 / 400 / 600 / 850 / 1100 / 1350 / 1500 / 1650 / 1800 / 1950 / 2100 / 2250 (Hz)	1800 (Hz)
RX DSP	095 SUB-CW-SHAPE	SOFT / SHARP	SHARP
RX DSP	096 SUB-CW-SLOPE	STEEP / MEDIUM / GENTLE	MEDIUM
RX DSP	097 SUB-CW-NARROW	25 / 50 / 100 / 200 / 300 / 400 (Hz)	300 (Hz)
RX DSP	098 SUB-PSK-SHAPE	SOFT / SHARP	SHARP
RX DSP	099 SUB-PSK-SLOPE	STEEP / MEDIUM / GENTLE	MEDIUM
RX DSP	100 SUB-PSK-NARROW	25 / 50 / 100 / 200 / 300 / 400 (Hz)	300 (Hz)
RX DSP	101 SUB-RTTY-SHAPE	SOFT / SHARP	SHARP
RX DSP	102 SUB-RTTY-SLOPE	STEEP / MEDIUM / GENTLE	MEDIUM
RX DSP	103 SUB-RTTY-NARROW	25 / 50 / 100 / 200 / 300 / 400 (Hz)	300 (Hz)
RX DSP	104 SUB-SSB-SHAPE	SOFT / SHARP	SHARP
RX DSP	105 SUB-SSB-SLOPE	STEEP / MEDIUM / GENTLE	MEDIUM



Groupe	No.	MenuFunction	Available Values	Default Setting
RXDSP	106	SUB-SSB-NARROW	200 / 400 / 600 / 850 / 1100 / 1350 / 1500 / 1650 / 1800 / 1950 / 2100 / 2250 (Hz)	1800 (Hz)
SCOPE	107	MAIN FIX 1.8MHz	1800 ~ 1999 kHz	1800kHz
SCOPE	108	MAIN FIX 3.5MHz	3500 ~ 3999 kHz	3500kHz
SCOPE	109	MAIN FIX 5.0MHz	5250 ~ 5499 kHz	5250kHz
SCOPE	110	MAIN FIX 7.0MHz	7000 ~ 7299 kHz	7000kHz
SCOPE	111	MAIN FIX 10MHz	10100 ~ 10149 kHz	10100kHz
SCOPE	112	MAIN FIX 14MHz	14000 ~ 14349 kHz	14000kHz
SCOPE	113	MAIN FIX 18MHz	18000 ~ 18199 kHz	18068kHz
SCOPE	114	MAIN FIX 21MHz	21000 ~ 21449 kHz	21000kHz
SCOPE	115	MAIN FIX 24MHz	24800 ~ 24989 kHz	24890 kHz
SCOPE	116	MAIN FIX 28MHz	28000 ~ 28699 kHz	28000 kHz
SCOPE	117	MAIN FIX 50MHz	50000 ~ 53999 kHz	50000 kHz
SCOPE	118	SUB FIX 1.8MHz	1800 ~ 1999 kHz	1800 kHz
SCOPE	119	SUB FIX 3.5MHz	3500 ~ 3999 kHz	3500 kHz
SCOPE	120	SUB FIX 5.0MHz	5250 ~ 5499 kHz	5250 kHz
SCOPE	121	SUB FIX 7.0MHz	7000 ~ 7299 kHz	7000 kHz
SCOPE	122	SUB FIX 10MHz	10100 ~ 10149 kHz	10100 kHz
SCOPE	123	SUB FIX 14MHz	14000 ~ 14349kHz	14000 kHz
SCOPE	124	SUB FIX 18MHz	18000 ~ 18199 kHz	18068 kHz
SCOPE	125	SUB FIX 21MHz	21000 ~ 21449 kHz	21000 kHz
SCOPE	126	SUB FIX 24MHz	24800 ~ 24989 kHz	24890 kHz
SCOPE	127	SUB FIX 28MHz	28000 ~ 28699kHz	28000 kHz
SCOPE	128	SUB FIX 50MHz	50000 ~ 53999 kHz	50000 kHz
TUNING	129	MAIN DIAL STEP	1 / 10 Hz	10 Hz
TUNING	130	MAIN DIAL CW FINE	DISABLE / ENABLE	DISABLE
TUNING	131	1MHz/100kHz SELECT	1MHz / 100kHz	1 MHz
TUNING	132	AM CH STEP	2.5 / 5 / 9 / 10 / 12.5 kHz	5 kHz
TUNING	133	FM CH STEP	5 / 6.25 / 10 / 12.5 / 25 kHz	5 kHz
TUNING	134	FM DIAL STEP	10Hz / 100 Hz	100 Hz
TUNING	135	MY BAND	1.8 ~ 50 (MHz) / GEN / TRV	-----
TX AUDIO	136	F-PRMTRC EQ1-FREQ	OFF / 100 / 200 / 300 / 400 / 500 / 600 / 700 (Hz)	OFF
TX AUDIO	137	F-PRMTRC EQ1-LEVEL	-10 ~ 0 ~ 10	5
TX AUDIO	138	F-PRMTRC EQ1-BWTH	1 ~ 10	10
TX AUDIO	139	F-PRMTRC EQ2-FREQ	OFF / 700 / 800 / 900 / 1000 / 1100 / 1200 / 1300 / 1400 / 1500 (Hz)	OFF
TX AUDIO	140	F-PRMTRC EQ2-LEVEL	-10 ~ 0 ~ 10	5
TX AUDIO	141	F-PRMTRC EQ2-BWTH	1 ~ 10	10
TX AUDIO	142	F-PRMTRC EQ3-FREQ	OFF/1500 ~ 3200 (100Hz Step)	OFF
TX AUDIO	143	F-PRMTRC EQ3-LEVEL	-10 ~ 0 ~ 10	5
TX AUDIO	144	F-PRMTRC EQ3-BWTH	1 ~ 10	10
TX AUDIO	145	R-PRMTRC EQ1-FREQ	OFF / 100 / 200 / 300 / 400 / 500 / 600 / 700 (Hz)	OFF
TX AUDIO	146	R-PRMTRC EQ1-LEVEL	-10 ~ 0 ~ 10	5
TX AUDIO	147	R-PRMTRC EQ1-BWTH	1 ~ 10	10
TX AUDIO	148	R-PRMTRC EQ2-FREQ	OFF / 700 / 800 / 900 / 1000 / 1100 / 1200 / 1300 / 1400 / 1500 (Hz)	OFF
TX AUDIO	149	R-PRMTRC EQ2-LEVEL	-10 ~ 0 ~ 10	5
TX AUDIO	150	R-PRMTRC EQ2-BWTH	1 ~ 10	10
TX AUDIO	151	R-PRMTRC EQ3-FREQ	OFF / 1500 ~ 3200 (Hz) (100Hz Step)	OFF
TX AUDIO	152	R-PRMTRC EQ3-LEVEL	-10 ~ 0 ~ 10	5
TX AUDIO	153	R-PRMTRC EQ3-BWTH	1 ~ 10	10
TX GNRL	154	TX MAX POWER	10 / 50 / 100 / 200 (W)	200 (W)

# ***MENU MODE***

<b>Groupe</b>	<b>No.</b>	<b>MenuFunction</b>	<b>Available Values</b>	<b>Default Setting</b>
TXGNRL	155	TX PWR CONTROL	ALL MODE / CARRIER	ALL MODE
TX GNRL	156	EXT AMP TX-GND	ENABLE / DISABLE	DISABLE
TX GNRL	157	EXT AMP TUNING PWR	10 / 50 / 100 / 200 (W)	100 (W)
TX GNRL	158	FULL DUPLEX	SIMP / DUP	SIMP
TX GNRL	159	VOX SELECT	MIC / DATA	MIC
TX GNRL	160	EMERGENCY FREQ TX	DISABLE / ENABLE	DISABLE

**Downloaded by  
RadioAmateur.EU**

---

## AGC GROUP

---

### **001. MAIN-FAST-DELAY**

**Function:** Sets the delay time for the AGC FAST mode of the main band (VFO-A) receiver.

**Available Values:** 20 ~ 4000 msec (20 msec/step)

**Default Setting:** 300 msec

### **002. MAIN-FAST-HOLD**

**Function:** Sets the hang time of the AGC peak voltage for the AGC FAST mode of the main band (VFO-A) receiver.

**Available Values:** 0 ~ 2000 msec (20 msec/step)

**Default Setting:** 0 msec

### **003. MAIN-MID-DELAY**

**Function:** Sets the delay time for the AGC MID mode of the main band (VFO-A) receiver.

**Available Values:** 20 ~ 4000 msec (20 msec/step)

**Default Setting:** 700 msec

### **004. MAIN-MID-HOLD**

**Function:** Sets the hang time of the AGC peak voltage for the AGC MID mode of the main band (VFO-A) receiver.

**Available Values:** 0 ~ 2000 msec (20 msec/step)

**Default Setting:** 0 msec

### **005. MAIN-SLOW-DELAY**

**Function:** Sets the delay time for the AGC SLOW mode of the main band (VFO-A) receiver.

**Available Values:** 20 ~ 4000 msec (20 msec/step)

**Default Setting:** 2000 msec

### **006. MAIN-SLOW-HOLD**

**Function:** Sets the hang time of the AGC peak voltage for the AGC SLOW mode of the main band (VFO-A) receiver.

**Available Values:** 0 ~ 2000 msec (20 msec/step)

**Default Setting:** 0 msec

### **007. SUB-FAST-DELAY**

**Function:** Sets the delay time for the AGC FAST mode of the sub band (VFO-B) receiver.

**Available Values:** 20 ~ 4000 msec (20 msec/step)

**Default Setting:** 300 msec

### **008. SUB-FAST-HOLD**

**Function:** Sets the hang time of the AGC peak voltage for the AGC FAST mode of the sub band (VFO-B) receiver.

**Available Values:** 0 ~ 2000 msec (20 msec/step)

**Default Setting:** 0 msec

### **009. SUB-MID-DELAY**

**Function:** Sets the delay time for the AGC MID mode of the sub band (VFO-B) receiver.

**Available Values:** 20 ~ 4000 msec (20 msec/step)

**Default Setting:** 700 msec

### **010. SUB-MID-HOLD**

**Function:** Sets the hang time of the AGC peak voltage for the AGC MID mode of the sub band (VFO-B) receiver.

**Available Values:** 0 ~ 2000 msec (20 msec/step)

**Default Setting:** 0 msec

### **011. SUB-SLOW-DELAY**

**Function:** Sets the delay time for the AGC SLOW mode of the sub band (VFO-B) receiver.

**Available Values:** 20 ~ 4000 msec (20 msec/step)

**Default Setting:** 2000 msec

### **012. SUB-SLOW-HOLD**

**Function:** Sets the hang time of the AGC peak voltage for the AGC SLOW mode of the sub band (VFO-B) receiver.

**Available Values:** 0 ~ 2000 msec (20 msec/step)

**Default Setting:** 0 msec

---

---

## DISPLAY GROUP

---

---

### **013. TFT COLOR**

**Function:** Selects the TFT color.

**Available Values:** COOL BLUE/CONTRAST BLUE/  
FLASH WHITE/CONTRAST UMBER/UMBER

**Default Setting:** COOL BLUE

### **014. DIMMER-METER**

**Function:** Setting of the meter brightness level when "DIM" is selected.

**Available Values:** 0 ~ 15

**Default Setting:** 4

### **015. DIMMER-VFD**

**Function:** Setting of the frequency and TFT display brightness level when "DIM" is selected.

**Available Values:** 0 ~ 15

**Default Setting:** 8

### **016. BAR DISPLAY SELECT**

**Function:** Selects one of three parameters to be viewed on the Tuning Offset Indicator.

**Available Values:** CLAR/CW TUNE/VRF- $\mu$ TUNE/  
NOTCH

**Default Setting:** CW TUNE

**CLAR:** Displays relative clarifier offset.

**CW TUNE:** Displays relative tuning offset between the incoming signal and transmitted frequency.

**VRF- $\mu$ TUNE:** Displays the peak position of the VRF or  $\mu$ TUNE filter.

**NOTCH:** While you rotate the [NOTCH] knob, the center frequency of the IF NOTCH feature will be indicated.

### **017. ROTATOR START UP**

**Function:** Selects the starting point of your controller's indicator needle.

**Available Values:** 0/90/180/270°

**Default Setting:** 0°

### **018. ROTATOR OFFSET ADJ**

**Function:** Adjusts the indicator needle precisely to the starting point set in menu selection 123.

**Available Values:** -30 - 0

**Default Setting:** 0

### **019. RIGHT TX METER**

**Function:** Selects the Sub meter function

**Available Values:** ALC/VDD

**Default Setting:** ALC

**ALC:** Indicates incoming signal strength on the sub band (VFO-B) while receiving, and indicates the ALC (Automatic Level Control) operating range while transmitting.

**VDD:** Indicates the Vdd (final amplifier drain voltage) at all times.

### **020. QMB MARKER**

**Function:** Enables/Disable the QMB Marker (White arrow "▽") to display on the Spectrum Band Scope.

**Available Values:** ENABLE/DISABLE

**Default Setting:** ENABLE

## FH-2 SETUP GROUP

### **021. BEACON TIME**

**Function:** Sets the interval time between repeats of the beacon message.

**Available Values:** OFF/1 ~ 255 sec

**Default Setting:** OFF

### **022. CONTEST NUMBER**

**Function:** Selects the Contest Number "Cut" format for imbedded contest number.

**Available Values:** 1290/AUNO/AUNT/A2NO/A2NT/12NO/12NT

**Default Setting:** 1290

**1290:** Does not abbreviate the Contest Number

**AUNO:** Abbreviates to "A" for "One," "U" for "Two," "N" for "Nine," and "O" for "Zero."

**AUNT:** Abbreviates to "A" for "One," "U" for "Two," "N" for "Nine," and "T" for "Zero."

**A2NO:** Abbreviates to "A" for "One," "N" for "Nine," and "O" for "Zero."

**A2NT:** Abbreviates to "A" for "One," "N" for "Nine," and "T" for "Zero."

**12NO:** Abbreviates to "N" for "Nine" and "O" for "Zero."

**12NT:** Abbreviates to "N" for "Nine" and "T" for "Zero."

### **023. CW MEMORY 1**

**Function:** Permits entry of the CW message for message register 1.

**Available Values:** TEXT/MESSAGE

**Default Setting:** MESSAGE

**TEXT:** You may enter the CW message from a supplied **FH-2** Remote Control Keypad.

**MESSAGE:** You may enter the CW message from the CW keyer.

### **024. CW MEMORY 2**

**Function:** Permits entry of the CW message for message register 2.

**Available Values:** TEXT/MESSAGE

**Default Setting:** MESSAGE

**TEXT:** You may enter the CW message from a supplied **FH-2** Remote Control Keypad.

**MESSAGE:** You may enter the CW message from the CW keyer.

### **025. CW MEMORY 3**

**Function:** Permits entry of the CW message for message register 3.

**Available Values:** TEXT/MESSAGE

**Default Setting:** MESSAGE

**TEXT:** You may enter the CW message from a supplied **FH-2** Remote Control Keypad.

**MESSAGE:** You may enter the CW message from the CW keyer.

### **026. CW MEMORY 4**

**Function:** Permits entry of the CW message for message register 4.

**Available Values:** TEXT/MESSAGE

**Default Setting:** MESSAGE

**TEXT:** You may enter the CW message from a supplied **FH-2** Remote Control Keypad.

**MESSAGE:** You may enter the CW message from the CW keyer.

### **027. CW MEMORY 5**

**Function:** Permits entry of the CW message for message register 5.

**Available Values:** TEXT/MESSAGE/COUNTUP

**Default Setting:** MESSAGE

**TEXT:** You may enter the CW message from a supplied **FH-2** Remote Control Keypad.

**MESSAGE:** You may enter the CW message from the CW keyer.

## GENERAL GROUP

### **028. ANT SELECT**

**Function:** Sets the method of antenna selection.

**Available Values:** BAND/STACK

**Default Setting:** BAND

**BAND:** The antenna is selected in accordance with the operating band.

**STACK:** The antenna is selected in accordance with the band stack (different antennas may be utilized on the same band, if so selected in the band stack).

### **029. BEEP LEVEL**

**Function:** Sets the beep level.

**Available Values:** 0 ~ 255

**Default Setting:** 50

### **030. CAT RATE**

**Function:** Sets the transceiver's computer-interface circuitry for the CAT baud rate to be used.

**Available Values:** 4800/9600/38400 bps

**Default Setting:** 4800 bps

### **031. MEM GROUP**

**Function:** Enables/Disables Memory Group Operation.

**Available Values:** DISABLE/ENABLE

**Default Setting:** DISABLE

### **032. QUICK SPLIT FREQ**

**Function:** Selects the tuning offset for the Quick Split feature.

**Available Values:** -20 ~ 0 ~ +20 kHz (1 kHz Step)

**Default Setting:** +5 kHz

### **033. TIME OUT TIMER**

**Function:** Sets the Time-Out Timer countdown time.

**Available Values:** OFF/5/10/15/20/25/30 min

**Default Setting:** OFF

The Time-Out Timer shuts off the transmitter after continuous transmission of the programmed time.

### **034. TRV OFFSET**

**Function:** Set the 10's and 1's of the MHz digits display for operation with a transverter.

**Available Values:** 30 ~ 49 MHz

**Default Setting:** 44 MHz

If you connect a 430 MHz transverter to the radio, set this menu to "30" (the "100 MHz" digits are hidden on this radio).

### **035. $\mu$ TUNE DIAL STEP**

**Function:** Select the  $\mu$ -TUNE mode.

**Available Values:** DIAL STEP-1/DIAL STEP-2/OFF

**Default Setting:** DIAL STEP-1

**DIAL STEP-1:** Activates the  $\mu$ -TUNE system in the Auto mode using "**FINE**" steps of the  $\mu$ -TUNE knob (1 step/click) on the 14 MHz and lower amateur bands on the main band (VFO-A).

**DIAL STEP-2:** Activates the  $\mu$ -TUNE system in the Auto mode using "**COARSE**" steps of the  $\mu$ -TUNE knob (2 steps/click) on the 7 MHz and lower amateur bands. On the 10/14 MHz bands, "FINE"  $\mu$ -TUNE knob steps will be used (1 step/click).

**OFF:** Disables the  $\mu$ -TUNE system. Activates the VRF feature on the 14 MHz and lower amateur bands on the main band (VFO-A).

### **036. MIC SCAN**

**Function:** Enables/disables scanning access via the microphone's [UP]/[DOWN] keys (only available at the rear panel's MIC Jack).

**Available Values:** ENABLE/DISABLE

**Default Setting:** ENABLE

### **037. MIC SCAN RESUME**

**Function:** Selects the Scan Resume mode.

**Available Values:** PAUSE/TIME

**Default Setting:** TIME

**PAUSE:** The scanner will hold until the signal disappears, then will resume after one second.

**TIME:** The scanner will hold for five seconds, then resume whether or not the other station is still transmitting.

### **038. AF/RF DIAL SWAP**

**Function:** Reverses the functions of the **AF GAIN** (VFO-B) and **RF GAIN** (VFO-A) knobs.

**Available Values:** NORMAL/SWAP

**Default Setting:** NORMAL

When this menu is set to "SWAP," you may adjust the sub (VFO-B) receiver audio using the large **RF GAIN** (VFO-A) knob and adjust the main (VFO-A) receiver RF gain using the small **AF GAIN** (VFO-B) knob. This puts both "Volume" controls on the same shaft.



---

---

## MODE-AM GROUP

---

---

### 039. AM MIC GAIN

**Function:** Sets the microphone gain for the AM mode.

**Available Values:** MCVR/0 ~ 255 (FIX)

**Default Setting:** 160

When this menu is set to "MCVR," you may adjust the microphone gain using the front panel's **MIC** knob.

### 040. AM MIC SELECT

**Function:** Selects the microphone to be used on the AM mode.

**Available Values:** FRONT/REAR/DATA/PC

**Default Setting:** FRONT

**FRONT:** Selects the microphone connected to the front panel's **MIC** jack while using the AM mode.

**REAR:** Selects the microphone connected to the rear panel's **MIC** jack while using the AM mode.

**DATA:** Selects the microphone connected to pin 1 of the **PACKET** Jack while using the AM mode.

**PC:** Selects the microphone connected to the rear panel's **AUDIO IN** 3.5-mm jack while using the AM mode.

---

---

## MODE-CW GROUP

---

---

### 041. F-KEYER TYPE

**Function:** Selects the desired keyer operation mode for the device connected to the front panel's **KEY** jack.

**Available Values:** OFF/BUG/ELEKEY/ACS

**Default Setting:** ELEKEY

**OFF:** Disables the front panel's keyer ("straight key" mode for use with external keyer or computer-driven keying interface).

**BUG:** Mechanical "bug" keyer emulation. One paddle produces "dits" automatically, while the other paddle manually produces "dahs."

**ELEKEY:** Iambic keyer with ACS (Automatic Character Spacing) disabled.

**ACS:** Iambic keyer with ACS (Automatic Character Spacing) enabled.

### 042. F-CW KEYER

**Function:** Selects the keyer paddle's wiring configuration of the **KEY** jack on the front panel.

**Available Values:** NOR/REV

**Default Setting:** NOR

**NOR:** Tip = Dot, Ring = Dash, Shaft = Ground

**REV:** Tip = Dash, Ring = Dot, Shaft = Ground

### 043. R-KEYER TYPE

**Function:** Select the desired keyer operation mode for the device connected to the rear panel's **KEY** jack.

**Available Values:** OFF/BUG/ELEKEY/ACS

**Default Setting:** ELEKEY

**OFF:** Disables the front panel's keyer ("straight key" mode for use with external keyer or computer-driven keying interface).

**BUG:** Mechanical "bug" keyer emulation. One paddle produces "dits" automatically, while the other paddle manually produces "dahs."

**ELEKEY:** Iambic keyer with ACS (Automatic Character Spacing) disabled.

**ACS:** Iambic keyer with ACS (Automatic Character Spacing) enabled.

### 044. R-CW KEYER

**Function:** Selects the keyer paddle's wiring configuration of the **KEY** jack on the rear panel.

**Available Values:** NOR/REV

**Default Setting:** NOR

**NOR:** Tip = Dot, Ring = Dash, Shaft = Ground

**REV:** Tip = Dash, Ring = Dot, Shaft = Ground

---

---

## MODE-CW GROUP

---

---

### **045. CW AUTO MODE**

**Function:** Enables/disables CW keying while operating on SSB.

**Available Values:** OFF/50MHz/ON

**Default Setting:** OFF

**OFF:** Disables CW keying while operating on SSB.

**50MHz:** Enables CW keying only while operating SSB on 50 MHz (but not HF).

**ON:** Enables CW keying while operating on SSB (all TX bands).

**Note:** This feature allows you to move someone from SSB to CW *without having* to change modes on the front panel.

### **046. CW BFO**

**Function:** Sets the CW carrier oscillator injection side for the CW mode.

**Available Values:** USB/LSB/AUTO

**Default Setting:** USB

**USB:** Injects the CW carrier oscillator on the USB side.

**LSB:** Injects the CW carrier oscillator on the LSB side.

**AUTO:** Injects the CW carrier oscillator on the LSB side while operating on the 7 MHz band and below, and the USB side while operating on the 10 MHz band and up.

### **047. CW BK-IN**

**Function:** Sets the CW "break-in" mode.

**Available Values:** SEMI/FULL

**Default Setting:** SEMI

**SEMI:** The transceiver will operate in the semi break-in mode. The delay (receiver recovery) time is set by the front panel's **CW DELAY** knob.

**FULL:** The transceiver will operate in the full break-in (QSK) mode.

### **048. CW WAVE SHAPE**

**Function:** Selects the CW carrier wave-form shape (rise/fall times).

**Available Values:** 1/2/4/6 msec

**Default Setting:** 4 msec

### **049. CW WEIGHT**

**Function:** Sets the Dot:Dash ratio for the built-in electronic keyer.

**Available Values:** (1:) 2.5 ~ 4.5

**Default Setting:** 3.0

### **050. CW FREQ DISPLAY**

**Function:** Frequency Display Format for the CW mode.

**Available Values:** DIRECT FREQ/PITCH OFFSET

**Default Setting:** PITCH OFFSET

**DIRECT FREQ:** Displays the receiver carrier frequency, without any offset added. When changing modes between SSB and CW, the frequency display remains constant.

**PITCH OFFSET:** This frequency display reflects the added BFO offset.

### **051. PC KEYING**

**Function:** Enables/disables CW keying from the "DATA IN" terminal on the rear panel's **PACKET** jack while operating on the CW mode.

**Available Values:** DISABLE/ENABLE

**Default Setting:** DISABLE

### **052. QSK**

**Function:** Selects the time delay between when the PTT is keyed and the carrier is transmitted during QSK operation when using the internal keyer.

**Available Values:** 15/20/25/30 msec

**Default Setting:** 15 msec

## MODE-DAT GROUP

### 053. DATA IN SELECT

**Function:** Selects the data input to be used on the PKT mode.

**Available Values:** DATA/PC

**Default Setting:** DATA

**DATA:** Uses the data input line which is connected to the rear panel's **PACKET** jack while using the PKT mode.

**PC:** Uses the data input line which is connected to the rear panel's **AUDIO IN** jack while using the PKT mode.

### 054. DATA GAIN

**Function:** Sets the data input level from the TNC to the AFSK modulator.

**Available Values:** 0 ~ 255

**Default Setting:** 128

### 055. DATA OUT

**Function:** Selects the receiver to be connected to the data output port (pin 4) of the **PACKET** jack.

**Available Values:** VFO-a/VFO-b

**Default Setting:** VFO-a

### 056. DATA VOX DELAY

**Function:** Adjusts the "VOX" delay (receiver recovery) time on the PKT mode.

**Available Values:** 30 ~ 3000 msec

**Default Setting:** 300 msec

### 057. DATA VOX GAIN

**Function:** Adjusts the "VOX" gain on the PKT mode.

**Available Values:** 0 ~ 255

**Default Setting:** 128

## MODE-FM GROUP

### 058. FM MIC GAIN

**Function:** Sets the microphone gain for the FM mode.

**Available Values:** MCVR/0 ~ 255 (FIX)

**Default Setting:** 160

When this menu is set to "MCVR," you may adjust the microphone gain using the front panel's **MIC** knob.

### 059. FM MIC SELECT

**Function:** Selects the microphone to be used on the FM mode.

**Available Values:** FRONT/REAR/DATA/PC

**Default Setting:** FRONT

**FRONT:** Selects the microphone connected to the front panel's **MIC** jack while using the FM mode.

**REAR:** Selects the microphone connected to the rear panel's **MIC** jack while using the FM mode.

**DATA:** Selects the microphone connected to pin 1 of the **PACKET** Jack while using the FM mode.

**PC:** Selects the microphone connected to the rear panel's **AUDIO IN** 3.5-mm jack while using the FM mode.

### 060. RPT SHIFT (28MHz)

**Function:** Sets the magnitude of the repeater shift on the 28 MHz band.

**Available Values:** 0 ~ 1000 kHz

**Default Setting:** 100 kHz

### 061. RPT SHIFT (50MHz)

**Function:** Sets the magnitude of the repeater shift on the 50 MHz band.

**Available Values:** 0 ~ 4000 kHz

**Default Setting:** 1000 kHz

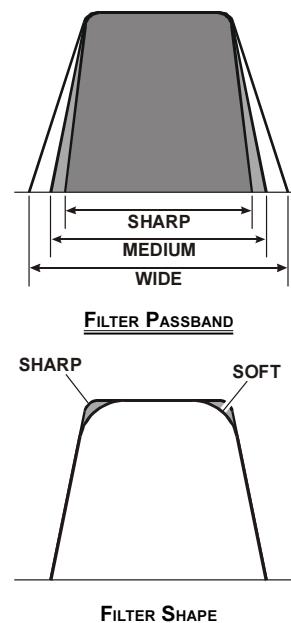

# MENU MODE

---

---

## MODE-PKT GROUP

---

---

### **062. PKT DISP**

**Function:** Sets the packet frequency display offset.

**Available Values:** -3000 ~ +3000 Hz (10 Hz/step)

**Default Setting:** 0 Hz

### **063. PKT GAIN**

**Function:** Adjusts the audio input level from the TNC to the AFSK modulator.

**Available Values:** 0 ~ 255

**Default Setting:** 128

### **064. PKT SHIFT (SSB)**

**Function:** Sets the carrier point during the SSB Packet operation

**Available Values:** -3000 ~ +3000 Hz (10 Hz/step)

**Default Setting:** +1000 Hz (Typical center frequency for PSK31, etc.)

---

---

## MODE-RTY GROUP

---

---

### **065. POLARITY-R**

**Function:** Selects normal or reverse Mark/Space polarity for RTTY receive operation.

**Available Values:** NOR/REV

**Default Setting:** NOR

### **066. POLARITY-T**

**Function:** Selects normal or reverse Mark/Space polarity for RTTY transmit operation.

**Available Values:** NOR/REV

**Default Setting:** NOR

### **067. RTTY SHIFT**

**Function:** Selects the frequency shift for the FSK RTTY operation.

**Available Values:** 170/200/425/850 Hz

**Default Setting:** 170 Hz

### **068. RTTY TONE**

**Function:** Selects the mark tone for RTTY operation.

**Available Values:** 1275/2125 Hz

**Default Setting:** 2125 Hz

Downloaded by  
RadioAmateur.EU

## MODE-SSB GROUP

### 069. SSB MIC SELECT

**Function:** Selects the microphone to be used on the SSB mode.

**Available Values:** FRONT/REAR/DATA/PC

**Default Setting:** FRONT

**FRONT:** Selects the microphone connected to the front panel's **MIC** jack while using the SSB modes.

**REAR:** Selects the microphone connected to the rear panel's **MIC** jack while using the SSB modes.

**DATA:** Selects the microphone connected to pin 1 of the **PACKET** Jack while using the SSB modes.

**PC:** Selects the microphone connected to the rear panel's **AUDIO IN** 3.5-mm jack while using the SSB modes.

### 070. SSB-TX-BPF

**Function:** Selects the audio passband of the Enhanced DSP modulator on the SSB mode.

**Available Values:** 50-3000(Hz)/100-2900(Hz)/200-2800(Hz)/300-2700(Hz)/400-2600(Hz)/3000WB

**Default Setting:** 300-2700 Hz

### 071. LSB RX-CARRIER

**Function:** Adjusts the receiver carrier point for LSB mode.

**Available Values:** -200 Hz ~ +200 Hz (10 Hz steps)

**Default Setting:** 0 Hz

### 072. LSB TX-CARRIER

**Function:** Adjusts the transmitter carrier point for LSB mode.

**Available Values:** -200 Hz ~ +200 Hz (10 Hz steps)

**Default Setting:** 0 Hz

### 073. USB RX-CARRIER

**Function:** Adjusts the receiver carrier point for USB mode.

**Available Values:** -200 Hz ~ +200 Hz (10 Hz steps)

**Default Setting:** 0 Hz

### 074. USB TX-CARRIER

**Function:** Adjusts the transmitter carrier point for USB mode.

**Available Values:** -200 Hz ~ +200 Hz (10 Hz steps)

**Default Setting:** 0 Hz

## RX AUDIO GROUP

### 075. AGC-SLOPE

**Function:** Selects the gain curve of the AGC amplifier.

**Available Values:** NORMAL/SLOPE

**Default Setting:** NORMAL

**NORMAL:** The AGC output level will follow a linear response to the antenna input level, while AGC is activated.

**SLOPE:** The AGC output level will increase at 1/10 the rate of the antenna input level, while AGC is activated.

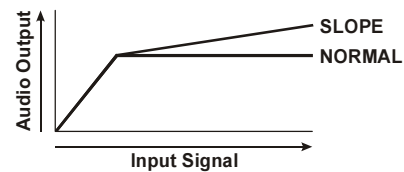

### 076. HEADPHONE MIX

**Function:** Selects one of three audio mixing modes when using headphones during Dual Receive operation.

**Available Values:** SEPARATE/COMBINE-1/COMBINE-2

**Default Setting:** SEPARATE

**SEPARATE:** Audio from the main (VFO-A) receiver is heard only in the left ear, and sub (VFO-B) receiver audio solely in the right ear.

**COMBINE-1:** Audio from both main (VFO-A) and sub (VFO-B) receivers can be heard in both ears, but sub (VFO-B) audio is attenuated in the left ear and main (VFO-A) audio is attenuated in the right ear.

**COMBINE-2:** Audio from both main (VFO-A) and sub (VFO-B) receivers is combined and heard equally in both ears.

### 077. SPEAKER OUT

**Function:** Selects audio mixing modes for the "sub" (secondary) speaker during Dual Receive operation.

**Available Values:** SEPARATE/COMBINE

**Default Setting:** COMBINE

**SEPARATE:** Audio from the main (VFO-A) receiver is fed to the main speaker, and sub (VFO-B) receiver audio is fed to the "sub" speaker.

**COMBINE:** Audio from both main (VFO-A) and sub (VFO-B) receivers is combined and split equally between the main and sub speakers.

## RX DSP GROUP

### 078. MAIN-CONTOUR-LEVEL

**Function:** Adjusts the parametric equalizer gain of the main band (VFO-A) receiver Contour filter.

**Available Values:** -20 ~ +10 dB

**Default Setting:** -15 dB

### 079. MAIN-CONTOUR-WIDTH

**Function:** Adjusts the Q-factor of the main band (VFO-A) receiver Contour filter.

**Available Values:** 1 - 11

**Default Setting:** 10

### 080. SUB-CONTOUR-LEVEL

**Function:** Adjusts the parametric equalizer gain of the sub band (VFO-B) receiver Contour filter.

**Available Values:** -20 ~ +10 dB

**Default Setting:** -15 dB

### 081. SUB-CONTOUR-WIDTH

**Function:** Adjusts the Q-factor of the sub band (VFO-B) receiver Contour filter.

**Available Values:** 1 ~ 11

**Default Setting:** 10

### 082. IF-NOTCH-WIDTH

**Function:** Selects the bandwidth of the DSP NOTCH filter

**Available Values:** NARROW/WIDE

**Default Setting:** WIDE

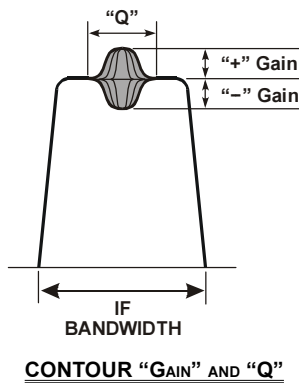

### 083. MAIN-CW-SHAPE

**Function:** Selects the passband characteristics of the main band (VFO-A) DSP filter for the CW mode.

**Available Values:** SOFT/SHARP

**Default Setting:** SHARP

**SOFT:** Primary importance attached to amplitude of the filter factor.

**SHARP:** Primary importance attached to phase of the filter factor.

### 084. MAIN-CW-SLOPE

**Function:** Selects the shape factor of the main band (VFO-A) DSP filter for the CW mode.

**Available Values:** GENTLE/MEDIUM/STEEP

**Default Setting:** MEDIUM

### 085. MAIN-CW-NARROW

**Function:** Selects the passband of the main band (VFO-A) DSP filter for the CW "narrow" mode.

**Available Values:** 25/50/100/200/300/400 Hz

**Default Setting:** 300 Hz

### 086. MAIN-PSK-SHAPE

**Function:** Selects the passband characteristics of the main band (VFO-A) DSP filter for the PSK mode.

**Available Values:** SOFT/SHARP

**Default Setting:** SHARP

**SOFT:** Primary importance attached to amplitude of the filter factor.

**SHARP:** Primary importance attached to phase of the filter factor.

### 087. MAIN-PSK-SLOPE

**Function:** Selects the shape factor of the main band (VFO-A) DSP filter for the PSK mode.

**Available Values:** GENTLE/MEDIUM/STEEP

**Default Setting:** MEDIUM

### 088. MAIN-PSK-NARROW

**Function:** Selects the passband of the main band (VFO-A) DSP filter for the PSK "narrow" mode.

**Available Values:** 25/50/100/200/300/400 Hz

**Default Setting:** 300 Hz

### 089. MAIN-RTTY-SHAPE

**Function:** Selects the passband characteristics of the main band (VFO-A) DSP filter for the RTTY mode.

**Available Values:** SOFT/SHARP

**Default Setting:** SHARP

**SOFT:** Primary importance attached to amplitude of the filter factor.

**SHARP:** Primary importance attached to phase of the filter factor.



## RX DSP GROUP

### 090. MAIN-RTTY-SLOPE

**Function:** Selects the shape factor of the main band (VFO-A) DSP filter for the RTTY mode.

**Available Values:** GENTLE/MEDIUM/STEEP

**Default Setting:** MEDIUM

### 091. MAIN-RTTY-NARROW

**Function:** Selects the passband of the main band (VFO-A) DSP filter for the RTTY “narrow” mode.

**Available Values:** 25/50/100/200/300/400 Hz

**Default Setting:** 300 Hz

### 092. MAIN-SSB-SHAPE

**Function:** Selects the passband characteristics of the main band (VFO-A) DSP filter for the SSB mode.

**Available Values:** SOFT/SHARP

**Default Setting:** SHARP

**SOFT:** Primary importance attached to amplitude of the filter factor.

**SHARP:** Primary importance attached to phase of the filter factor.

### 093. MAIN-SSB-SLOPE

**Function:** Selects the shape factor of the main band (VFO-A) DSP filter for the SSB mode.

**Available Values:** GENTLE/MEDIUM/STEEP

**Default Setting:** MEDIUM

### 094. MAIN-SSB-NARROW

**Function:** Selects the passband of the main band (VFO-A) DSP filter for the “narrow” SSB mode.

**Available Values:** 200/400/600/850/1100/1350/1500/1650/1800/1950/2100/2250 Hz

**Default Setting:** 1800 Hz

### 095. SUB-CW-SHAPE

**Function:** Selects the passband characteristics of the sub band (VFO-B) DSP filter for the CW mode.

**Available Values:** SOFT/SHARP

**Default Setting:** SHARP

**SOFT:** Primary importance attached to amplitude of the filter factor.

**SHARP:** Primary importance attached to phase of the filter factor.

### 096. SUB-CW-FIL-SLOPE

**Function:** Selects the shape factor of the sub band (VFO-B) DSP filter for the CW mode.

**Available Values:** GENTLE/MEDIUM/STEEP

**Default Setting:** MEDIUM

### 097. SUB-CW-NARROW

**Function:** Selects the passband of the sub band (VFO-B) DSP filter for the CW “narrow” mode.

**Available Values:** 25/50/100/200/300/400 Hz

**Default Setting:** 300 Hz

### 098. SUB-PSK-SHAPE

**Function:** Selects the passband characteristics of the sub band (VFO-B) DSP filter for the PSK mode.

**Available Values:** SOFT/SHARP

**Default Setting:** SHARP

**SOFT:** Primary importance attached to amplitude of the filter factor.

**SHARP:** Primary importance attached to phase of the filter factor.

### 099. SUB-PSK-SLOPE

**Function:** Selects the shape factor of the sub band (VFO-B) DSP filter for the PSK mode.

**Available Values:** GENTLE/MEDIUM/STEEP

**Default Setting:** MEDIUM

### 100. SUB-PSK-NARROW

**Function:** Selects the passband of the sub band (VFO-B) DSP filter for the PSK “narrow” mode.

**Available Values:** 25/50/100/200/300/400 Hz

**Default Setting:** 300 Hz

### 101. SUB-RTTY-SHAPE

**Function:** Selects the passband characteristics of the sub band (VFO-B) DSP filter for the RTTY mode.

**Available Values:** SOFT/SHARP

**Default Setting:** SHARP

**SOFT:** Primary importance attached to amplitude of the filter factor.

**SHARP:** Primary importance attached to phase of the filter factor.

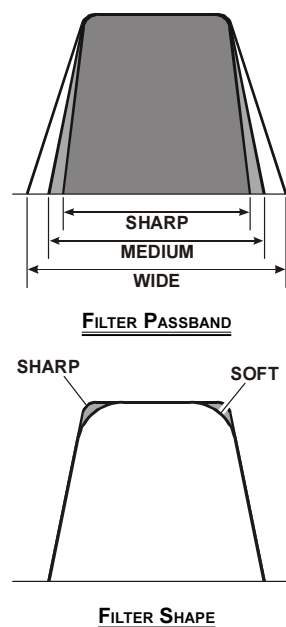

---

---

## RX DSP GROUP

---

---

### 102. SUB-RTTY-SLOPE

**Function:** Selects the shape factor of the sub band (VFO-B) DSP filter for the RTTY mode.

**Available Values:** GENTLE/MEDIUM/STEEP

**Default Setting:** MEDIUM

### 103. SUB-RTTY-NARROW

**Function:** Selects the passband of the sub band (VFO-B) DSP filter for the RTTY "narrow" mode.

**Available Values:** 25/50/100/200/300/400 Hz

**Default Setting:** 300 Hz

### 104. SUB-SSB-SHAPE

**Function:** Selects the passband characteristics of the sub band (VFO-B) DSP filter for the SSB mode.

**Available Values:** SOFT/SHARP

**Default Setting:** SHARP

**SOFT:** Primary importance attached to amplitude of the filter factor.

**SHARP:** Primary importance attached to phase of the filter factor.

### 105. SUB-SSB-SLOPE

**Function:** Selects the shape factor of the sub band (VFO-B) DSP filter for the SSB mode.

**Available Values:** GENTLE/MEDIUM/STEEP

**Default Setting:** MEDIUM

### 106. SUB-SSB-NARROW

**Function:** Selects the passband of the main band (VFO-A) DSP filter for the "narrow" SSB mode.

**Available Values:** 200/400/600/850/1100/1350/1500/1650/1800/1950/2100/2250 Hz

**Default Setting:** 1800 Hz

---

---

## SCOPE GROUP

---

---

### 107. MAIN FIX 1.8 MHz

**Function:** Selects the scan start frequency of the FIX mode Spectrum Scope while monitoring on the main band (VFO-A) 160 m amateur band.

**Available Values:** 1.800 - 1.999 MHz (1 kHz steps)

**Default Setting:** 1.800 MHz

### 108. MAIN FIX 3.5 MHz

**Function:** Selects the scan start frequency of the FIX mode Spectrum Scope while monitoring on the 80 m amateur band.

**Available Values:** 3.500 - 3.999 MHz (1 kHz steps)

**Default Setting:** 3.500 MHz

### 109. MAIN FIX 5.0 MHz

**Function:** Selects the scan start frequency of the FIX mode Spectrum Scope while monitoring on the 60 m amateur band.

**Available Values:** 5.250 - 5.499 MHz (1 kHz steps)

**Default Setting:** 5.250 MHz

### 110. MAIN FIX 7.0 MHz

**Function:** Selects the scan start frequency of the FIX mode Spectrum Scope while monitoring on the 40 m amateur band.

**Available Values:** 7.000 - 7.299 MHz (1 kHz steps)

**Default Setting:** 7.000 MHz

### 111. MAIN FIX 10 MHz

**Function:** Selects the scan start frequency of the FIX mode Spectrum Scope while monitoring on the 30 m amateur band.

**Available Values:** 10.100 - 10.149 MHz (1 kHz steps)

**Default Setting:** 10.100 MHz

### 112. MAIN FIX 14 MHz

**Function:** Selects the scan start frequency of the FIX mode Spectrum Scope while monitoring on the 20 m amateur band.

**Available Values:** 14.000 - 14.349 MHz (1 kHz steps)

**Default Setting:** 14.000 MHz

### 113. MAIN FIX 18 MHz

**Function:** Selects the scan start frequency of the FIX mode Spectrum Scope while monitoring on the 17 m amateur band.

**Available Values:** 18.000 - 18.199 MHz (1 kHz steps)

**Default Setting:** 18.068 MHz

### 114. MAIN FIX 21 MHz

**Function:** Selects the scan start frequency of the FIX mode Spectrum Scope while monitoring on the 15 m amateur band.

**Available Values:** 21.000 - 21.449 MHz (1 kHz steps)

**Default Setting:** 21.000 MHz

---

---

## SCOPE GROUP

---

---

### **115. MAIN FIX 24 MHz**

**Function:** Selects the scan start frequency of the FIX mode Spectrum Scope while monitoring on the 12 m amateur band.

**Available Values:** 24.800 - 24.989 MHz (1 kHz steps)

**Default Setting:** 24.890 MHz

### **116. MAIN FIX 28 MHz**

**Function:** Selects the scan start frequency of the FIX mode Spectrum Scope while monitoring on the 10 m amateur band.

**Available Values:** 28.000 - 28.699 MHz (1 kHz steps)

**Default Setting:** 28.000 MHz

### **117. MAIN FIX 50 MHz**

**Function:** Selects the scan start frequency of the FIX mode Spectrum Scope while monitoring on the 6 m amateur band.

**Available Values:** 50.000 - 53.999 MHz (1 kHz steps)

**Default Setting:** 50.000 MHz

### **118. SUB FIX 1.8 MHz**

**Function:** Selects the scan start frequency of the FIX mode Spectrum Scope while monitoring on the main band (VFO-A) 160 m amateur band.

**Available Values:** 1.800 - 1.999 MHz (1 kHz steps)

**Default Setting:** 1.800 MHz

### **119. SUB FIX 3.5 MHz**

**Function:** Selects the scan start frequency of the FIX mode Spectrum Scope while monitoring on the 80 m amateur band.

**Available Values:** 3.500 - 3.999 MHz (1 kHz steps)

**Default Setting:** 3.500 MHz

### **120. SUB FIX 5.0 MHz**

**Function:** Selects the scan start frequency of the FIX mode Spectrum Scope while monitoring on the 60 m amateur band.

**Available Values:** 5.250 - 5.499 MHz (1 kHz steps)

**Default Setting:** 5.250 MHz

### **121. SUB FIX 7.0 MHz**

**Function:** Selects the scan start frequency of the FIX mode Spectrum Scope while monitoring on the 40 m amateur band.

**Available Values:** 7.000 - 7.299 MHz (1 kHz steps)

**Default Setting:** 7.000 MHz

### **122. SUB FIX 10 MHz**

**Function:** Selects the scan start frequency of the FIX mode Spectrum Scope while monitoring on the 30 m amateur band.

**Available Values:** 10.100 - 10.149 MHz (1 kHz steps)

**Default Setting:** 10.100 MHz

### **123. SUB FIX 14 MHz**

**Function:** Selects the scan start frequency of the FIX mode Spectrum Scope while monitoring on the 20 m amateur band.

**Available Values:** 14.000 - 14.349 MHz (1 kHz steps)

**Default Setting:** 14.000 MHz

### **124. SUB FIX 18 MHz**

**Function:** Selects the scan start frequency of the FIX mode Spectrum Scope while monitoring on the 17 m amateur band.

**Available Values:** 18.000 - 18.199 MHz (1 kHz steps)

**Default Setting:** 18.068 MHz

### **125. SUB FIX 21 MHz**

**Function:** Selects the scan start frequency of the FIX mode Spectrum Scope while monitoring on the 15 m amateur band.

**Available Values:** 21.000 - 21.449 MHz (1 kHz steps)

**Default Setting:** 21.000 MHz

### **126. SUB FIX 24 MHz**

**Function:** Selects the scan start frequency of the FIX mode Spectrum Scope while monitoring on the 12 m amateur band.

**Available Values:** 24.800 - 24.989 MHz (1 kHz steps)

**Default Setting:** 24.890 MHz

### **127. SUB FIX 28 MHz**

**Function:** Selects the scan start frequency of the FIX mode Spectrum Scope while monitoring on the 10 m amateur band.

**Available Values:** 28.000 - 28.699 MHz (1 kHz steps)

**Default Setting:** 28.000 MHz

### **128. SUB FIX 50 MHz**

**Function:** Selects the scan start frequency of the FIX mode Spectrum Scope while monitoring on the 6 m amateur band.

**Available Values:** 50.000 - 53.999 MHz (1 kHz steps)

**Default Setting:** 50.000 MHz

## TUNING GROUP

### 129. MAIN DIAL STEP

**Function:** Setting of the Main Tuning Knob's tuning speed on the SSB, CW, and AM modes.

**Available Values:** 1 or 10 Hz

**Default Setting:** 10 Hz

### 130. MAIN DIAL CW FINE

**Function:** Setting of the Main Tuning Knob's tuning speed in the CW mode.

**Available Values:** ENABLE/DISABLE

**Default Setting:** DISABLE

**ENABLE :** Tuning in 1 Hz steps on the CW mode.

**DISABLE:** Tuning according to the steps determined via menu item 129: DIAL STEP.

### 131. 1MHz/100kHz SELECT

**Function:** Selects the tuning steps for the **CLAR/VFO-B** knob when the **BAND/MHz** button is pressed.

**Available Values:** 1 MHz/100 kHz

**Default Setting:** 1 MHz

### 132. AM CH STEP

**Function:** Selects the tuning steps for the microphone's **[UP]/[DWN]** keys in the AM mode.

**Available Values:** 2.5/5/9/10/12.5 kHz

**Default Setting:** 5 kHz

### 133. FM CH STEP

**Function:** Selects the tuning steps for the microphone's **[UP]/[DWN]** keys in the FM mode.

**Available Values:** 5/6.25/10/12.5/25 kHz

**Default Setting:** 5 kHz

### 134. FM DIAL STEP

**Function:** Setting of the Main Tuning Knob's tuning speed in the FM mode.

**Available Values:** 10/100 Hz

**Default Setting:** 100 Hz

### 135. MY BAND

**Function:** Programs a band to be skipped while selecting bands using the **CLAR/VFO-B** knob.

**Available Values:** 1.8 ~ 50/GEN/TRV

**Default Setting:** TRV

To program the band to be skipped, rotate the **CLAR/VFO-B** knob to recall the band to be skipped while selecting bands via the **CLAR/VFO-B** knob, then press the **[ENT]** key to change this setting to "ON." Repeat the same procedures to cancel the setting (skipped "off"). The skipped band will be high-lighted on the TFT display.

## TX AUDIO GROUP

### 136. F-PRMTRC EQ1-FREQ

**Function:** Selects the center frequency of the lower range for the front panel's parametric microphone equalizer.

**Available Values:** OFF/100 ~ 700 Hz (100 Hz/step)

**Default Setting:** OFF

**OFF:** The equalizer gain and Q-factor are set to factory defaults (flat).

**100 ~ 700:** You may adjust the equalizer gain and Q-factor at this selected audio frequency via menu items 138: F-PRMTRC EQ1-LEVEL and 139: F-PRMTRC EQ1-BWTH.

### 137. F-PRMTRC EQ1-LEVEL

**Function:** Adjusts the equalizer gain of the low range of the front panel's parametric microphone equalizer.

**Available Values:** -10 ~ +10

**Default Setting:** +5

### 138. F-PRMTRC EQ1-BWTH

**Function:** Adjusts the Q-factor of the low range of the front panel's parametric microphone equalizer.

**Available Values:** 1 ~ 10

**Default Setting:** 10

### 139. F-PRMTRC EQ2-FREQ

**Function:** Selects the center frequency of the middle range for the front panel's parametric microphone equalizer.

**Available Values:** OFF/700 ~ 1500 Hz (100 Hz/step)

**Default Setting:** OFF

**OFF:** The equalizer gain and Q-factor are set to factory defaults (flat).

**700 ~ 1500:** You may adjust the equalizer gain and Q-factor at this selected audio frequency via menu items 141: F-PRMTRC EQ2-LEVEL and 142: F-PRMTRC EQ2-BWTH.

### 140. F-PRMTRC EQ2-LEVEL

**Function:** Adjusts the equalizer gain of the middle range of the front panel's parametric microphone equalizer.

**Available Values:** -10 ~ +10

**Default Setting:** +5

### 141. F-PRMTRC EQ2-BWTH

**Function:** Adjusts the Q-factor of the middle range of the front panel's parametric microphone equalizer.

**Available Values:** 1 ~ 10

**Default Setting:** 10

## TX AUDIO GROUP

### **142. F-PRMTRC EQ3-FREQ**

**Function:** Selects the center frequency of the high range for the front panel's parametric microphone equalizer.

**Available Values:** OFF/1500 ~ 3200 Hz (100 Hz/step)

**Default Setting:** OFF

**OFF:** The equalizer gain and Q-factor are set to factory defaults (flat).

**15 ~ 32:** You may adjust the equalizer gain and Q-factor in this selected audio frequency via menu items 144: F-PRMTRC EQ3-LEVEL and 145: F-PRMTRC EQ3-BWTH.

### **143. F-PRMTRC EQ3-LEVEL**

**Function:** Adjusts the equalizer gain of the high range of the front panel's parametric microphone equalizer.

**Available Values:** -10 ~ +10

**Default Setting:** +5

### **144. F-PRMTRC EQ3-BWTH**

**Function:** Adjusts the Q-factor of the high range of the front panel's parametric microphone equalizer.

**Available Values:** 1 ~ 10

**Default Setting:** 10

### **145. R-PRMTRC EQ1-FREQ**

**Function:** Selects the center frequency of the low range for the rear panel's parametric microphone equalizer.

**Available Values:** OFF/100 ~ 700 Hz (100 Hz/step)

**Default Setting:** OFF

**OFF:** The equalizer gain and Q-factor are set to factory defaults (flat).

**100 ~ 700:** You may adjust the equalizer gain and Q-factor in this selected audio frequency via menu items 147: R-PRMTRC EQ1-LEVEL and 148: R-PRMTRC EQ1-BWTH.

### **146. R-PRMTRC EQ1-LEVEL**

**Function:** Adjusts the equalizer gain of the low range of the rear panel's parametric microphone equalizer.

**Available Values:** -10 ~ +10

**Default Setting:** +5

### **147. R-PRMTRC EQ1-BWTH**

**Function:** Adjusts the Q-factor of the low range of the rear panel's parametric microphone equalizer.

**Available Values:** 1 ~ 10

**Default Setting:** 10

### **148. R-PRMTRC EQ2-FREQ**

**Function:** Selects the center frequency of the middle range for the rear panel's parametric microphone equalizer.

**Available Values:** OFF/700 ~ 1500 Hz (100 Hz/step)

**Default Setting:** OFF

**OFF:** The equalizer gain and Q-factor are set to factory defaults (flat).

**700 ~ 1500:** You may adjust the equalizer gain and Q-factor at this selected audio frequency via menu items 150: R-PRMTRC EQ2-LEVEL and 151: R-PRMTRC EQ2-BWTH.

### **149. R-PRMTRC EQ2-LEVEL**

**Function:** Adjusts the equalizer gain of the middle range of the rear panel's parametric microphone equalizer.

**Available Values:** -10 ~ +10

**Default Setting:** +5

### **150. R-PRMTRC EQ2-BWTH**

**Function:** Adjusts the Q-factor of the middle range of the rear panel's parametric microphone equalizer.

**Available Values:** 1 ~ 10

**Default Setting:** 10

### **151. R-PRMTRC EQ3-FREQ**

**Function:** Selects the center frequency of the high range for the rear panel's parametric microphone equalizer.

**Available Values:** OFF/1500 ~ 3200 Hz (100 Hz/step)

**Default Setting:** OFF

**OFF:** The equalizer gain and Q-factor are set to factory defaults (flat).

**1500 ~ 3200:** You may adjust the equalizer gain and Q-factor at this selected audio frequency via menu items 153: R-PRMTRC EQ3-LEVEL and 154: R-PRMTRC EQ3-BWTH.

### **152. R-PRMTRC EQ3-LEVEL**

**Function:** Adjusts the equalizer gain of the high range of the rear panel's parametric microphone equalizer.

**Available Values:** -10 ~ +10

**Default Setting:** +5

### **153. R-PRMTRC EQ3-BWTH**

**Function:** Adjusts the Q-factor of the high range of the rear panel's parametric microphone equalizer.

**Available Values:** 1 ~ 10

**Default Setting:** 10

---

---

## TX GNRL GROUP

---

---

### **154. TX MAX POWER**

**Function:** Selects a maximum output power limit.

**Available Values:** 200/100/50/10 W

**Default Setting:** 200 W

### **155. TX PWR CONTROL**

**Function:** Configures the **RF PWR** knob.

**Available Values:** ALL MODE/CARRIER

**Default Setting:** ALL MODE

**ALL MODE:** The **RF PWR** knob is enabled on all modes.

**CARRIER:** The **RF PWR** knob is enabled in all modes except SSB. In this configuration, the SSB output power will be set to maximum, regardless of the **RF PWR** knob's position.

### **156. EXT AMP TX-GND**

**Function:** Enables/Disables the **TX GND** jack on the rear panel.

**Available Values:** ENABLE/DISABLE

**Default Setting:** DISABLE

### **157. EXT AMP TUNING PWR**

**Function:** Selects a maximum output power limit for driving the input circuit of an external linear RF amplifier while tuning (while using the Remote Control function of the linear RF amplifier).

**Available Values:** 200/100/50/10 W

**Default Setting:** 100 W

### **158. FULL DUPLEX**

**Function:** Enables/Disables Full Duplex operation.

**Available Values:** SIMP/DUP

**Default Setting:** SIMP

When this menu is set to "DUP," you may receive on the sub band (VFO-B) frequency while transmitting, during dual receive operation, on a different band on the main band (VFO-A).

### **159. VOX SELECT**

**Function:** Selects the audio input source for triggering TX during VOX operation.

**Available Values:** MIC/DATA

**Default Setting:** MIC

**MIC:** The VOX function will be activated by microphone audio input.

**DATA:** The VOX function will be activated by data audio input.

### **160. EMERGENCY FREQ TX**

**Function:** Enables Tx/Rx operation on the Alaska Emergency Channel, 5167.5 kHz.

**Available Values:** DISABLE/ENABLE

**Default Setting:** DISABLE

When this Menu Item is set to "ENABLE," the spot frequency of 5167.5 kHz will be enabled. The Alaska Emergency Channel will be found between the Memory channels "P-1" and "01 (or 1-01)."





# SPECIFICATIONS

---

## General

<b>Rx Frequency Range:</b>	30 kHz - 60 MHz (Operating) 160 - 6 m (Amateur bands only)
<b>Tx Frequency Ranges:</b>	160 - 6 m (Amateur bands only)
<b>Frequency Stability:</b>	±0.03 ppm (after 5 min. @ -10 °C ~ +60 °C [+14 °F ~ +140 °F])
<b>Operating Temperature Range:</b>	-10 °C ~ +60 °C [+14 °F ~ +140 °F]
<b>Emission Modes:</b>	A1A (CW), A3E (AM), J3E (LSB, USB), F3E (FM), F1B (RTTY), F1D (PACKET), F2D (PACKET)
<b>Frequency Steps:</b>	1/10 Hz (SSB, CW, & AM), 100 Hz (FM)
<b>Antenna Impedance:</b>	50 Ω, unbalanced 16.7 - 150 Ω, unbalanced (Tuner ON, 160 - 10 m Amateur bands, TX only) 25 - 100 Ω, unbalanced (Tuner ON, 6 m Amateur band, TX only)
<b>Power Consumption:</b>	Rx (no signal) 100 VA Rx (signal present) 120 VA Tx (200 W) 720 VA
<b>Supply Voltage:</b>	90 VAC - 264 VAC (Universal)
<b>Dimensions (WxHxD):</b>	20.4" x 6.5" x 17.3" (518 x 165 x 438.5 mm)
<b>Weight (approx.):</b>	66 lbs (30 kg)

## Transmitter

<b>Power Output:</b>	5 - 200 watts (5 - 75 watts AM carrier), Class A mode (SSB): 5 - 75 watts maximum
<b>Modulation Types:</b>	J3E (SSB): Balanced, A3E (AM): Low-Level (Early Stage), F3E (FM): Variable Reactance
<b>Maximum FM Deviation:</b>	± 5.0 kHz/± 2.5 kHz
<b>Harmonic Radiation:</b>	Better than -60 dB (160 - 10m Amateur bands) Better than -70 dB (6m Amateur band)
<b>SSB Carrier Suppression:</b>	At least 70 dB below peak output
<b>Undesired Sideband Suppression:</b>	At least 80 dB below peak output
<b>Audio Response (SSB):</b>	Not more than -6 dB from 400 to 2600 Hz
<b>3rd-order IMD:</b>	-31 dB @ 200 watts PEP, -50 dB @ 75 watts PEP (Class A mode)
<b>Microphone Impedance:</b>	600 Ω (200 to 10 kΩ)

Downloaded by  
RadioAmateur.EU

## Receiver

<b>Circuit Type:</b>	Triple-conversion superheterodyne		
<b>Intermediate Frequencies:</b>	VFO-A; 40.455 MHz/455 kHz/30 kHz (24 kHz for FM), VFO-B; 40.455 MHz/450 kHz/30 kHz (24 kHz for FM)		
<b>Sensitivity (IPO "OFF"):</b>	SSB (2.4 kHz, 10 dB S+N/N) 0.2 $\mu$ V (160 - 10 m Amateur bands) 0.125 $\mu$ V (6 m Amateur band) 2 $\mu$ V (0.1 - 50 MHz) AM (6 kHz, 10 dB S+N/N, 30 % modulation@400 Hz) 3.2 $\mu$ V (0.1 - 1.8 MHz) 2 $\mu$ V (1.8 - 30 MHz) 1 $\mu$ V (6 m Amateur band) FM (12 dB SINAD) 0.5 $\mu$ V (10 m Amateur band) 0.35 $\mu$ V (6 m Amateur band)		
<b>Selectivity (-6/-66 dB):</b>	Mode	-6 dB	-66 dB
	CW/RTTY/PKT	0.5 kHz or better	750 Hz or less
	SSB	2.4 kHz or better	3.6 kHz or less
	AM	9 kHz or better	18 kHz or less
	FM	15 kHz or better	25 kHz or less
	(WIDTH: Center, VRF/ $\mu$ -TUNE: OFF)		
<b>Image Rejection:</b>	70 dB or better (160 - 10m Amateur bands)		
<b>Maximum Audio Output:</b>	2.5 W into 4 $\Omega$ with 10% THD		
<b>Audio Output Impedance:</b>	4 to 8 $\Omega$ (4 $\Omega$ : nominal)		

*Specifications are subject to change, in the interest of technical improvement, without notice or obligation, and are guaranteed only within the amateur bands.*

# ***NOTE***

---



# ***NOTE***

---



This equipment has been tested and found to comply with the limits for a Class B digital device, pursuant to Part 15 of the FCC Rules. These limits are designed to provide reasonable protection against harmful interference in a residential installation. This equipment generates, uses and can radiate radio frequency energy and, if not installed and used in accordance with the instructions, may cause harmful interference to radio communications. However, there is no guarantee that interference will not occur in a particular installation.

If this equipment does cause harmful interference to radio or television reception, which can be determined by turning the equipment off and on, the user is encouraged to try to correct the interference by one or more of the following measures:

- Reorient or relocate the receiving antenna.
- Increase the separation between the equipment and receiver.
- Connect the equipment into an outlet on a circuit different from that to which the receiver is connected.
- Consult the dealer or an experienced radio/TV technician for help.

1. Changes or modifications to this device not expressly approved by VERTEX STANDARD could void the user's authorization to operate this device.
2. This device complies with part 15 of the FCC Rules. Operation is subject to the following two conditions; (1) this device may not cause harmful interference, and (2) this device must accept any interference including interference that may cause undesired operation.
3. The scanning receiver in this equipment is incapable of tuning, or readily being altered, by the User to operate within the frequency bands allocated to the Domestic public Cellular Telecommunications Service in Part 22.

#### DECLARATION BY MANUFACTURER

The scanner receiver is not a digital scanner and is incapable of being converted or modified a digital scanner receiver by any user.

**WARNING: MODIFICATION OF THIS DEVICE TO RECEIVE CELLULAR RADIOTELEPHONE SERVICE SIGNALS IS PROHIBITED UNDER FCC RULES AND FEDERAL LAW.**



**VERTEX STANDARD CO., LTD.**

4-8-8 Nakameguro, Meguro-Ku, Tokyo 153-8644, Japan

**VERTEX STANDARD**

**US Headquarters**

10900 Walker Street, Cypress, CA 90630, U.S.A.

**YAESU EUROPE B.V.**

P.O. Box 75525, 1118 ZN Schiphol, The Netherlands

**YAESU UK LTD.**

Unit 12, Sun Valley Business Park, Winnall Close  
Winchester, Hampshire, SO23 0LB, U.K.

**VERTEX STANDARD HK LTD.**

Unit 5, 20/F., Seaview Centre, 139-141 Hoi Bun Road,  
Kwun Tong, Kowloon, Hong Kong



Copyright 2005

**VERTEX STANDARD CO., LTD.**

All rights reserved

No portion of this manual  
may be reproduced without  
the permission of  
**VERTEX STANDARD CO., LTD.**

Printed in Japan.