

HF/50MHz Transceiver

FTDX9000



The radio... YAESU
Choice of the World's top DX'ers

Ours is an age of “easy” communications via the Internet. Push a button,
and your message is sent without hearing a sound.
Which is precisely why, today, the allure of HF DX communication is stronger than ever.

HF DX involves communication with imagination. . .

The dream of faraway places and the wonder at how your signal will get to the far side of the world.
The noise, the polar flutter, the echo of the Long Path. . . and the sudden joy at hearing your callsign
being sent in response to your call.

This is the essence of DX, and only a person who has experienced the thrill can know the thrill.

Drama, emotion, and excitement. . .

These are the essential elements of the lure of HF DX.
A fundamental human need to know what's out there.

The magnificence of Nature brings unforeseen ionospheric encounters, and you prepare yourself for
these special moments. You improve your technical skills, optimize your antennas,
and tweak your rig for the best possible performance.

It's been said that the destination is not as important as the journey.
Surely this expression was written with Ham Radio in mind. . .

HF Excitement

The lure of HF DX. . .

The Radio: FT DX 9000

The birth of a new reality. . .

The dynamic environment in which you operate demands that you exercise the most effective command possible over your station. It's not enough just to receive and transmit. You need to convert your knowledge and intuition about band conditions and the pile-up behavior into a configuration for your equipment that carries the day. With the YAESU FT DX 9000, you'll marvel at how your high expectations are exceeded, every time you turn on the rig!

This is a radio only YAESU can make.
One that will surprise you and inspire you.

A select radio for a select user. . .you!

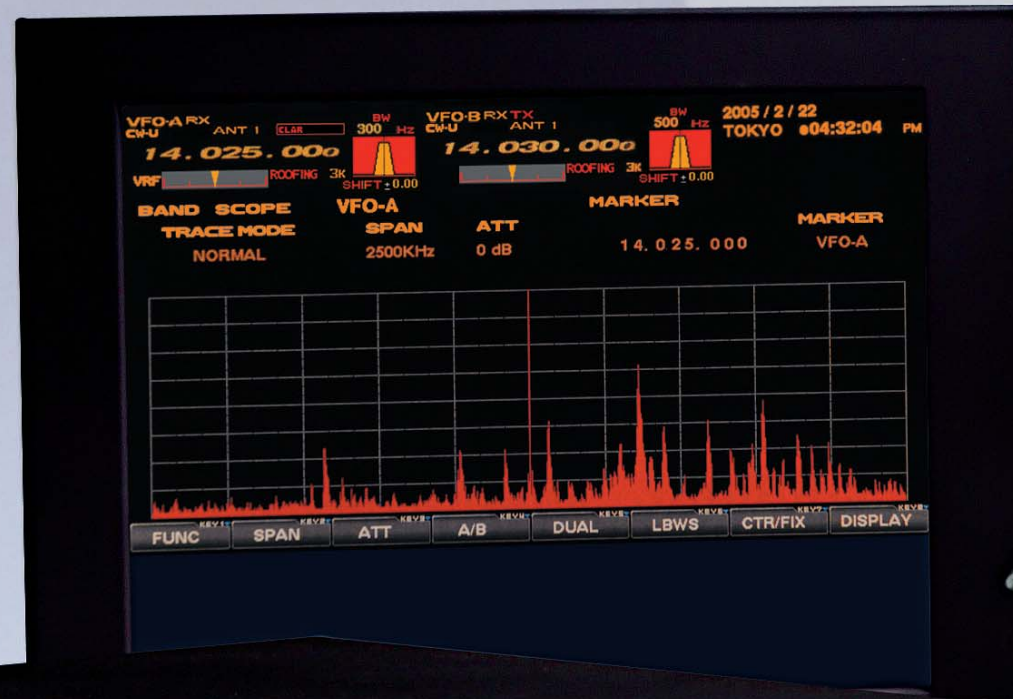

Photograph depicts after-market keyboard, keyer paddle, and monitor, not supplied with transceiver. Display image simulated and may differ in actual use.

Single Side Band DNA

Historical Background

For over half a century, the enthusiasm and dedication of our customers has fed our product development pure research efforts. Whether our users were at home, on the side of a Himalayan peak, or atop the Antarctic snow pack, their communications needs associated with their adventures have fed our design passion and know-how.



A decades-long friendship and professional collaboration between our Founder, Mr. S. Hasegawa and HF DX legend Mr. Don Wallace, W6AM, is typical of the kind of relationship that brought about the development of the "FT DX" concept of high-performance DX-ready transceivers.

For You, the HF Specialist. . .

The history of the Yaesu product centers around the development of SSB technology, and the specialized knowledge we possess is derived from having pioneered the technology originally. Our Founder, Mr. S. Hasegawa, JA1MP, began with prototype SSB generators, moving on to the development of the balanced modulator and the use of IF crystal filters and their outstanding shape factor characteristics to generate a voice wave-form. From these early steps, we have arrived at the zenith of SSB communications, the introduction of the FTdx 9000.

Fifty years ago, AM reigned as the modulation technique used for Amateur communication. But a bright young engineer named Hasegawa realized the potential that lay in the efficiency of SSB, and he devoted his life to the development of this new technology. Years of research brought about new breakthroughs in stability and signal purity, and within ten years SSB had supplanted AM as the dominant modulation technique, and it remains so today.

Beginning in 1962, Yaesu products such as the FL-10 and FL-20 transmitters, and FL-100/FR-100 transmitter/receiver combo, captured the imaginations of Radio Amateurs worldwide, bringing them worldwide communications possibilities they had only dreamed of a few years earlier. Then, in 1970, came the introduction of the world's first self-contained AC/DC HF SSB transceiver, the FT-101, of which over two hundred thousand were sold. The FT-101 Series was followed by the first all-solid state transceiver, the FT-301, signaling the "beginning of the end" for tube-type equipment. Later market-leading models included the FT-901, FT-107, FT-102, FT-980, and, in 1990, the FT-1000, which dominated the marketplace for over a decade.

Nowadays, when Hams think of SSB, they think of YAESU, and they think of the company that made manufacturing of high-quality SSB equipment practical and affordable. And by being on the air with the technology pioneered by Mr. Hasegawa in his youth, they serve to keep his legacy very much alive.



The Best of the Best – From The House that SSB Built

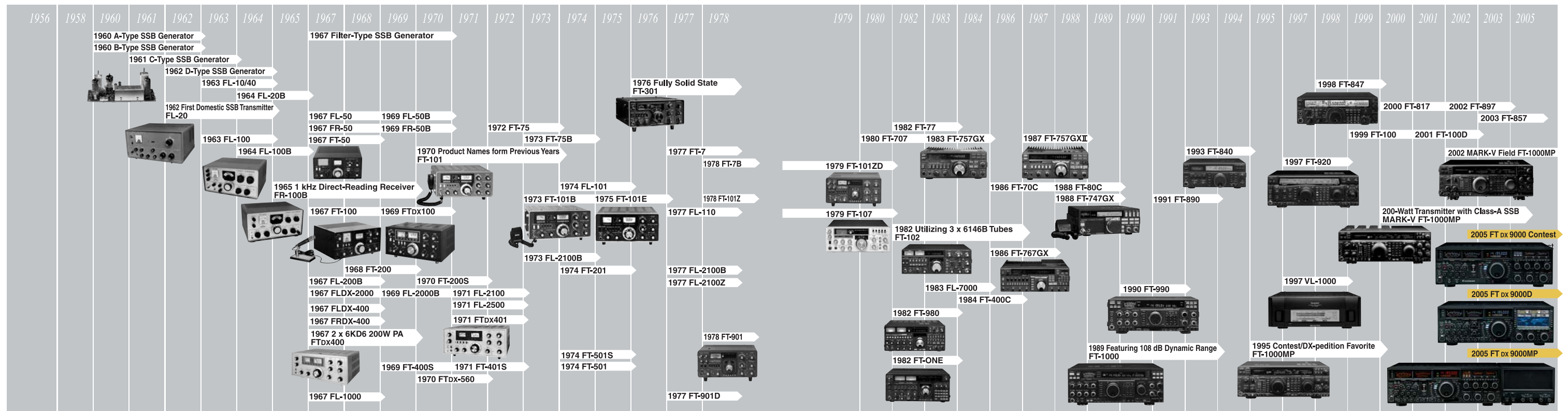

Passion for Radio

On-The-Air Devotion

YAESU HF transceivers have received acclaim from prominent DXers on every continent. There is a good reason for this: our engineers share a never-ending passion for DXing with the DX operators who use our products!



(from June, 1977 edition, CQ Ham Radio)

Overwhelming , eminent presence.
Nothing to compromise,
seeking perfection in all areas of transceiver design.



If you inspect this life-size photograph yourself,
you'll realize that words do not do justice to its beauty.

Photograph: FT DX 9000D, Actual Size

Craftsmanship

It's not just about size and shape and weight. It's a profound knowledge and understanding of the most subtle aspects of form, response sensitivity, and layout of front panel controls, both individually and when taken as a system. This knowledge comes not from a book, but rather from the weight of history of personal experiences, and dedication to perfecting one's art. It's the essence of the mindset of a craftsman.

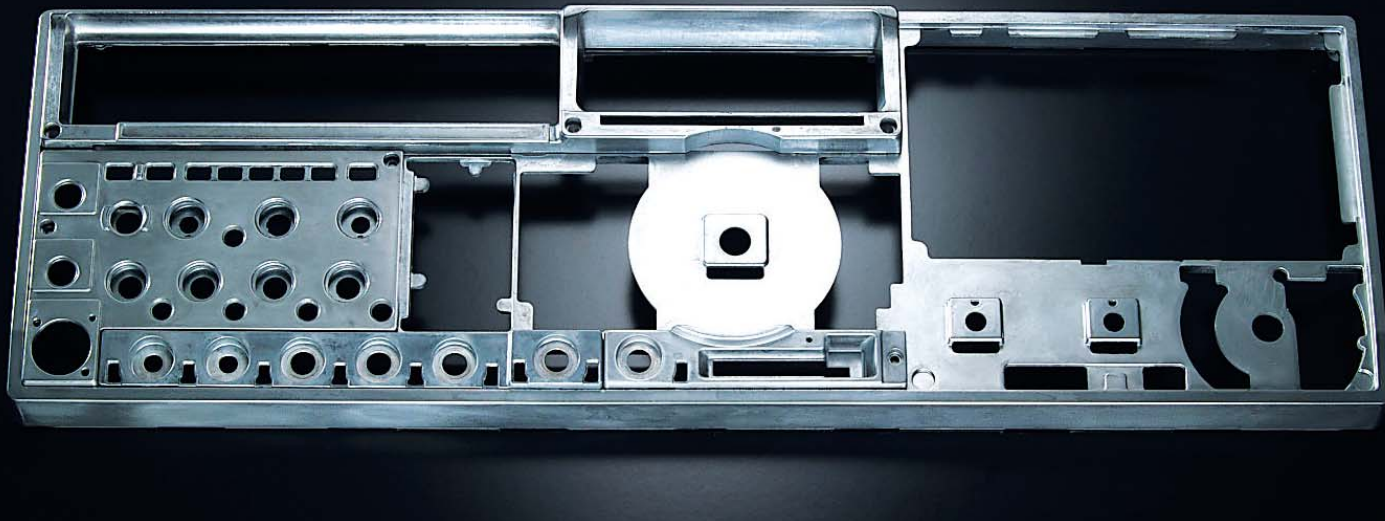

The large aluminum die-cast front panel, created in an 800-ton, high-accuracy die-cast molding machine, is crafted with the precision you expect in an elite-class transceiver.

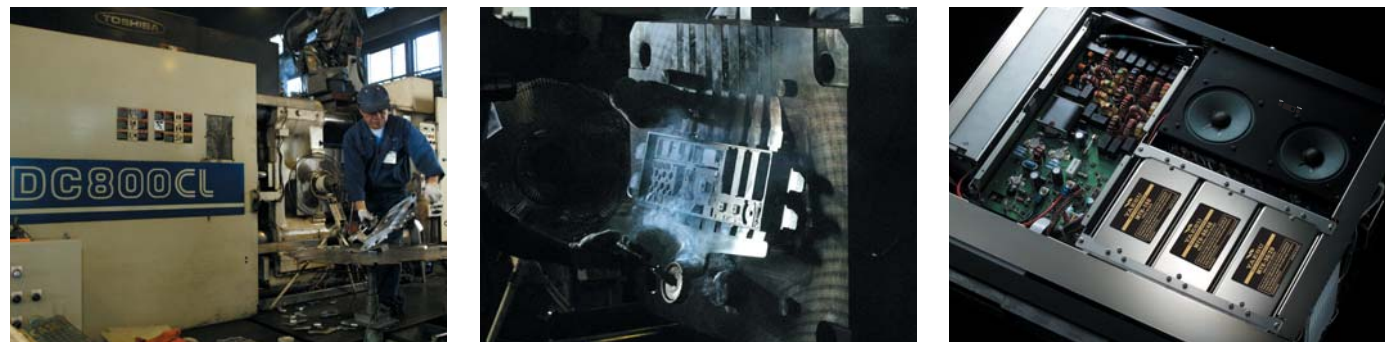

Visibility

From the moment you switch on the power for the first time, your eyes catch only information you need, as if it always has been there. You blend comfortably into the HF world without feeling like you do not belong. Only the necessary information, and only in the right place. This is what we think is superb visibility.

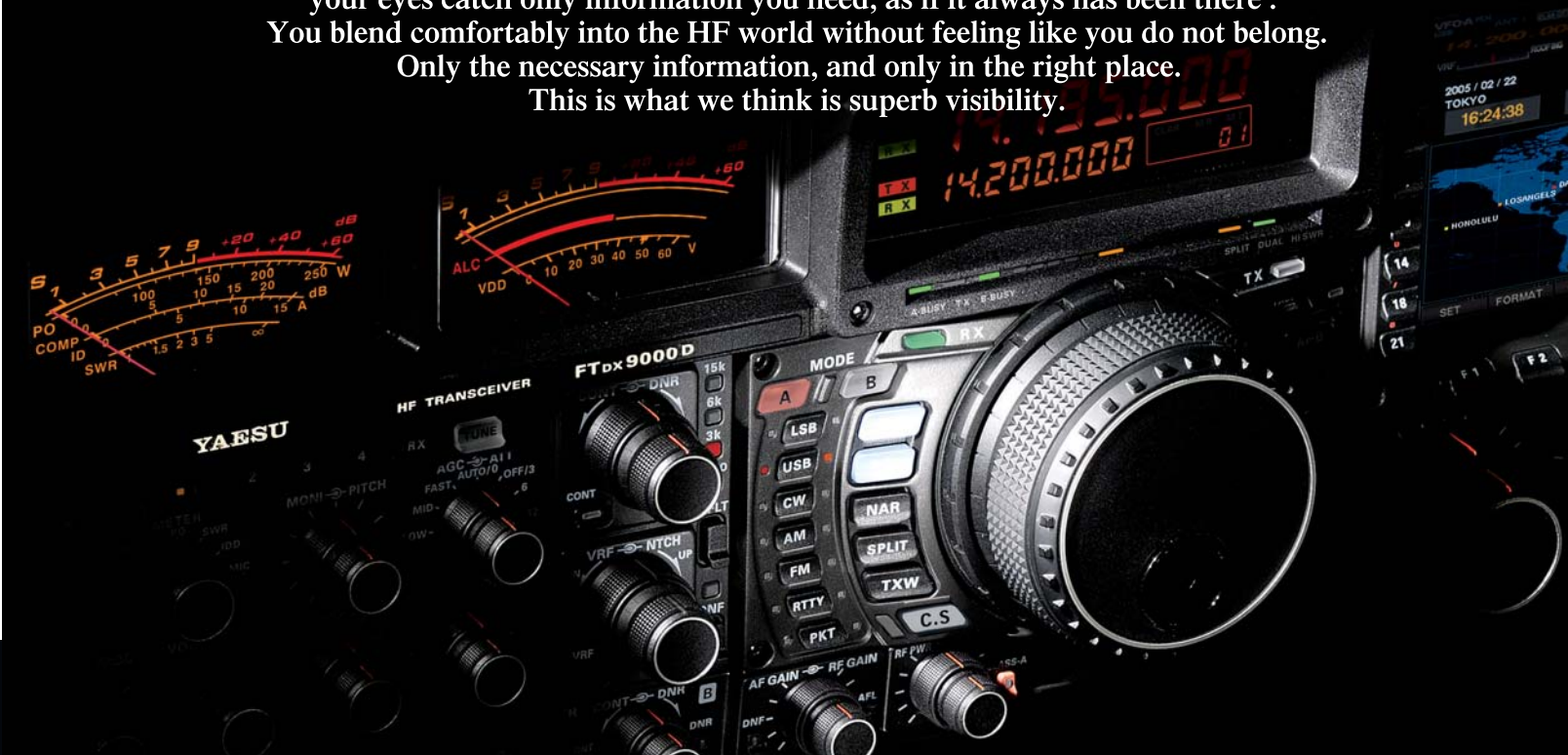

Facing this rig, it is a propitious moment in time. As if you were in an aircraft cockpit, the displays are inclined toward your eyes. This is your space, where you can immerse yourself in the sounds of the bands, enjoying the passage of time. The radio created for talking to Mother Nature's wonders: the FT DX 9000.

Superb Visibility, Traditional Layout

Designed for use by long-haul contest operators, the superior front panel layout emphasizes simplicity and clarity of viewing for the most important area on the front panel: the main frequency display above the main tuning dial. The center frequency display is not cluttered with extraneous information; just frequency and TX/RX status are provided, to keep it simple. The important transceiver operating status conditions are shown on the two large analog meters on the left side of the front panel, affording you instant recognition of the information most critical to your operating success.



Independent Analog Clarifier Display

Helping to provide an instantaneous, intuitive notation of receiver offset status to the operator, the FT DX 9000 provides both a digital display of the Clarifier frequency offset, as well as an analog depiction of the direction and magnitude of the offset. Whether you're moving fast to find callers during a "run" in a contest, or simply following a slow drift on another station in a local rag-chew, an instantaneous visual feedback is provided by the analog Clarifier scale, which is conveniently located between the main tuning dial and the center frequency display.

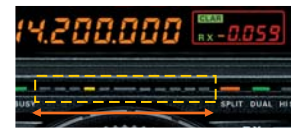

Your Station Becomes a Cockpit, with All Meters Facing the Pilot

Just as in a cockpit, the meter faces are inclined at a 2° angle, so as to face the operator directly, thus eliminating glare and difficulty in reading the indications.

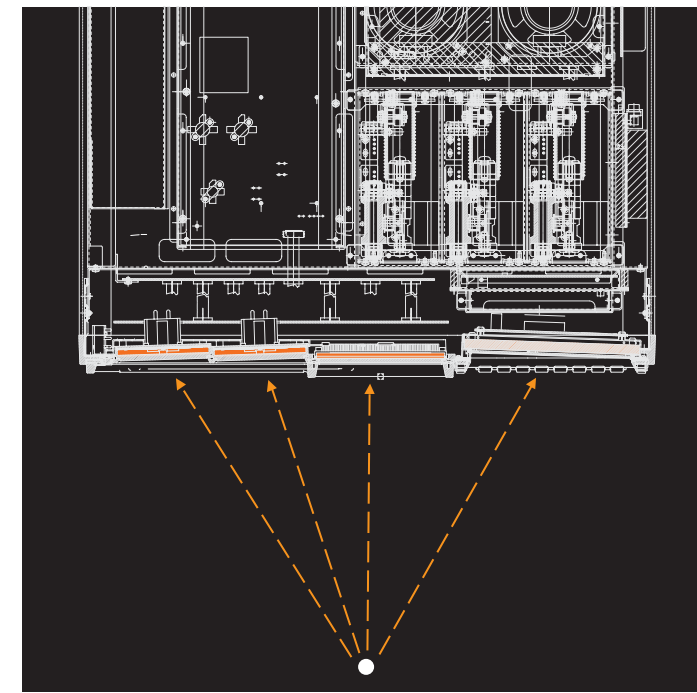

Dual High-Accuracy Analog Meters

The FT DX 9000 utilizes custom-designed high-accuracy 3.4" (86 mm) true analog meters, providing excellent visibility due to the wide meter scale and the bright, back-lighted lettering (using 20 long-life white LEDs) on the meter scales. The left meter is a comprehensive TX/RX meter, operating primarily as the "S-Meter" for the main Receiver. The right meter is always the S-Meter for the Sub Receiver, thus minimizing confusion, and on transmit it serves as an ALC Meter for the transmitter, allowing simultaneous monitoring of ALC along with Power Output, Compression Level, Microphone Input Level, PA Current, or SWR on the left meter. On the "Contest" and "MP" versions, two additional meters on the right side of the front panel allow monitoring of PA Voltage, Bias, SWR, and PA Temperature, and the "D" version displays these parameters on its 6.5" TFT!



Proprietary Large-digit High-brightness VFD (Fluorescent Character Display Tube)

The main frequency display of the FT DX 9000 is a uniquely easy-to-read, and very bright, VFD (fluorescent character display tube), providing frequency indication for both Main and Sub VFOs separately from the TFT display. Contrast is excellent, and the frequency displays are easily visible over an incredibly wide viewing angle. In order to reduce fatigue even further, when operating in a monoband mode you may elect to display only the Main VFO frequency information, if you prefer.



● Dual Band Display Mode ● Monoband Display Mode

Umber and Light Blue Display Options

Among the display options, at the time of purchase, are the normal Umber display or the alternative Light Blue option. Both are outstanding for long hours of operation with minimal fatigue due to eye strain, and the proprietary display design provides outstanding contrast, whichever option you choose. Color modification is available after purchase; the entire display must be changed out in this case.



● Umber Display



● Blue Display

Various Function Indicators

The display possibilities abound on the FT DX 9000 depending on the configuration. The 6.5", 800 x 480 dot TFT of the FT DX 9000D includes a number of status displays, including a band-swept SWR display, Spectrum Scope, log book, audio scope and oscilloscope page with waveform and "waterfall" displays, memory channel listings, Menu listings, and a multi-function World Clock with sunrise/sunset display. In the Spectrum Scope mode, the lower part of entire TFT becomes the spectrum display, for maximum viewing ease and resolution, important for discerning weak signals in the noise and interference on the band. And, when using a YAESU rotator, the TFT may be utilized for display and control of rotator operations.

FT DX 9000 Series

On the MP and Contest versions, a 1.8" 160 x 128 dot LCD is utilized, providing indication of the VFO-B frequency, along with Main and Sub VFO passband displays, in addition to being used for Menu setting. To the right of the LCD, two additional large analog meters provide monitoring of SWR and PA Voltage; you may also display PA Heat Sink Temperature and PA Bias point. Below the meters, four large knobs are provided for adjustment of the Passband Contour, Digital Noise Reduction, VRF (Receiver Preselector), and the IF Notch filter.



● LCD/FT DX 9000MP/Contest ● FT DX 9000D/TFT Display



● FT DX 9000MP/Contest

What's more, when using the MP, Contest or D version, you may display the contents of the FT DX 9000D's TFT by connecting an LCD or other monitor to the rear panel's "DISPLAY" jack (on the Contest version, the Data Management option is required in order to connect an external display).



Main/Sub Band Functional Display LEDs

Convenient indication LEDs are strategically positioned near the knobs or function displays associated with them, and in the case of the two receivers the functions are easily separated due to the Main Receiver being associated with Red LEDs, and the Sub Receiver with Orange. The easy recognition of functions and their status aids in reducing operator stress over long hours of operation, day or night.



Indirect Illumination

For ease of nighttime operation, the controls on the front panel are indirectly illuminated, thanks to carefully-positioned lamps in the frame underneath the meters and TFT (depending on model).



Operability

Even the first time you operate the FT DX 9000, you're not searching for a knob you need to turn, but naturally your fingers touch the right location on the front panel; this is the intuitive feeling we have labored to achieve. And the more time you spend with this rig, the more comfortable you'll feel with every aspect of operation. This is superb operability.



The Joy of Operating

In the ideal case, you and your transceiver become as one. Besides just being a transmitter for your signal, your rig must be designed with the most important functions immediately available for adjustment. When fleeting opportunities present themselves, the superior operability of the FT DX 9000 lets you seize the moment.

Touch the Main Dial, and You Know the FT DX 9000 is Different...

- The Main Tuning Dial is a large-diameter (3.2"/81 mm) die-cast aluminum dial directly coupled to the magnetic rotary encoder which drives the HRDDS via microprocessor control. Its heavy weight (7 oz./200 g) and quality mounting and construction provide a smooth "flywheel" effect during operation, ideal for quick cruising up and down a band.
- The main tuning dial is constructed in two parts, main dial and skirt. When you touch your fingers on main dial, your fingertip feels the air gap between the skirt and main dial. This air gap reduces sweat accumulation on the operator's fingertips, enhancing tuning precision during long operating sessions, especially on DX-peditions to hot tropical areas.
- Ease of operation is further enhanced by the convenient positioning of frequency-determining switches immediately adjacent to the Main Tuning Dial. VFO and Memory selection switches are all located to the right, while the "Store" and "Recall" switches for the Quick Memory Bank (QMB) memory registers are easy-to-spot blue switches just to the left of the Main Tuning Dial.



- Torque adjustment of the main dial is made possible by use of the dual structure of the dial and its associated skirt. Boasting an ultra-smooth flywheel effect, the dial affords you a light tuning touch, with the profound feeling of quality associated with a heavy, precision dial assembly. Just hold the dial skirt, and rotate the main dial structure, and you can quickly customize the dial torque for just the right "feel" for your style of tuning.
- From the skillful way that the finger hole in the main dial is carved from the heavy aluminum knob structure, to the quality and precision of the bearing used to secure the dial drive shaft, you're in for a profoundly enjoyable experience from the simple act of tuning your FT DX 9000!

Three Large Knobs for Effortless Operation

On the lower right-hand side of the front panel, three large (1.5"/39 mm) knobs are provided for several of the most often-used control operations. The AF/RF Gain knobs are high-quality, concentric volume test controls with the extreme durability normally found on high-use test equipment. The SHIFT/WIDTH controls utilize a carefully-specified dial tension, so as to ensure both ease and precision in adjustment and stability of the settings.



Multi-Function Dial

To the right of the other two primary control knobs is a "multi-function" knob that serves a number of important purposes. Its most-often-used tasks include VFO-B and Clarifier (offset) tuning, and the large diameter makes precise tuning effortless. When operating in the VFO-B mode, moreover, this knob may be used for tuning in 500 kHz steps (for quick "general coverage" band change), as well as operating mode selection for VFO-B. When operating in the "VFO-B" mode, the outer circle lights up in orange, matching the color of the VFO-B labels, thus preventing operator confusion and errors. This dial also can be used for auxiliary functions such as 100kHz Up/Down QSY, plus the innovative "My Bands" quick band selection feature, as well.



Dial Swap Feature

The AF and RF Gain controls are large knobs located at the bottom right side of the front panel, and being concentric they are ideally configured for most use. However, if you are a heavy user of Dual Receive, you may wish to take advantage of a unique convenience facility of the FT DX 9000: use the Menu to change the outer knob (originally Main VFO RF Gain) to be Sub VFO AF Gain instead. Now you can adjust either Main or Sub Receiver audio levels instantaneously, without moving the position of your right hand!



"My Bands" Feature

When changing bands using the multi-function knob on the right side of the front panel, you can customize the band selection by omitting bands you do not need at the moment, thus reducing clutter and confusion when changing bands in a contest. It's also great when using a multi-band antenna whereby operation on certain bands is not possible.

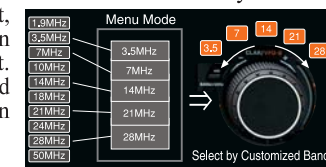

As you tune the dial, you're in a special seat reserved for true HF enthusiasts...

Many important control functions have been brought out of the configuration menu and placed on the front panel, per the requests of active operators worldwide, and they're grouped in together for instant access. For CW operation, controls such as Pitch, Keyer Speed, CW Delay, and Keyer On/Off are all closely grouped, while for SSB the VOX Gain and Delay, Mic Gain, Processor Level, and Compression Level metering controls are positioned close together. And operations associated with the Sub Receiver are all assembled in a special area on the bottom left-hand side of the panel, so you may use your left hand for feature selection and your right hand for tuning of the Sub Receiver. Both direct frequency entry and one-touch band change are also provided, for efficient QSY.



CS Key

The Custom Selection (CS) key, located below and to the left of the main tuning dial, serves as a "hot key" to an often-used Menu selection, providing a quick means of returning to a Menu item you use often.



Keyboard-based Logbook Feature

The rear panel includes convenient USB and PS-2 keyboard terminals, which may be utilized for connection of an aftermarket computer keyboard (not supplied) for entry of data for the onboard Logbook function. The date, time of day, frequency, and mode are entered automatically by the microprocessor, allowing you to save time by entering just the callsign and personal data of the other station!



To use the log book feature, your rig requires the internal TFT or external aftermarket LCD monitor with the Data Management Unit. The Data Management Unit is installed in MP and D versions, and is optional on the Contest Version.

Smart Memory Card for Data Storage

The Smart Memory (CF) card may be used to store useful information, such as your favorite band setup configuration, as well as look book data, which you can then download to your PC for utilization with aftermarket logging or station-management software.



• While the CF card is being accessed, a Red LED will light up. • The CF card's rugged die-cast aluminum housing ensures long-term reliability.

Antenna Switching Optimized for Contest Use

Antenna switching on the FT DX 9000 is accomplished electronically, with one-touch ease of storage and access for arranging your antennas, on the Main and Sub VFOs, for efficient contest and DX operation. A dedicated receive-only jack is provided for Beverage or receiving loop use. And for insertion of a special bandpass filter, preamp, etc., BNC In/Out jacks are provided in the receiver input path, for quick connection and minimal confusion with other rear-panel jacks.



• Antenna Selection: ANT 1-VFO A, Red LED/ANT 2-VFO B, Orange LED.

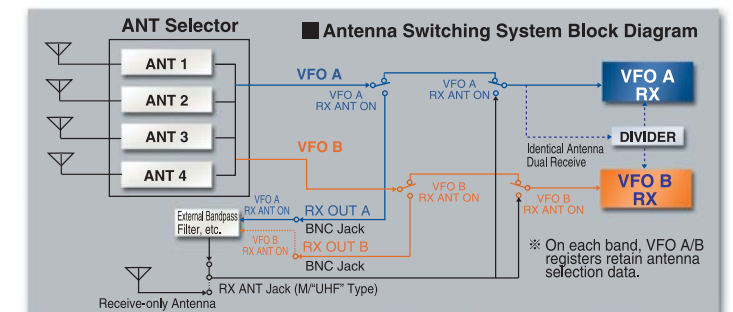

Features Crafted for Real-World Operation

The Quick Memory Bank (QMB) remembers frequency and mode data with one-touch Storage and Recall capability. And the FT DX 9000 also includes a valuable 30-second Digital Voice Recorder that stores the incoming audio for the most-recent 30-second period, so you can go back and review what was being received in case you missed some important information during the other station's transmission!

Consistently, yet Boldly.

True evolution, when examined closely, involves change that will stand the test of time.
Not just random jumps of technology made for their own sake;
rather, features born out of necessity and experience.
And the result of the accumulated knowledge and experience is a superior transceiver
whose name will be etched in history for all time. . .

This is the attitude of the true pioneer.

In developing the FT DX 9000, we have poured in much more than four years
of engineering expertise, passion, and experience. . .
we are driven by our five decades as a true pioneer in HF technology.

This is the birth of The Radio, born with overwhelming features and specifications,
and endowed with a competition-grade future.

**We seek to combine the highest quality
with the utmost in operating efficiency
and technological advancement to enhance
the final product that you will enjoy on the air.**

From the original design concept, through the circuit evaluations
and on to the final product field testing, our engineers utilize their technical knowledge
and passion for excellence to crystallize the ultimate operating experience into this exciting new product,
and the DNA of an entire new generation of HF operating has now been born.

Comprehensive attention to balance from beginning to
end of the receiver design leads to a superior final result.
There is no substitute for delicate care in crafting the optimum gain distribution in each stage,
properly defining the local oscillator levels and minimizing noise, optimizing the attack
and release properties of the AGC, and generally accounting for every aspect of signal
and real-world noise behavior throughout the receiver.
With superior knowledge and care in design comes a superior operating experience for you.

400 MHz High-Resolution Direct Digital Synthesizer (HRDDS)

40.455MHz 1st IF 3 kHz Roofing Filter

Triple-Conversion Design

Advanced VRF Preselector + Ultra-High-Q “ μ -Tune” RF Filter

IF SHIFT, Variable Bandwidth, IF Notch, and Passband-Perturbation (“Contour”)
Selectivity using Super Multi-Function 30 kHz/32-Bit Floating-Point IF DSP

Two Identical, Independent Receivers (2nd Receiver optional on Contest version)

Continuously-Adjustable SSB Bias, with Class-A Operation

The close-in, multi-signal environment. . . This is where a truly high-quality radio makes the difference.

The instant the antenna is connected, you hear a gentle rush, but you immediately notice how low the noise level is. Then you begin to observe weak signals that you probably never knew were there. But this was just the starting point for our research and development team for their elite class HF transceiver for the new decade.

Not only did they devote attention to measurement data such as BDR (Blocking Dynamic Range), IDR (IMD Dynamic Range), and IP3 (3rd-Order Intercept Point), which all are in the limelight in the modern HF industry, but they also directed special attention on high performance in the difficult close-in multiple-strong-signal environment by determining the optimum gain allocation for each stage, the purity of all local signals, adequate gain in the mixers, and then followed the research up with exhaustive field tests.

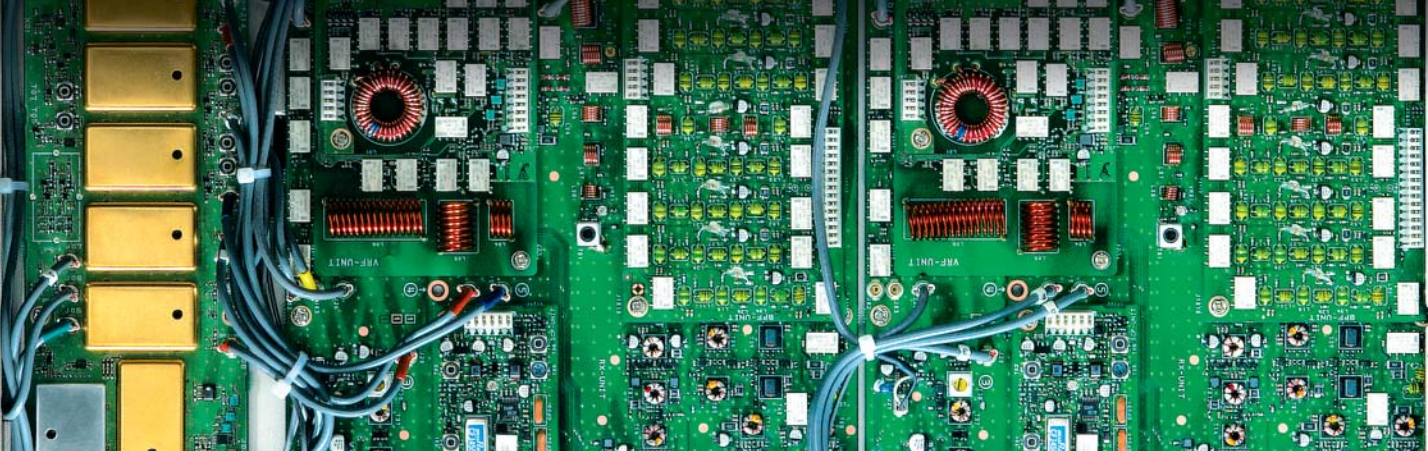

Creating serenity out of HF band chaos. . . it's the everlasting mission of an HF transceiver

Nature provides the propagation. . . and the noise, and your stress level rises as you anticipate the QRM. But from the first moment you experience truly quiet reception, you begin to realize the real wonder and glory of HF DX.

The Ultimate Overall Receiver Performance, Achieved through Balanced, High-Level Design

In elite-class Contest and DX-pedition environments, a large number of high-power stations are calling simultaneously inside a window of only a few kHz. Frequently, the RF front end's capabilities are exceeded by the presence of these high powered stations, obstructing reception due to a number of serious performance problems such as receiver gain compression, as well as an increase in internally-generated noise from the receiver's own local signals. The front end of an HF radio, of course, faces the diverse challenge of dealing with multiple signals, ranging in strength from micro-Volts to dozens of Volts, in addition to constantly-changing noise levels. The stress from this hostile RF environment is very harsh on a receiver's RF front end. Our engineering team has concentrated on improving the performance of a receiver operating in this kind of harsh environment. Most importantly, they have recognized the need to improve the overall receiver performance, balanced at the highest levels, and considering all measurement data (including BDR, IDR, IP3) to form a unified, optimized receiver figure of merit. This important optimization and balance have resulted in a superior receiver with the highest order of performance.

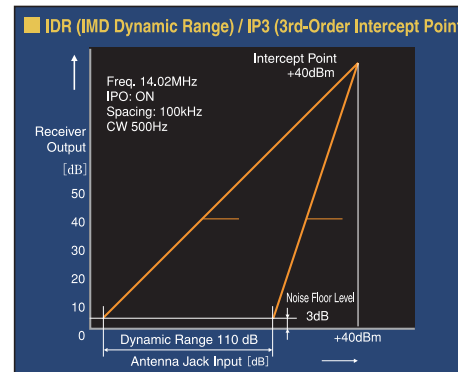
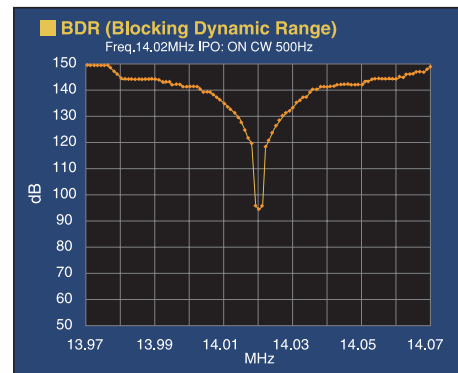

Moreover, care must be exercised when evaluating the claimed specifications of high-end receivers, as the precise measurement techniques associated with those specifications may be misleading. For example, a receiver with an outstanding Blocking Dynamic Range, measured with a test signal 100 kHz away, may, nonetheless, have inferior front-end characteristics when signals much closer than 10 kHz are encountered (as they typically are in a Contest or DX-pedition environment). Noise may be generated inside the receiver, to the extent that the desired signal is obscured by the noise or AGC action suppressing the sensitivity. Ultimately, the desired signal is lost.

Throughout the four-year FT DX 9000 design process, our mission has been to tackle the life-long challenges of multiple-signal interference, external noise, and internally-generated noise, and we have stayed true to the mission through completion of the FT DX 9000 Project. We are confident that you will enjoy the result.

Ultra-Low-Noise Local Oscillator System Creates "The Sound of Silence." World's First 400 MHz High-Resolution Direct Digital Synthesizer (HRDDS): Unmatched Capability to Ensure Weak Signal Reception in a High-Level, Multi-Signal Environment

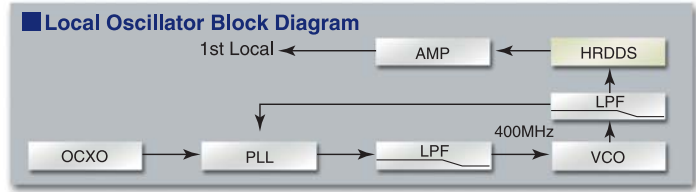

In order to make a dramatic improvement in multi-signal, close-in strong signal handling performance, new thinking was required in the crafting of the first local oscillator (LO), critical to the process because it feeds the important first mixer of the receiver. A noisy first LO can cause irreparable degradation to the received signal, as the noise cannot be removed in succeeding stages of the receiver. Traditional PLL systems, in seeking to achieve a rapid lock time, suffer a rapid rise in LO noise around the carrier signal. The HRDDS (High Resolution Direct Digital Synthesizer) system being introduced in the FT DX 9000 Series utilizes a direct locking technique using a 400 MHz reference signal, resulting in a lock time that approaches zero; because the lock time is zero, the inversely-related C/N ratio has no degradation close-in, resulting in unprecedented maintenance of the signal-to-noise ratio close to your operating frequency, and the BDR performance follows suit.

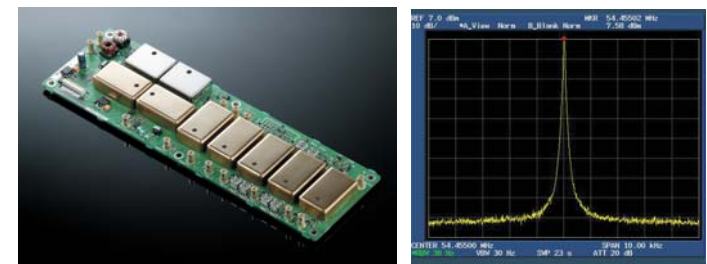

Local Oscillator Unit w/400 MHz HRDDS C/N Ratio Performance

Triple Conversion Receiver using Gain Distribution Optimization

In the FT DX 9000, a gain-optimized triple-conversion super-heterodyne receiver architecture is employed, utilizing IFs of 40 MHz, 455 kHz, and 30 kHz (FM 3rd IF: 24 kHz). Each stage is carefully filtered, and its gain balanced against the other IF stages' gains, to optimize net system performance. The system architecture does not require extraneous circuits for image rejection, resulting in an efficient design without unnecessary stages that can provide opportunities for performance degradation.

And the Dual Receive circuit architecture, from the RF stage through the AF stage and to the speaker, provides identical circuitry on both Main and Sub sides, so system performance is unchanged when listening to either receiver (μ-Tuning Modules in RF front end are on main receiver (VFO-A) only).

Front End Block Diagram (VFO-A/B, with Dual Receivers Installed)

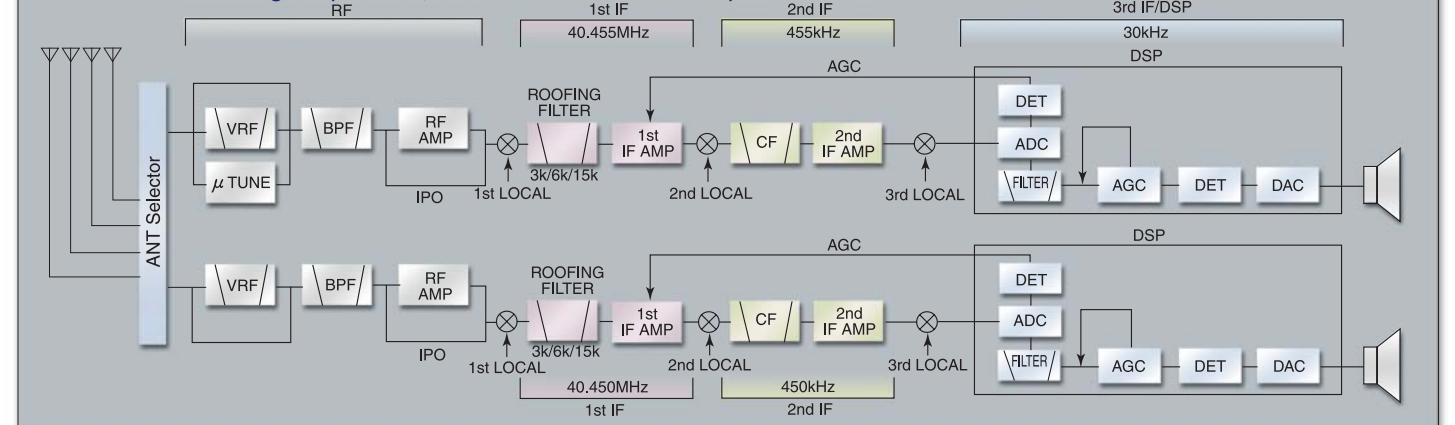

Ultra-Strong RF Front End

YAESU's outstanding RF-stage filtering system cuts off strong signals outside the RF filters' passbands. Then it is the important task of the RF amplifier and first mixer stages to have outstanding characteristics, so as to excel in performance as they confront the many close-in signals within the RF front-end filters.

The RF Amplifier stage consists of a pair of SST310 Junction FETs in a parallel push-pull configuration to provide low noise figure and excellent immunity to blocking and Intermodulation. For the 21 MHz and higher bands, push-pull configured 3SK131 FETs are used for optimal noise figure performance on these higher frequencies. Following the RF Amplifier is the 1st Mixer, crafted using four SST310s in a doubly-balanced configuration ideal for optimizing IMD rejection in a multi-signal environment. Gain distribution in the front end is carefully balanced, as are stage gains throughout the receiver. The power supply in the front end runs at 22 Volts, further enhancing strong-signal performance. And the 1st Mixer, being an active type, does not contribute loss to the signal path, so frequently there is no need to use the RF amplifier stage at all (IPO-Intercept Point Optimization mode), but rather provide direct feed to the 1st mixer, which improves intermodulation performance further.

For operation on the 50 MHz band, a lower Noise Figure is sometimes important, especially for owners in very quiet locations operating EME (Moonbounce) or other very-weak-signal modes. So for 50 MHz operation, Yaesu's engineers have designed a special low-noise GaAs FET RF Amplifier using push-pull SGM2016 devices, while the first mixer utilizes four 2SK520 Junction FETs to push the Noise Figure well below what is required during HF operation.



RX Unit (Showing the VRF and BPF Units)

First IF (40 MHz) 3 kHz Roofing Filter

In the 40 MHz 1st IF, three selectable roofing filters are provided, in bandwidths of 3 kHz, 6 kHz, and 15 kHz, to protect the following stages from strong signals that could degrade dynamic range in the first IF amplifier and subsequent stages. Each roofing filter consists of a four-pole fundamental-mode monolithic crystal filter array, the best technique evaluated in Yaesu's exhaustive testing process.

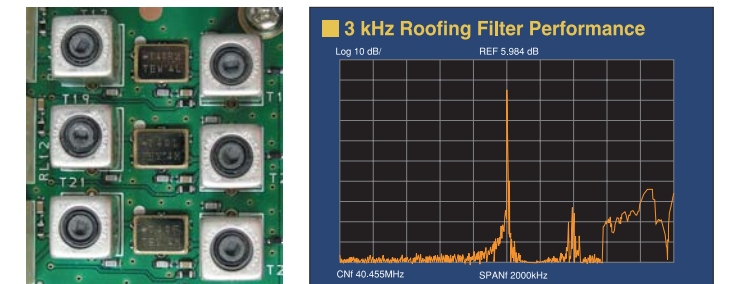

Three Selections of IF Roofing Filters 10 dB/Div · 200 kHz/Div

VRF (Variable RF Filter): Our Standard Preselector Filter Covers 1.8 ~ 50 MHz

The RF front end input circuit, consisting of the VRF (Variable RF Filter) and BPF (Bandpass filter) stages, is designed to protect the stages to follow (especially the RF amplifier and first mixer) from the effects of strong off-frequency signals. The VRF operates as an RF "preselector" with sufficient "Q" to be significantly narrower than the traditional BPF networks used for decades in solid-state receivers; as a result, much more interference suppression is afforded by the VRF circuit. The high Q is obtained, depending on the frequency of interest, by using large-diameter (T-80) toroidal inductors and air-core coils; a total of 31 relay-selected combinations of coils and capacitors are used to establish resonance around the operating frequency, and the VRF may also be optimally skewed to one side or the other of your operating frequency, in difficult cases of co-location interference inside the bandpass filter, by manually turning the VRF dial on the front panel. Following the VRF preselector stage, which operates an all Amateur bands from 160 through 6 meters, a fifteen-bank Bandpass Filter stage (8 networks for Amateur bands, 7 for general HF coverage) further extends the out-of-band protection, sending a thoroughly-filtered signal to the RF preamplifier. To switch these bandpass filters, 17 expensive surface-mount type relays are employed, guaranteed against surge voltage of 2500 V, providing immunity to contact degradation due to air pollution or humidity.

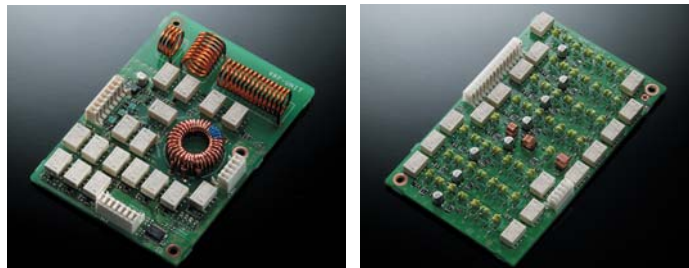

● VRF Unit

● BPF Unit

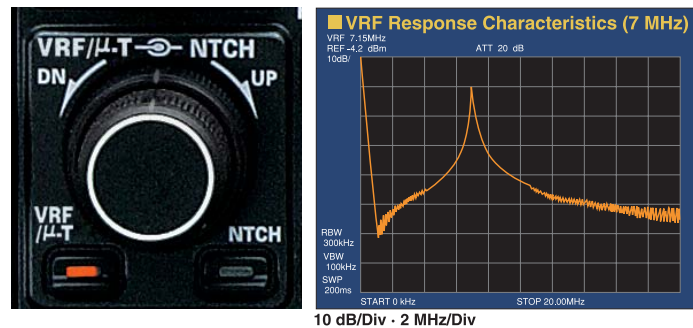

New Mu (μ) Narrow-bandwidth High-Q RF Filters Using Large-Diameter (28 mm) Coils: Helping Weak Signals Rise Out of the Interference and Noise!

Operation on the low bands, especially 1.8 MHz, frequently involves very strong signals from close-by broadcast stations, with signal voltages much greater than on the high bands due to NVIS propagation and large antenna size. Heretofore no RF filtering system in an Amateur Transceiver was fully equipped to cope with this challenge, but Yaesu's new "μ-Tuning" filter breaks new ground, providing ultra-high-Q RF preselection selectivity on the 14 MHz and lower Amateur bands. A total of three μ-Tuning filter modules are required for this band coverage (1.8 MHz, 3.5/7 MHz, and 10/14 MHz), and all three modules are installed on the FT DX 9000D version; on the other versions, they are available options.

When the front panel's "μ-T" switch is turned on, the VRF circuit is switched out of the receiver input line, and is replaced by the μ-Tune circuit, which provides much tighter RF selectivity thanks to the high Q (300 or more) afforded by the large 28 mm (1.1") diameter Ni-Zn ferrite magnet toroidal coil stack used in filter construction. As the toroid stack is passed through the coil structure, the center frequency is adjusted, and the resulting 3 dB bandwidth is approximately ±12 kHz on 1.8 MHz (-30 dB bandwidth ±450 kHz). Insertion of the μ-Tuning filter alone typically increases the IP3 by 4 dB.

The core stack is driven by a high-resolution hybrid stepping motor (4-phase, unipolar motor with 2-phase magnetization and 1.8° step resolution) which is connected to a long-life synchronized belt drive with an operational lifetime of over 10,000 hours. In order to cover the 1.8 MHz bands, the moving core stack is a whopping 2.2" (55 mm) long, and the resonance is controlled automatically by the microprocessor as you tune around the band. Manual override (±5 kHz during auto mode, or full manual tuning) is provided, allowing you to make very fine peaking adjustments in the peaking and/or interference suppression of the μ-Tune filter.

If you have turned the μ-Tune filter off, just switching it back on will automatically cause it to re-center itself on your operating frequency. On those bands on which you have μ-Tune filter modules installed, we recommend you always use this filter for its superior RF selectivity characteristics. If you have a special application involving wide TX/RX splits or want to adjust the μ-Tune filter yourself, the Menu system allows you to disable the μ-Tune filter, or engage fully manual control.

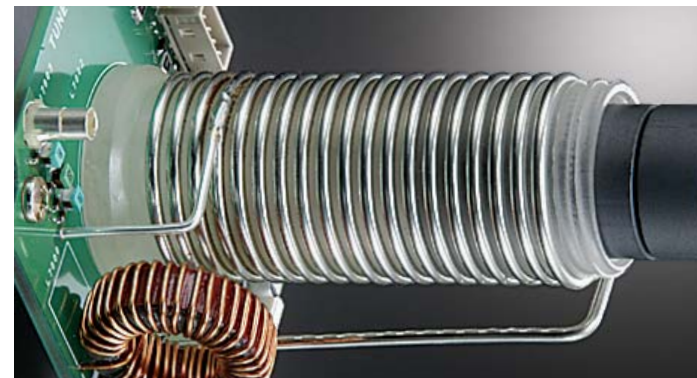

● Large-Area (1 1/2" x 28 mm) Coil (Actual Size)



● Long-life Synchronizing Drive Belt

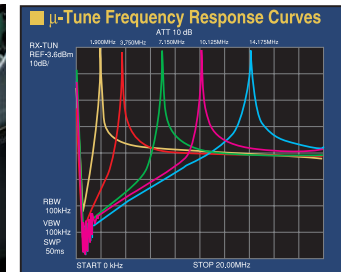

● RF μ-Tuning Unit Photo



● Three μ-Tune Modules Installed in FT DX 9000 Mainframe

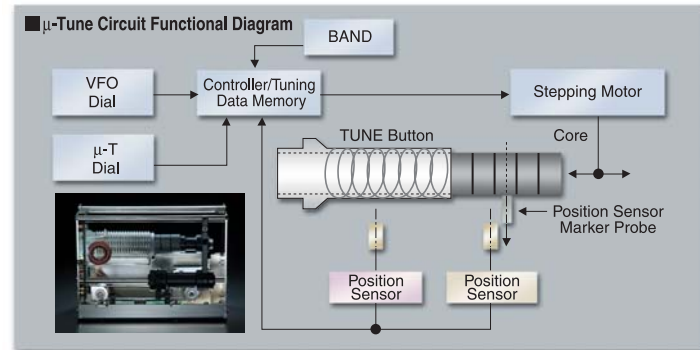

Enjoy the New World of YAESU 32-bit Floating-Point DSP, Crafted through Worldwide DXer Input for Uniquely High Performance and Operability

The new IF DSP system, utilizing a TI TMS320C6711 device, is a high-speed 32-bit floating point circuit designed with a unique objective: to do away with the "digital" sound of many DSP filtering systems, and emulate the "Analog Sound" so familiar and comfortable to HF DX and Contest operators. Special attention has been paid to AGC attack/release time design within the DSP, so as to enhance weak-signal reception on crowded bands. The result, after thousands of hours of testing, revision, and final evaluation, is a leading-edge receiver that has the "feel" of a traditional analog receiver, but with the flexibility and superb filtering capability of a modern digital filtering system.



● 32-Bit High-Speed Floating-Point DSP

Renowned Interference-Fighting WIDTH/SHIFT Controls: Now DSP-Based!

The IF DSP system brings the operator razor-sharp, precise adjustment capability of the dual filtering concept known traditionally as IF Shift and IF Width controls, only now these functions are generated in the DSP. These filter systems allow both the width of the IF passband, and the center frequency of the filter response, to be continuously adjusted; the result is the perfect passband response, without a complicated adjustment procedure. IF Shift may be adjusted ±1.0 kHz in 20 Hz steps, and precise bandwidth setting is facilitated by the large-diameter, concentric knobs on the front panel; one-touch "Narrow" presets may also be engaged, for quick reduction of bandwidth to a favorite value.

The IF bandwidth, at the center detent of the large (1.5"/39 mm) IF Width control, is set to 2.4 kHz for SSB, and 500 Hz for CW, RTTY, and PSK. Counter-clockwise rotation of the Width control will narrow the bandwidth further, to reduce interference, and for local hi-fi ragchews you can expand the SSB bandwidth out to 3000 Hz by rotating the Width control clockwise from the center detent. The current alignment of the IF Width and IF Shift controls is portrayed graphically on the TFT (D version) or LCD window (MP/Contest versions).

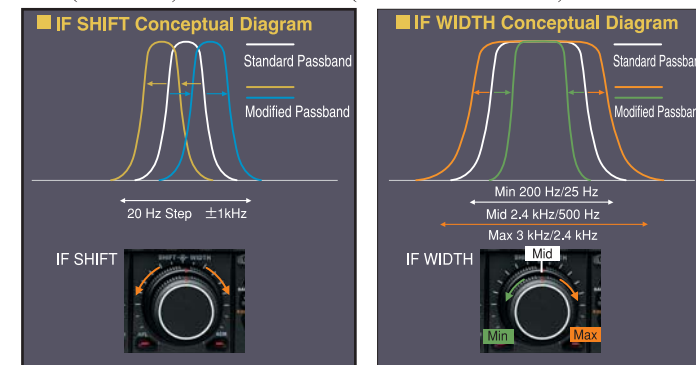

Preset NARROW Filter Selection

In addition to the continuously-adjustable bandwidth capability provided by the IF Width control, you may also set up one-touch, quick-switch "Narrow" bandwidths according to the operating mode. For SSB, the default Narrow bandwidth is 1.8 kHz, and you may select from 200/400/600/850/1100/1350/1500/1650/1800/1950/2100/2250 Hz as you prefer, and for CW/RTTY/PSK the default bandwidth is 300 Hz, and the available selections are 25/50/100/200/300/400 Hz.

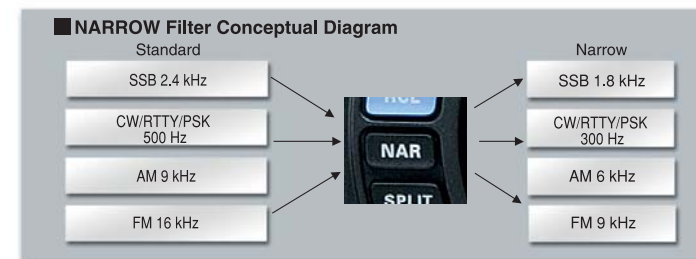

New-Design Analog-like DSP CONTOUR Passband Adjustment

One potential problem of DSP-based IF filtering is the tendency of the sharp shape factor of the filter to cause the incoming signal to have a peculiar, unnatural sound. Seeking to mitigate this effect, we have redesigned the "CONTOUR" control so as to allow the operator to modify the "shoulder" or "in-band" roll-off characteristics of the main IF passband, thus retaining a more natural sound to the signal while suppressing interference-bearing frequency segments dramatically. The attenuation level and width for Contour tuning may be adjusted using the Menu, and you may find that the CONTOUR control is more effective even than the WIDTH and SHIFT controls!

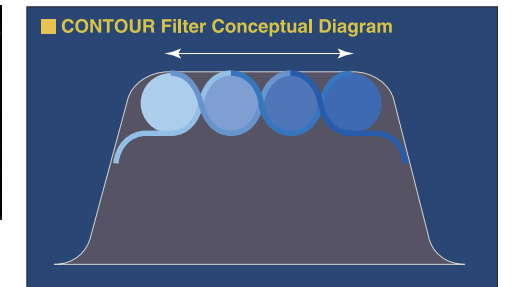

Interference-Fighting IF Notch and Ultra-Narrow Auto-Notch Beat Reduction Filter

The IF Notch circuit is a powerfully high-Q attenuation circuit that is very effective from removing interfering carriers from the receiver passband. Normally, this filter will be manually adjusted by the operator to notch out an offending signal, but when multiple interfering carriers are encountered, the Auto Notch filter may be engaged to null out all such beat tones within the IF passband. The powerful IF Notch is capable of up to 70 dB of attenuation, and the width of the notch may be adjusted, to as to minimize perturbation of the desired signal (narrow), or to increase the coverage of the notch action (wide) in the case of a broader interfering signal.

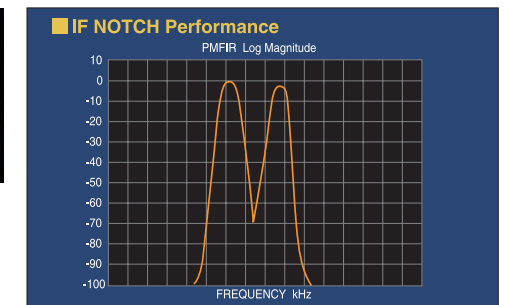

Digital Noise Reduction

Capable of reducing atmospheric and other noises using sixteen different unique, original mathematical algorithms, the DSP's Digital Noise Reduction circuitry is a powerful tool for enhancing signal-to-noise ratio on difficult paths. Different conditions may call for a different noise reduction parameter, and with the proper selection weak signals will literally jump out of the background noise, making copy much easier. And the FT DX 9000 accomplishes this task of noise reduction without imparting a strange "digital" sound to the desired signal, a problem in other competing designs.

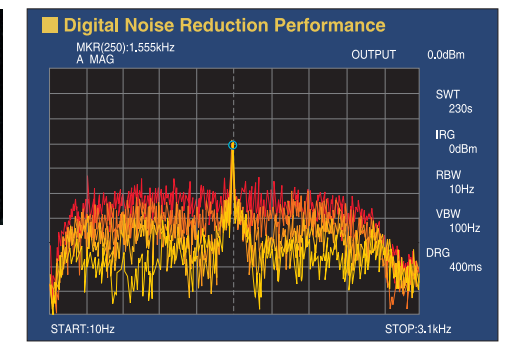

New Ultra-High-Stability Oven-Controlled Crystal Oscillator (OCXO)

Serving as the master reference oscillator for the transceiver, the 10 MHz OCXO is a large-area (50 x 50 mm/2" x 2") oscillator operating at high temperature, for ultra-high thermal stability for the oscillator components. The resulting frequency stability precision is truly amazing: it's rated at 0.03 ppm over the temperature range -10° to +60° C (-14° to +140° F). You can be proud to utilize the highest stability ever provided an Amateur rig.

OCXO Frequency Stability

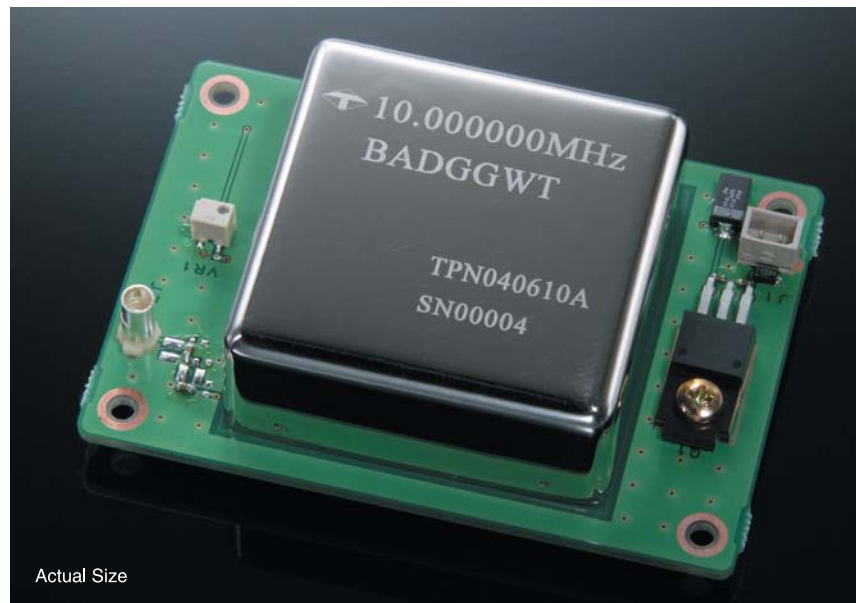
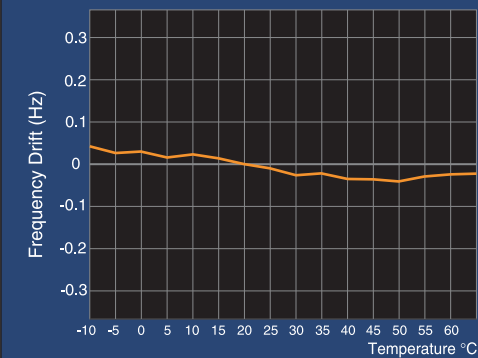

●2" x 2" (50 x 50 mm) OCXO Unit (Actual Size)

CW Mode "Adjacent Channel Monitor" (ACM) S-Meter function (Dual Receiver Versions)

During CW operation, the tight filters and low noise of the FT DX 9000 may make you unaware of the presence of a very close in, strong signal that may be causing interference to those who might call you. This is especially so during a contest, where signals may be tightly bunched. When using a version of the FT DX 9000 equipped for Dual Receive, you may solve this problem by engaging ACM, which utilizes the Sub Receiver to create a monitor function, using a 2.4 kHz bandwidth, displaying the presence of any signals within the 2.4 kHz bandwidth on the left-side S-meter. If nobody is responding to your CQ calls, you can look over to the left S-meter to see if there is someone over S9 right next to your frequency. . .and you can then hop to VFO-B to ask him to QSY!

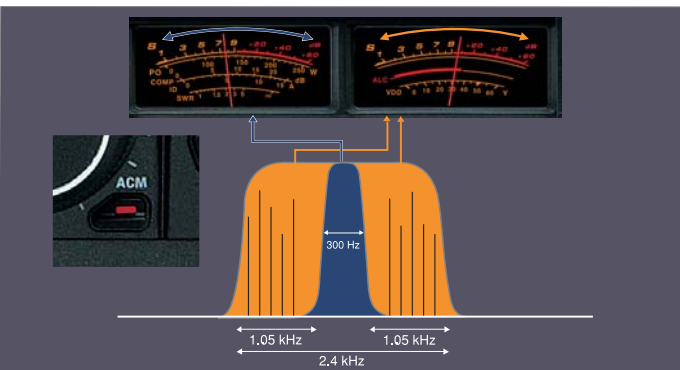

CW Zero Beat Indication



For effortless CW operation, the precise transmitting pitch, and matching sidetone (which reflects your CW pitch offset) may be adjusted from a dedicated knob on the front panel. Therefore, when tuning around the band, you simply press the SPOT button to match the pitch of the incoming station's signal to that of your CW sidetone, and you will be precisely aligned to the other station's frequency. We have also included a CQ tuning indicator, in which a marker will move toward the center position from the left or right, and the central LED will light up when precise alignment has been accomplished (without the need to engage the SPOT tone). And you still have indication of the Clarifier offset on the main display area, so you won't miss the switch from the "Analog Clarifier Display" to the "CW Tuning Indicator" display.

IF Noise Blanker

The IF Noise Blanker, crafted especially for reduction of impulse-type noise generated from ignition systems and power lines, may be engaged in addition to the Digital Noise Reduction. The precise time constant for removing the offending noise may be instantaneously optimized via a front panel control.

Receiver Audio Limiter (AFL) Feature

When hunting weak DX stations, you often have the AF Gain control turned up, especially when using a quiet receiver. Then, suddenly, a loud station may appear that startles you, and may even damage your hearing temporarily. The FT DX 9000 provides an AF Limiter (AFL) circuit which, once engaged, detects the strong signal and clamps an upper limit on the available audio output power, even before the AGC circuit engages its gain control in the RF and IF stages.



SLOPED AGC Feature

The AGC (Automatic Gain Control) circuitry for the receivers is designed to limit the gain through the RF and IF stages, so as to limit gain at a safe level in the interest of preventing distortion in and saturation of the amplifiers and mixers. And while generally the AGC's function is to provide a fixed audio output once a certain input signal voltage threshold is achieved, this is not always optimum for an environment containing both weak and very strong signals. So the YAESU design team have crafted a new Sloped AGC system that accommodates all levels of signals, and it results in S-meter readings that more faithfully reflect what your ear detects as the difference between signals of different strengths.

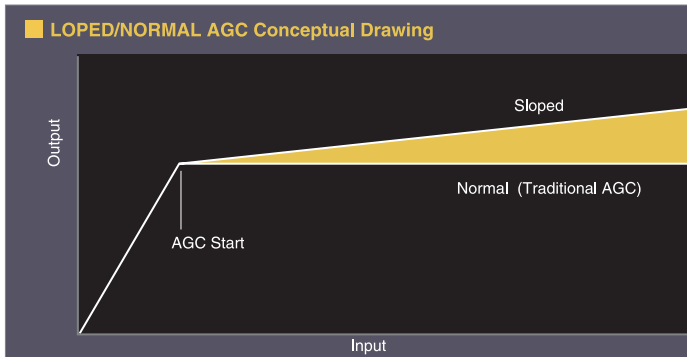

Systematic Modular Layout within Each Design Block Yields Superior Heat Dissipation

Long-duration aging was performed during the heat-dissipation design of the FT DX 9000, seeking to secure maximum durability and reliability of all components. One aspect of this design effort is a proprietary heat sink design that provides significant "headroom" for cooling of the DSP's IC and the display IC, and the overall shielding of the transceiver is utilized extensively to dissipate heat safely. The side panels of the FT DX 9000 are 3 mm aluminum bonded to other internal assemblies, providing an innovative self-cooling capability to this transceiver.



High-fidelity Dual Speaker System Built In!

Receiver audio quality is important to you, and we've made it a high priority on the FT DX 9000. That's why we created a unique speaker enclosure system optimized for enhancing audio quality from a transceiver, utilizing a pair of 3.6" (92 mm) speakers in a housing optimized for the dual-speaker design. The resulting 7.2" (184 mm) aperture creates a rich, wide-range tonal quality for the recovered audio. In addition, it is possible to separate the audio from the Main and Sub receivers, using switches to the side of the speakers and the Menu, to achieve the exact audio mixing capability you desire in your station (when shipped from the factory, the speakers are connected in parallel for the optimum audio response.)

Independent Power Switch and Circuit Breaker (D/Contest Versions)

The main power switch and rear-panel circuit breaker, helping to ensure high stability when you turn the transceiver on. By leaving the circuit breaker turned on, power is supplied to the OCXO (even if the transceiver main power is off); this keeps the reference oscillator stabilized at its operating temperature, and when you turn the transceiver itself on you'll not have to endure a "warm-up time" as the crystal oven reaches its specified operating temperature.



Utilizing First-Rate Parts with Superior Durability

In order to secure stable long-term high performance, expensive proprietary high-accuracy sealed-mold potentiometers (similar to those found in high-end audio gear) are used exclusively on the FT DX 9000 for the AF/RF Gain and SHIFT/WIDTH controls.

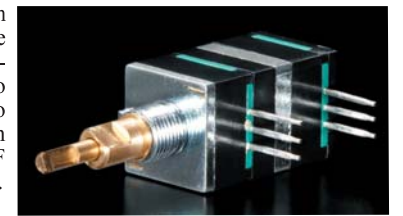

●Proprietary High-Accuracy Sealed-Mold Potentiometers

●To ensure stability of impedance over all frequencies, Teflon[®]-dielectric coaxial antenna connectors are employed on the rear panel of the FT DX 9000.



●Teflon[®] Coaxial Connectors

●The Data Management Unit, which utilizes its own high-speed VIA C3/667 MHz processor, is isolated, on the right edge, from the weak-signal areas of the transceiver. It's equipped with its own wide-area heat sink, and the combination of the effective shielding and lack of fan noise helps maintain the weak-signal capabilities of the receiver.

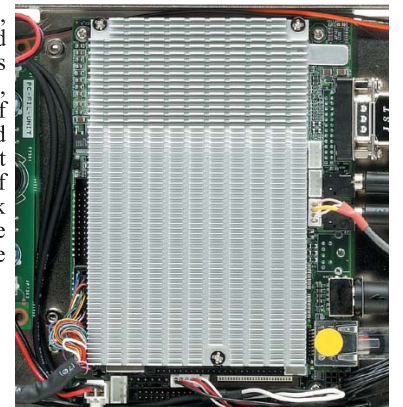

●The rear panel's RCA, 3.5 mm, and 6 mm connectors are all gold-plated, to ensure high reliability and low resistance, especially critical for maintaining integrity and low distortion in low-level audio circuits.

Top-End, but Practical, Operating Features

CW Functions

●Built-in Electronic Keyer, with Weight control, "Bug" setup option, and key plug connection inversion; speed is variable between 4 and 60 WPM. ●CW SPOT, using the sidetone pitch (400-1000 Hz) to zero in on incoming signals. ●Multiple-LED CW Zero-Beat Tuning Indicator. ●Two Key jacks (Contest version: 3) that may be configured both for paddle and computer-driven keying (simultaneously). ●CW Reverse, allowing you to tune using the opposite sideband for interference rejection. ●CW Delay (30 ms - 3 sec, analogous to VOX Delay on voice modes). ●Full CW Break-in. ●Multi-function contest message memory keyer with imbedded, incrementing serial numbers, utilizing supplied FH-2 Remote Control Keypad. Up to five 50-character (PARIS system) message memories are provided. ●Adjustable CW attack/decay times.

Receiver Functions

●Continuous coverage reception: 30 kHz - 60 MHz (specifications guaranteed only in Amateur bands). ●Selectable front-end attenuator (Off/3/6/12/18 dB). ●Four-stage AGC circuit, which can be configured (Off/Slow/Medium/Fast) independently on each operating mode.

Transmitter Functions

●VOX ●MOX ●Continuous RF power control. ●Operation on Alaska Emergency Frequency (5167.5 MHz) and 60-Meter band (U.S. version).

Miscellaneous Capabilities

●YAESU-exclusive one-touch LED/switches for Main-Sub TX and RX control. ●During Split operation, one-touch TXW (TX Watch) button lets you listen on

your transmit frequency. ●One-touch VFO switching (A>B, B>A, and A<>B) and Split mode setup. ●One touch VFO/Memory control (V/M, M>A, A>M). ●Dial Lock function. ●Function-based, easy-access menu mode. ●Versatile scanning functions. ●99 Memories (5 memory groups available) with Alpha-numeric labeling available. ●Five-channel QMB (Quick Memory Bank) one-touch memory bank which stores frequency and mode. ●Memory Offset Tuning (MT) offers VFO-like tuning off from a memorized frequency. ●Digital recording of incoming audio, activated by pushing the P.BACK button for 2 seconds, records the most-recent 30 seconds of receiver audio on a running basis; pressing P.BACK while recording changes indicator LED from Red to Orange and begins playback. ●Five-message (20 seconds each) digital voice memory for repetitive transmitted messages, using supplied FH-2 Keypad which also facilitates remote command functions. ●CAT (Computer-Aided Transceiver) command control via rear-panel RS-232C jack. ●Repeater Shift and 50 CTCSS Tones (Encode/Decode) for 29/50 MHz repeaters. ●FM "Narrow" mode. ●AM Wide/Narrow modes. ●Automatic Power-Off function can turn transceiver off after a user-defined time period of up to two hours.

Miscellaneous Capabilities

●The rear panel includes a convenient DATA terminal for interconnection to AFSK devices like TNCs and Sound Cards for operation on PSK31, RTTY, HF Packet, SSTV, and WSJT.

Open-Architecture Linux[®] Operating System

In adopting the Linux[®] operating system, we have created the opportunity for customized after-market development of capabilities like a custom TFT screen layout, etc.

The Ultimate in Signal Purity: Class-A Operation

We share your interest in the highest signal quality!

From start to finish, the FT DX 9000 design stresses SSB signal quality.

Your microphone audio is first passed through the YAESU-exclusive three-band Parametric Microphone Equalizer, allowing you to adjust audio quality more precisely than ever.

And the journey ends with the ultra-low-distortion Class-A final amplifier capability, which typically suppresses 3rd-order IMD better than 50 dB and 5th-order and higher responses by 70 dB or more!



Quality Transmit Audio

It's how your signal will be remembered.
So it won't do to be less than the best!

New-Design High-Power Final Amplifier

The 200-Watt PA section of the FT DX 9000 utilizes push-pull SD2931 devices in a conservative, high-stability design. The heat sink is a huge 2720 cc aluminum design, using a 3 mm copper plate with a high coefficient of thermal conductivity to spread heat effectively during continuous transmission, or Class-A operation. The thermostatically-controlled cooling fan is a 4-3/4" (120 mm) brushless design that cools the heat sink effectively and quietly, and at night the fan will turn at slow speed to minimize noise in your operating room. Heat sink temperature monitoring is provided in the TFT or in a front panel meter (depending on the version), so you can constantly observe the cooling performance of your transceiver and adjust your operating conditions appropriately. Sounds good!!



●200-Watt Version Utilizes Push-Pull SD2931 Devices



●Final Amplifier Temperature Display (MP/Contest Versions)



●200-Watt PA Unit

High-Speed Automatic Antenna Tuner

A comprehensive review of previous antenna tuner designs has resulted in the adoption of a new, high-speed design based on the use of stepper motors to provide high precision and quick recall of previous settings. A total of 100 antenna tuner data memories may be preserved, allowing hands-free return to a particular frequency where tuning data was stored. In the antenna tuning circuit, ultra-rugged relays, coils, and capacitors rated for operation at the 500-Watt level are employed, to ensure high reliability for many years.



●Automatic, High-Speed 500-Watt-Capable Antenna Tuner

FT DX 9000 Series

Ultra-Low-Distortion Class-A Final Amplifier for Best IMD Suppression on the Band!

Referring to the illustrations below, note the very low distortion obtainable with the FT DX 9000's Class A operating capability. In the FT DX 9000, you have front-panel control over the bias level applied to the final amplifier, affording continuous adjustment of the operating conditions, from Class A to Class AB! In the 400-Watt version, the power output becomes 100 Watts, and typical 3rd-order IMD drops to -50 dB, while 5th- and higher-order IMD drops below -70 dB! This means that, when exciting a linear amplifier, your linear is not amplifying all those distortion products along with the desired signal! On the 200-Watt versions, Class-A output is 75 Watts.

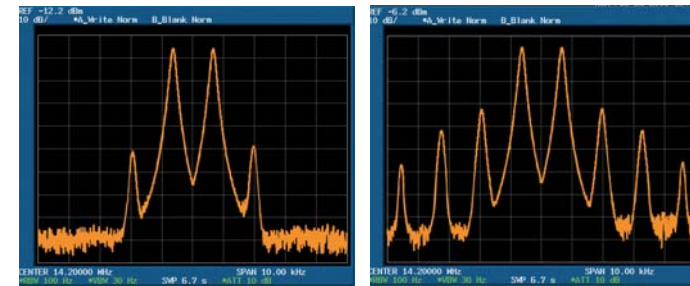

●Class A: Ultra-Low TX IMD (PO: 100W MP Version) ●Class AB: Typical IMD at 400W PEP Output

The unique capability to set the desired bias operating point, from Class A to AB, allows you to optimize the bias point-on the fly-to conform to the operating conditions you utilize, whether you're in a local, high-fidelity rag-chew or in the heat of battle in a contest, where Class AB will generate less heat in your operating room.



Professional-Grade Cannon (XLR) Microphone Connector

For audio professionals, a Cannon-type (XLR) balanced connector is provided on the front panel of the transceiver, affording easy connection to Heil Sound or other high-end microphone systems and processors. And if your microphone has a traditional 8-pin connector, a matching jack is provided on the rear panel of the transceiver.

●Cannon (XLR) Connector (w/48V Mic Power LED engaged)

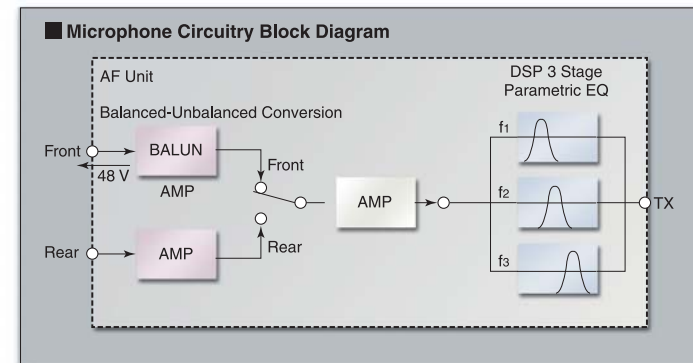

Skillfully-Conceived Microphone Circuit for First-Class Transmit Audio Quality

The microphone input circuit is a low-noise FET design, using a professional-grade Tamura TpAs-203 audio transformer to ensure high fidelity is preserved. Additionally, when using a professional high-fidelity condenser microphone requiring a 48-Volt supply, this voltage may be enabled on the front panel XLR connector by changing an internal jumper, and a LED on the front panel will light up to confirm that voltage is being supplied to the XLR connector.

Yaesu Exclusive: 3-Stage Parametric Equalizer Microphone Amplifier

Another design breakthrough on the FT DX 9000 Series is the incorporation of the industry's first three-band Parametric Equalizer Microphone Amplifier. The Parametric Equalizer, compared to simpler designs, allows very precise enhancements of three different ranges (bass, mid-range, and treble) of audio frequency response, providing unmatched ability for you to match your radio's response to your voice and microphone. The front and rear microphone inputs may be equalized independently, and the sparkling fidelity from your FT DX 9000 will make you the envy of everyone else on the band!

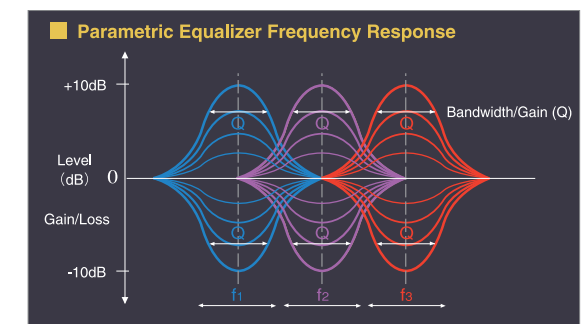

Renowned Speech Processor Design for that "Sunday Punch" in a Pile-up!

Seeking to provide a tool for increasing the average transmitter output power on SSB, we have incorporated a powerful IF DSP Speech Processor, crafted so as to increase intelligibility along with talk power. Whereas traditional speech processors frequently cause a significant increase in distortion to the point where the processing becomes counter-productive, the FT DX 9000 utilizes the power of the IF DSP, and leverages the capabilities of the Parametric Microphone Amplifier, to provide precise adjustment capability to yield that unique "Yaesu Punch" on those Sunday afternoon pile-ups-where DX stations will stop and say "Wow, OM, your audio sounds great!"

Transmitter Monitor Feature

The Transmitter Monitor may be utilized to monitor the output from the DSP, so as to verify changes in audio sound quality, compression level, and the results of Parametric Equalizer adjustments. The monitor level may be adjusted for maximum comfort using a dedicated knob on the front panel. In addition, versions equipped with the Data Management Unit can display, on the internal TFT or an external monitor, oscilloscope and other waveform patterns that can be especially helpful in making Speech Processor adjustments.

Full Duplex Operation

The FT DX 9000 includes a unique capability among HF transceivers: the ability to operate in a full duplex environment, whereby you can transmit on the main band (VFO-A) while simultaneously tuning around, on a different band, on the sub band (VFO-B). This affords the contest operator extra tuning time in search of new contacts and multipliers while calling CQ on the "run" band. This yields "SO2R" (Single Operator, Two Radio) operating capability while using only one transceiver!

Note: Full Duplex operation within the same band (e.g. both Main and Sub VFOs on 20 meters) is not possible.

Low-Level Transverter Output Jack

A convenient rear-panel RCA Transverter jack provides 10 mW of output, for use with VHF/UHF transmitting converter modules.

The radio... FT DX 9000



FT DX 9000 Contest 200 W Custom-Configurable Version

Two Pairs of Meters, plus LCD Window
VRF Input Preselector Filter
Three Key Jacks, and Dual Headphone Jacks
50 V/12 A Internal Switching Regulator Power Supply

The YAESU FT DX Series, born decades ago, soon grew through such best-sellers as the FT DX 401 to represent the very best in high-power DX-ready base stations, and the envy of those unfortunate few who didn't own one.

The return of the FT DX series brings back devastating output power, along with the most advanced features and specs, answering the calls for the ultimate DX base station.

Throughout the past 50 years, YAESU has poured know-how and passion into our leadership role in the development and perfection of HF SSB technology. This radio is born out of this tradition.

FT DX 9000D 200 W Version

Large TFT, Data Management Unit and Flash Memory Slot Built In,
Main/Sub Receiver VRF, plus Full Dual Receive Capability
Three μ -Tuning Modules for 160 - 20 M
50 V/12 A Internal Switching Regulator Power Supply



FT DX 9000MP 400 W Special Order Version

Two Pairs of Meters, plus LCD Window; Large TFT, Data Management Unit and Flash Memory Slot Built In
Main/Sub Receiver VRF, plus Full Dual Receive Capability
External 50 V/24 A Switching Regulator Power Supply and Speaker with Audio Filters



FT DX 9000MP 400W

Bold Dignity

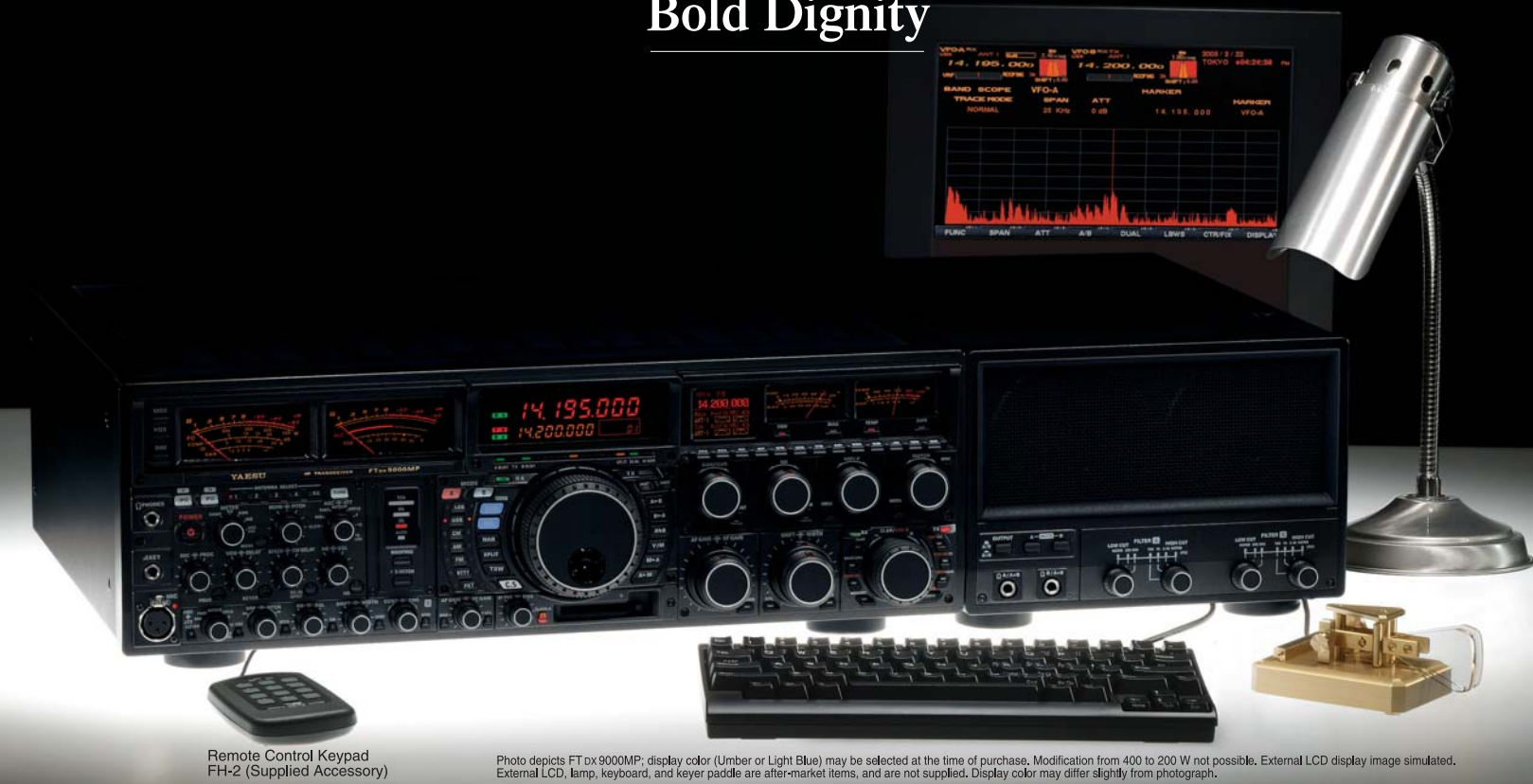

Remote Control Keypad FH-2 (Supplied Accessory)

Photo depicts FT DX 9000MP; display color (Umber or Light Blue) may be selected at the time of purchase. Modification from 400 to 200 W not possible. External LCD display image simulated. External LCD, lamp, keyboard, and key paddle are after-market items, and are not supplied. Display color may differ slightly from photograph.

The pinnacle of HF Transceiver performance has been reached in the 400-Watt FT DX 9000MP. You'll know that special feeling from the moment your fingertips touch the dial. . .

Stable, reliable power output from a PA module without peer. . .

The final amplifier stage of the FT DX 9000MP utilizes four SD2931 MOS FET devices in a parallel, push-pull configuration, running at 50 volts to obtain the highest power output in a production Amateur Radio transceiver today. Careful crafting of the bias circuit has resulted in low distortion and reliable performance over long hours of operation. The new heat sink design utilizes an aluminum base 130% larger than that of the 200-Watt versions, and thick copper fins with a high coefficient of thermal conductivity are employed in the cooling system, which has a total volume of 3580 cc. This huge heat sink assembly typically cools the transceiver through convection, but when the heat sink temperature reaches 167° F (75° C), a thermostat will engage the cooling fan automatically. The cooling fan is uniquely mounted to the chassis using a rubber pad that suppresses vibrations; this plus the low-RPM design afforded by the large bearing size means you'll have lower fan noise than you've ever experienced!

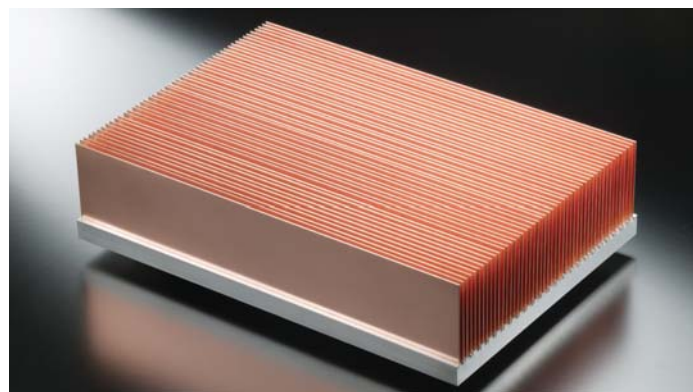

● Large-area Aluminum Heat Sink with Thick Copper Fins with High Coefficient of Thermal Conductivity



● 4 x 2SD2931 MOS FET Devices Produce 400 W of Output Power



● 400 W Final Amplifier

FT DX 9000MP

External Power Supply with Dual Speakers and Audio Filters

The FT DX 9000MP employs a rugged 50-Volt, 24-Amp Switching Regulator power supply, providing reduced heat and high stability over a wide range of input voltages. The power supply enclosure features two 4" (100 mm) speakers, affording independent audio paths for the Main and Sub VFO audio output; the left speaker puts out Main VFO audio, while the right speaker yields Sub VFO audio, and a front panel switch also allows you to combine the audio signals from both receivers for mixed distribution from the two combined speakers. This produces an effective aperture of 8" (200 mm), for outstanding tonal quality! The audio filters provide three steps of high-cut (2400/1000/700 Hz) and two steps of low-cut filtering (500/300 Hz), and each audio path (Main/Sub) may be filtered independently, allowing you to experiment with optimum settings in a "diversity" dual reception filtering mode. And we've included an independent Mute switch which is very convenient during dual receive.

Two headphone jacks are provided on the front panel of the speaker, allowing Main, Sub, or "mixed" audio to be monitored using your headphones.



● External Power Supply with Dual Speakers and Audio Filters FPS-9000H (50 V/24 A, included with MP version)

Using a Large External Display from a Personal Computer

When your transceiver has the Data Management Unit installed, but not the internal TFT, you may utilize a large after-market LCD or similar display, if you like, to display the information produced on the TFT. In this case, seven command keys below the meters on the right side may be used for control functions. The FT DX 9000MP has the data management unit installed at the factory.



(Display appearance may differ slightly from photograph.)

Function Keys used when using external display.

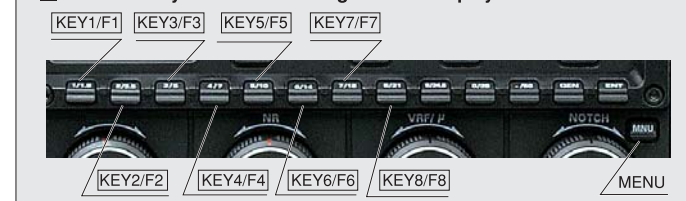

Customizing Optional Components

For all versions, you may select the display color at the time of ordering. Additional installation fee applies for installation of different color at later date.

● Light Blue Display option (Order via WDXC)



● Light Blue



● Umber Orange Display option (Order via WDXC)



● Umber Orange



● RF μ-Tuning Unit A MTU-160



160 M Band



● RF μ-Tuning Unit B MTU-80/40

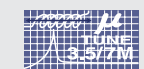

80/40 M Bands



● RF μ-Tuning Unit C MTU-30/20



30/20 M Bands



● TFT Display Unit TFT-9000



17"

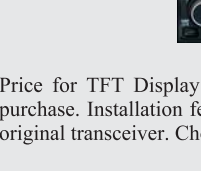

Price for TFT Display Unit may be higher if ordered after the time of purchase. Installation fee will apply if TFT is purchased after purchase of original transceiver. Check with WDXC for pricing.

FT DX 9000 Contest 200W

Be Creative. . .



Remote Control Keypad FH-2 (Supplied Accessory)

Photograph depicts FT DX 9000 Contest version with Umber display; Light Blue display also available at the time of purchase. Modification from 200- to 400-Watt version not available. Photo shows after-market keyer paddle, not supplied.

The joy of creating the most advanced equipment. . .
let it expand your spirit of exploration.

That's why, for contest and DX-pedition use, we've developed the FT DX 9000 Contest.

Extra Key and Headphone Jacks

In the FT DX 9000 Contest version, we have optimized the front panel for flexibility in single- or multi-operator station setups. An additional Key jack (for a total of three, two on the front panel) allows multiple keyer paddles to be connected, so two operators can respond to different calling stations. And an additional headphone jack makes it easy for a main operator and a logger to sit side-by-side and work a contest or DX-pedition pile-up at high rate!



VRF (Variable RF Filter) 1.8 - 50 MHz Preselector Module Built In

The VRF Preselector circuitry is much narrower than standard fixed bandpass filters, and it affords excellent rejection of out-of-band interference on the 1.8 - 50 MHz bands. The VRF's center frequency may be adjusted manually, if desired, from a dedicated knob on the front panel.

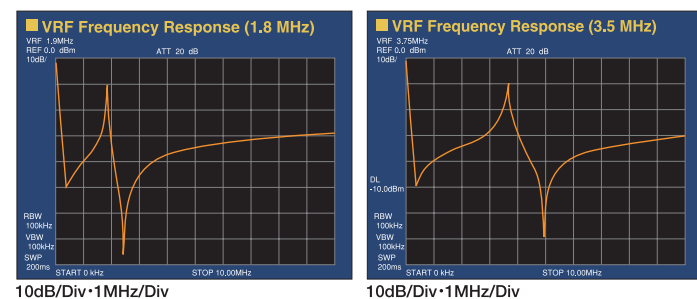

Customization

- For the Best in Low-Band Performance**
 FT DX 9000 Contest +
 - RF μ -Tuning A
 - MTU-160 (160 M Band)
- Enable Dual Reception for Full VFO-A/B Operation**
 FT DX 9000 Contest +
 - Dual Receive Module RXU-9000
 - Sub-Receiver VRF Unit VRF-9000
- Just Use One Receiver, but Enable the Spectrum Scope**
 FT DX 9000 Contest +
 - Data Management Unit DMU-9000
 - External Display (After-market item, not supplied) 800X600 SVGA
- On-Board TFT**
 FT DX 9000 Contest +
 - Data Management Unit DMU-9000
 - TFT Display Unit TFT-9000

FT DX 9000 Contest

Use Your Creativity to Build Your System. Your imagination evolves, and your station follows.

This radio respects your individuality.

Optimize your station according to your location's specialized capabilities, or according to your particular interests, such as Low Band DX, Contests, local rag-chewing, or DX-peditioning. And you can start up with a basic setup, then add modules and capabilities one by one as your interests expand.

Building up your station yourself. . . one of the true joys in Amateur Radio.

- * The Contest version can become the equivalent of the "D" version by installation of all options.
- * Selection of Umber or Light Blue display color is made at time of transceiver purchase.
- * Modification of display color at later date incurs a modification fee.
- * Installation of TFT Unit requires concurrent installation of Data Management Unit (DMU-9000).
- * Installation of TFT Unit after date of original transceiver purchase incurs a modification fee.

System Customization Diagrams

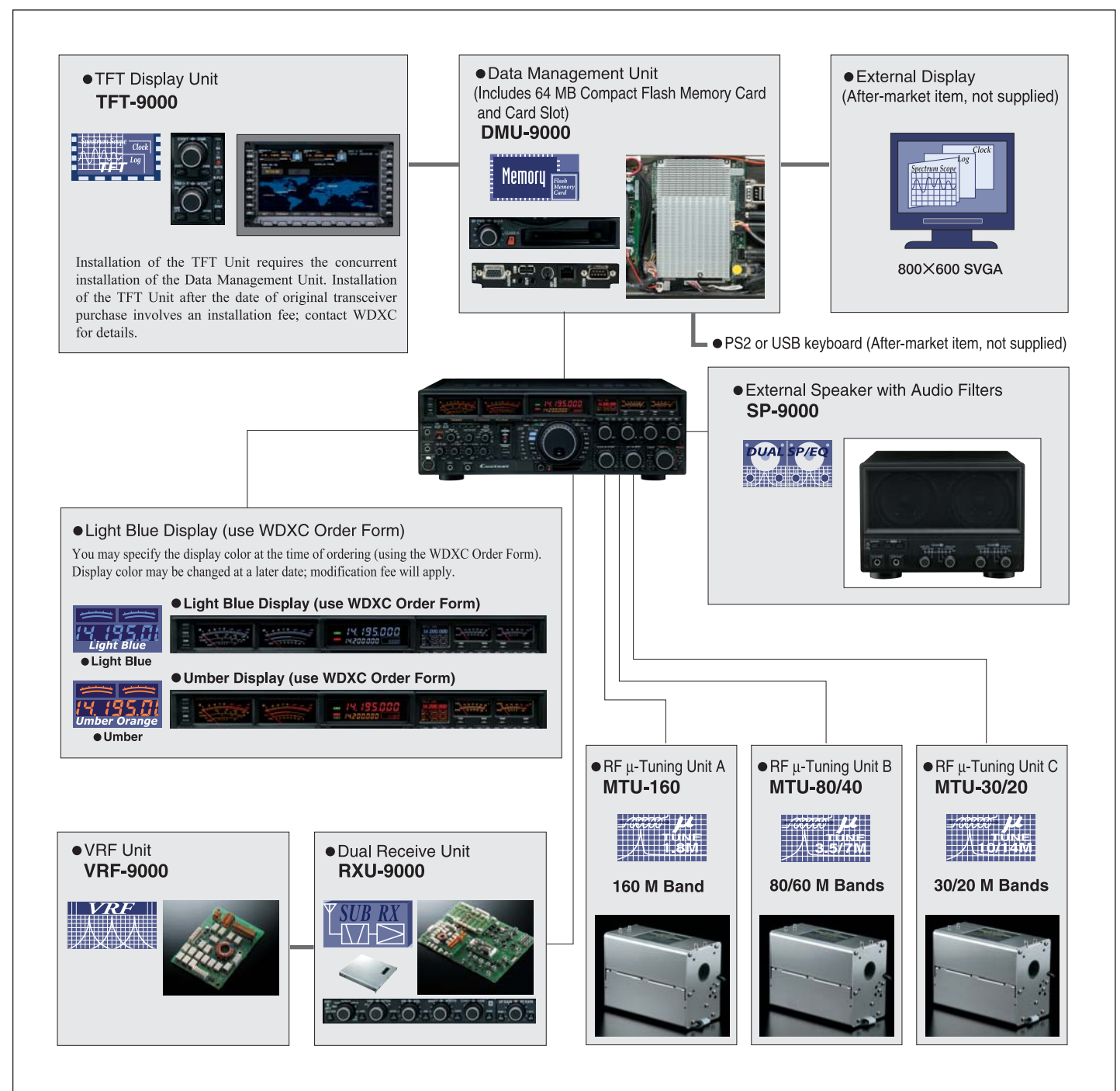

FT DX 9000D 200W

The Masterpiece



Photograph depicts FT DX 9000D version with Light Blue display; Umber display also available at the time of purchase. Modification from 200- to 400-Watt version not available. Display image simulated; actual appearance may differ. Photo shows aftermarket keyer paddle, keyboard, and lamp, not supplied with transceiver purchase.

Remote Control Keypad FH-2 (Supplied Accessory)

The Ultimate, "All Options Installed" Version. With three μ -Tune modules, for the pinnacle of receiver performance!

Three μ -Tuning Modules Factory Installed

The D version is equipped, at the factory, with all three μ -Tuning modules, covering the 160, 80/40, and 30/20 meter Amateur bands. These high-Q RF filters provided a degree of RF selectivity not found on any other Amateur transceiver, and they make FT DX 9000D operation a truly special experience.



Large, Easy-to-Read TFT Display

The wide-screen 6.5" TFT display is an 800 x 400 dot configuration, for high resolution; the FT DX 9000D is also configured with a rear-panel port allowing connection of an external display. Included in the available displays on the TFT are a World Clock, Spectrum Scope, Transceiver Status page with band-swept SWR indication, Audio Scope and Oscilloscope, Rotator Control page including a Great Circle Map, Memory channel List, and Menu List. With a number of customization possibilities, as well as a choice of up to five different illumination colors, the TFT display is both a functional and attractive centerpiece on your FT DX 9000D!

Log Book Feature

The Logbook feature allows you to connect your own keyboard to the read panel of the transceiver, and then utilize the onboard Logbook function for station record-keeping. Because date and time, as well as frequency and mode, are already maintained in the transceiver's memory, you only need to enter the other station's callsign and miscellaneous report information. The data is saved on the supplied CF card, and may be exported for use in other logging and bookkeeping software you may use in your station.



LBWS Panadapter, Dual RF Scope

The Dual Spectrum Scope function allows you to monitor activity on two different bands or within the same band. This allows you to choose the band with the most activity, least noise, etc., and it's a great way, for example, to watch for six-meter band openings while operating on HF at the same time! The LBWS (Limited Bandwidth Sweep) feature enhances the speed of the Spectrum Scope on band segments of high importance to you.



The Spectrum Scope's bandwidth (span) may be programmed, by the operator, to 25 kHz, 50 kHz, 100 kHz, 250 kHz, 500 kHz, 1 MHz, or 2.5 MHz, with the sweep speed remaining constant. Resolution is automatically programmed according to the span width: for 250 kHz and lower, the resolution is 1 kHz, while for wider spans the resolution is set to 6 kHz.



● SPAN: 25 kHz ● SPAN: 2.5 MHz

A unique innovation adopted in the FT DX 9000D's Spectrum Scope is the LBWS (Limited Band Width Sweep) feature, which allows you to engage a high-speed sweep of a particular segment (50%, 30%, or 10%)

of the full span. If you select 50% of the full bandwidth, the sweep speed is doubled; if you select 30%, the sweep speed is tripled, and at 10% the sweep speed is ten times faster! Once the bandwidth is set, you may use the \leftarrow \rightarrow keys to choose the area of the spectrum you want to sweep at high speed. LBWS is a great tool for making high-accuracy assessments of band occupancy, or in searching for stations making only brief transmissions.



● LBWS Display ● LBWS Features Variable Bandwidth and Center Frequency

Usually, a Spectrum Scope just follows your own operating frequency around. But on the FT DX 9000, you have the ability to define, band by band (via the Menu), what part of each band you particularly want to watch. For example, if you just want to watch the CW segment on 20 meters, you can limit the span so as to watch, for example, only 14.000 to 14.100 MHz. This lets you concentrate on the activity that's important to you!

Audio Scope/Oscilloscope Feature

Another useful function of the TFT is its Audio Scope/Oscilloscope page. These displays may be used to monitor signal quality when making speech processor or Parametric Equalizer adjustments, and the two displays allow different aspects of performance to be monitored. The oscilloscope uses the horizontal axis as the time base, while the audio scope uses the horizontal axis for the frequency domain.

What's more, on receive the audio scope may be used to evaluate the audio quality of the incoming signal, and it can be very useful in helping you select an optimum passband setting for the DSP, whether you're on SSB or CW. And for weak-signal work such as EME or PSK31, the Waterfall display allows you to visualize the position of the incoming signal relative to your radio's passband filters, allowing tuning and passband optimization so as to allow easy decoding by your computer's sound card.



● Spectrum Display ● Waterfall Display

Band-Swept SWR Indication

The SWR graph plots the SWR of your antenna system, as seen at the transceiver's Antenna jack, as you make transmissions across the band. This way, you can instantly spot anomalies that may indicate the need for antenna system repair.



Customizing Optional Components

You may specify the display color at the time of ordering (using the WDXC Order Form). Display color may be changed at a later date; modification fee will apply.



* TFT display images above are simulated; actual appearance may differ slightly.

World Clock Feature

An extremely useful tool on the TFT is the World Map page, which includes a handy Daylight/Darkness display including the Grey Line for spotting those interesting DX openings that follow the Terminator. Besides world time zone information, we have included an alarm function that you can set up with respect to a particular location, alerting you to when a particular time occurs in a faraway location. And we've included a 120-minute Off-Timer feature!



Memory Channel List

The Memory Channel List provides details of the 5-Group, 99-Channel memory system. The frequency, mode, and any programmed identification label will all be displayed, and since all the channels are listed, it is easy to look across them quickly so as to locate a particular memory channel of interest.



Great Circle Direction-Indicating Map

On the Rotator Control page, you may create a Great Circle map, centered on your location, to aid in visually determining the optimum beam heading for a particular station you want to work. Instead of the usual compass display, which is also available, the Great Circle map display actually shows where to align the rotation pointer, saving time and guesswork. When using the G-800/1000/2800DXA rotators, the FT DX 9000 may actually be used to control the direction setting, without using the normal controller box, and you may even program memories for important directions, so you can do one-touch rotation commands. Your location may be programmed using your keyboard, or you may connect a GPS unit that supplies standard NMEA0183 data to the COM port on the rear panel of the transceiver.



● Rotator Control Feature ● Antenna Bearing Indication using Great Circle Map

External Speaker with Audio Filters SP-9000



FT DX 9000 Rear Panel

Photo: D Version

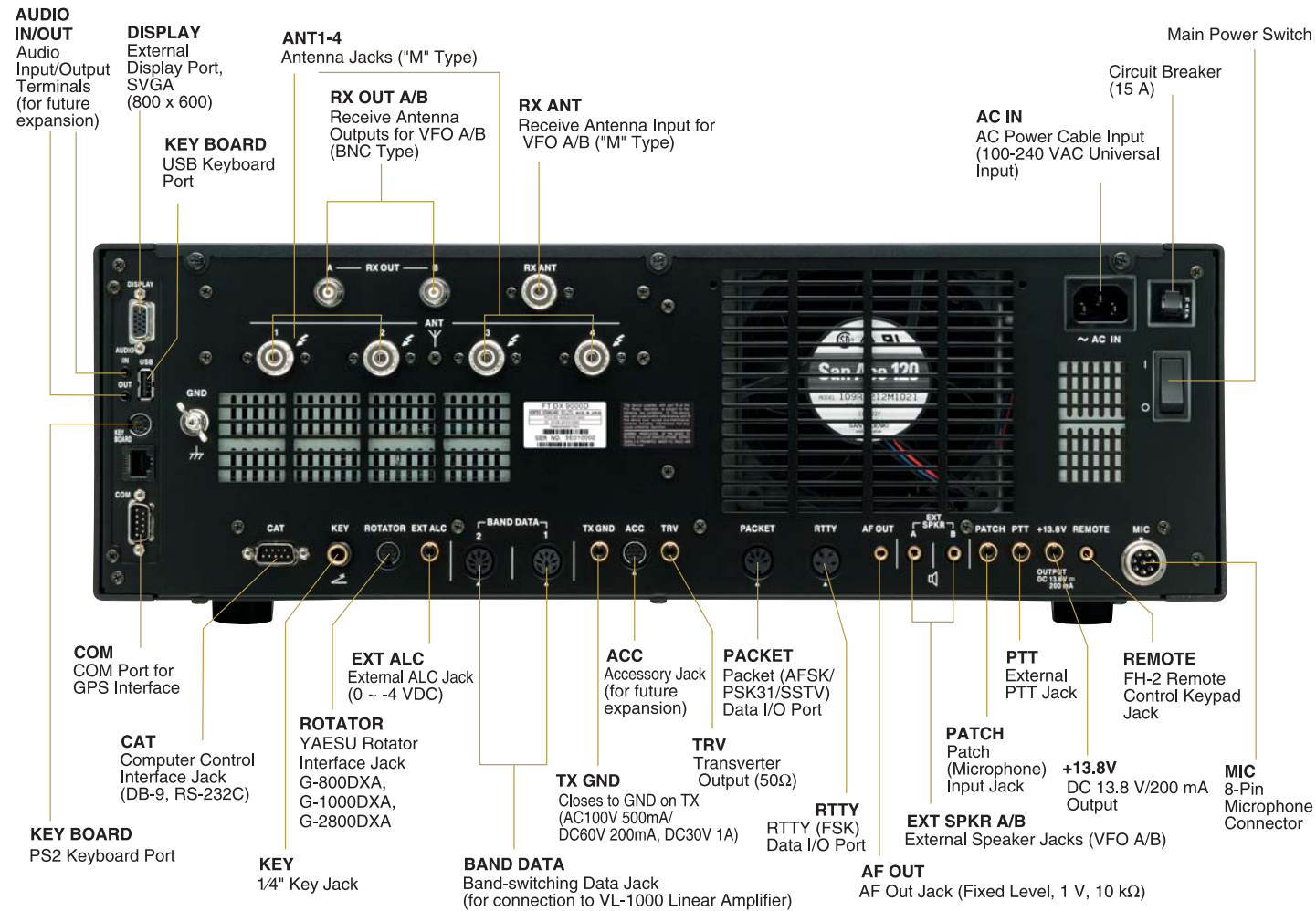

FH-2 Remote Control Keypad

(Supplied Accessory)



Supplied Accessories

- **FH-2 Remote Control Keypad**
Message Keyer, Audio Message Memory Command and Selection
- **64 MB CF Card (included with MP/D versions)**

For retention of Log Book text data
- **RCA Plugs (6 pcs.)**
- **1/4" Stereo Plugs (2 pcs.)**
- **3.5 mm Mono Plugs (2 pcs.)**
- **3.5 mm Stereo Plug (1 pc.)**
- **4-Pin DIN Plug (1 pc.)**
- **5-Pin DIN Plug (1 pc.)**
- **7-Pin DIN Plug (1 pc.)**
- **8-PIN DIN Plug (1 pc.)**
- **AC Cord (1 pc.)**
- **8 Pin ↔ Modular Mic Adapter Cable (for MD-200A8X, MD-100A8X, MH-31B8)**



■ **FT DX 9000MP Accessory FPS-9000H External Power Supply with Dual Speakers and Audio Filters (Output: 50 V/24 A)**

Size (WHD): 9.7"×6.5"×17.2" /246×165×438mm (w/o knob)

Optional Accessories

SP-9000 Dual Speaker System with Audio Filters

The SP-9000 enclosure features two 4" (100 mm) speakers, affording independent audio paths for the Main and Sub VFO audio output; the left speaker puts out Main VFO audio, while the right speaker yields Sub VFO audio, and a front panel switch also allows you to combine the audio signals from both receivers for mixed distribution to the two combined speakers. This produces an effective aperture of 8" (200 mm), for outstanding tonal quality! The audio filters provide three steps of high-cut (2400/1000/700 Hz) and two steps of low-cut filtering (500/300 Hz), and each audio path (Main/Sub) may be filtered independently, allowing you to experiment with optimum settings in a "diversity" dual reception filtering mode. And you also get individual mute switches, useful for dual receive operation.

Twin headphone jacks are provided on the front panel of the SP-9000, providing monitoring of both VFOs A and B.

Size (WHD): 9.7"×6.5"×17.2" /246×165×438mm (w/o knob)



For the MP version, similar capabilities are provided in the supplied Dual Speaker/Power Supply FPS-9000H.

Top View



Bottom View

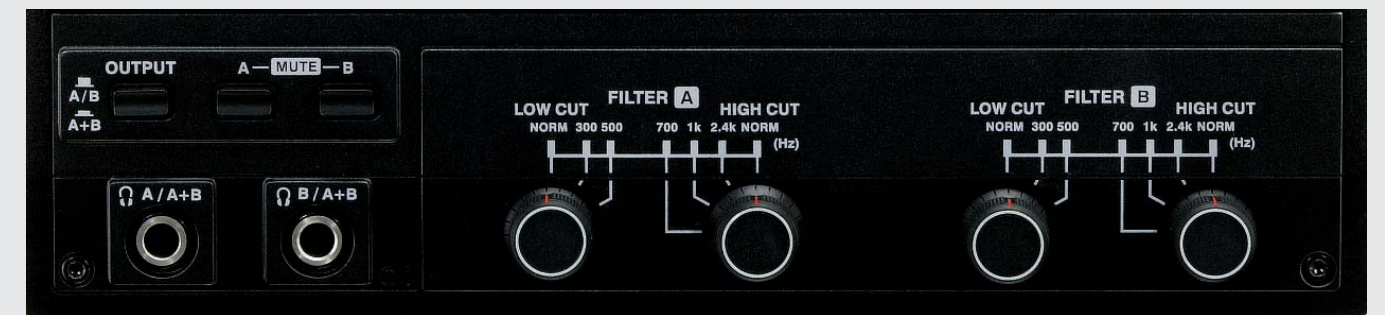

QUADRA SYSTEM

VL-1000 HF/50 MHz* 1 KW Linear Amplifier
VL-1000
Built-in Automatic Antenna Tuner
* U.S. Version: 24/28 MHz bands blocked

VP-1000 Matching Power Supply for VL-1000
VP-1000



Desktop Dynamic Microphone MD-200A8X



Hand Microphone MH-31B8



● MD-100A8X Desktop Microphone ● YH-77STA Stereo Headphones

FT dx 9000 Standard Equipment Chart

	FT dx 9000 Contest	FT dx 9000D	FT dx 9000MP (Special Order Version)
Transmitter Power Output	200 W		400 W
AC Input	Universal Input (100-240 VAC) without re-wiring		FPS-9000H AC Power Supply with Dual Speakers and Audio Filters
Appearance and Features	LCD + 2 Dual Meters, no Sub Receiver Main Receiver includes VRF	Large 6.5" TFT Display Main/Sub Receiver includes VRF	LCD + 2 Dual Meters, Main/Sub Receiver includes VRF
Dual Receive Unit (Sub Receiver) RXU-9000	Option	○	○
Sub Receiver RF Unit VRF-9000	Option	○	○
RF μ -Tuning Unit A (160 m Band) MTU-160	Option	○	Option
RF μ -Tuning Unit B (80/40 m Bands) MTU-80/40	Option	○	Option
RF μ -Tuning Unit C (30/20 m Bands) MTU-30/20	Option	○	Option
Data Management Unit DMU-9000	Option Allows interconnection of external LCD display (not supplied) when TFT Unit is not installed.	○	○
TFT Display Unit TFT-9000	Option (DMU-9000 required)	○	Option
Light Blue Display Color	please specify when ordering.	please specify when ordering.	please specify when ordering.

•Additional installation charges will apply if accessories are ordered after original purchase date for transceiver.

Specifications

General	Frequency Range		
Transmit	160 - 6 Meters (60 Meter Band /USA Version) (Amateur Bands Only)		
	5.1675 MHz (Alaska Emergency Frequency : USA Only)		
Receive	30 kHz - 60 MHz (Operating)		
	160 - 6 m (Amateur bands only)		
Emission Modes	A1A(CW),A3E(AM),J3E(LSB,USB),F3E(FM) F1B(RTTY),F1D(PACKET),F2D(PACKET)		
Synthesizer Steps(Min)	1Hz/10Hz(CW,SSB,AM),100Hz(FM)		
Antenna Impedance	50 Ohms, Unbalanced (Tuner OFF) 16.7 - 150 Ohms, unbalanced (Tuner ON, 160- 10 m, TX only) 25 - 100 Ohms, unbalanced (Tuner ON, 6 m, TX only)		
Operating Temperature Range	+14° F - +140° F (-10° C~+60° C)		
Frequency Stability	±0.03 ppm (+14° F - +140° F /-10° C~+60° C, after 5 min)		
Supply Voltage	100 VAC/200 VAC (Universal Input) 90 VAC~264 VAC		
Current Consumption (117 VAC Input)	RX(no signal) 100 VA (Approx.)		
	RX(signal present) 120 VA		
	TX MP-400 W 1500 VA (Approx.)		
	D/Contest-200 W 720 VA (Approx.)		
Case Size(WHD/ Approx.)	20.4"x 6.5"x 17.3" (518 x 165 x 438.5 mm)		
Weight (Approx.)	64 lb (29 kg) (MP- w/o Power supply)		
	66 lb (30 kg) (D)		
	53 lb (24 kg) (Contest)		
Transmitter	RF Power Output	MP	D/Contest
		CW/SSB/FM/RTTY/PKT AM Class A(SSB)	10-400 W 10-100 W 10-100 W
Modulation Types	J3E (SSB): Balanced		
	A3E (AM): Low-Level (Early Stage) F3E (FM): Variable Reactance		
FM Maximum Deviation	±5.0 kHz /±2.5 kHz		
Spurious Radiation	Better than -60 dB (160 - 10m Amateur bands) Better than -70 dB (6 Meter Band)		
SSB Carrier Suppression	At least 70 dB below peak output		
Undesired Sideband Suppression	At least 80 dB below peak output		
Audio Response (SSB)	Not more than -6 dB from 400 to 2600 Hz		
3rd-order IMD	MP -35dB(400W)/-50dB(Class A 100W)		
	D/Contest -35dB(200W)/-50dB(Class A 75W)		
Microphone Impedance	600 Ohms (200 to 10 k-Ohms)		

Receiver	Circuit Type	Triple-conversion superheterodyne	
Intermediate Frequencies	VFO-A: 40.455 MHz 455 kHz 30 kHz (24 kHz for FM), VFO-B: 40.450 MHz 450 kHz 30 kHz (24 kHz for FM)	SSB (2.4 kHz, 10 dB S+N/N)	
		0.2 μ V (160 - 10 m Amateur bands)	
		0.125 μ V (6 m Amateur band)	
		2 μ V (0.1 - 30 MHz)	
		AM (6 kHz, 10 dB S+N/N, 30 % MOD @400 Hz)	
		32 μ V (0.1 - 1.8 MHz)	
Sensitivity (IPO "off")	2 μ V (1.8 - 30 MHz) 1 μ V (6 m Amateur band) FM (12 dB SINAD) 0.5 μ V (10 m Amateur band) 0.35 μ V (6 m Amateur band)	Mode	-6 dB -66 dB
		CW/RTTY/PKT	0.5 kHz or better 750 Hz or less
		SSB	2.4 kHz or better 3.6 kHz or less
		AM	9 kHz or better 18 kHz or less
		FM	15 kHz or better 25 kHz or less
		Image Rejection	70 dB or better (160 - 10m Amateur bands)
Maximum Audio Output	2.5 W into 4 Ohms with 10% THD		
Audio Output Impedance	4 to 8 Ohms (4 Ohms: nominal)		

Specifications are subject to change, in the interest of technical improvement, without notice or obligation, and are guaranteed only within the amateur bands.

About this brochure: we have made this brochure as comprehensive and factual as possible. We reserve the right, however, to make changes at any time in equipment, optional accessories, specifications, model numbers, and availability. Precise frequency range may be different in some countries. Some accessories shown herein may not be available in some countries. Some information may have been updated since the time of printing; please check with your Authorized Yaesu Dealer for complete details.

 **VERTEX STANDARD CO., LTD.**
4-8-8 Nakameguro, Meguro-ku, Tokyo 153-8644, Japan

For the latest Yaesu news, visit us on the Internet:
<http://www.vxstd.com>

VERTEX STANDARD <http://www.vxstdusa.com>
Email: amateursales@vxstdusa.com

US Headquarters
10900 Walker Street, Cypress, CA 90630, U.S.A.
Phone 714/827-7600; Fax 714/827-8100

YAESU EUROPE B.V.
P.O. Box 75525, 1118 ZN Schiphol, The Netherlands

YAESU UK LTD. <http://www.yaesu.co.uk>
Email: sales@yaesu.co.uk
Unit 12, Sun Valley Business Park, Winnall Close
Winchester, Hampshire, SO23 0LB, U.K.

VERTEX STANDARD HK LTD. <http://www.vxstd.com.hk>
Unit 5, 20/F., Seaview Centre, 139-141 Hoi Bun Road,
Kwun Tong, Kowloon, Hong Kong