

INSTRUCTION MANUAL FR-101

Provided by
<http://www.yaesu-museum.com>

Downloaded by
Amateur Radio Directory

YAESU MUSEN CO., LTD.

TOKYO JAPAN

TABLE OF CONTENTS

GENERAL DESCRIPTION	Page 1
SPECIFICATIONS	Page 2
INSTALLATION	Page 3
CONTROLS AND SWITCHES	Page 4
OPERATION	Page 7
CIRCUIT DESCRIPTION	Page 15
ALIGNMENT	Page 19
RESISTANCE & VOLTAGE MEASUREMENTS	Page 27
PARTS LIST	Page 28

FR-101

COMMUNICATIONS RECEIVER



GENERAL DESCRIPTION

The model FR-101 is a solid-state communications receiver designed to provide extreme flexibility that even the most demanding amateur desires with provisions for all mode reception on twenty one 500 KHz amateur and major shortwave broadcast bands from 160 through 2 meters. The versatile FR-101 receiver is capable of transceive or independent receive and transmit function with the matching FL-101 transmitter or FT-101E/277E transceiver.

New, solid-state technology, with features such as a double-balanced mixer, offer unparalleled performance and rejection of cross-modulation and intermodulation interference. All circuits are composed of standard, computer type, plug-in modules, for reliable operation and service simplicity. A linear tuning, temperature compensated VFO with 1 KHz frequency readability is

incorporated. A 100 KHz/25 KHz crystal calibrator is built-in. The FR-101 also includes fast attack/slow release AGC for SSB or AM and fast release for CW. If desired, the AGC can be completely disabled. A built-in noise blanker with adjustable threshold control provides excellent elimination of most impulse type noise.

In addition to external VFO operation, a crystal oscillator is built-in for crystal-control operation of 4 channels of fixed frequency reception. The FR-101 includes a self-contained AC power supply - adjustable from 100/110/117/200/220/234 volt AC when the primary power transformer winding is appropriately wired.

The SP-101PB/277PB phone-patch and external speaker combination is a useful accessory for amateur operation.

SPECIFICATIONS

Frequency Range:

160m	1.8 ~ 2.0 MHz	
80	3.5 ~ 4.0	
60	4.5 ~ 5.0*	
40	7.0 ~ 7.5	
31	9.5 ~ 10.0*	
25	11.5 ~ 12.0*	
20	14.0 ~ 14.5	
19	15.0 ~ 15.5*	
16	17.5 ~ 18.0*	
15	21.0 ~ 21.5	
13	21.5 ~ 22.0*	
11	25.5 ~ 26.0*	
CB	27.0 ~ 27.5*	
10A	28.0 ~ 28.5	
10B	28.5 ~ 29.0	
10C	29.0 ~ 29.5*	
10D	29.5 ~ 29.9*	
VHF 6m	50.0 ~ 52.0*	52.0 ~ 54.0*
VHF 2m	144 ~ 146*	146 ~ 148*
☆1	4.0 ~ 4.5**	
☆2	5.0 ~ 5.2**	
☆3	7.5 ~ 9.0**	
☆4	22.0 ~ 27.0**	

Type of Emission:

USB, LSB, CW, AM, FM* or RTTY

Frequency Stability:

Within 100 Hz during any 30 minute period after warm-up. Not more than 100 Hz with 10% line voltage variation.

Calibration Accuracy:

1 KHz maximum after 100 KHz calibration.

Backlash:

Not more than 50 Hz.

Antenna Impedance:

50 ohm unbalanced nominal.

Power Requirement:

100/110/117/200/220/234 volt AC 50/60 Hz or 13.5 volt DC nominal.

Sensitivity:

SSB and CW...0.3 μ V for 10 dB Noise plus Signal to Noise Ratio on 14 MHz.

AM.....1 μ V on 14 MHz.

FM12 dB SINAD

Selectivity:

CW·N*0.6 KHz/6 dB, 1.5 KHz/60 dB

CW, SSB, RTTY, AM·N

.....2.4 KHz/6 dB, 4 KHz/60 dB

AM·W*.....6 KHz/6 dB, 12 KHz/50 dB

FM*.....20 KHz/6 dB, 45 KHz/50 dB

Harmonic & Other Spurious Response:

Image Rejection Better than 60 dB.

Internal Spurious Signal ... Below 1 μ V equivalent to antenna input.

Automatic Gain Control:

AGC threshold nominal 1 μ V.

Selectable AGC time constant, fast or slow.

Fast attack time 3 milli-second and slow attack time 4 milli-second. Fast release time 0.5 second and slow release time 2 seconds.

Audio Noise Level:

Not less than 40 dB below 1 watt.

Audio Output:

2 watts at 4 ohm impedance.

Audio Distortion:

Less than 10% at 2 watts output.

Dimensions:

340(W) x 153(H) x 285(D) mm.

Weight:

9 Kg.

*Options for FR-101 Standard Type Receiver.

**Options for FR-101 Standard and Deluxe Type Receives.

SEMICONDUCTORS

Silicon TR:

18 x 2SC372Y, 1 x 2SC710D, 6 x 2SC735Y

FET:

8 x 2SK19GR, 3 x 3SK35, 1 x 3SK40M

IC:

1 x AN214, 1 x TA7061AP, 2 x CA3053,

1 x MC1496G, 1 x MFC6034A

Diode:

2 x 1S2236, 1 x 1S2689, 5 x WZ090, 1 x WZ0109,

1 x 1S993, 6 x 1S1555, 14 x 1S1007,

4 x 1S188FM, 4 x V06B, 2 x TLR104

Provided by
<http://www.yaesu-museum.com>

Downloaded by
Amateur Radio Directory

INSTALLATION

GENERAL

Carefully remove the FR-101 receiver from the carton and examine it for any physical damage. Should any be apparent, notify the carrier immediately, stating the damage in detail. Save the carton and packing materials for future use.

LOCATION

In general, the location of the FR-101 is not critical, however it is recommended that excessively warm locations be avoided. The FR-101 should be placed in a location that has adequate space to permit free air circulation through the cabinet opening.

POWER REQUIREMENT

Two prewired plugs are furnished with the unit for AC or DC voltage operation. The FR-101 is supplied with a multi-voltage power transformer and can be operated in many areas of the world where voltages may differ from your local supply voltage. Therefore, before connecting the AC cord to the power outlet, be sure that the voltage marked on the rear of the receiver agrees with the local AC supply voltage.

CAUTION

PERMANENT DAMAGE WILL RESULT IF IMPROPER AC SUPPLY VOLTAGE IS APPLIED TO THE RECEIVER.

The FR-101 will operate satisfactorily from 12 volt, negative ground battery source by connecting the DC power cord to the rear panel receptacle. The receiver requires an average of 0.5 amp. When making connections to the battery, be certain that the RED lead is connected to the positive (+) and the BLACK lead to the negative (-) terminals of the battery. Reversed connection could permanently damage the receiver circuitry.

ANTENNA AND GROUND

The FR-101 is designed for use with a resonant antenna at the operating frequency and having an impedance of 50 to 75 ohms. This requirement is easily met by using a center-fed dipole antenna resonated to the receiving frequency and fed with coaxial cable. For amateur band operation, any commercially designed antenna system with an impedance of 50 to 75 ohms may be used.

If a tuned, open-wire transmission line or a long wire antenna is used, a suitable antenna tuner must be used between the receiver and antenna. For more detailed description on antennas, please refer to "The ARRL Antenna Hand Book" or "The Radio Amateur Hand Book".

It is recommended to use the transmitting antenna when the FR-101 is used with a transmitter or a transceiver. Antenna change-over is accomplished by an antenna relay provided in our transmitter or transceiver.

The FR-101 should be connected to a good ground. The ground lead should be connected to the terminal marked GND located on the rear panel of the receiver.

SPEAKER

A 4 ohm speaker should be connected to the jack on the rear of the chassis marked SP. One lead of the speaker output is grounded to the chassis so that the one lead of the speaker should be connected as illustrated in Figure 1. Our accessory speaker model SP-101B/277B or SP-101PB/277PB provides the correct impedance match and matches in appearance with the FR-101.

HEADPHONE (4 to 8 ohm impedance)

A headphone jack is provided on the front panel for the use of a high sensitivity headphone. When a low sensitivity headphone is used, the 100 ohm resistor, R11, should be shorted for adequate volume. (Ref. to Fig. 2)

MUTE

The MUTE jack on the rear of the chassis is wired so that the receiver will operate only when the inner-conductor of this jack is shorted to ground. When the FR-101 is operated separately, and external muting is not desired, the RCA plug with shorted inner and outer conductors should be inserted into the MUTE jack. The inner-conductor should, therefore, be connected to a relay contact in the transmitter, or the transceiver, which is normally open in transmit and grounded in receive. It is recommended that a shielded wire be used for the interconnection between the transmitter or transceiver.

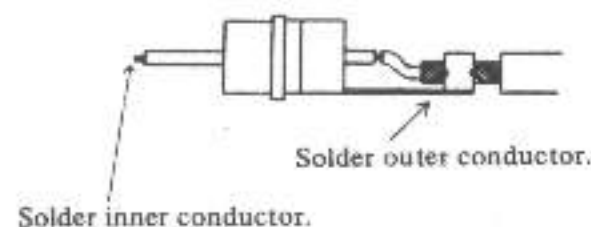

Fig. 1



Fig. 2

CONTROLS AND SWITCHES

The FR-101 has been specifically designed for ease of operation and versatility. All controls have been properly adjusted at the factory. Several panel controls and switches are unusual in operation, and improper adjustment may result in poor receiver performance. The

function of various controls and switches is described in the following section. Be certain that you understand thoroughly the individual function of each before operating the receiver.

FRONT PANEL

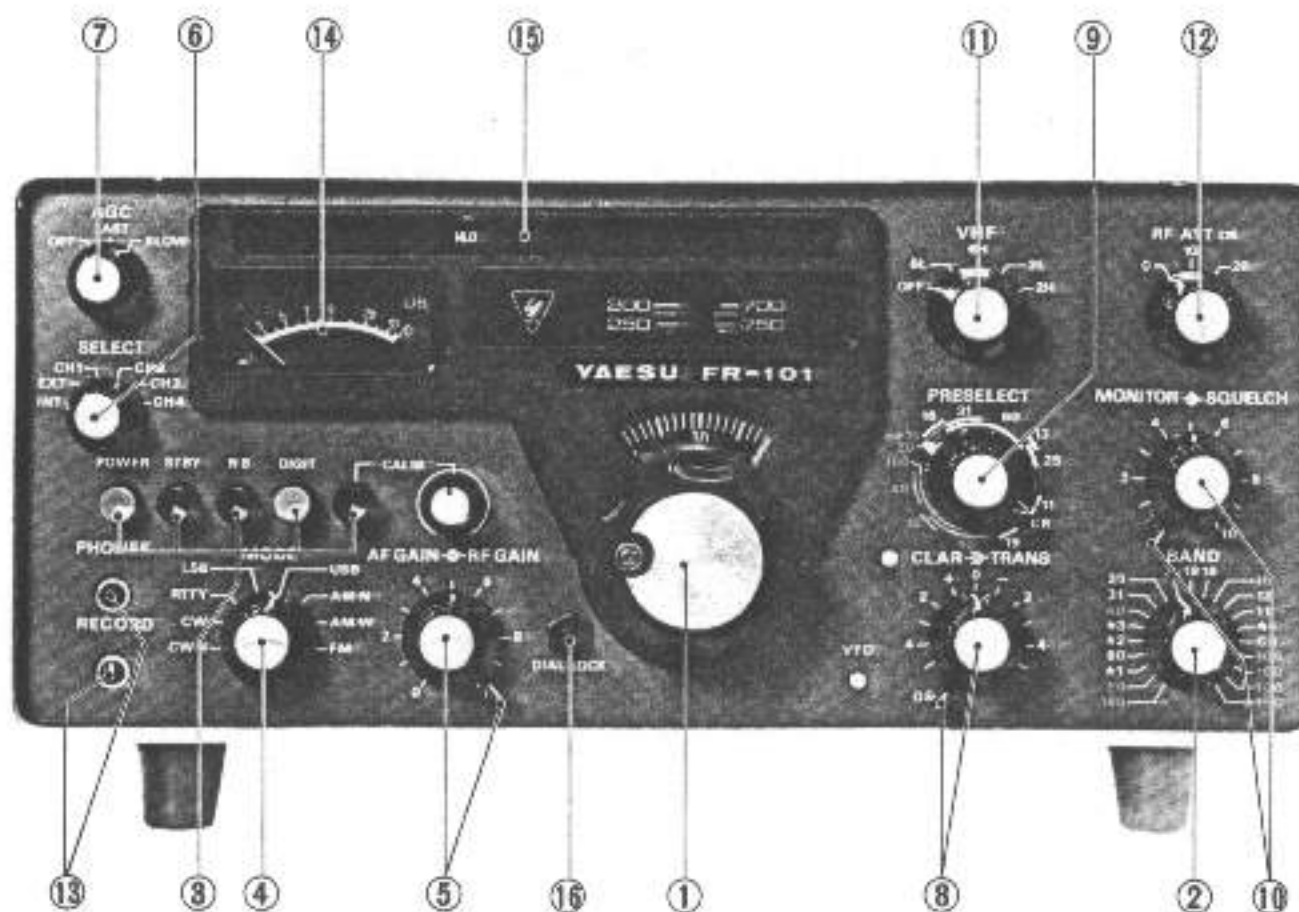

(1) MAIN TUNING

The MAIN TUNING knob determines the frequency which you are receiving.

(2) BAND

The BAND switch is a twenty one position switch. The tunable frequency range of each band is listed in the specifications on page 2.

(3) FUNCTION SWITCH

The FUNCTION switch consists of five push button switches: POWER, STBY, NB, DIGIT and CALIB.

POWER: When this switch is in the depressed position, the power transformer primary is connected to the power line for AC operation. A separate DC cable is provided for connection to a battery for DC operation.

STBY: With this switch in the depressed position, the receiver is muted.

NB: With this switch in the depressed position, the Noise Blanker is activated.

DIGIT: This switch is used on the digital readout receiver to turn off the last digit if the flicker is annoying.

CALIB: With this switch in the depressed position, the 100 KHz/25 KHz calibrator is switched on.

A control is used for the calibration of the digital model only.

(4) MODE

The MODE switch is an eight position switch which determines the appropriate detector and the filter in use. In the AM position, a diode detector is incorporated and the carrier oscillator is switched off. In the CW, RTTY, and SSB (USB & LSB) positions, a ring demodulator is used as a detector with the appropriate carrier oscillator turned on. In the FM position, an (optional) FM detector unit is switched in. The appropriate filter is also automatically selected by the MODE switch.

(5) AF-RF GAIN

The AF and RF GAIN control is a concentric double-shaft potentiometer. The inner knob controls the audio output level of the receiver and the outer lever knob controls the RF and IF gain of the receiver.

(6) SELECT

This switch provides the selection of an external VFO or one of four crystal-controlled oscillator positions. Normal operation of the FR-101 requires that the switch be placed in the "INT" (Internal) position. When the switch is in the "INT" position, a red lamp marked VFO is lighted.

(7) AGC

This switch selects the AGC time constant. In the SLOW position, the AGC time constant is 0.75 second and in the FAST position, it is approximately 0.025 second. In the OFF position, AGC voltage is not generated. The SLOW position is normally used with SSB and CW, and the FAST position is normally used for break-in CW and RTTY. The OFF position may be used on CW under difficult reception conditions in conjunction with the RF Gain control

(8) CLAR-TRANS

These controls use a concentric double-shaft potentiometer. The CLAR (Clarifier) control - the inner knob - provides a means of varying the receiver frequency a few KHz to either side of the transmitting frequency when the FR-101 is used as a companion receiver to the FL-101 or FT-101E/277E. Thus it is possible to set the pitch of the voice you are receiving to the most readable point without affecting your transmitting frequency. The CLAR control may be switched off and the receiver locked to the transmitting frequency by setting the CLAR control to the OFF position. Normally, you will want to keep the clarifier in the OFF position until the initial contact is made. The CLAR control may then be used to zero-in and correct any drift on the received signal. With the clarifier ON position, a red lamp is lighted.

The TRANS (Transceiver) control is used to coincide the receiving frequency with transmitting frequency when the FR-101 is used in conjunction with the FL-101 or

FT-101E/277E. Slowly advance the MONITOR knob of the FR-101 to monitor the transmitted signal, then adjust the TRANS control for the most natural voice quality while transmitting.

(9) PRESELECTOR

The PRESELECTOR control permeability-tunes the antenna and RF coils in the receiver front-end. The scale on this control is calibrated with the wave length markings showing the correct setting for various bands. This control has two pointers - red and white. The red pointer corresponds to red band markings and the white pointer to white band markings.

(10) MONITOR-SQUELCH

The MONITOR control is used to monitor the transmitted signal when the FR-101 is used in transceive with the FL-101 transmitter or FT-101E/277E transceiver. The SQUELCH control adjusts the receiver squelch threshold sensitivity in the FM reception mode (when the optional FM detector unit is installed).

(11) VHF

The VHF switch selects the (optional) 6 meter and 2 meter VHF convertors. In normal reception, this switch should be set to the HF position.

(12) RF ATT

The RF ATT (RF Attenuator) switch attenuates the incoming signal to prevent over-loading of the front-end when an extremely strong signal is present.

(13) PHONE-RECORD

PHONE and RECORD jacks are provided for private listening and recording when desired. The attenuator resistor, R11, is connected to the PHONE jack in order to use high sensitivity stereo headphones.

(14) S-METER

The S-METER indicates the relative signal strength of a received signal. It is calibrated in S-Units from S-1 to S-9 and in DB over S-9.

(15) BAND INDICATOR

The BAND INDICATOR automatically indicates the band in use when the BAND switch is set to the desired band.

(16) DIAL LOCK

The DIAL LOCK locks the dial for the dial calibration.

Provided by
<http://www.yaesu-museum.com>

Downloaded by
Amateur Radio Directory

REAR PANEL CONNECTIONS

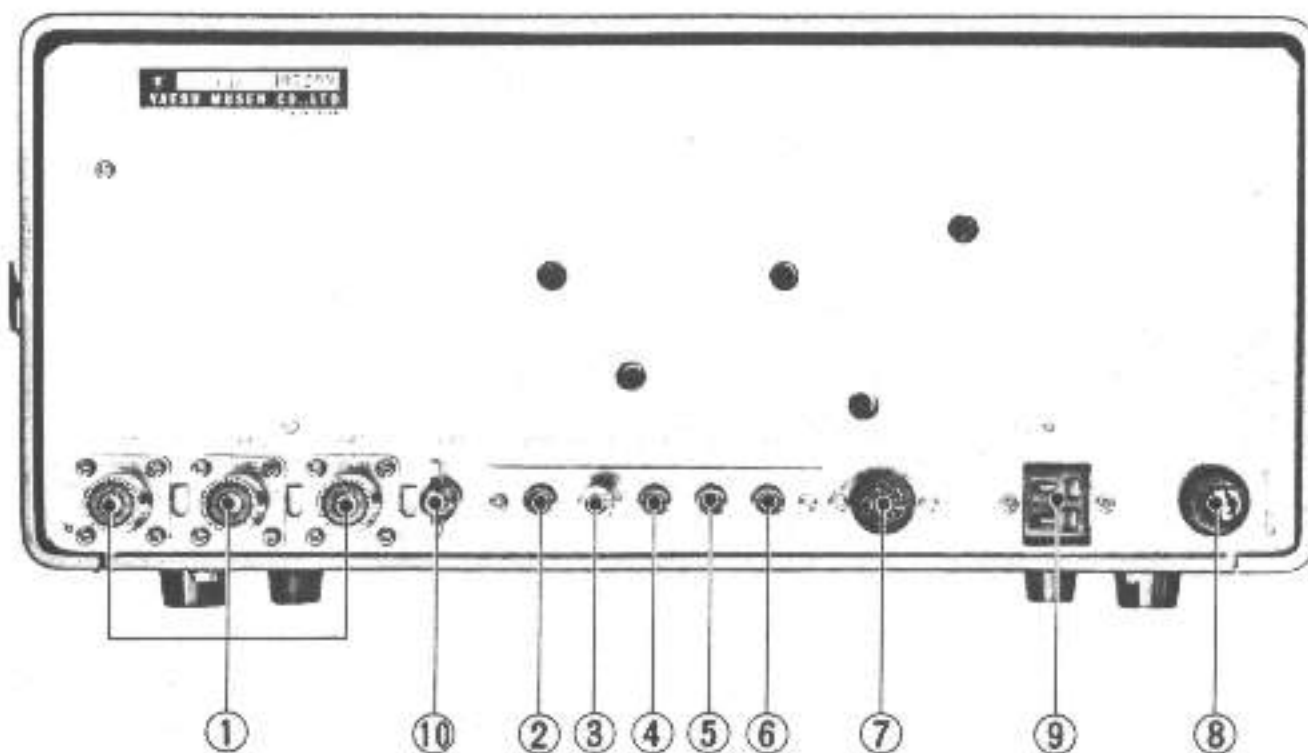

(1) ANTENNA CONNECTOR

Three coaxial connectors are provided for separate use on HF, 6 meter and 2 meter bands. The input impedance is approximately 50 ohms and an antenna having an impedance between 50 to 75 ohms should be used.

(2) AUX JACK

An AUXILIARY jack is provided for optional use and this jack is not wired internally.

(3) MUTE JACK

The MUTE jack is for externally muting the receiver. Shorting the center conductor to ground places the receiver in the receive mode and the FR-101 mutes when the center conductor is open from ground.

(4) TONE JACK

The TONE jack is for input of an external sidetone signal in CW operation.

(5) SP JACK

The SP jack is for a connection of 4 ohm speaker, such as our SP-101B/277B.

(6) A. TRIP

The receiver audio signal is brought out from the A. TRIP (Anti-Trip) jack for use in energizing the VOX circuit of a transmitter used with the FR-101, such as our FL-101 or FT-101E/277E.

(7) VFO

This socket is used for coupling the VFO signal of FR-101 to the FL-101 or FT-101E/277E, so that transceive operation may be obtained.

(8) FUSE

A 1 amp. fuse is used to protect the FR-101. For 220 volt operation, a 0.5 amp. fuse should be used.

(9) POWER

The POWER socket accepts AC or DC voltages. AC and DC cables are provided.

(10) GND

This is for a GROUND connection.

OPERATION

The receiving procedure of the FR-101 is not complicated, however care should be exercised when tuning to insure optimum performance of the equipment. The following paragraphs describe the procedures for the operation of the receiver.

INITIAL CHECK

Before connecting the FR-101 to a power source, carefully examine for any visible damage. Check that all modules and crystals are firmly in their sockets and that controls and switches are operating normally. Be sure that the voltage specification marked on the rear panel matches the supply voltage.

FREQUENCY SELECTION

The main tuning dial has two scales for proper frequency readout and is marked in 50 KHz increments to provide a coarse setting within a given band. The white scale is for 0 to 500 KHz and a green scale is for 500 KHz to 1 MHz. The sub-dial in window is marked in 1 KHz increments and provides accurate settings of the received frequency.

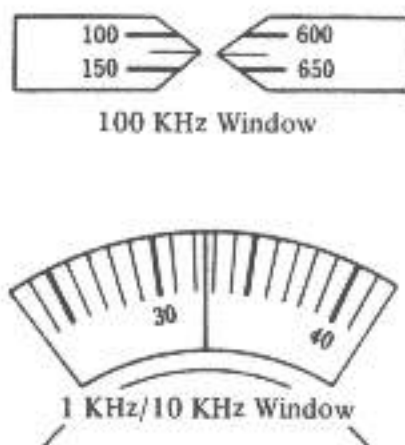

Fig. 3

The lower frequency limit of the main tuning dial is automatically illuminated in the top window of the dial escutcheon by setting the BAND switch. For example, when the BAND switch is set to 25 meter band, the top window shows 11.5 MHz as starting frequency. Therefore, the green scale is used for the frequency readout. The setting shown in the example, Figure 3, would then be 11,632.5 KHz, when the BAND switch is set to 25 meter band. When the BAND switch is set to 20 meter band, then the starting frequency is now 14.0 MHz. Therefore, the above setting would then be 14,132.5 KHz. The amateur bands are marked in red on the BAND switch. For VHF reception (with the optional convertors), the 10 meter bands are used as a variable IF stage. Refer to the Table 1 for the correct frequency readout.

BAND	HF (MHz)	6L (MHz)	6H (MHz)	2L (MHz)	2H (MHz)
10A	28.0	50.0	52.0	144.0	146.0
	28.5	50.5	52.5	144.5	146.5
10B	28.5	50.5	52.5	144.5	146.5
	29.0	51.0	53.0	145.0	147.0
10C	29.0	51.0	53.0	145.0	147.0
	29.5	51.5	53.5	145.5	147.5
10D	29.5	51.5	53.5	145.5	147.5
	30.0	52.0	54.0	146.0	148.0

Table 1

PRELIMINARY CONTROL SETTING

For all modes of operation, set the controls as follows:

POWER	OFF (push out position)
AGC	SLOW (push out position)
SELECT	INT
STBY	OFF (push out position)
NB	OFF (push out position)
DIGIT	OFF (push out position)
CALIB	OFF (push out position)
MODE	Desired mode
AF GAIN	Comfortable listening level
RF GAIN	Fully clockwise
VHF	HF
RF ATT	0
MONITOR	Fully counter-clockwise
SQUELCH	Fully counter-clockwise
CLAR	OFF
TRANS	Fully counter-clockwise
BAND	Desired band
PRESELECT	Set the band mark and peak for maximum S-meter reading.

Push in the POWER switch and tune the main tuning dial for the desired signal and peak the PRESELECTOR for a maximum S-meter reading. The bandwidth of the receiver is automatically selected by the setting of the MODE switch as listed in Table 2.

If impulse type noise is experienced, push in the NB (Noise Blanker) switch. The noise blanker is an IF device which turns off the signal pass during a noise pulse. It is equally effective on all modes except the FM mode, however it will be noticed that the noise blanker works when the noise is greater than the desired signal. Due to the effect of the AGC in holding the audio output constant the noise may not appear to decrease, but a signal down in the noise will come up. It should be noted that the noise blanker functions best on noise pulses which are very short in duration and which are separated widely in time such as automobile ignition noise. For continuous noise, such as power line static,

the noise blanker will be less effective since the blanker circuit has difficulty in distinguishing the noise from the desired signal.

For VHF reception, set the VHF switch to the desired band, either 6 or 2 meters. Set the BAND switch to the 10 meter band and peak the PRESELECTOR for maximum S-meter reading. The frequency relation is listed in Table 1. When the (optional) FM unit is installed, advance the SQUELCH control slowly until the back-ground noise disappears with no signal input.

MODE	BANDWIDTH	
	CW·N *	0.6 kHz/6 dB
CW RTTY** LSB USB AM·N	2.4 kHz/6 dB	4.0 kHz/60 dB
AM·W *	6 kHz/6 dB	12 kHz/50 dB
FM *	20 kHz/6 dB	45 kHz/50 dB

*With optional filter for FR-101 Standard type receiver

**With optional filter for FR-101 Standard and Deluxe type receivers.

Table 2

DIAL CALIBRATION

The calibration of the main tuning dial may vary slightly from band to band due to the tolerance limits of the heterodyne crystals. Therefore, a dial calibration knob is provided on the front panel. To set the calibration on a given band and desired mode, proceed as follows:

1. Set the BAND switch and the PRESELECTOR to the desired band.
2. Set the CLAR switch to OFF position.
3. Push the CALIB switch in. A switch is located on the top of AF unit inside the cabinet that selects either the 25 KHz or 100 KHz calibrate signals. When the switch is set in the direction of front panel, a calibrate signal may be heard at 25 KHz intervals.
4. Set the 100 KHz dial in the window to the nearest 100 KHz or 25 KHz reading, then zero beat the main tuning dial against marker signal while pressing the DIAL LOCK. For AM or FM, the beat tone can not be heard. Therefore, the calibration should be made for maximum S-meter reading. Since the AM and FM filters have a wide bandwidth, the calibration should be made at the center of the passband as illustrated in Figure 4.

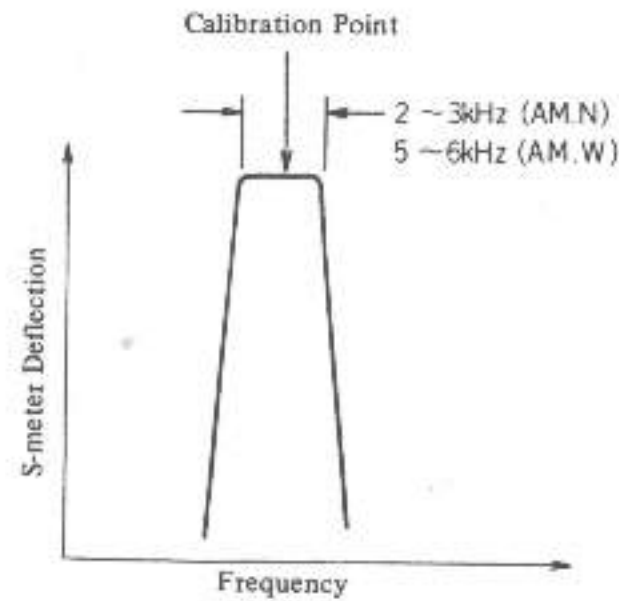

Fig. 4

CRYSTAL-CONTROLLED SPOT RECEPTION

The FR-101 provides for spot frequency reception with a crystal-controlled oscillator utilized in the place of the main tuning VFO. The crystal holders accept standard HC-25/U type crystals. All crystal frequencies must fall between 8,700 to 9,200 KHz. A trimmer capacitor has been connected to each crystal for precise frequency adjustment and its adjustment range is approximately 1 KHz. The correct crystal frequency for any desired operating frequency within the band set by the BAND switch, may be determined as follows:

$$F \text{ crystal} = f_1 - Fx$$

Where f_1 is taken from Table 3; Fx is the last 3 figures of operating frequency from which Mega-Hertz order is disregarded. When the last 3 figures are between 500 to 999 KHz, 500 KHz is subtracted from this value.

- Example 1—Find the crystal frequency for 7099 KHz in LSB mode.

From the Table 3, f_1 is 9201.5 KHz.

Therefore, $F \text{ crystal}$ is $9201.5 - 99 = 9102.5 \text{ KHz}$.

- Example 2—Find 11.750 MHz AM reception.

From the Table 3, f_1 is 9200 KHz.

Therefore, $F \text{ crystal}$ is $9200 - (750 - 500) = 8950 \text{ KHz}$.

MODE	f_1 (KHz)
AM, FM	9200.0
LSB	9201.5
USB	9198.5
CW	9199.3

Table 3

AUXILIARY BAND RECEPTION

In addition to the amateur and major shortwave broadcast bands, the FR-101 may be programmed to receive four 500 KHz-wide ranges covered in Table 4.

The crystals can be ordered direct from your dealer. When ordering, be sure to specify that the crystals you desire are for auxiliary band use in the FR-101.

The PRESELECTOR tuning range is given in Figure 5. On ☆1, ☆2 and ☆4 position, the FR-101 will work properly by only inserting the crystals, however on ☆3 position, TC22 must be adjusted as follows:

1. Insert the crystal in ☆3 socket.
2. Set the BAND switch to ☆3 position.
3. Push the CALIB switch on and tune the FR-101 to

the calibrator signal.

4. Peak the PRESELECTOR.
5. Adjust TC22 for maximum S-meter reading.

Insert the crystal of the correct frequency given in the Table 4 to the corresponding crystal socket located on the right side of the chassis. The crystal socket accepts standard HC-25/U type crystals. In order to receive the desired band, the BAND switch must be set to the number corresponding to the crystal socket in which the auxiliary crystal in use is installed.

A fundamental frequency is used when the crystal frequency is lower than 28 MHz and the second harmonic when higher than 28 MHz. It should be noted that the bands covered in Table 4 work only when the appropriate auxiliary bands are used as listed in the Table.

AUX	FREQ (MHz)	LOCAL OSC		RF AMP		MIX T103
		XTAL (MHz)	TRIMMER	T101	T102	
☆1	4.0~4.5	10.02	TC25 + C38	T107 + C4	T108 + C7	T109 + C20
☆2	5.0~5.2	11.02	TC24 + C37	T107 + TC1 + C9	T108 + TC2 + C11	T109 + TC11 + C22
☆3	7.5~8.0	13.52	TC22 + 50P	TC3 + C12	TC4 + C14	TC11 + C23
	8.0~8.5	14.02	"	"	"	"
	8.5~9.0	14.52	"	"	"	"
☆4	22.0~22.5	28.02	C44	TC9	TC10	TC15
	22.5~23.0	28.52	"	"	"	"
	23.0~23.5	29.02	"	"	"	"
	23.5~24.0	29.52	"	"	"	"
	24.0~24.5	30.02	"	"	"	"
	24.5~25.0	30.52	"	"	"	"
	25.0~25.5	31.02	"	"	"	"
	26.0~26.5	32.02	"	"	"	"
	26.5~27.0	32.52	"	"	"	"
27.5~28.0	33.52	"	"	"	"	

Table 4 AUX BAND

The band not covered by Table 4 may be programmed by using the band which is already assigned to another band. The relations between the desired new band and existing band are listed in Table 5.

○ Example—Desired Band: 10.5 - 11.0 MHz

From the Table 5, the local crystal frequency is 16.52 MHz.

Insert this crystal into the crystal socket assigned to the 31 meter band as shown in the remarks column of Table 5. Adjust TC21 as described in $\times 3$ band adjustment. Set the BAND switch to the 31 meter band position and peak the PRESELECTOR around the scale given in Figure 5.

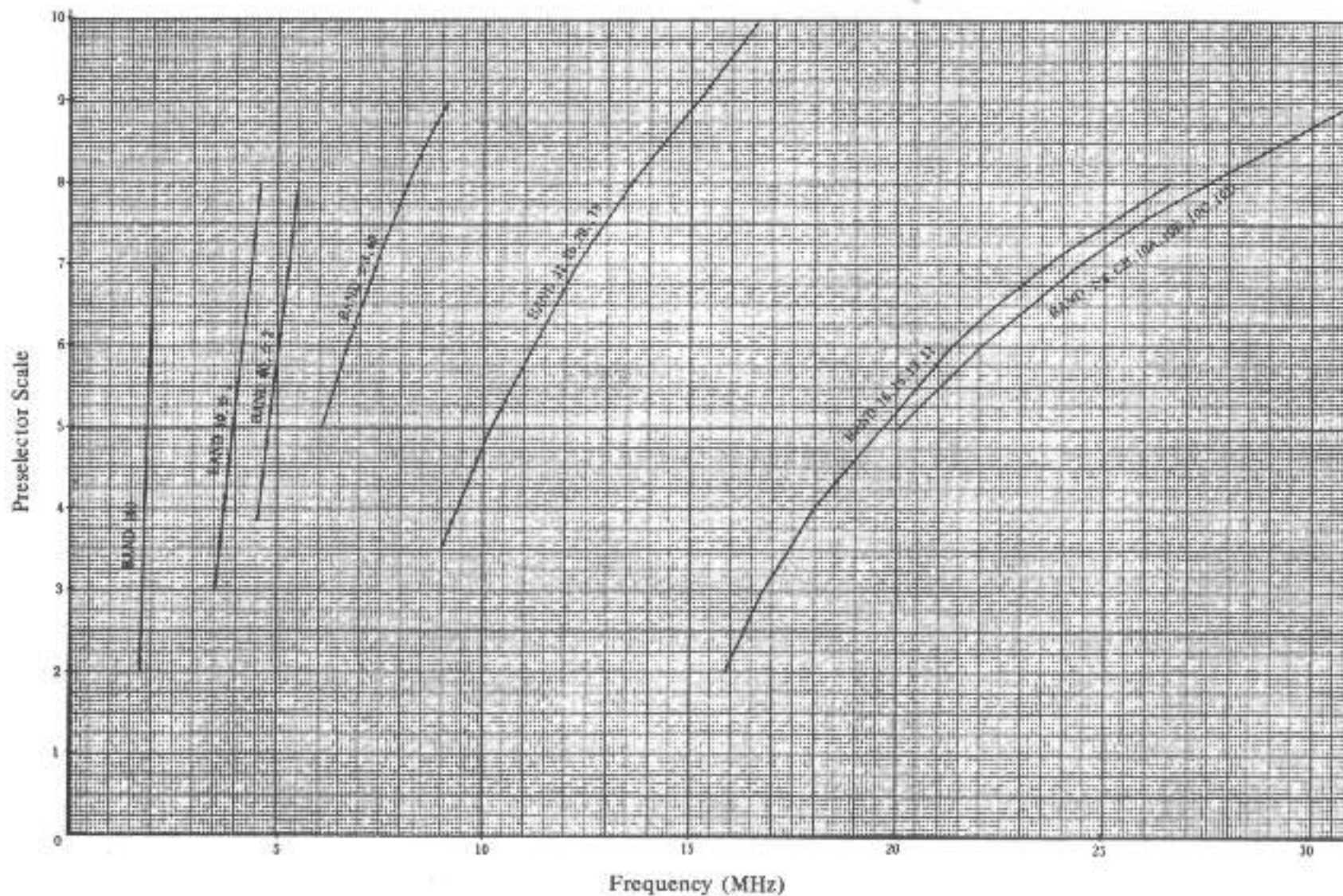

Fig. 5

Provided by
<http://www.yaesu-museum.com>

 Downloaded by
 Amateur Radio Directory

FREQ	XTAL (MHz)	BAND	RMKS	FREQ	XTAL (MHz)	BAND	RMKS	
1.8~2.0	7.52	160		16.0~16.5	22.02		Use 16m band.	
2.0~2.5			Not covered.	16.5~17.0	22.52			
2.5~3.0				17.0~17.5	23.02			
3.0~3.5				17.5~18.0	23.52	16		
3.5~4.0	9.52	80		18.0~18.5	24.02			
4.0~4.5	10.02		AUX 1	18.5~19.0	24.52			Adjust TC18.
4.5~5.0	10.52	60		19.0~19.5	25.02			
5.0~5.5	11.02		AUX 2	19.5~20.0	25.52			
5.5~6.0			Not covered.	20.0~20.5	26.02			
6.0~6.5				20.5~21.0	26.52			
6.5~7.0				21.0~21.5	27.02	15		
7.0~7.5	13.02	40		21.5~22.0	27.52	13	AUX 4	
7.5~8.0	13.52		AUX 3	22.0~22.5	28.02			
8.0~8.5	14.02			22.5~23.0	28.52			
8.5~9.0	14.52			23.0~23.5	29.02			
9.0~9.5	15.02		Use 31m band.	23.5~24.0	29.52			
9.5~10.0	15.52	31		24.0~24.5	30.02			
10.0~10.5	16.02		Adjust TC21.	24.5~25.0	30.52			
10.5~11.0	16.52		Use 25m band.	25.0~25.5	31.02			
11.0~11.5	17.02			25.5~26.0	31.52	11		
11.5~12.0	17.52	25		26.0~26.5	32.02			
12.0~12.5	18.02			Adjust TC20.	26.5~27.0	32.52		
12.5~13.0	18.52		Use 20m or 19m band.	27.0~27.5	33.02	CB		
13.0~13.5	19.02			27.5~28.0	33.52			
13.5~14.0	19.52			28.0~28.5	34.02	10A		
14.0~14.5	20.02	20		28.5~29.0	34.52	10B		
14.5~15.0	20.52			Adjust TC19 or TC27.	29.0~29.5	35.02		10C
15.0~15.5	21.02	19		29.5~30.0	35.52	10D		
15.5~16.0	21.52							

Table 5

TRANSCEIVE OPERATION

The FR-101 has the feature of transceive operation when it is used with our FL-101 transmitter or FT-101E/277E transceiver.

(1) FR-101-FL-101 COMBINATION

Before connecting the equipment, the interconnection cables should be prepared as illustrated in Figure 9. Install the FL-101 side by side with the FR-101 and connect them, as illustrated in Figure 6, with the cables prepared.

The switches and controls may be used as described in the preceding pages, however some of them are used particularly in transceive operation as follows:

SELECT: This switch selects the VFO (main tuning) of both transmitter and receiver as shown in Table 6. The red lamp will light up to indicate the VFO in use.

MONITOR: When the transmitting frequency coincides with the receiving frequency, the transmitted signal may be monitored by advancing this control slowly in a clockwise

direction. When the monitored signal is distorted by overloading, use the RF ATTENUATOR. This control does not work for CW sidetone monitoring, since the CW sidetone must be set to the desired listening level with the controls in the transmitter section.

TRANS:
(Trans-
ceive)

This control is used to coincide the frequency difference between the FR-101 and transmitter due to the tolerance limits of the various crystals. The adjustment of this control is as follows:

Set the CLAR control to OFF position. Advance the MONITOR control until your transmitting voice is heard from the FR-101 while transmitting on the same SSB mode as that of the receiver. Adjust the TRANS control for a natural voice quality. For CW operation, adjust the TRANS control for maximum S-meter reading of the monitor signal with the mode switch in the CW Narrow position, while keying the transmitter. Once the above adjustment has been done, it is not necessary to readjust the control until the band or mode in use is changed.

	SELECT SWITCH		OPERATION
	FR-101	FL-101	
1	INT	INT	Separate operation.
2	EXT	INT	Transmitter VFO controls transmitter and receiver.
3	EXT	EXT	Transmitter VFO controls receiver, and receiver VFO controls transmitter frequency.
4	EXT	TRX	Receiver VFO controls transmitter and receiver. (Transceive operation by FR-101's VFO.)

Table 6

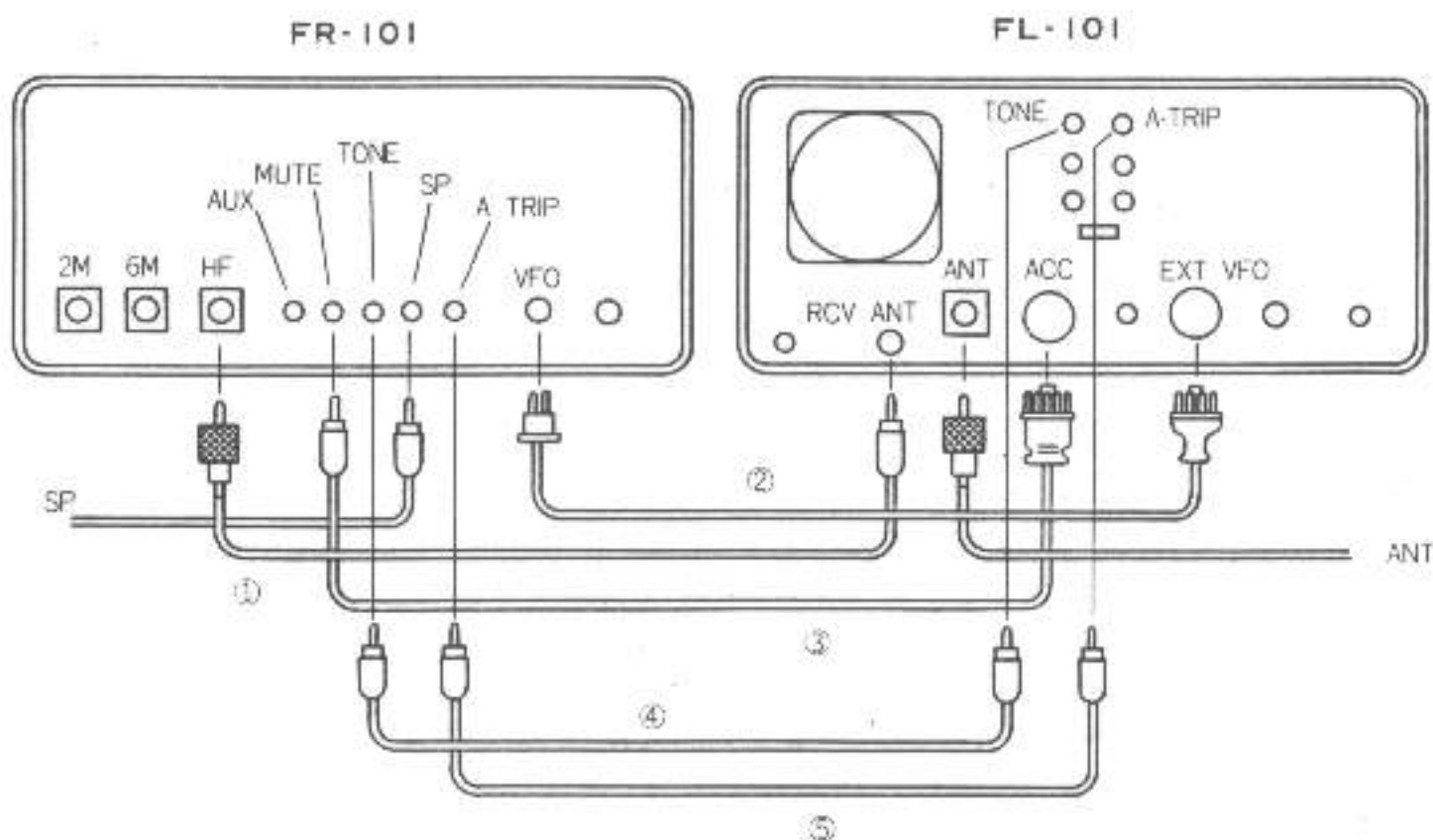

Fig. 6

(2) FR-101-FT-101E/277E COMBINATION

Connect the FR-101 and FT-101E/277E as illustrated in Figure 7. The operation is exactly same as the FR-FL combination except the function of SELECT switch, which is shown in Table 7.

Since the first IF of FR-101 has the characteristics shown in Figure 8, the receiver sensitivity will be decreased by the same amount shown on the Figure 8 when the FR-101 and FT-101E/277E are operated on different frequencies in mode 4 of Table 7.

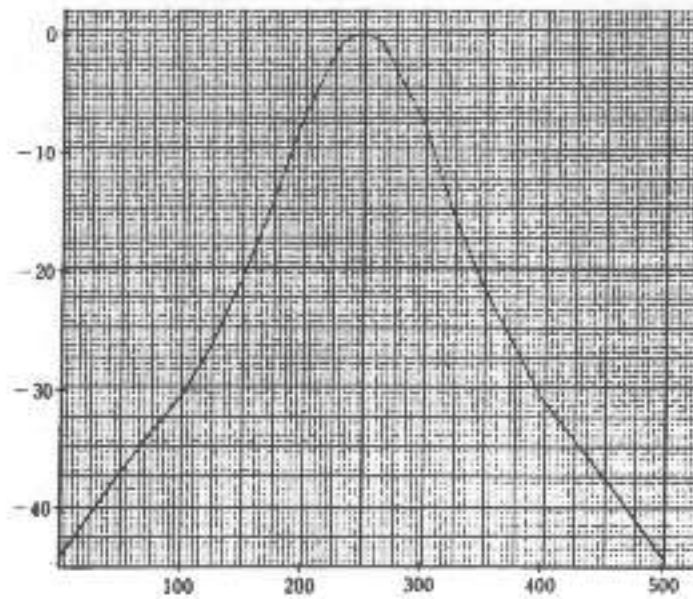

Fig. 8

	SELECT SWITCH		OPERATION
	FR-101	FT-101E/277E	
1	INT	INT	Separate operation. Transceiver VFO controls transceiver, and receiver VFO controls receiver.
2	EXT	INT	Transceiver VFO controls transceiver and receiver. (Transceive operation by FT-101E/277E's VFO)
3	EXT	RXEXT	Transceiver VFO controls transmitting frequency. Receiver VFO controls receiver itself and receiving frequency of transceiver.
4	EXT	TXEXT	Transceiver VFO controls receiving frequency of transceiver and receiver. Receiver VFO controls transmitting frequency of transceiver.
5	EXT	EXT	Receiver VFO controls both transceiver and receiver.

Table 7

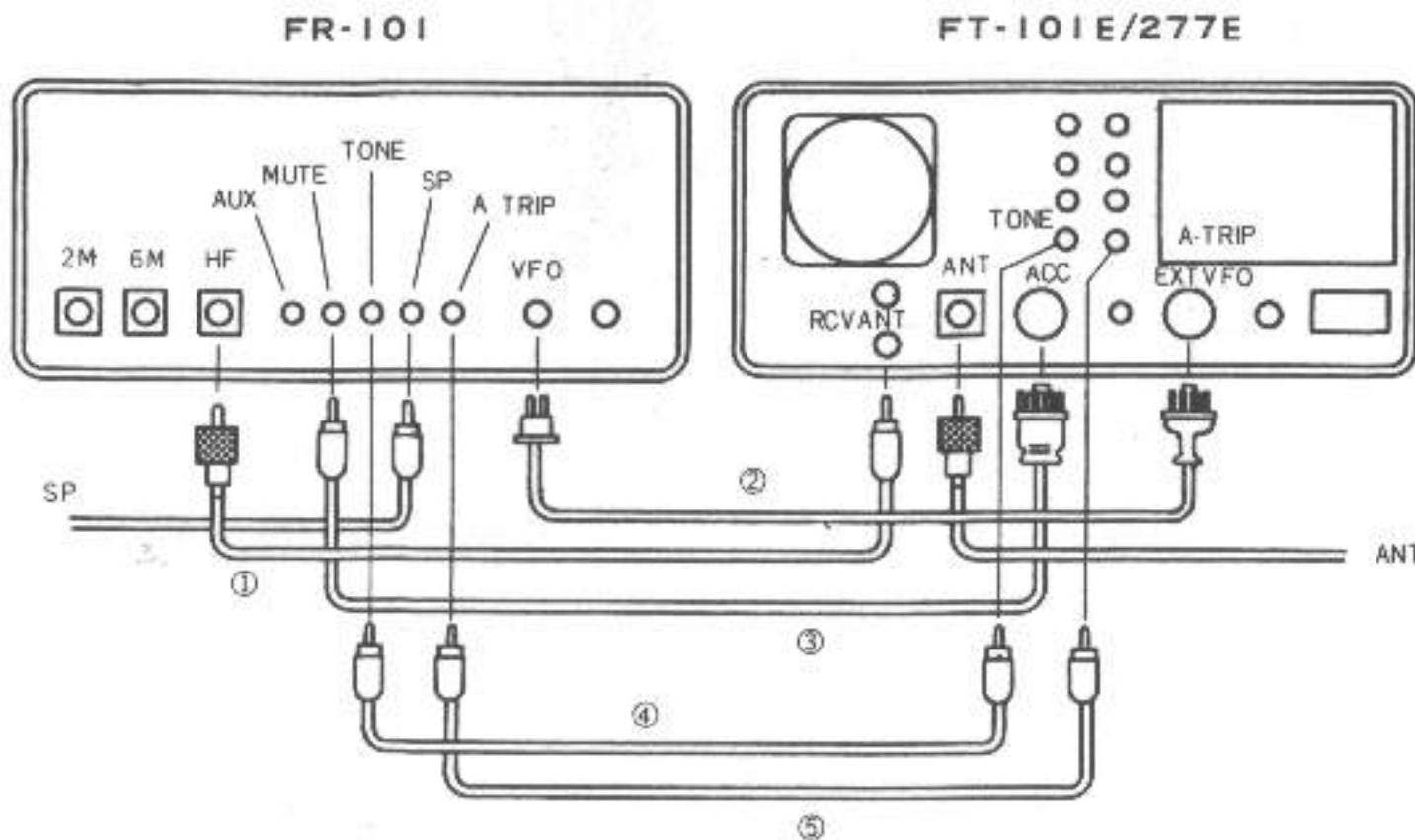

Fig. 7

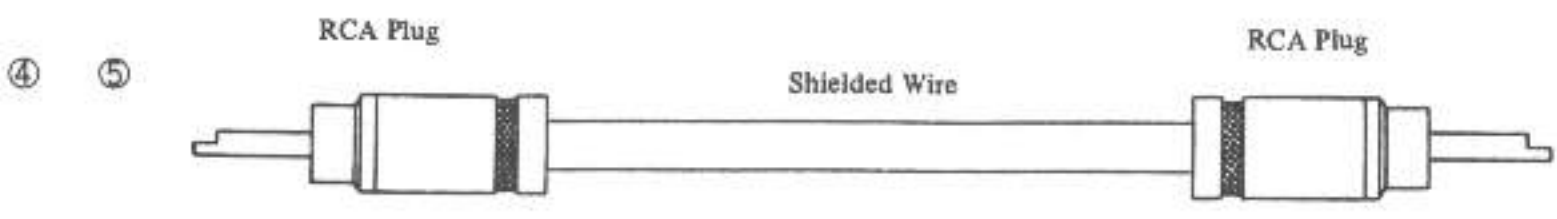
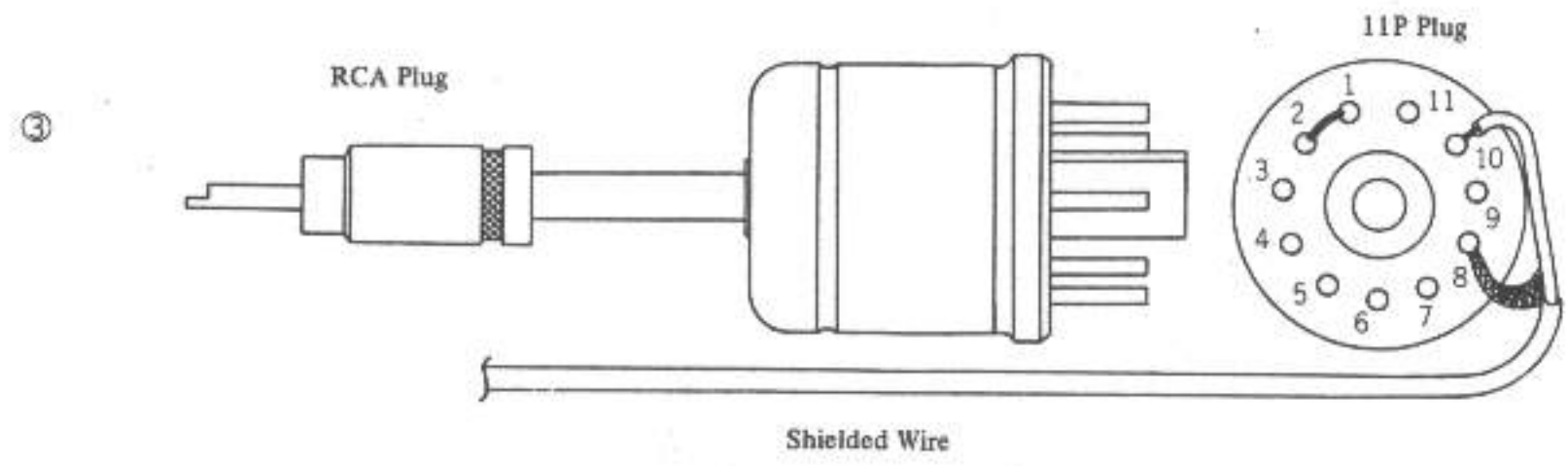
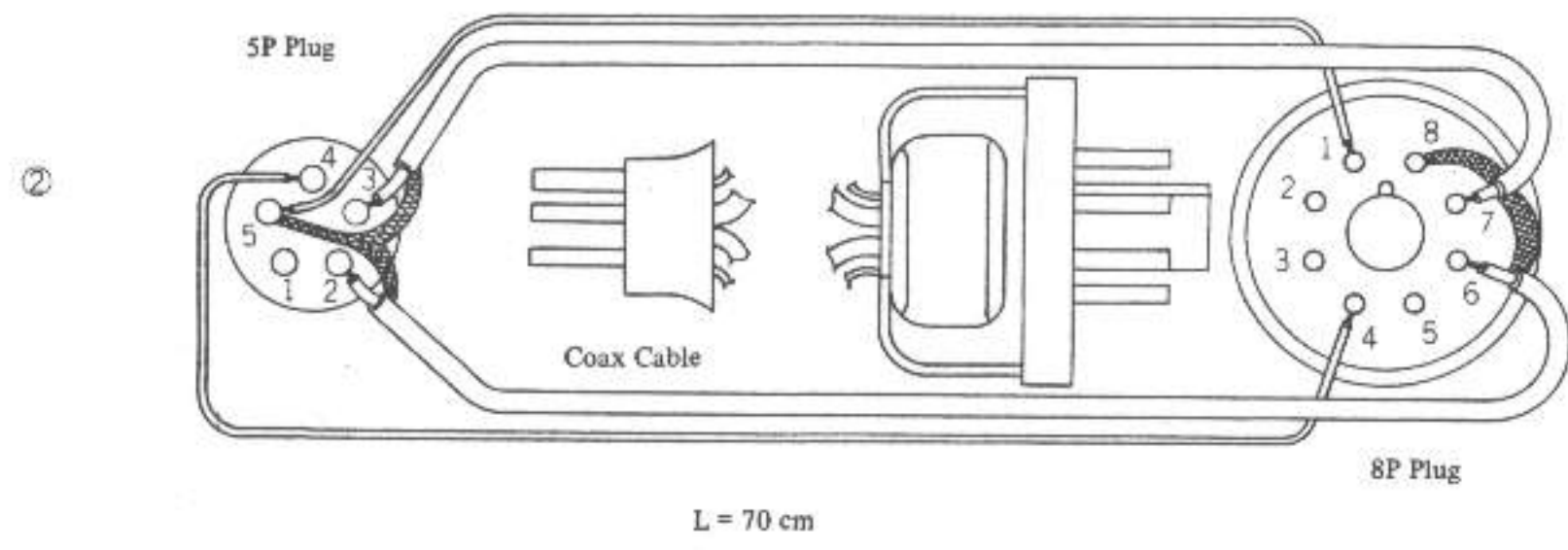
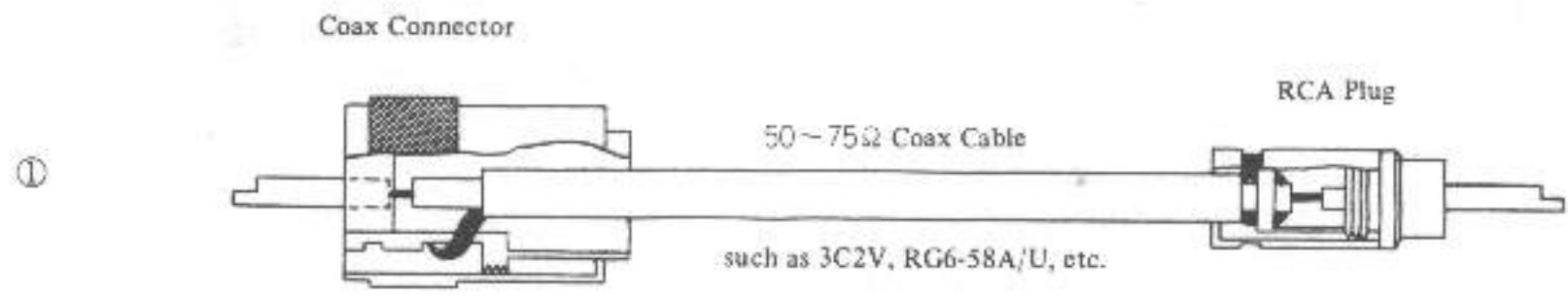

Fig. 9

crystal filter is amplified through Q4 and Q5, CA3053, and fed to the appropriate detector.

The ring demodulator, D1 through D4, 1S1007, is used for the detection of SSB, CW, and RTTY signals. The carrier signal for SSB and the beat frequency signal for CW and RTTY, which is generated by the carrier oscillator Q1, Q2, and Q3, 2SC372Y, in the Regulator and BFO Unit, is fed to the ring demodulator through a buffer amplifier, Q1, 2SC372Y. The ring demodulator is balanced by VR1 for minimum distortion. The carrier oscillator oscillates either at 3,177.45 KHz, 3,181.50 KHz or 3,178.50 KHz, depending upon whether Q1, Q2 or Q3, 2SC372Y, is selected by the MODE switch. The MODE switch disconnects the emitter circuit of either transistor when not in use. The relation between the mode of received signal and carrier frequency is shown on Table 9.

MODE	FILTER	XTAL
CW·N	XF-3	X-3
CW	XF-1	X-3
RTTY	XF-1	X-1
USB	XF-1	X-3
LSB	XF-1	X-2
AM·N	XF-1	—
AM·W	XF-2	—
FM	—	—

X-1 = 3177.45 KHz.
X-2 = 3181.5 KHz.
X-3 = 3178.5 KHz.

Table 9

BAND	FREQ (MHz)	LOCAL OSC		RF AMP		MIXER T103
		XTAL (MHz)	TRIMMER	T101	T102	
160	1.8~2.0	7.52	TC26+C39	T104+C1	T105+C3	T106+C19
80	3.5~4.0	9.52	TC25+C38	T107+C4	T108+C7	T109+C20
60	4.5~5.0	10.52	TC24+C37	T107+TC1+C9	T108+TC2+C11	T109+TC11+C20
40	7.0~7.5	13.02	TC23+C36	TC3+C12	TC4+C14	TC12+C23
31	9.5~10.0	15.52	TC21+C35	TC5+C15	TC6+C17	TC13+C24
25	11.5~12.0	17.52	TC20+C34	"	"	"
20	14.0~14.5	20.02	TC19+C33	"	"	"
19	15.0~15.5	21.02	TC27+C42	"	"	"
16	17.5~18.0	23.52	TC18+C32	TC7	TC8	TC14
15	21.0~21.5	27.02	TC17	"	"	"
13	21.5~22.0	27.52	"	"	"	"
11	25.5~26.0	31.52	C44	"	"	"
CB	27.0~27.5	33.02	"	TC9	TC10	TC15
10A	28.0~28.5	34.02	"	"	"	"
10B	28.5~29.0	34.52	"	"	"	"
10C	29.0~29.5	35.02	"	"	"	"
10D	29.5~30.0	35.52	"	"	"	"

Table 8

An AM signal is detected by D5, 1S1007. An FM signal is fed to a limiter amplifier, Q6, TA7061AP, in an (optional) FM detector unit through C13 and Pin 1. The output from Q6 is then fed to the FM detector consisting of D1 and D2, 1S188FM. The detected audio signal is amplified by Q1, 2SC372Y, and fed to the audio amplifier unit through the MODE switch. The squelch circuit consists of a noise amplifier, Q4 and Q5, 2SC372Y, a rectifier, D3 and D4, 1S188FM, and Schmitz trigger circuit, Q2 and Q3, 2SC372Y. The noise produced at the output of the FM detector is amplified by noise amplifier, Q4 and Q5, which is tuned to

approximately 35 KHz and rectified by D1 and D2. The rectified DC voltage is fed to the Schmitz circuit through the SQUELCH threshold control on the front panel. The Schmitz circuit cuts off the audio amplifier, Q1, in the absence of an incoming RF carrier, and thus speaker noise is eliminated. The audio output signals from the detectors are fed to the audio amplifier integrated circuit, Q5, AN214, through the MODE switch and the AF GAIN potentiometer. The audio amplifier circuit utilizes a OTL (Output Transformer-Less) circuit and delivers 3 watts to the speaker.

AGC & S-METER CIRCUIT

The output signal from the last IF amplifier, Q4, is fed to the AGC (Automatic Gain Control) rectifiers, D6 and D7, 1S1555, through C14. The rectified AGC voltage is then amplified by a DC amplifier, Q2 and Q3, 2SC372Y. The AGC voltage automatically controls the gain of the RF amplifier, Q1, 3SK39Q, the second IF amplifier, Q5, CA3053, and the (optional) VHF converters. The S-meter is placed in the emitter circuit of the AGC amplifier, Q3, in which the emitter current changes in accordance with the signal strength.

NOISE BLANKER CIRCUIT

A part of the second IF signal is fed to the noise amplifier, Q3 and Q4, 2SC372Y, and rectified by D3 and D4, 1S1555, to obtain a reference voltage for the noise blanker rectifier.

When the noise pulses exceed this reference voltage, D2, 1S1555, produces a negative voltage which is applied to the gate of Q6, 2SK19GR, causing a rise in drain voltage. This voltage causes Q7, 2SC372Y, to stop conducting and its collector voltage to rise. D1, 1S1555, starts to conduct, shorting the output voltage of T117 to ground, when a strong noise pulse is present.

FIX CHANNEL CIRCUIT

A FET, Q1, 2SK19GR, crystal-controlled oscillator, produces the second mixer injection signal. Four crystals may be selected by the SELECT switch on the front panel. The output signal is fed to the second mixer through L101. The clarifier control on the front panel varies the voltage on a varicap diode, D1, 1S2236, resulting in a slight change of oscillating frequency to compensate for crystal frequency tolerance.

POWER SUPPLY & VOLTAGE REGULATOR CIRCUIT

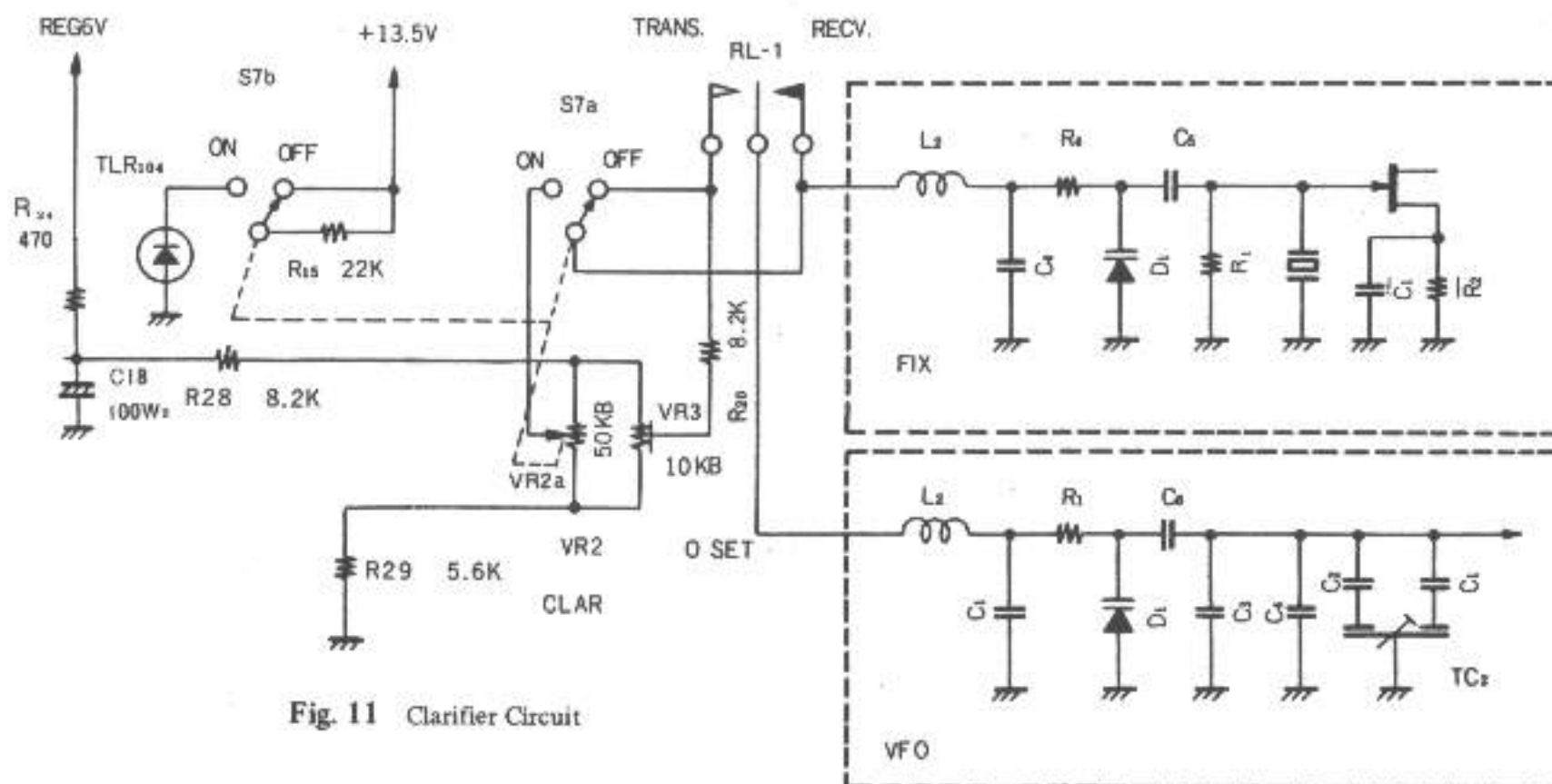

Fig. 11 Clarifier Circuit

The power supply is designed to operate from either 100/110/117/200/220/234 volt AC 50/60 Hz or 12 volt DC (negative ground). Inserting the appropriate power plug into the rear panel receptacle makes the necessary connection to operate the supply in either AC or DC. For AC operation, +14.5 volts is supplied from bridge connected rectifier diodes, D3 through D6. The DC voltage from this rectifier is supplied to the voltage regulator, Q4 MFC 6033 (~34A) to obtain an extremely stable 6 volt DC supply which is then fed to the various circuits. The digital readout receiver is designed for AC operation only.

CALIBRATOR CIRCUIT

Crystal-controlled oscillator, Q1, 2SC735Y, on the AF board, oscillates at 100 KHz for calibration purpose. A trimmer capacitor, TC1, is used to calibrate 100 KHz crystal frequency against WWV or JJY. The output from this oscillator is fed into a 25 KHz multivibrator, Q2 and Q3, 2SC735Y, which generates a marker signal every 25 KHz. The switch on the printed board disables the 25 KHz multivibrator. The calibrator output signal is fed to the receiver antenna circuit through a buffer amplifier, Q4, 2SC735Y.

CLARIFIER CIRCUIT

A control voltage is applied to a varactor diode, D1, 1S2236, through a relay contact and the clarifier switch, to shift the VFO frequency for receiver offset tuning. This voltage is also used to shift the frequency of the FIX crystals.

When the clarifier switch is ON, the control voltage is applied through R28, VR2a, S7a, and a relay contact to the varactor diode. When the clarifier is OFF or in transceive, the control voltage is applied through R28, VR3, S7a, and a relay contact to the varactor diode.

VHF CONVERTERS

(1) 6 METER CONVERTER

A 6 meter signal from the antenna input jack is fed to a MOS FET RF amplifier, Q1, 3SK35, through passband transformers, T601 and T602. The amplified signal is then fed through interstage transformers, T603 and T604, to a gate of mixer, Q3, 3SK19GR, where the incoming signal is mixed with a heterodyne signal delivered from a crystal oscillator, Q2, 2SC372Y, - producing a 28 MHz through 30 MHz IF signal. The crystal oscillator, Q2, generates a 22 MHz or 24 MHz signal to cover the entire 6 meter band. Crystals, X1 and X2, are selected by the diode switch. The IF signal is fed through T607 and the VHF switch to the input circuit of the FR-101.

(2) 2 METER CONVERTER

A 2 meter signal from the antenna input jack is fed to a MOS FET RF amplifier, Q1, 3SK35, through T201. The amplified signal is then fed through slit-resonators, T202 - T206, to a gate of mixer Q2, 2SK19GR, where the incoming signal is mixed with a heterodyne signal through 30 MHz IF signal. The crystal oscillator, Q3, 2SC372Y, generates a 38.666 MHz or 39.333 MHz signal which is multiplied to 116 MHz or 118 MHz by a diode tripler, D2, 1S1555. This heterodyne signal is fed to a mixer through a buffer amplifier, Q4, 2SC710D. The IF signal from the mixer is fed to the input circuit of the FR-101 through T207 and the VHF switch.

NOTE: The earlier model has one crystal and covers 2 MHz range.

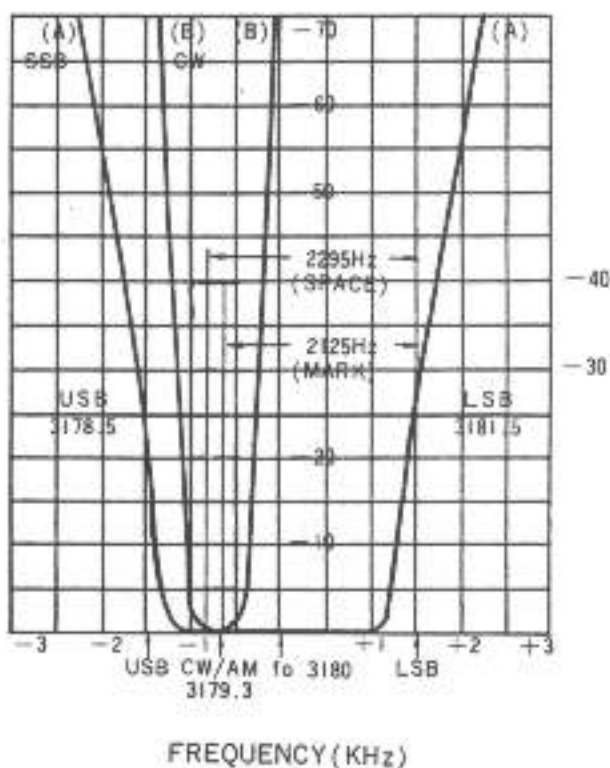

NOTE: RTTY RECEPTION

Since 170 Hz shift is commonly used in recent RTTY operation, the following modification may be recommended so as to use the 600 Hz CW filter in the RTTY reception.

MJ-6 BFO/REG Unit Socket

Remove a white/yellow wire from pin 6 of the MJ-6 and solder this white/yellow wire to pin 4 of the MJ-6.

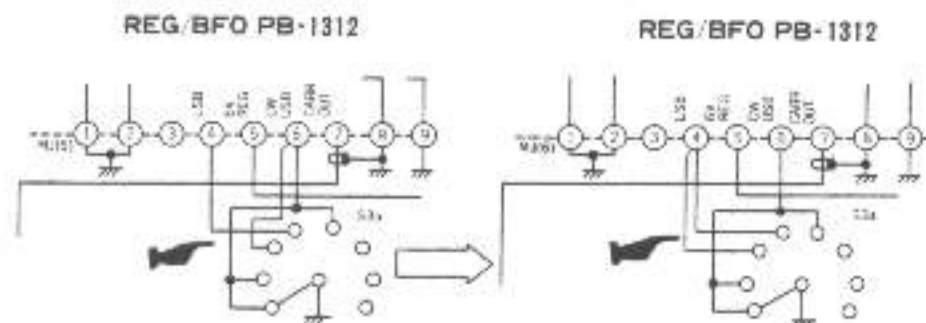
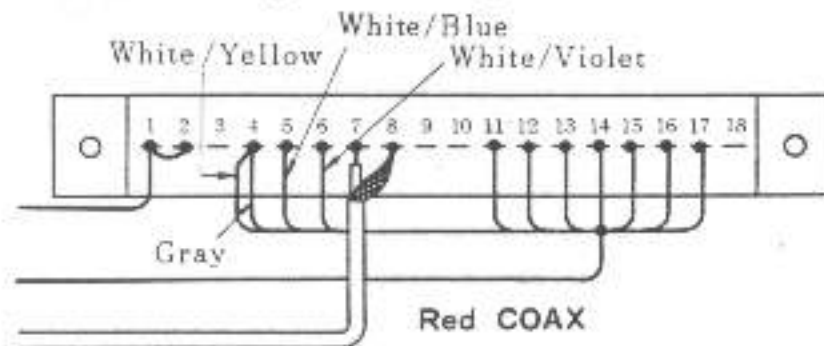

MODE Switch (S₃C wafer)

Disconnect a jumper wire between pin 5 and 6. Connect pin 5 to 7 with a jumper wire. Connect pin 6 to 8 with a jumper wire.

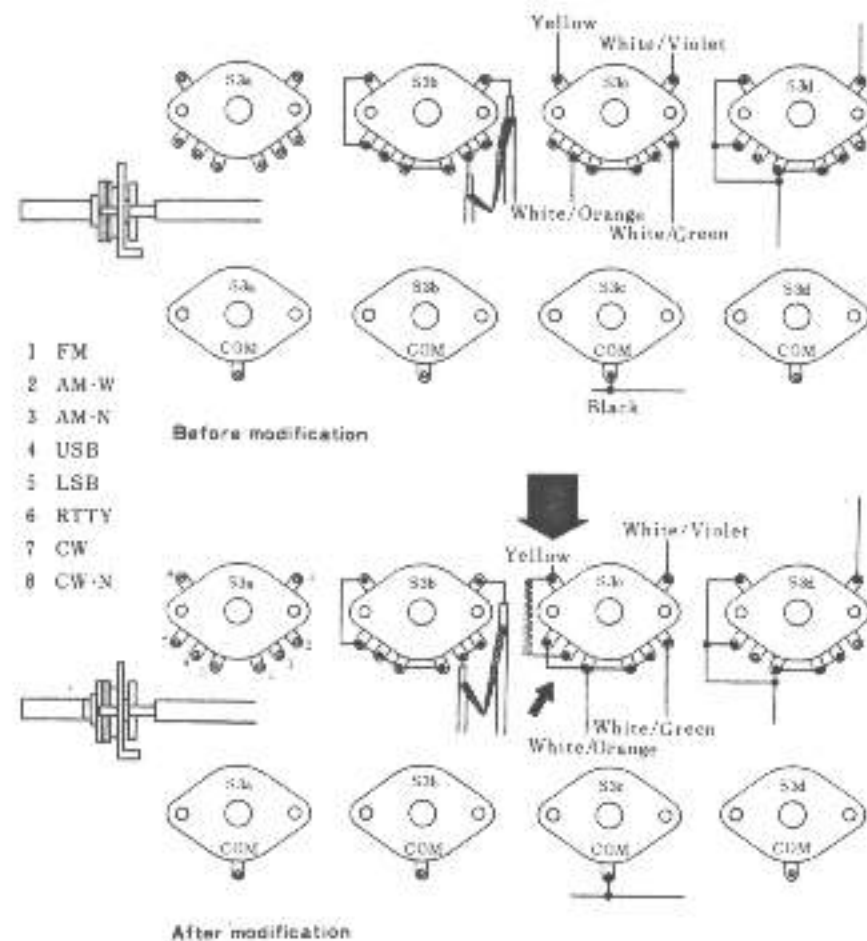

ALIGNMENT

GENERAL

The FR-101 has been carefully aligned and tested at the factory before shipment and, with normal usage, it should not require other than the usual attention given to any electronic equipment. Service or replacement of major component may require substantial realignment, but, under no circumstances, should realignment be attempted unless the operation of the receiver is fully understood and the malfunction has been fully analyzed and traced to misalignment. Service work should only be performed by experienced personnel using proper test equipment.

RF UNIT, PB-1225

(1) Oscillator Transformer, T110

- Connect the RF probe of a VTVM to the junction point between C27 and R11 (first local input).
- Set the BAND switch to the 11 meter band (10A band for FR-101 in which the 11 meter band is not installed).
- Adjust the slug of T110 for maximum VTVM reading.
- Check the VTVM reading when the BAND switch position is changed between 11 through to 10D. If the VTVM reading varies with the different BAND switch position, adjust T110 until the same reading is obtained through the 11 to 10D positions.

(2) Trimmer Capacitors, TC17 thru TC26

These trimmer capacitors are tuning capacitors for T110.

- Set the BAND switch to the 15 meter band.
- Peak TC17 for maximum VTVM reading.
- Slowly turn TC17 in direction of decreasing capacitance and set it to the point where the VTVM reading is 90% of the peak reading. (Refer to Figure 13.)
- Repeat the above procedures for the other bands as shown in Table 10.

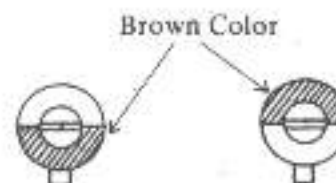

Fig. 13 Minimum Maximum

STEP	BAND	TRIMMER	OUTPUT VOLTAGE (V)	CHECK BAND
1	11	—	2.0	11~10D
2	15	TC17	"	15~13
3	16	TC18	"	—
4	19	TC27	"	—
5	20	TC19	"	—
6	25	TC20	"	—
7	31	TC21	"	—
8	40	TC23	"	—
9	60	TC24	"	—
10	80	TC25	"	—
11	160	TC26	"	—

Table 10

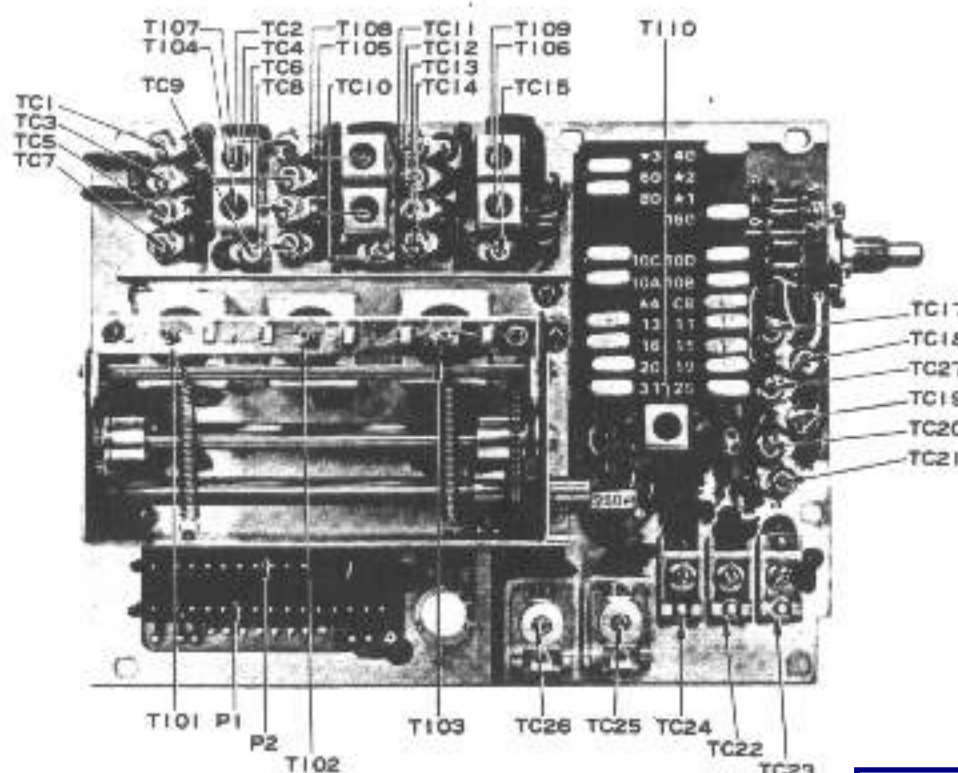

Fig. 12

Provided by
<http://www.yaesu-museum.com>

 Downloaded by
 Amateur Radio Directory

(3) Preselector and Associated Trimmers

A standard signal generator is required for this alignment. When a signal generator is not available, use the calibrator signal with the antenna terminal terminated with 50 ohm resistor. Connect the signal generator output to the antenna terminal marked HF. It is recommended to adjust the output level of the signal generator for an S-6 reading on the S-meter with the RF GAIN control at a fully clockwise position to avoid saturation during the following alignment.

Set the white pointer of the PRESELECTOR knob to 4.1 on the unity scale. Adjust the slugs of T101, T102 and T103 until the head of the slugs come to same level as the head of the coil bobbins.

Step 1, 2 and 3

Set the BAND switch to 10D, main tuning dial to 0 on the green scale (30 MHz) and the red pointer of PRESELECTOR to 3.3 on the unity scale. Set the signal generator to 30MHz and tune the FR-101 in with the main tuning dial. Adjust TC9, TC10 and TC15 for maximum S-meter reading.

Step 4, 5 and 6

Set the BAND switch to 10A, main tuning dial to 0 on the white scale, the red pointer of PRESELECTOR to 2.8 on the unity scale. Set the signal generator to 28 MHz and tune the FR-101 in. Adjust the slugs of T101, T102 and T103 for maximum S-meter reading.

Step 7

Repeat step 1 through step 6.

Step 8 thru 25

Perform as shown in Table 11 and as described above.

BANDPASS IF UNIT, PB-1396

- a. Set the BAND switch to the 20 meter position and the CALIB switch ON. Tune the FR-101 to a 14,250 KHz calibrator signal.
- b. Peak T111, T112 and T113 for maximum S-meter reading.

STEP	BAND	DIAL	PRE-SELECT	CAPACITOR
1	10D	G 000	R 3.3	TC9
2	"	"	"	TC10
3	"	"	"	TC15
4	10A	W 000	R 2.8	T101
5	"	"	"	T102
6	"	"	"	T103
7	Repeat procedures 1 ~ 6.			
8	160	G 900	R 10	T104
9	"	"	"	T105
10	"	"	"	T106
11	80	G 750	R 9.1	T107
12	"	"	"	T108
13	"	"	"	T109
14	60	"	W 4.5	TC1
15	"	"	"	TC2
16	"	"	"	TC11
17	40	W 250	R 1.3	TC3
18	"	"	"	TC4
19	"	"	"	TC12
20	19	"	W 9	TC5
21	"	"	"	TC6
22	"	"	"	TC13
23	11	G 750	W 7.7	TC7
24	"	"	"	TC8
25	"	"	"	TC14

Table 11

NOISE BLANKER & MIXER UNIT, PB-1252

(1) T114, T117 and T118

Set the FR-101 as described in the above procedure of PB-1396, and peak T114, T117 and T118 for maximum S-meter reading.

(2) T116

Connect the plus lead of VTVM to test point marked TP in Figure 14 and the minus lead to ground. Set the AGC switch to the OFF position and tune the FR-101 as above Step (1). Peak T116 for maximum VTVM reading.

(3) VR1

This potentiometer may be adjusted when the FR-101 is

used in transceive operation in conjunction with our FT-101E/277E transceiver.

- a. Set the SELECT switch of FT-101E/277E to INT position and the SELECT switch of FR-101 to EXT position.
- b. Set the MODE switch of FT-101E/277E to TUNE position and the BAND switch to 40 and tune the transmitter at 7,100 KHz for maximum output into a dummy load.
- c. Set the BAND switch of the FR-101 to the 80 meter position and the MODE switch to SSB (LSB or USB) position. Advance the MONITOR control until a beat can be heard while the FT-101E/277E is transmitting as described in Step (b).
- d. Adjust VR1 for minimum beat note.

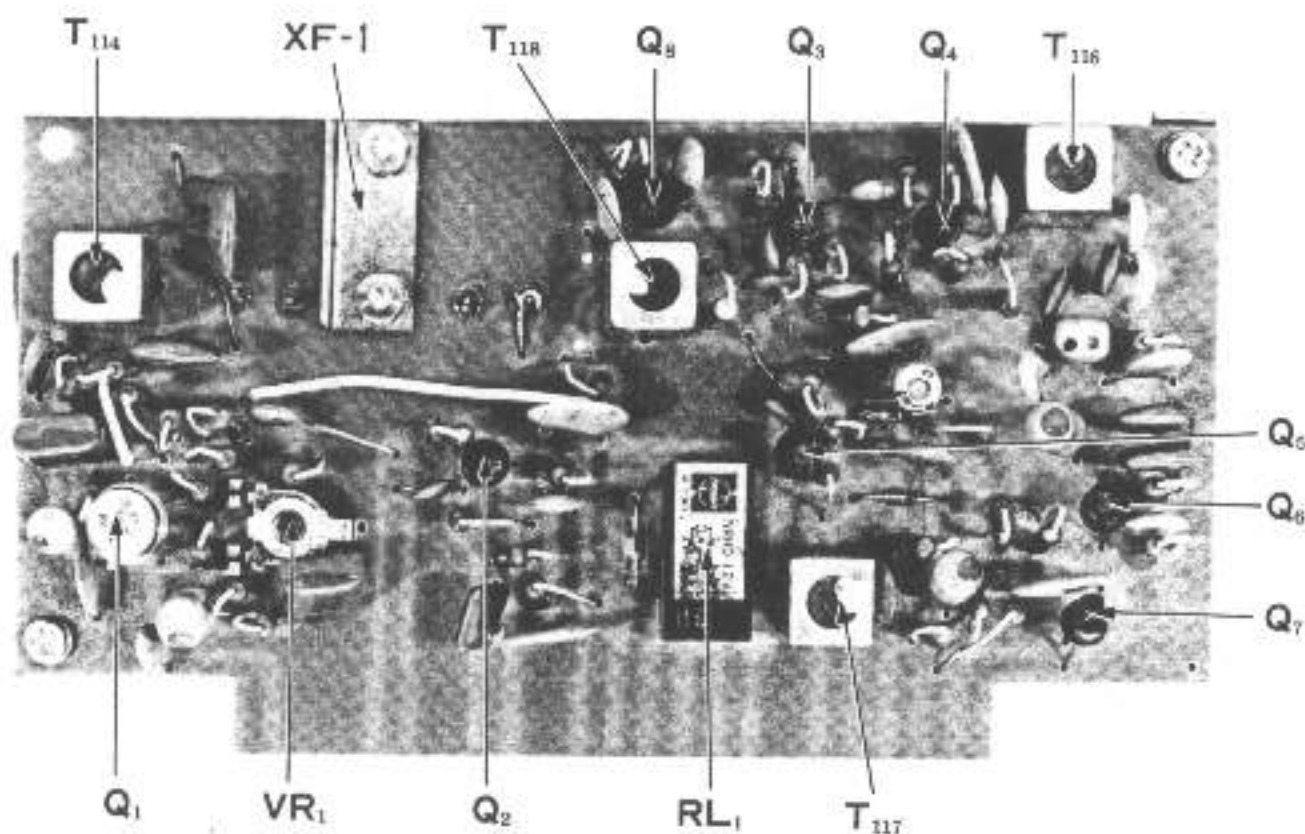

Fig. 14 NB-MIX UNIT

IF UNIT, PB-1251

(1) T119 and T120

Peak T119 and T120 for maximum S-meter reading as described in the T114 adjustment.

(2) VR1

Disconnect the antenna from the antenna jack. Set the MODE switch to USB position and adjust VR1 for minimum S-meter reading. Then set the MODE switch to

LSB position and adjust VR1 for minimum S-meter reading. Repeat these procedures for minimum S-meter reading at both USB and LSB positions.

(3) VR2

Connect the signal generator to the antenna jack of FR-101 and set the frequency to 14,250 KHz with an output level of 0.1 volt. Tune the FR-101 to the signal generator. Peak the PRESELECTOR and set the RF GAIN control fully clockwise. Adjust VR2 for S-9 +60 dB S-meter reading.

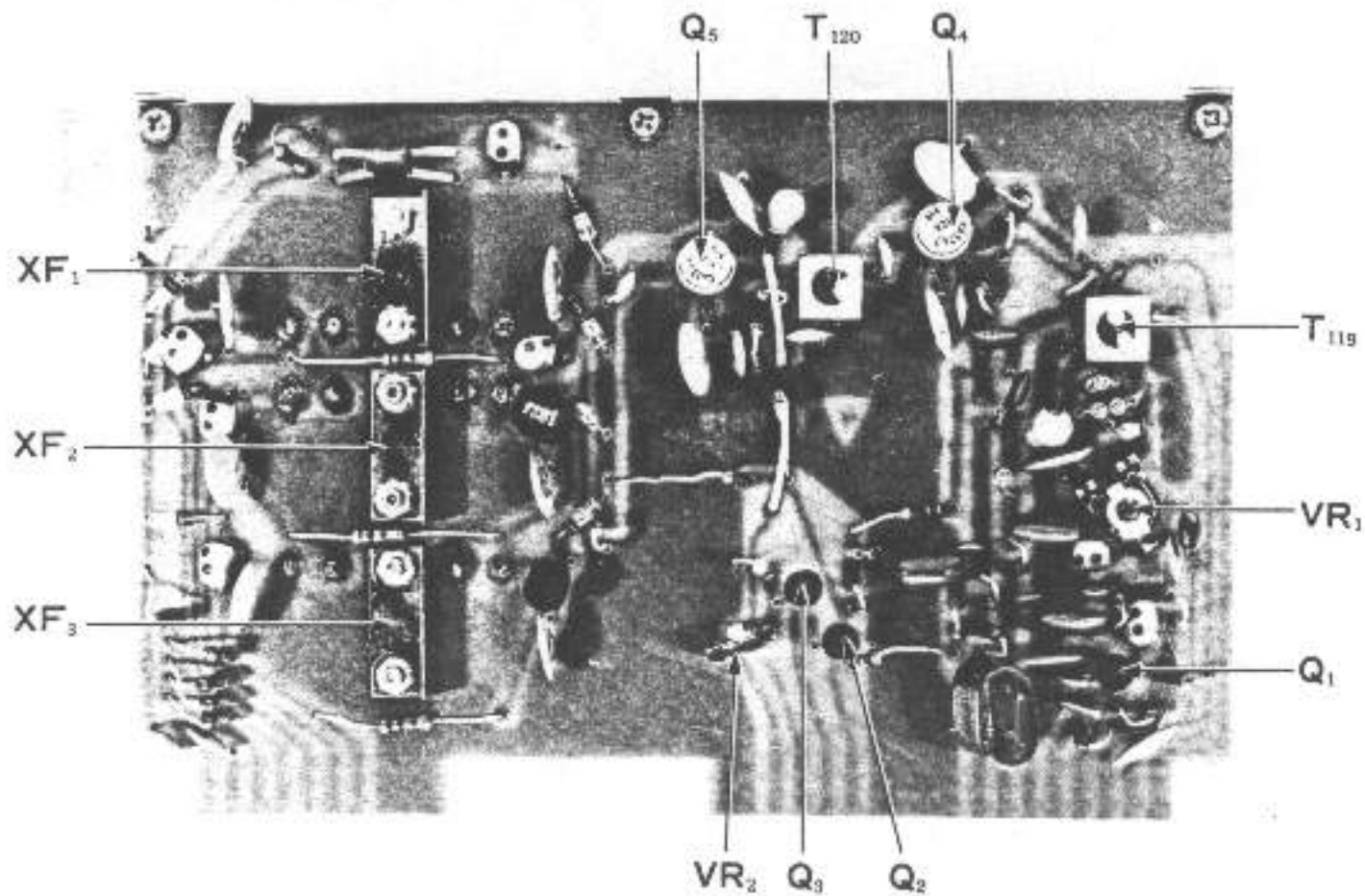

Fig. 15 IF UNIT

AF UNIT, PB-1268

(1) VR1

Adjust VR1 until the 25 KHz multivibrator locks in and the 25 KHz calibrator signal can be heard at every 25 KHz.

(2) VR2

Adjust VR2 for comfortable listening level of the sidetone signal when the FR-101 is used with FT-101E/277E in transceive operation.

(3) TC1

Receive WWV or JJY signal on AM Narrow mode and adjust TC1 for zero beat against 100 KHz calibrator signal.

(3) TC3

Adjust TC3 exactly to 3,178.5 KHz as described in (1).

(4) VR1

Connect the VTVM between Pin 14 of MJ-6 and ground and adjust VR1 for 6 volt VTVM reading

REGULATOR & BEAT FREQUENCY OSCILLATOR UNIT, PB-1312

(1) TC1

Connect a frequency counter to Pin 7 of MJ-6 and adjust TC1 until the frequency of the RTTY oscillator becomes exactly 3,177.45 KHz.

(2) TC2

Adjust TC2 exactly to 3,181.5 KHz as described in (1).

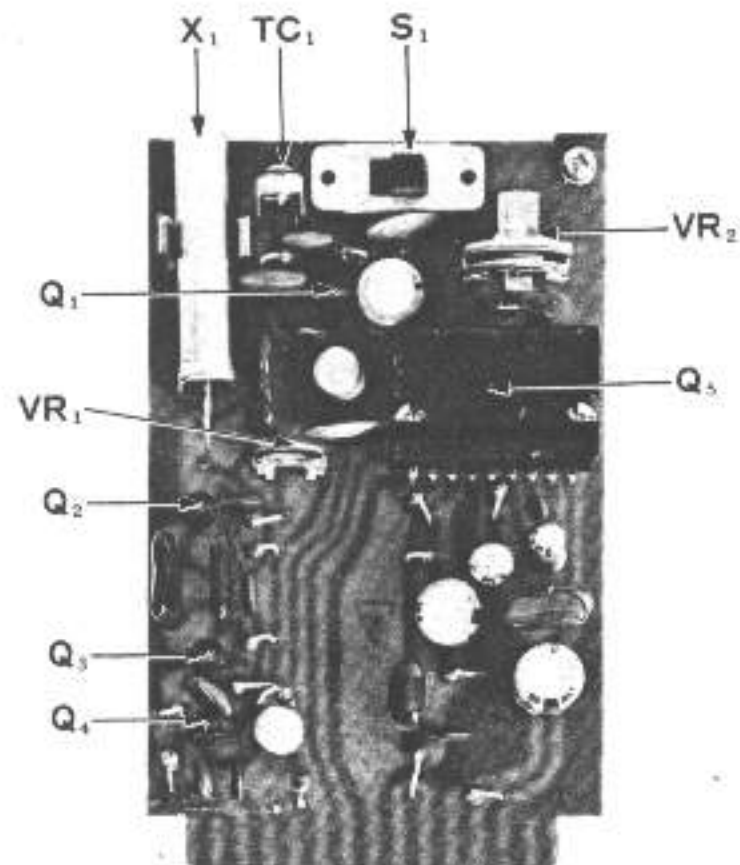

Fig. 16 AF-CALIB UNIT

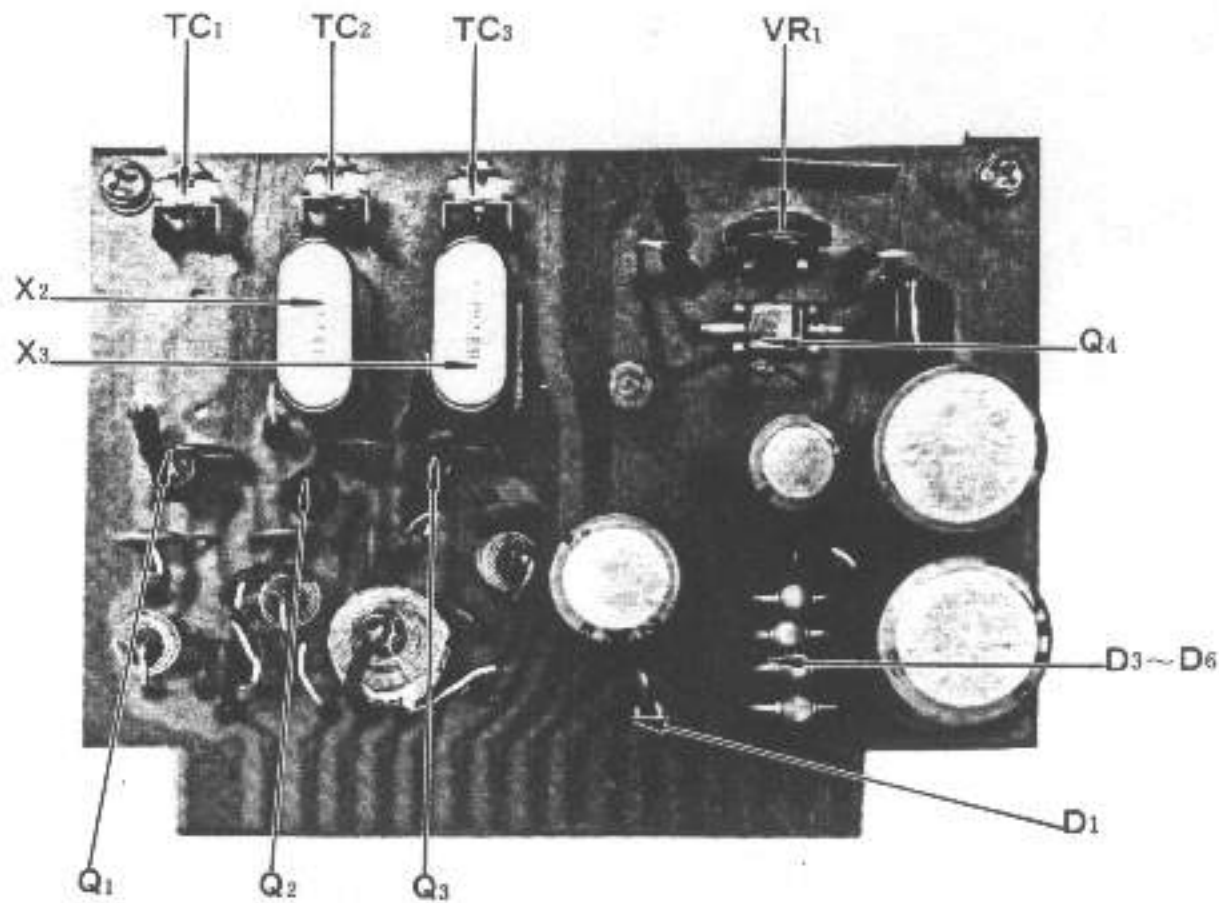

Fig. 17 REG-BFO UNIT

VFO UNIT, PB-1307

(1) TC1

Connect the frequency counter to the output terminal of the VFO unit. Set the main tuning dial to 14,000 KHz, i.e. the white scale to zero and subdial to zero. Adjust TC1 for 9,200 KHz.

(2) TC2

This trimmer capacitor is used to adjust the temperature compensation. At the setting illustrated in Figure 18, the oscillator frequency decreases with a temperature rise, and at the setting of Figure 19, the oscillator frequency rises with a temperature rise.

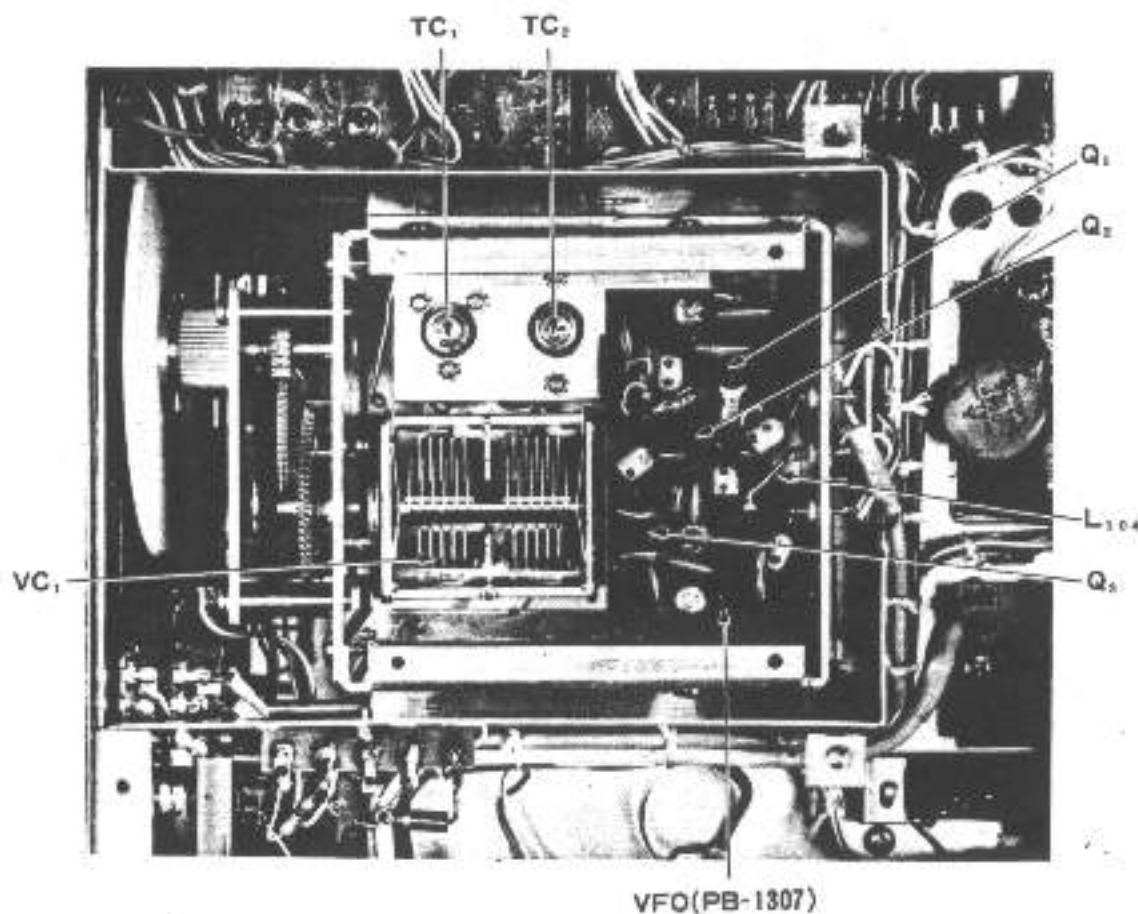

Fig. 20

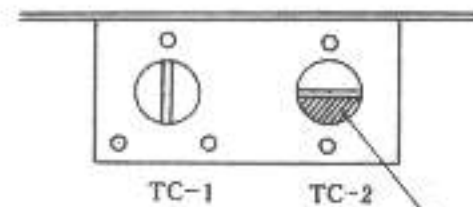

Fig. 18

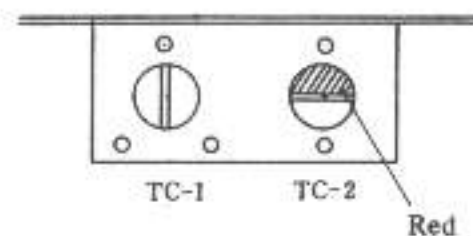

Fig. 19

Provided by
<http://www.yaesu-museum.com>

Downloaded by
 Amateur Radio Directory

VFO BUFFER UNIT, PB-1310

(1) L102

Another receiver is required for this alignment to monitor the spurious signal.

- Connect the FR-101 and FT-101E/277E as illustrated in Figure 7.
- Connect a dummy load to the antenna jack of the FT-101E/277E.
- Set the SELECT switches of the FR-101 and FT-101E/277E to the EXT position.
- Set the BAND switches of the FR-101 and FT-101E/277E to the 15 meter band.
- Tune the FR-101 to 21.2 MHz.
- Tune the FT-101E/277E to maximum power output with the MODE switch at the TUNE position.
- Tune the test receiver to the spurious signal which can be heard around 21.22 MHz and adjust L102 for a minimum S-meter reading at the test receiver.

FIX UNIT, PB-1311

(1) L101

- Connect the RF probe of a VTVM to the output terminal.
- Insert a crystal(s) in a crystal socket(s) and set the SELECT switch to the channel where the crystal is installed.
- Peak L101 for a maximum VTVM reading and then rotate the slug of L101 $\frac{1}{4}$ turn counter-clockwise.

(2) TC1 thru TC4

Adjust TC1 through TC4 to compensate for the crystal tolerance.

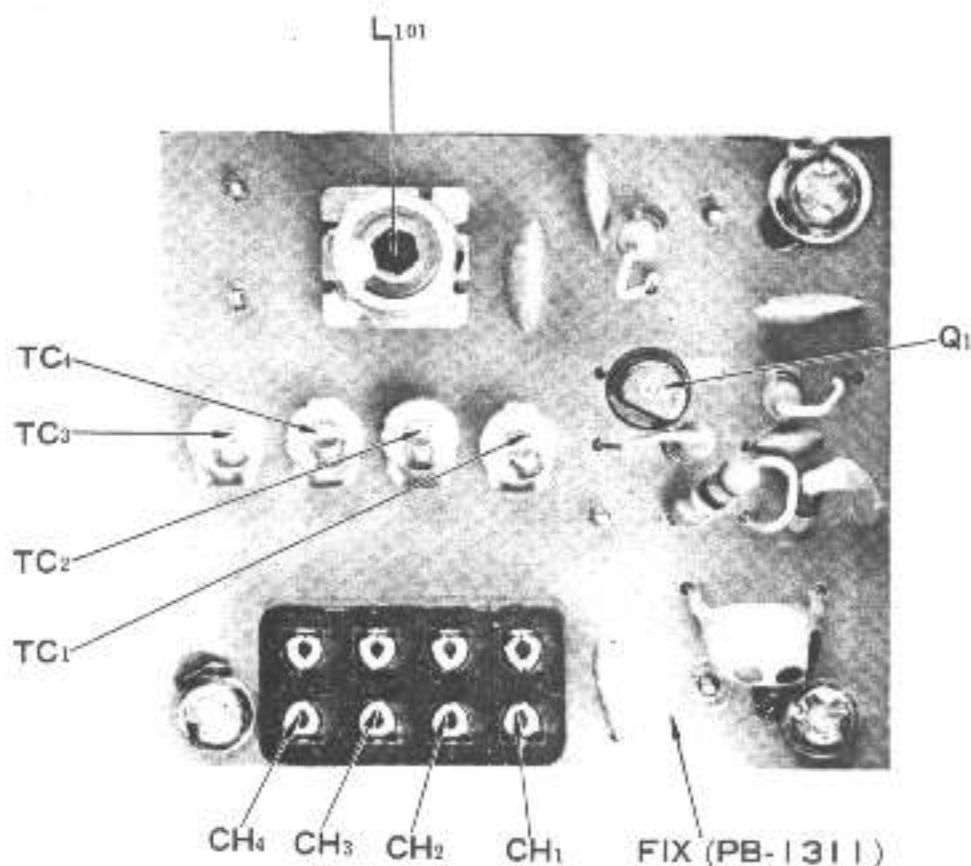

Fig. 21

IF TRAP COIL, (A) PB-1309 & (B) PB-1309

(1) T123

- Set the BAND switch to the 40 meter band and the red pointer of the PRESELECTOR to 10 on the unity scale.
- Connect the signal generator and set its frequency to 5,900 KHz with an output level of 60 dB.
- Locate this signal with main tuning knob and adjust T123 for minimum S-meter reading.

(2) T124

This trap coil functions when the FR-101 is in transceive operation. Adjust T124 for a minimum beat tone as described in the VR1 adjustment of the Noise Blanker and Mixer Unit alignment. Adjust the VR1 and T124 alternately for a minimum beat note.

FM UNIT, PB-1269

(1) T301 and T302

- Connect the DC probe of a VTVM to the test point shown as TP in Figure 22.
- Set the BAND switch to 20 meter, the MODE switch to AM, and the CALIB switch to ON.
- Tune the FR-101 to the calibrator signal and then turn the MODE switch to the FM position.
- Peak T302 for maximum VTVM reading. When the VTVM reading shows a minus direction, reverse the polarity of the VTVM.
- Adjust T301 for a zero VTVM reading.

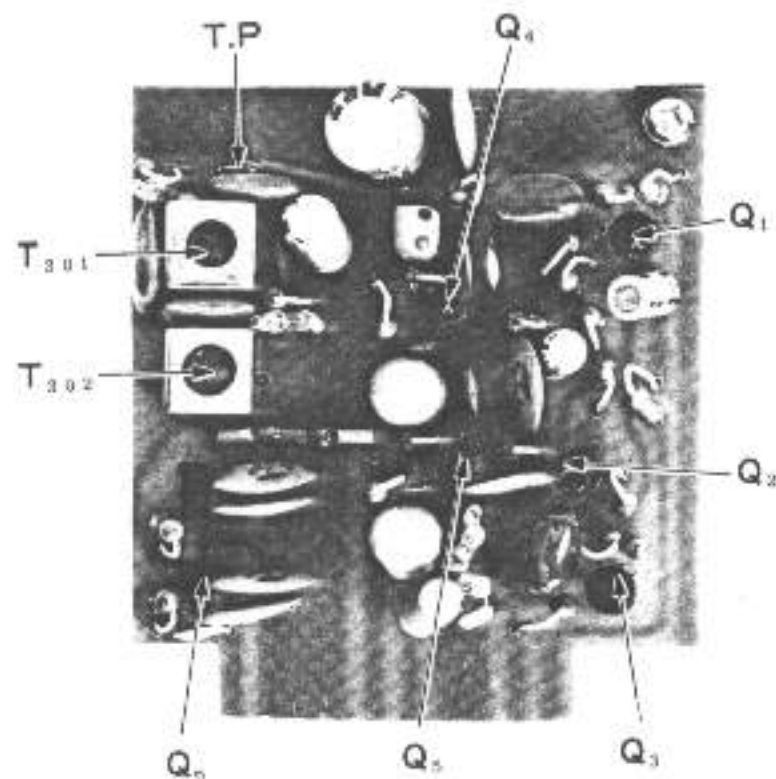

Fig. 22 FM UNIT

6 METER CONVERTER UNIT, PB-1305A

(1) T611, T612, T613 and T614

It is not recommended to align these coils, as special measuring instruments are required for this alignment.

(2) T615 and T616

- Connect the RF probe of a VTVM to the output terminal of T616.
- Peak T615 for a maximum VTVM reading. Then turn the slug $\frac{1}{4}$ turn counter-clockwise.
- Peak T616 for a maximum VTVM reading. When the oscillation stops with the T616 alignment, realign T615 for stable oscillation.

(3) T617 and T618

Receive a 51 MHz signal and peak T617 and T618 for a maximum S-meter reading.

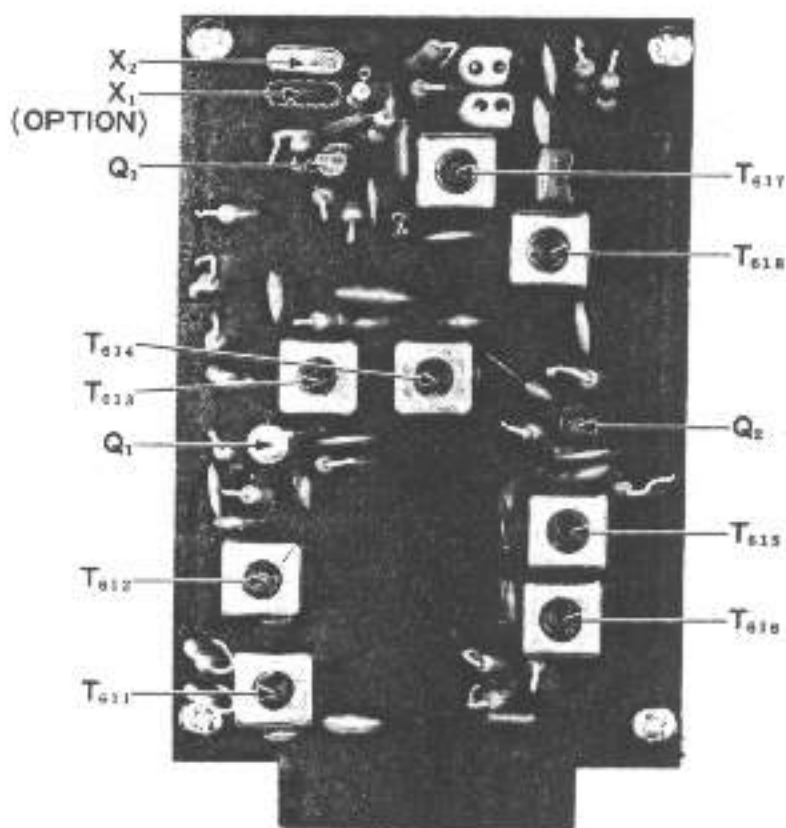

Fig. 23 6m CONVERTER PB-1305A

2 METER CONVERTER UNIT, PB-1306A

(1) T211, T212, T213, T214 and T215

It is not recommended to align these coils, as special measuring instruments are required for this alignment.

(2) T218, T219, and T220

- Connect the RF probe of a VTVM to the output terminal of T220.
- Peak T218 for a maximum VTVM reading. Then turn the slug $\frac{1}{4}$ turn counter-clockwise.

- Peak T219 and T220 for a maximum VTVM reading. When the oscillation stops with the alignment of T219, realign T218 for a stable oscillation.

(3) T216 and T217

Receive a 145 MHz signal and peak T217 for a maximum S-meter reading.

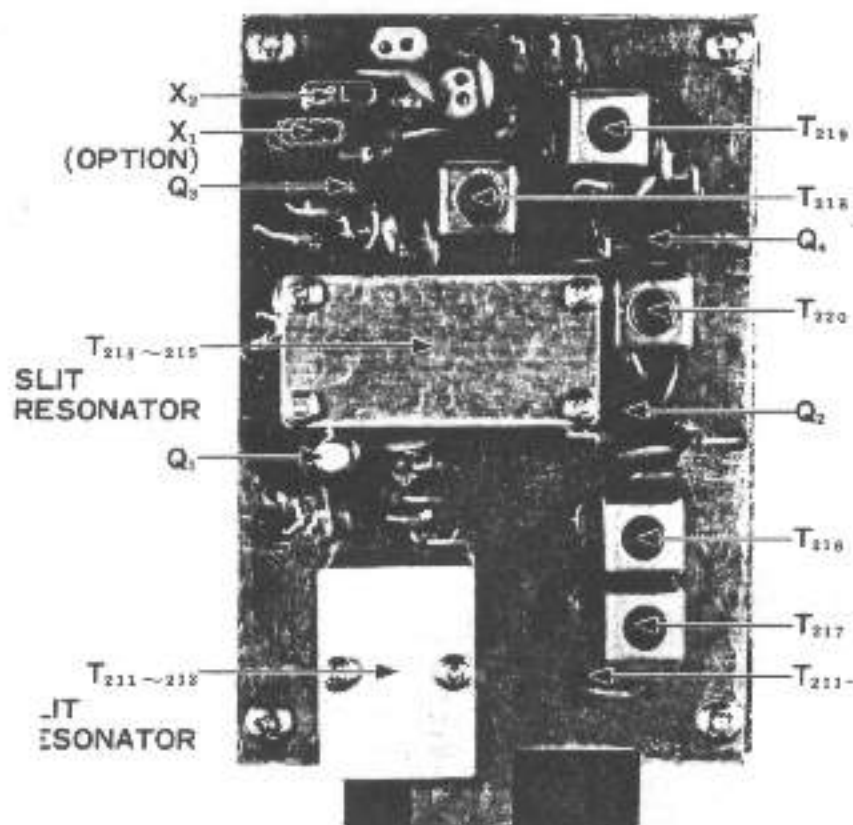

Fig. 24 2m CONVERTER PB-1306A

MAIN CHASSIS

(1) VR3

- Set the BAND switch to 20, the MODE switch to USB, the CALIB switch to ON and the CLARIFIER to zero. Zero beat the FR-101 against the calibrator signal with the main tuning dial.
- Set the CLARIFIER to the OFF position and adjust VR3 for a zero beat.

(2) VR5

Adjust VR5 for optimum performance of noise blanker. Too high of a setting of this control may cause cross modulation.

Provided by
<http://www.yaesu-museum.com>

Downloaded by
Amateur Radio Directory

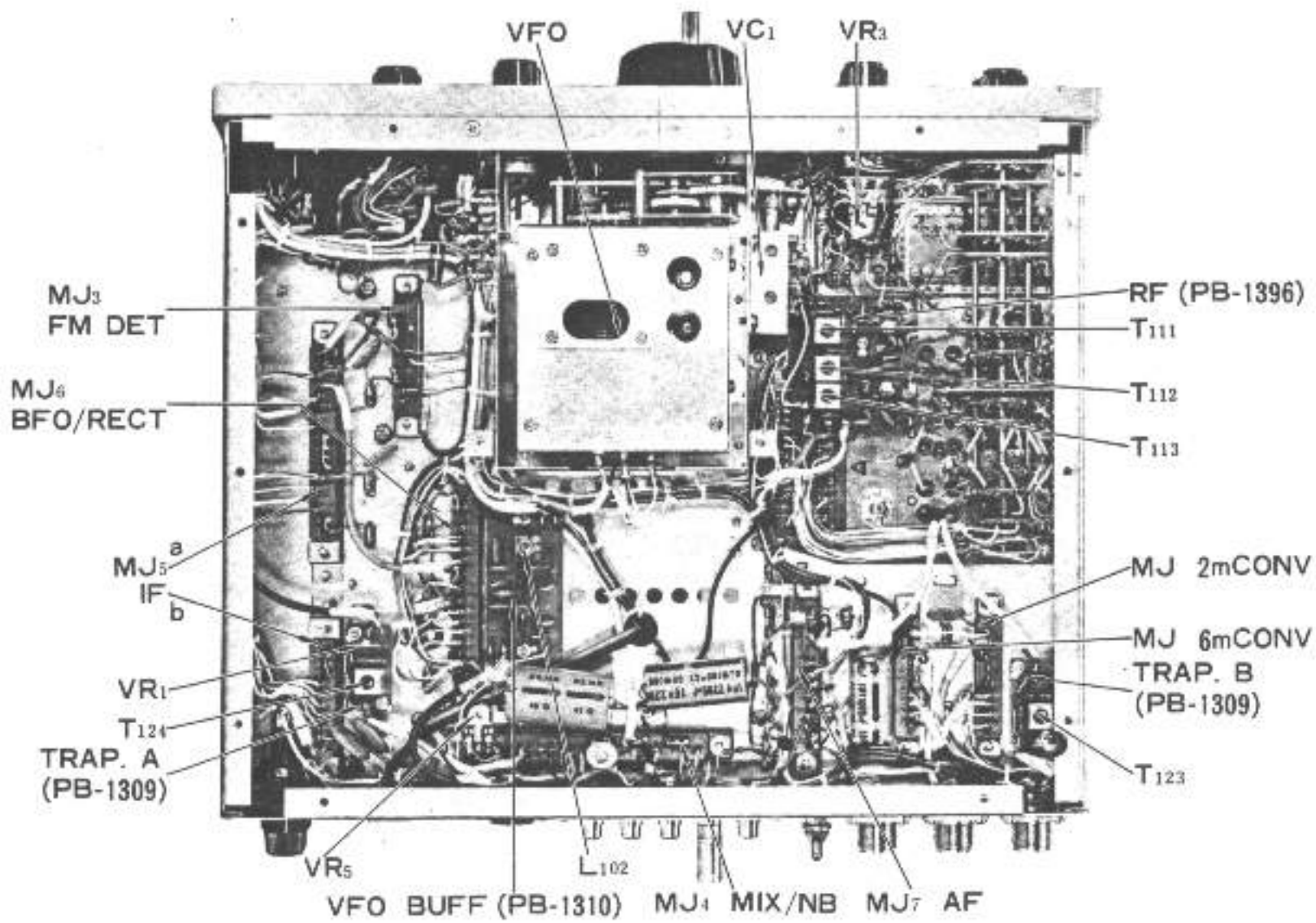
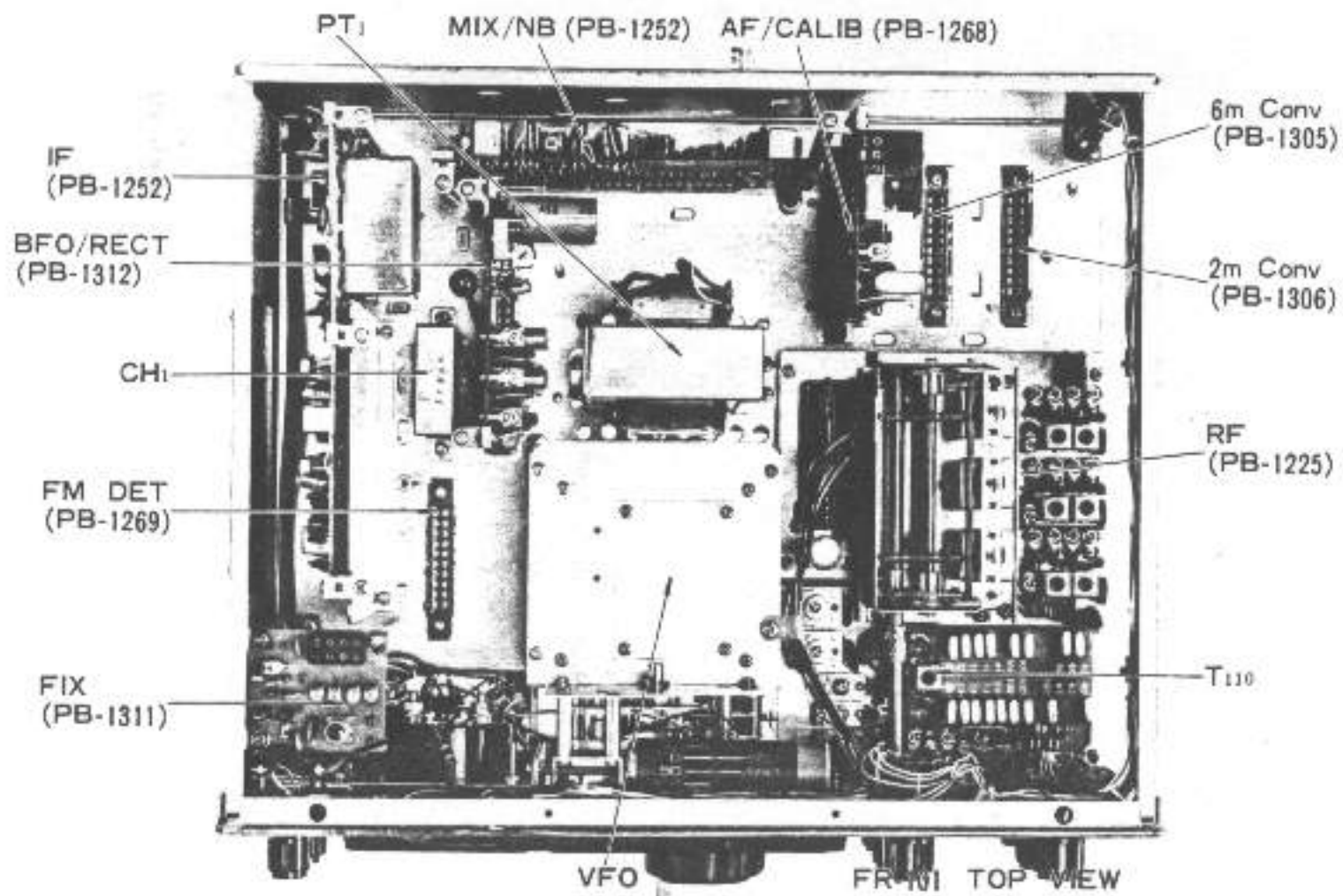

RESISTANCE & VOLTAGE MEASUREMENTS

MJ PIN	RESISTANCE (Ω)								VOLTAGE (V)								
	1	2	3	4	5a	5b	6	7	1	2	3	4	5a	5b	6	7	
1	800	800	∞	∞	∞	E	E	E	9	9	0	0	0	E	E	E	
2	0	0	E	E	E	E	E	E	0	0	E	E	E	E	E	E	
3	E	E	E	E	20	E	2.6	0	E	E	E	E	13.5	E	0.5	0	
4	E	E	E	E	4K	1.8K	2.7K	NC	E	E	E	E	2	13.5	0.5	NC	
5	E	E	∞	∞	50K	1.8K	24	1.6K	E	E	0	0	0	13.5	6	13.5	
6	E	E	900	E	E	0	0	5K	E	E	0	E	E	0	0	0	
7	E	E	E	E	1.7M	1.8K	4K	20	E	E	E	E	0	13.5	2	14.5	
8	0	0	E	∞	∞	20	E	E	0	0	E	0	0	13.5	E	E	
9	0	0	900	0	E	E	E	0	0	0	1	0	E	E	E	0	
10	20	20	∞	E	E	0	NC	E	13.5	13.5	0	E	E	0	NC	E	
11				20	E		4	1K				13.5	E		AC 15	0	
12				600	E		12	0				13.5	E		AC 11	0	
13				4K	20		NC	E				3.2	13.5		NC	E	
14				4K	800		24	E				3.2	9		6	E	
15				4K	800		12					3.2	9		AC 12		
16				0	95		12					0	0		AC 12		
17				0	E		20					0	E		14.5		
18				0	E		E					0	E		E		
19				E								E					
20				20								13.5					
21				100K								13.5					
22				100K								13.5					
The value may vary with the polarity of test lead. Above chart shows the higher values.									MODE : USB Measured with VTVM.								

Table 12

Provided by
<http://www.yaesu-museum.com>

 Downloaded by
 Amateur Radio Directory

PARTS LIST

MAIN CHASSIS			MJ-MULTI JACK		
Q-TRANSISTOR			1-3,5b		10P
1		2SC735Y	7		14P
			5a,6		18P
D-DIODE			4		22P
1	Ge	1S1007			
4	Zener	WZ061			
R-RESISTOR			PL-PILOT LAMP		
5,6	1/4 W	56Ω	1	BF026-29730A	14V 0.2A
1	1/4 W	75Ω	2-18	BQ041-32603A	14V 0.65A
2,3	1/4 W	100Ω	19,20	LED TLR-104	
4,9	1/4 W	220Ω			
19	1/4 W	470Ω			
R31	1/4 W	560Ω			
10,14	1/4 W	1KΩ			
15,18	1/4 W	2.2KΩ			
8,30	1/4 W	3.3KΩ			
20	1/4 W	8.2KΩ			
21	1/4 W	22KΩ			
12,26	1/2 W	10Ω			
11,25	1/2 W	100Ω			
17	1/2 W	56KΩ			
32	1 W	22Ω			
16	1 W				
VR-POTENTIOMETER					
1	EVK-A2AR	03-339			
2	50KΩB	with SWITCH			
3,5	10Ω	10KΩB			
4	EVK-DOAS15-601				
6	EVK-A2AR	03-604			
C-CAPACITOR					
DIPPED MICA					
14	500WV	180PF			
CERAMIC DISC					
2,3,13,15	50WV	0.01μF			
1,4,11	50WV	0.047μF			
6,7	1.4KV	0.0047μF			
MYLAR					
5,	50WV	0.01μF			
ELECTROLYTIC					
8	16WV	1000μF			
9	16WV	2000μF			
L-INDUCTOR					
1,2,3	RFC	250μH			
CH-CHOKE COIL					
1	20mH	0.5A			
PT-POWER TRANSFORMER					
1	SA2-10594				
M-METER					
1	S.METER				
S-SWITCH					
1	PUSH SWITCH				
5,6	1-4-3				
3	4-4-8				
4	3-6-6				
2	2-4-5				
J-JACK					
1,2,3	J50-239				
4	SG-7814				
5	SG-7615				
6-9,11	SN-7017	RCA JACK			
10	SI-6403-1				
12	QMS-AB4M				
			RF UNIT		
			PB-PRINTED CIRCUIT BOARD		
			1225(A-Z) RF BOARD		
			Q-TRANSISTOR		
			1	2SC372Y	
			D-DIODE		
			Varactor 1S2689		
			X-CRYSTAL		
			1	HC-25/U	7.52MHz
			2	HC-25/U	9.52MHz
			4	HC-25/U	10.52MHz
			7	HC-25/U	13.02MHz
			8	HC-25/U	15.52MHz
			9	HC-25/U	17.52MHz
			10	HC-25/U	20.02MHz
			11	HC-25/U	21.02MHz
			12	HC-25/U	23.52MHz
			13	HC-25/U	27.02MHz
			14	HC-25/U	27.52MHz
			15	HC-25/U	31.52MHz
			17	HC-25/U	33.02MHz
			18	HC-25/U	34.02MHz
			19	HC-25/U	34.52MHz
			20	HC-25/U	35.02MHz
			21	HC-25/U	35.52MHz
			R-RESISTOR		
			4	1/4 W	56Ω
			3,7	1/4 W	100Ω
			5	1/4 W	180Ω
			2	1/4 W	10KΩ
			1	1/4 W	15KΩ
			21	1/4 W	22KΩ
			6	1/4 W	33KΩ
			C-CAPACITOR		
			DIPPED MICA		
			16	500WV	1PF
			18	500WV	2PF
			13	500WV	3PF
			32,43,44	500WV	10PF
			6,10	500WV	15PF
			2,27	500WV	20PF
			33,42	500WV	30PF
			34,45	500WV	50PF
			15,17,24,28	500WV	60PF
			35	500WV	80PF
			36	500WV	100PF
			29	500WV	150PF
			38	500WV	
			12,14,23,37	500WV	220PF
			9,11,22	500WV	280PF
			39	500WV	400PF
			4,7	500WV	470PF
			20	500WV	500PF

1,3,19	500WV	1200PF	Q-TRANSISTOR, FET & IC	
	CERAMIC DISC		1	MC1496G
25,26,30,40,46	50WV	0.01 μ F	2,4,7	2SC372Y
31	50WV	0.047 μ F	3,5,6,8	2SK19GR
	ELECTROLYTIC			
41	16WV	470 μ F	D-DIODE	
TC-TRIMMER CAPACITOR			1~3	Si 1S1555
CERAMIC			5	Ge 1S188FM
1~6,11~13,17~21,27		50P32	6	Zener WZ 090
7~10,14,15		20P32		
	MICA		1	FM XF30D
22~24	B2PY	100PF		
25,26	A4P3	300PF	XF-CRYSTAL FILTER	
L-INDUCTOR			38	$\frac{1}{4}$ W 22 Ω
1	RF CHOKE	10 μ H	24,28	$\frac{1}{4}$ W 56 Ω
2	RF CHOKE	250 μ H	16,19,25,44	$\frac{1}{4}$ W 100 Ω
			12	$\frac{1}{4}$ W 150 Ω
T-TRANSFORMER			18,27,35	$\frac{1}{4}$ W 220 Ω
101	ANT COIL A		30,39	$\frac{1}{4}$ W 330 Ω
102	RF COIL A		2,23,14	$\frac{1}{4}$ W 470 Ω
103	MIX COIL A		41	$\frac{1}{4}$ W 560 Ω
104	ANT COIL B		1	$\frac{1}{4}$ W 820 Ω
105	RF COIL B		5,6,7,10,29	$\frac{1}{4}$ W 1K Ω
106	MIX COIL B		4	$\frac{1}{4}$ W 1.2K Ω
107	ANT COIL C		43	$\frac{1}{4}$ W 1.5K Ω
108	RF COIL C		11,34	$\frac{1}{4}$ W 3.3K Ω
109	MIX COIL C		45,32	$\frac{1}{4}$ W 5.6K Ω
110	OSC COIL		31	$\frac{1}{4}$ W 8.2K Ω
			3,8,9,21,40,42	$\frac{1}{4}$ W 10K Ω
J-JACK			13,22	$\frac{1}{4}$ W 22K Ω
1	PIN CONNECTOR	15P	33	$\frac{1}{4}$ W 56K Ω
2	PIN CONNECTOR	10P	17,26	$\frac{1}{4}$ W 100K Ω
3,4	CRYSTAL SOCKET	12P	38	$\frac{1}{4}$ W 150K Ω
			37	$\frac{1}{4}$ W 330K Ω
			36	$\frac{1}{4}$ W 1M Ω
RF AMP UNIT			VR-POTENTIOMETER	
PB-PRINTED CIRCUIT BOARD			1	10 ϕ 50K Ω B
1396(A~Z)	RF AMP BOARD		C-CAPACITOR	
			DIPPED MICA	
Q-FET			18	500WV 1PF
1,2	3SK35		10,17,47	500WV 10PF
			6	500WV 25PF
R-RESISTOR			34,35	500WV 30PF
13	$\frac{1}{4}$ W	56 Ω	9	500WV 39PF
12	$\frac{1}{4}$ W	100 Ω	32,33	500WV 100PF
6	$\frac{1}{4}$ W	150 Ω	12,45	500WV 200PF
9	$\frac{1}{4}$ W	220 Ω	14	500WV 700PF
7	$\frac{1}{4}$ W	1.8K Ω	CERAMIC DISC	
4	$\frac{1}{4}$ W	22K Ω	1,20,44	50WV 0.001 μ F
11	$\frac{1}{4}$ W	33K Ω	4,5,7,8,13,19,21,23	50WV 0.01 μ F
1,2,3,5,8	$\frac{1}{4}$ W	100K Ω	27,28,31,36,38,39,40	
10	$\frac{1}{4}$ W	220K Ω	11,22,30,42	50WV 0.047 μ F
C-CAPACITOR			2,3,41	50WV 0.1 μ F
			MYLAR	
			ELECTROLYTIC	
6	500WV	0.5PF	37	16WV 10 μ F
4	500WV	5PF	L-INDUCTOR	
7,8,9	500WV	60PF	1,2,4,5,6	RFC 1mH
1	500WV	100PF	3	RFC 250 μ H
CERAMIC DISC			7	FL4H6R8K 6.8 μ H
2,3,5,10,11,12	50WV	0.01 μ F	T-TRANSFORMER	
VC-VARIABLE CAPACITOR			114	IF COIL
1	C-332-A		116,117,118	N.B COIL
T-TRANSFORMER			RL-RELAY	
111	BPF COIL		1	12V AE5343
112	BPF COIL			
113	BPF COIL		IF UNIT	
MIX & N.B UNIT			PB-PRINTED CIRCUIT BOARD	
PB-PRINTED CIRCUIT BOARD			1251(A~Z) IF BOARD	
1252(A~Z)	MIX & N.B BOARD		Q-TRANSISTOR & IC	
			1~3	2SC372Y
			4,5	CA3053(TA7045M)

D-DIODE			13	$\frac{1}{4}$ W	470 Ω
1~5,7~15	Ge	1S1007	3,7,11	$\frac{1}{4}$ W	1K Ω
6	Si	1S1555	15	$\frac{1}{2}$ W	4.7 Ω
XF-CRYSTAL FILTER			14	$\frac{1}{4}$ W	1.5K Ω
			1,5,9	$\frac{1}{4}$ W	4.7K Ω
1	SSB	XF-32A	2,6,10	$\frac{1}{4}$ W	22K Ω
2	AM	XF-30B	18	$\frac{1}{2}$ W	100 Ω
3	CW	XF-30C	4,8,12	$\frac{1}{2}$ W	4.7K Ω
R-RESISTOR			VR-POTENTIOMETER		
			1	10 ϕ	1K Ω B
7,8,18	$\frac{1}{4}$ W	100 Ω	C-CAPACITOR		
12	$\frac{1}{4}$ W	150 Ω	DIPPED MICA		
3	$\frac{1}{4}$ W	180 Ω	3,6,9	500WV	30PF
6	$\frac{1}{4}$ W	470 Ω	2,5,8	500WV	40PF
37	$\frac{1}{4}$ W	560 Ω	CERAMIC DISC		
14,20	$\frac{1}{4}$ W	1K Ω	1,4,7,10	50WV	0.01 μ F
34	$\frac{1}{4}$ W	1.5K Ω	MYLAR		
15,21	$\frac{1}{4}$ W	2.2K Ω	15	50WV	0.001 μ F
2	$\frac{1}{4}$ W	4.7K Ω	16	50WV	0.1 μ F
22,23,27,29	$\frac{1}{4}$ W	6.8K Ω	ELECTROLYTIC		
4,5,19,24~26,28	$\frac{1}{4}$ W	10K Ω	14	16WV	10 μ F
1,9	$\frac{1}{4}$ W	22K Ω	11	16WV	100 μ F
11	$\frac{1}{4}$ W	56K Ω	17	25WV	220 μ F
10,13,36	$\frac{1}{4}$ W	100K Ω	12,13	25WV	1000 μ F
30~32	$\frac{1}{2}$ W	100 Ω	TC-TRIMMER CAPACITOR		
VR-POTENTIOMETER			1~3	CERAMIC	20P40
1	10 ϕ	500 Ω B	L-INDUCTOR		
2	10 ϕ	1K Ω B	1~3	RFC	22 μ H
C-CAPACITOR			4	TV-245	250 μ H
DIPPED MICA			AF UNIT		
13	500WV	10PF	PB-PRINTED CIRCUIT BOARD		
12	500WV	30PF	1268(A~Z) AF BOARD		
14,34	500WV	100PF	Q-TRANSISTOR & IC		
3,5	500WV	300PF	1~4	2SC735Y	
CERAMIC DISC			5	AN214	
16,20,28	50WV	0.001 μ F	D-DIODE		
8,10,17,23,25,40,41	50WV	0.01 μ F	1	Zener	WZ090
2,6,9,18,19,26,27	50WV	0.047 μ F	X-CRYSTAL		
29~31,35~38			1	HC-13/U	100kHz
MYLAR			R-RESISTOR		
4	50WV	0.001 μ F	3,10	$\frac{1}{4}$ W	100 Ω
7	50WV	0.022 μ F	17	$\frac{1}{4}$ W	120 Ω
1	50WV	0.047 μ F	12	$\frac{1}{4}$ W	220 Ω
15	50WV	0.1 μ F	19	$\frac{1}{4}$ W	1K Ω
21	50WV	0.47 μ F	4,7	$\frac{1}{4}$ W	4.7K Ω
ELECTROLYTIC			1,9,18	$\frac{1}{4}$ W	10K Ω
24	16WV	10 μ F	14	$\frac{1}{4}$ W	15K Ω
L-INDUCTOR			15	$\frac{1}{4}$ W	18K Ω
1	RFC	10 μ H	5	$\frac{1}{4}$ W	27K Ω
4,10	RFC	250 μ H	6,13	$\frac{1}{4}$ W	33K Ω
2,3	RFC	1mH	16	$\frac{1}{4}$ W	56K Ω
T-TRANSFORMER			2,8	$\frac{1}{4}$ W	100K Ω
119,120	IF COIL		VR-POTENTIOMETER		
BFO & REG UNIT			2	10 ϕ	5K Ω B
PB-PRINTED CIRCUIT BOARD			1	10 ϕ	10K Ω B
1312(A~Z)	BFO & REG BOARD		C-CAPACITOR		
Q-TRANSISTOR			DIPPED MICA		
1~3	2SC372Y		5,7,9	50WV	30PF
4	MFC-6034A		10	50WV	40PF
D-DIODE			8	50WV	50PF
1,3~6	Si	V06B	1	50WV	100PF
X-CRYSTAL			2	50WV	250PF
2	HC-6/U	3181.5kHz	4,6	50WV	1000PF
3	HC-6/U	3178.5kHz	3	50WV	2200PF
R-RESISTOR			MYLAR		
18	$\frac{1}{4}$ W	10 Ω	14	50WV	0.001 μ F
			16	50WV	0.01 μ F
			19	50WV	0.1 μ F

22	50WV	0.2 μ F	D-DIODE		
	ELECTROLYTIC		1	Varactor	1S2236
17	16WV	10 μ F			
18	16WV	22 μ F	R-RESISTOR		
13,15	16WV	100 μ F	1	$\frac{1}{4}$ W	10K Ω
20	16WV	220 μ F			
			C-CAPACITOR		
	TC-TRIMMER CAPACITOR		1	CERAMIC DISC 50WV	0.01 μ F
1	CERAMIC	50P40			
	L-INDUCTOR			FIX UNIT	
1,2	RFC	4mH		PB-PRINTED CIRCUIT BOARD	
				1311(A~Z) FIX BOARD	
	S-SWITCH				
1	SA-119			Q-FET	
			1	2SK19GR	
	VFO UNIT		D-DIODE		
	CHASSIS		1	Varactor	1S2236
	C-CAPACITOR				
	CERAMIC			XS-CRYSTAL SOCKET	
1	500WV	20PF	1	S-14	
	CERAMIC T.C				
5	UJ 50WV	2PF		R-RESISTOR	
3	UJ 50WV	7PF	2	$\frac{1}{4}$ W	56 Ω
2	UJ 50WV	20PF	3	$\frac{1}{4}$ W	100 Ω
6	NPO50WV	8PF	1,4	$\frac{1}{4}$ W	100K Ω
4	NPO50WV	82PF			
				C-CAPACITOR	
	VC-VARIABLE CAPACITOR			DIPPED MICA	
1	B5240 DS114		5	500WV	20PF
			3	500WV	60PF
	TC-TRIMMER CAPACITOR			CERAMIC DISC	
1	AIR TSN-150C	30PF	1,2,4	50WV	0.01 μ F
2	AIR TSN-170C	10PF \times 2			
				TC-TRIMMER CAPACITOR	
	L-INDUCTOR		1~4	CERAMIC	20P51
104	OSC COIL				
1,2	RFC	250 μ H		L-INDUCTOR	
			2	RFC	250 μ H
	OSC BOARD		101	OUTPUT COIL	
	PB-PRINTED CIRCUIT BOARD				
	1307(A~Z) VFO BOARD				
				VFO BUFF AMP UNIT	
	Q-TRANSISTOR & FET			PB-PRINTED CIRCUIT BOARD	
1,2	2SK19GR			1310(A~Z) VFO BUFF AMP BOARD	
3	2SC372Y				
				Q-TRANSISTOR	
	R-RESISTOR		1	2SC735Y	
3,5	$\frac{1}{4}$ W	100 Ω			
2	$\frac{1}{4}$ W	150 Ω		R-RESISTOR	
9	$\frac{1}{4}$ W	270 Ω	3	$\frac{1}{4}$ W	120 Ω
6	$\frac{1}{4}$ W	330 Ω	5	$\frac{1}{4}$ W	220 Ω
8	$\frac{1}{4}$ W	8.2K Ω	2	$\frac{1}{4}$ W	4.7K Ω
7	$\frac{1}{4}$ W	22K Ω	1	$\frac{1}{4}$ W	15K Ω
1,4	$\frac{1}{4}$ W	100K Ω	4	$\frac{1}{2}$ W	1K Ω
10	$\frac{1}{2}$ W	1K Ω			
	C-C-CAPACITOR			C-CAPACITOR	
	DIPPED MICA			DIPPED MICA	
6,8	500WV	100PF	1	500WV	80PF
1,2	500WV	650PF	7	500WV	400PF
9	500WV	2000PF	6	500WV	680PF
	CERAMIC DISC		4	500WV	1000PF
3,5,7,10	50WV	0.01 μ F	5	500WV	5000PF
	CERAMIC T.C			CERAMIC DISC	
4	NPO 50WV	10PF	2,3	50WV	0.01 μ F
	L-INDUCTOR			L-INDUCTOR	
1~3	RFC	250 μ H	102	TRAP COIL	
105	RFC		103	OUTPUT COIL	
	CLARI BOARD				
	PB-PRINTED CIRCUIT BOARD			IF TRAP A UNIT	
	1308(A~Z) CLARI BOARD			PB-PRINTED CIRCUIT BOARD	
				1309(A~Z) TRAP BOARD	

R-RESISTOR			26	16WV	10 μ F
1	$\frac{1}{4}$ W	1.5K Ω	21	16WV	22 μ F
			2	16WV	100 μ F
C-CAPACITOR					
DIPPED MICA					
1,2	500WV	1500PF	6m CONVERTER UNIT		
			PB-PRINTED CIRCUIT BOARD		
			1305(A~Z) 6m BOARD		
T-TRANSFORMER					
123	TRAP COIL				
			Q-TRANSISTOR & FET		
			1	3SK40M	
			3	2SK19GR	
			2	2SC372Y	
IF TRAP B UNIT					
PB-PRINTED CIRCUIT BOARD					
1309(A~Z) TRAP BOARD					
			D D-DIODE		
R-RESISTOR			1	Zener	WZ090
1	$\frac{1}{4}$ W	820 Ω			
			X-CRYSTAL		
VR-POTENTIOMETER			1	HC-25/U	22 MHz
1	10 ϕ	500 Ω B			
			R-RESISTOR		
C-CAPACITOR			17	$\frac{1}{4}$ W	68 Ω
DIPPED MICA			7,14-16	$\frac{1}{4}$ W	100 Ω
1,2	500WV	700PF	6,11	$\frac{1}{4}$ W	220 Ω
			10	$\frac{1}{4}$ W	470 Ω
T-TRANSFORMER			8,13	$\frac{1}{4}$ W	3.3K Ω
124	TRAP COIL		3	$\frac{1}{4}$ W	8.2K Ω
			9	$\frac{1}{4}$ W	10K Ω
			1,2,4	$\frac{1}{4}$ W	56K Ω
			5,12	$\frac{1}{4}$ W	100K Ω
FM UNIT					
PB-PRINTED CIRCUIT BOARD					
1269(A~Z)			C-CAPACITOR		
			DIPPED MICA		
Q-TRANSISTOR & IC			3	500WV	2PF
1-5	2SC372Y		1	500WV	12PF
6	TA 7061AP		4,11,9	500WV	15PF
			5,12,13	500WV	20PF
D-ODE			20	500WV	30PF
1-4	Ge	1S188FM	17	500WV	60PF
5	Zener	AW0109	2,16	500WV	70PF
			10	500WV	300PF
R-RESISTOR			CERAMIC DISC		
10	$\frac{1}{4}$ W	22 Ω	6,7,8,14,15,18,19	50WV	0.01 μ F
18	$\frac{1}{4}$ W	220 Ω			
24	$\frac{1}{4}$ W	470 Ω			
6	$\frac{1}{4}$ W	680 Ω			
2,16	$\frac{1}{4}$ W	1K Ω	2m CONVERTER UNIT		
8,9,21,23	$\frac{1}{4}$ W	2.2K Ω	PB-PRINTED CIRCUIT BOARD		
13	$\frac{1}{4}$ W	3.3K Ω	1306(A~Z) 2m BOARD		
1,20	$\frac{1}{4}$ W	4.7K Ω			
5,7,11,12	$\frac{1}{4}$ W	10K Ω	Q-TRANSISTOR & FET		
4	$\frac{1}{4}$ W	15K Ω	1	3SK40M	
17	$\frac{1}{4}$ W	22K Ω	2	2SK19GR	
25	$\frac{1}{4}$ W	33K Ω	3	2SC372Y	
14,15	$\frac{1}{4}$ W	47K Ω	4	2SC710D	
3	$\frac{1}{4}$ W	56K Ω			
19,22	$\frac{1}{4}$ W	330K Ω	D-DIODE		
26	$\frac{1}{2}$ W	100 Ω	1	Zener	WZ090
			2	Si	1S1555
C-CAPACITOR			X-CRYSTAL		
DIPPED MICA			1	HC-25/U	38.666MHz
9	500WV	30PF			
10	500WV	150PF	R-RESISTOR		
6	500WV	200PF	15,18,19	$\frac{1}{4}$ W	100 Ω
7,8	500WV	300PF	6,10	$\frac{1}{4}$ W	220 Ω
CERAMIC DISC			9	$\frac{1}{4}$ W	470 Ω
14,16	50WV	0.001 μ F	14	$\frac{1}{4}$ W	1K Ω
17,20	50WV	0.01 μ F	8,13,17	$\frac{1}{4}$ W	3.3K Ω
4,11-13,15,18,23	50WV	0.047 μ F	3,7,11	$\frac{1}{4}$ W	10K Ω
W MYLAR			12	$\frac{1}{4}$ W	15K Ω
19,22	50WV	0.0047 μ F	1,2,4	$\frac{1}{4}$ W	56K Ω
5,24	50WV	0.1 μ F	5,16	$\frac{1}{4}$ W	100K Ω
ELECTROLYTIC			C-CAPACITOR		
1,3	16WV	1 μ F	DIPPED MICA		
25	16WV	4.7 μ F			

1	500WV	3PF	
15	500WV	8PF	
11	500WV	10PF	
2.6.7.10.17	500WV	20PF	
18	500WV	30PF	
CERAMIC DISC			
12	50WV	0.001 μ F	
3-5.8.9.13.14.16.19	50WV	0.01 μ F	
T-TRANSFORMER			
201	ANT	COIL	
202~206	BPF	COIL	
207	OUTPUT	COIL	
208	OSC	COIL	
209	BUFF	COIL	
210	AMP	COIL	



Provided by
<http://www.yaesu-museum.com>

Downloaded by
Amateur Radio Directory