

FT-109RH OPERATING MANUAL



YAESU MUSEN CO., LTD.
C.P.O. BOX 1500
TOKYO, JAPAN

TABLE OF CONTENTS

§1 SPECIFICATIONS	2
§1.1 GENERAL	2
§1.2 RECEIVER	2
§1.3 TRANSMITTER	2
§1.4 SUPPLIED ACCESSORIES	3
§1.5 OPTIONS	3
§2 CONTROLS & CONNECTORS	4
§2.1 TOP PANEL	4
§2.2 FRONT PANEL & KEYPAD	6
§2.3 SIDE PANEL AND BOTTOM	11
§3 BATTERY PACKS AND CHARGERS	12
§3.1 BATTERY REMOVAL AND REPLACEMENT	13
§3.2 BATTERY CHARGERS	14
§3.3 YH-2 HEADSET & MH-12A2B SPEAKER/MIC	16
§3.4 ANTENNA CONSIDERATIONS	17
§3.5 FTS-6 TONE SQUELCH UNIT INSTALLATION	18
§3.6 MEMORY BACKUP INFORMATION	19
§4 OPERATION	20
§4.1 BASIC KEYPAD FUNCTIONS	21
§4.1.1 Frequency Entry	24
§4.1.2 Storage & Recall of Frequencies in Memory	25
§4.1.3 Repeater Operation (standard shift)	26
§4.1.4 Frequency/Memory Stepping and Basic Scanning	27
§4.1.5 Basic Priority Channel Operation	28
§4.2 ADVANCED FUNCTIONS	30
§4.2.1 Power Saving	30
§4.2.2 Calling Channel Mode	32
§4.2.3 Selected Memory Scanning, Masking & Deleting	32
§4.2.4 Limited Band/Programmable Step Scanning	33
§4.2.5 Odd Repeater Shifts & Split-Freq Memories	35
§4.2.6 Multi-channel Priority Scanning	36
§4.2.7 Tone Squelch Programming	37

YAESU FT-109RH
DUAL CPU-CONTROLLED
220 MHz FM HANDIE TRANSCEIVER

The FT-109RH FM Hand-Held incorporates the latest advances in microprocessor design and microminiature manufacturing to provide a wealth of features for the 220 MHz band. The high power mode provides 5 watts RF output in selectable 5 or 10kHz channel steps. Twenty dual-function keys on the front panel give the operator 39 different commands for programming the two 4-bit microprocessors at the heart of the FT-109RH. Each of ten memory channels allows the operator to store independent transmit and receive frequencies, for any repeater shift in any channel, with touch-key reverse or simplex on either frequency.

Scanning capabilities include step-programmable full or partial band or memory scanning for clear or busy; select channel exclusive scanning; calling channel, select memory or dial priority scanning/monitoring, and other unique yet useful functions too numerous to list, but all programmable from the front panel keypad. With all of these functions operation remains simple: the CPU's do the work for you, keeping keystrokes to a minimum.

Operational battery charge life can be greatly extended over standard squelched reception when monitoring, with Yaesu's programmable Power Saver System, which only activates the receiver to check the selected channel momentarily at programmable intervals.

A front panel multimeter indicates battery condition or signal strength and relative transmitter output power, with a side panel lamp button for easy viewing in the dark. The fat 1/4-inch high frequency digits on the LCD are complemented by ten memory indicators and nine other special function indicators, so the operator knows the exact status of all transceiver functions at a glance.

When the optional FTS-6 Tone Squelch Unit is installed, any of 37 CTCSS tones may be selected from the keypad and stored in the memories, with the particular tone stored in each channel indicated on the display along with the stored frequency and memory channel number. The state of the Tone Squelch (encode only, encode/decode or off) may also be programmed and stored in each memory. A DTMF encoder is also included.

§1 SPECIFICATIONS

§1.1 GENERAL

Frequency range:

220 to 224.995 MHz

Channel steps:

5 or 10 kHz (selectable);
programmable for scanning

Mode of emission:

F3 (G3E)

Antenna connection:

BNC (YHA-22 rubber duck supplied)

Supply voltage:

6-15 VDC

Supply current (mA @12VDC):

Receive: 175

Squelched: 40

Power Save: 12-25

Transmit: High- 1200, Low- 400

Case Size (WHD):

65 x 168 x 34 mm

Weight (grams, approx.):

616 w/FNB-4

§1.2 RECEIVER (@12VDC)

Circuit type:

Double conversion superheterodyne

Intermediate frequencies:

21.6 MHz and 455 kHz

Sensitivity:

0.25uV for 12dB SINAD;

1uV for 30dB S+N/N

Selectivity (kHz, -6/-60dB):

±7.5/±15

Audio Output (for 10% THD):

450 mW into 8 ohms, or better

§1.3 TRANSMITTER (@12VDC)

RF Power Output (w/ 50-ohm load):

5 watts (High), 0.5 watts (Low)

Modulation method:

Variable reactance

Maximum deviation:

±5 kHz

Maximum bandwidth (-60dB):

16 kHz

Spurious emissions:

-55 dBc or better

Microphone type (internal):

condenser, 2 kilohms

Specifications subject to change without notice.

§1.4 SUPPLIED ACCESSORIES

YHA-22(A) Rubber Flex Antenna

DTMF Generator Keypad

§1.5 OPTIONS

FNB-3 425 mAh Ni-Cd Pack

FNB-4 500 mAh Ni-Cd Pack

FBA-5 Dry Cell battery case (for 6 AA cells)

CSC-10 Soft Case (for 109RH w/FNB-3 or FBA-5)

CSC-11 Soft Case (for 109RH w/FNB-4)

FTS-6 Tone Squelch Unit

YH-2 Headset

MH-12A2B Speaker/Microphone

NC-9B/C 117/220 VAC Compact Charger (for FNB-3)

NC-18B/C 117/220 VAC Compact Charger (for FNB-4)

NC-15 Quick Charger/DC Supply

PA-3 DC Car Adapter/Trickle Charger

MMB-21 Mobile Hanger Bracket

Note: certain options may be included as standard accessories according to local needs or popularity.

§2 CONTROLS & CONNECTORS

§2.1 TOP PANEL

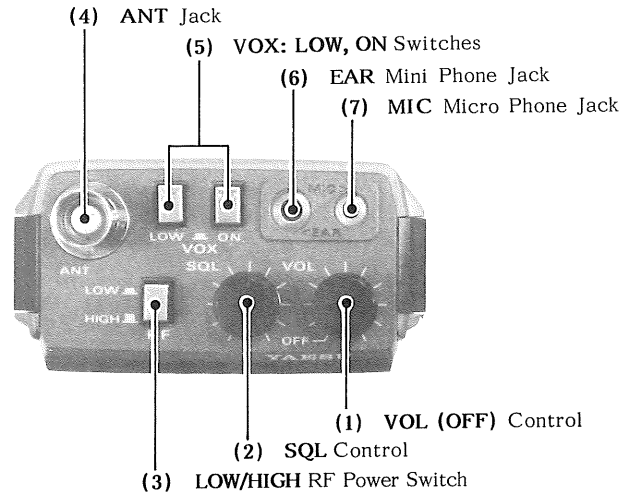

(1) VOL (OFF) Control

This is the receiver volume control and power on/off switch for the FT-109RH. Set this control fully counterclockwise into the OFF click-stop when the transceiver is not in use.

(2) SQL Control

This control sets the threshold level at which received signals (or noise) will open the squelch. Whenever the squelch is open, the green BUSY LED on the front panel will be illuminated. When the optional FTS-6 Tone Squelch Unit is installed and activated as a decoder, this control sets the threshold at which the BUSY LED will light and the scanner stop, if activated.

(3) LOW/HIGH RF Power Switch

This two-position push button switch selects the RF output power of the transmitter: approximately 500mW when the switch is depressed, or 5W when not depressed. The LOW position provides extended battery life when high power is not necessary for maintaining communication.

(4) ANT Jack

This BNC connector is for the supplied YHA-22 rubber flex antenna or other antenna system which presents 50 ohms impedance at the operating frequency. Do not transmit unless a proper antenna is connected to this jack.

(5) VOX: LOW, ON Switches

These two switches are disabled except during VOX (voice-actuated receive/transmit switching) operation with the optional YH-2 Headset. When the YH-2 is connected to the EAR & MIC jacks, the ON button activates VOX operation and the LOW button selects decreased VOX sensitivity, to prevent ambient noise from keying the transmitter.

(6) EAR Mini Phone Jack

This jack provides an auxiliary audio output from the receiver, for an external earphone, the optional MH-12_{A2B} Speaker Microphone or the YH-2 Headset. When this jack is used the speaker in the transceiver is bypassed.

(7) MIC Micro Phone Jack

This jack accepts auxiliary transmitter audio from an external 2-kilohm condenser microphone such that in the MH-12_{A2B} Speaker/Mic or YH-2 Headset. The internal microphone is bypassed when a plug is installed in this jack.

S2.2 FRONT PANEL & KEYPAD

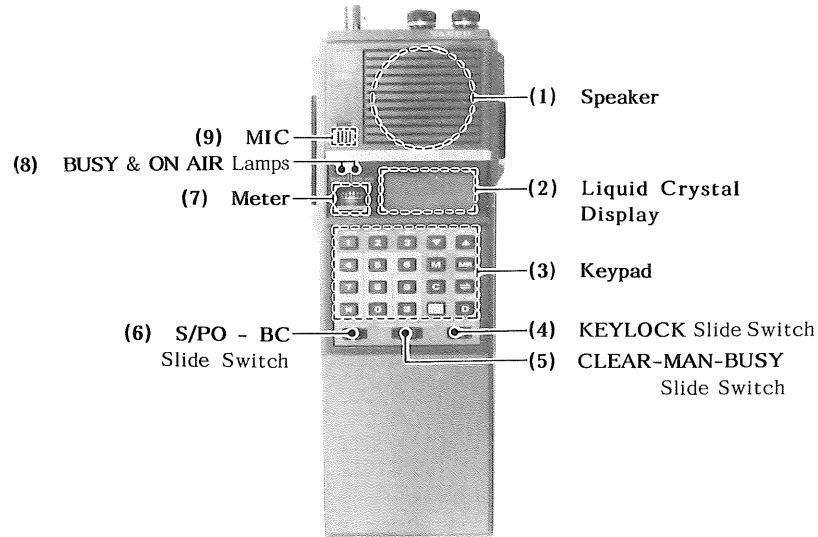

(1) Speaker

Behind the grill at the top of the front panel is a 36mm diameter speaker.

(2) Liquid Crystal Display

This display shows the last four digits of the operating frequency and a variety of information regarding any special functions that may be activated.

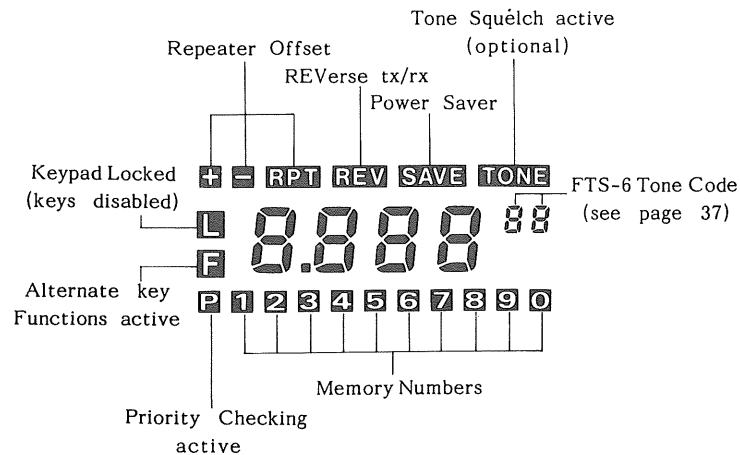



(3) Keypad

During reception, these twenty keys select the frequency and various special functions of the FT-109RH. The labels on the faces of the keys indicate their primary functions, while the label on the panel just above each key indicates the alternate function, activated by pressing the yellow [F] key first. Pressing the [F] key causes an 'F' to appear to the left of the frequency on the display for three seconds, during which time the alternate functions of the other keys are active.

During transmission, the leftmost 16 keys are active as a DTMF encoder. All keypad operation is disabled unless the KEY LOCK switch below the keypad is set to the left (off).

The primary function of each key during reception is described briefly below. Alternate key functions are described later in the Operation section of this manual. For descriptive purposes in this manual, all key label references are enclosed in square brackets []. Primary key functions are referred to by the labels on the key faces, except as follows:

 and  are referred to as [Up] and [Down] arrow keys

 is referred to as the [SWAP] key

Alternate key functions are referred to by the label above each key, prepended by '[F]+' to remind you to press the [F] key first. For example, '[F]+[UP]' indicates that you should press the [F] key followed by the  key (within three seconds). Key functions are summarized on the FT-109RH Handie Reference Card.

Numbered keys

The numbered keys are used to select frequencies, either digit-by-digit (by pressing [D] last), or by recalling a memory (by pressing [MR] after the memory number 0-9).

[Up] and [Down] Arrow Keys

Press these keys momentarily to increment or decrement the operating frequency one step. Press and hold the key in for more than one second to engage the scanner. If pressed while operating on a memory, stepping and scanning will be through the memories.

[M] Memorize

This key stores the displayed frequency into a memory if the memory number (only) is pressed prior to this key. Otherwise, if only this key is pressed when operating in the dial mode, the numbers of the memories which currently have data stored will be displayed briefly below the dial frequency.

[MR] Memory Recall

This key recalls a memory if the memory number is pressed prior to this key. Otherwise, if only this key is pressed when operating in the dial mode, the last-used memory will be recalled. In either case, the number of the recalled memory will be displayed below the channel frequency. If an invalid channel number (>9) is keyed in first, **Err** will be displayed briefly, and operation will remain unchanged. Operation on a memory is referred to as the 'Memory Mode', as opposed to the 'Dial Mode', where operating data is not stored in a numbered memory.

[D] Dial Mode

After keying in a frequency on the keypad, press this key to 'enter' the displayed data into the CPU and execute the change in receiving frequency. Prior to pressing this key one of the display digits should be blinking. After pressing this key the blinking will cease and the MHz decimal will appear. If this key is pressed while receiving on a memory, operation will shift to the last frequency used in the dial mode and the memory number below the frequency display will disappear. Note that the dial mode functions as a special-purpose un-numbered memory.

[C] Clear Error

The CPUs in the FT-109RH have been programmed to recognize most of the possible errors that can be made at the keypad, and thus will automatically return to normal operation after briefly displaying **Err**. However, if an undesired digit is accidentally pressed during operation or keypad entry, this key can be used to cancel the (last) key command.

[SWAP]

During split frequency (repeater) operation, this key allows instant exchanging of the transmit and receive frequencies.

[*] Call Channel Recall

This key instantly recalls Call channel memory 0, regardless of the last operating mode. Thus if the local calling channel is programmed in memory 0, it can be accessed quickly with just a single key. When the call channel function is active the right-most frequency digit on the display will be replaced with a 'C'. Press [D] or [MR] to exit calling channel operation.

[#] Priority Monitor

Press this key to activate the priority channel monitor function, in which the receiver samples the (last) selected memory channel for activity periodically while operating in the Dial mode. The display will show a small 'P' in the lower left corner, while the number of the channel being checked will blink below the operating frequency. If a signal appears on the priority check frequency that is strong enough to open the squelch, the checking function will be cancelled and operation will automatically shift to the priority frequency. Otherwise, press the [D] or [MR] key to cancel priority monitoring and stay on the Dial frequency.

(4) KEYLOCK Slide Switch

Setting this switch to the right disables the keypad, preventing inadvertent key entry. When the keypad is locked an 'L' is displayed to the left of the frequency. Slide this switch to the left to activate the keypad.

(5) CLEAR-MAN-BUSY Slide Switch

This 3-position switch selects the scan stop mode for the scanning functions. When set to the center (MAN) position, scanning stops when the [Up] or [Down] arrow key is released. When set to the CLEAR position, scanning stops whenever the squelch closes (ie., on a clear channel). When set to the BUSY position, scanning stops whenever the squelch opens (ie., on a busy channel).

(6) & (7) Meter and S/PO - BC Slide Switch

The function of the meter is determined by this slide switch. When set to S/PO, the meter indicates relative received signal strength during reception, and relative transmitter power output when transmitting (the numbered meter scale is for relative comparisons only). When set to BC the meter indicates the condition of the battery. A weak battery is indicated when the meter indicates in the green zone during high power transmission.

(8) BUSY & ON AIR Lamps

The green BUSY indicator is lit whenever the squelch is open during reception. This is normally due to the presence of a signal on the channel, but can be caused by noise if the SQL control is set too far counterclockwise.

The red ON AIR indicator is lit when transmitting. If it does not light when the PTT button is pressed, battery condition should be checked on the meter.

(9) MIC

Behind this small grill is a 2-kilohm condenser microphone.

§2.3 SIDE PANEL AND BOTTOM

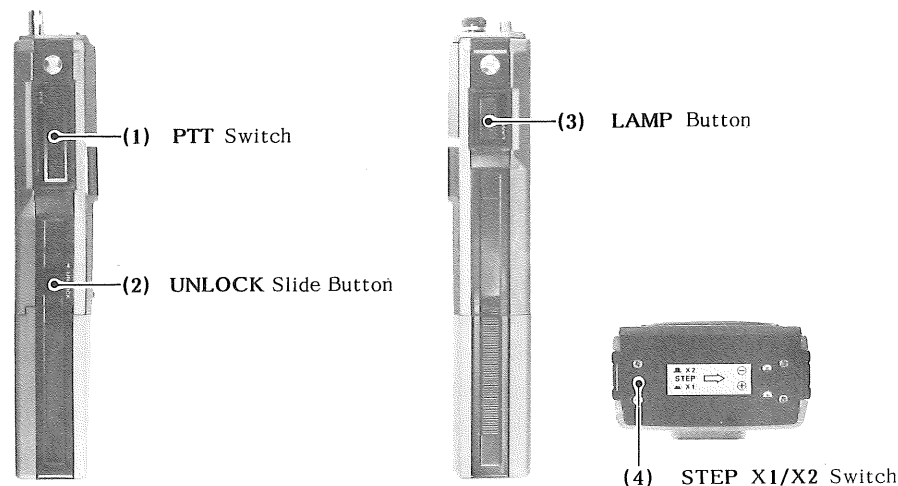

(1) PTT Switch

Press the PTT switch on the left side of the transceiver to transmit, and release it to receive. The red ON AIR lamp should be lit while this switch is depressed.

(2) UNLOCK Slide Button

To remove the battery pack, hold this button upwards to release the safety catch and allow the battery to be slid (to the left) out of its mounting track.

(3) LAMP Button

Press this button on the right side of the transceiver to turn on the lamp illuminating the meter and display, when ambient light is insufficient.

(4) STEP X1/X2 Switch (in battery mounting track)

This recessed two-position push button switch is accessible with a pointed instrument through the square hole in the battery mounting track when the battery pack is removed from the transceiver, and allows selection of the size of the channel steps. 5kHz steps are selected when the switch is in the depressed position, and 10kHz steps when the switch is in the undepressed position.

§3 BATTERY PACKS & CHARGERS

The following battery packs are recommended for use with the FT-109RH:

- FNB-3 10.8V 425mAh Ni-Cd Battery Pack
- FNB-4 12V 500mAh Ni-Cd Battery Pack

Also available is the FBA-5 Battery Case for 6 AA-size dry cells (non-rechargeable, batteries optional).

In some countries, one or more of the above may be supplied with the transceiver. If not, contact the nearest Yaesu dealer. We do not recommend the use of any other type of battery with the FT-109RH, and using another type may affect your warranty.

The FNB-3 and FNB-4 are both rechargeable, either while attached to the transceiver or separately, using the battery chargers described on the following pages. Each Ni-Cd pack should be fully charged before it is used with the transceiver for the first time. Note that the chargers required for the FNB-3 (except for the NC-15) are different than those for the FNB-4, because of the difference in battery voltage.

RF power output from the transmitter will differ according to which type of battery is used, with the FNB-4 providing the highest output and the FBA-5 with fresh dry cells providing about 20% less output.

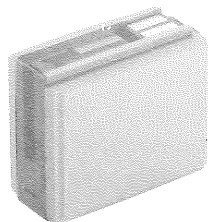

FNB-3

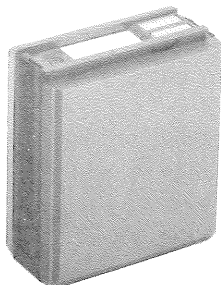

FNB-4

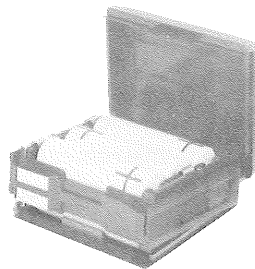

FBA-5

§3.1 BATTERY REMOVAL & REPLACEMENT

1. Make sure that the **VOL** control is set into the **OFF** click-stop, and remove the protective soft or hard case, if used.
2. Grasp the upper portion of the transceiver with your left hand, so that your palm is over the speaker and your left thumb is on the ◀**UNLOCK** button.
3. Move the ◀**UNLOCK** button in the direction indicated by the small arrowhead, while using your right hand to slide the battery case toward the side with the ◀**UNLOCK** button. The battery case should slide smoothly out of its track.
4. If using the FBA-5 battery case and dry cells, they can be removed from the case by placing both of your thumbs on the mounting tracks on top of the case and gently prying the tracks apart. Although both sides must be opened to change the cells, only one side must be opened at a time, to avoid damage to the hinges. First install or replace the three cells in one side, and then close that side, open the other side, and install or replace the other three cells. Always replace all six cells.
5. To replace the battery case or Ni-Cd pack, repeat steps 2 and 3 above, simply sliding the battery case in the other direction after aligning the shorter side of the battery case with the track below the ◀**UNLOCK** button.

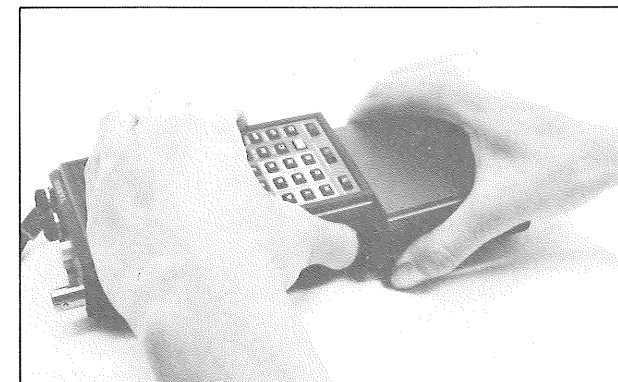

§3.2 BATTERY CHARGERS

NC-9B/C

The NC-9B (117VAC) and NC-9C (220–234VAC) are compact chargers for recharging the FNB-3 Ni-Cd pack from the AC line. A completely discharged pack requires approximately 15 hours to recharge with the NC-9B/C. Do not attempt to charge the FNB-4 with the NC-9B/C.

NC-18B/C

The NC-18B (117VAC) and NC-18C (220–234VAC) are compact chargers for recharging the FNB-4 Ni-Cd pack from the AC line. A completely discharged pack requires about 15 hours to recharge with the NC-18B/C. Do not attempt to charge the FNB-3 with the NC-18B/C.

It is not necessary to remove the battery pack from the transceiver when charging, but the transceiver can not be operated while the NC-9B/C or NC-18B/C is connected. Therefore it is advisable to keep an extra pack on hand so operation is not interrupted.

Do not attempt to recharge dry batteries used in the FBA-5.

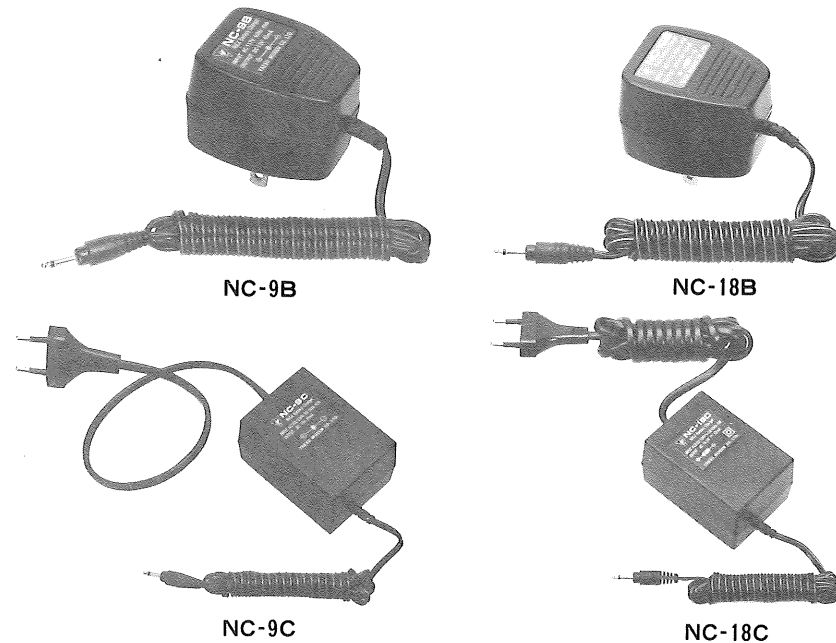

NC-15

The NC-15 is a battery charger/DC supply with quick and trickle charging modes. The quick mode is automatically selected initially, to bring the battery pack up to full charge as fast as is safely possible. The charger then automatically reverts to the trickle charge mode, to prevent self-discharge. The quick mode recharges a completely discharged FNB-3 in about 1 hour, or FNB-4 in about 1.5 hours.

The DC power supply function of the NC-15 allows the transceiver to be operated while also charging an attached battery pack.

PA-3

The PA-3 is a DC-DC adapter for use when operating the transceiver mobile. The PA-3 provides a constant trickle charge to the FNB-3 or -4, which helps to preserve battery charge life during operation. Use with 12-volt negative ground electrical systems only.

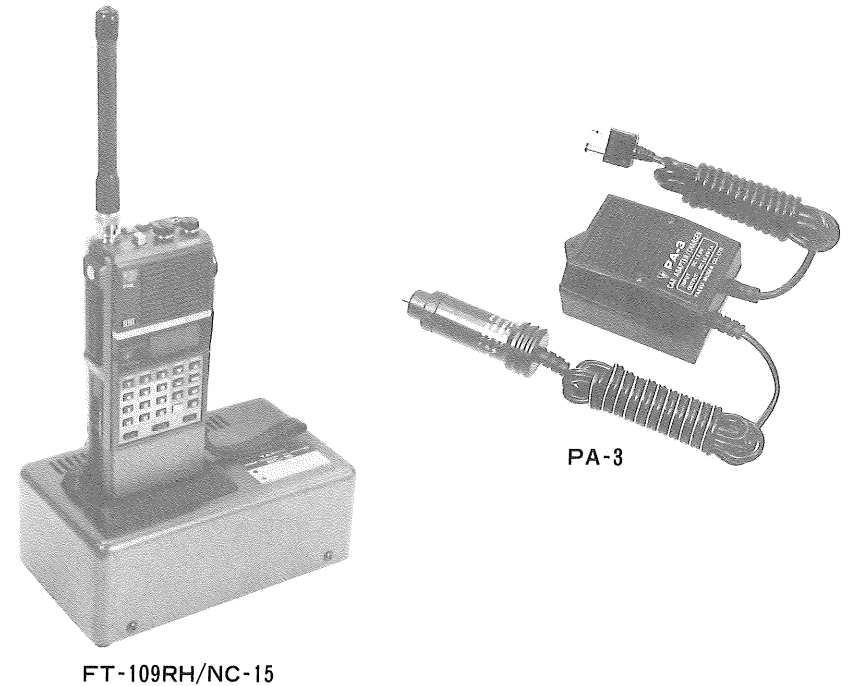

§3.3 YH-2 HEADSET & MH-12_{A2B} SPEAKER/MIC

Either of these optional accessories can be used to increase operating convenience and extend communications range and signal strength. Each is equipped with a dual plug connector which mates with the EAR and MIC jacks on the top panel of the transceiver, disabling the internal speaker and microphone. The connecting cable then allows the transceiver to be left clipped to the operator's belt, or to be held overhead above obstructions for improved performance, if necessary. For mobile operation with the MMB-21 Mobile Hanger, the transceiver can be left in the Hanger during transmission.

The MH-12_{A2B} Speaker/Microphone can be held close to the ear during reception; or if preferred, an external earphone can be connected to the transceiver via the speaker/mic plug, thereby attenuating the audio from the speaker in the MH-12_{A2B} speaker. To transmit, just hold the speaker/mic close to your mouth and close the PTT switch on the microphone.

The YH-2 Headset includes both a lightweight earphone and miniature boom microphone with a single headband, permitting totally hands-free operation of the transceiver when the VOX (voice-actuated transmit/receive switching) system in the transceiver is activated by pressing the VOX ON switch on the top panel. When in a normal, quiet environment, set the VOX LOW switch to the un-depressed (high) position, for maximum sensitivity of the VOX circuit. If in a noisy environment where extraneous sounds might trigger the VOX inadvertently, press the VOX LOW switch.

To transmit when using the YH-2 it is only necessary to speak. The boom microphone will pick up your voice, which will automatically activate the transmitter and be sent out over the air (watch what you say). To return to receive, just stop talking.

§3.4 ANTENNA CONSIDERATIONS

While the supplied YHA-22 rubber flex antenna provides great convenience for short-range portable operation, the standard BNC-type antenna connector on the transceiver allows for the use of higher gain antennas for extended range in base or mobile operation. However, any antenna connected to the transceiver must have an impedance close to 50 ohms throughout the operating frequency band. Also, if the antenna is to be connected with a feedline to the transceiver, high quality 50-ohm coaxial cable should be used.

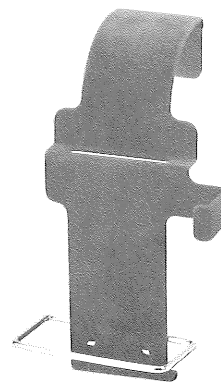

MMB-21



YH-2

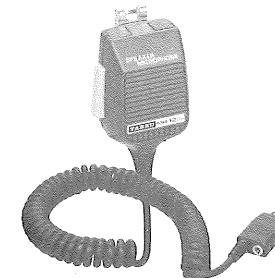

MH-12A2B

§3.5 FTS-6 TONE SQUELCH UNIT INSTALLATION

1. Make sure that the **VOL** control is set into the **OFF** position. Remove the hard or soft case, if used, from the transceiver, and remove the battery pack (§3.1).
2. Remove the four screws affixing the battery mounting track on the bottom of the transceiver, and carefully remove the track.
3. Locate the 1/8-watt, 27-kilohm resistor that is inserted in one side of the (otherwise empty) socket on the bottom of the transceiver, and pull the resistor out of the socket. It is not needed when the FTS-6 is installed, but will have to be replaced if the FTS-6 is later removed.
4. Make sure that all of the pins on the FTS-6 are straight, and position the FTS-6 so that the 8-pin side is aligned with the 8-pin side of the socket (the other side of the FTS-6 and socket has 7 pins). Gently press the FTS-6 into the socket, rocking the board back-and-forth a little at a time until the top of the IC is flush with the surrounding black plastic inner cover. Do not use a sharp object to press on the board, as this may damage the circuitry.
5. Replace the battery mounting track and its 4 screws, followed by the battery pack, which should fit as smoothly as before if the FTS-6 is properly seated.

See §4.2.7 for details of tone squelch operation.

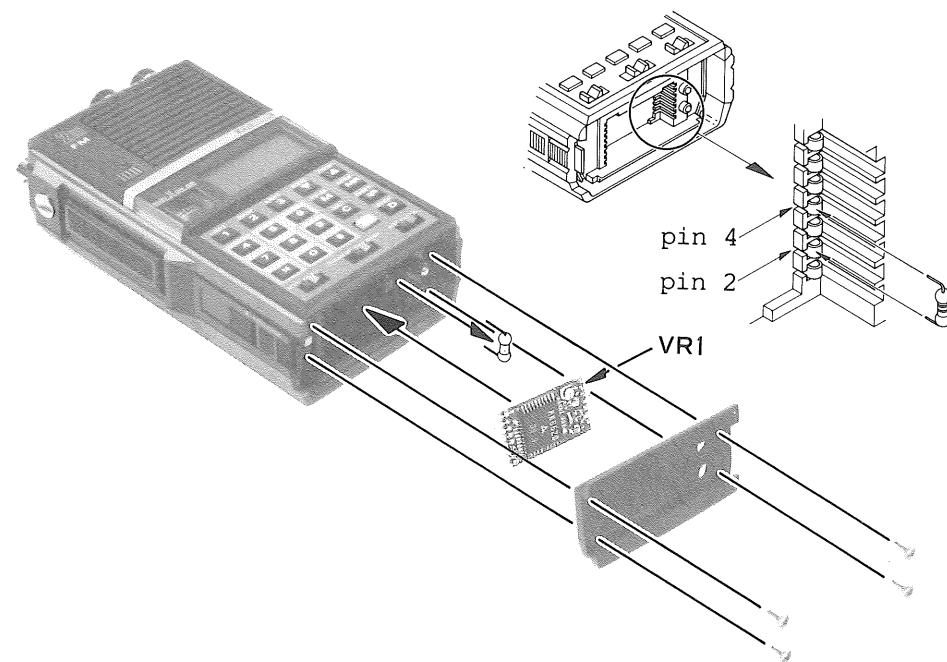

§3.6 MEMORY BACKUP INFORMATION

Most of the operating data programmed in the FT-109RH is retained in memory by an internal lithium cell even when the power is off and the battery removed. This backup cell has an estimated life-time of five years, after which time data may be lost when power is switched off. When that occurs, see your Yaesu dealer for installation of a replacement backup cell.

§4 OPERATION

Before You Start

Before operating the transceiver, make sure that the battery pack is fully charged if using the FNB-3 or FNB-4. Ni-Cd battery packs that have just been received from the dealer require full recharging before beginning operation. Also, before installing the battery pack (remove it if it is already installed), set the STEP X1/X2 switch on the bottom of the transceiver to the desired position for 5 or 10 kHz channel steps. If using the FBA-5 battery case, install 6 'AA' size batteries as described in §3.1.

Connect the YHA-22 rubber flex antenna to the antenna jack on the top of the transceiver. Never operate the transceiver without an antenna connected.

VOX operation using the YH-2 Headset is described in §3.3. For now, do not connect the YH-2 or the MH-12_{A2B} Speaker/Mic, and set both of the VOX buttons on the top panel to the undepressed position (until familiar with basic operation). Also on the top panel, press the RF button to select LOW power output.

On the front panel, beneath the keypad, set the left-hand (meter) switch to the S/PO position, the center (scan stop mode) switch to MAN, and the right-hand KEYLOCK switch to the left (off).

With the VOL control set into the click-stop (OFF), set the SQL control fully counterclockwise. Now rotate the VOL control out of the click-stop and adjust for a comfortable volume on the noise or received signal. If a signal is present, press either the [Up] or [Down] key at the upper right of the keypad, until a frequency is found where only noise is heard.

Rotate the SQL control clockwise just to the point where the noise is silenced and the green BUSY LED is extinguished. If the SQL control is set farther clockwise, sensitivity to weak signals will be reduced. Now, whenever a signal reaches the receiver strong enough to open the squelch, the BUSY LED will light.

To transmit, wait until the channel is clear (green BUSY LED off), then squeeze the PTT switch (on the side) and speak into the microphone (MIC on the front panel, just above the meter). During transmission the red ON AIR LED will light. If it does not, or becomes dim after several hours of operation, the battery pack should be recharged or batteries replaced (in the FBA-5).

Release the PTT switch to receive. If more power is required, press the RF button on the top panel so that it returns to the undepressed position. However, whenever communication is possible with low power, this button should be depressed to conserve battery life and minimize possible interference to other stations.

In certain locations, when received signals are weak or repeater access unstable, the signals may be improved by moving the transceiver: in general, the higher the better. The signal strength function of the meter is useful for determining the optimum position of the transceiver while receiving, which position will also be the best for transmitting. Either the YH-2 Headset or MH-12_{A2B} Speaker Microphone allow the transceiver to be help high overhead during operation. These accessories are described in §3.3.

When operating in the dark press the LAMP button to illuminate the display and meter.

§4.1 BASIC KEYPAD FUNCTIONS

This subsection describes the basic operating functions you will need regularly, while §4.2 covers special functions which you may need only occasionally.

Although the variety of keypad-programmable functions in the FT-109RH can seem formidable at first glance, basic operation is not complicated and requires only a few moments with the transceiver in hand. Once this has been learned you can select those particular functions that you wish to use right away, ignoring the functions that may be less useful in your particular case until last.

This manual presents the keypad programming functions in step-by-step procedures. Before reading this you may wish to review the descriptions of display segments and the primary functions of the keys in §2.2. Later, you can refer to the Handie Reference Card to refresh your memory, if necessary.

The following procedures assume that you have become familiar with the key and LCD segment locations and that you are acquainted with the following terms:

Calling Channel - a frequency usually set aside by fraternal agreement to be used only for establishing contact (after which stations QSY to another frequency). This assures operators of a frequency on which someone is (hopefully) always monitoring, yet which is never occupied for more than a few seconds. In the United States, 223.50 MHz has been designated by the ARRL as the National Simplex Calling Frequency. Memory 0 in the FT-109RH is intended for calling channel use.

DIAL - the primary operating mode of the transceiver when not operating on a "memory" channel. The DIAL mode has its own register in the CPU, and is backed up when power is off. The **D** key activates (accesses) this mode.

DTMF (Dual Tone Multi Frequency) - a push button audible tone signaling system often used for telephone dialling, in which each of the digits 0-9 and '*' and '#' are represented by two audible tones transmitted simultaneously when the key is pressed. The DTMF generator in the FT-109RH allows accessing the telephone system through repeaters equipped for autopatch.

Priority Channel Operation - a method of operation whereby the transceiver periodically checks a preselected frequency (the "priority" channel memory) momentarily for the presence of a signal while operating on another channel. The priority channel memory is checked only during reception, and operation automatically shifts to this memory if it becomes active.

Repeater Shift - the difference between the output (transmitting) and input (receiving) frequencies of a repeater. '+' shift signifies that the receiving frequency of the repeater is above its transmitting frequency, and '-' shift is vice-versa. Remember that you must transmit on the input and receive on the output frequency, though the FT-109RH allows reversing these, when required.

Tone Squelch - a subaudible tone system in which the transmitted voice signal has a subaudible (very low audio frequency) tone superimposed, and the receiver has a sharp audio filter (tuned to the same subaudible frequency) in its squelch circuit. The receiver squelch will open only when it receives a signal with the matching subaudible tone, regardless of other signals on the frequency. The FTS-6 Tone Squelch Unit is available as an option for the FT-109RH.

NOTICE: MEMORY RESET

The following procedures assume that no data has previously been entered into the FT-109RH, and all functions and memories are at their default values. To ensure that this is so, locate the small hole in the lower rear cover beside the belt clip, and gently press the point of a small sharp instrument into this hole when the power is switched on, to reset the memory of the CPUs. This can be done at any time to erase all data and return to the default settings, which are as follows:

Preset frequency - 223.5 MHz
Repeater shift - +/-1.6 MHz
Tone Squelch - w/FTS-6 option only, 88.5 Hz

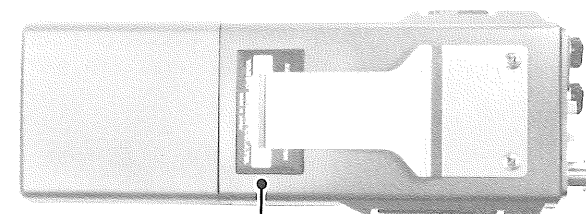

Access Hole

§4.1.1 Frequency Entry

1. To key in the digits of any frequency within the range of the FT-109RH, begin by pressing the MHz digit of the desired frequency (even if already shown on the display). This informs the CPU that you are entering new data, and it will respond by replacing the previous display data with the digit you pressed followed by three 0's, with the second one blinking.

Note that it is not necessary to enter the hundred and ten MHz digits, since the FT-109RH expects these to always be 2s; only the one MHz digit (0-4) should be entered. If the display shows something else press [C] (clear) and try again.

2. Next enter the 100's and 10's of kHz digits of the frequency you desire. After each entry the next digit on the display will blink. Finally, if a 5 kHz step is required, press [5].
3. The display should now show the frequency that you wish to enter, so you can now press [D] (Dial) to enter the new frequency in the Dial mode. If the display does not show the frequency you want, press [C] to cancel the last keystroke, and re-enter the desired digits. Pressing [C] more than once will cancel previous keystrokes in the reverse order that they were made, all the way back to the initial state of the transceiver. However, once [D] has been pressed the keyed in data becomes the operating frequency in the Dial mode, where the [C] key is deactivated.

EXAMPLE: to enter 225.550 MHz

Press [5] (the display will show 5000), and [5] again two more times. The display will then show 5550. Press [D] and the decimal will appear after the leftmost digit.

§4.1.2 Storage & Recall of Frequencies in Memory

1. To store a frequency in memory, first enter the desired frequency in the Dial mode as described above. Then press the desired memory number, from [0]-[9], followed by [M]. The memory number will appear briefly at the bottom of the display, confirming the action, but the transceiver will remain in the Dial mode. Go ahead, store a few frequencies. If you want to store repeater frequencies, enter the output frequency (the frequency you want to receive on) for now. Remember that when you store data in memory, the data previously stored in that memory (if any) will be erased.

EXAMPLE: To store 223.50 MHz in the CALL memory (0)

Press [3], [5] and [D] (it's now in the DIAL register), followed by [0] and then [M].

2. To recall any memory press the memory number followed by [MR]. The recalled memory number will appear at the bottom of the display, indicating that the transceiver is no longer in the Dial mode, but in the Memory mode. However, if you try to recall a memory that has nothing stored in it you will get an error indication.

Calling channel 0 is a special case: you need press only one key ([*]) to recall it. The last frequency digit will be replaced with a C, for the Calling Channel mode. Memory 0 has some other special features described later.

3. If you wish to check which memories are in use before storing new data, press [M] while in the Dial mode. The numbers of the memories which are occupied will appear for a second at the bottom of the display.

§4.1.3 Repeater Operation (standard shift)

1. Default repeater shift is +/-1.6 MHz, which may be easily changed from the keypad, as described later. For now, just check the standard shift by pressing [F]+[SHIFT]. The display will show **1.600** for a second.

Note: See §2.2 for a description of the yellow [F] key and the method used here to indicate alternate keypad functions.

2. To activate the standard repeater shift press [F]+[+RPT] or [F]+[-RPT], depending on which direction your transmit frequency is to be offset from your receiving frequency. + or - and RPT will appear on the display. If the transceiver is in the Dial mode, this shift will be applied to any new frequency that you may enter in this mode, or to any memories you may store. However, if you are in the Memory or Call modes, the repeater shift will only apply to the displayed memory frequency, and will be cancelled once you change modes or memories. To store the repeater shift in the memory channel, after recalling the memory and selecting the shift, just press [M] (the + or - sign on the display will disappear).

EXAMPLE: To program 222.34/223.94 into Memory 1

First, press [3], [9], [4] and [D] to enter the repeater output frequency (your receiving frequency) in the Dial mode. Then press [F]+[-RPT] to select the shift (to transmit below your receiving frequency). Finally, press [1] and [M] to store the works in memory 1. The transceiver will remain in the Dial mode, but you can press [1] and [MR] to check the memory. Note that the + or - sign is not displayed when repeater shift is stored in memory.

3. To cancel or change the direction of the repeater shift in the Dial mode, just press [F]+[SIMP] (to cancel), or [F]+[-RPT] or [F]+[+RPT]. Similarly, to cancel the shift in the Memory mode, press [F]+[SIMP]. This will be temporary (not stored in memory) unless you press [M]. Changing the direction of shift once it is stored in a memory is not so easy: you need to first press [F]+[SIMP] and [M] before pressing [F]+[+/-RPT] again and the other shift direction. Remember to press [M] if you want the change memorized.

4. One more repeater function that should be mentioned at this point is the reverse function, which exchanges the transmit and receive frequencies of the transceiver during repeater shift operation. To do this, press [SWAP]. REV will appear on the display, and the transmit and receive frequencies will be reversed. This key is especially handy for checking the direction of shift of a memory without the need to transmit. Just press [SWAP] twice.

§4.1.4 Frequency/Memory Stepping and Basic Scanning

1. Manual scanning is controlled by the [Up] and [Down] arrow keys. If the transceiver is in the Dial mode these keys will cause the frequency to step up or down from the initial frequency by the size of the tuning steps, determined by the position of the STEP switch on the bottom of the transceiver (§2.3).

If the transceiver is set to the Memory mode (a memory number is displayed below the frequency), pressing [Up] or [Down] will cause the frequency to move to the next higher or lower (occupied) memory. Here, "higher" and "lower" refer to the memory number (0-9), not the frequency stored there. Also, note that only those memories which actually have frequencies memorized will (or can) be checked. To determine which memories are occupied or empty, just press [M] when in the Dial mode. The numbers of the occupied memories will appear for a few seconds below the Dial frequency.

2. Holding an arrow key for more than a second will cause scanning to start. The condition under which scanning will stop is determined by the CLEAR-MAN-BUSY slide switch and the setting of the SQL control (unless the switch is set to MAN). If set to MAN, scanning stops whenever the arrow key is released. If the slide switch is set to CLEAR, the beeper will sound and scanning will stop (for about 3 seconds) whenever a frequency is reached where the squelch does not open, and then resume automatically. Conversely, if the slide switch is set to BUSY, scanning will stop briefly on frequencies where the squelch does open. While automatic scanning in either mode is paused, the decimal of the displayed frequency will blink.

Notice that the SQL setting determines the strength of received signals that will affect automatic scan stop functions, so it must be set carefully for the desired threshold before starting scanner operation. Also, while it is normally convenient to have the beeper activated, to signal when a key is pressed or when automatic scanning stops, this can be a nuisance when the automatic scanning stops often. To deactivate the beeper just press [F]+[B OFF], and [F]+[BEEP] to turn it back on.

Automatic scanning may be interrupted at any time, by pressing either [Up] or [Down] again, or by pressing [D] (if in the Dial mode) or [MR] (if in the Memory mode), or the PTT switch. If the PTT switch is used for this, the transmitter will not be activated unless the PTT switch is released first, and then pressed again.

§4.1.5 Basic Priority Channel Operation

1. To check for activity on a memory frequency while receiving in Dial mode, first preset the SQL control for the desired threshold level. If the frequency to be checked is already stored in a memory, just press [MR] to recall it. Otherwise, go ahead and store it in a memory as described in §4.1.2, and then press [MR] to recall it.
2. Once the memory to be checked has been recalled, press [D] to change to the Dial mode, and enter the frequency you wish to operate on while the memory frequency is being checked. Of course you can also use repeater shift. Now press [#] to activate priority checking: a small P will appear at the lower left corner of the display, and the memory number of the priority channel will blink. Every 3 seconds the displayed frequency will briefly change from the Dial frequency (on which you are operating) to the priority channel frequency, and then back.
3. You can go ahead and operate in the Dial mode as you normally would (transmit, change frequency, scan, etc.), until a signal above the squelch threshold appears on the priority channel is received, at which time the operating frequency will automatically shift to the priority channel memory. If you were in

the middle of a QSO in the Dial mode, you may need to press [D] to go back to that frequency and inform the other station that you received a call (in which case just press [MR] to return to the priority channel).

4. Priority operation can be terminated manually at any time by pressing [D], [MR] or [*], depending on which mode is desired for consequent operation.

This concludes the description of the basic functions of the FT-109RH. The next section describes specialized functions useful for particular types of VHF FM operation and local requirements. Before proceeding, please take time to become thoroughly familiar with the above functions, which must be clearly understood to make full use of the specialized functions.

§4.2. ADVANCED FUNCTIONS

Once the basic functions described on the previous pages are clearly understood, the operator may select from the following those special functions that he may require for his particular operating requirements.

§4.2.1 Power Saving

This function allows the FT-109RH to monitor a frequency for activity while drawing less current than is required for normal squelched reception. This is done by removing power from all circuits (except a timer and the display) for programmable intervals, during which "SAVE" will be displayed along with the frequency data. Between 'save' intervals, the receiver will be enabled for about 300ms to check the preselected frequency for activity. When a signal appears the receiver will function normally. However, if the carrier drops for more than five seconds, power saving will resume automatically. If the PTT switch is closed at any time during power saver operation, the transmitter will activate as usual. If no station responds to the transmission within five seconds after releasing the PTT switch, power saving will resume.

1. Before activating the power saver, set the transceiver to receive on the desired frequency to be monitored, which may be in any of the Dial, Memory or Call modes. Make sure that the **SQL** control is set to the desired threshold (the **BUSY LED** must be off), and then press [F]+[SAVE]. Note that the power saver is not deactivated by switching the transceiver power off (although it is of course disabled). To deactivate it, press [F]+[S OFF] (or reset the CPUs) when the transceiver is on.
2. In its default state the power saver provides a 1:2 duty cycle ratio (300ms receive, 600ms save). This ratio can be reprogrammed by the user for 1:1 to 1:10 by selecting multiples of 300ms, from one to ten, for the 'save' time. Press the numbered key corresponding to the desired multiple ([0] for x 10, or 3 seconds save), and then [F]+[SAV T]. This can be done regardless of whether the save function is on or off. The chart on the following page shows the various selectable save intervals.

EXAMPLE: to program 300ms receive, 1.5 seconds save

Press [5] and then [F]+[SAV T] (300ms x 5 = 1500ms, or 1.5 sec). Then set the **SQL** control to the point where the **BUSY lamp** just turns off, and press [F]+[SAVE] to activate the power saver, if not already on ("SAVE" shown on display).

Notice that the keypad has priority over the power save function; whenever a key is pressed the save cycle will be interrupted, and will not resume until five seconds after all entries are finished. However, if the power saver is active when the power is switched off, "SAVE" will be displayed for three seconds whenever power is switched back on, to let you know it is activated.

POWER SAVER INTERVALS

Key Code	Save Time (T_1)	Save/Receive Ratio (T_1/T_2)
[1]	300 ms	1:1
[2]	600 ms (default)	2:1
[3]	900 ms	3:1
[4]	1200 ms	4:1
[5]	1500 ms	5:1
[6]	1800 ms	6:1
[7]	2100 ms	7:1
[8]	2400 ms	8:1
[9]	2700 ms	9:1
[0]	3000 ms (3 sec)	10:1

Note: Receive Sampling time T_2 is always 300 ms

§4.2.2 Calling Channel Mode

This function was introduced in §4.1 as a memory channel (0) with a special single-key ([*]) recall capability. The [*] key activation of the Calling Channel makes this really a mode of its own, independent from the Dial or Memory modes. Therefore, even though the default frequency (223.500 MHz) is present in the Calling Channel when the CPUs are reset, it cannot be recalled as memory 0 by pressing [0] and [MR] until this (or another frequency) has been memorized in the usual manner.

Although any frequency stored in memory 0 will always be the same as that of the calling channel, the way that frequency is recalled (with [*] or with [0] and [MR]) will determine how the frequency is displayed (with or without a "C") and how it can be used.

If the calling channel is to be used for priority channel checking, it must be manually stored in memory 0 as would any other memory, and then recalled before activating priority operation. In this case, do not use [*] to recall it: treat it like any other memory. Pressing [*] during priority channel checking will cancel that function and operation will shift to the calling channel.

Some of the following special memory functions do not include memory 0, to protect the programmed calling channel frequency from accidental erasure.

§4.2.3 Selected Memory Scanning, Masking and Deleting

In addition to the memory scanning function described in §4.1.4 it is possible to select only certain memories for scanning without having to erase the others.

1. To mask a memory, press the memory number followed by [F]+[MSS] (memory scan skip). The beeper will sound three times, and the display will show (for a few seconds) the numbers of all memories that are currently included for scanning, plus the memory that has just been masked, the number of which will blink. Although the masked memory will no longer be included in memory scanning, it can still be recalled manually by pressing the memory number and [MR].

2. The memories included in the selected memory scan can be checked at any time by pressing [M] twice while in the Dial mode (the first press causes the display to show the numbers of the occupied memories, and the second press will show only those included in the selected scan). Scanning of the selected memories is activated and deactivated from the Memory mode with the up and down arrow keys (§4.1.4).
3. To reinstate a memory that has been masked from memory scanning, stop the scanner (if active), and then press the number of the memory followed by [MR] and [M].
4. To delete a memory without entering a new frequency, press the memory number and [MR] to recall it, then press the memory number again, followed by [F]+[MC], and [D]. This is useful if more than just the frequency is being stored.

§4.2.4 Limited Band/Programmable Step Scanning

It is possible to scan the frequencies between any two adjacent memories, using the PMS (Programmable Memory Scan) function. The steps of the scanner can also be programmed in this mode, in multiples of the basic step up to x 10.

1. To scan upwards or downwards from a memory channel, press the number of that memory followed by either [F]+[PMS up] or [F]+[PMS down], according to the desired scanning direction. The number of the memory keyed in and also that of the next higher or lower memory will be displayed (data must have been stored previously in both memories). Hold the last key down for a second to start scanning, which will continue in the selected direction (if uninterrupted) until it reaches the frequency of the programmed limit, and then jump back to the starting memory frequency. As usual, scanning can be interrupted automatically by busy or clear channel conditions, or manually with [D] or [*], or the PTT switch.

Note that memory 0 may be included in the above scanning functions, in which case its relative position is above memory 9 and below memory 1. Also note that although it is necessary

that both memories used in this scanning mode have data previously stored, it is possible to use memories that have been programmed for omission from standard memory scanning: their status for that purpose will be unchanged.

Once the initial PMS memory channel and direction have been selected, even though operation may be changed to the Dial or Memory modes on other frequencies, or power switched off, the PMS memory and direction will be retained in memory and can be recalled at any time with only [F]+ either PMS key. The two memories originally used will be displayed, and the scan direction will be that originally programmed: not that indicated by the PMS key just pressed.

2. The steps of the scanner during PMS operation can be programmed from the Dial, Memory or Call mode, by pressing the numbered key corresponding to the multiple of 5 kHz that will provide the desired scanning step ([0] = x 10).

EXAMPLE: 50 kHz scanning steps

Press [0], and [F]+[STEP]. Note that the [0] key is used for times 10. Press [F]+[STEP] to confirm the new steps.

As with PMS memories and direction, PMS steps are retained permanently during other modes of operation (though they are not applicable to other scanning modes), and when power is off.

3. One additional function that comes in handy especially when making use of the PMS system is memory swapping, whereby any two memories (excluding channel 0) can be exchanged. To do this, just press the number of one memory followed by [MR], the other memory number, and [M].

You can activate PMS scanning and priority channel checking at the same time. To do this, first recall the memory for priority checking and set the squelch as required. Then press [#] to activate priority operation (the display will show the Dial frequency, which may be ignored), and finally [F]+ either [PMS] key.

§4.2.5 Odd Repeater Shifts & Split-Frequency Memories

Non-standard repeater shifts can be set in the Dial mode, using the frequency shift register, for occasional or one-time needs; or in the Memory mode for permanent requirements.

1. To operate with a non-standard (other than 1.6 MHz) shift in the Dial mode, first key in your receive frequency and press [D], followed by the desired **offset** (not the actual transmit frequency), and [F]+[SHIFT]. Then press either [F]+[+RPT] or [F]+[-RPT], as required. **+RPT** or **-RPT** will be displayed along with the operating frequency, which will be offset by the same amount regardless of what frequency is later set in the Dial mode.

Simplex operation can be recalled by pressing [F]+[SIMP], in which case the offset will remain in the frequency shift register but 'shift' operation will be cancelled; or by pressing [0] and [F]+[SHIFT], which will zero the offset but retain 'split' operation (with no shift).

2. To store an odd split in a memory, begin by storing the receive frequency (key in the digits, press [D], the memory number and then [M]). Then key in the desired amount of offset, press [F]+[SHIFT] and [F]+[+RPT] or [F]+[-RPT], followed by the same memory number just entered, and [M] again. At this point, the transceiver is still in the Dial mode, so you can go ahead and operate. When the memory is recalled, it will have the data just programmed, but the '+' or '-' indicating the offset direction will not be displayed.

The above two procedures each cause the shift to be changed, so that it must be reprogrammed to return to standard shift (by keying in [1], [6], and [F]+[SHIFT]). This may be inconvenient if only one repeater has that particular odd split, and so a third method is available which does not use the frequency shift register, but programs completely independent receive and transmit frequencies into a memory.

3. First key in the receive frequency, and press [D], the desired memory number and [M] to store it in the memory. Then key in the actual transmit frequency (not offset), and press [D], the same memory number, and [F]+[TXM]. Note that the transceiver is now in the Dial mode on the transmit frequency. Recall the memory by pressing the memory number and [MR].

Recall that the [SWAP] key is available for reversing the transmit and receive frequencies at any time (to check for signals on the repeater input frequency, or to transmit on the repeater output frequency). This can be used with any of the above methods, and "REV" will be shown on the display when operation is the reverse of that programmed.

§4.2.6 Multi-channel Priority Scanning

The Priority Channel Checking function described in §4.1.5 may be implemented to sequentially check a set of memories for activity.

1. The selected memory scanning system described in §4.2.3 can be used for priority checking of selected memory channels during operation in the Dial mode. First, enter your desired receive frequency and press [D]. Now check the selected memories by pressing [M], and enter or unmask the memories that you wish to have priority-checked. Then recall the memory you wish to begin with, by pressing the memory number and [MR], and start select memory scanning with the up or down arrow key. Set the **SQL** control for the desired threshold, and press [#] to activate priority checking. The transceiver is now operating in the Dial mode, but each time the priority system checks a memory, it will be higher or lower than that checked previously.

Of course, when operating in the Dial mode and priority checking memories, it is also possible to scan the Dial frequency, just by pressing either of the scan keys again. However, when the Dial is used for scanning the SAVE function is inoperative, so power consumption is higher.

§4.2.7 Tone Squelch Programming (requires FTS-6 option)

When the optional FTS-6 CTCSS Tone Squelch Unit is installed the tone frequency and decoder selectivity (Q) may be selected from the transceiver keypad, along with encode-only (transmit) or encode/decode operation. The standard CTCSS tone frequencies are assigned specific code numbers for programming purposes, shown in the chart below.

FTS-6 CTCSS Tone Code Chart

Code No.	Freq (Hz)	Code No.	Freq	Code No.	Freq
1	67.0*	15	131.8	30	225.7
2	71.9*	16	136.5	31	233.6
3	77.0*	17	141.3	32	241.8
4	82.5*	18	146.2	33	250.3
5	88.5*	19	151.4	34	67.0
6	94.8	20	156.7	35	71.9
7	100.0	21	162.2	36	74.4
8	103.5	22	167.9	37	77.0
9	107.2	23	173.8	38	79.7
10	110.9	24	177.9	39	82.5
11	114.8	25	186.2	40	85.4
12	118.8	26	192.8	41	88.5
13	123.0	27	203.5	42	91.5
14	127.3	28	210.7	63	1000**
		29	218.1		

* Decoder Q = 40, other codes have decoder Q = 80

** Audible test tone

1. Select the tone code from the chart that corresponds with the desired tone frequency. Note that codes 1-5 have the same frequencies as codes 34, 35, 37, 39 and 41, but with only half the selectivity. These low-Q codes are for use when the adjacent tone frequencies are not used in the local area, and provide faster response than the more selective codes.

Key in the digit(s) of the tone code, and press [F]+[T SET]. The code number will now appear briefly to the right of the frequency on the display.

2. To activate the tone squelch system (encoder on transmit and decoder on receive), press [F]+[T SQ]. "TONE" is now shown on the display. If you wish to use the encoder only (for transmission), press [F]+[ENC] instead, in which case "TONE" will appear on the display only during transmission.

If the tone code is not entered as in step 1, the default 88.5 Hz (Code 5) will be selected automatically whenever the T SQ or ENC functions are activated. If operating on a memory, be sure to press [M] to store the tone code before changing to another memory or mode. Each memory can store a different tone along with frequency and split, when required.

3. To deactivate the tone squelch or encoder without erasing the selected code, press [F]+[T OFF]. Remember, if you wish to preserve a newly set status in a memory you must press [M] to restore the channel data (if already in the Memory mode, or a memory number and then [M] if in the Dial mode).

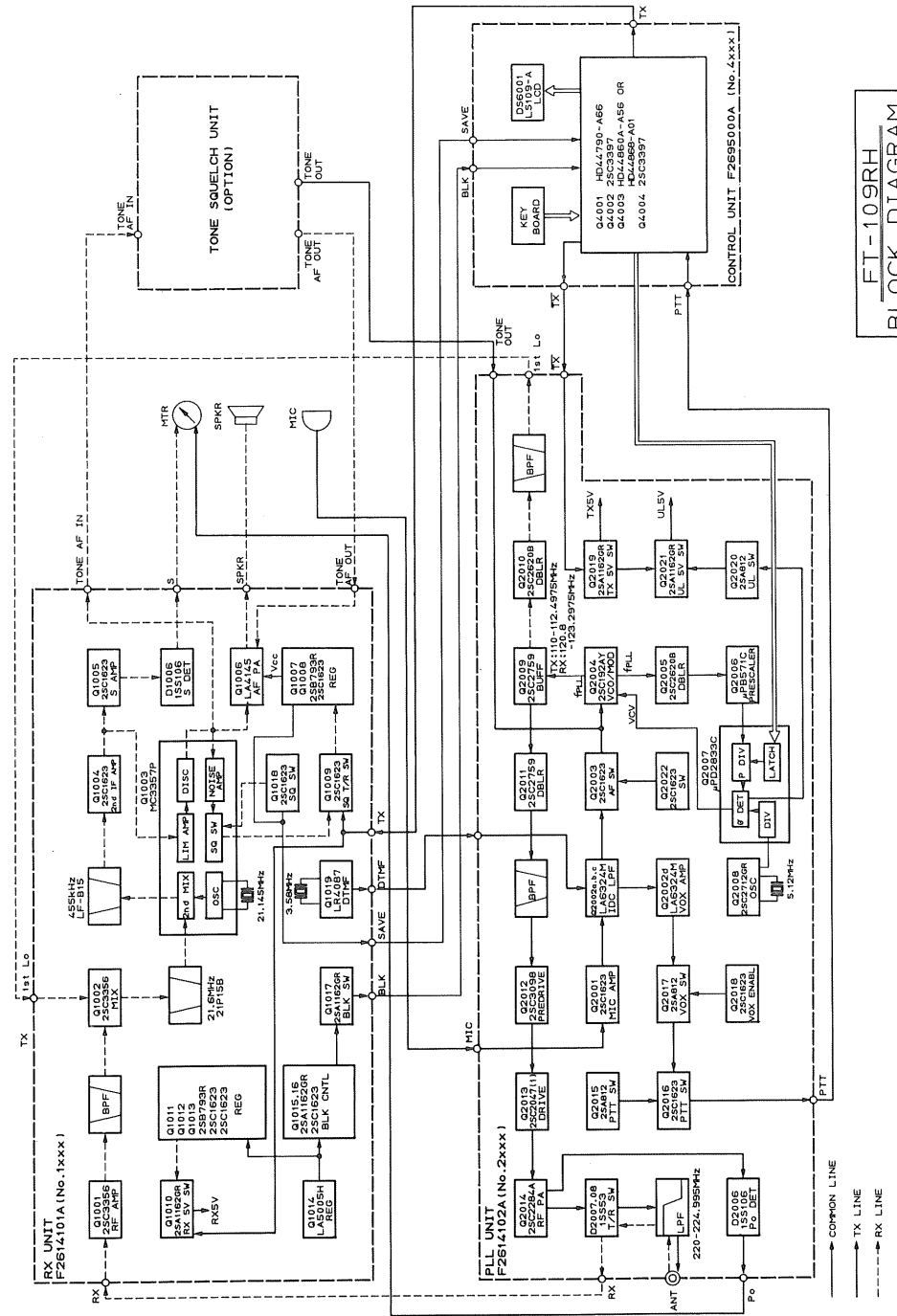

FT-109RH
BLOCK DIAGRAM

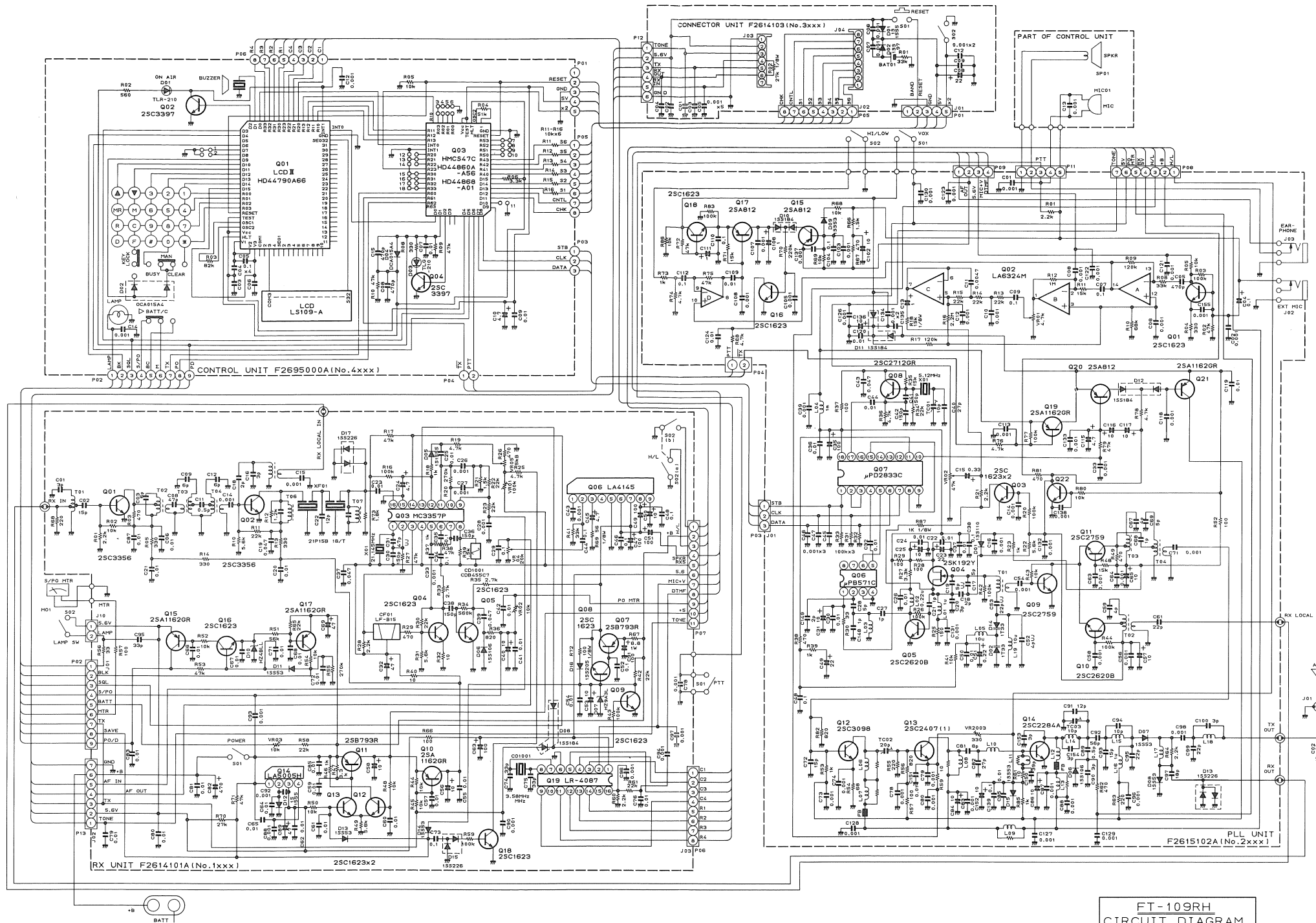

FT-109RH
CIRCUIT DIAGRAM

FNB-3 & FNB-4 RECHARGEABLE BATTERY PACKS FOR YAESU HAND-HELD TRANSCEIVERS

The FNB-3 and -4 are compact, lightweight Ni-Cd power packs designed for the latest model Yaesu handheld transceivers having slide-on battery mounting tracks. Recharging is provided by the NC-15 desk-top Charger/AC Adapter, or the NC-9B/C (for FNB-3) or NC-18B/C (for FNB-4) plug-in wall chargers.

Specifications

Temperature ranges (°C, [°F]):

	Minimum	Optimum	Maximum
Charge	10 [50]	25 [77]	40 [104]
Discharge	-20 [-4]	25 [77]	60 [140]
Storage	-30 [-22]	-4 [25]	50 [122]
Long Storage	-30 [-22]	-4 [25]	35 [95]

	FNB-3	FNB-4
Charge capacity (C, in mAh):	425	500
Number of cells:	9	10
Output voltage:		
@full charge, 1.2V/cell	10.8	12
discharged, 1.0V/cell	9.0	10
Standard charge current (mA):		
14 - 16 hours (C/10)	45	50
Charging time (hours):		
w/ NC-15	1	1.5
w/ NC-9B/C (FNB-3 only)	14-16	-
w/ NC-18B/C (FNB-4 only)	-	14-16

Precautions and Tips on Use

Before using the battery pack for the first time, charge it completely with the NC-15, or NC-9B/C (for the FNB-3) or NC-18B/C (for the FNB-4). The NC-9 and NC-18 require 14 to 16 hours for a complete charge. Do not attempt to charge the FNB-3 with the NC-18, or the FNB-4 with the NC-9.

Whenever charging a pack without the transceiver attached, be careful to avoid allowing any metal object to contact the terminals on top of the pack. We do not recommend using the FNB-3 or -4 for any equipment other than Yaesu transceivers specifically designed for these packs.

If carefully maintained, these packs can be expected to retain usefulness for about 300 charge/discharge cycles, or for up to five years. However, any of the following will shorten useful life of the battery, and should be avoided:

- * exceeding the temperature limits specified above;
- * overcharging by using an incorrect charger, or by charging for too long (the NC-15 has an automatic protection system that works in conjunction with circuits inside the pack to avoid this problem);
- * over-discharging. When the red transmit ("on air") indicator on the transceiver fails to light to full brightness on transmit, the transceiver should be switched off (unless using the NC-15) and the battery should be recharged;
- * shorting the battery terminals, or using the pack with equipment not specifically designed for it;
- * reversing charge polarity. This is avoided by using the NC-15, NC-9 (or NC-18), but if these are tampered with or another charger is used, the pack may be permanently damaged;
- * submersing the battery in water, or attempting to open the battery casing.

If a battery is to be stored without use for more than three months, every three months it should be first returned to room temperature and then recharged to avoid over-discharging itself. Also, note the lower temperature range specified for long storage periods. After storage, the battery should be returned to room temperature before use. It may first function at reduced capacity, but should return to full capacity after several charge/discharge cycles.

If the charge life of the pack becomes very short it should be replaced. Do not dispose of batteries in fire.

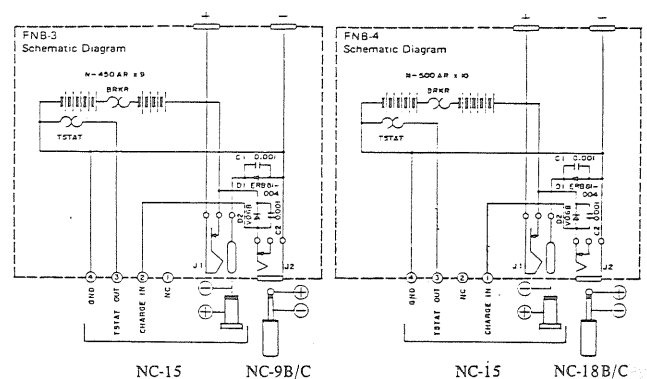

FTS-6 TONE SQUELCH UNIT INSTALLATION

The FTS-6 can be installed in versions A of the FT-209R and RH, FT-709R and FT-727R.

- (1) Make sure that the VOL control is set into the OFF position. Remove the hard or soft case, if used, from the transceiver, and remove the battery pack.
- (2) Remove the four screws affixing the battery mounting track (just two on the FT-727R) on the bottom of the transceiver, and carefully remove the track.
- (3) Locate the 1/8-watt, 27-kilohm resistor that is inserted in one side of the (otherwise empty) socket on the bottom of the transceiver, and pull the resistor out of the socket. It is not needed when the FTS-6 is installed (but must be replaced if the FTS-6 is removed).

If this resistor cannot be found, or if a circuit is already installed in the socket, the transceiver is probably not a Model A. In this case, contact your Yaesu dealer before proceeding.

- (4) Make sure that all of the pins on the FTS-6 are straight, and position the FTS-6 so that the 8-pin side is aligned with the 8-pin side of the socket (the other side of the FTS-6 and socket has 7 pins). Gently press the FTS-6 into the socket, rocking the board back

and forth a little at a time until the top of the IC is flush with the surrounding black plastic inner cover. Do not use a sharp object to press on the board, as this may damage the circuitry.

- (5) Replace the battery mounting track and its 4 screws, followed by the battery pack, which should fit as smoothly as before if the FTS-6 is properly seated. See the Tone Squelch Operation section of the transceiver Operating Manual for operating details.

FTS-6 CTCSS Tone Code Chart

Code	Freq	Code	Freq	Code	Freq	Code	Freq
1	67.0*	12	118.8	23	173.8	34	67.0
2	71.9*	13	123.0	24	177.9	35	71.9
3	77.0*	14	127.3	25	186.2	36	74.4
4	82.5*	15	131.8	26	192.8	37	77.0
5	88.5*	16	136.5	27	203.5	38	79.7
6	94.8	17	141.3	28	210.7	39	82.5
7	100.0	18	146.2	29	218.1	40	85.4
8	103.5	19	151.4	30	225.7	41	88.5
9	107.2	20	156.7	31	233.6	42	91.5
10	110.9	21	162.2	32	241.8		
11	114.8	22	167.9	33	250.3	63	1000**

* Decoder Q=40, other codes have decoder Q=80
 ** Audible test tone

