

INSTRUCTION MANUAL FT-208R

Amateur
Radio
Directory

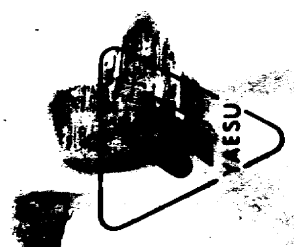

YAESU ELECTRONICS CORP.
P.O. BOX 49
PARAMOUNT, CA 90723, U.S.A.
YAESU MUSEN CO., LTD.
C.P.O. BOX 1500
TOKYO, JAPAN

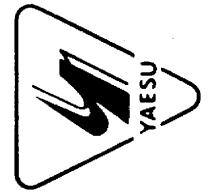

E3690182FC8208-L

INDEX

GENERAL 1
 SPECIFICATIONS 2
 SEMICONDUCTORS 3
 ACCESSORIES 3
 TOP PANEL CONTROLS AND SWITCHES 4
 FRONT PANEL SWITCHES 5
 BOTTOM PANEL CONNECTIONS 7
 BATTERY PACK INFORMATION 8
 BATTERY CHARGER INFORMATION 10
 OPERATION 16
 BLOCK DIAGRAM 24
 CIRCUIT DESCRIPTION 25
 MAINTENANCE AND ALIGNMENT 29
 PARTS LIST 38

MODEL	FREQUENCY RANGE	PRESET FREQUENCY	FREQUENCY STEP	REPEATER SHIFT	STONE BURST
	(MHz)	(MHz)	(KHz)	(KHz)	(Hz)
A	144,000- 147,995	147,000	5/10	±600	-
B	144,000- 145,9875	145,000	12.5/25	±600	1750
C	144,000- 147,9875	145,000	12.5/25	±600	1750
D	144,000- 147,995	145,000	5/10	±600	1750
E	144,000- 147,995	147,000	5/10	±600	1750 (1800)

FT-208R MODEL CHART

SPECIFICATIONS

GENERAL

TRANSMITTER

Frequency coverage:

Power output:

144,000-147,995 MHz
(Model A, D, E)

2.5 watts (HIGH)
300 mW (LOW)

144,000-145,9875 MHz
(Model B)

Deviation:

144,000-147,9875 MHz
(Model C)

±5 KHz

Number of channels:

Spurious radiation:

800 5 KHz steps (Model A,D,E)
320 12.5 KHz steps (Model C)
160 12.5 KHz steps (Model B)

Microphone:

Condenser type, 2000 ohm
impedance

Emission type:

RECEIVER

Batteries:

Circuit type:

Ni-Cd battery pack FNB-2

Double conversion
superheterodyne

Voltage requirement:

Intermediate frequencies:

10.8 VDC (maximum 13V)

1st IF = 16.9 MHz
2nd IF = 455 KHz

Current consumption:
RX 150 mA
(20 mA squelched)

Sensitivity:

TX 700 mA (HI),
350 mA (LOW)

Better than 0.25 μ V for 12 dB
SINAD
Better than 1 μ V for S/N 30 dB

Case dimensions:

Selectivity:

168 (H) x 61 (W) x 49 (D) mm

± 6 KHz at -6 dB
±12 KHz at -60 dB

Weight:

Audio output:

(with battery pack, rubber antenna)
720 g Approx.

500 mW at 10% THD

CONTROL UNIT

Symbol	Part No.	Description
PB-2337A	F0002337A	Printed Circuit Board
	C0023370	P.C.B. with Components (w/o BAT301 Lithium Battery)
		IC
Q301	G1090423	HD44820-A61
Q302	G1090346	TP0401
Q303	G1090126	MC14069B
Q304	G1090330	MK5087
		DISPLAY LCD
DS301	G6090021	HI301
		DIODE
D301-305,308,309	G2090027	Si 1SS53
D306	G2090118	Schottky Barrier 1SS97
D311	G2090182	Zener HZ7A-2
D310	G2090175	LED SR-535D
D312	G2090173	LED SG235D
		CRYSTAL
X301	H0102320	HC-18/T 3.579545MHz
		RESISTOR
R309	J01215471	Carbon Film 1/8W TJ 470 Ω
R310	J01215152	" " " 1.5k Ω
R313	J01215222	" " " 2.2k Ω
R316	J01215332	" " " 3.3k Ω
R304	J01215472	" " " 4.7k Ω
R305,314,315	J01215562	" " " 5.6k Ω
R301	J00215104	" " " VJ 100k Ω
R303	J01215104	" " " TJ 100k Ω
R311,312	J01215224	" " " TJ 220k Ω
R302	J00215684	" " " VJ 680k Ω
R306	J01215824	" " " TJ 820k Ω
R307,308	J00215105	" " " VJ 1M Ω
		THERMISTOR
TH301	G9090016	33D-28

* Specifications subject to change without notice or obligation.

SEMICONDUCTOR

ICs:	Transistors:	Diodes:
HD44820A61	2SA950Y	1S1555 (Si)
MC3357	2SA1175E	1SS53 (")
MC14069UB	2SC2053	U05B (")
TC5082	2SC2512	1SS97
TP0401	2SC2120Y	(Schottky Barrier)
μ PC577H	2SC2196	1SV69
μ PD2819C	2SC2549	(Varactor)
MK5087	2SC2785E	1T25 (")
	2SC2786L	FC53 (")
	2SC2787L	MV11
		(Varistor)
		MV103 (")
		HZ6B-1L
		(Zener)
		HZ7A-2 (")
		HZ7B-1L (")
		SG235D(LED)
		SR535D (")

FETs:

2SK184Y	1
2SK192Y	1
2SK193K	3

LCD Display:

HI301	1
-------	---

* Model B, C, D, E only

ACCESSORIES

Rubber Whip Antenna	YHA-14	(Q3000005)	1
Shoulder Strap with Ring		(R7048792B)	1
Earphone		(M4190001)	1

C273	K70167104	Tantalum (CS15E1V0R1M)	35WV	0.1 μ F
C272	K70127225	" (CS15E1C2R2M)	16WV	2.2 μ F
C222	K70127475	" (CS15E1C4R7M)	"	4.7 μ F
C226,227	K70127685	" (CS15E1C6R8M)	"	6.8 μ F
C216	K70127106	" (CS15E1C150M)	"	10 μ F
C218,250,287	K70107106	" (CS15E1A100M)	10WV	10 μ F
C277	K70087106	" (CS15E0J100MIS)	6.3WV	10 μ F
C240	K40179005	Electrolytic (50RC2-R47)	50WV	0.47 μ F
C207,245,276 278-280, 285	K40129012	" (16RC2-10)	16WV	10 μ F
C243	K40109009	" (10RC2-33)	10WV	33 μ F
C239,0314	K40129002	" (16RE47)	16WV	47 μ F
TC201	K91000029	TRIMMER CAPACITOR ECV-1ZW20X53	20pF	
		INDUCTOR		
L202	L1190108	FL3H-R68M	0.68 μ H	
L201	L1190105	FL3H-1R0M	1 μ H	
L203	L1190019	FL5H-150K	15 μ H	
L206	L1190115	S-154K	150mH	
L204	L0020978			
L205	L0020745B			
		TRANSFORMER		
T201	L0020904			
T202-204	L0020747			
T205	L0020905			
T206	L0020906			
T207-210	L0020907			
		SWITCH		
S201	N6090026A	SSS212005		
		CONNECTOR		
J201	P0090187	DCP-20		
J202	P1090127	2.5EJ1		
		FUSE		
F201	Q0000022	MFA-5	5A	

TOP PANEL CONTROLS AND SWITCHES

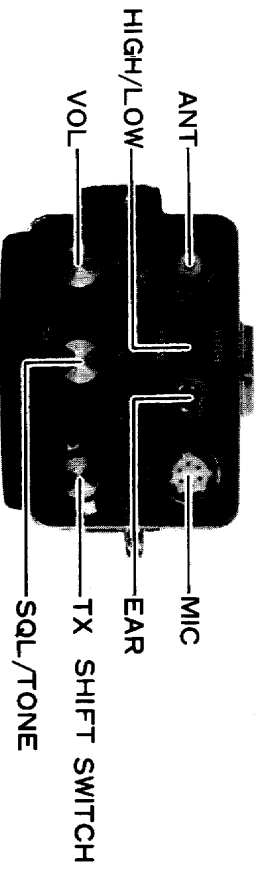

VOL

This is the main volume and power ON/OFF switch for the transceiver.

SQL/TONE

The squelch control silences the receiver audio until a signal is received. When rotated to the TONE position, this switch will activate the optional Tone Squelch Unit, FTS-32, which provides silent monitoring of busy channels.

MIC

This connector accommodates the optional YM-24A Remote Speaker/Microphone.

ANT

The ANT jack is a BNC type connector for quick connection of the rubber flex antenna or an external antenna.

EAR

This is a miniature phone jack used to accommodate an external earphone.

HIGH/LOW

This switch selects transmitter powers of 2.5 watts RF output or 300 mW of RF output.

C202,205,229	K06182050	Ceramic disc (RD870-1N750-5R0C63V)	63WV	UJ	5pF
C263,266,270	K06183060	" (RD870-1N750-6R0D63V)	"	"	6pF
C235	K04183090	" (RD870-1N150-9R0D63V)	"	PG	7pF
C203	K02183080	" (RD870-1NPO-8R0D63V)	"	CH	8pF
C204,206,257, 258	K06183080	" (RD870-1N750-8R0D63V)	"	UJ	8pF
C236	K06183090	" (RD870-1N750-9R0D63V)	"	"	9pF
C210,232	K04185120	" (RD870-1N150-120J63V)	"	PG	12pF
C234,261,293	K00185150	" (RD870-1SL-150J63V)	"	SL	15pF
C214	K00185220	" (RD870-1SL-220J63V)	"	"	22pF
C224,225,294	K00185330	" (RD870-1SL-330J63V)	"	"	33pF
C252	K07179013	" (RD871-2N150-330J63V)	"	"	33pF
C253	K04185330	" (RD871-1N150-330J63V)	"	PG	33pF
C231	K06189006	" (RD871-2N750-680J63V)	"	UJ	68pF
C246-248	K06185331	" (RD874-2N750-331J63V)	"	"	330pF
C208,211,217, 233,237,238, 249,254,255, 259,260,268, 271,283,284, 286,288,289, 291,292,296, 299,0300,0312	K10186102	" (RD870-1B102K63V)	"	B	0.001 μ F
C215,219,223, 241,242,244, 251,275,290	K14180103	" (RD871-1FZ-103Z63V)	"	FZ	0.01 μ F
	K13179002	" (2222-662-02223)	"	"	0.022 μ F
C213,220,221, 228,295,297	K19149013	" (UAT05X103K-L05AE)	"	X	0.01 μ F
C281,282	K19149019	" (UAT08X333K-L45AE)	25WV	X	0.033 μ F
C274	K23170006	" (RPF112C473K50)	50WV	"	0.047 μ F
C0301,0303, 0313	K23140005	" Chp (GR40W5R102M)	"	"	0.001 μ F

R257	J00215561	Carbon Film	1/8W	VJ	560Ω
R207,230	J00215102	"	"	"	1kΩ
R261	J00215122	"	"	"	1.2kΩ
R239,251,258	J00215152	"	"	"	1.5kΩ
R222,224	J00215182	"	"	"	1.8kΩ
R210,225,232,240,254	J00215222	"	"	"	2.2kΩ
R255,256,263	J00215272	"	"	"	2.7kΩ
R204	J00215332	"	"	"	3.3kΩ
R216	J01215472	"	"	TJ	4.7kΩ
R253	J00215472	"	"	VJ	4.7kΩ
R264	J00215562	"	"	"	5.6kΩ
R235	J00215103	"	"	"	10kΩ
R226	J00215123	"	"	"	12kΩ
R237	J00215333	"	"	"	33kΩ
R236,252	J00215563	"	"	"	56kΩ
R238,262	J00215683	"	"	"	68kΩ
R201,247	J00215104	"	"	"	100kΩ
R233,246	J01215104	"	"	TJ	100kΩ
R218-220,250	J10246104	" Composition	1/4W	GK	100kΩ
R260	J01215154	" Film	1/8W	TJ	150kΩ
R206,209	J00215224	"	"	VJ	220kΩ
R214	J01215224	"	"	TJ	220kΩ
R242-245,249	J10246224	" Composition	1/4W	GK	220kΩ
R228,231	J00215334	" Film	1/8W	VJ	330kΩ
R203	J00215474	"	"	"	470kΩ
R217	J00215105	"	"	"	1MΩ
VR202	J51745332	POTENTIOMETER H0651A010-3.3KB	3.3kΩB		
TH201	G9090008	THERMISTOR 31D-26			
C264	K00182059	CAPACITOR Ceramic disc (RD870-1SL-0R5C63V)	63WV	SL	0.5pF
C209	K02182010	" (RD870-1NP01R0C63V)	"	CH	1pF
C212	K00182020	" (RD870-1SL-2R0C63V)	"	SL	2pF
C262,265,269	K02182030	" (RD870-1N150-3R0C63V)	"	CH	3pF
C201	K06182040	" (RD870-1N7504R0C63V)	"	UJ	4pF
C256	K04182040	" (RD870-1N150-4R0C63V)	"	"	4pF

SHIFT

This switch selects the repeater transmit frequency offset desired. In the SIMP position, the transmit and receive frequencies are the same. Shifts of ±600 kHz and auxiliary splits (±SET) can be selected. When set to the MS position, you will receive on the memory channel selected while transmission will occur on the dial frequency. See the "Operation" Section for details.

FRONT PANEL SWITCHES

PTT Switch

The Push-To-Talk switch activates the transmitter. Release the switch for receiver recovery.

TOPE BURST Switch (Model B, C, D, E only)

When the TOPE BURST switch is squeezed along with the PTT switch, a 1750 Hz tone will be superimposed on the transmitted signal. The repeater access tone is manually actuated; the tone signal length can thus be controlled by the operator.

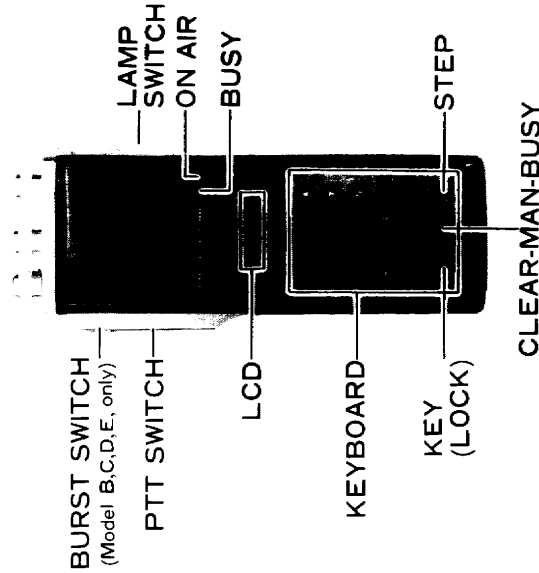

LAMP Switch

This switch activates the LCD illumination lamp (for nighttime operation).

ON AIR

This indicator lights while you are transmitting.

BUSY

This indicator lights when the main receiver squelch is opened up by an incoming signal.

KEYBOARD

On receive, the keyboard controls frequency programming, up/down scanning, and setting of auxiliary repeater splits. On transmit, the keyboard becomes a 16 button dual-tone multi-frequency encoder for autopatch or control purposes.

KEY

This control disables the keyboard, so as to prevent accidental frequency change caused by inadvertent bumping of one of the buttons on the keyboard. When the keyboard is in the "LOCK" mode, the letter "L" will be shown on the display.

BUSY-MAN-CLEAR

This switch selects the STOP mode of the scanner.

STEP

This switch selects the desired synthesizer step. When this switch is set to the X2 position, 10 kHz (25 kHz) steps are programmed. When not in the X2 position, 5 kHz (12.5 kHz) steps are programmed.

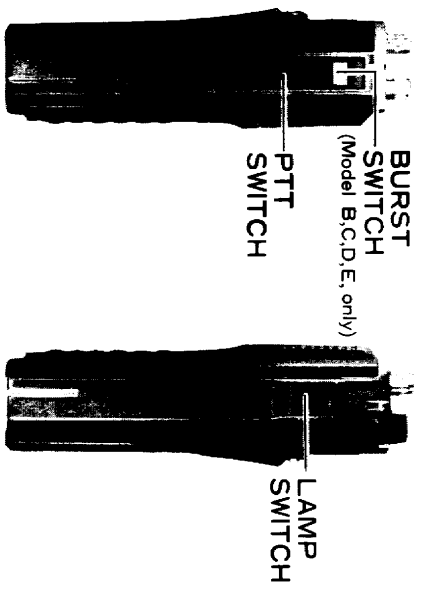

Q206	G1090237	IC	μPD2819C	
Q217	G1090072		μPC577H	
Q220 (FU Model)	G1090239		TC5082P	
Q207	G3801840Y	FET	2SK184Y	
Q201	G3801920Y		2SK192Y	
Q214,215,218	G3801930F		2SK193F.P.K	
			P	
			K	
Q208,211,212, 219	G3327850E /F	TRANSISTOR	2SC2785E/F	
Q202-205,209, 210,213,216	G3327860L		2SC2786L	
D204,205,207, 215,216,219, 220	G2090027	DIODE	SI 1SS53	
D218	G2090003		V06B	
D201	G2090107		Varactor 1T25	
D202,210-214	G2090109		1SV69	
D209	G2090179		FC53	
D208	G9090005		Varistor MV-103	
D206	G2090178		Zener HZ6B-1L	
D217	G2090181		" HZ7B-1L	
D221	G2090138		Schottky ERA-81-004	
X201	H0102408	CRYSTAL	5.76MHz	Model A,D,E
X201	H0102409		HC-18/T 7.2MHz	Model B,C
X202	H0102403		HC-18/T 125.595MHz	Model A,D,E
X202	H0102405		HC-18/T 124.5875MHz	Model B,C
X203	H0102407		HC-18/T3P 16.9MHz	
X204	H0101982		HC-18/T 7.168MHz	Model B,C,D,E
R234	J10246220	RESISTOR	Carbon Composition 1/4W GK	22Ω
R221	J10246470		" " " "	47Ω
R211,259	J00215560		Film 1/8W VJ	56Ω
R205,208,212, 213,241	J00215101		" " " "	100Ω
R265,266	J00215221		" " " "	220Ω
R248	J10246221		Composition 1/4W GK	220Ω
R202,215	J00215331		Film 1/8W VJ	330Ω
R223	J00215391		" " " "	390Ω

C168,170	K40109002	Electrolytic (10RE47)	10WV	47 μ F
C152	K70127225	Tantalum (CS15E1C2R2M)	16WV	2.2 μ F
C159	K70127475	" (CS15E1C4R7M)	"	4.7 μ F
C112,115	K70127106	" (CS15E1C100M)	"	10 μ F
INDUCTOR				
L113	L1190105	FL3H-1R0M	1 μ H	
L101,104	L1020686			
L103,105,110	L1020677			
L114	L1020687			
L102	L0020748			
L106	L0020423			
L107	L0020728			
L108	L0020726			
L109	L0020987A			
L111	L0020342			
TRANSFORMER				
T103	L0020907			
T101	L0020984			
T102	L0020985			
T105,106	L0020986			
T107	L0020887			
SWITCH				
S101		With VR101		
S102		With VR102		
COIL SHIELD CASE				
	L9190016			
TP TERMINAL				
	Q5000036	TPG		
PLL UNIT				
Symbol No.	Part No.	Description		
PB-2204D	F0002204D	Printed Circuit Board		
	C0022040	P.C.B. with Components		

BOTTOM PANEL CONNECTIONS

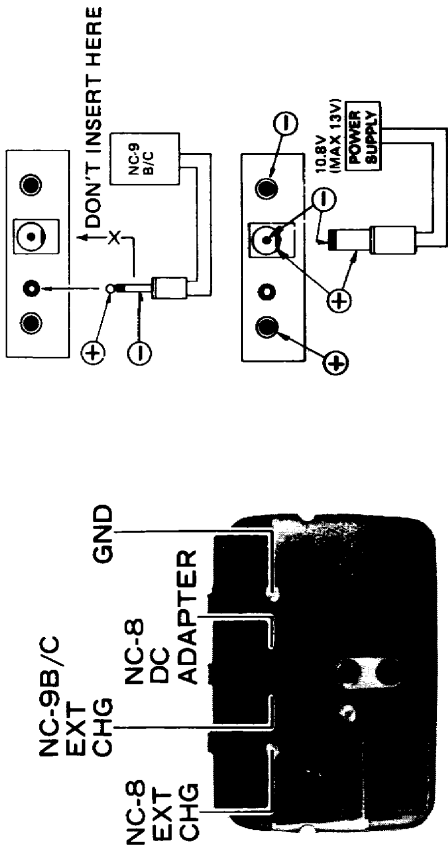

EXT CHG (Jack)

This jack is used for connection to the external NC-9B/C Ni-Cd charger (optional).

EXT CHG (Terminal)

This terminal is for use with the NC-7 and NC-8 chargers (optional).

EXT DC (DC Adapter)

This jack accommodates an external DC power supply. When a plug is inserted, the Ni-Cd battery is automatically switched off.

CAUTION

Never attempt to insert the charge plug from the NC-9B/C or other metal material into the DC adapter jack on the bottom of the FT-208R, as the internal protection fuse will blow.

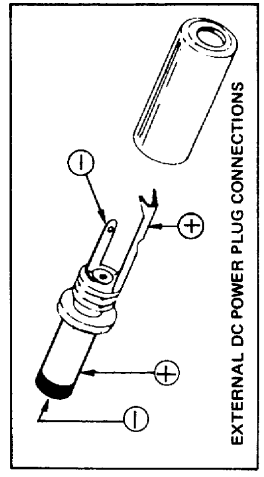
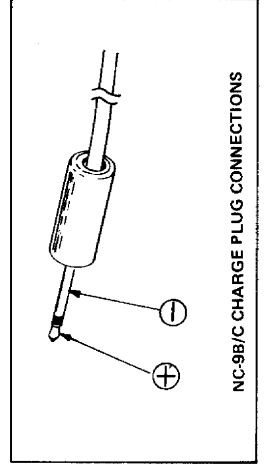

BATTERY PACK INFORMATION

The FNB-2 Ni-Cd battery pack is a 10.8 volt 450 mAh pack designed expressly for the FT-208R. We do not recommend the use of other brands of battery packs. Before removing the battery pack from the transceiver, be sure to remove the charger plug from the transceiver. Never apply AC power of any kind, nor DC voltages above 13 volts, as these types of abuse will void any factory warranties.

The following procedure will allow quick changing of battery packs.

1. Turn the battery compartment cover lock.
2. Remove the battery compartment cover.
3. Remove the discharged battery pack, and install the new pack in the correct manner. Be certain the ⊕ mark is in the upper right hand corner, as shown below.
4. Replace the battery compartment cover, and be sure the cover is locked into place.
5. When operating in remote areas, always be sure to carry at least one extra battery pack, so as not to be without communications in the event of an emergency.

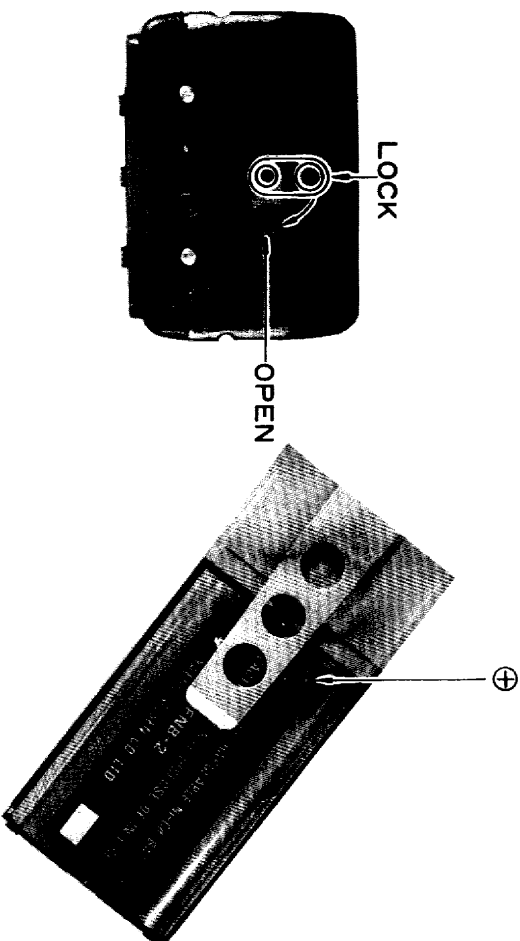

C129,133,155	K00183100	Ceramic Disc (RD870-1SL-100D63V)	63WV	SL	10pF
C110,127	K02185120	" (RD870-1NPO120J63V)	"	CH	120F
C176	K00185120	" (RD870-1SL-120J63V)	"	SL	12pF
C148	K00185150	" (RD870-1SL-150J63V)	"	"	15pF
C120	K00185180	" (RD870-1SL-180J63V)	"	"	18pF
C101,106,118	K00185220	" (RD870-1SL-220J63V)	"	"	22pF
C123	K00185330	" (RD870-1SL-330J63V)	"	"	33pF
C149	K06185330	" (RD870-1N750-330J63V)	"	UJ	33pF
C125	K00185390	" (RD870-1SL-390J63V)	"	SL	39pF
C150	K06185470	" (RD871-1N150-470J63V)	"	UJ	47pF
C107,111	K00185560	" (RD871-1SL-560J63V)	"	SL	56pF
C117	K00185820	" (RD871-1SL-820J63V)	"	"	82pF
C102-105,108, 114,121,122, 126,140,141, 147,157,160, 161,174,175	K10186102	" (RD870-1B102K63V)	"	B	0.001μF
C132,144,146, 151	K14180103	" (RD871-1FZ-103Z63V)	"	"	0.01μF
C163,169	K19149013	" (UAT05X103K-L05AE)	25WV	X	0.01μF
C154,156	K19149017	" (UAT06X223K-L45AE)	"	"	0.022μF
C109,113,177, 178	K23140005	" Chp (GR40W5R102M)	50WV	"	0.001μF
C153,172	K23170008	" Disc (RPE110F104Z50V)	"	"	0.1μF
C162,164	K40179002	Electrolytic (50RC2-R1)	"	"	0.1μF
C166	K40179001	" (50RC2-1)	"	"	1μF
C145,158	K40129012	" (16RC2-10)	16WV	"	10μF
C173	K40129007	" (16RE100)	"	"	100μF

ANTENNA CONSIDERATIONS

The FT-208R comes equipped with a helical rubber flexible antenna, which should be sufficient for local work through repeaters, etc. Different types of antennas may be connected to the top panel BNC connector.

The external antenna should have an impedance of 50 ohms, and should be fed with good quality cable. If your current antenna has a connector which differs from the BNC type, consult your dealer regarding the purchase of a suitable adapter.

For base station use, gain antennas such as the yagi, quad, stacked vertical, etc., will enhance long distance communications. These antennas are also available from most Yaesu dealers.

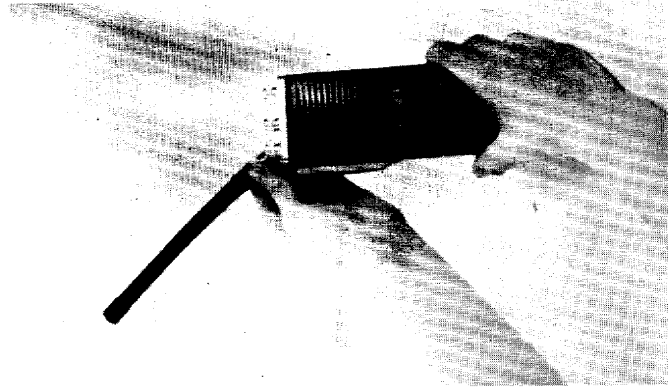

R115	J02245471	Carbon Film	1/4W	SJ	470Ω
R102,130,144, 155	J00215102	"	1/8W	VJ	1kΩ
R103	J10246102	"	1/4W	GK	1kΩ
R108,139	J00215152	Film	1/8W	VJ	1.5kΩ
R125,128,132, 134,157,166	J00215222	"	"	"	2.2kΩ
R165	J10246222	Composition	1/4W	GK	2.2kΩ
R118	J00215332	Film	1/8W	VJ	3.3kΩ
R140,141,145	J00215472	"	"	"	4.7kΩ
R168	J10246472	Composition	1/4W	GK	4.7kΩ
R124,142	J00215562	Film	1/8W	VJ	5.6kΩ
R150,152	J00215103	"	"	"	10kΩ
R151	J01215103	"	"	TJ	10kΩ
R122,138	J00215153	"	"	VJ	15kΩ
R126	J00215183	"	"	"	18kΩ
R147	J01215183	"	"	TJ	18kΩ
R121,153,133	J01215333	"	"	TJ	33kΩ
R129	J00215333	"	"	VJ	33kΩ
R136,164	J00215473	"	"	"	47kΩ
R135	J00215513	"	"	"	51kΩ
R143	J00215683	"	"	"	68kΩ
R153	J10246823	Composition	1/4W	GK	82kΩ
R146	J10246152	"	"	"	100kΩ
R149,163	J00215104	Film	"	VJ	100kΩ
R127,131	J00215124	"	1/8W	"	120kΩ
R117	J00215184	"	"	"	180kΩ
R154	J00215224	"	"	"	220kΩ
R167	J10246224	Composition	1/4W	GK	220kΩ
R137	J00215274	Film	1/8W	VJ	270kΩ
R123	J00215474	"	"	"	470kΩ
		POTENTIOMETER			
VR101 (with S101)	J60800091	EVJLKBP15A24	20KΩA		
VR102 (with S102)	J60800090	EVJLKBP15B53	5KΩB		
VR103	J51745103	H0651A013-10KB	10KΩB		
		CAPACITOR			
C136	K00182010	Ceramic Disc (RD870-1SL-1R0C63V)	63WV	SL	1pF
C119,124,142	K00182030	"	"	"	3pF
C128	K07183060	"	"	"	6pF
C130,134,137	K07183070	"	"	"	7pF

BATTERY CHARGER INFORMATION (OPTION)

NC-7

The NC-7 is a battery charger for base stations, designed to match the FT-208R. A completely discharged FNB-2 battery pack can be charged in 15 hours, using the NC-7. While charging the battery pack with the NC-7, the FT-208R cannot be used.

NC-8

The NC-8, designed for the FT-208R, is a battery charger/DC adapter with three different charging modes: QUICK, STANDARD and TRICKLE. Any of these modes may be selected according to your battery condition and the desired charge time. The QUICK mode charges the battery in approximately 4 hours, the STANDARD mode in 15 hours, and the TRICKLE mode may be used to protect the battery from self-discharge when the battery is completely charged.

The DC adapter function of the NC-8 can be used to operate your FT-208R, while saving battery consumption. During operation with the DC adapter, the charger function can also be activated.

FBA-2

This battery sleeve is designed to charge the FNB-2 battery pack, using either the NC-7 or NC-8. It is especially convenient when you charge an extra battery pack while using your transceiver.

NC-9B/C

The NC-9B/C is a compact charger to charge the FNB-2 battery pack while installed in the FT-208R. The approximate time required for a completely discharged battery is 15 hours.

PA-3

The PA-3 is a DC-DC adapter for use with the FT-208R, when operating your transceiver from a car. The PA-3 allows you to operate the FT-208R while conserving battery charge, and the trickle charger function also protects the battery pack from self-discharge. (Use only with 12 V negative ground cars.)

MAIN UNIT

Symbol No.	Part No.	Printed Circuit Board	Description
PB-2276A	F0002276A		Printed Circuit Board
	C0022760		P.C.B. with Components
Q109	G1090145	IC	MC3357P
		TRANSISTOR	
Q116,120	G3109500Y		2SA950Y
Q111,114,117	G3111750E		2SA1175E
Q102	G3320530		2SC2053
Q115,119	G3321200Y		2SC2120Y
Q103	G3321960		2SC2196
Q101	G3325120		2SC2512
Q104	G3325490		2SC2549
Q110,112,113, 118,121,122	G3327850E /F		2SC2785E/F
Q105	G3327860L		2SC2786L
Q106-108	G3327870L		2SC2787L
		DIODE	
D108,109	G2090027	SI	1SS53
D106	G2015550	"	1B1555
D101,102	G2090033	"	M1301
D107	G9090017	Varistor	MV-11
		CRYSTAL	
X101	H0102419	HC-18/T	17.355MHz (Model A,D,E)
X101	H0102406	HC-18/T	16.445MHz (Model B,C)
		FILTER	
XF101	H1102033	16M15A18T	
CF101,102	H3900030	LF-B15	
		RESISTOR	
R161,162	J00215279	Carbon Film	1/8W VJ 27Ω
R112	J00215100	"	" " 10Ω
R109	J01215100	"	" " TJ 10Ω
R169	J20336390	Metallic "	2W 39Ω
R104	J01215470	Carbon "	1/8W TJ 47Ω
R156	J00215560	"	" " VJ 56Ω
R133	J00215101	"	" " 100Ω
R160	J00215121	"	" " 120Ω
R148	J00215151	"	" " 150Ω
R107,159	J00215221	"	" " 220Ω
R172	J01215221	"	" " TJ 220Ω
R171	J10246221	"	" Composition 1/4W GK 220Ω
	J00215271	"	" Film 1/8W VJ 270Ω
R101,158	J00215331	"	" " 330Ω

PARTS LIST

MAIN CHASSIS		Part No.	Description
		RESISTOR	
R01	J01215101	Carbon film	1/8W TJ 100Ω
R02*	J20336180	Metallic film	MOR 2P 2W 18Ω
		CAPACITOR	
C01	K02175180	Ceramic disc	50WV CH 18pF (DD104CH80J50V02)
C03	K10186102	" "	63WV B 0.001μF (RD870-1B102K63V)
C05	K41120476	Electrolytic	16WV 47μF (16TL47)
C04	K40129007	" "	100μF (16RE100)
		INDUCTOR	
L01	L0020334		
		SWITCH	
S01	N6090025	SST(C)	12-04V
S02	N0190080A	JRA-1-12-9	(with PB-2207A)
S03	N4090040	KHG10901	
S05 (S04)	N4090041	KHC10904	
S06	N5090006	KEA5A021	
		RECEPTACLE	
J01	F1090201	UK-0002	
J02	F1090052	SR30-10R-6S	
J03	F1090191	UG-625B/U	
		CONNECTOR	
F1 (with white)	T9302310		
		MICROPHONE	
MIC1	M3290001	EM-76	
	(M3290005)	(EM-78C)	
		SPEAKER	
SP1	M4090050	VS-40A	8Ω 0.1W
		CABLE	
	T9204090		
		LITHIUM BATTERY *****	
BAT301	Q9000106	CR2025 for BACK UP (CONTROL UNIT)	

(* LOW POWER ... 1W MODEL)

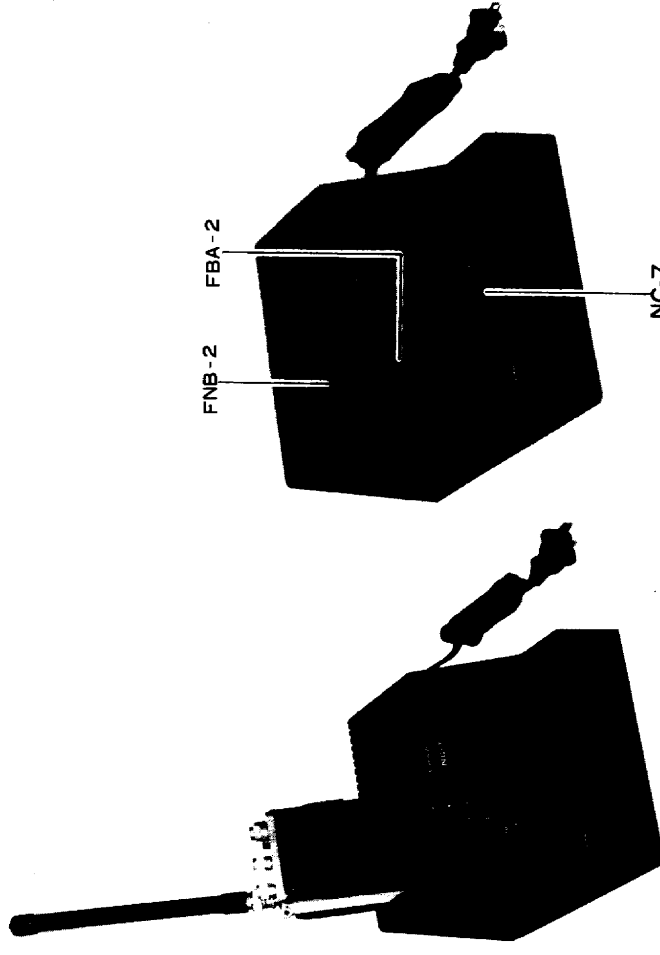

NC-7/FT-208R

NC-7/FBA-2/FNB-2

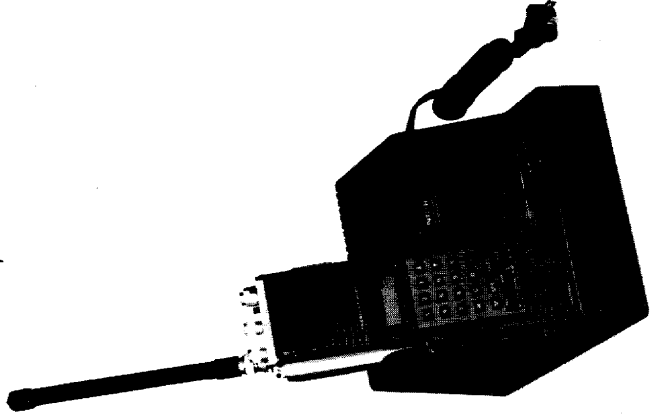

NC-8/FT-208R

NC-8/FBA-2/FNB-2



NC-9B (for 117V AC)

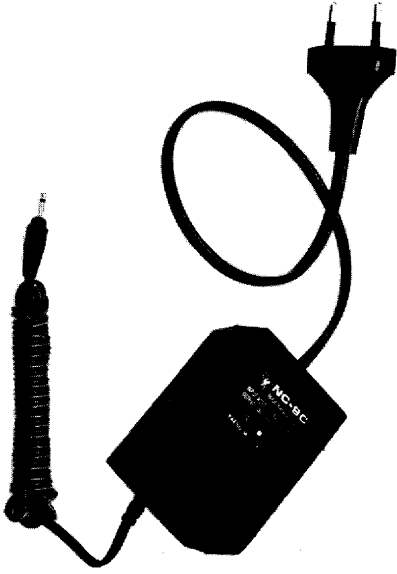

NC-9C (for 220-234V AC)

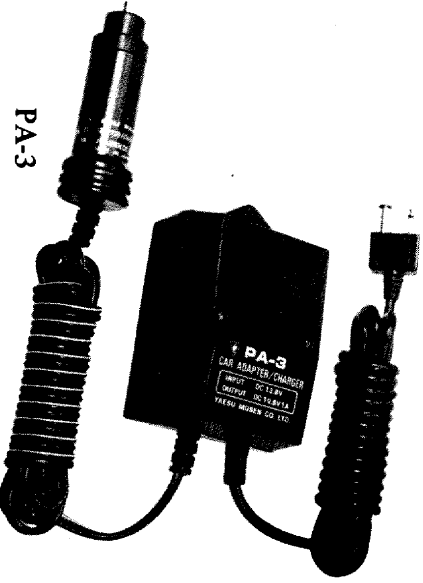

PA-3

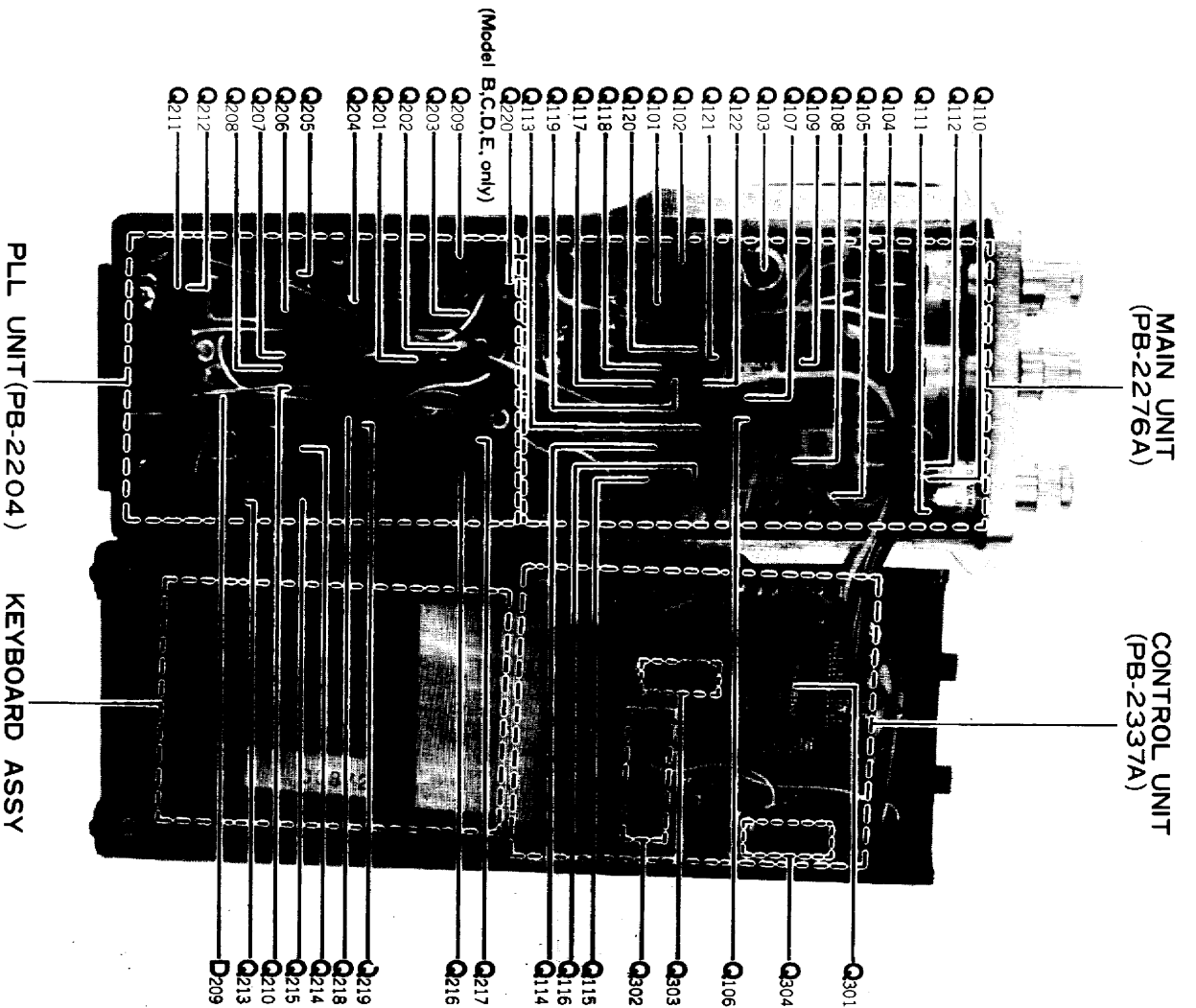

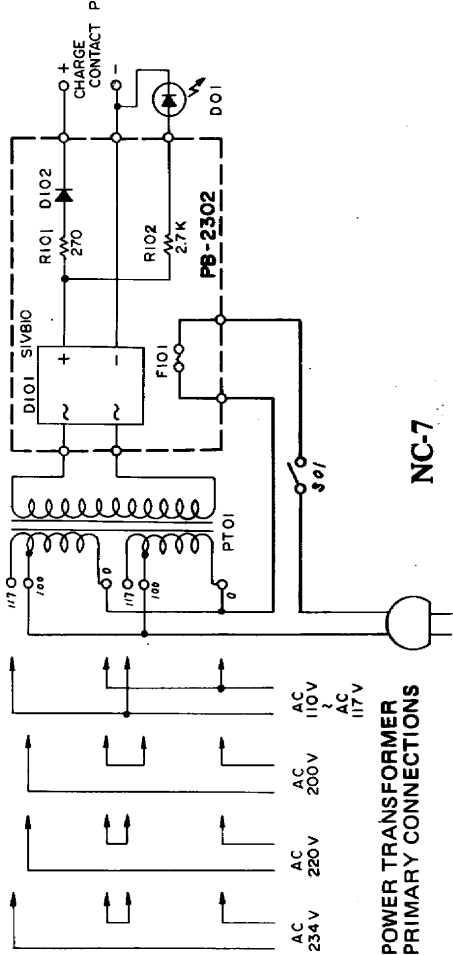

**POWER TRANSFORMER
PRIMARY CONNECTIONS**

NC-7

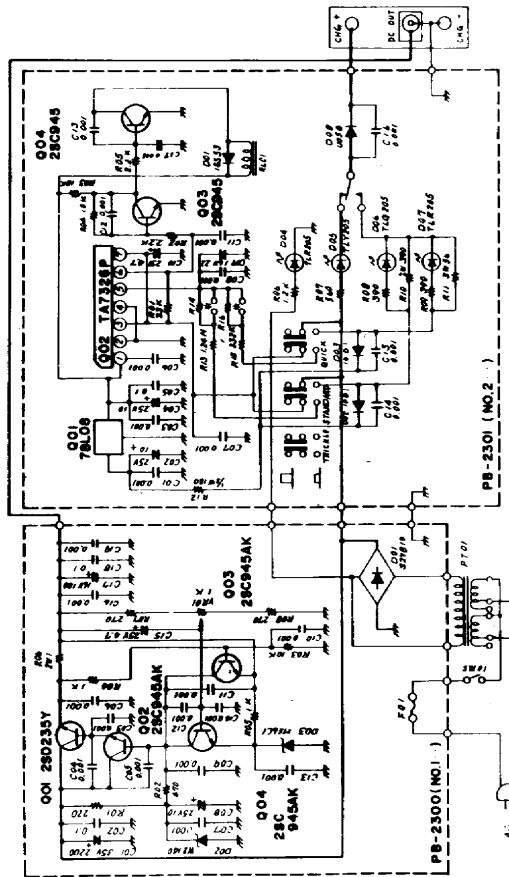

- LCD
- Q 302
- Q 303
- BU BAT
- BUZZER
- Q 304

NC-8 * Adding resistor in parallel
charges time constant

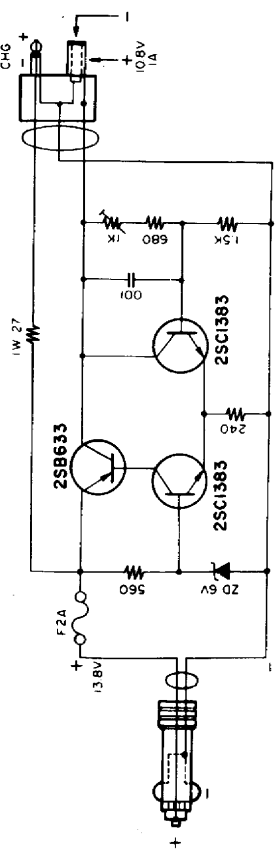

PA-3

EXTERNAL SPEAKER/MICROPHONE (OPTION)

An external speaker/microphone may be attached through the top panel microconnector.

The microphone should have an impedance of 2000 ohms. See your Yaesu dealer for details of the YM-24A Remote Speaker/Microphone.

Once installed, the YM-24A can be held close to your ear during reception, allowing you to raise your FT-208R high above any obstructions. On transmit, hold the microphone near your mouth, and squeeze the switch on the microphone. Release the switch to resume reception.

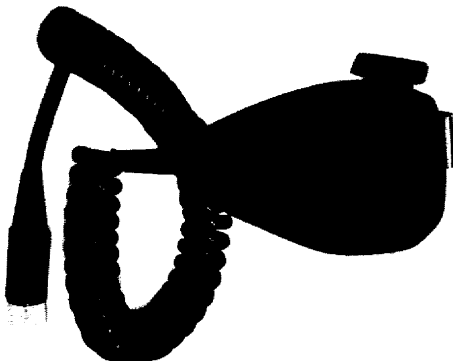
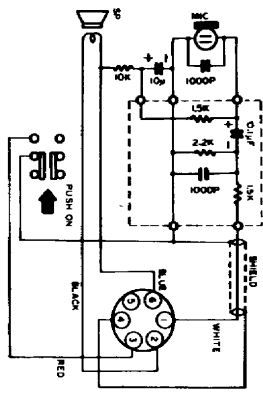

The YM-24A Speaker/Microphone option adds versatility to your Yaesu transceiver.

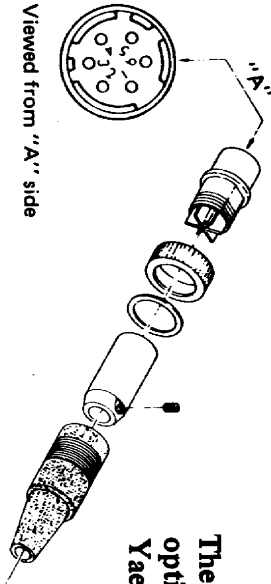

YM-24A Speaker/Microphone Connections

B. Deviation Adjustment

1. Connect a dummy load through a directional coupler to the ANT jack, and a portion of the output from the directional coupler to the deviation meter. Apply a 1 kHz 25 mV signal to the external microphone connector from an audio oscillator.
2. Adjust VR₂₀₂ for a deviation of ± 4.5 kHz on the deviation meter (refer to Figure 2).

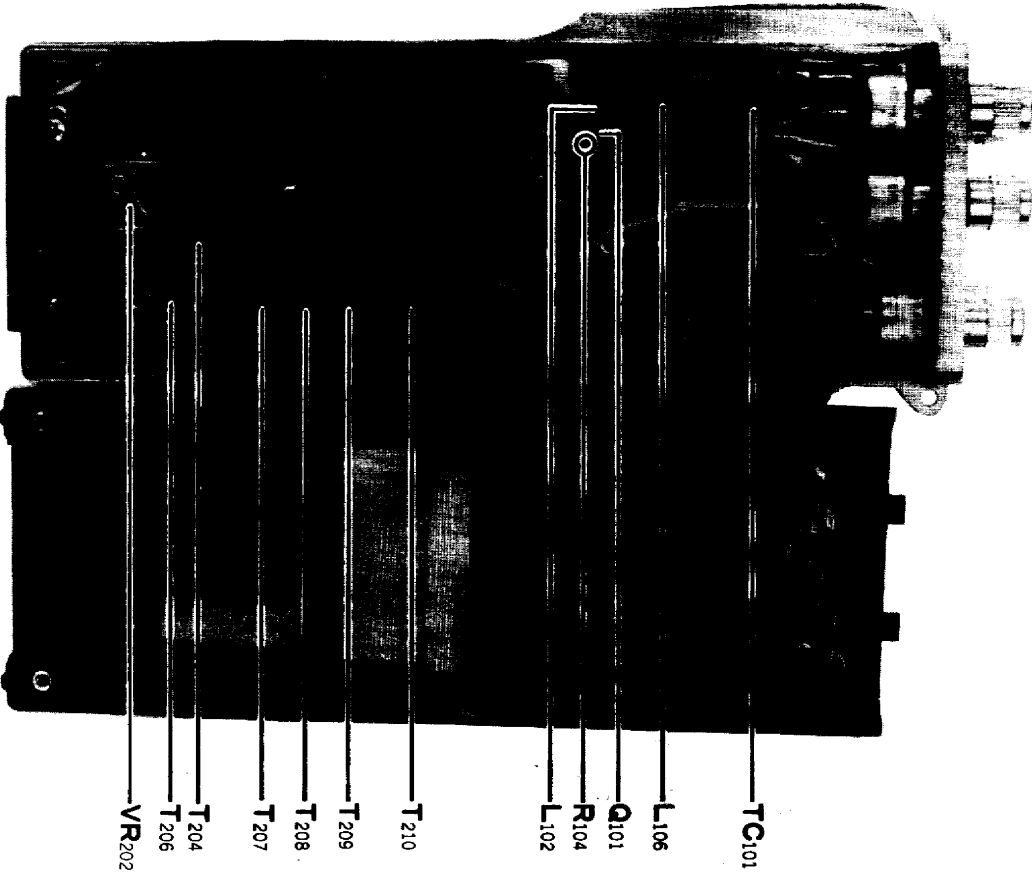

TRANSMITTER SECTION ALIGNMENT POINTS

III. Transmitter Alignment

A. Power Amplifier Alignment

1. Connect a dummy load/wattmeter to the ANT jack, and set the transmitter to 146 MHz (model B: 145 MHz).
2. Connect a DC voltmeter to the emitter of Q₁₀₁. Refer to the alignment point photo.
3. Set the HI/LOW switch to the LOW position and close the PTT switch. Now adjust T₂₀₄, T₂₀₆, T₂₀₇, T₂₀₈, T₂₀₉ and T₂₁₀ for maximum DC voltage on the meter.
4. Set the HIGH/LOW switch to the HIGH position, and adjust L₁₀₂, L₁₀₆ and TC₁₀₁ for a maximum RF power reading on the wattmeter.

MMB-10 MOBILE BRACKET (OPTION)

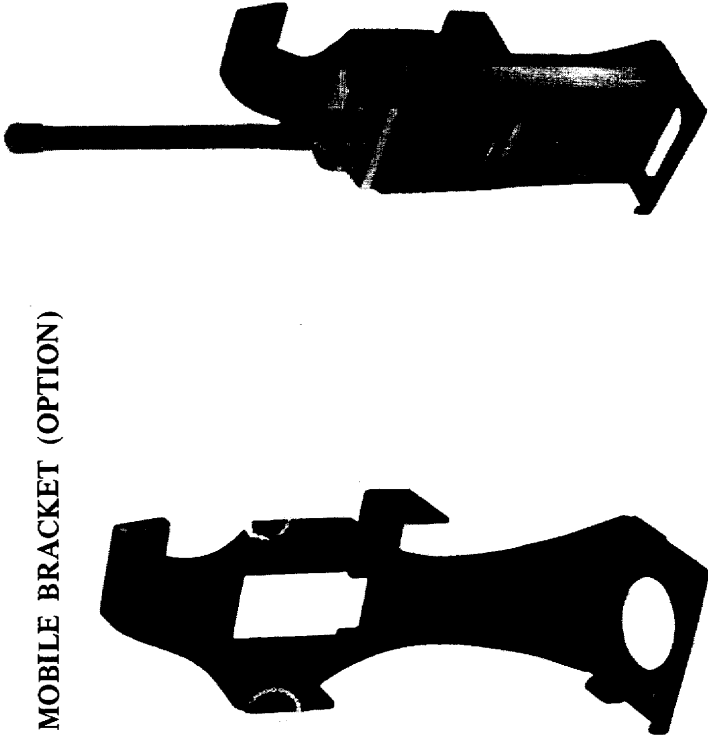

MMB-10/FT-208R

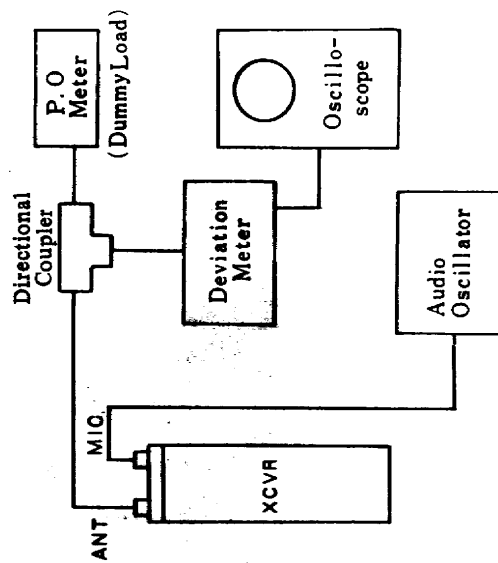
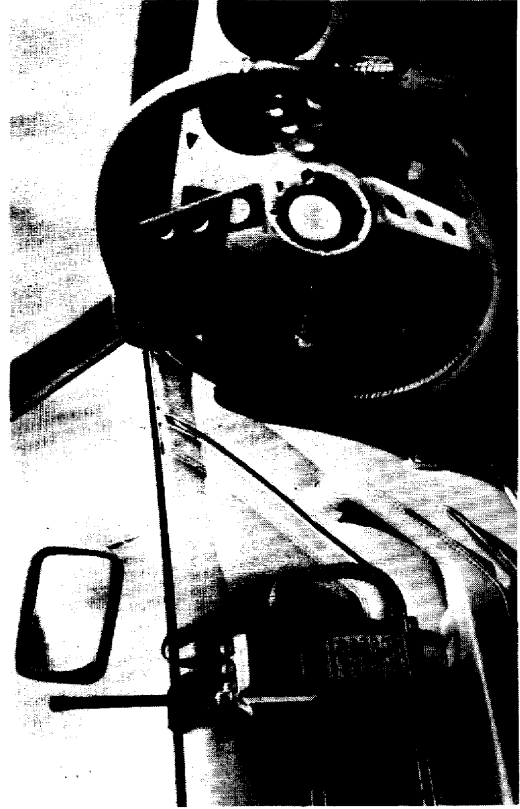

Figure 2



FT-208R/YM-24A/MMB-10

OPERATION

A. Basic Operation

1. Preset the controls and switches as follows:

SHIFT	SIMP position
VOL	OFF position
SQL	Position just before the click-stop
KEY	UNLOCK (left) position
CLEAR-MAN-BUSY	MAN position
STEP	X1 (left) position
BACKUP	ON position

(located in the battery compartment)
See page 23

2. Make certain that the battery pack is correctly installed and that the antenna has been properly connected.
3. Turn the VOL control clockwise out of the click-stop position. The digital display will indicate "7.000" meaning 147.000 MHz (Model B, C, D "5.000" = 145.000 MHz). Gradually rotate the VOL control for a comfortable level on the background noise or incoming signal.
4. When the channel is clear, rotate the SQL control clockwise until the background noise is just silenced. If you go beyond this threshold point the receiver will not respond to weak signals.
5. Squeeze the push-to-talk (PTT) switch to transmit. Release the PTT switch for receiver recovery. If your FT-208R (Model B, C, D, E) is equipped with a tone burst switch, press this switch, along with the PTT switch, to transmit a 1750 Hz tone to access repeaters.

B. Entering Frequencies from the Keyboard

[Model A, D, E]

1. When a frequency is programmed from the keyboard, the last four digits of the operating frequency must be entered. This frequency must be divisible by 5 KHz (e.g., 5.325, 5.350, etc.).

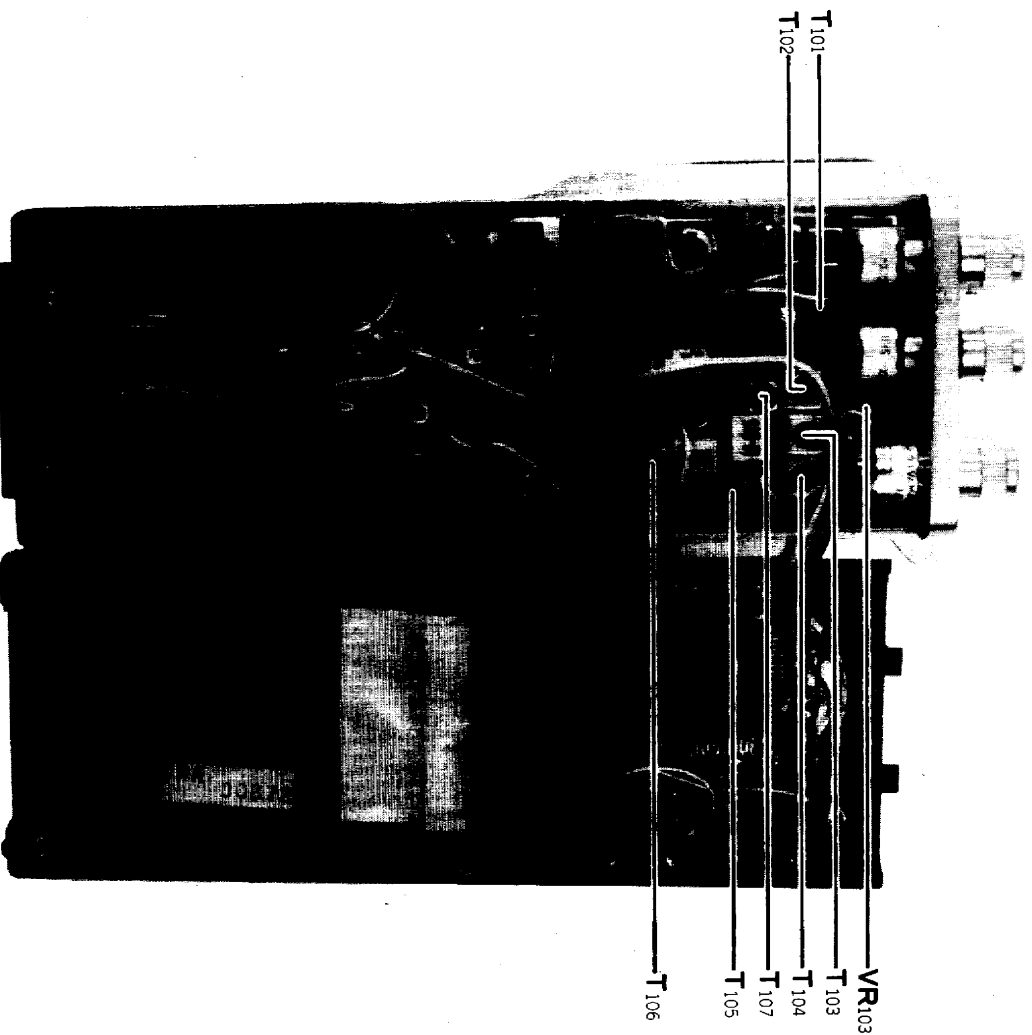

RECEIVER SECTION ALIGNMENT POINTS

II. Receiver Alignment

A. 1st, 2nd IF Alignment

1. Connect a signal generator to the ANT connector, and set the frequency to 146 MHz (145 MHz), with 1 kHz modulation @ ± 3.5 kHz deviation, and the output level to 20 dB (ref: 0 dB = 1 μ V). Connect an oscilloscope to the earphone jack as shown in the figure.

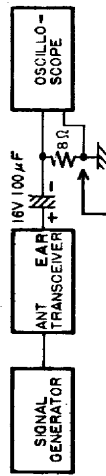

Connect this ground to the BNC jack.

Figure 1

2. Adjust the cores of T_{105} , T_{106} and T_{107} until a minimum distortion pattern and maximum output are observed on the oscilloscope.

B. RF Coil Adjustment

1. Set the transmitter frequency and signal generator to 147.995 MHz (145.975 MHz or 147.975 MHz), and adjust T_{101} , T_{102} , T_{103} and T_{104} for minimum distortion and maximum amplitude on the oscilloscope. Now, set the transmitter frequency to 144.000 MHz, and again adjust T_{101} to T_{104} . Repeat this alignment at both lower and upper band edges until maximum sensitivity is obtained on both band edges.

C. Squelch Adjustment

1. Apply a -8 dB signal with 1 kHz modulation @ ± 3.5 kHz deviation to the ANT jack, and set the frequency to 146 MHz (145 MHz). Then set the transmitter to the same frequency.
2. Rotate the SQL control knob fully counterclockwise, and adjust VR_{103} so that the squelch just opens.

2. To enter 146.025 MHz, press "6025" on the keyboard. The digital display will now show these digits. Now press the DIAL key, and the decimal point will appear between the "6" and the "025". You are now operating on 146.025 MHz.

3. Let's try another example: To operate on 147.725 MHz, press "7725" and DIAL.

[Models B and C]

1. When a frequency is entered from the keyboard, the four digits above the 1 kHz digit must be entered. This frequency must be divisible by 12.5 kHz. [Example: 5.012(5), 5.500(0)].

2. To enter 145.0125 MHz, press "5012" on the keyboard. The last digit of "5" does not have to be entered. Now press the DIAL key, and the decimal point will appear between the "5" and the "012", with a small "5" displayed after the "012".

You are now operating on 145.0125 MHz.

3. Let's try another example: To operate on 145.1875 MHz, press "5187" and DIAL, and the display will show 5.1875.

C. Entry and Recall of Memory Channels

1. To store a frequency in memory, the desired frequency is first entered on the display. Then press the desired memory channel number, 0 to 9, and then press M. Now the frequency is stored in the memory.
2. To store 145.475 MHz in memory channel 1, press "5475", DIAL, "1", and then "M".
3. Now store another frequency in memory channel 2. For example, to store 145.125 MHz press "5125", "DIAL", "2", and then "M".
4. Now memory channels 1 and 2 have been programmed. If you desire additional memory channels, store the frequencies in the same manner described in Steps 2 and 3.
5. To recall a memory channel, push the desired memory channel number (0 to 9) and then "MR". For example, to recall the frequencies stored in the above examples, first press "1" and then "MR". The digital display will show "5.475", which is the frequency stored in memory

channel 1. To recall memory channel 2, press "2" and then "MR". The display will then show "5.125". If other memory channels have been stored, press the corresponding channel number and "MR", and the digital display will show the desired frequency. (The last frequency displayed before the DIAL button was pushed)

6. To return to the dial frequency, press "DIAL", and the display will return to 5.125, unless other frequencies were stored in the memory channels during Step 4. If you wish to operate on frequencies other than the memory channel, press the keys for the desired frequency and "DIAL". The display will then show the frequency and allow operation on that frequency. For example, press "5775" and "DIAL" to operate on 145.775 MHz.

D. Priority Channel Operation

1. First enter into the memory channels all desired frequencies for priority use.
2. Now enter another frequency onto the dial. In this example, we will use 145.500 MHz. Press "5500" and "DIAL". The display will show "5.500".
3. Now recall any of the stored memory channels. As 145.125 MHz was previously stored in memory channel 2, press "2" and "MR" to recall that frequency. Now press the "#" key. The display will indicate "5.500 P", and every few seconds the display will switch to the memory channel "5.125".
4. When the CLEAR-MAN-BUSY switch is in the BUSY position, the transceiver will lock on the memory channel when a carrier appears on that frequency. If you place the CLEAR-MAN-BUSY switch in the CLEAR position, the search will stop when the memory channel is clear (no signal is present).
5. To use different memory channels with priority channels, enter the priority frequency from the keyboard and press "DIAL". Now press the number of the desired memory channel for recall, and then press the "#". The transceiver will search the memory channel from the dial frequency every few seconds.

for a maximum reading on the VTVM. The nominal value is approximately 300 mV rms.

F. TX Frequency Adjustment

1. Set the transceiver to 146.000 MHz (145.000 MHz).
2. Connect a frequency counter to the secondary of T₂₁₀, and adjust the core of T₂₀₅ for a reading of exactly 146 MHz (145 MHz).

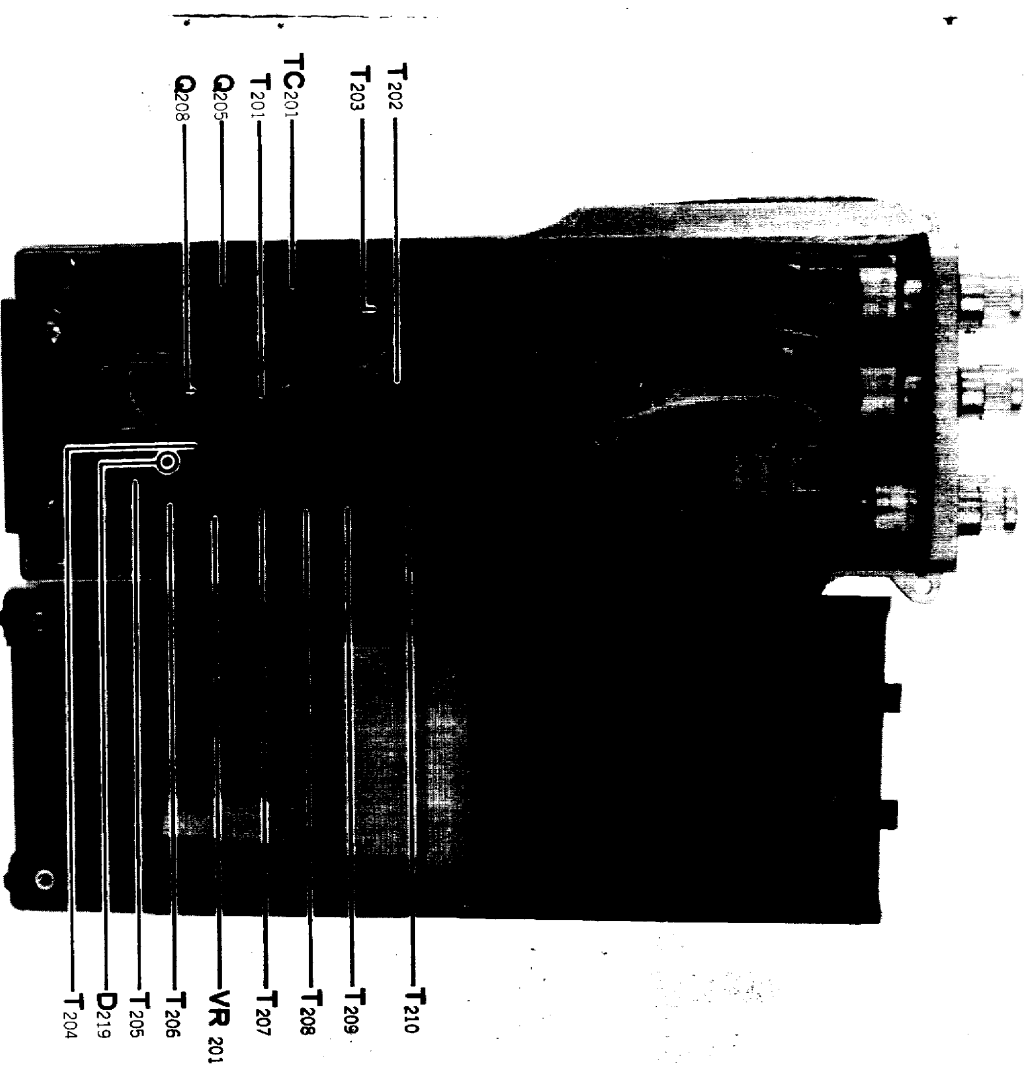

PLL SECTION ALIGNMENT POINTS

I. PLL Alignment

A. VCO Alignment

1. Connect a DC voltmeter to the collector of Q₂₀₈. (2SC2785E).
2. Set the transceiver to 144.000 MHz.
3. Adjust the core of T₂₀₁ for a reading of exactly 1.5 volts on the voltmeter.
4. Now set the transceiver to 147.995 MHz (145.975 MHz or 147.975 MHz), and check to see that the DC voltmeter shows more than 5.5 volts.

B. PLL IF Alignment

1. Set the transceiver to 147.995 MHz (145.975 MHz or 147.975 MHz).
2. Connect the RF probe of a VTVM to the collector of Q₂₀₅, and adjust the cores of T₂₀₂ and T₂₀₃ for maximum deflection on the VTVM. The nominal value is approximately 1 volt rms.

C. PLL Local Frequency Adjustment

1. Set the transceiver to 146.000 MHz (Model: A, C, D, E) or 145.000 MHz (Model: B).
2. Connect a frequency counter to the cathode of D₂₁₉ and adjust TC₂₀₁ for a reading of exactly 129.100 MHz (128.100 MHz).
3. Now set the frequency to 144.000 MHz, and check to see that the frequency counter shows a frequency of exactly 127.100 MHz. Then set the transceiver frequency to 147.995 MHz (145.975 MHz or 147.975 MHz), and check to see that the counter frequency is 131.095 MHz (129.075 MHz, 131.075 MHz)

D. PLL Output Coil Alignment

1. Set the transceiver to 147.995 MHz (145.975 MHz or 147.975 MHz).
2. Connect the RF probe of a VTVM to the cathode of D₂₁₉, and adjust the core of T₂₀₄ for a maximum reading on the VTVM. The nominal value is approximately 300 mV rms.

E. TX Bandpass Filter Alignment

1. Set the transceiver to 147.995 MHz (145.975 MHz or 147.975 MHz).
2. Connect a dummy load to the ANT connector, and connect the RF probe of a VTVM to the secondary of T₂₁₀.
3. Now close the PTT switch and adjust the cores of T₂₀₆ through T₂₁₀

E. Repeater Operation

1. Repeater shifts of +600 kHz and -600 kHz are built into the FT-208R. To select the shift frequency, set the SHIFT switch to either the +RPT or -RPT position.
2. When nonstandard repeater shifts (other than ±600 kHz shifts) are required, the repeater shift can be programmed from the keyboard. For example, to program a split of ±700 kHz, push "0700" and then the "S" key. Now the repeater shift is programmed. Set the SHIFT switch to the +SET position, and close the PTT switch. The display will indicate the frequency that is +700 kHz from the receive frequency. If the SHIFT switch is in the -SET position, the transmit frequency will be -700 kHz from the receive frequency. (See Page 22 Error Modes)

F. Split Operation

1. To transmit on the dial frequency and receive on one of the memory frequencies, set the SHIFT switch to the MS position, and enter the desired transmit frequency from the keyboard.
2. Now recall the desired memory channel for receive. Close the PTT switch, and the display will indicate the dial frequency during transmission. Release the PTT switch to return to the receive mode (on the memory channel).

G. Scanner Operation

1. With the CLEAR-MAN-BUSY switch in the MAN position and the STEP switch in the X1 position (left side), press the UP or DOWN switch to move 5 kHz (12.5 kHz) up or down, respectively. If you push and hold the UP or DOWN switch for more than 1 second, the scanner will become activated.

2. To stop the scan, press the UP, DOWN, or PTT switch. If you hit the PTT switch while scanning, no transmission will occur. Release the PTT switch momentarily, then press the PTT switch again to transmit.
3. To stop the scanner on a busy or clear channel, place the CLEAR-MAN-BUSY switch to the desired position, and press the UP or DOWN switch for a moment. The scanner will search until a busy or clear channel is found. After a 5 second stop on the channel for monitoring, the scanner will again start to search other channels. If you wish to stop on a channel, momentarily close the PTT switch.
4. To scan only the memory channels, press the MR switch, and then either the UP or DOWN switch. The scanner will move to search all ten memory channels. Press the PTT switch on the channel you wish to remain on. You may choose the desired scan mode as described in the above steps.

H. Limited Band Scanner Operation

1. To scan between a dial frequency and one of the memory channels, enter the desired frequency from the keyboard, and then call the memory frequency and press the “#” key. The priority function will then be activated. Now, press either the UP or DOWN switch. If UP is pressed with the CLEAR-MAN-BUSY switch in the MAN position, the display will scan from the dial frequency to the memory channel continuously. If the CLEAR-MAN-BUSY switch is placed in the BUSY position, the scanner will stop at a channel where a carrier is present, and start scanning again after 5 seconds.
2. For example, enter 145.750 into memory channel 1, and press “4750”. Next, press “DIAL”, “1”, “MR”, and finally “#”. The priority function will then be activated. When the UP switch is pressed, the transceiver will scan up to “5.750”, and then the display will jump back to 144.750 MHz, continuing the scan up to 145.750 MHz again.

MAINTENANCE AND ALIGNMENT

The FT-208R has been carefully aligned and tested at the factory prior to shipment. The solid state discrete devices and integrated circuits used in the FT-208R should provide many years of trouble-free service, if the transceiver is not abused and if routine maintenance is carried out.

Periodic cleaning of the interior of the transceiver may be required if the unit is used in a dusty environment. A vacuum cleaner may be used to remove loose dirt, while a small brush will help in dislodging caked dirt. The exterior may be wiped with a damp cloth whenever necessary.

Should feeble power output or degraded receiver sensitivity indicate the need for alignment, we recommend that the transceiver be returned to your Yaesu dealer, as the test equipment and expertise required to align the FT-208R can be obtained there. Any attempt to align this transceiver without the proper equipment and knowledge may result in seriously degraded performance.

ALIGNMENT

Equipment Required:

- Signal generator good to 150 MHz
- Audio voltmeter
- VTVM
- VOM
- Audio oscillator
- Oscilloscope
- Linear detector (deviation meter)
- Dummy load/wattmeter (50 ohms, 150 MHz)
- Frequency counter good to 150 MHz
- Directional coupler
- Spectrum analyzer

REMOVAL OF THE TRANSCEIVER CASE

1. Remove the battery case cover and the Ni-Cd battery pack from the transceiver as you would usually do when replacing the battery pack.
2. Remove the four screws affixing the rear case in the Ni-Cd battery compartment and carefully remove the rear case and front panel.

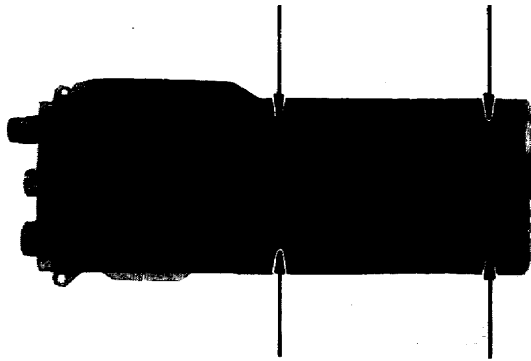

3. If the DOWN key is pressed instead, the display will scan from 144.750 MHz to the low band edge of "4.000" and then jump to the high band edge of "7.995 (5.9875, 7.9875)". From this band edge, the scanning moves to the memory frequency of "5.750", and then jumps to the dial frequency of "4.750", omitting the frequencies in between. This scanning function will repeat itself until you stop on a specific frequency.

Note:

The following frequencies cannot be programmed as band edges for the limited band scanning function:

Model: A, D, E: "4.000", "4.005", "4.005", "7.990", "7.990", "7.995"
 Model: B : "4.000", "4.0125", "5.975", "5.9875", "5.9875"
 Model: C : "4.000", "4.0125", "7.975", "7.975", "7.9875"

I. Miscellaneous

1. To disable the keyboard and lock the FT-208R on the frequency you are currently using, slide the LOCK switch to the right. This will provide protection against accidental frequency changes. When the LOCK switch is moved to the right, the display will indicate "L". Locking the keyboard will not disable the two-tone (DTMF) generator during transmission.
2. To activate the memory backup in the CPU, place the BACKUP switch in the ON position. The built-in lithium battery will serve to backup the memory frequency, programmable shift frequency, etc., while the power switch is OFF, or while the transceiver is without battery power. The battery has an estimated lifetime of more than 5 years. After this period, please ask your Yaesu Dealer for a replacement.
3. The top panel HIGH-LOW switch may be set to either the HIGH (2.5 watts output) or LOW (300 mW output) position, allowing you to select different transmitter output powers. Use the LOW position whenever possible to prolong battery life.

MODEL	A	B	C	D	E
Frequency Range (MHz)	144.000- 147.995	144.000- 145.9875	144.000- 147.9875	144.000- 147.995	144.000- 147.995
RX 1st Local (MHz) (PLL out)	127.100- 131.095	127.100- 129.0875	127.100- 131.0875	127.100- 131.095	127.100- 131.095
RX 2nd Local (MHz)	17.355	16.445	16.445	17.355	17.355
PLL Local (MHz)	125.595 (41.865x2)	124.5875 (41.52916x3)	124.5875 (41.52916x3)	125.595 (41.865x3)	125.595 (41.865x3)
PLL IF (MHz)	1.505-5.500	2.5125-4.500	2.5125-6.500	1.505-5.500	1.505-5.500
Divider (1/N) Ratio	1/301-1/1100	1/201-1/360	1/201-1/520	1/301-1/1100	1/301-1/1100
Reference Frequency (kHz)	5 (5760/1152)	12.5 (7200/576)	12.5 (7200/576)	5 (5760/1152)	5 (5760/1152)

J. Error Modes

1. If you inadvertently program a frequency incorrectly (e.g., by pushing "7353" and DIAL), the display will indicate "E" to tell you an error has been made. If this occurs, push C (Clear) to return to the previous frequency.
2. If you program a repeater shift outside the amateur band, such as -600 KHz shift at 144.500 MHz, the display will indicate "E" when the PTT switch is closed. No transmission will occur under this condition.

K. Tone Squelch Operation (Option)

1. When the optional FTS-32 tone squelch unit is installed, it may be activated by placing the SQL control in the TONE position (click-stop).
2. When a signal is received which contains a similar subaudible tone signal, the FT-208R squelch will open normally. If the incoming signal does not contain the subaudible tone squelch signal, the receiver will remain silent, but the BUSY indicator will become illuminated. This will alert the operator to the fact that the channel is in use.
3. On transmit, a subaudible tone will be superimposed on your voice signal, activating the receiver of other stations equipped with a similar tone squelch system. The tone frequency (both transmit and receive) can be selected by the DIP switch mounted on the FTS-32. Refer to the frequency chart supplied with the optional FTS-32 to determine the setting for the tone frequency you require.
4. For autopatch or control purposes, the two-tone (DTMF) encoder can be activated from the keyboard by pushing the PTT switch and dialing the required access codes and telephone number.

For installation information regarding the FTS-32 Tone Squelch and FTS-32AE Tone Encoder, please refer to the instructions supplied with the respective units.

The IF signal is fed to a balanced mixer, Q_{214}/Q_{215} (2SK193K), where the 16.9 MHz FM signal is mixed with a local signal from the VCO, with the output being at the ultimate transmitting frequency. A three-stage auto-tune resonator between Q_{214}/Q_{215} and Q_{216} , along with a filter immediately following Q_{216} (2SC2786L), provide superior rejection of spurious signals.

The signal is delivered to a three-stage RF power amplifier consisting of Q_{101} (2SC2512), Q_{102} (2SC2053), and Q_{103} (2SC2196), resulting in a power output of 2.5 watts.

HETERODYNE OSCILLATOR

The heterodyne signal of 127.100-131.095 MHz (Model A, D, E), 127.100-129.0875 MHz (Model B), 127.100-131.0875 MHz (Model C) for the receiver and transmitter is generated by a PLL (Phase Locked Loop) circuit.

The VCO, Q_{201} (2SK192Y), generates a signal of one of the above frequencies. The oscillator frequency is controlled by varactor diode D_{201} (1T25), which varies the capacitance of the oscillator tuned circuit in accordance with a control voltage. This control voltage is generated by phase comparator Q_{206} (μ PD2819C) and delivered through a lowpass filter consisting of Q_{207} (2SK184Y) and Q_{208} (2SC2785E), to the VCO.

This voltage is then fed to varactor diode D_{201} , which changes the output phase of the VCO to lock with that of the reference signal. The control voltage is also used to tune the transmitter bandpass filters and local signal amplifier filter, thus providing optimum spurious attenuation.

PLL CONTROL SECTION

The PLL control Unit employs a 4-bit microprocessor chip, Q_{301} (HD-44820A61), which provides various control information for display control, transmit disable, DTMF encoder, etc. The reader is referred to the block diagram of the PLL control Unit for an explanation of the functions of the CPU. A full description of each logic state is beyond the scope of this manual.

When a carrier is present in the 455 kHz IF, the noise is removed from the discriminator output, and Q_{114} is then biased for normal operation, thus allowing receiver recovery. VR_{102} sets the squelch sensitivity level. Scanning control voltages are also provided by Q_{109} , allowing interactive operation with the Central Processing Unit for control of the SCAN STOP function.

TRANSMITTER

The transmitter produces a frequency modulated signal. The audio input from the microphone or DTMF encoder Q_{304} (MK5087) is amplified by Q_{217} (μ PC577H), which also limits the maximum amplitude of the audio input and filters out signal components above the normal speech range. The audio signal is then applied to varactor diode D_{209} (FC53), which varies the frequency of a 16.9 MHz crystal oscillator, Q_{213} (2SC2786L). This signal is then delivered to the balanced mixer and amplifier stages.

A portion of the output from VCO (Voltage Controlled Oscillator) Q_{201} (2SK192Y), is fed through buffer amplifier Q_{202} (2SC2786L) to PLL (Phase Locked Loop) mixer Q_{203} (2SC2786L), where the signal is mixed with a local signal of 125.595 MHz (Model A, D, E) or 124.5875 MHz (Model B, C) delivered from Q_{209} (2SC2786L). This results in a 1.505–5.500 MHz (Model A, D, E) or 2.5125 MHz–4.500 MHz (Model B), 2.5125 MHz–6.500 MHz (Model C) PLL IF signal.

The PLL IF signal is amplified by Q_{204} and Q_{205} (2SC2786L) and then fed to Q_{206} (μ PD2819C). This programmable divider divides the signal by a factor of 301–1100 (Model A, D, E), 201–360 (Model B), 201–520 (Model C), producing basic 5 kHz (Model: A, D, E), 12.5 kHz (Model: B, C) steps for the synthesizer. One section of Q_{206} acts as a 5.76 MHz (Model A, D, E) or 7.2 MHz (Model: B, C) oscillator, which, in turn, is divided into 5 kHz (12.5 kHz) steps. The phase comparator section of Q_{206} then compares the phase of the PLL IF signal with that of the PLL reference signal, and any difference in phase produces an error-correcting voltage, which is used to control varactor diodes to lock the PLL onto the correct frequency. This feedback system produces a highly stable output signal.

Memory Backup Information

The FT-208R memory channels are protected by a memory backup lithium cell in the transceiver. When the transceiver is delivered from our factory, the memory backup switch is in the OFF position in order to clear the information in the memory. To activate the memory backup, turn the memory backup switch in the battery compartment to the ON position. Once this switch is turned on, it is not necessary to turn it off because of the extremely low current consumption of approximately $0.1 \mu\text{A}$. The estimated life of the cell is more than five years. If, after this period, the memory backup becomes intermittent, ask your Yaesu dealer for a replacement cell. The life of the lithium battery is not extended significantly by keeping the backup switch OFF.

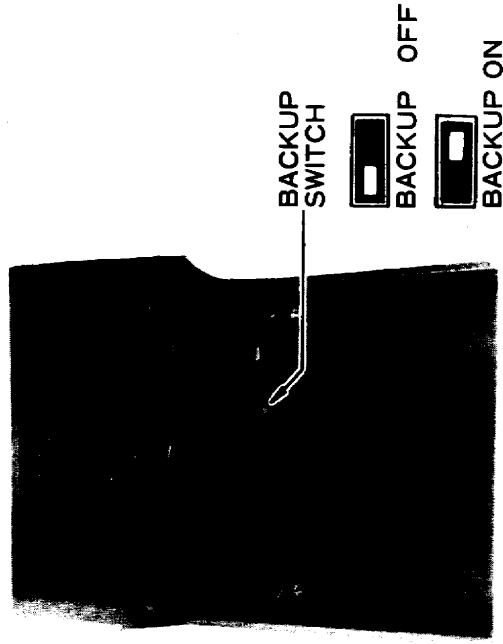

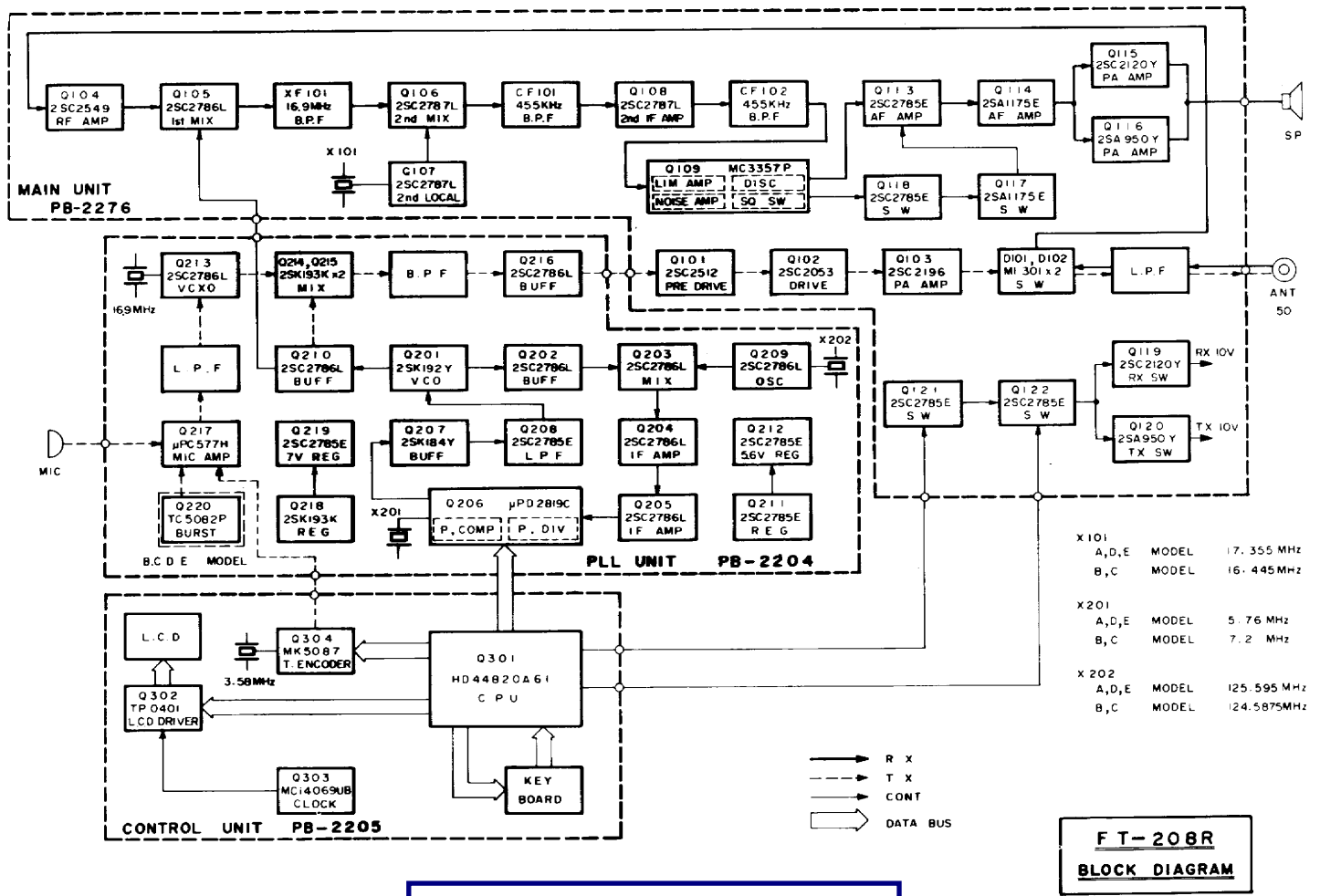

FT-208R
BLOCK DIAGRAM

Downloaded by
Amateur radio Directory

CIRCUIT DESCRIPTION

The block diagram and circuit description to follow will provide the owner with a better understanding of the FT-208R transceiver. Please refer to the schematic diagram for component details.

RECEIVER

The VHF signal from the antenna is fed through a lowpass filter and antenna diode switch to RF amplifier Q104 (2SC2549), which is protected by a three-stage bandpass filter to minimize intermodulation caused by strong out-of-band signals. The amplified signal from Q104 is fed to the first mixer, Q105 (2SC2786L), where the RF signal is mixed with the first LO signal delivered from the PLL unit, producing a 16.9 MHz first IF. The IF signal is passed through a monolithic crystal filter, XF101, which has a 3 dB bandwidth of ±14 kHz, and is fed to the second mixer, Q106 (2SC2787L). Here the first IF signal is heterodyned with the second local oscillator signal 17.355 MHz (Model: A, D, E) or 16.445 MHz (Model: B, C) delivered from Q107 (2SC2787L), resulting in a second IF of 455 kHz. The IF signal is passed through a ceramic filter, CF101; amplified by Q108 (2SC2787L), then fed through another ceramic filter, CF102. The highly filtered IF signal is then fed to Q109 (MC3357), which functions as an IF amplifier, limiter, discriminator, and squelch control. The amplification and limiting process eliminates amplitude variations in the IF signal, which is then fed to the discriminator section of Q109, where an audio response is produced in accordance with a corresponding frequency shift in the IF signal. The audio signal is then amplified by Q113 (2SC2785E), Q114 (2SA1175E), Q115 (2SC2120Y), and Q116 (2SA950Y). The audio PA section delivers 500 mW of audio output power to the speaker.

When no carrier is present in the 455 kHz IF, the high frequency noise at the output of the discriminator is amplified by the noise amplifier section of Q109. This amplified signal drives a squelch switch in the same IC, which in turn biases Q118 (2SC2785E) and Q117 (2SA1175E) such that DC voltage is removed from AF amplifier Q114, thus silencing the receiver.