

FT-209R TECHNICAL SUPPLEMENT

SCHEMATHEEK

Beh. T. Hultermans

Postbus 4228

5604 EE Eindhoven

This booklet contains supplemental technical information related to the FT-209R for use with the FT-209R Operating Manual. Service or repairs to the FT-209R transceiver should be performed by qualified technicians only.

Provided by
<http://www.yaesu-museum.com>

Downloaded by
Amateur Radio Directory

YAESU MUSEN CO., LTD.
C.P.O. BOX 1500
TOKYO, JAPAN

CHIP DESCRIPTION AND MARKINGS

Bipolar Transistors

Part (Location) No.	Nomenclature	Marking
Q2015,2017,2020	2SA812(M6/M7)	M6/M7
Q1010,1015,1017, 2019,2021	2SA1162GR	SG
Q2001,2003,2016, 2018,2022	2SC1623(L6/L7)	L6/L7
Q1002,2005,2010	2SC2620B	QB
Q1004,1005,1008, 1009,1012,1013, 1016,1018,2008	2SC2712GR	LG
Q2011,2012	2SC2759	U22
Q2009	2SC3120	HB
Q1001	2SC3356	R22
Q4002,4004	2SC3397*	DY

* Bias resistors included

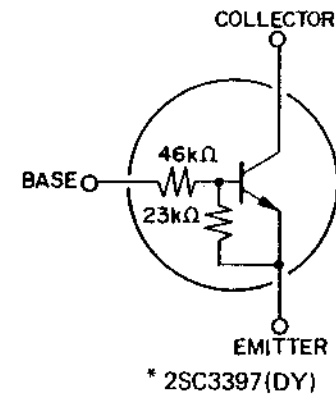
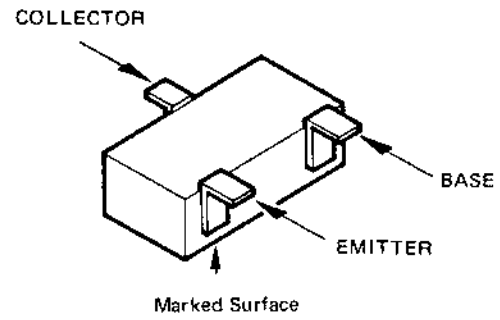
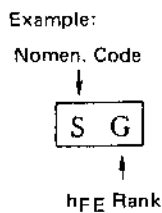

FET

Q2004	2SK210Y	Y Y
-------	---------	-----

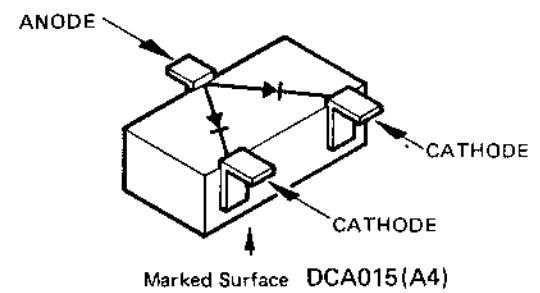
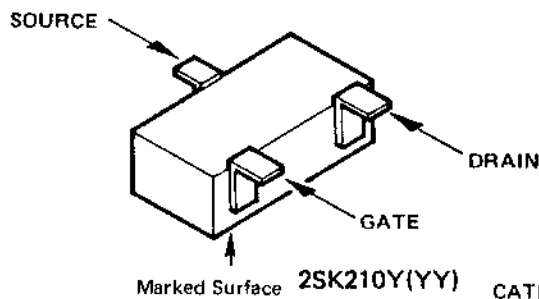
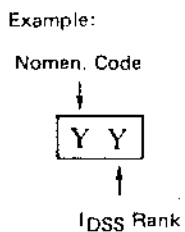

Dual Diodes

D1008,2010,2011, 2012	1SS184	B 3
D1015,2013	1SS226	C 3
D4002,4004	DCA015	A 4

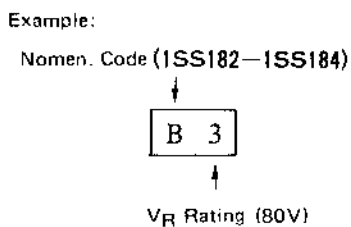

B1 = 1SS182 (30V)
 B2 = 1SS183 (50V)
 B3 = 1SS184 (80V)
 C1 = 1SS224 (30V)
 C2 = 1SS225 (50V)
 C3 = 1SS226 (80V)
 A4 = DCA015

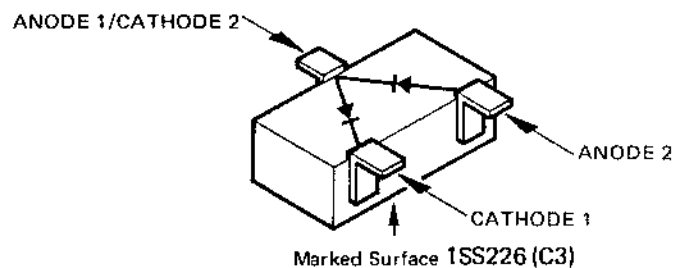
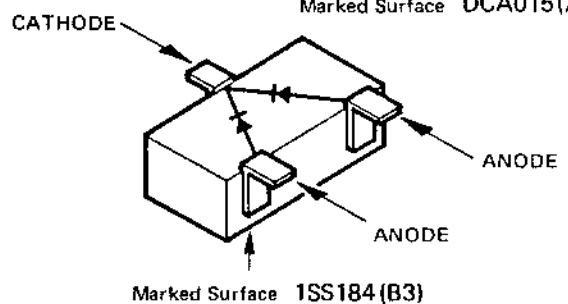

Resistors

Type RMC 1/10W
Marking* A1 Z6

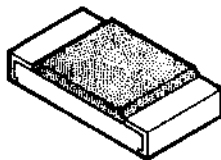

Value code				Multiplier code	
A	1.0	N	3.3	0	1
B	1.1	P	3.6	1	10 ¹
C	1.2	Q	3.9	2	10 ²
D	1.3	R	4.3	3	10 ³
E	1.5	S	4.7	4	10 ⁴
F	1.6	T	5.1	5	10 ⁵
G	1.8	U	5.6	6	10 ⁶
H	2.0	V	6.2		
J	2.2	W	6.8		
K	2.4	X	7.5		
L	2.7	Y	8.2		
M	3.0	Z	9.1		

Examples:

A1 = 10Ω
J3 = 2.2kΩ
S4 = 47kΩ

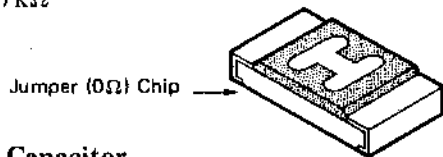

Tantalum Capacitor

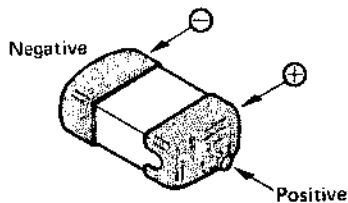

Polarized, Unmarked
(determine value from layout and Parts List)

Ceramic Capacitors

Types: C2012
C3216 (only 0.1μF used in FT-209R)

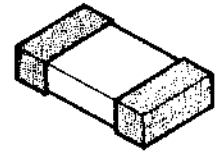

Marking* C3216 (Bar) C2012

Value code						Multiplier code	
A	1.0	M	3.0	Y	8.2	0	1
B	1.1	N	3.3	Z	9.1	1	10 ¹
C	1.2	P	3.6	a	2.5	2	10 ²
D	1.3	Q	3.9	b	3.5	3	10 ³
E	1.5	R	4.3	d	4.0	4	10 ⁴
F	1.6	S	4.7	e	4.5	5	10 ⁵
G	1.8	T	5.1	f	5.0	6	10 ⁶
H	2.0	U	5.6	m	6.0	7	-
J	2.2	V	6.2	n	7.0	8	10 ⁻²
K	2.4	W	6.8	t	8.0	9	10 ⁻¹
L	2.7	X	7.5	y	9.0		

C3216 types use a bar marking for either thermal coefficient or tolerance ranking, (according to capacitance value range) as below

Temperature Compensating Types (low values) No bar = SL-type

NPO(CH)	N150(PH)	N220(RH)	N330(SH)	N470(TH)	N750(UJ)
□□	□□	□□	□□	□□	□□

Dielectric Constant (Hi K) Types (high values)

B	D	No bar = F
□□	□□	

Example:

A1 10pF NPO
J31 0.0022μF D
1A3 0.001μF B

Cap. Tolerance

B = 10%
D = 20%
F = +80%/-20%

SEMICONDUCTOR CROSS-REFERENCE

PART LOCATION No.	ORIGINAL	REPLACEMENT		
	NOMENCLATURE (MARKING) AND PART NUMBER	NOMENCLATURE (MARKING) AND PART NUMBER		
	Q1004,1005,1008,1009,1012,1013,1016,1018	2SC1623L6/L7(L6/L7) G3316230F/G	2SC2712GR/BL(LG/LL) G3327120G/B	2SC2462C/D(LC/LD) G3324620C/D
Q1010,1015,1017	2SA1162GR(SG) G3111620G	2SA812M6/M7(M6/M7) G3108120F/G	2SA1052C/D(MC/MD) G3110520C/D	2SA1179F/G(M6/M7) G311179F/G
Q2001,2003,2016,2018,2022	2SC2712GR/BL(LG/LL) G3327120G/B	2SC1623L6/L7(L6/L7) G3316230F/G	2SC2462C/D(LC/LD) G3324620C/D	2SC2812F/G(L6/L7) G3328120F/G
Q2005,2010	2SC2620B(QB) G3326200B	2SC2757T33(T33) G3327570B		
Q2009,2012	2SC2759U22(U22) G3327590B	2SC3120(HB) G3331200		
Q2015,2017,2020	2SA812M6/M7(M6/M7) G3108120F/G	2SA1162GR(SG) G3111620G	2SA1052C/D(MC/MD) G3110520C/D	2SA1179F/G(M6/M7) G3111790F/G
Q2019,2021 (Not 2SA812)	2SA1162GR(SG) G3111620G	2SB624BV4/5(BV4/BV5) G3206240D/E	2SA1052C/D(MC/MD) G3110520C/D	
D1008,2010,2011,2012	1S5184(B3) G2070009	1S2838(A6) G2028380	DCB015TA(A6) G2070012	
D1015	1S5226(C3) G2070003	1S5123(A7) G2070020		

Use original types only for Q1002, Q1008 and Q2011.

RX UNIT (obverse view of "mixed component" side)

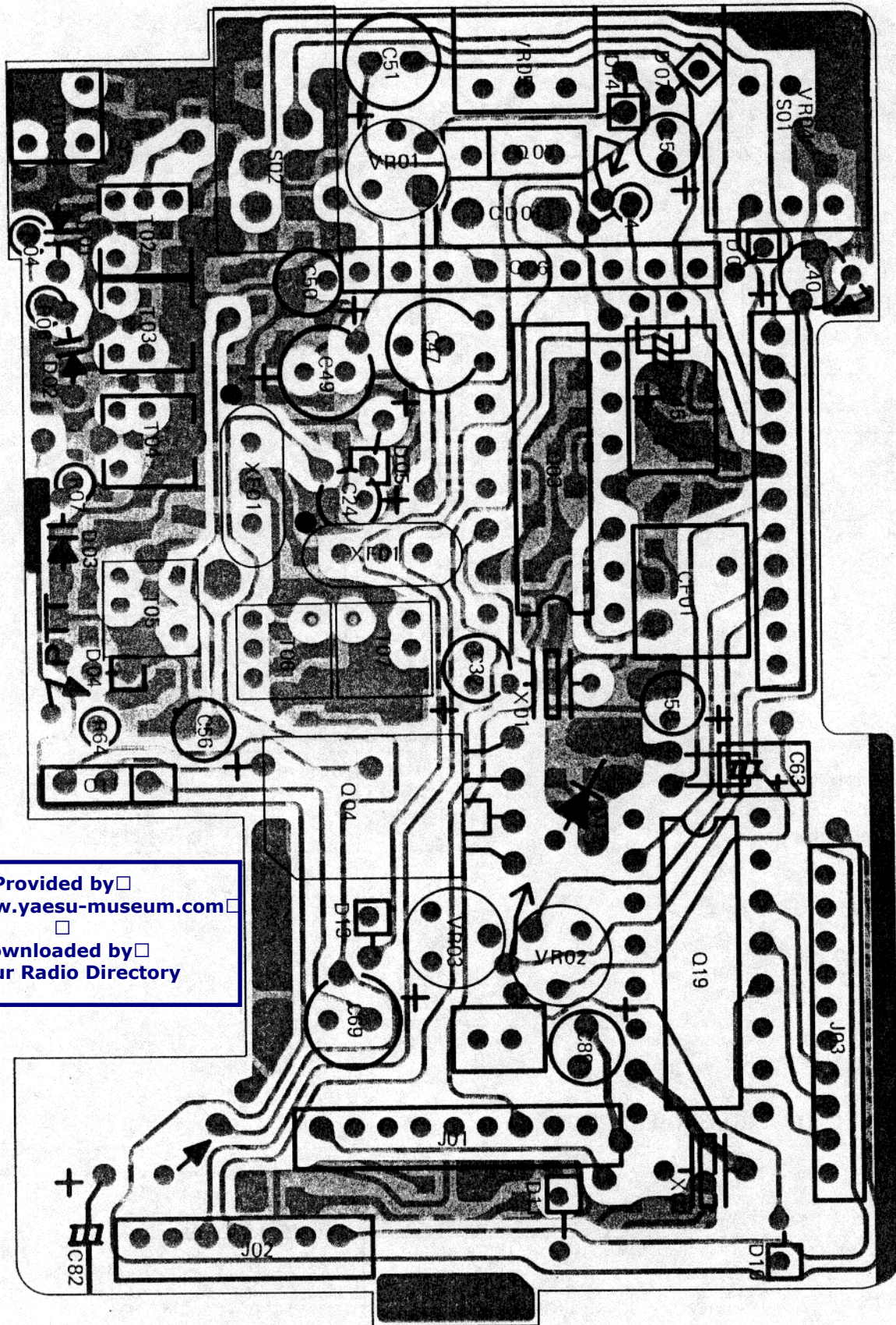

Provided by <http://www.yaesu-museum.com>

 Downloaded by Amateur Radio Directory

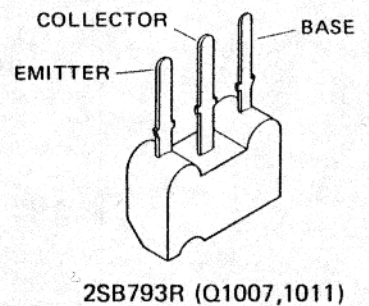
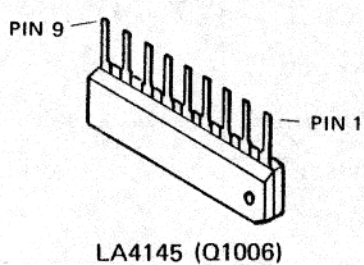
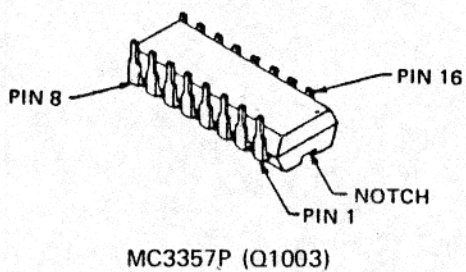

RX UNIT (reverse view of "chip-only" side)

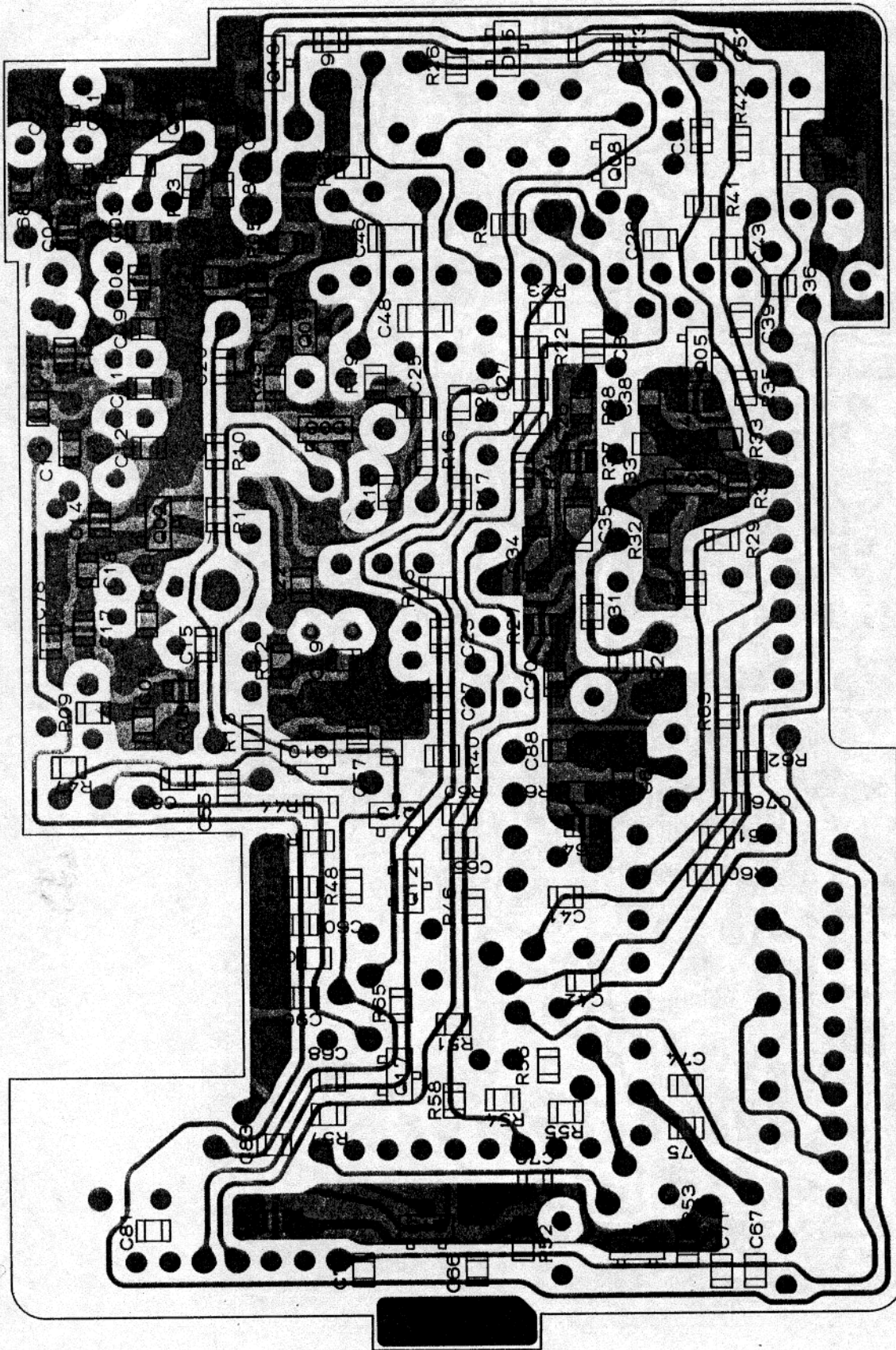

SCHEMATHEEK
Beh. T. Hultermans
Postbus 4228
5604 EE Eindhoven

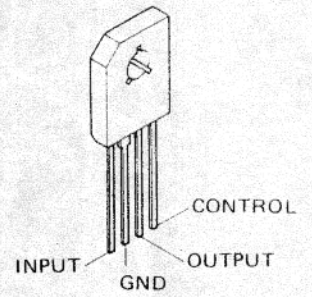

LA5005H (Q1004)

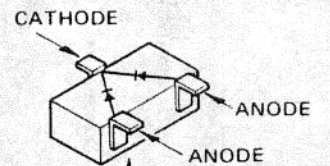

Marked Surface
1SS184(B3) (D1008)

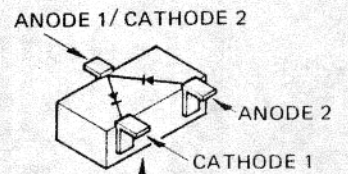

Marked Surface
1SS226(C3) (D1015)

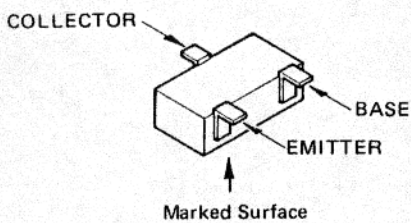

2SA1162GR(SG) (Q1010,1015,1017)
2SC2620B(QB) (Q1002)
2SC2712GR(LG) (Q1004,1005,1008,
1009,1012,1013,
1016,1018)
2SC3356(R22) (Q1001)

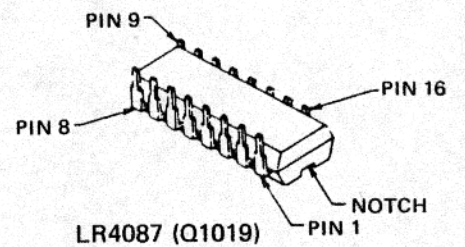

RX UNIT (obverse view of "chip-only" side)

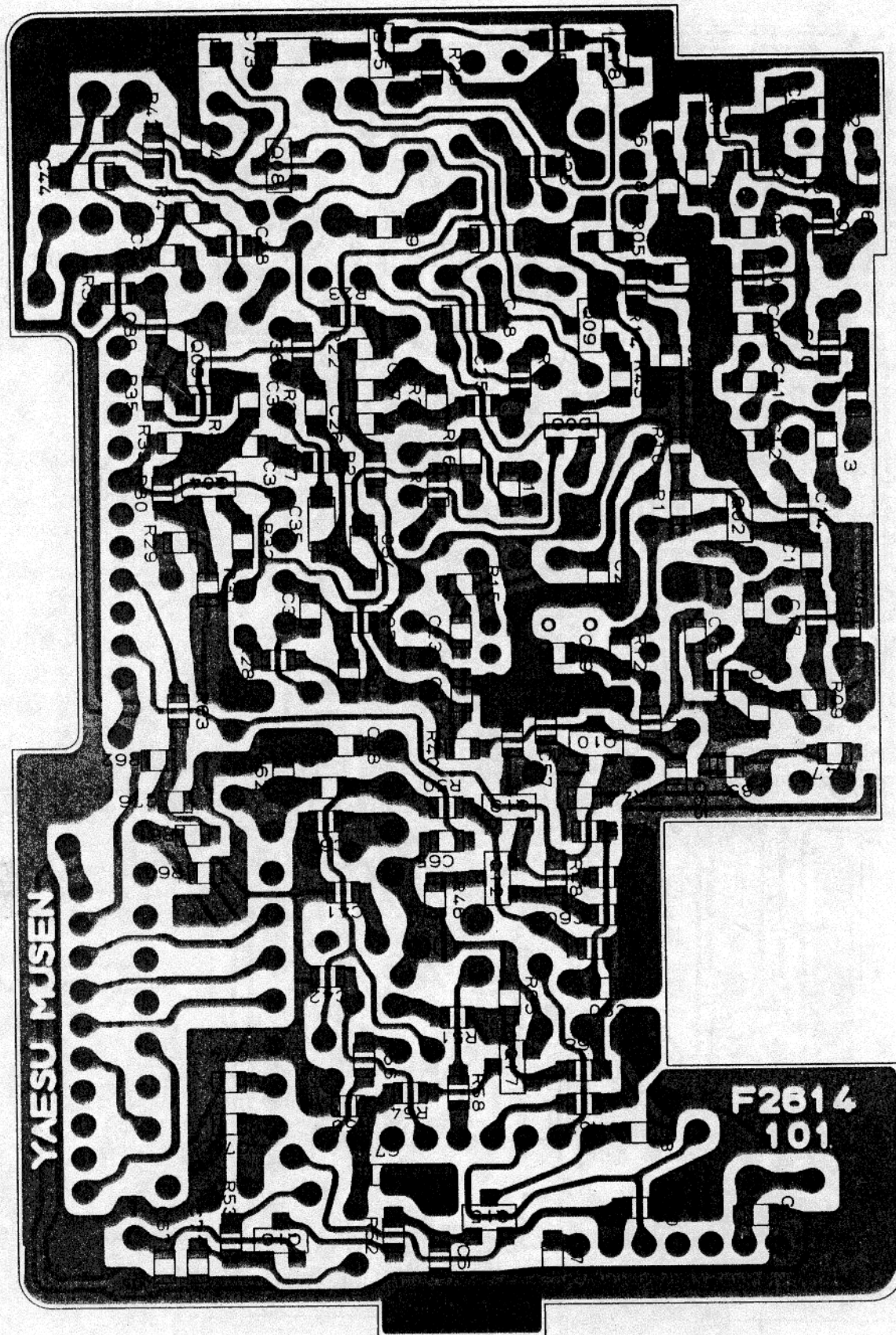

Provided by
<http://www.yaesu-museum.com>

Downloaded by
Amateur Radio Directory

RX UNIT (reverse view of "mixed component" side)

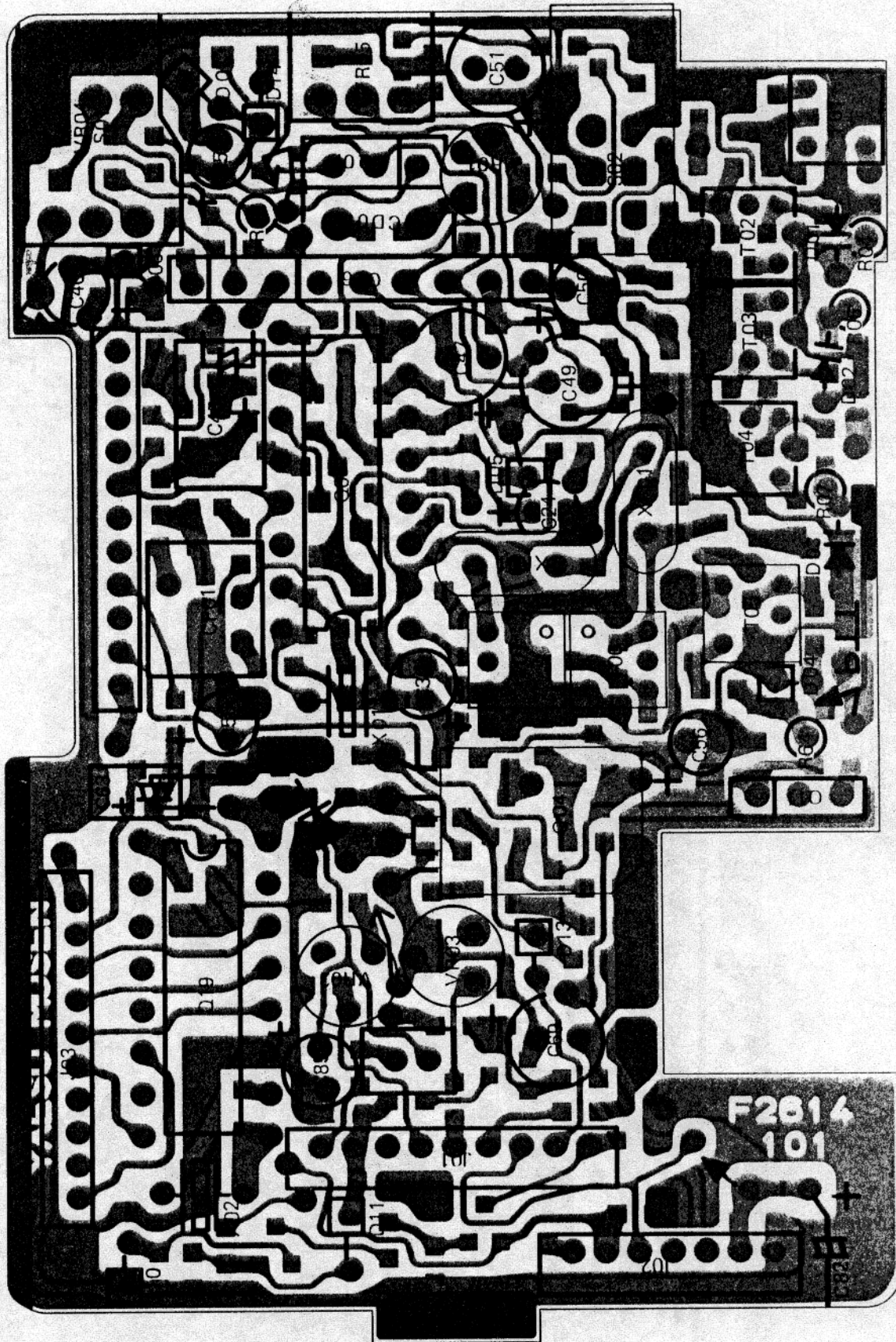

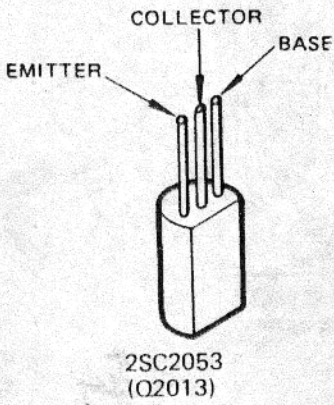
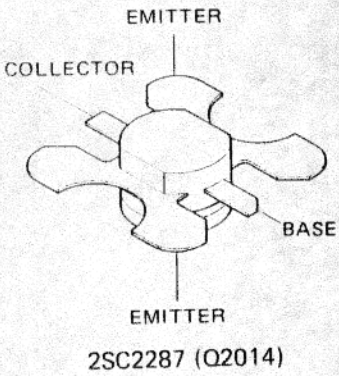
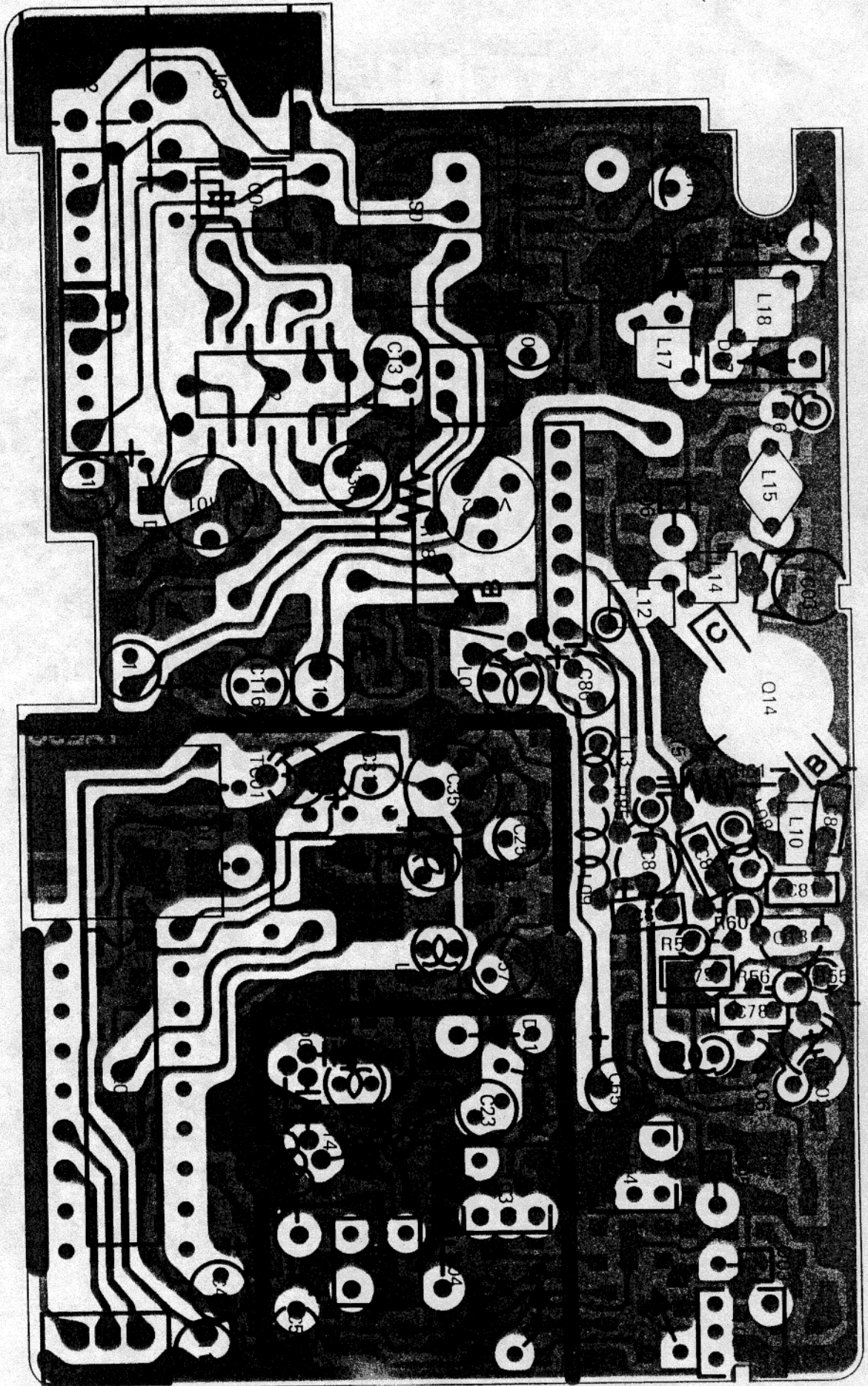

SCHEMATHEEK
Beh. T. Hultermans
Postbus 4228
5604 EE Eindhoven

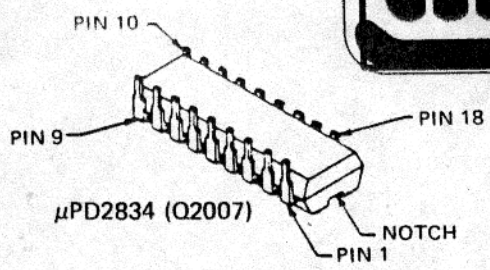
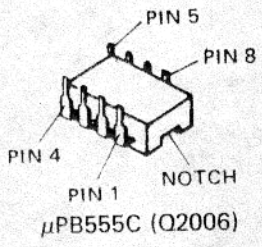

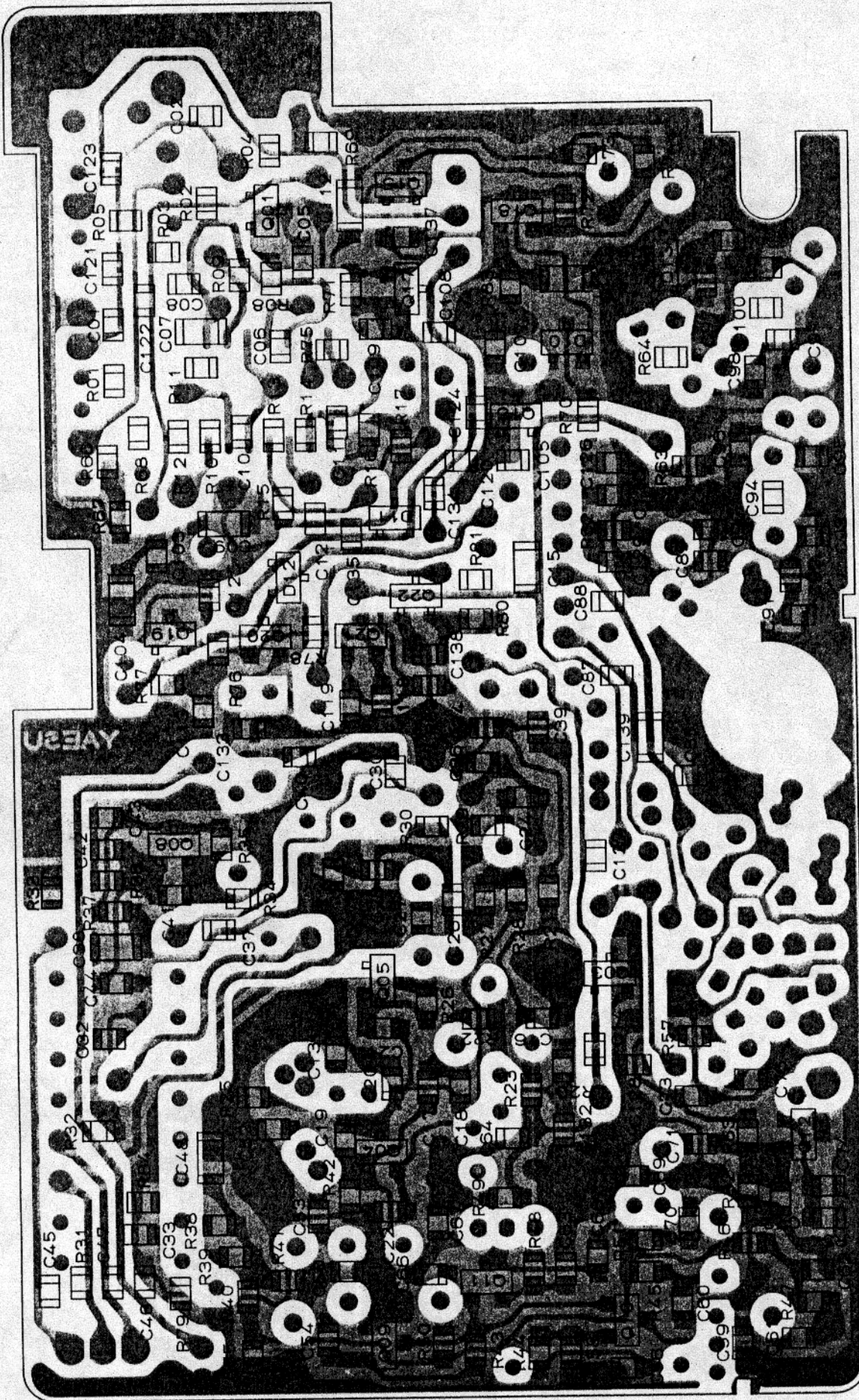

SCHEMATHEEK
Beh. T. Hultermans
Postbus 4228
5604 EE Eindhoven

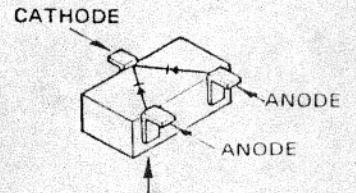

Marked Surface
1SS184 (B3)
(D2010,2011,2012)

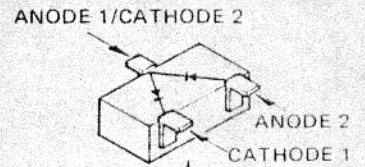

Marked Surface
1SS226 (C3) (D2013)

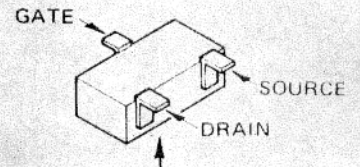

Marked Surface
2SK210Y (YY) (Q2004)

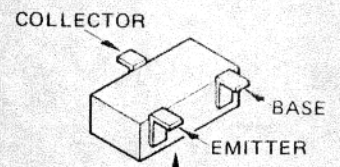

Marked Surface
2SA812 (M6/M7) (Q2015,2017,2020)
2SA1162GR (SG) (Q2019,2021)
2SC1623 (L6/L7) (Q2001,2003,2016,
2018,2022)
2SC2620B (QB) (Q2005,2010)
2SC2759 (U22) (Q2011,2012)
2SC3120 (HB) (Q2009)

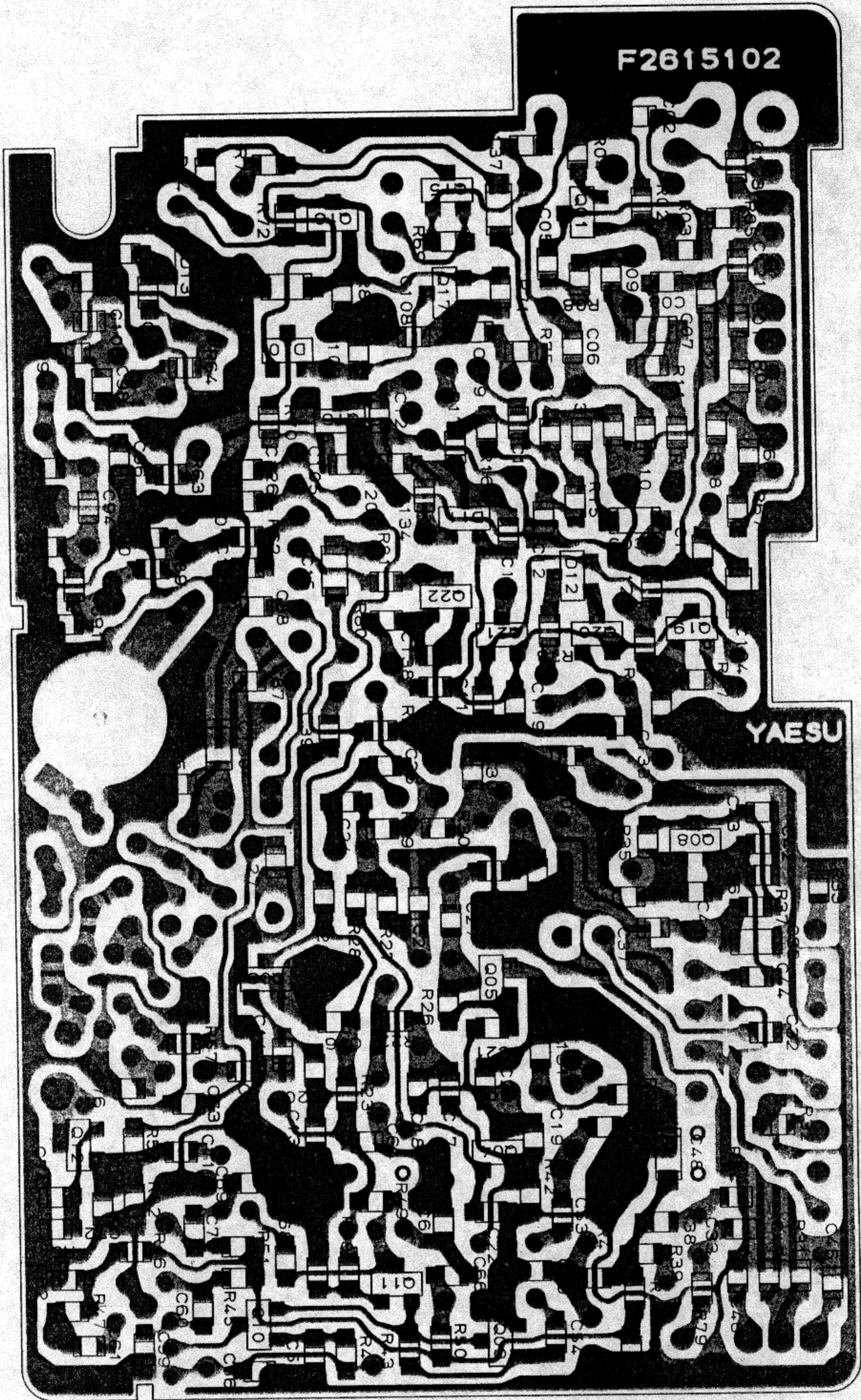

Provided by
<http://www.yaesu-museum.com>

Downloaded by
Amateur Radio Directory

SCHEMATHEEK
Beh. T. Hultermans
Postbus 4228
5604 EE Eindhoven

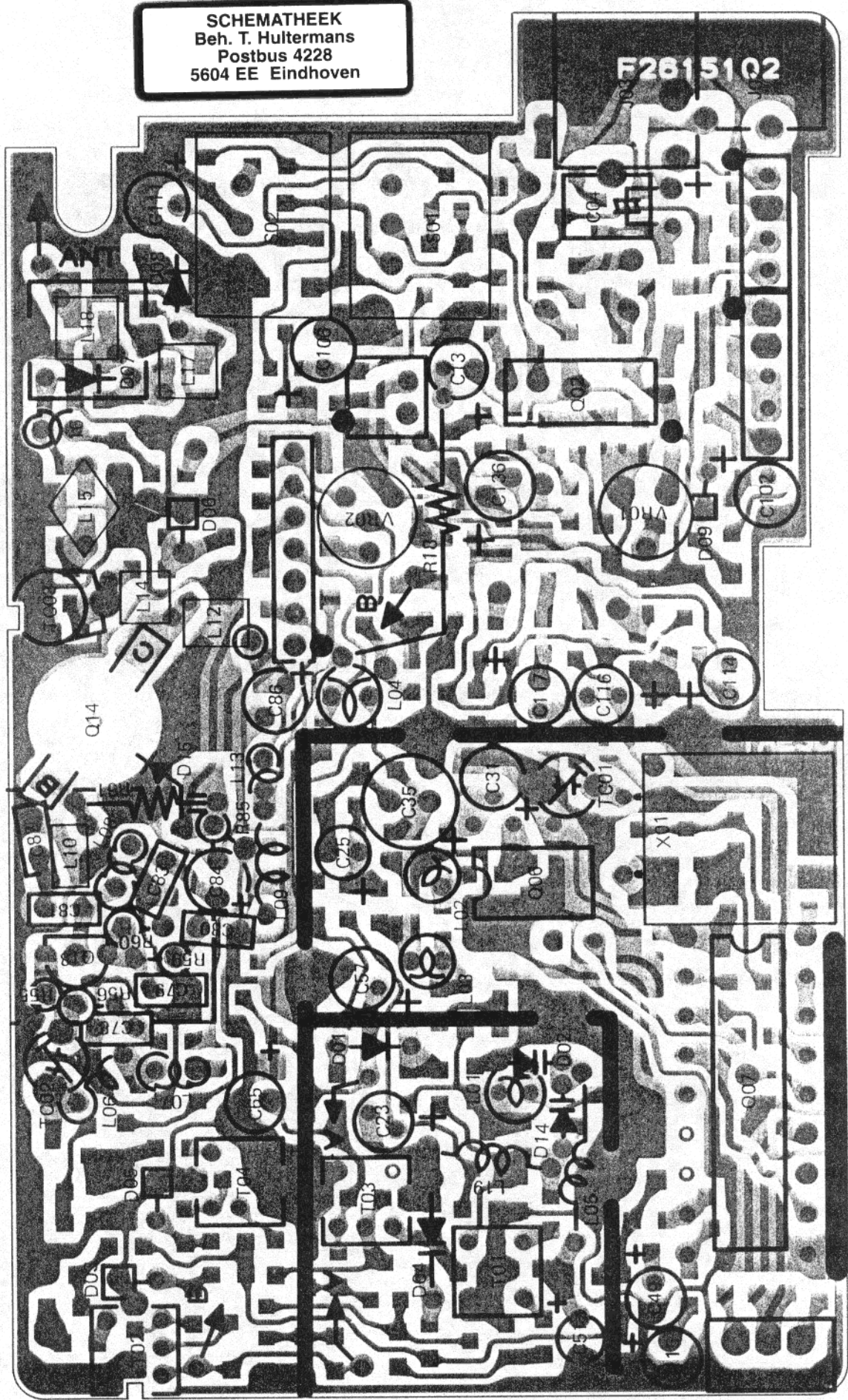

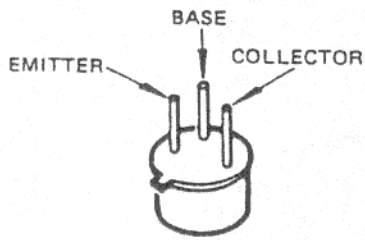

2SC1947 (Q2014)

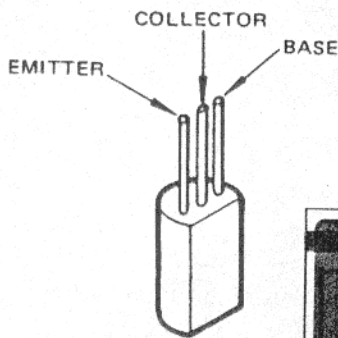

2SC2053 (Q2013)

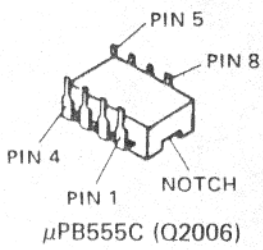

μ PB555C (Q2006)

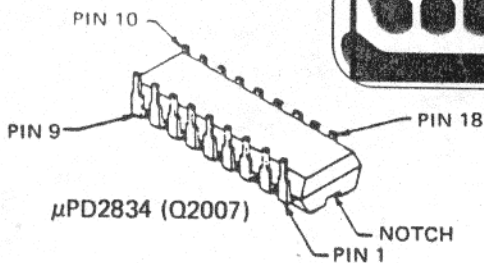

μ PD2834 (Q2007)

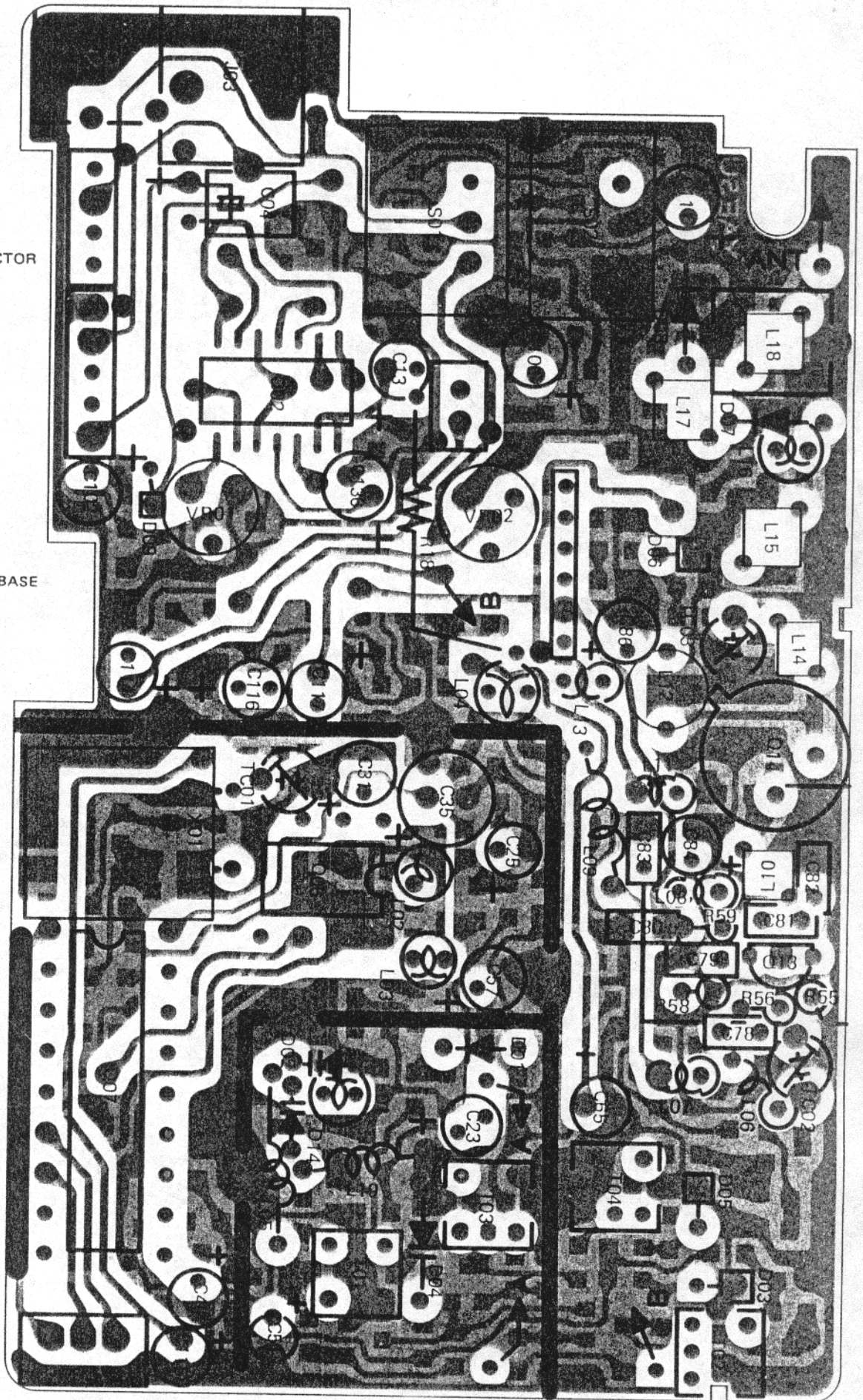

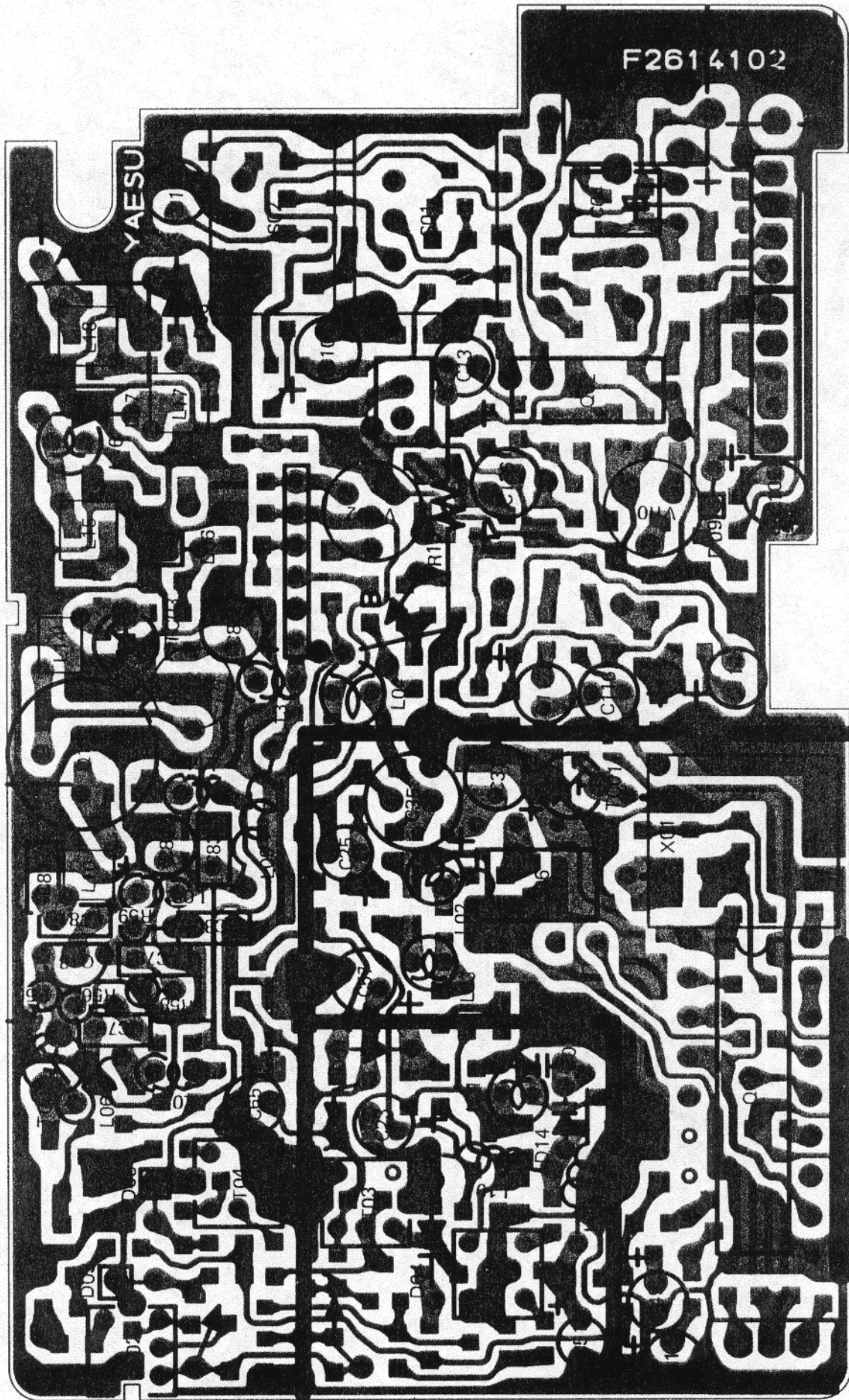

CONTROL UNIT (obverse view)

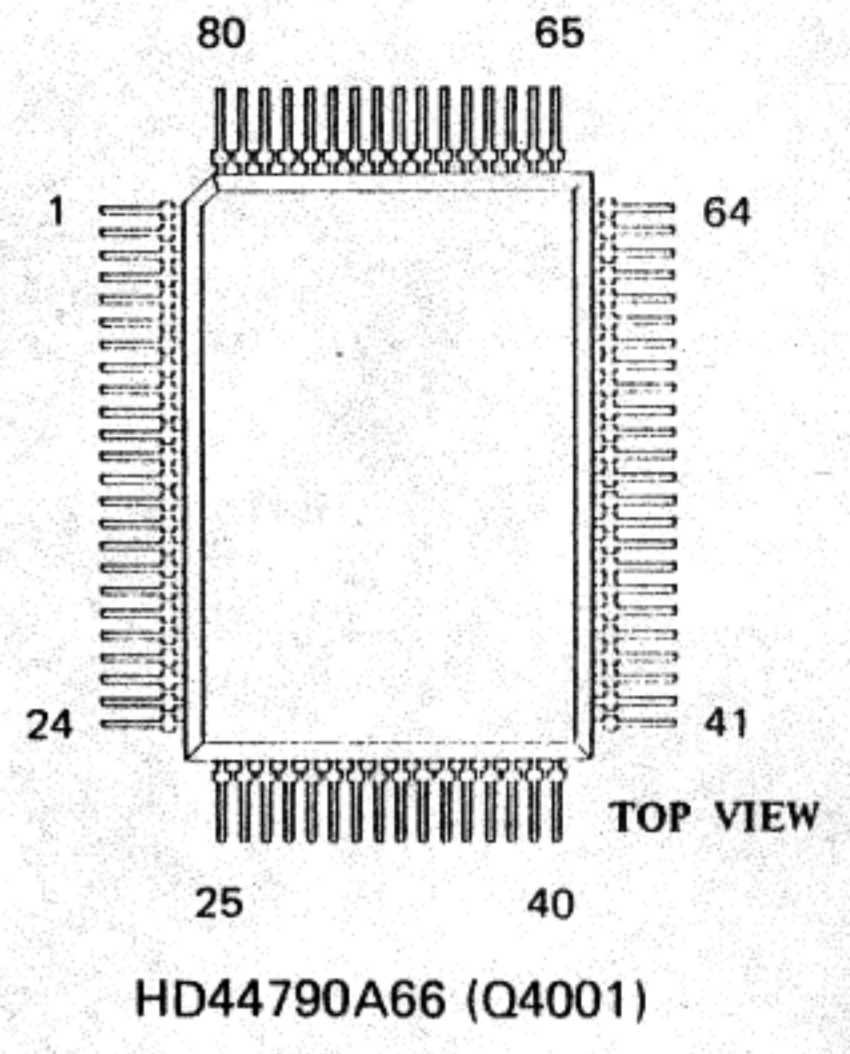
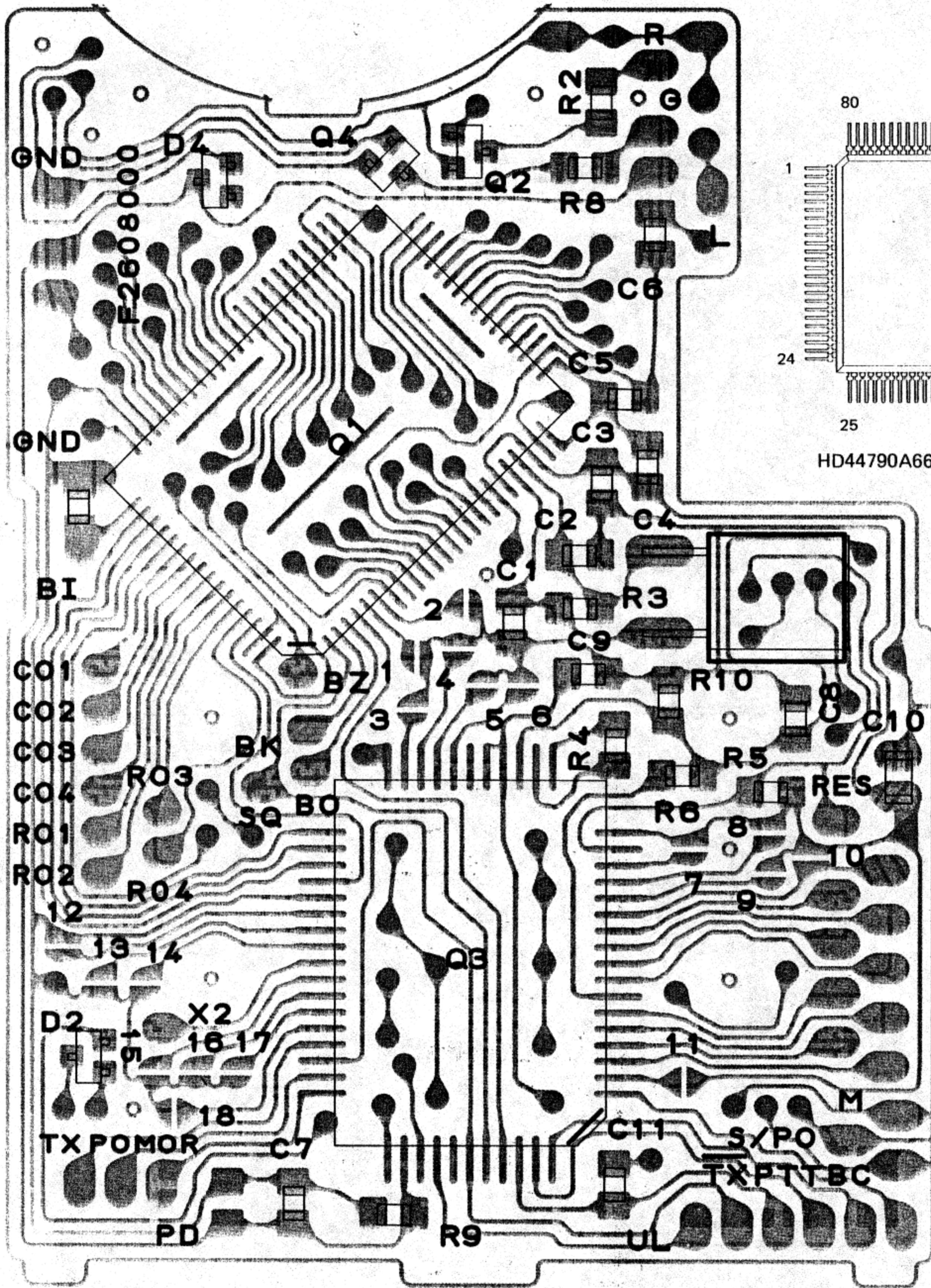

SCHEMATHEEK
 Beh. T. Hultermans
 Postbus 4228
 5604 EE Eindhoven

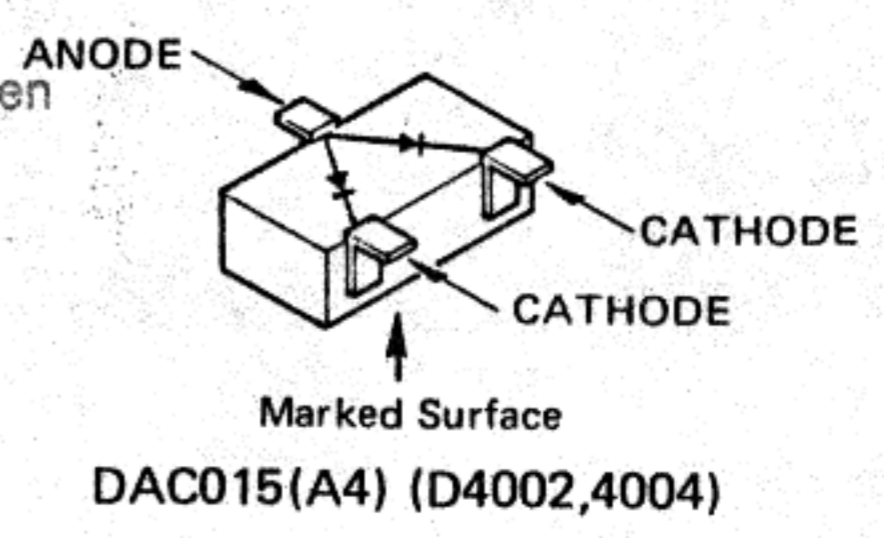
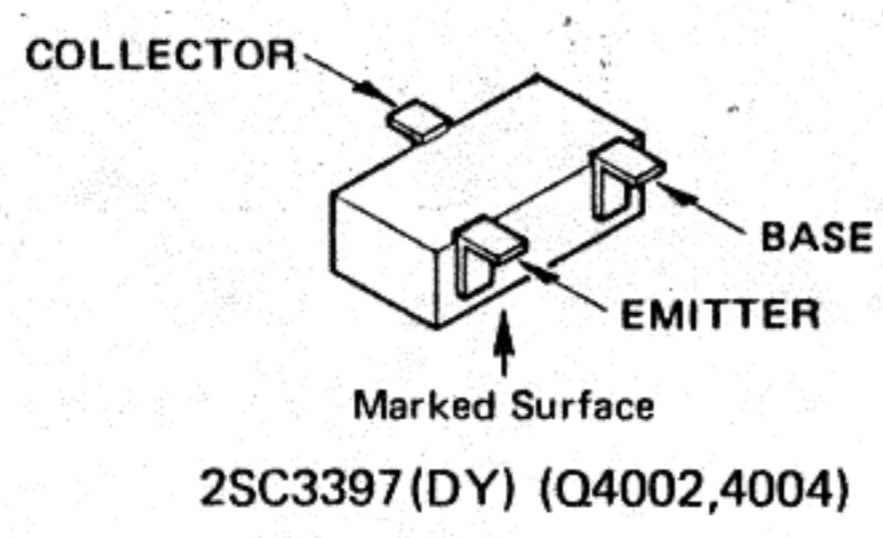

CONTROL UNIT (reverse view)

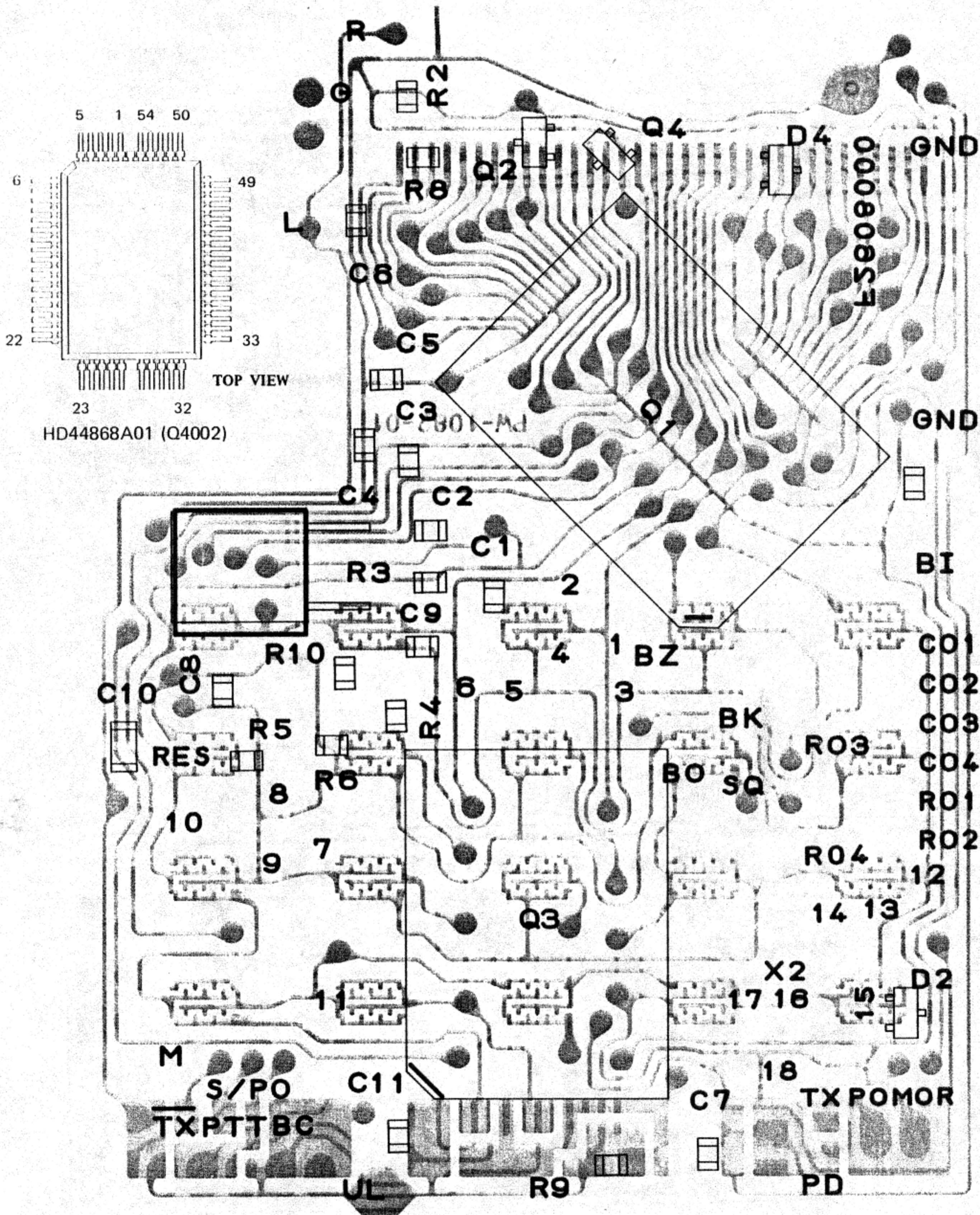

SCHEMATHEEK
Beh. T. Hultermans
Postbus 4228
5604 EE Eindhoven

Provided by
<http://www.yaesu-museum.com>

Downloaded by
Amateur Radio Directory

CONNECTOR UNIT (obverse view of "mixed component" side)

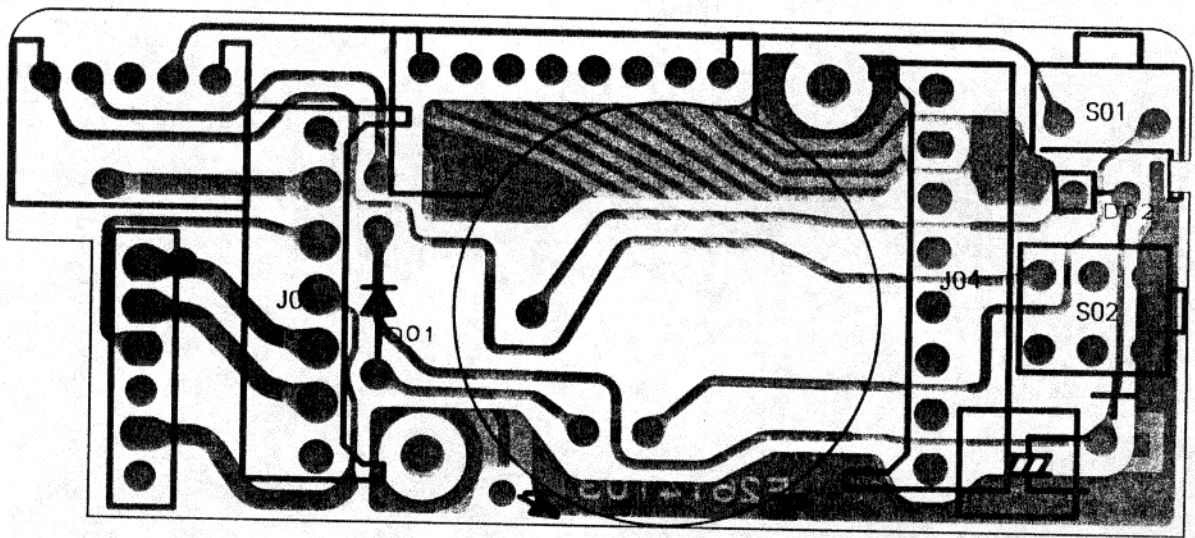

CONNECTOR UNIT (reverse view of "chip-only" side)

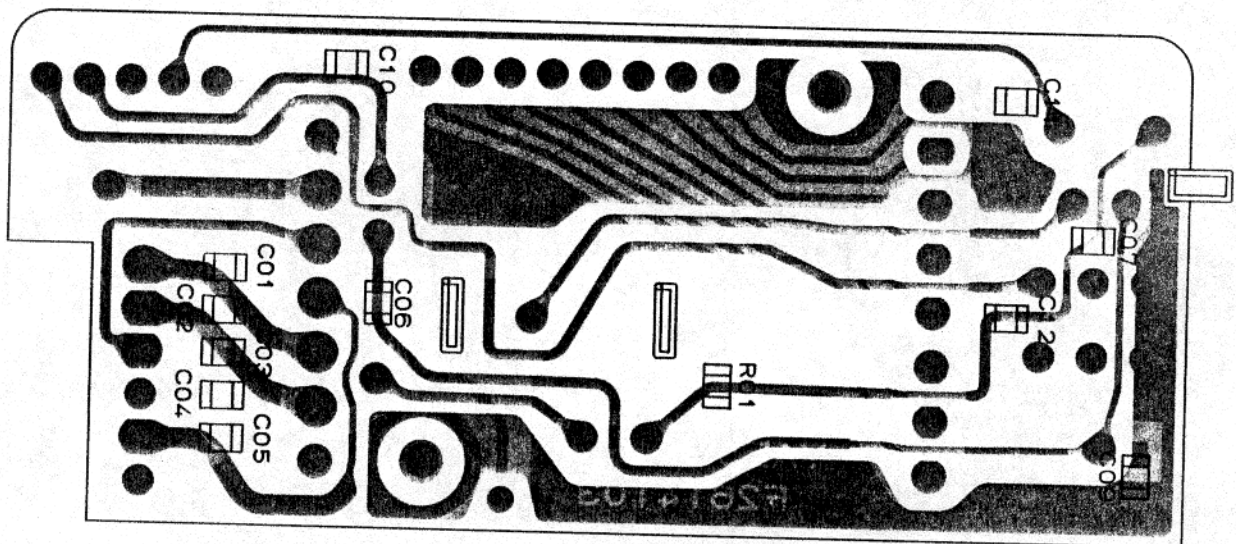

Provided by
<http://www.yaesu-museum.com>

Downloaded by
Amateur Radio Directory

CONNECTOR UNIT (obverse view of "chip-only" side)

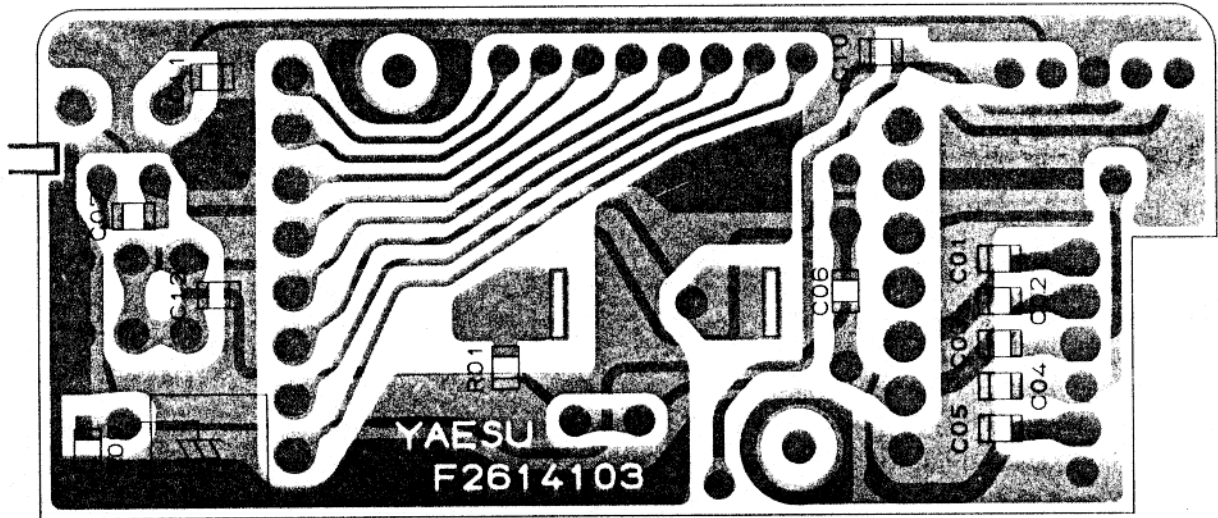

CONNECTOR UNIT (reverse view of "mixed component" side)

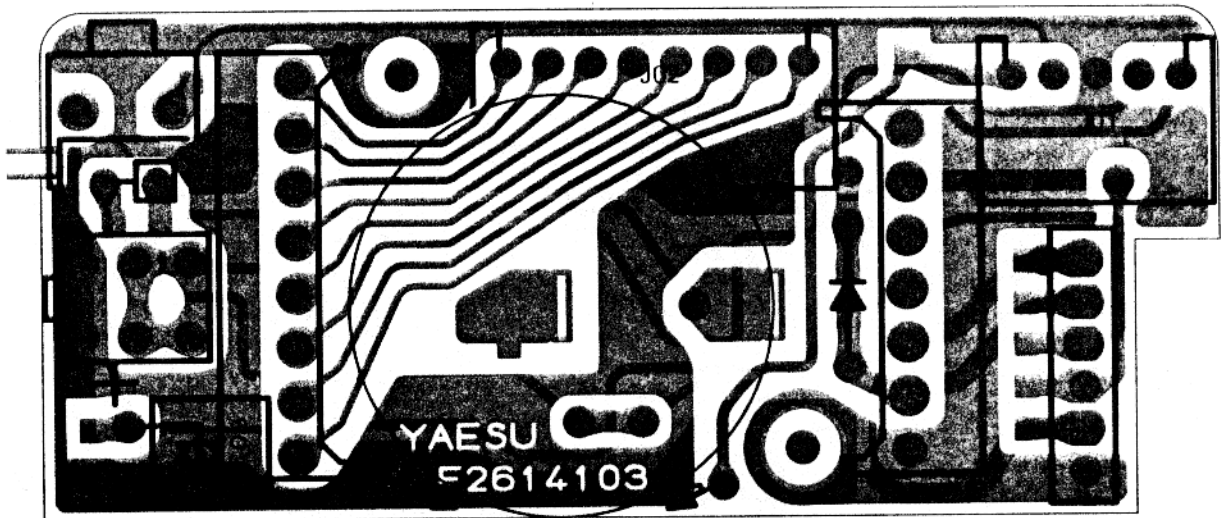

CASE DISASSEMBLY

As there are many fine interconnecting wires inside the FT-209R/RH, extreme care must be exercised whenever the case is open to avoid damaging the connections. We recommend that the exploded view be studied carefully before beginning disassembly of the case.

1. Remove the battery pack and the four screws affixing the battery mounting track.
2. Remove the strap mounting screw with its washer, and the strap mounting dummy screw.
3. Using a small screwdriver as shown below, gently pry off the right side cover of the case (the one that includes the LAMP button), while observing how the button is hinged.
4. Remove the two screws affixing the belt clip to the rear cover, and in the case of the FT-209RH, also remove the one other screw on the rear cover.
5. Now slowly separate the rear cover and remaining side cover from the transceiver, noting the location and method of positioning of the PTT switch and the UNLOCK button and spring. The PLL Unit will now be exposed.
6. To gain access to the Control and RX Units, remove the four screws (2 on each side) affixing the front cover, and slowly separate the front cover and Control Unit (without disturbing the interconnecting wiring).

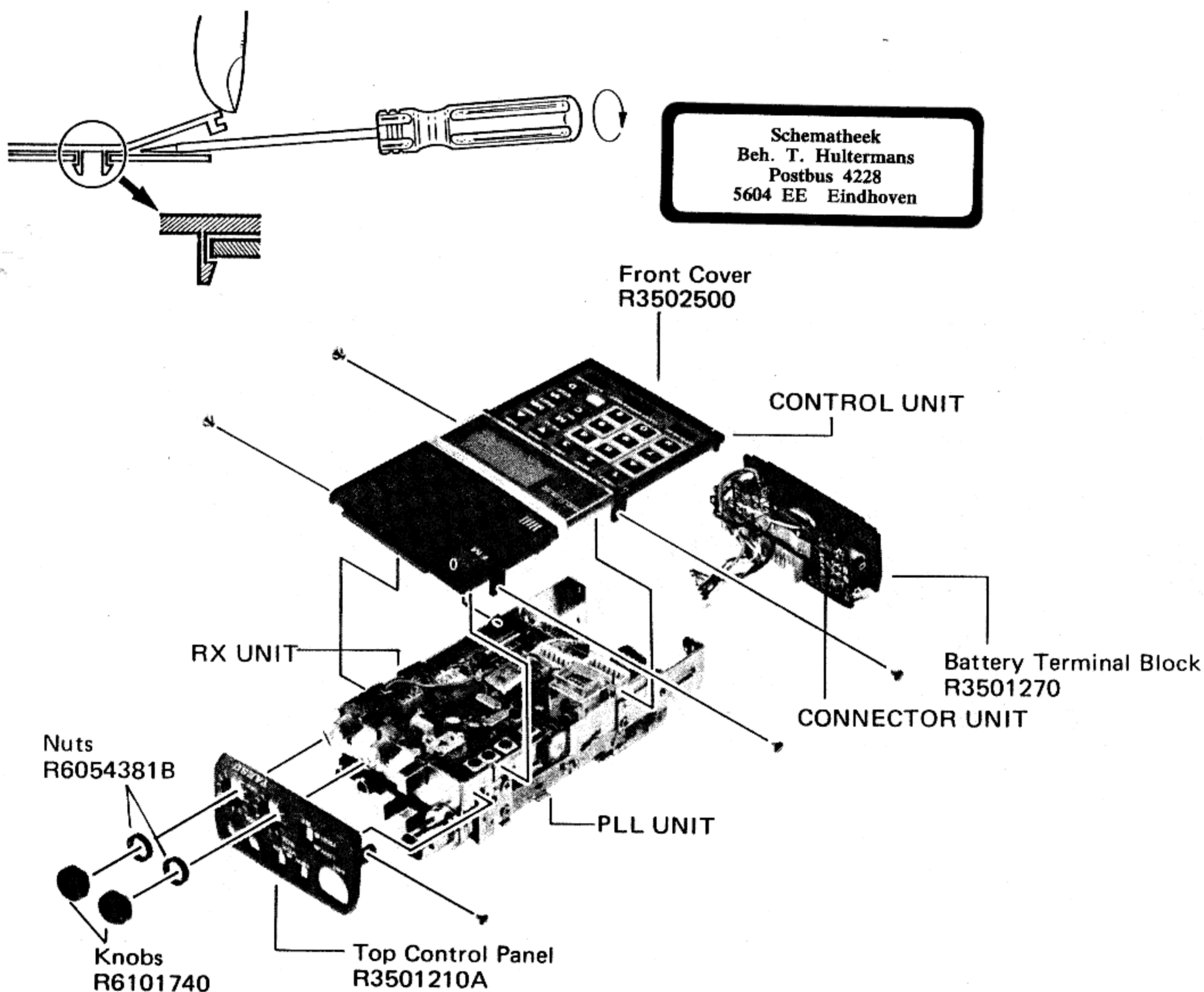

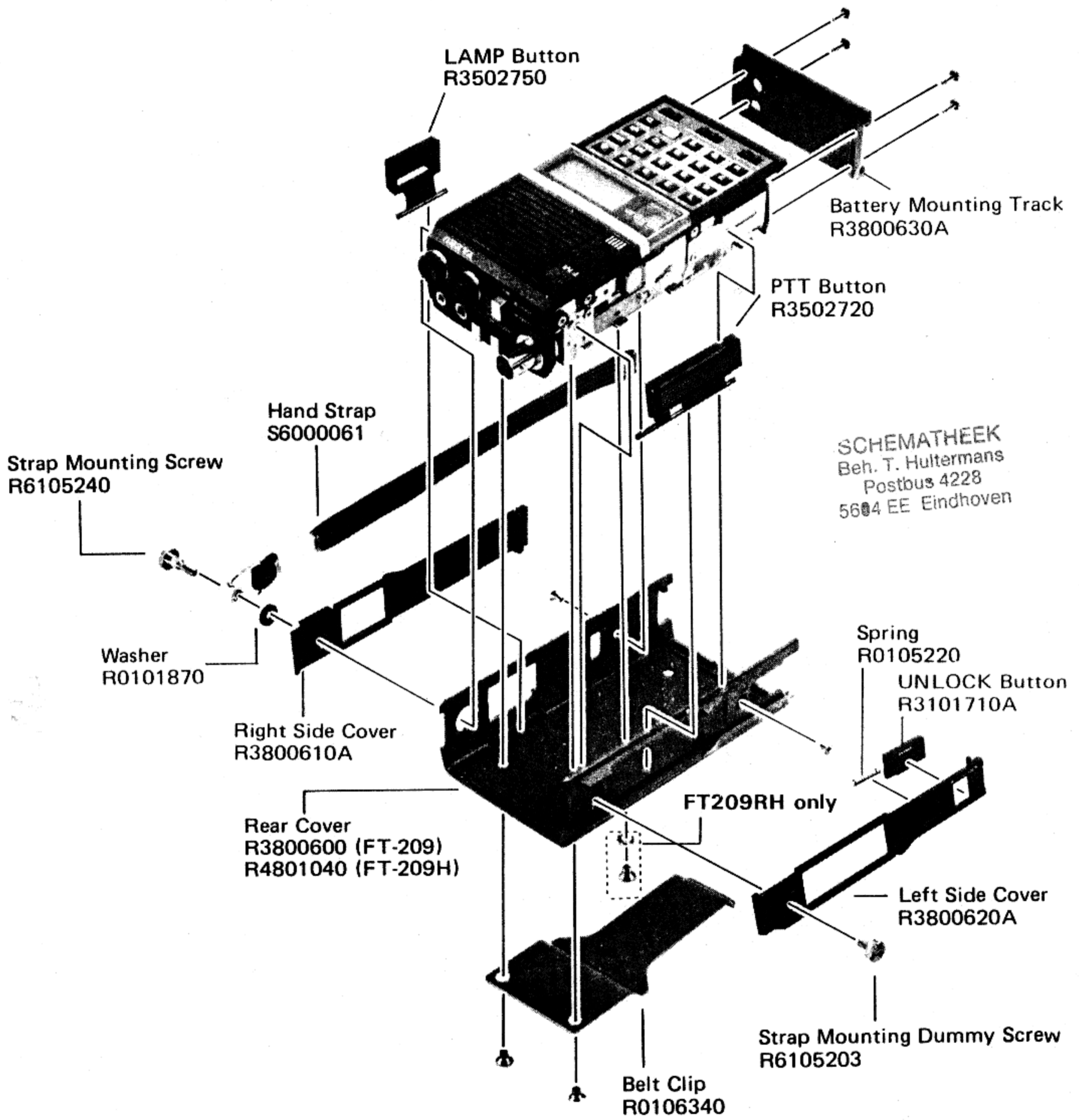

ALIGNMENT

Alignment preparation and precautions

Because of several thermally sensitive interactive components in the transceiver, particular attention must be paid to assure a constant ambient temperature around the transceiver during alignment. If the transceiver temperature is different than that of the alignment environment, allow sufficient time for complete thermal equalization before proceeding. Alignment temperature must remain constant and be within the range of 20 to 30°C (68 to 86°F).

Furthermore, proper alignment requires that the shield cover above the VCO, and shield plate beneath, be in place; and that the circuit boards be mounted in place on the chassis.

Alignment voltage is 10.8 VDC for the FT-209R, or 12.5 VDC for the FT-209RH, except where specifically indicated otherwise.

The frequencies associated with the upper and lower band limits and band center referred to in the alignment procedures are indicated in the following chart for the various model versions.

ALIGNMENT FREQUENCIES

Version	Lower Band Limit	Band Center	Upper Band Limit
A	144.00	146.00	147.995
B	144.00	145.00	145.9875
C	144.00	146.00	147.9875
E	144.00	146.00	147.995

PLL Circuit

The varactor control voltage is carefully set using a special test jig and adjusting L₂₀₀₁ at the factory, and should not require realignment. However, the voltage should be checked prior to alignment. Connect the DC voltmeter to pin 11 of Q₂₀₀₇, tune the transceiver to the lower band limit, and check for 0.8 ± 0.3 V DC.

Provided by
<http://www.yaesu-museum.com>

Downloaded by
Amateur Radio Directory

Transmitter

Connect the test equipment for transmitter alignment as shown below. Make certain that the 50-ohm dummy load is connected to the antenna jack at all times during alignment; do not make any adjustments using the antenna.

A. Transmitter Resonant Circuits

1. Set the transceiver to the lower band edge. Connect the RF millivoltmeter to the emitter of Q_{2013} , close the PTT and adjust T_{2003} and T_{2004} for maximum voltage on the meter.
2. Now retune the transceiver to band center, close the PTT and adjust TC_{2002} , again for maximum voltage on the meter (at the emitter of Q_{2013}).
3. (Not generally required unless driver or final components changed.) Reduce the supply voltage to 6V, close the PTT and adjust the pitch of L_{2010} for maximum output power.
4. With the supply voltage set back to normal, check the power output at each MHz point in the range of the transceiver (at least 2.5W in the FT-209R, and 5W in the FT-209RH). Supply current should be less than 700 mA in the R versions, and less than 1A in the RH versions. If necessary, adjust the pitch of L_{2014} and TC_{2003} for maximum power output and simultaneously minimum supply current.

B. Low Power Operation Check

1. With the RF HI/LOW switch set to LOW, set the transceiver to band center and check for 400 mW (R versions) or 800 mW (RH versions) power output. Now set the transceiver to first the lower and then the upper band limits, and check for output within the range of 300–500 mW (R versions) or 700–1000 mW (RH versions).
2. Reduce the supply voltage to 6V, set the RF HI/LOW switch to HI, and check for at least 500 mW output at the band limits and band center.

C. Master Oscillator (PLL) Frequency

Ground the external MIC jack (so that there is no modulation), and set the transceiver to band center. Close the PTT and adjust TC_{2001} , if necessary, so that the output is within ± 100 Hz of the displayed frequency.

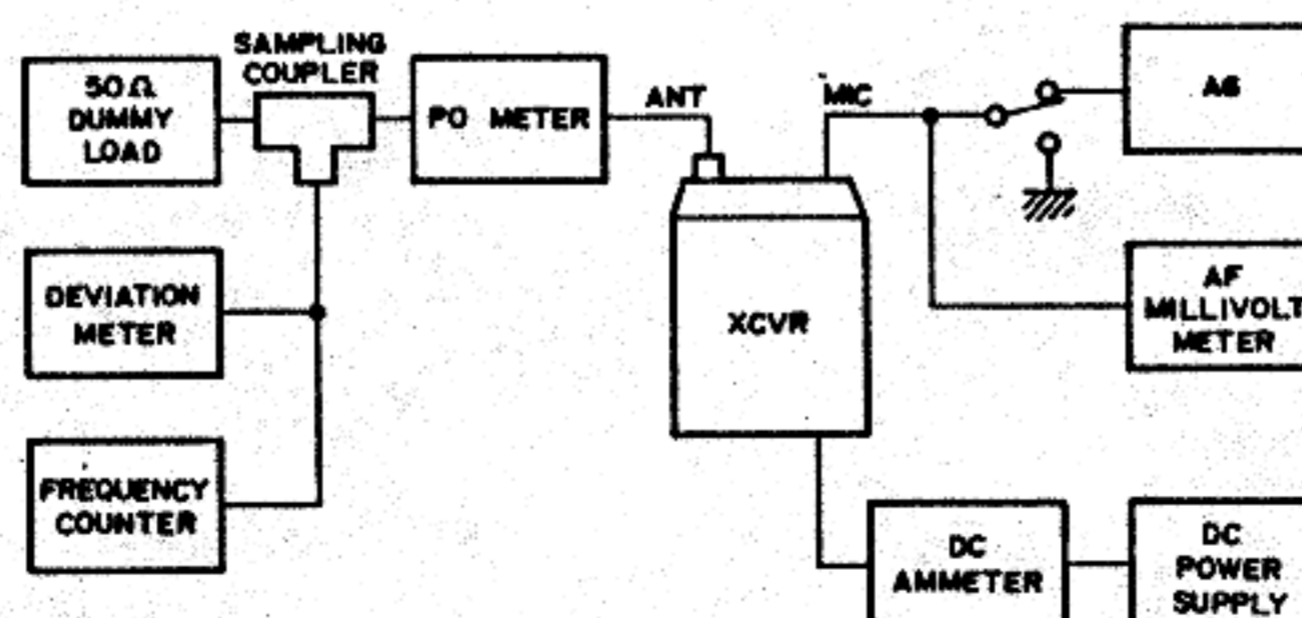

Test Equipment Connections for Transmitter Alignment

D. PO Meter Calibration

With the transceiver set to band center, the HI/LOW switch set to HI and the meter switch set to S/PO, close the PTT and adjust VR₁₀₀₂ on the RX Unit, if necessary, so that the meter indicates "8" on the PO scale.

E. Modulator Deviation

Set the AF oscillator (connected to the MIC jack) for 1 kHz at 25 mV, and adjust VR₂₀₀₁, if necessary, for ± 4.5 kHz deviation (output). Now reduce the level of the modulating tone until the deviation meter shows ± 3.5 kHz deviation, and check that the audio generator output level is between 2 and 4 mV.

F. Tone Encoder Output Level (if optional FTS-6 is installed)

With the transceiver set to band center, on the keypad press [3] [0] [F] [6] [F] [8], and then close the PTT and adjust VR₂₀₀₂, if necessary, for ± 0.5 kHz deviation (with no external modulation).

G. Battery Condition Meter Function

Set the meter switch to BC, reduce the supply voltage to 6V, and adjust VR₁₀₀₃, if necessary, so that the meter is centered on the red/green border. Return the supply voltage to normal.

H. VOX Sensitivity Check

With the audio generator tuned to 1 kHz and connected to the MIC jack, note the generator output level at which the VOX activates. This should be within 1.5 to 3.5 mV when the VOX HI/LOW switch is in the HI position, and within 3.5 to 5.5 mV in the LOW position.

Receiver

Connect the test equipment as shown for receiver alignment.

A. Resonant Circuits

1. With the transceiver set to the low band limit and the meter switch set to S/PO, set the RF signal generator for 20 dB output at the same frequency with no modulation, and adjust T_{1002} – T_{1004} for peak indication on the S-meter.
2. Now modulate the generator signal 70% (± 3.5 kHz) with a 1 kHz tone, and adjust T_{1005} and T_{2002} for peak indication on the S-meter.
3. Return the transceiver to band center and adjust T_{1001} , T_{1006} and T_{1007} for peak S-meter deflection and minimum distortion on the oscilloscope. Adjust the generator level as necessary to keep S-meter indications on scale.
4. Confirm at least 12 dB SINAD at $0.2 \mu\text{V}$ or less generator output on each 1 MHz through the range of the transceiver.

B. Squelch Threshold Preset

Set the transceiver to band center, and the SQL control to mid-range. With no input at the antenna jack, adjust VR_{1001} , if necessary, so that the squelch just closes.

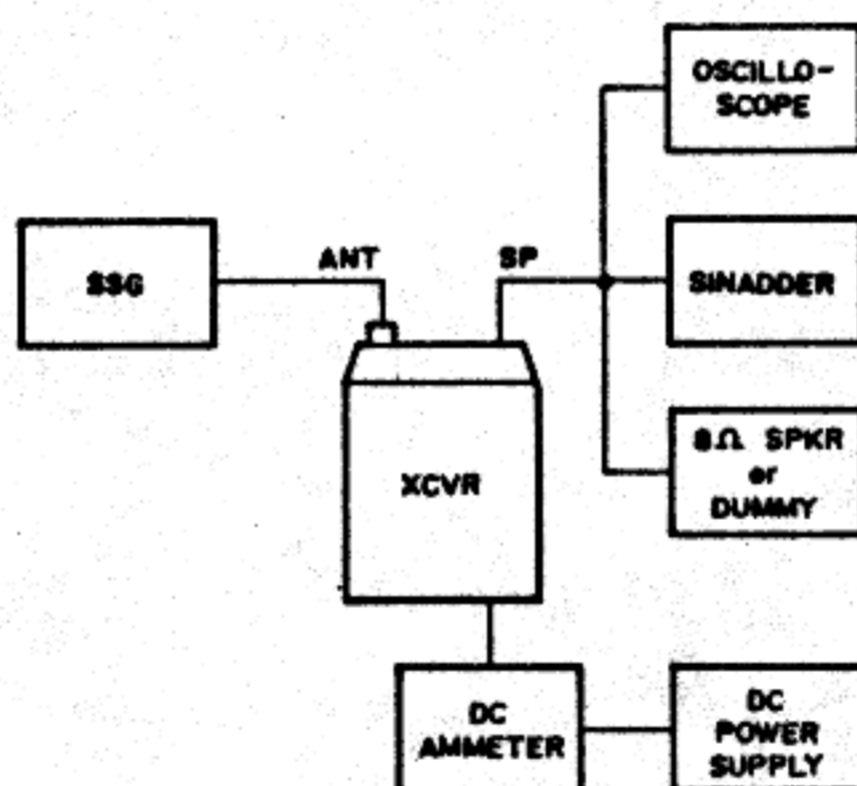

Test Equipment Connections for Receiver Alignment

Provided by
<http://www.yaesu-museum.com>

Downloaded by
Amateur Radio Directory

PLL UNIT ALIGNMENT POINTS

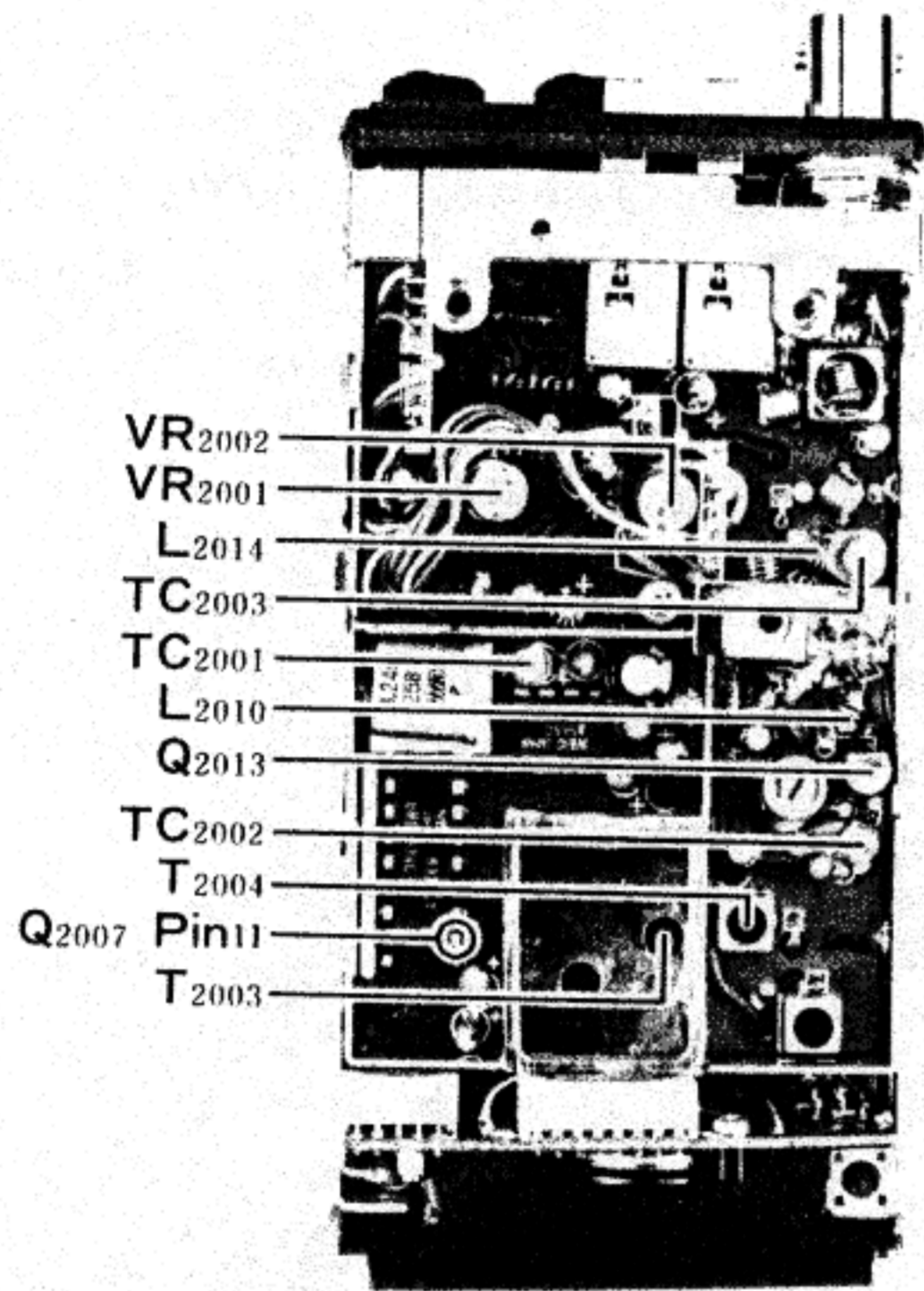

FT-209RH

SCHEMATHEEK
 Beh. T. Hultermans
 Postbus 4228
 5604 EE Eindhoven

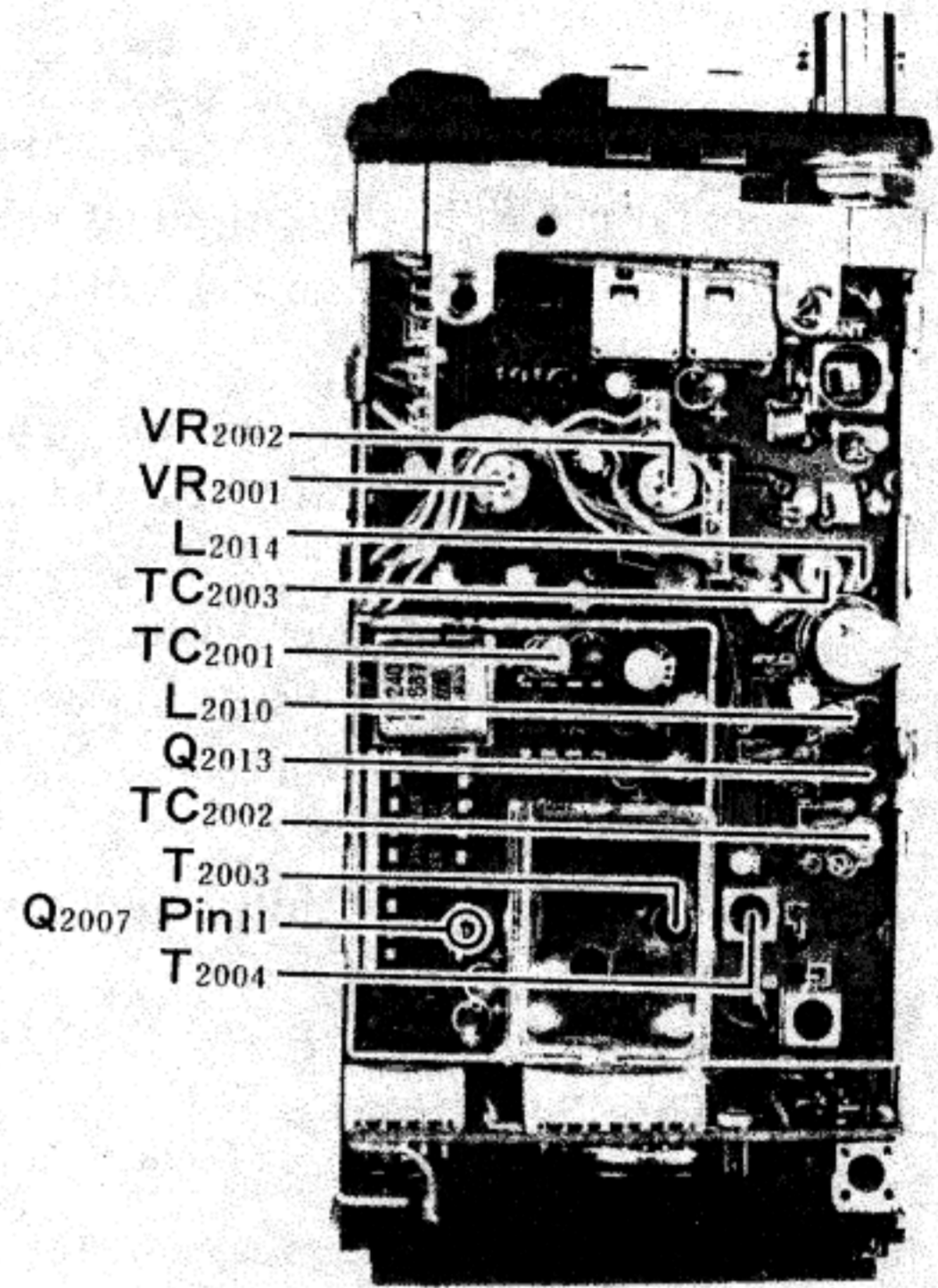

FT-209R

RX UNIT ALIGNMENT POINTS

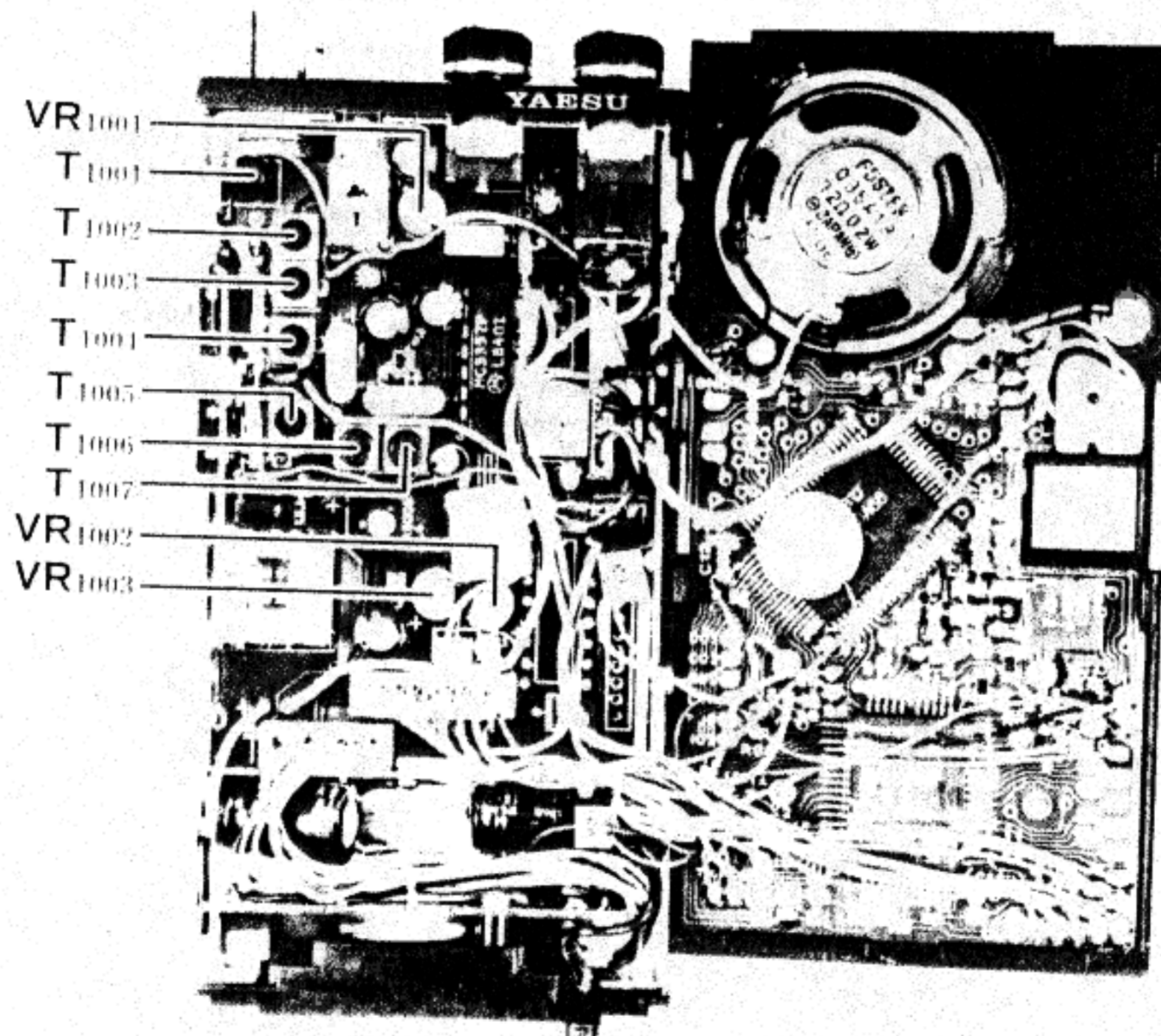

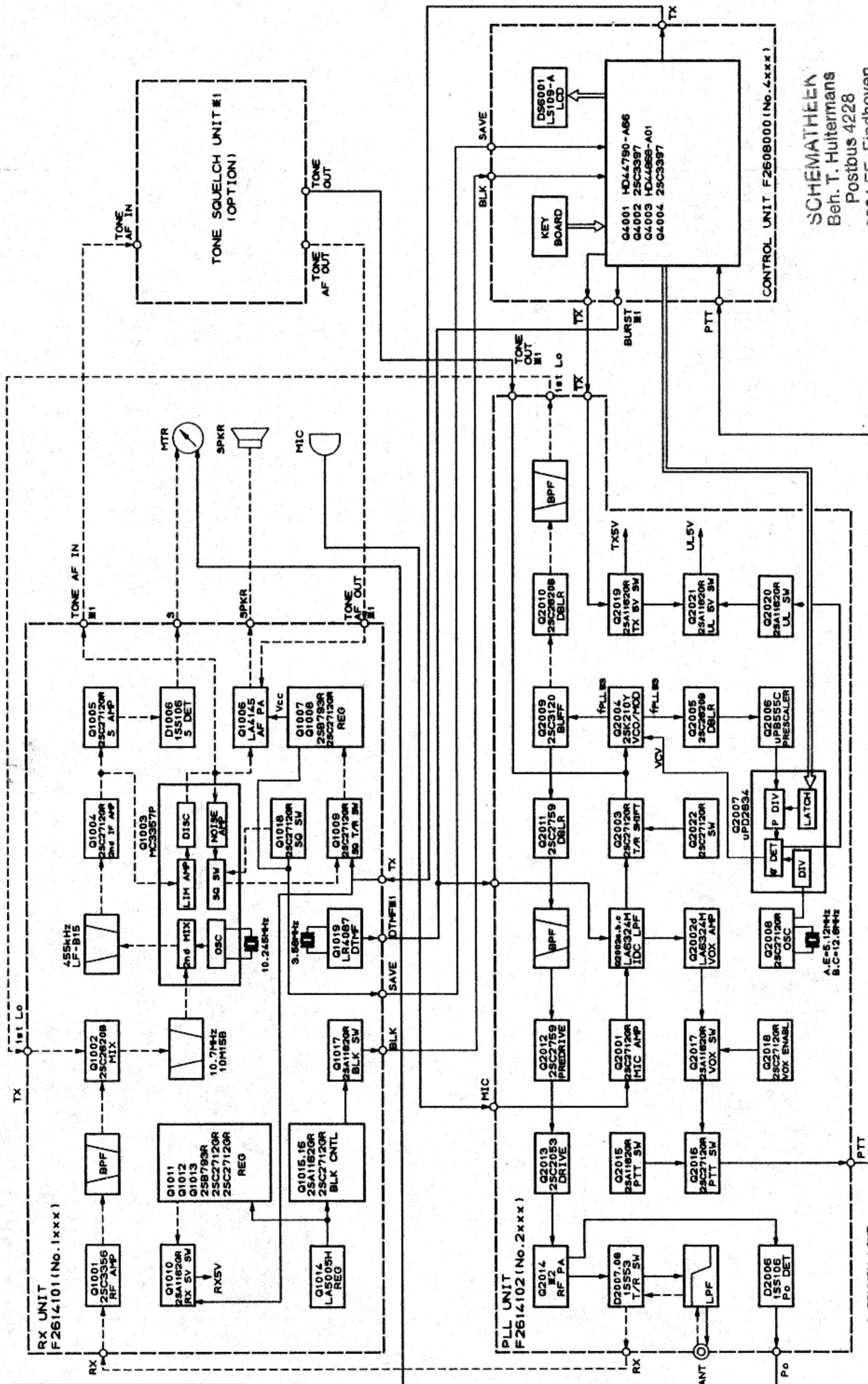

**FT-209R/RH
BLOCK DIAGRAM**

SCHEMATHIEK
Beh. T. Huitermans
Postbus 4228
5604 EE Eindhoven

	TX (MHz)	RX (MHz)
A.E	72.000-73.9975	66.65-68.6475
B	72.000-73.9975	66.65-67.64375
C	72.000-73.9975	66.65-68.04375

#2 PLL UNIT	
Q2014	Q2014
FT-209R	25C1947
FT-209RH	25C2287

#1 RX PLL AND CONTROL VARIATIONS		
	BURST	TONE SQ
A	○	○
B	○	○
C	○	○
E	○	○

#3		
	TX (MHz)	RX (MHz)
A.E	72.000-73.9975	66.65-68.6475
B	72.000-73.9975	66.65-67.64375
C	72.000-73.9975	66.65-68.04375

Provided by <http://www.yaesu-museum.com>
Downloaded by Amateur Radio Directory

PARTS LIST

MAIN CHASSIS			CONTROL UNIT		
Symbol No.	Part No.	Description	Symbol No.	Part No.	Description
		CAPACITORS			CONTROL UNIT ASSY
C2	K02173100	Ceramic disc " 10pF CH (DD104CH100D50V)		Q9000269	Version A
				Q9000270	Versions B & C
				Q9000271	Version E
				Q9000272	Version F
		METER			Control Board
M1	M0290044	MH-42F		F2608000	
		SWITCHES			ICs
SI,2,3*	N4090040	KHG10901 PTT, LAMP, BURST*	Q4001	G1090580	HD44790A66
			Q4003	G1090581	HD44860A56
		CONNECTOR			TRANSISTORS
J1	P1090376	BNC-R (050-1400)	Q4002,4004	G3333970	25C3397 (DY)
		Top Control Panel			
	R3501210A	Front Cover See Control Unit Assy			
	R3800600	Rear Cover w/o label, belt clip (FT-209,209R)			
	R4801040	" " (FT-209H,209RH)	D4002,4004	G2070011	SI DCA015(A4)
	R8105540	Trim band FT-209RH	D4001	G2090243	LED TLR210
	R8105550	" " FT-209H	D4003	G2090288	" TLG210
	R8102170	" " FT-209R			
	R8102160	" " FT-209			
	R3800620A	Left Side Cover (PTT) or (PTT and BURST)			
	R3800610A	Right side Cover (LAMP)	DS4001	G6090034	LIQUID CRYSTAL DISPLAY LS109-A
	R3502720	PTT Button (long) Versions A & F			
	R3502730	" " (short) " B, C & E	CO4001	H7900190	CERAMIC RESONATOR CSB390 390kHz (Versions B, C & E)
	R3502740	BURST Button "			
	R3502750	LAMP Button "			
	R3101710A	UNLOCK Latch Button	BZ4001	M4290001	BUZZER EFBRE-25D02
	R0105220	Spring			
	R3800630A	Battery Mounting Track			
	R6101740	Knob IITS (V/L and S/L)			
	R3102070	Push Button (VOX and VOX H/L)	MIC4001	M3290005	MICROPHONE EM-78C
	R3102080	" " (Power H/L)			
	R6105230	Strap Mounting Dummy Screw			
	R6105240	Strap Mounting Screw			
	R0101870	Washer	SP4001	M4090063	SPEAKER CO35A13
	R0105250	Inner Frame C			

* Versions B, C & E

RESISTORS			
R4008	J23205331	Chip RMC-1/10B	331J 330Ω
R4002	J23205152	"	152J 1.5kΩ
R4006	J23205332	"	332J 3.3kΩ
R4005	J23205103	"	103J 10kΩ
R4009,4010	J23205473	"	473J 47kΩ
R4004	J23205513	"	513J 51kΩ
R4003*	J23205823	"	823J 82kΩ
R4003*	J23205105	"	105J 1MΩ
CAPACITORS			
C4001*,4008	K22170801	Chip 50WV 470pF	B
C4002*,4011, 4012*,4013,4014	K22170805	(C2012BIH471MFA)	"
C4007,4009	K22171004	" (C2012BIH102MFA)	0.001μF
C4003-4006	K22141904	" (C2012FIH103ZFA)	0.01μF F
C4010	K78080002	(C3216D1E104KFA)	D
		Tantalum 6.3WV 4.7μF	
		(F950J475MAA)	
CONNECTORS			
P1 (with wire)	T9204820		
P2 (")	T9204821A		
P3 (")	T9204822A		
P5*(")	T9204824A		
P6*(")	T9204827		
P6*(")	T9204826		
RX UNIT			
Symbol No.	Part No.	Description	
	F2614101	Printed Circuit Board	
	C026141A	PCB with Components	Version A
	C026141B	"	Versions B, C & E
	C026141C	"	Version F

ICs			
Q1003	G1090145	MC3357P	
Q1006	G1090558	LA4145	
Q1014	G1090609	LA5005H	
Q1019*	G1090508	LR4087	
TRANSISTORS			
Q1010,1015,1017	G3111620G	2SA1162GR (SG)	
Q1007,1011	G3207930R	2SB793R	
Q1002	G3326200B	2SC2620B (QB)	
Q1004,1005,1008, 1009,1012,1013, 1016,1018	G3327120G	2SC2712GR (LG)	
Q1001	G3333560	2SC3356 (R22)	
DIODES			
D1001-1003	G2090248	Varactor 1T32	
D1004	G2090109	" 1SV69	
D1005,1012	G2015550	Si 1S1555	
D1006	G2090244	Schottky 1SS106	
D1007	G2090295	Zener HZ9A3L	
D1008	G2070009	Si 1SS184 (B3)	
D1010	G2090294	Zener HZ4BLL	
D1011,1013,1014	G2090027	Si 1SS53	
D1015	G2070003	" 1SS226 (C3)	
CRYSTAL			
X1001	H0102583	HC-18/T 10.245MHz	
CERAMIC RESONATOR			
CO1001*	H7900120	R3.58M 3.579545MHz	
MONOLITHIC FILTER			
XF1001	H1102086	10M15B (2 pcs; matched pair)	
CERAMIC FILTER			
CF1001	H3900030	LF-B15	
CERAMIC DISCRIMINATOR			
CD1001	H7900180	CDB455C7	

* Version A
* Versions B, C & E

		RESISTORS			
		Carbon film	1/8W	10Ω	TJ
R2059,2061*	J01215100	"	"	220Ω	VJ
R2055	J00215221	"	"	560Ω	"
R2056	J00215561	"	"	22kΩ	TJ
R2018	J01215223	Chip RMC 1/10T	330J	33Ω	
R2030,2060*	J24205330	"	"	101J	100Ω
R2028,2029,2037, 2038*,2052, 2054,2057	J24205101	"	"	151J	150Ω
R2025	J24205151	"	"	221J	220Ω
R2063	J24205221	"	"	271J	270Ω
R2039	J24205271	"	"	331J	330Ω
R2004	J24205331	"	"	391J	390Ω
R2061*	J24205391	"	"	471J	470Ω
R2038*,2062, 2067,2081,2082	J24205471	"	"	102J	1kΩ
R2049,2053,2073, 2085*	J24205102	"	"	152J	1.5kΩ
R2066	J24205152	"	"	222J	2.2kΩ
R2001,2021,2024, 2064	J24205222	"	"	272J	2.7kΩ
R2027	J24205272	"	"	332J	3.3kΩ
R2036,2074,2076, 2078	J24205472	"	"	472J	4.7kΩ
R2022	J24205562	"	"	562J	5.6kΩ
R2023	J24205682	"	"	682J	6.8kΩ
R2005,2041,2043, 2068,2069,2080	J24205103	"	"	103J	10kΩ
R2011,2035,2048, 2071	J24205153	"	"	153J	15kΩ
R2013-2015,2034	J24205223	"	"	223J	22kΩ
R2008	J24205333	"	"	333J	33kΩ
R2002,2072,2079	J24205473	"	"	473J	47kΩ
R2010	J24205683	"	"	683J	68kΩ
R2003,2020,2026, 2031-2033, 2042,2044,2046, 2047,2075,2077, 2083	J24205104	"	"	104J	100kΩ
R2009,2017	J24205124	"	"	124J	120kΩ
R2070	J24205564	"	"	564J	560kΩ
R2012	J24205105	"	"	105J	1MΩ
R2016,2040,2045, 2050,2051, 2084*	J24205225	"	"	225J	2.2MΩ

		POTENTIOMETERS			
VR2001	J51745472	H0651A011-4.7kΩ	4.7kΩ	4.7kΩ	CH
VR2002	J51745473	H0651A017-47kΩ	47kΩ	47kΩ	CH
VR2003	J50750331	RG4-HAS	330Ω	330Ω	CH
C2081	K02173100	Ceramic disc 50WV	10pF	10pF	CH
C2082*	K02185390	"	39pF	39pF	"
C2082*	K02189001	(RD871-JNPO390J63V)	47pF	47pF	"
C2078-2080,2083	K12171102	(RD872-INPO470J63V)	0.001μF	0.001μF	E
C2089	K22170201	Chip	0.5pF	0.5pF	CH
C2021,2027,2068, 2090,2094	K22170204	(C2012CHI1H0RSCFA)	3pF	3pF	"
C2052	K22170304	"	3pF	3pF	UJ
C2017,2095,2100, 2091*	K22170206	(C2012CHI1H030CFA)	5pF	5pF	CH
C2067,2069	K22170207	"	6pF	6pF	"
C2059	K22170209	(C2012CHI1H060DFA)	8pF	8pF	"
C2019	K22170311	"	10pF	10pF	UJ
C2028	K22170211	(C2012UJ1H100DFA)	10pF	10pF	CH
C2097	K22170215	"	15pF	15pF	"
C2066,2070	K22170317	(C2012CHI1H150JFA)	18pF	18pF	UJ
C2020,2060	K22170319	"	22pF	22pF	"
C2061,2093	K22170219	(C2012UJ1H220JFA)	22pF	22pF	CH
C2040,2072,2099	K22170221	(C2012CHI1H220JFA)	27pF	27pF	"
C2018	K22170323	"	33pF	33pF	UJ
C2053	K22170329	(C2012UJ1H330JFA)	56pF	56pF	"
C2054,2092*	K22170229	"	56pF	56pF	CH

C2041,2042	K22170239	Chip (C2012CHI1H1S11FA)	50WV	150pF	CH
C2005	K22170801	"	"	470pF	B
C2001,2002,2006, 2008,2010,2012, 2014,2016,2033, 2039, 2045-2047, 2053,2056,2058, 2062-2064, 2071,2073,2074, 2076,2085,2087, 2088,2092*, 2096,2098,2103, 2113,2118,2105, 2107,2108, 2121-2124, 2126-2135, 2137,2138	K22170805	(C2012B1H471MFA) " (C2012B1H102MFA)	" " "	0.001μF	"
C2011	K22170813	"	"	0.0047μF	"
C2022,2024,2032, 2044,2050,2109	K22170817	(C2012B1H472MFA) "	"	0.01μF	"
C2026,2030,2036, 2037,2119,2120	K22171004	(C2012B1H103MFA) "	"	0.01μF	F
C2043	K22171008	(C2012F1H103ZFA) "	"	0.047μF	"
C2007,2009,2015, 2038,2048,2104, 2110,2112,2139*	K22141904	(C2012F1H473ZFA) "	25WV	0.1μF	D
C2051	K70140003	Tantalum (489D224X0025A1)	25WV	0.22μF	
C2106,2111	K70140007	"	"	1μF	
C2115	K70100002	(489D105X0025A1) "	"	4.7μF	
C2086	K70120002	(489D475X0010A1) "	16WV	10μF	
C2031	K70080002	(489D106X0016C1) "	6.3WV	10μF	
C2023,2049	K70080004	"	"	22μF	
C2004	K40179002	(489D226X0006C1) Electrolytic 50WV (ECE-A1HK0R1)	50WV	0.1μF	
C2013	K40179001	"	"	1μF	
C2025,2057,2065, 2084,2102,2114, 2116,2117,2136	K40129012	(ECE-A1HK010) " (ECE-A1CK100)	16WV	10μF	

C2035	K40089007	Electrolytic 6.3WV 100μF (ECE-A0JK101)
TC2001	K91000101	TRIMMER CAPACITORS ECR-GA010D30 10pF
TC2002	K91000100	ECR-GA020E30 20pF
TC2003*	K91000028	ECV-1ZW10X53T 10pF
TC2003*	K91000107	ECR-GA015E30 15pF
L2001	L1190105	INDUCTORS FL3H-1R0M 1μH
L2002,2003	L1190113	FL3H-R22M 0.22μH
L2004	L1190017	FLSH-102K 1mH
L2005,2019	L1190148	LAL03NA-100K 10μH
L2006-2008,2013	L1020677	
L2009	L1020671	
L2010	L0020423	
L2011*	L1020677	
L2012*	L0020987A	
L2012*	L0020679	
L2014*	L0021446	
L2015,2018	L0020342	
L2016	L1190149	LAL03NA010M 1μH
L2017	L0020951	
T2001	L0021448	TRANSFORMERS
T2002-2004	L0021418	Coil Case KS7-5 (H=6.5mm)
S2001,2002	N4090092	SWITCHES SPI512E
J2001	P0090370	CONNECTORS 5403-03CPB
J2002	P1090369	HSJ0838-01-010
J2003	P1090370	HSI0836-01-010
L9190001	L9190001	FERRITE BEADS Ri 3x3x1
L9190043	L9190043	B20L-25*

* FT-209RH
* FT-209R

FTS-6 TONE ENCODER/DECODER (D3000320)

Symbol No.	Part No.	Description
	F2632100	Printed Circuit Board
Q1001	G1090577	IC MN6520
Q1004	G3111620G	TRANSISTORS 2SA1162GR (SG)
Q1002,1003	G3327120G	2SC2712GR (LG)
X1001	H0102571	CRYSTAL MS41F 4.194304MHZ
R1013	J24205222	RESISTORS Chip RMC1/10T 22J 2.2KΩ
R1001	J24205472	" " 47J 4.7KΩ
R1002,1005,1009, 1010,1016,1017	J24205103	" " 10J 10KΩ
R1003,1007,1012	J24205123	" " 12J 12KΩ
R1011	J24205153	" " 15J 15KΩ
R1004	J24205333	" " 33J 33KΩ
R1008	J24205683	" " 68J 68KΩ
R1006,1014	J24205154	" " 15J 150KΩ
R1015	J24205474	" " 47J 470KΩ
VR1001	J51750473	POTENTIOMETER H0423A04747KB 47KΩB
C1012,1013	K22170217	CAPACITORS Chip 50WV 18pF CH (C2012CH1H180JFA)
C1008-1010	K22171004	" " 0.01μF F (C2012F1H103MFA)
C1001,1003,1004	K22141904	" " 0.1μF D (C3216D1E104KFA)
C1002,1006	K72100001	Tantalum 10WV 1μF (F951A105MA1)
C1007,1011	K72080003	" 6.3WV 10μF (F950J106MCI)
C1005	K72080006	" 10WV 47μF (F950J476MG1)

Provided by <http://www.yaesu-museum.com>
 Downloaded by Amateur Radio Directory

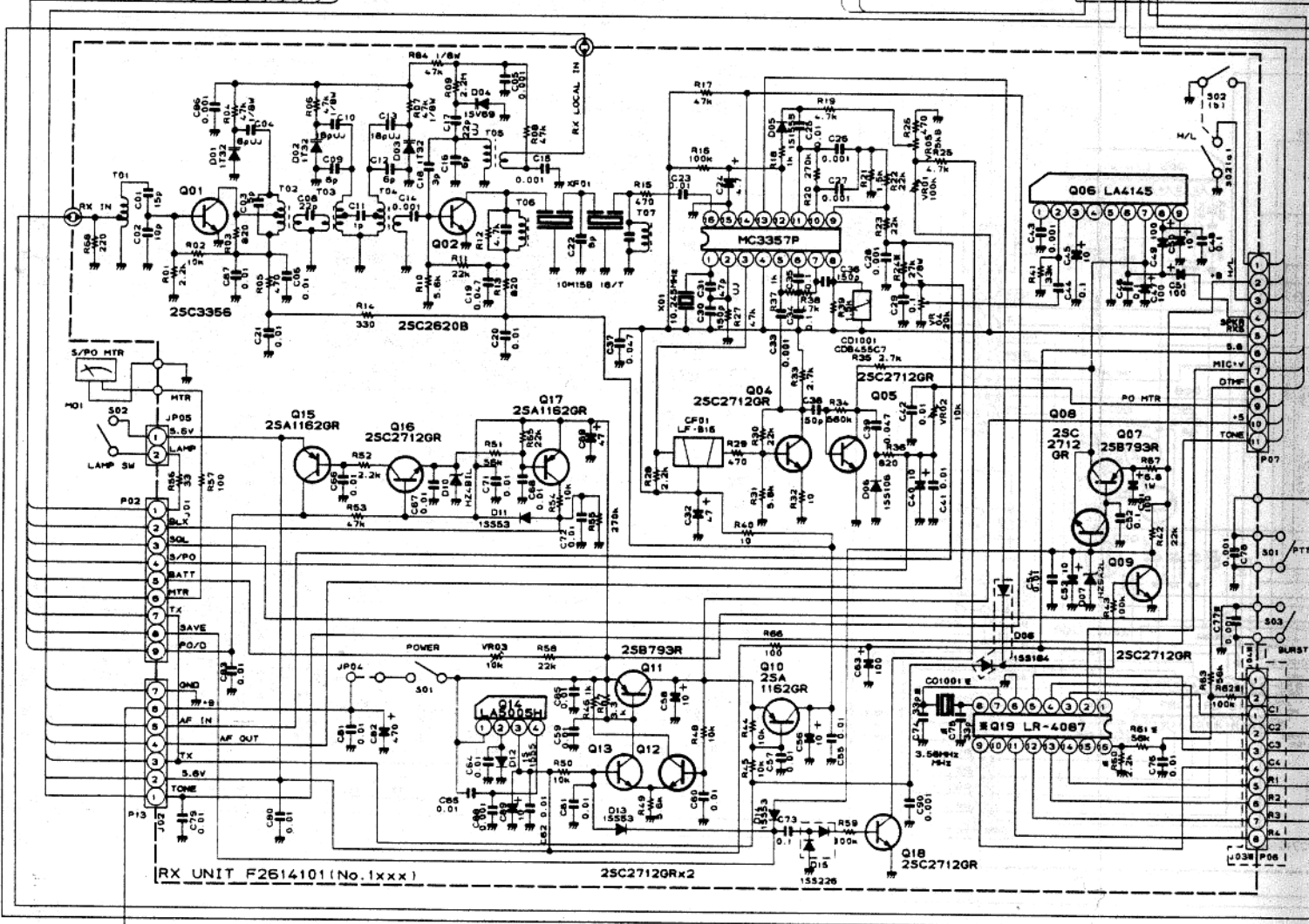
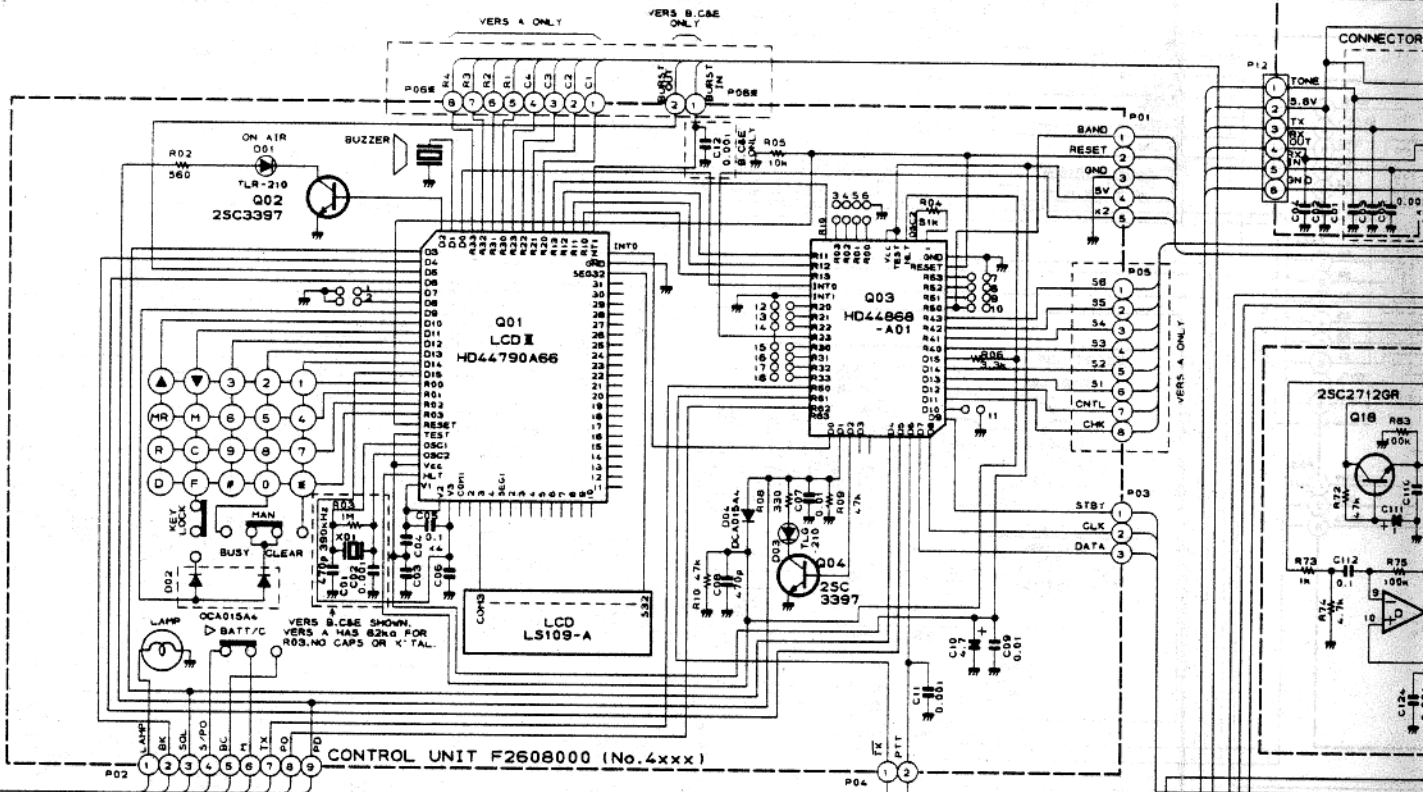

CONTROL UNIT INSTALL JUMPERS IN THE POSITIONS MARKED

A	1	2	3	4	5	6	7	8	9	10	11	12	13	14	15	16	17	18
B																		
C																		
E																		

R102	R106	R108	R109
A	27k	100k	56k 2.2k
B&C	27k	100k	
E	27k	100k	

SCHEMATEEK
Beh. T. Hultermans
Postbus 4228
5604 EE Eindhoven

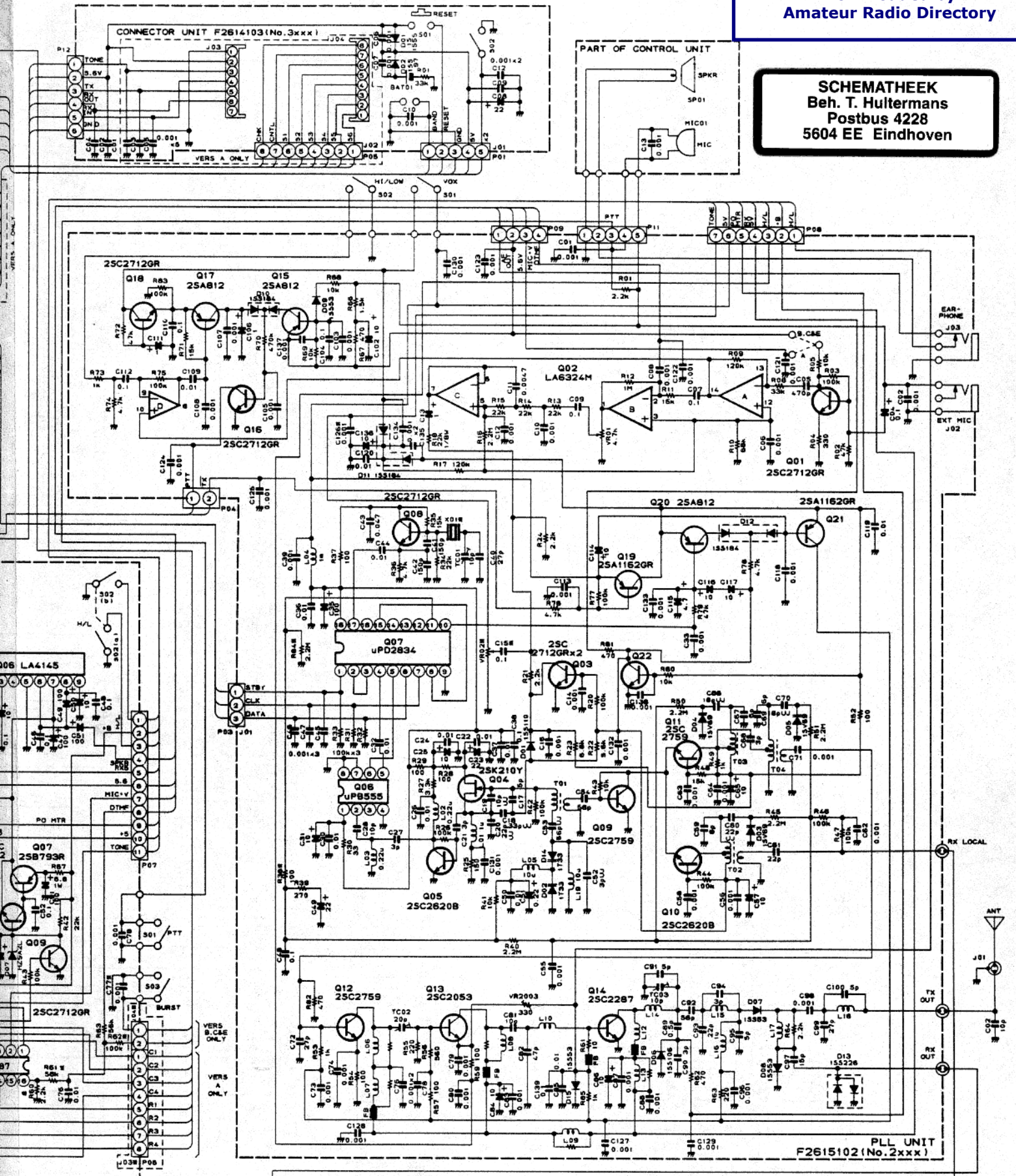

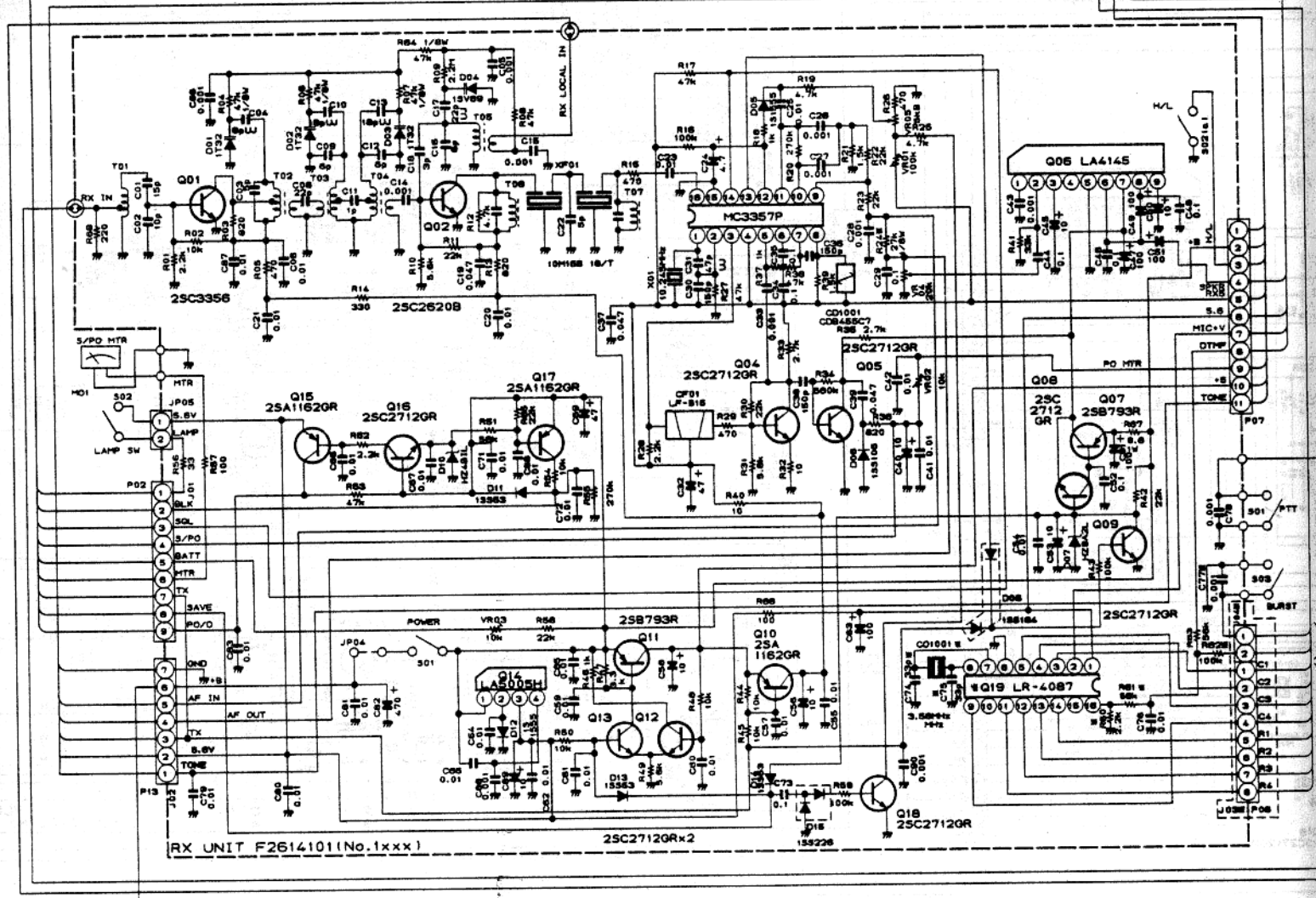
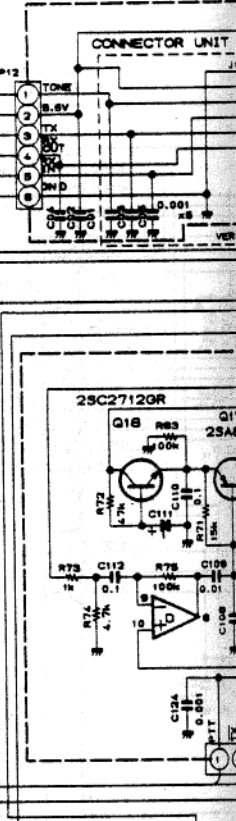
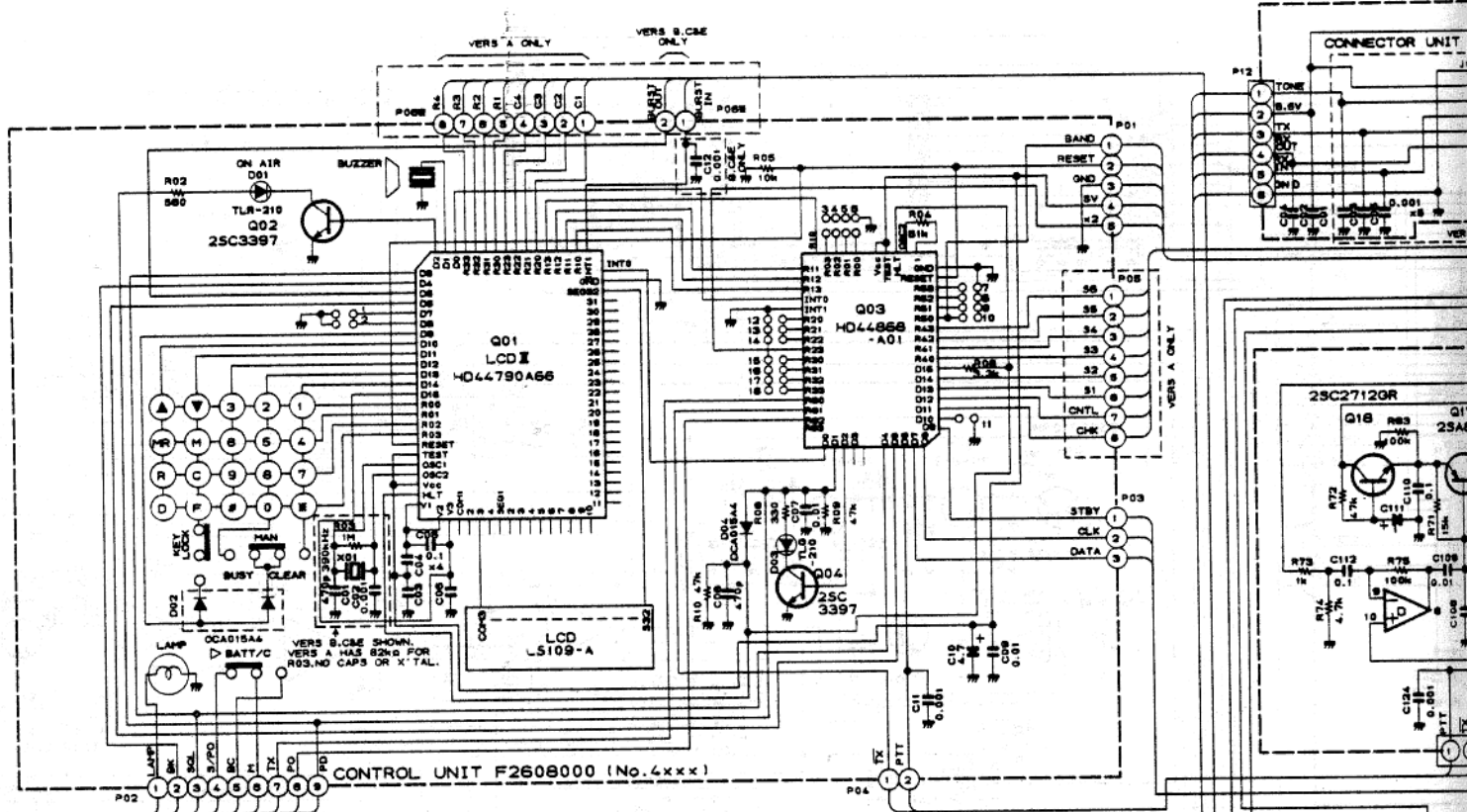

CONTROL UNIT INSTALL JUMPERS IN THE POSITIONS MARKED

	1	2	3	4	5	6	7	8	9	10	11	12	13	14	15	16	17	18
A																		
B																		
C																		
E																		

	R1024	R1062	R1081	R1080	C10
A				56k	2.2k
B&C	27k	100k			0.0
E	27k	100k			0.0

SCHEMATEEK
 Beh. T. Hultermans
 Postbus 4228
 5604 EE Eindhoven

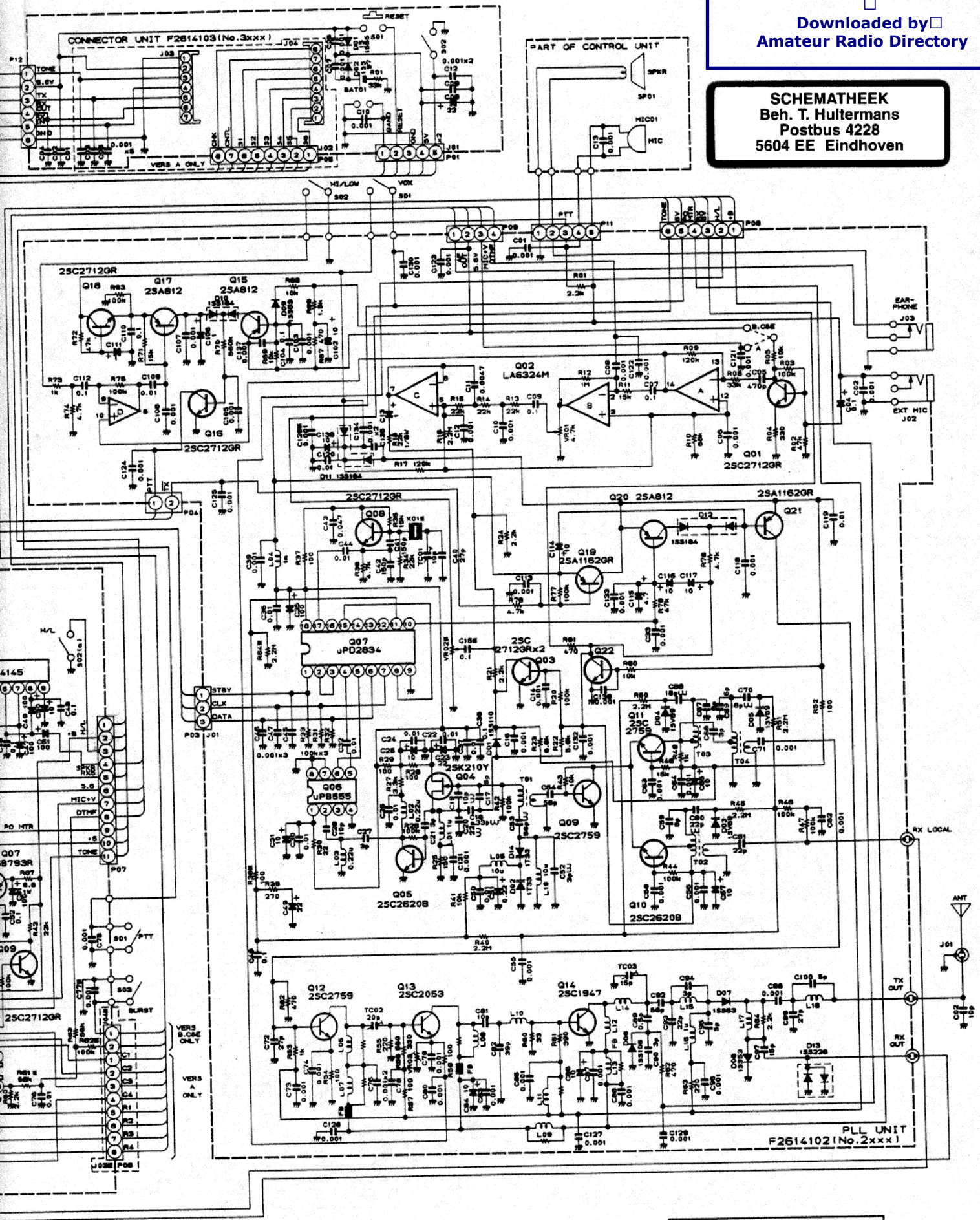

RX & PLL COMPONENT VARIATIONS

	R1024	R1062	R1061	R1060	C1077	C1074	C1075	Q1019	C01001	U1003	U1004	X2001	R2038	R2064	C2015	C2128	VR2002
A	B&C	27k	100k	56k	2.2k	0.001	33p	33p	R4087	3.58MHz	8P	B.12MHz	100	2.2M	0.1	0.001	47k
E	27k	100k			0.001						2P	B.12MHz	100				

FT-209R
CIRCUIT DIAGRAM