

# **INSTRUCTION / MANUAL**

**FT 220**

**YAESU MUSEN CO , LTD.**

TOKYO JAPAN.

## FT-220 SSB FM CW TRANSCEIVER



### GENERAL DESCRIPTION

The model FT-220 two meter transceiver is a precision built, compact, high performance transceiver of advanced design providing SSB (USB or LSB selectable), FM and CW modes of operation. The transceiver operates at an input of 20 watts on 144 through 146 MHz. All circuits are transistorized and composed of plug-in modules permitting easy maintenance.

The transceiver is self-contained, requiring only an antenna and power source for home, portable or mobile operation. The transceiver may be operated from 100/110/117/200/220 or 234 volt AC when appropriately wired, but normally supplied for 117 volt AC and 12 volt DC operation. The two-way solid state power supply is built-in. Two power cords are provided with the transceiver. Selection of AC or DC power source is automatically made when the proper line cord plug is inserted into the receptacle on the rear panel.

Adoption of wide band amplification technique throughout the transceiver requires no tuning control, such as plate, loading or pre-selector.

All accessories, such as VOX, break-in CW with side-tone, 100 KHz calibrator, noise blanker and squelch are built-in. In addition, crystal-controlled channels (4 channels x 4 bands = 16 channels), clarifier and speaker are integral parts of the unit. For tone actuated repeater service, an adjustable "tone burst" generator is included.

The entire transceiver weighs approximately 8.5 kg, and is 280 m/m wide, 125 m/m high, and 295 m/m deep. The construction is of heavy-gauge steel which provides extremely rugged package, virtually immune to the effects of vibration and shock.

The FT-220 is supplied complete with all cables, connectors and microphone as shown in Figure 1.

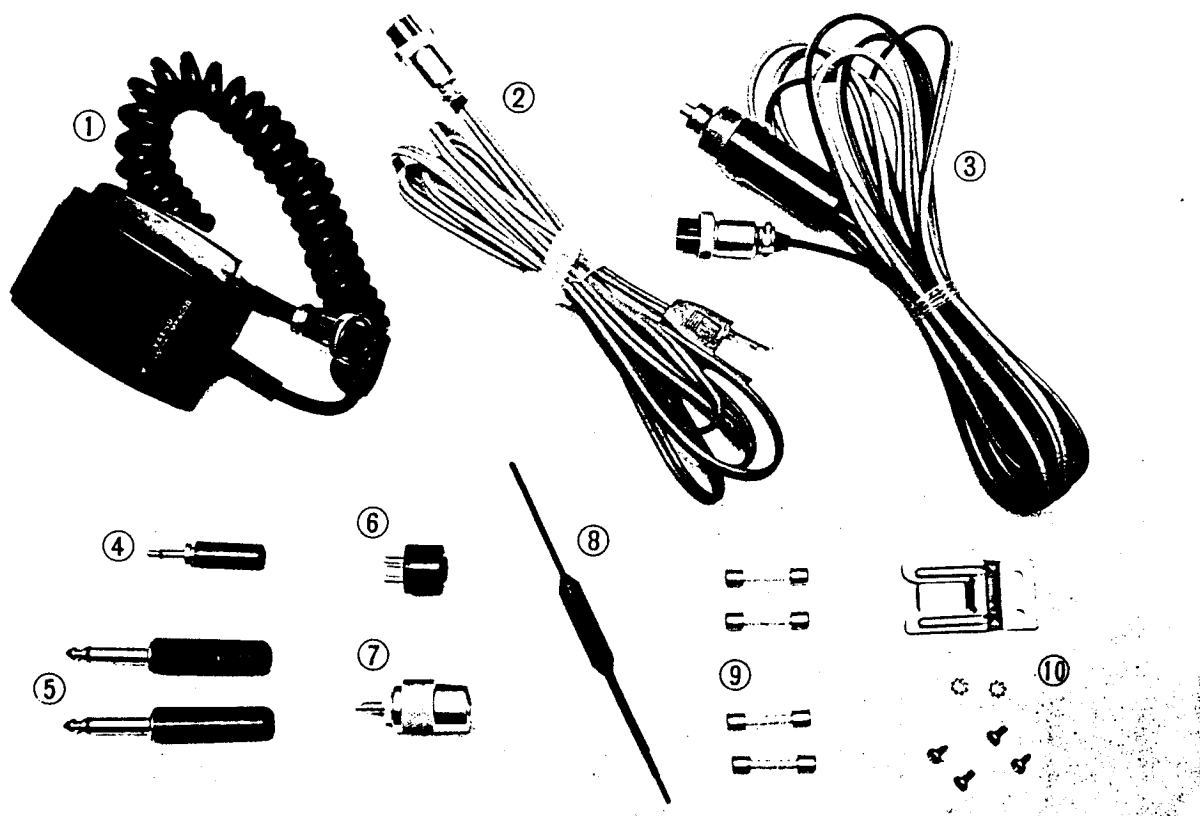

Figure 1

## SPECIFICATIONS

### GENERAL

Frequency Range	144.0 - 144.5 MHz 144.5 - 145.0 MHz 145.0 - 145.5 MHz 145.5 - 146.0 MHz (1 kHz frequency readout)
Emission	SSB (USB or LSB selectable) FM CW
Power Output	10 watts
Antenna Impedance	50 ohm unbalanced
Spurious Radiation	Down 60 dB or more
Speaker Impedance	4 ohms
Audio Output	2 watts at 10% distortion
Repeater Burst Signal	1300 to 3000 Hz adjustable
Power Requirement	AC 100/110/117/200/220/234 volts 50/60 Hz DC 12 - 14.5 volts, negative ground
Power Consumption	AC Receive 30VA Transmit 90VA at 10 watt output DC Receive 0.6A Transmit 3A at 10 watt output

### SSB, CW

Carrier Suppression	40 dB or better
Unwanted Sideband Suppression	... 40 dB or better
Transmitter Frequency Response	... 300 - 2700 Hz $\pm$ 3 dB
Sensitivity	0.5 uV S/N 10 dB
Selectivity	2.4 kHz at -6 dB 4.1 kHz at -60 dB
Image Ratio	Better than 60 dB

FM

Modulation .....	Variable reactance frequency modulation
Deviation .....	Maximum $\pm 12$ kHz
Sensitivity .....	-4 dB for 20 dB QS
Selectivity .....	$\pm 10$ kHz at -6 dB $\pm 20$ kHz at -60 dB
Image Ratio .....	60 dB or better

SEMICONDUCTORS COMPLEMENT

TRANSISTOR

2SC372Y	29	2SC1589	1
2SC373Y	4	2SC1590	1
2SC735Y	3	2SC1591	1
2SC784R	7	2SD313	2
2SC828Q	2	2SD114	1
2SC741	1		

FET

2SK19GR	8	3SK40	2
2SK19Y	1		

INTEGRATED CIRCUIT

AN214R	1	TA7042M	1
MC1496G	1	TA7045M	2
SN7400	1	TA7061AP	1
SN7490	1		

S. C. R.

CW01B	1
-------	---

DIODE

1S188FM	18	DS130MD	1
1S330	2	IN4740	3
1S990	1	MX-1	1
1S1007	9	AW01-15	1
1S1555	9	WZ061	1
1S2236	1	WZ090	4
4B20Y	1	WZ110	3
10D1	6		

## INSTALLATION

### GENERAL

The model FT-220 transceiver has been designed primarily for base service requiring only an antenna. However, the transceiver provides an efficient mobile service with its compactness. The transceiver has been factory pre-tuned and requires no adjustment for normal operation into a 50 ohm load.

The antenna and its location are the most important consideration in both base and mobile installations with effective communication range directly related to antenna height. The antenna should always be as high and in the clear as possible, however a minimum distance of 5 feet should be maintained between the VHF and other antennas. Also in mobile installation it is advisable to locate the antenna as far from the engine as practical to minimize ignition noise pickup. In all installations the most popular antenna type is either a 1/4 wave length whip with unity gain or a 5/8 wave length whip with matching device at base of the whip affording approximately 3.5 dB gain. Our mobile antenna RSL-145 is available through your dealer.

To minimize loss in the antenna system, use the shortest length of coaxial cable that is practical, avoiding any sharp angles or kinks. Use type RG-8/U cable if the transmission line length exceeds 25 feet, while RG-58/U may be suitable for shorter lengths.

### BASE STATION INSTALLATION

The transceiver is designed for use in many areas of the world using supply voltage that may differ from the operator's local supply voltage. Therefore, before connecting the AC cord to the power outlet, be sure that the voltage marked on the rear of the transceiver agrees with the local AC supply voltage. If not, please refer to Page 8 for rewiring of transformer primary connections.

### CAUTION =====

PERMANENT DAMAGE WILL RESULT IF IMPROPER AC SUPPLY VOLTAGE IS APPLIED TO THE TRANSCEIVER. OUR WARRANTY DOES NOT COVER THE DAMAGE CAUSED BY IMPROPER SUPPLY VOLTAGE.

Be sure that a proper fuse is used for local supply voltage, 2 amps for 117 volts and 1 amp for 220 volts. The transceiver should be connected to a good ground. The ground lead should be connected to the terminal marked GND located on the rear panel of the transceiver.

It is recommended that an excessively warm location be avoided. The transceiver should be placed in a location that has adequate space to permit free air circulation through the cabinet openings.

## MOBILE INSTALLATION

The transceiver will operate satisfactorily from any 12 volt negative ground battery source by connecting the DC power cord to the rear panel receptacle. In the car, a location should be selected clear of heater duct to protect it from the excessive heat. No special mounting precautions be observed if adequate ventilation space is available. A minimum of two inches of air space above the cabinet top and on all sides is recommended to allow proper air flow around the cabinet. You may put it on the seat but be sure that there is clearance between the transceiver bottom and seat. As the transceiver requires an average of 3 amps on transmit, the fuse in the DC power cable should be rated 5 amps.

When making connections to the car battery, be certain that the RED lead is connected to the positive (+) terminal and the BLACK lead to the negative (-) terminal of the battery. Reversed connection could permanently damage the transceiver. The BLACK lead should run directly to the negative terminal of the battery. The power cable should be kept away from ignition wires and be as short as possible to minimize voltage drop and to provide a low impedance path from the transceiver to the battery.

Prior to operating the transceiver in a mobile installation, the voltage regulator setting should be checked. In many vehicles, the voltage regulations are very poor and in some cases the regulator may be adjusted for an excessively high charging voltage. As the battery and regulator age, the maximum voltage while charging can increase to a very high level which is injurious to the battery and could cause damage to the transceiver.

The transceiver is designed to operate from a source voltage range of 11 to 14 volts. It is necessary to carefully set the regulator so that the highest charging voltage does not exceed 14 volts. The transceiver should be switched "OFF" when vehicle is started to prevent voltage transients from damaging transistors.



It is recommended to use the microphone furnished with this transceiver, however any other microphone of 500 - 600 ohm impedance may be used without any problem. Refer to Figure 2 for microphone plug connection. The microphone may be put on the side of the cabinet. It may also be put any any convenience place making two 2.5 m/m holes in 14 m/m space.

A speaker is built in the transceiver, but the speaker output is also available for external speaker use. Any speaker having 4 ohm impedance may be used as external speaker and when the external speaker plug is plugged in the EXT SP jack on the rear panel the built-in speaker is disabled.

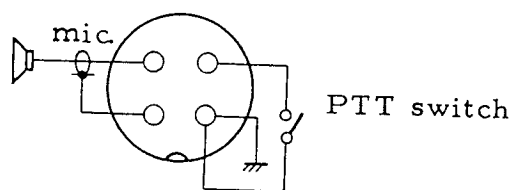

Figure 2

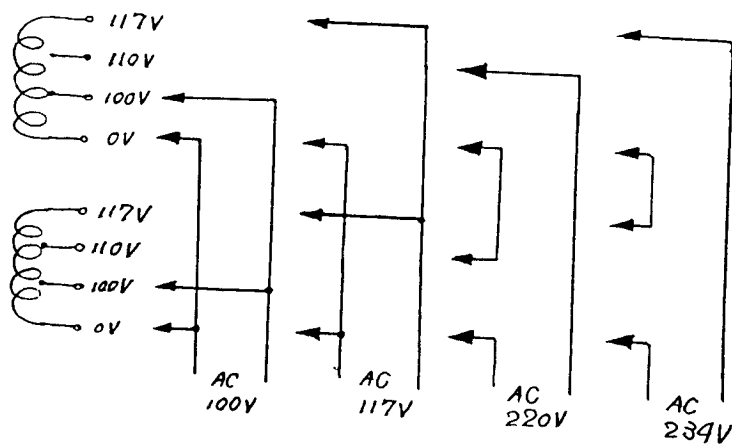

Figure 3 : Transformer Wiring

## CONTROLS AND SWITCHES

The transceiver has been specifically designed for ease of operation and versatility. All controls have been preset at factory. Several of the controls are unusual in operation, and improper adjustment may result in poor quality signals. The various front panel controls and their functions are described in the following section. Be certain that you thoroughly understand the function of each control before operating the transceiver.

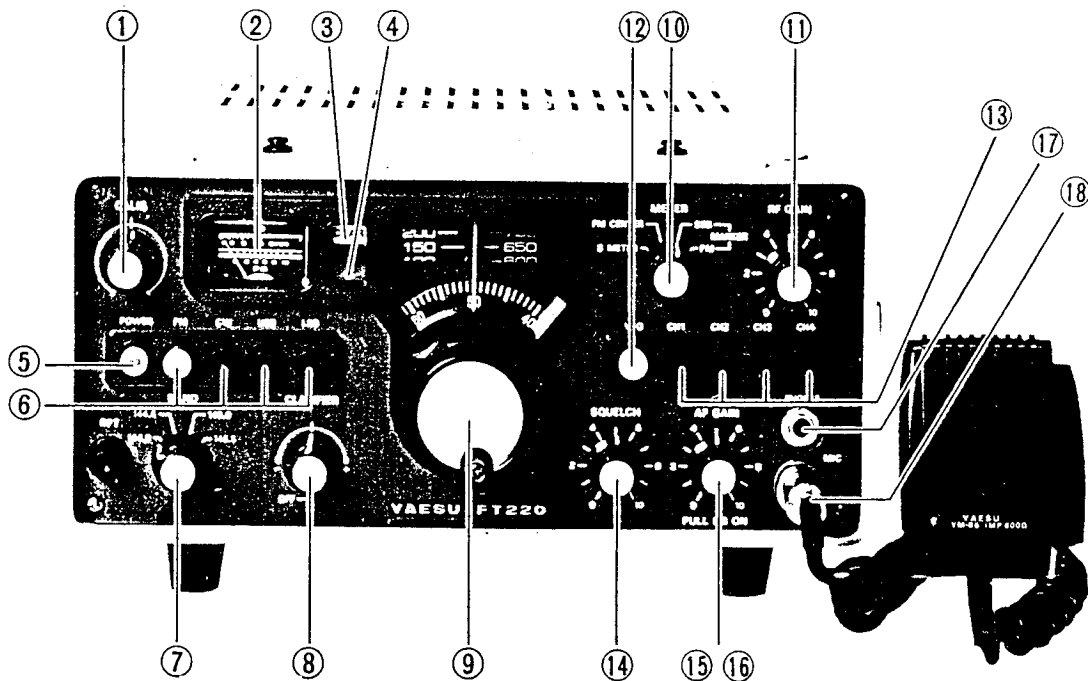

Figure 4 : Front Panel

- |     |                             |   |  |
|-----|-----------------------------|---|--|
| (1) | CALIB (calibration) control | - | The CALIB control is used to calibrate the frequency indication on the dial against marker signal.           |
| (2) | METER                       | - | The METER indicates signal strength, FM frequency center in receive and a relative power output in transmit. |
| (3) | CLAR (clarifier) indicator  | - | With the clarifier ON, this indicator lights up.   |

- (4) FIX (fix channel) indicator - This indicator lights up when the crystal control channel is selected instead of VFO control.
- (5) POWER switch - The POWER switch turns transceiver "ON" when depressed, and "OFF" when released for both AC and DC operation.
- (6) MODE (FM/CW/USB/LSB) switches - These switches are used to select the mode of operation desired when they are pushed in. Do not push down two switches simultaneously.

FM --- Frequency Modulation  
CW --- Code  
USB -- Upper Sideband  
LSB -- Lower Sideband

- (7) BAND switch - The BAND switch is a four-position switch to select one of 500 kHz segments in two meter amateur bands. These segments are:

144.0 --- 144.0 - 144.5 MHz  
144.5 --- 144.5 - 145.0 MHz  
145.0 --- 145.0 - 145.5 MHz  
145.5 --- 145.5 - 146.0 MHz

- (8) CLARIFIER control - The CLARIFIER control provides a means of tuning the receiver frequency approximately 4 kHz to either side of the transmitting frequency. Thus it is possible to set the pitch of the voice you are receiving to the most readable point without affecting your transmitting frequency on SSB operation. Its use is particularly valuable in "net" operation when several participants may be transmitting slightly off frequency. The CLARIFIER control may be switched off and the receiver locked to the transmitting frequency. Normally you will want to keep the CLARIFIER in the OFF position until the initial contact is made.

- (9) MAIN TUNING and DIAL - The TUNING knob located below the DIAL window in combination with the band switch determines the actual frequency of operation. The VFO drive mechanism consists of a precision spring loaded split system in combination with a planetary drive unit to provide zero backlash at low tuning rates. Each revolution of the TUNING knob results in a frequency change of 10 kHz as indicated on the DIAL window.
- (10) METER switch - The METER switch selects meter mode calibration to read following indications and turns marker signal ON.
- S Meter ----- The strength of receiving signal in S-unit for all modes.
- FM Center --- Discriminator center current for FM reception.
- SSB Marker -- Turns the 100 kHz calibrator ON for dial calibration on SSB signal.
- FM Marker --- Turns the 100 kHz calibrator ON and reads discriminator center current for FM calibration.
- When the METER switch is at the S Meter position, the meter shows a relative power output in transmit.
- (11) RF GAIN control - The RF GAIN controls the gain of RF amplifier stage.
- (12) VFO switch - When the VFO switch is pressed down the transceiver frequency is controlled by the main tuning knob.
- (13) CH1 - CH4 (crystal controlled channel) switch - Four crystals can be installed for the crystal controlled operation, and when pressed the transceiver frequency is controlled by the crystal of depressed channel. Fix channel indicator (4) lights

when the transceiver is crystal controlled. The crystal frequency unchanged when the band switch is changed. For example, the crystal controlled frequency of 144.25 MHz in the 144.0 segment becomes 144.75 MHz in 144.5 segment.

- (14) SQUELCH control
  - The SQUELCH control adjusts the receiver squelch threshold level.
  
- (15) & (16) AF GAIN control & NB switch
  - The AF GAIN control adjusts the receiver audio output level. When the knob is pulled out, the NOISE BLANKER is placed into the circuit.
  
- (17) PHONE receptacle
  - Headphone may be inserted in this receptacle for private listening. The internal speaker is disconnected when the headphone plug is inserted.
  
- (18) MIC receptacle
  - It is recommended to use the microphone supplied with the transceiver, however, any microphone having 500 to 600 ohm impedance can be used.

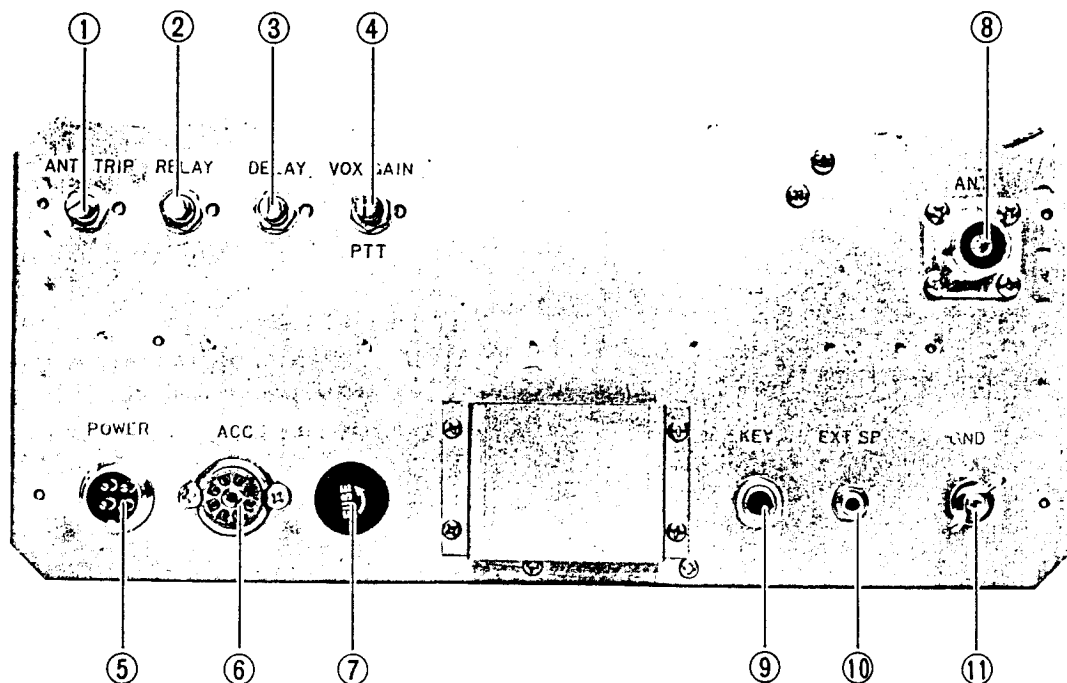

Figure 5 : Rear Panel

- |     |                  |   |  |
|-----|------------------|---|--|
| (1) | ANTITRIP control | - | The ANTITRIP control adjusts a threshold voltage to prevent the speaker output from tripping the transceiver into the transmit function. |
| (2) | RELAY control    | - | The RELAY control provides coarse adjustment for VOX relay sensitivity.  |
| (3) | DELAY control    | - | The DELAY control determines the relay hold time.  |
| (4) | VOX GAIN control | - | The VOX GAIN control adjusts VOX relay sensitivity.  |
| (5) | POWER receptacle | - | Both AC and DC cables are supplied with the transceiver.   |

- (6) ACC (accessory socket) - Accessory socket provides access to the transceiver operating voltage and relay contact at this outlet.
- (7) FUSE - Fuse holder for AC operation. Two amp fuse is used for 100 volts and 1 amp for 220 volts.
- (8) ANT - Coaxial connector for antenna.
- (9) KEY - Key jack for code operation.
- (10) EXT SP - Audio output is provided at this jack. Output impedance is 4 ohms and the internal speaker will be disabled when the plug is inserted.
- (11) GND - Ground connection.

## OPERATION

The tuning procedure of the transceiver is not complicated, however care should be exercised when tuning to insure peak performance of the equipment. The following paragraphs describe the procedure for receiver and transmitter tunings.

### INITIAL CHECK

Before connecting the transceiver to a power source, carefully examine the unit for any visible damage. Check that all modules and crystals are firmly in place and that controls and switches are operating normally. Ensure that voltage specification marked on rear panel matches the supply voltage.

### RECEIVER

After the transceiver is properly set up for operation, set the controls and switches as follows:

POWER	OFF
BAND	Desired band
CLARIFIER	OFF
DIAL	Around the frequency desired
SQUELCH	Fully CCW position
AF GAIN	Fully CCW position
VFO	Depressed position
METER	S-Meter
RF GAIN	Fully CW position

Turn on POWER switch. The dial and meter lamps light up, and the transceiver is now ready to operate. Slowly advance AUDIO GAIN control until the receiver background noise is heard. Set the control for desired listening level.

Rotate the main tuning control (VFO) and tune in the signal. USB (upper sideband) is mostly used for 2 meter SSB operation. When the received signal can not be heard clearly then change the sideband to another sideband. RF GAIN control is normally set to fully clockwise position, but if the incoming signal is extremely strong it is recommended to turn this control back to prevent overload of front end. When there is noise caused by automobiles, switch on NB (noise blanker) to eliminate the noise.



The above described receiving techniques are for SSB modes, and these are common for other modes of operation. However there are a few different techniques for other modes as described below.

CW Mode : With CLARIFIER switch OFF position, tune the signal until 800 Hz beat tone is heard. Under this condition your transmitting frequency coincide with the receiving signal. If you desire to hear the beat tone at your choice, then use the CLARIFIER control.

FM Mode : Tune the tuning control to the incoming signal for maximum and steady S-Meter reading where a natural voice is heard. For accurate tuning, set the METER switch to FM CENTER position. Carefully readjust tuning control until the meter indicates zero (half way of the full scale). If the S-Meter indication wabbles or if a clean audio output is not available, it is very likely that the signal is in SSB mode. In this case, push SSB switch (USB or LSB) down, and carefully tune the tuning control until clear voice is heard. It is important that the CLARIFIER switch should be set to OFF position when calling the other party. After contact is made, then the CLARIFIER may be used for the most easy listening sound.

### Calibration of the Frequency

#### ° Dial Readout

The main tuning dial is color coded with the band selector switch for proper frequency readout. When the band selected is marked in white on transceiver front panel the operator reads white scale on the main tuning drum. When the band selected is marked in green the operator reads green scale. The main tuning drum is marked in 50 kHz increments. This provides a coarse frequency setting within the band. The sound subdial on the dial window surrounding the tuning knob is scaled in 1 kHz increments and provides fine settings of the transceiver operating frequency. Following example will familiarize yourself with the relationship of main and subdial frequency readout.

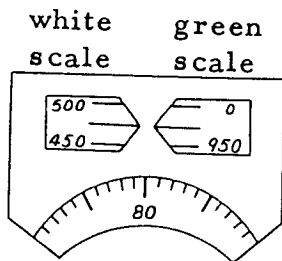

Figure 6

Read white scale on main dial for the bands 144.0 and 145.0, and green scale for 144.5 and 145.5.

Then the setting shown in the example would be 144.480 MHz on 144.0 BAND switch setting, and 145.480 MHz on 145.0. And also the frequency would be 144.980 MHz on 144.5 BAND switch setting, and 145.980 MHz on 145.5.

#### ° SSB Mode

Set the CLARIFIER to OFF position, and the tuning control to the 100 kHz point in the dial nearest the desired frequency. Set the METER switch to SSB MARKER position and adjust the CALIBRATOR control for zero beat. The transceiver must be recalibrated when changing the mode of operation of USB, LSB or CW.

#### ° FM Mode

Set the CLARIFIER to OFF position, and the tuning control to the 100 kHz point in the dial nearest the desired frequency. Set the METER switch to FM MARKER position and adjust the CALIBRATOR control until the meter indicates red line at the center of the scale.

NOTE : WHEN THE METER SWITCH IS IN MARKER POSITION, THE ANTENNA IS DISCONNECTED FOR EASE OF CALIBRATION.

### TRANSMITTER

Connect a 50 ohm dummy load or matched antenna to the coaxial fitting on rear panel. As the transmitter section utilizes wide band technique, no tuning control is necessary except the main tuning control to select the operating frequency. Plug in the microphone into MIC jack and select the desired mode. Push down the PTT (push-to-talk) switch on the microphone and speak into the microphone.

#### ° SSB Operation

The meter indicates maximum deflection on voice peak and zero with no microphone input. Release the PTT switch for receive. The MIC GAIN control, VR401, is located on a printed board under top cover

and it has been preset at factory for ordinary QSO and should not be readjusted unless it is necessary to do so.

° CW Operation

Plug in the key into the KEY jack on rear panel. Push down the CW switch on front panel. Rotate the VOX GAIN control fully counter-clockwise and set it to the low VOX gain position to prevent the microphone input from tripping the transmitter. On key down condition, the meter will show 6 to 8 relative power output, and with key up, the receiver recovers.

° FM Operation

Press down the FM switch on front panel, and push the PTT switch on the microphone and speak into the microphone. The meter will show 6 to 8 relative power output. Release the PTT switch on the microphone for receive. The MIC GAIN, VR403, is located on a printed board under top cover, however it is not necessary to touch it as it has been preset at factory to the suitable value for ordinary operation.

° VOX (voice controlled) Operation

Adjust the VOX GAIN control on rear panel until the voice actuates the transmitter speaking into the microphone normally. Set the ANTITRIP control to the minimum point to prevent the speaker output from tripping the VOX circuit. Do not use more VOX GAIN or ANTITRIP GAIN than necessary. Adjust the DELAY control for suitable release time. The RELAY control provides coarse adjustment for relay sensitivity and this control has been preset at factory.

° Repeater Operation

Push down RPT switch on the front panel, then receiving frequency is automatically shifted 600 kHz higher than transmitting frequency. For tone actuated repeater operation, set the BURST switch on rear panel to "BURST" position. The tone burst signal is then automatically transmitted at the beginning of transmission. The tone burst signal may be disabled with the BURST switch at "OFF" position. The frequency and duration of the tone burst signal may be adjusted by the controls in the SSB IF unit as shown in Figure 7.

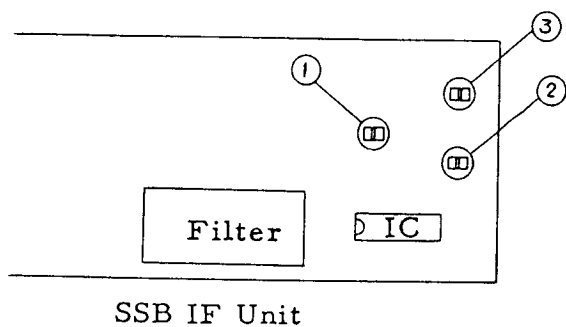

Figure 7

° Crystal Controlled Operation

In addition to the normal VFO controlled operation, four crystals may be selected for crystal controlled operation by push-button switches on the front panel. The crystal controlled operation is of great advantage where the transceiver is operated on the preset frequencies. As the entire 2 meter band has been spilited into four bands, four crystals can be used as 16 crystal controlled channels.

The crystal holders accept standard HC-25/U type crystals. All crystal frequencies must fall between 8,000 kHz and 8,500 kHz. A trimmer capacitor has been connected in series with each crystal to permit proper frequency adjustment. Adjustment of this trimmer will change the crystal frequency approximately 1 kHz. The correct crystal frequency for any desired operating frequency can be determined by the following formula.

$$f_x = f_o - f_l$$

where  $f_x$  : crystal frequency  
 $f_o$  : operating frequency  
 $f_l$  : given from Table 1

BAND (MHz)	LSB (kHz)	USB (kHz)	FM (MHz)
144.0 - 144.5	130001.5	135998.5	136.0
144.5 - 145.0	136501.5	136498.5	136.5
145.0 - 145.5	137001.5	136998.5	137.0
145.5 - 146.0	137501.5	137498.5	137.5

Table 1

Example (1) --- Find the proper crystal frequency for 144.15 MHz USB operation.

From the table,  $f_1$  for USB is 135998.5.

Therefore,  $f_x = 144.15 - 135.9985 = 8151.5$  kHz.

Example (2) --- 144.72 MHz FM operation

$f_x = 144.72 - 136.5 = 8220$  kHz

## CIRCUIT DESCRIPTION

The block diagram and following circuit description will provide you with a better understanding of this transceiver.

### RECEIVER

The 144 MHz input signal from the antenna is fed through antenna relay to the first gate of RF amplifier, Q501, 3SK40, field effect transistor. The second gate of Q501 automatically controls the gain of RF amplifier with the AGC voltage applied to this gate. The amplified signal is applied through three stage hi-Q slot coupled resonators to the first mixer, Q502, 3SK40. The use of an FET RF amplifier, together with the slot coupled resonators, combines to minimize effects of cross modulation and other spurious responses, while providing a low noise figure for the receiver front end. The amplified 144 MHz signal is heterodyned with the signal delivered from premix circuit and produces the first IF signal of 10.7 MHz. The first mixer injection signal is 10.7 MHz below the input signal in all cases.

#### ° SSB/CW Operation

The 10.7 MHz IF signal is amplified through the first IF amplifiers, Q1301, 2SC784R, and Q1306, 2SC372Y. This signal is then fed through noise blanker diode, D1305, 1S1555, and the crystal filter, XF201, to two stage IF amplifiers, Q202 and Q203, TA7045M. The output from Q203 is fed to the ring demodulator, D407 through D410, 1S1007, which works as balanced modulator in transmit. The carrier oscillator oscillates either crystal controlled 10698.5 kHz for USB or 10701.5 kHz for LSB and CW depending upon whether Q409, 2SC373, or Q410, 2SC373, is selected by the MODE switches. The MODE switch disconnects the emitter circuit and either transistor when not in use. The output from the carrier oscillator is fed to the ring demodulator through the balancing potentiometers, VR405 and VR406.

These crystal frequencies are matched to the pass band of the crystal filter to place the carrier frequency approximately 25 dB down on the skirt of the filter response. The audio signal from the ring demodulator is fed through the MODE switches to the first audio amplifier, Q211, 2SC372Y. The output of Q211 is fed through the AUDIO GAIN control, VR7, to the power amplifier which utilizes the OTL (output transformer less circuit).

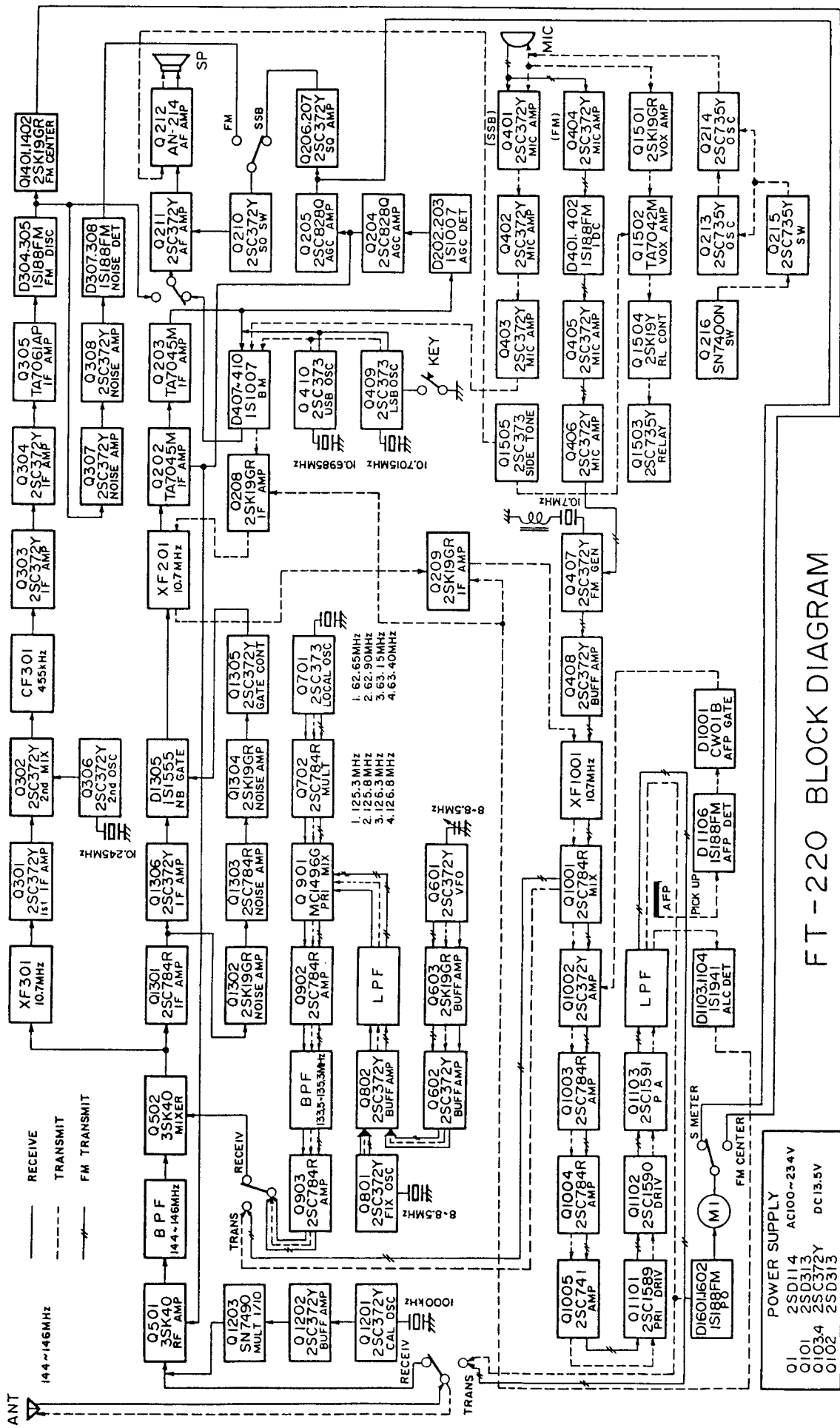

## ° FM Operation

The 10.7 MHz IF signal from the first mixer, Q502, is fed through a crystal filter, XF301, to the first IF amplifier, Q301, 2SC372Y. The amplified 10.7 MHz IF signal is then fed to the second mixer, Q302, 2SC372Y, where the first IF signal is heterodyned with the 10.245 MHz signal fed to the emitter from the second heterodyne oscillator, Q306, 2SC372Y, and to produce the second IF signal of 455 kHz at the output of Q302.

The 455 kHz IF amplifier circuit consists of Q303, Q304, 2SC372Y, and Q305, TA7061AP. The ceramic filter, CF301, provides the adequate selectivity for FM receiver, and the limiting action of Q305 removes any amplitude modulation component in the signal applied to the discriminators, D304 and D305, 1S188FM. The discriminator produces an audio output in response to a corresponding frequency (or phase) shift in the 455 kHz IF signal. The discriminator output is then fed to the common audio amplifier stage through the MODE switch.

## TRANSMITTER

### ° SSB/CW Operation

A speech signal from the microphone is fed to the first microphone amplifier, Q401, 2SC372Y, from pin 2. Input impedance of the microphone amplifier is 500 ohms. The amplified signal, controlled in amplitude by VR401 (preset at factory), is amplified by the second microphone amplifier, Q402, 2SC372Y, and applied to the emitter follower, Q403, 2SC372Y, to be delivered to the ring connected balanced modulators, D407 through D410, 1S1007. The carrier oscillator oscillates 10701.5 kHz by Q409, 2SC373, for LSB or 10698.5 kHz by Q410, 2SC370, for USB. The double sideband suppressed carrier signal is amplified by Q208, 2SK19GR. The unwanted sideband is rejected by the crystal filter, XF201, and then a single sideband signal is amplified by Q209, 2SK19GR. The ALC voltage is applied to Q208 and Q209 to prevent the distortion by overdrive.

For CW operation, the 10701.5 kHz carrier signal is shifted approximately 800 Hz to 10700.7 kHz which is the center of the crystal filter pass band. The balanced modulator is unbalanced by applying DC voltage producing the carrier signal on its output. The CW carrier signal is then fed through XF201 to the gate of Q208 and amplified by Q218 and Q209.

The 10.7 MHz IF signal (SSB or CW) is fed to the mixer Q1001, 2SC784R, where it is heterodyned with the local signal of 133.3 MHz to 135.3 MHz delivered from premix circuit. Sum of two signals produces



144.0 to 146.0 MHz signal at the output of the mixer. The output signal from the mixer is fed to the buffer amplifier, Q1002, 2SC784R, and further amplified by 3 stage preamplifiers, Q1003, Q1004, 2SC784R, and Q1005, 2SC741. The signal is amplified by the driver stages, Q1101, 2SC1589, Q1102, 2SC1590, and fed to the final amplifier Q1103, 2SC1591 which delivers 10 watts RF signal to the antenna through the two stage low pass filter.

#### ° FM Operation

A speech signal from the microphone input, J3, is amplified by Q404, 2SC372Y, and fed through instantaneous deviation control circuit (IDC) to the speech amplifier stage, Q405, 2SC372Y. The IDC circuit, diodes D401 and D402, 1S188FM, clips both positive and negative peaks when the speech signals exceed a predetermined level to limit the maximum deviation of the transmitter. The IDC control, VR402, permits the deviation to be adjusted and is normally factory set for a deviation of  $\pm 5$  kHz. When wide-band deviation is desired, the VR402 must be readjusted to provide the wider maximum deviation.

The output from Q405 is fed through MIC GAIN control, VR401, to Q406, 2SC372Y. The audio signal from Q406 varies the bias applied to the varactor diode, D403, MX1, in turn causing the frequency modulation of 10.7 MHz signal generated by a crystal oscillator, Q407, 2SC372. The frequency modulated signal is amplified by buffer amplifier, Q408, 2SC372, and fed through a crystal filter, XF1001, to the gate of transmitter mixer Q1001, 2SC784R, where the 10.7 MHz signal is heterodyned with the signal from the premix circuit producing 144 MHz signal. The signal is then amplified in same manner as described in SSB operation.

### COMMON CIRCUITS

#### ° VFO & FIX Oscillator

The VFO (variable frequency oscillator), Q601, 2SC372Y, oscillates 8,000 to 8,500 kHz signal. Varactor diode, D601, 1S2236, is connected through C610, 5pF capacitor, to the tank circuit and used for the calibration of the dial and also for the CLARIFIER. The output from the VFO oscillator is fed to the buffer amplifiers, Q602 and Q802, 2SC372Y.

With one of crystal controlled channel switches, CH1 through CH4, pushed down position, the supply voltage to Q601 is disconnected to stop the VFO oscillation, and FIX channel crystal oscillator, Q801, 2SC372Y, starts to oscillate. The output from Q801 is fed through L801

to the buffer amplifier, Q802, 2SC372Y. The crystal frequency may be adjusted by the trimmer capacitors, TC801 through TC804, connected in series with crystals. When the FIX channel is in use the red light marked FIX comes on. The output signal from Q802 is fed through the band pass filter, L802, L803, L804, to the premix circuit.

The premix circuit is used to produce the local heterodyne signal for receiver and transmitter by mixing the VFO signal with the signal from the crystal oscillator for the band selection. The crystal oscillator, Q701, 2SC784R, oscillates the signal of 60 MHz range selected by the BAND switch. The output from Q701 is fed to the frequency doubler, Q702, 2SC784R. The output signal from Q702 (120 MHz range) is mixed by Q901, MC1496G, with the signal from VFO or FIX channel producing 133.3 MHz to 135.3 MHz local signal for the receiver or transmitter mixer stage.

The local heterodyne signal is fed through L901 and L902 to the buffer amplifier Q902, 2SC784R. The output signal from Q902 passes through slit resonators to eliminate spurious signal and is amplified by Q902, 2SC784R, to be delivered to the transmitter mixer, Q1001, or the receiver mixer, Q502.

#### ° Power Supply

The power supply has been designed to operate from either 100/110/117/200/220/234 volt AC or 12 volt DC negative ground. Inserting the appropriate power plug into the rear panel receptacle makes necessary connection to operate the supply in either mode, AC or DC.

For AC operation, DC voltage is supplied from bridge connected diodes, D101 through D104, 4B20Y, connected to 13 volts 3 amps secondary winding of the power transformer. The DC voltage is regulated at 13.5 volts with the voltage regulator circuit consisting of Q1, 2SD114, and Q103, 2SD313. Since the circuits require an extremely stabilized voltage such as VFO or crystal oscillator, the 13.5 volt DC voltage is further stabilized at 9 volts by Q101, 2SD313, and Q102, 2SC372Y.

For DC operation plus voltage is connected to pin 3 and minus voltage to pin 4 of the power receptacle, J7. To protect the circuits from reverse connection of DC voltage, D1, 130MD which conducts heavily at the reverse connection to blow the fuse in the DC power cord, is placed between pin 3 and ground.

## OTHER CIRCUITS

### ° Noise Blanker Circuit

The 10.7 MHz output signal from the receiver IF amplifier, Q1301, 2SC372Y, is amplified by noise amplifier, Q1302, 2SK19GR, and Q1303, 2SC784R. The noise rectifier diode, D1302, 1S1555, produces the bias voltage for a pulse rectifier diode, D1301, 1S1555.

Under normal condition, pulse amplifier, Q1304, 2SK19GR, conducts producing cut-off voltage to the base of gate controller, Q1305, 2SC372Y, in turn high collector voltage of Q1305 is supplied to a gate diode, D1305, 1S1555, which conducts to pass the signal freely.

With a pulse noise, D1302 causes a higher voltage exceeding the cut-off bias voltage for D1301. Thus the D1301 conducts for short duration supplying the negative voltage to turn off the Q1304. In turn the Q1305 conducts and its collector voltage drops causing the gate diode, D1305, to disconnect the IF signal during the noise pulse exists.

### ° AGC (automatic gain control) Circuit

The output signal from the receiver IF amplifier, Q203, TA7045M, is rectified by D202 and D203, 1S1007. The AGC voltage is amplified by the Q204, and fed to the RF amplifier, Q501, 3SK40, and IF amplifier, Q202, TA7045M, to reduce their gain automatically for the extremely strong signal.

### ° Meter Circuit

The DC output from the AGC amplifier, Q204, is amplified by the S-meter amplifier, Q205, 2SC328Q, to provide a meter deflection proportional to input signal. The meter is calibrated in the customary "S" units. A DC level at the discriminator output is applied to a differential amplifier, Q1401 and Q1402. When the frequency of received signal is shifted from the discriminator center, the resulting DC level causes either Q1401 or Q1402 to conduct indicating the amount of shift on the meter when the METER switch is placed to FM CENTER position.

A small portion of the RF output is rectified by D1601, 1S188FM, which delivers the resulting DC level to the meter where it provides an indication of relative power output from the transmitter.

### ° Squelch Circuit

For SSB reception, the voltage variation at the collector of the S-meter DC amplifier, Q205, 2SC828Q, is fed through the SQUELCH threshold control, VR5a, to the Schmitt circuit, Q206, Q207, 2SC372Y.

When no signal is present, the collector voltage of Q205 and Q207 rises and this DC voltage is applied to turn the squelch controller, Q210, 2SC372Y, "ON". With the Q210 "ON", the input circuit of the audio amplifier, Q211, is grounded to quiet the audio amplifier. When the signal is present, the Q210 is "OFF" and permits normal operation of the audio amplifier.

For FM reception, when no carrier is present in the 455 kHz IF, the "noise" at the discriminator output is amplified by the noise amplifier, Q307, Q308, 2SC372Y, and detected by D307, D308, 1S188FM. This DC voltage is applied to turn the Q210 "ON". With the Q210 "ON", the circuit works in same manner as described in the SSB operation.

#### ° Marker Circuit

The marker generator, Q1201, 2SC735Y, oscillates crystal controlled 100 kHz signal which is fed through the buffer amplifier, Q1202, 2SC735Y, to the receiver input circuit.

#### ° ALC (automatic level control) Circuit

The ALC circuit automatically controls the driving level to the final PA transistor to prevent the distortion caused by the overdrive. A small portion of the RF output power is rectified by the ALC diode, D1105, 1S188FM, which is biased by the ALC threshold control, VR1101, to determine threshold level. When the voltage exceeds this bias level, the D1105 conducts and the D1103, D1104, 10D1, produce the control voltage which is applied to the gate of the transmitter IF, Q208 and Q209, to control their gain.

#### ° AFP (automatic final protection) Circuit

The AFP circuit protects the final transistor from damage when the transmitter is operated without an antenna connected, or when a high VSWR exists in the antenna system. In such a case, the DC voltage rectified by the ALC diode, D1106, 1S188FM, is applied through the AFP threshold control, VR1103, to D1001, CW01B. When the DC voltage exceeds the threshold, the D1001 conducts causing the voltage drop through R1011. This voltage drop makes Q1001 and Q1002 stop the function to protect final stage from damage.

#### ° Tone Burst Circuit

The tone burst circuit consists of a timing generator and a gated multivibrator. When the REPEATER switch is set to the ON position and the transmitter "keyed", +13.5 volt DC is applied to the trigger logic

timing generator, Q216, SN7400N. The timing generator produces an output pulse applied to the switching transistor, Q215, 2SC735Y. The transistor Q215 gates the multivibrator, Q213, Q214, 2SC735Y, to produce a tone output that is applied to the microphone input of the transmitter section.

The tone frequency is adjustable between 1300 and 3000 Hz by VR204 while the output level (deviation) is adjustable by VR203, and the burst duration by VR205.

#### ° Repeater Circuit

With the RPT (repeater) switch at "ON" position, the diode switch, D701, 1S1007, selects the crystal X701 through X704 for 600 kHz shift of transmitting frequency. For normal operation, the diode switch, D702, 1S1007, selects the crystal X705 through X708.

## MAINTENANCE & ALIGNMENT

### GENERAL

Your model FT-220 transceiver has been carefully aligned and tested at factory prior to shipment. The reliability of the solid-state devices used in the FT-220 should provide years of trouble free service if the transceiver is not abused and normal routine maintenance is carried out.

The following precautions should be observed to prevent damaging the transceiver.

- (1) Do not misuse the power cord for AC and DC.
- (2) Do not apply any AC voltage other than the voltage determined by the transformer wiring.
- (3) Do not exceed 14 volt DC at the POWER receptacle in the DC operation. When operating mobile, check the battery voltage under the load (transmitter "keyed" in FM mode) with the engine running fast enough so the ammeter shows "charge". Also do not operate the FT-220 if the supply voltage is below 12 volt DC.
- (4) Avoid direct exposure to sunshine or water.

### ROUTINE MAINTENANCE

Routine maintenance should be limited to keeping the transceiver clean, and periodic performance checks of the transmitter RF power output and the receiver sensitivity.

#### Cleaning:

When the transceiver is used in dusty or sandy areas the interior should be periodically cleaned. A vacuum cleaner, or low pressure air source should be used, while accumulated dirt may be removed with a soft brush. Check that the interior is thoroughly dry before replacing the case and/or operating the equipment. Wipe the exterior with a damp cloth whenever required.

## PERFORMANCE CHECKS

Make all performance checks at 13.5 volt DC (under load) or AC voltage determined by the transformer wiring.

1. Check the transmitter output as follows:
  - (a) Connect a suitable 50 ohm dummy load/RF wattmeter to the ANT receptacle.
  - (b) Set to the FM mode and key the transmitter and check the power output. The power should be approximately 10 watts, and the S-meter should read between 6 and 8.
  - (c) Set to the SSB mode and key the transmitter. Normally speak into the microphone. The output meter shows 3 to 5 watts mean value.
  
2. Check the receiver sensitivity as follows:
  - (a) Connect an AC VTVM to the SP receptacle, set to the FM mode and set the SQUELCH control fully counter-clockwise.
  - (b) Connect the RF output of a precision, VHF signal generator to the ANT receptacle and with no signal input note the VTVM reading. Adjust the VOLUME control and VTVM range as required to obtain an approximate full scale reading. (DO NOT change the VOLUME control setting after this adjustment is made.)
  - (c) Set the signal generator to the receiving frequency of the transceiver and adjust the output amplitude of the signal generator until the VTVM reads 1/10th (20 dB decrease) of the reading in step (b). The signal generator output voltage at this point is the 20 dB quieting sensitivity, and should be approximately 0.3u volt.
  - (d) Set the mode switch to SSB position and connect the AC VTVM to the speaker output. Apply the none-modulated 0.5u volt signal from the standard signal generator and tune the transceiver for maximum VTVM reading.
  - (e) Set the RF GAIN control to the fully clockwise position and adjust the AF GAIN control for 450 mV VTVM reading.
  - (f) Cut the signal generator output and read the VTVM reading. The VTVM reading should be less than 45 mV for 10 dB S/N ratio.

If the above performance checks indicate a need for realignment it is recommended that the transceiver be returned to the dealer for alignment. The alignment procedures require special test equipment and techniques not normally available to the average owner. Attempts to realign the tuned circuits without proper test equipment will result in degraded performance of the transceiver.

## ALIGNMENT

THE FOLLOWING ALIGNMENTS ALSO REQUIRE SPECIAL TEST EQUIPMENT AND TECHNIQUES AND SHOULD ONLY BE DONE BY AN EXPERT ENGINEER WITH PROPER TEST EQUIPMENT.

The following alignments are done in receive mode unless otherwise noted.

### ° Receiver RF Amplifier (L501, L503 through L505)

These coils are aligned with a sweep generator for an optimum passband characteristics, however the following method may be suitable when the proper sweep generator is not available, though approximately 2 or 3 dB gain may be lost at the band edges.

Connect the RF output of a precision signal generator set its frequency to 145.00 MHz. Tune the transceiver to 145.00 MHz. Peak L501, L503 through L505 for maximum S-meter reading.

### ° SSB IF Amplifier 10.7 MHz (L508, L1301, L1307, L1308, L201, L202)

Set the mode switch to USB or LSB position. Connect the 10.7 MHz signal generator output to the base of Q502, 2SC784R, through 0.01 $\mu$ F capacitor. Peak L508 through L202 for maximum S-meter reading.

### ° FM IF Amplifier 10.7 MHz (L301, L302, L303)

Set the mode switch to FM position. Connect the 10.7 MHz signal generator output to pin 1 of P302 through 0.01 $\mu$ F capacitor. Peak L301 through L303 for maximum S-meter reading.



° Discriminator Crossover Adjustment (L305, L306)

Set the mode switch to FM position. Connect a 25-0-25 uA meter between pin 3 and the ground of accessory socket. Connect the output of a precision signal generator exactly set to 455 kHz to the base of Q302, 2SC372Y, through 0.01uF capacitor.

Rotate a slug of L306 fully counter-clockwise. Peak L305 for maximum meter reading. If the meter overscales, adjust the signal generator output for proper meter indication. Carefully adjust L306 to obtain "zero" indication on the meter.

° S-Meter (VR201, VR202)

Set the mode switch to USB or LSB position. Set the meter switch to S-Meter position. Set the RF GAIN control fully clockwise position.

Connect the output of the signal generator to the antenna connector. Set the signal generator output level to 100 dB. Tune the transceiver to the signal generator output. Adjust VR202 for full scale reading on the meter. Then set the output level of the signal generator to 0 dB. Adjust VR201 for S-meter reading of S5. Repeat above procedures until full scale at 100 dB and S5 at 0 dB indications are obtained.

Disconnect the signal generator output. Set the meter switch to FM CENTER position. Set the VR1402 to approximately middle of its travel. Adjust VR1401 carefully until the meter shows the center of its scale.

Rotate the VR1402 fully clockwise. Apply the signal generator output. Make sure that the meter indication moves both sides of the center when the main tuning dial is rotated slowly a few kHz up and down. Adjust VR1402 until the maximum deflection becomes 0 or 10 reading on the meter when the main tuning dial is rotated around the center.

° Noise Blanker (L1303, VR1301)

Set the mode switch to USB or LSB position. Connect the VTVM (DC 3V range) between the junction point of D1302, 1S1555, and R1312 (10 kilo ohms), and ground. Connect the 10.7 MHz signal generator to the base of Q502, 2SC784R, through 0.01uF capacitor. Peak L1303 for maximum VTVM reading. The noise blanker threshold control R1301 should be adjusted for the most effective point while receiving actual signal.

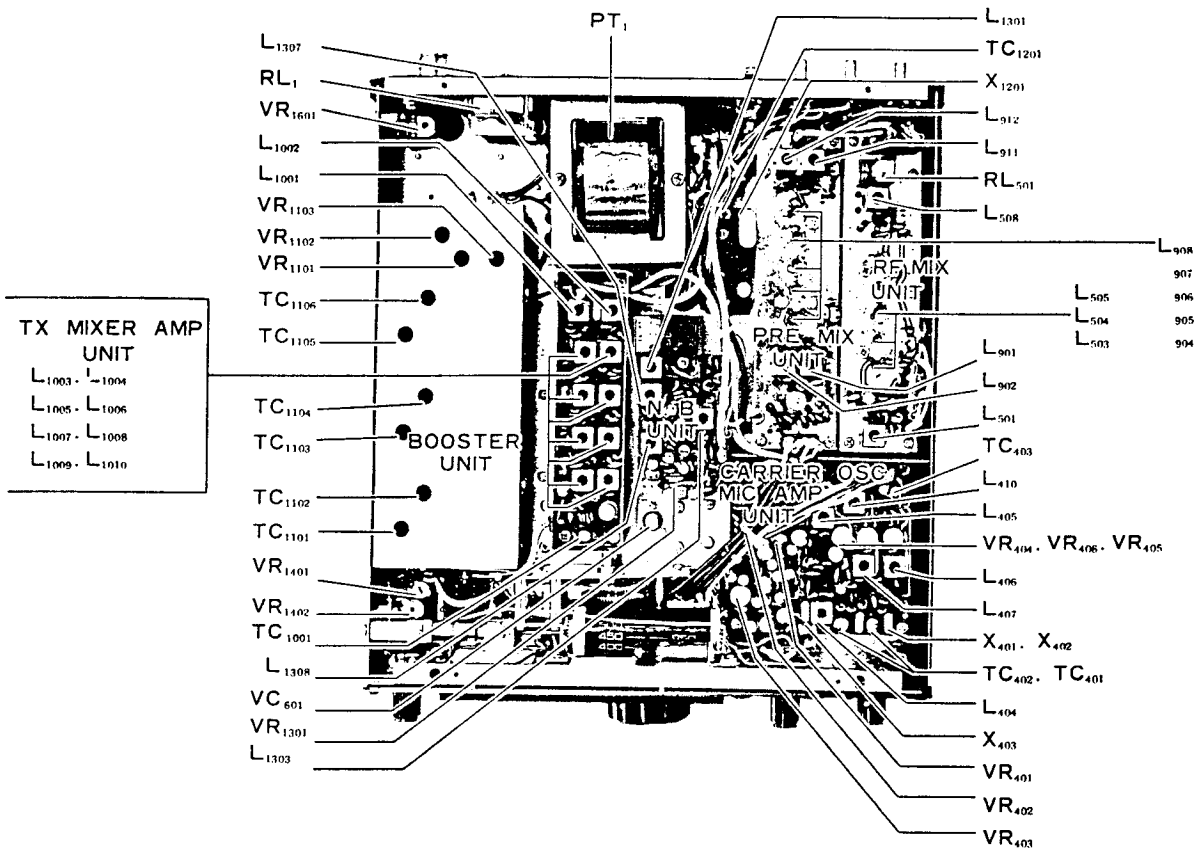

Figure 8 : TOP VIEW OF EARLIER MODEL

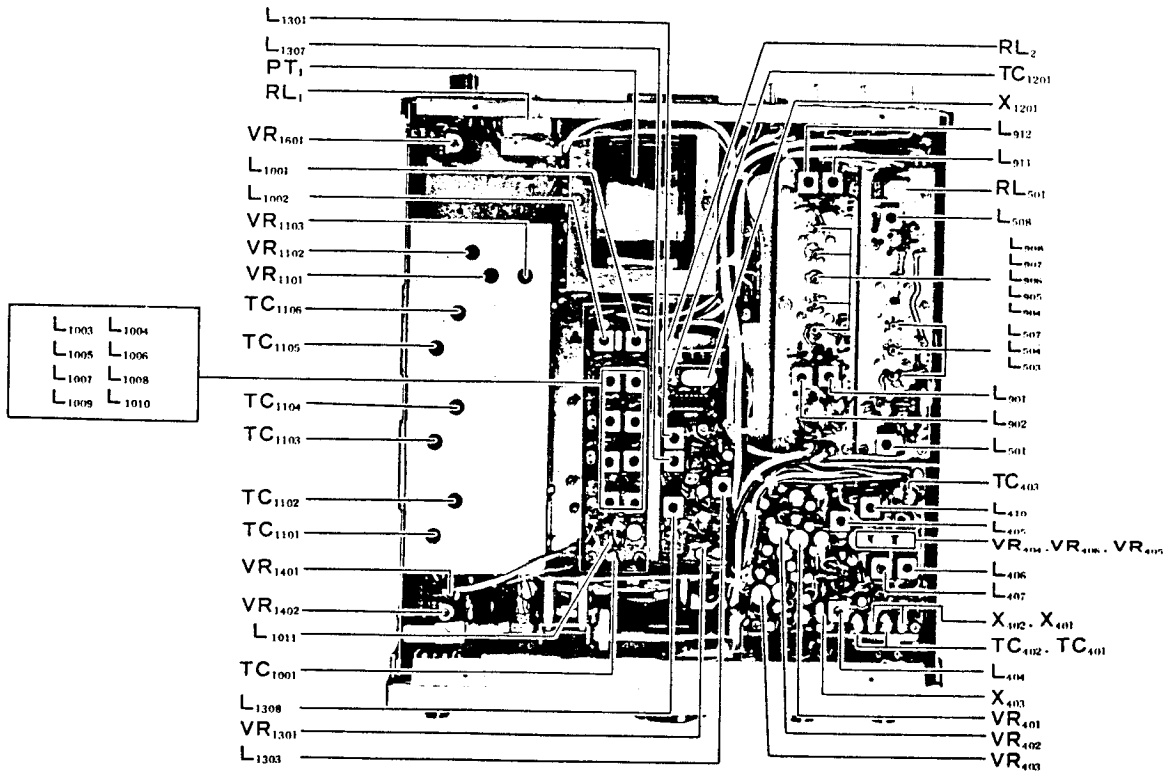

Figure 9 : TOP VIEW OF LATER MODEL

° Premix Circuit (L901, L904 through L908, L911, L912)

This circuit has been carefully aligned with a sweep generator for minimum spurious radiation. Therefore, extreme care is required for alignment. Connect the RF probe of a VTVM to pin 2 of P901 and ground. Carefully adjust L901 through L912 for 0.04 volt VTVM reading. Check the unity VTVM reading for all bands.

° Crystal Oscillator (L701, L702, TC701 through TC707) --- FOR EARLIER MODEL ONLY (Refer to Figure 10 on page 35.)

Connect the RF probe of a VTVM between the base of Q702, 2SC784R, and ground. Set the BAND switch to 145.5. Adjust L701 for 0.1 - 0.2 VTVM reading. In same way, adjust TC702 for 144.5 band and TC703 for 144.0 band for 0.1 - 0.2 volt VTVM reading.

Disconnect the VTVM from Q702 and connect it to pin 1 of P701. Peak TC706 for 144.0, TC705 for 144.5, TC707 for 145.0 and TC704 for 145.5 band for maximum VTVM reading.

° Local Oscillator (L702, L706, TC705 through TC708) --- FOR LATER MODEL ONLY (Refer to Figure 11 on page 35.)

Connect the RF probe of a VTVM to TP-701. Set the BAND switch to 144.5. Adjust TC709 for peak VTVM reading. Increase the capacitance of TC709 until the VTVM reading drops to 80% of the peak value. Disconnect the RF probe from TP-701 and connect it to pin 1 of P701. Adjust TC710 at 144.0 for 200 milli volt VTVM reading. Change the band to 144.5 and adjust TC711 for the same VTVM reading. Repeat this procedure for 145.0 adjusting TC712, and 145.5 adjusting TC712.

Disconnect the VTVM. Connect a frequency counter to the pin 1 of P701 and set the BAND switch to 144.0 and adjust the oscillating frequency to 125.3 MHz by adjusting L706 and TC705. Repeat this procedure for other bands as follows:

BAND	FREQUENCY (MHz)	TRIMMER
144.0	125.3	TC705
144.5	125.8	TC706
145.0	126.3	TC707
145.5	126.8	TC708

Table 2

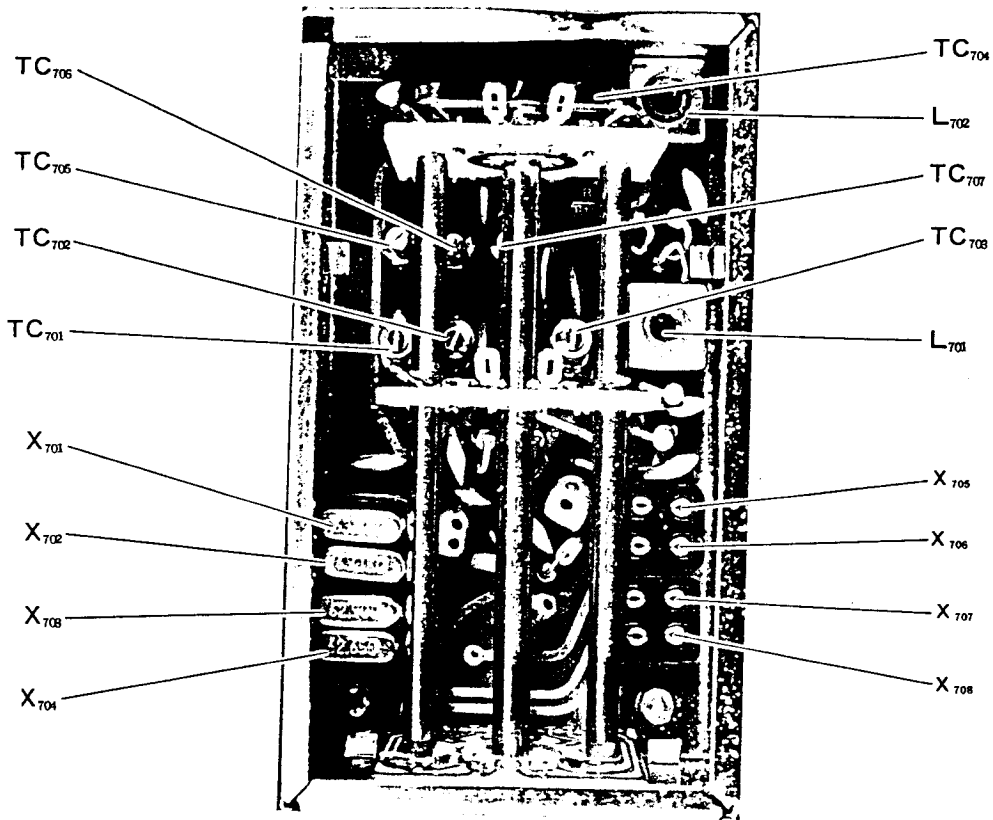

Figure 10 : EARLIER MODEL

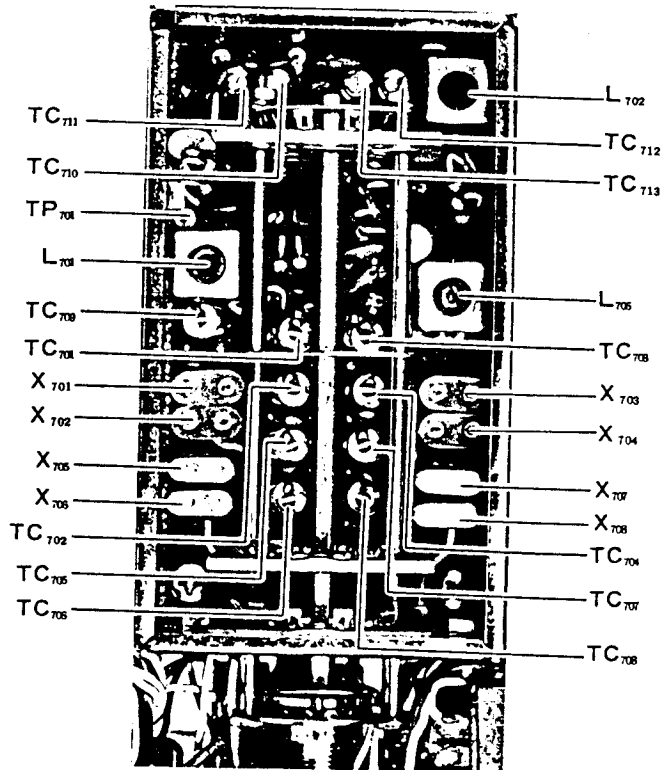

Figure 11 : LATER MODEL

° Clarifier (VR3)

Set the mode switch to USB or LSB position. Set the CLARIFIER control to OFF position. Set the meter switch to SSB MARKER position and tune the CLARIFIER control to zero position and adjust VR3 under the chassis for zero beat.

° Voltage Regulator (VR101)

Connect a VTVM between pin 15 of P101 and ground. Adjust VR101 on the regulator board for exactly 9.0 volt VTVM reading.

NOTE : IT IS NOT RECOMMENDED TO TOUCH THE VFO OSCILLATOR SECTION AS THE VFO UNIT HAS BEEN CAREFULLY ALIGNED AND TESTED AT FACTORY FOR LINEAR TUNING.

° 10.245 MHz Oscillator (L304)

Set the mode switch to FM position and connect a VTVM (DC 1V range) to TP on junction of R331 and C331, and ground. Adjust L304 for 0.18 volt VTVM reading.

° 10.7 MHz SSB TX IF Circuit (L207, L410)

Temporarily disconnect a wiring from pin 2 of PJ201. Apply the 1000 Hz audio signal to pin 2 of J2 (microphone jack). Set the mode switch to USB or LSB position. Connect the RF probe of a VTVM between the base of Q1001, 2SC784R, and ground. Peak L207 and L410 for maximum VTVM reading on transmit.

° Transmitter Tuning (L1003 through L1010, TC1001, TC1101 through TC1106)

Connect a 50 ohm dummy load to the ANT receptacle. Set the mode switch to FM, the BAND switch to 145.0 MHz and the VFO to 0 kHz. On transmit, adjust TC1001 and TC1101 through TC1106 for peak power output (approximately 10 watts). Adjust L1003 through L1010 for unity output for any setting of the BAND switch and VFO.

NOTE : L1003 AND L1010 HAVE BEEN PRECISELY ALIGNED AT FACTORY FOR MINIMUM SPURIOUS RADIATION, SO THAT IT IS NOT RECOMMENDED TO ADJUST THEM UNLESS PROPER TEST EQUIPMENT IS AVAILABLE.

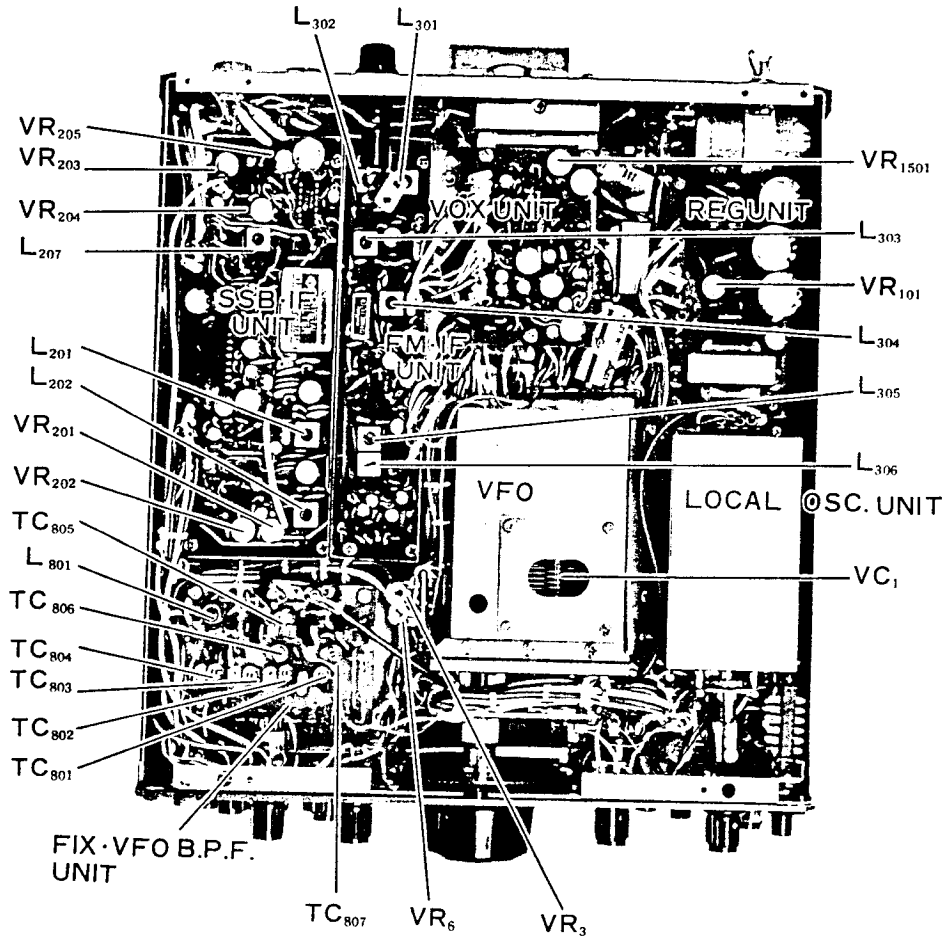

Figure 12 : BOTTOM VIEW OF EARLIER MODEL

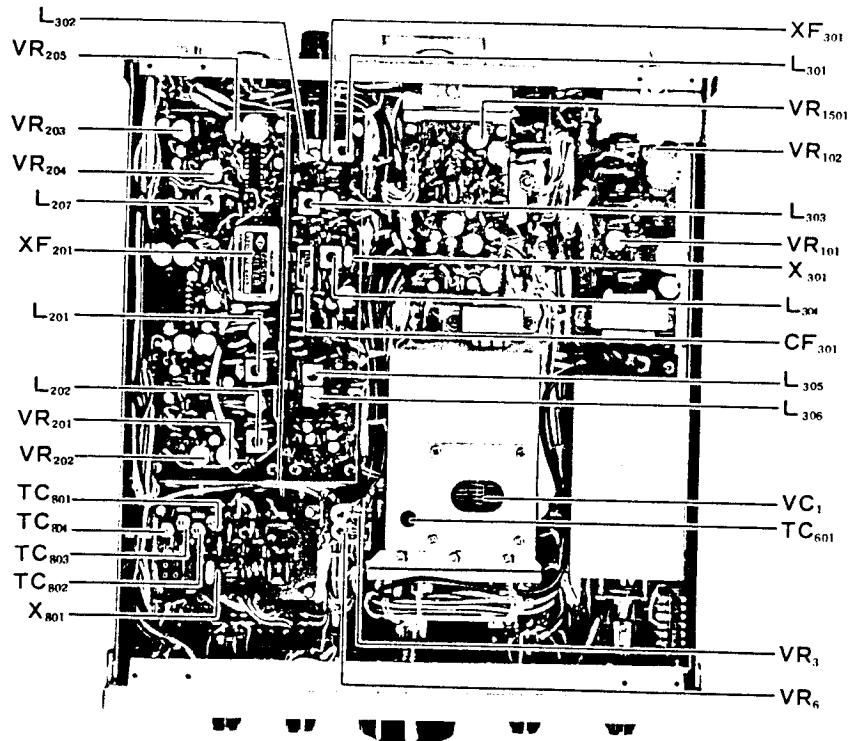

Figure 13 : BOTTOM VIEW OF LATER MODEL

° AFP (automatic final protection) (VR1102, VR1103)

Connect a VTVM (DC 1.5V range) to the junction point of C1146 and L1121. Adjust VR1102 for minimum VTVM reading when transmitting to the 50 ohm dummy load on FM mode. Set the VR1103 fully to counter-clockwise position. Disconnect the dummy load from the ANT receptacle and advance VR1103 clockwise until the relative power output meter indication falls to zero rapidly. Release the PTT switch for receive. Connect the dummy load and check the power output on transmit. If not, readjust VR1103.

NOTE : THIS ADJUSTMENT SHOULD BE DONE QUICKLY TO PROTECT THE FINAL TRANSISTOR FROM THE DAMAGE.

° Carrier Oscillator (L406, L407, TC401, TC402)

Set the mode switch to LSB position. Connect the RF probe of a VTVM to output terminal of L406. Adjust L406 for 0.7 volt VTVM reading. For USB, connect the VTVM to L407 and adjust it for 0.7 volt VTVM reading. Connect a frequency counter to the junction point of VR401 and C433. Adjust TC401 for 10701.5 kHz on LSB mode and TC402 for 10698.5 kHz on USB mode.

° Carrier Balance (VR405, VR406, TC403)

Connect a 50 ohm dummy load in parallel with the RF probe of a VTVM to the ANT receptacle. Set the mode switch to LSB. Set the MIC GAIN control, VR401, to fully counter-clockwise position. Press the PTT switch down. Adjust VR405 to minimum VTVM reading for LSB. Adjust VR406 to minimum VTVM reading for USB. Adjust TC403 to minimum VTVM reading on both LSB and USB modes. Do not forget to reset VR401 to its original setting after the carrier balance is obtained.

° FM Modulator Circuit (VR402, VR403, VR404, L404, L405)

NOTE : FOR THIS ALIGNMENT, SPECIAL TEST EQUIPMENT (FM LINEAR DETECTOR) IS REQUIRED.

Connect a dummy load and a linear detector to the ANT receptacle. Use a coupler for the linear detector connection. Connect an oscilloscope to audio output terminal of the linear detector. Set the mode switch to FM position. Set VR402 and VR404 to fully counterclockwise position and VR403 to the middle of its travel.

Connect a frequency counter to pin 8 of J402. Adjust L404 for 10.7 MHz counter reading on transmit. Disconnect the counter. Apply 1000 Hz 3 milli volt audio signal to pin 2 of the microphone jack, J3.

Adjust VR404 on transmit for maximum deviation on the linear detector and minimum distortion on the scope display. Increase the audio signal level to 20 milli volt. Adjust VR402 for required deviation. Peak L405 for maximum power output.

## RESISTANCE AND VOLTAGE MEASUREMENTS

The resistance and voltage measurements tabulated for the transistors or integrated circuits may be used to verify a suspected failure or improper level in the transceiver.

As there are always large tolerance in the solid state devices, it is not recommended to substitute them with other manufacturers. Your dealer may supply you with exactly what you need from their inventory.



## RESISTANCE CHART

NO.	E. S	B. G	C. D	NO.	E. S	B. G	C. D
Q 1	12	23	340	Q 501	140	G <sup>1</sup> 120K	G <sup>2</sup> 180K
Q 101	450	22	11	Q 502	160	45K	110K
Q 102	1.1K	1.1K	22	Q 601	2.1K	2.9K	2.9K
Q 103	22	.50	32	Q 602	140	290	520
				Q 603	350	600	320
Q 204	270	1K	2.8K	Q 701	680	450	500
Q 205	80	270	1.9K	Q 702	520	460	460
Q 206	20	140	2K	Q 801	1K	450	300
Q 207	20	140	2K	Q 802	220	1.2K	450
Q 208	260	390	170	Q 902	280	1K	100
Q 209	130	260	140	Q 903	300	260	100
Q 210	0	14	2.5K	Q 1001	2.1K	1.1K	410
Q 211	260	470	7K	Q 1002	1K	1.1K	410
Q 213	∞	4K	2.4K	Q 1003	200	1K	200
Q 214	∞	4K	2.4K	Q 1004	50	180	200
Q 215	0	12	∞	Q 1005	0	14	150
Q 301	950	1.4K	1.9K	Q 1101	0	14	85
Q 302	2.1K	1.9K	2.6K	Q 1102	0	11	60
Q 303	440	1.5K	2.5K	Q 1103	0	10	60
Q 304	180	1.5K	180	Q 1201	1K	2.2K	900
Q 306	440	1.1K	1.2K	Q 1202	0	800	∞
Q 307	1K	1.6K	3.4K	Q 1301	450	1K	300
Q 308	1K	1.5K	1.9K	Q 1302	160	310	230
Q 401	3K	1.1K	5K	Q 1303	450	400	310
Q 402	300	520	3K	Q 1304	600	1K	6.5K
Q 403	430	250	100	Q 1305	11K	10K	2.8K
Q 404	1K	1.6K	5.6K	Q 1306	500	400	310
Q 405	1K	1.5K	3.9K	Q 1401	1.8K	3K	1.8K
Q 406	800	1.3K	3.2K	Q 1402	1.1K	0	1.2K
Q 407	∞	1.6K	450	Q 1501	2.6K	8.5K	2.7K
Q 408	∞	1.8K	1.5K	Q 1503	0	100	∞
Q 409	∞	1.9K	5.5K	Q 1504	500	1.3K	100
Q 410	∞	1.9K	550	Q 1505	∞	2.5K	2.7K

NO.	1	2	3	4	5	6	7	8	9	10	11	12	13	14
Q 202	∞	400	1.4	520	210	100	5K	∞						
Q 203	∞	360	0	400	220	100	1.7K	∞						
Q 212	50	0	30	2.3K	130	0	2K	70K	11					
Q 216	800	630	55M	5.4K	1K	40	0	40K	510	1K	1K	900	510	640
Q 305	1.25K	240	230K	0	230K	1.6K	1.8K							
Q 901	1.5	∞	∞	1.5K	2.4K	1K	1.8K	1.8K	1K	0				
Q 1203	∞	0	0	∞	1K	0	0	∞	∞	0	∞	∞	∞	∞
Q 1502	240	110	3K	120	0	450	300	450	1.2K	1.4K	450	450		

Notes: (1) Measured with VTVM.  
 (2) Values are in OHMS.  
 (3) E: emitter, B: base, C: collector, S: source, G: gate, D: drain

# VOLTAGE CHART

NO.	E. S		B. G		C. D		NO.	E. S		B. G		C. D	
	R	T	R	T	R	T		R	T	R	T	R	T
Q 1	13.8	13.5	14.5	14.2	23	20	Q 501	3.2	0	G1 G2 2.5 4.5	G1 G2 0 0	13.5	0
Q 101	9	9.	9.5	9.5	13.8	13.5	Q 502	0.32	0	0 0	0 0	13.8	0
Q 102	6	6.	6.5	6.5	9.5	9.5	Q 601	2.4	2.4	3	3	4.7	4.7
Q 103	14.5	14.3	15	15	23	20	Q 602	1.2	1.2	1.8	1.8	8.0	8.0
							Q 603	1.2	1.2	0	0	8.5	8.5
Q 204	0.5	0.5	0.9	0.9	9.5	9.5	Q 701	2.0	2.0	2.6	2.6	8.5	8.5
Q 205	0	0.	0.5	0.5	9.5	9.5	Q 702	0.5	0.5	1.1	1.1	8.6	8.6
Q 206	0.14	0.14	4.6	4.6	9	9	Q 801	2.1	2.1	1.6	1.6	8.0	8.0
Q 207	0.33	0.13	0.8	0.8	0.18	0.18	Q 802	1.5	1.5	2.2	2.2	8.0	8.0
Q 208	0	1.6	0	0	0	13.5	Q 902	1.13	1.06	1.8	1.75	13.8	13.2
Q 209	0	1.15	0	0	0	13.2	Q 903	1.58	1.5	2.3	2.2	4.5	4.3
Q 210	0	0	0.18	0.18	0.8	0.8	Q 1001	0	0.4	0	0.86	0	13.4
Q 211	0.18	0.18	0.8	0.8	4.5	4.5	Q 1002	0	0.56	0	1.16	0	13.4
Q 213	0	7	0	7.2	0	8.6	Q 1003	0	1.55	0	2.3	0	12.8
Q 214	0	7	0	7.2	0	8.6	Q 1004	0	0.4	0	1.12	0	12.8
Q 215	6	0	0.1	0.1	7	7	Q 1005	0	0	0	0.58	0	11.6
Q 301	0.42	0	1.03	0	9.5	0	Q 1101	0	0	0	0.55	0	13.4
Q 302	1.2	0	1.7	0	9	0	Q 1102	0	0	0	0.25	0	13.4
Q 303	0.75	0	1.36	8	2.5	0	Q 1103	0	0	0	0.6	0	13
Q 304	1.33	0	2	0	10	0	Q 1201	2.5	0	3.0	0	10.0	0
Q 306	0.11	0	1.35	0	8.9	0	Q 1202	0	0	0.15	0	2.8	0
Q 307	1.11	0	1.7	0	7.5	0	Q 1301	0.22	0	0.91	0	13	0
Q 308	1.05	0	1.7	0	9	0	Q 1302	1.6	0	0	0	13	0
Q 401	0.25	0.22	0.85	0.84	7.3	7.2	Q 1303	1.5	0	2.1	0	12.5	0
Q 402	0.57	0.55	1.22	1.20	6	5.8	Q 1304	1.8	0	0	0	5.8	0
Q 403	6	5.8	6.7	6.5	12.6	12.2	Q 1305	5.8	0	5.9	0	6.4	0
Q 404	1.25	1.2	1.9	1.85	3.6	3.55	Q 1306	1.55	0	2.2	0	12.7	10
Q 405	1.6	1.55	2.2	2.15	5.7	5.6	Q 1401	2	0	0	0	8	0
Q 406	1.7	1.62	2.3	2.25	6.5	6.4	Q 1402	1.5	0	0	0	7.5	0
Q 407	2.45	2.4	2.75	2.7	9	9	Q 1501	1.6	1.6	0	0	13.0	0.75
Q 408	2.4	0.35	0.56	0.52	9	8.5	Q 1503	0	0	0.52	0.52	13.2	5.0
Q 409	1.8	1.8	1.9	1.9	9	9	Q 1504	0.39	0.39	0	0	0.52	0.52
Q 410	2.4	2.4	1.7	1.7	8.7	8.7	Q 1505	0.75	0.75	1.1	1.1	9	9

		1	2	3	4	5	6	7	8	9	10	11	12	13	14
Q 202	R	11.07	0	0.15	0.32	8.9	12.8	4.2	1.07						
	T	0	0	0	0	0	0	3.6	0						
Q 203	R	0.42	3.2	0	2.5	8.2	12.8	4.2	0.42						
	T	0	0	0	0	0	0	3.6	0						
Q 212	R	5.8	0	7	10.5	5.6	0	0	12	13.5					
	T	5.8	0	7	10.5	5.6	0	0	12	13.5					
Q 216	R	0.65	4.6	3.4	0	0	0.05	0	0.05	4.6	2.7	2.7	0.7	4.6	4.6
	T	2.3	4.4	0	0	0	0.05	0	0.05	4.3	2.6	2.6	0.65	4.4	4.4
Q 305	R	1.78	1.8	9.5	0	7.6	1.78	1.78							
	T	0	0	0	0	0	0	0							
Q 901	R	4	3.5	3.3	4	1.28	13.2	8	8	13.2	0				
	T	3.9	3.4	3.2	3.9	1.26	13.0	7.7	7.7	13	0				
Q 1203	R	2.8	0	0	0	5.0	0	0	1.4	1.4	0.85	2.0	0	0	0.85
	T	0	0	0	0	0	0	0	0	0	0	10.4	0	0	0
Q 1502	R	0.8	0.16	3.6	0.4	0	0.92	1.52	3.7	0.86	7.8	10.4	10.4		
	T	0.8	0.16	3.6	0.4	0	0.92	1.52	3.7	0.86	7.8	0	10.4		

- Notes: (1) Measured with VIVM.  
 (2) Values are in VOLTS.  
 (3) R: receive, T: transmit, E: emitter, B: base, C: collector, S: source, G: gate, D: drain  
 (4) Q801 and Q802 are measured at FIX ON position.  
 (5) Q1201 and Q1202 are measured at MARKER ON position.  
 (6) Q1301 - 1306 are measured at NB OFF position.  
 (7) Q1401 and Q1402 are measured at FM Center Meter ON position.  
 (8) Q213 - 215 are measured at RPT ON position.

Notes: (1) Q202 and Q203 are measured at Mode Switch SSB position.

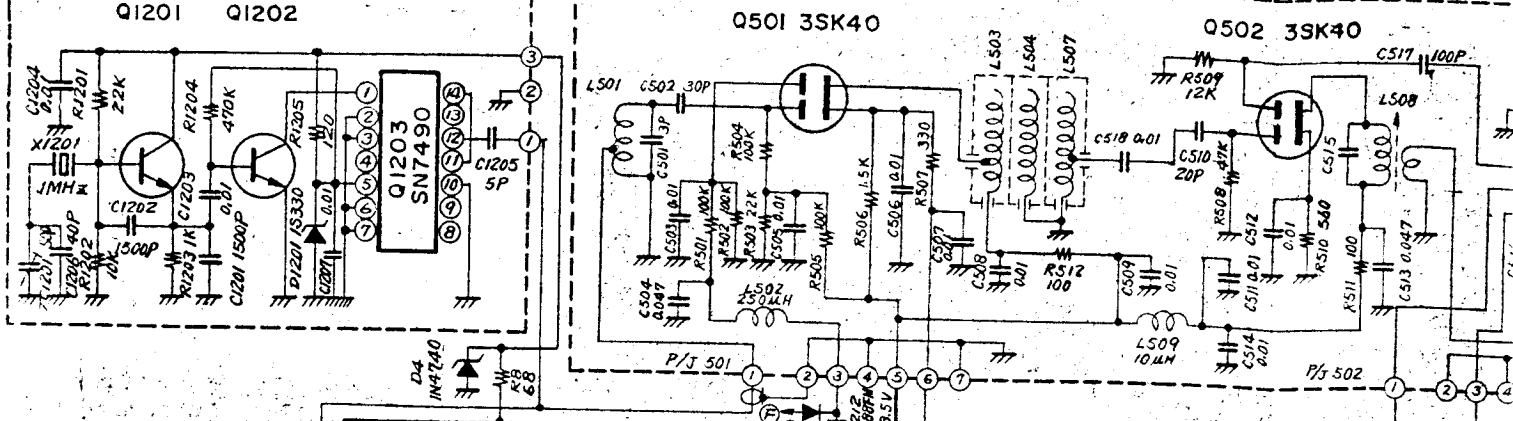

R8, D2-D4 = PB-1393  
 PL3, PL4 = PB-1360  
 VR3, VR6 = PB-1362

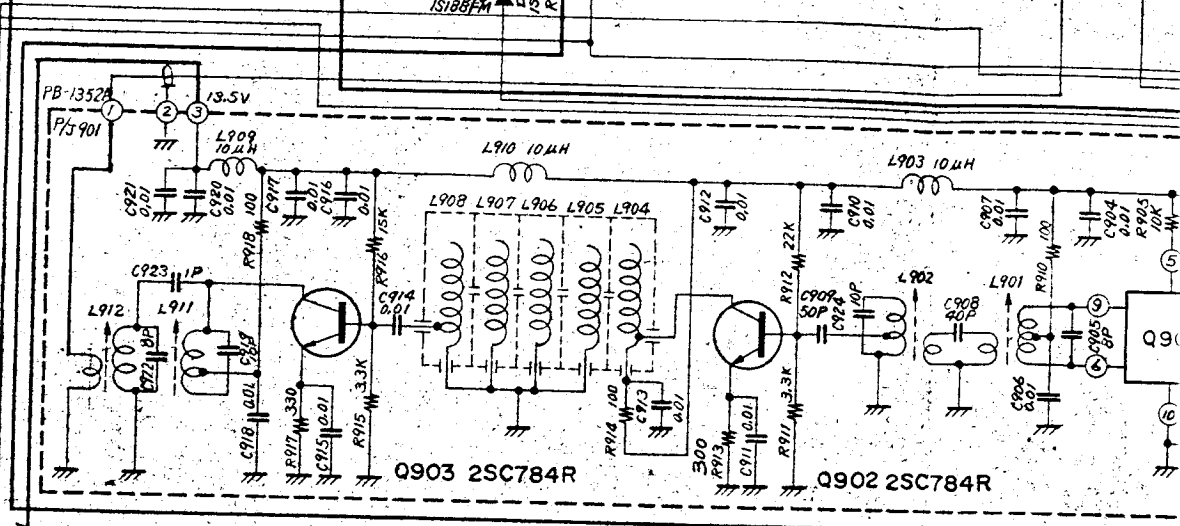

For Service Manuals Contact  
**MAURITRON TECHNICAL SERVICES**  
 8 Cherry Tree Rd, Chinnor  
 Oxon OX9 4QY  
 Tel: 01844-351694 Fax: 01844-352564  
 Email: enquiries@maurtron.co.uk

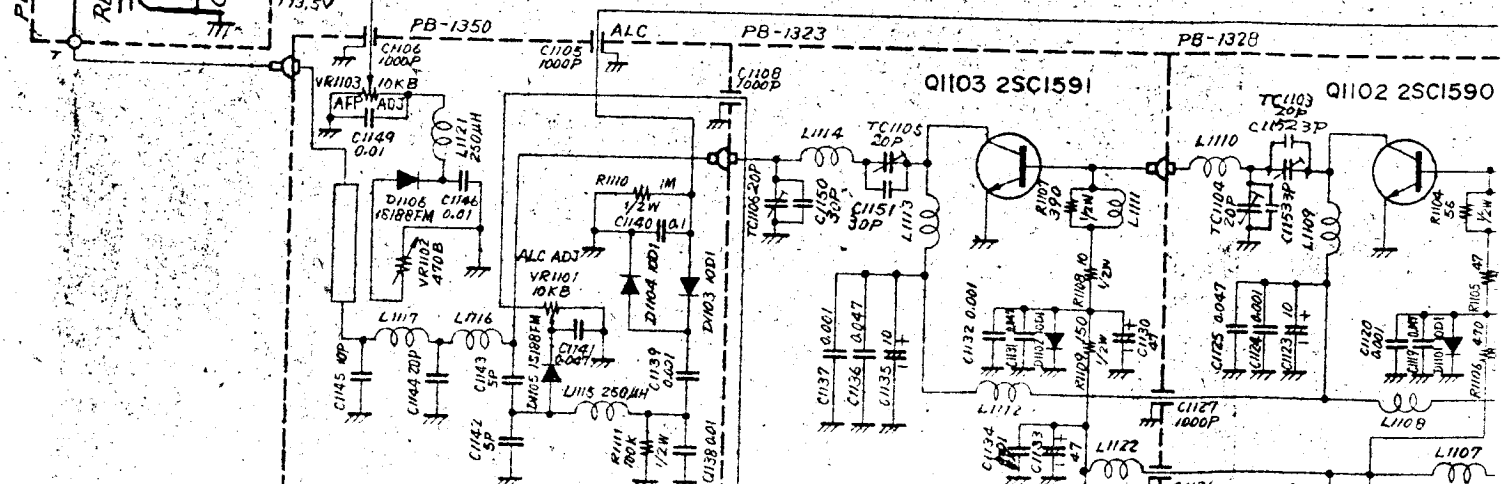
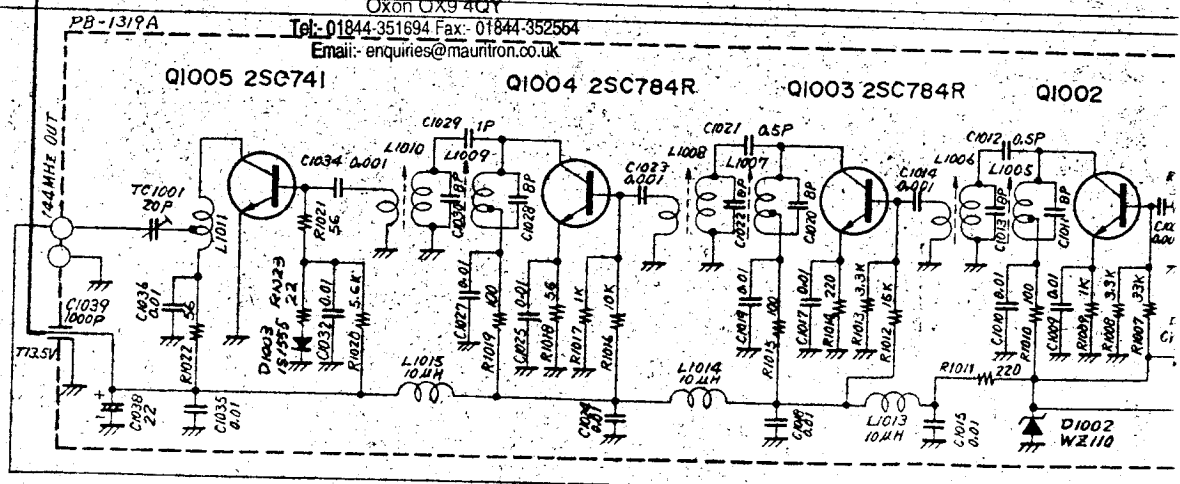
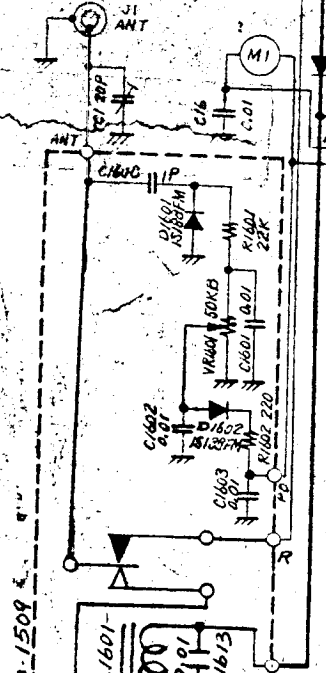

Q501 3SK40

Q502 3SK40

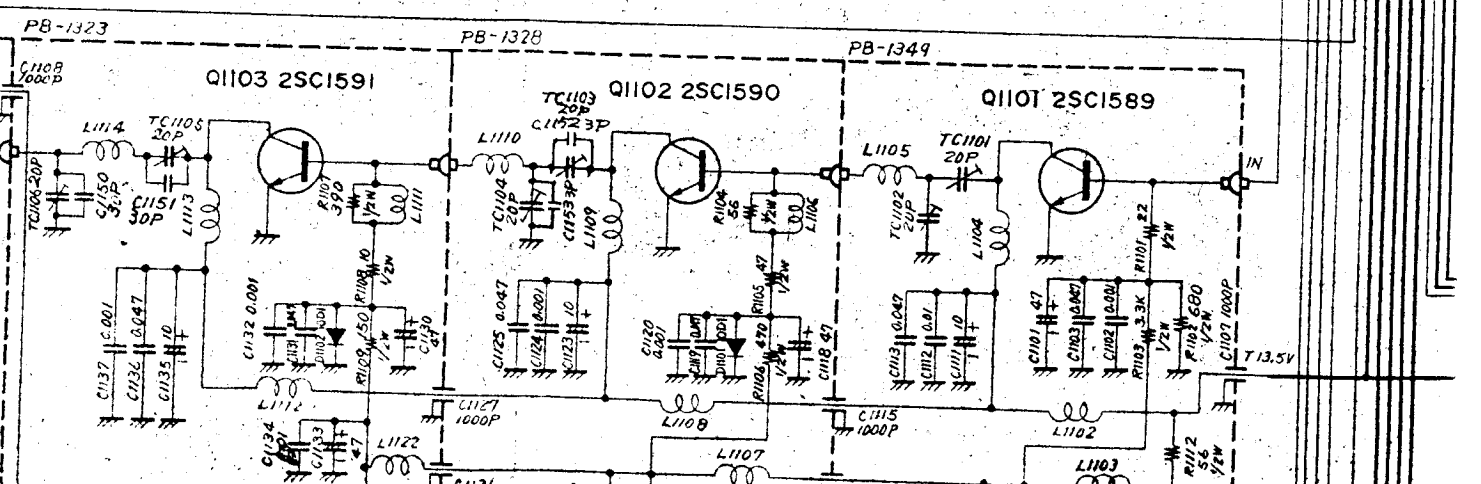
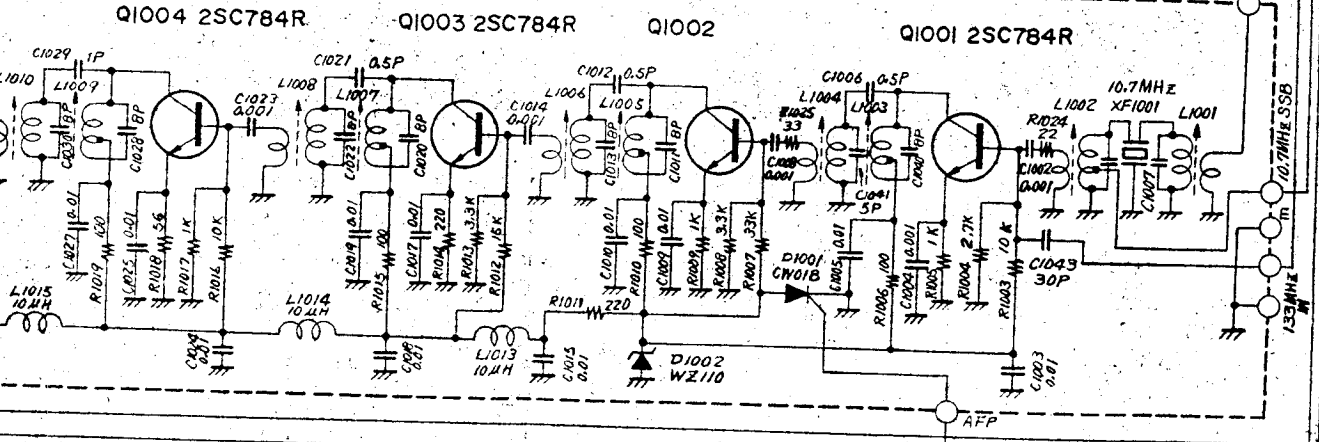
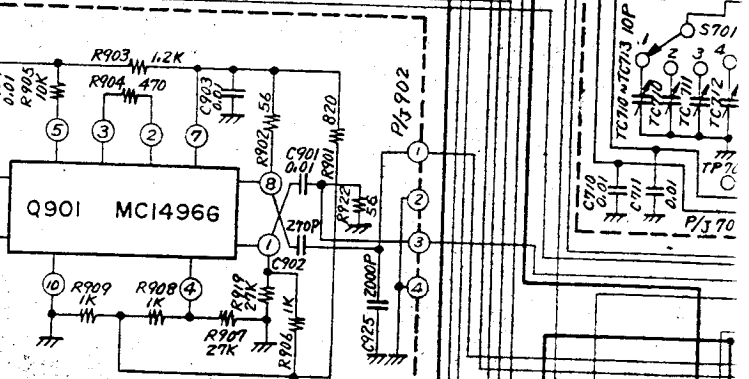
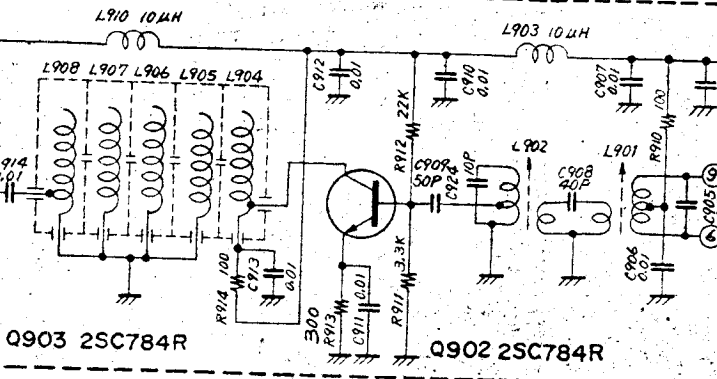
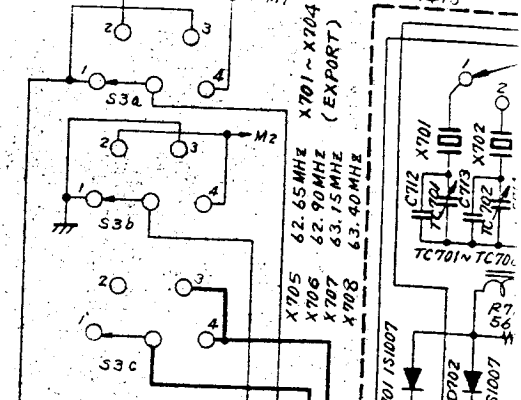
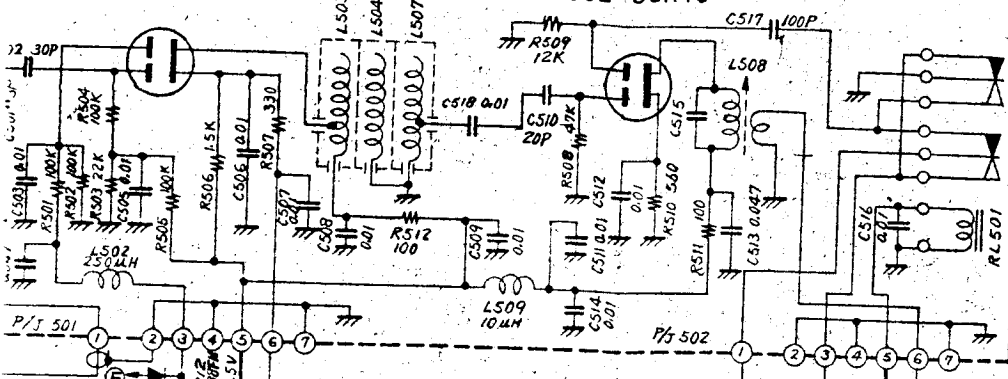

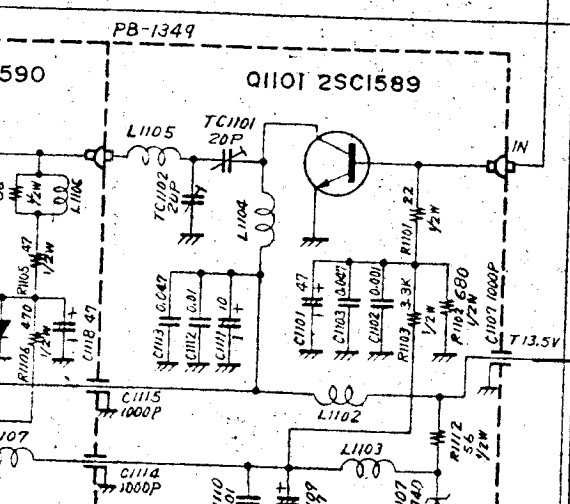
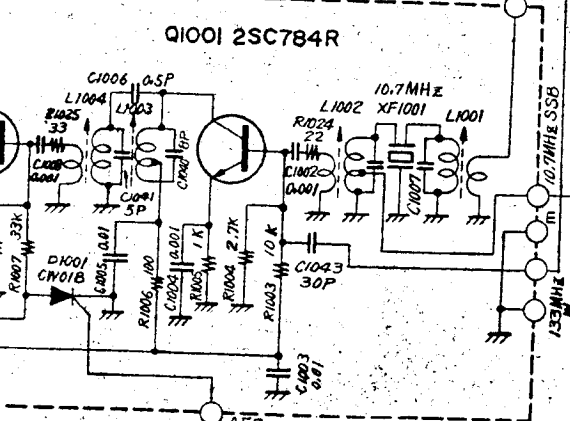
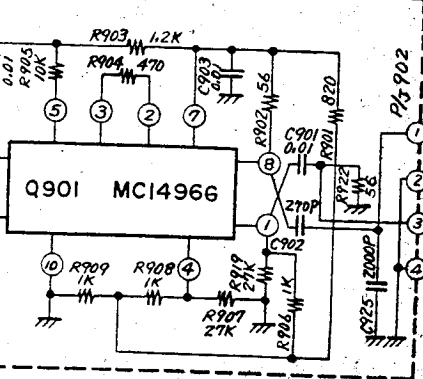
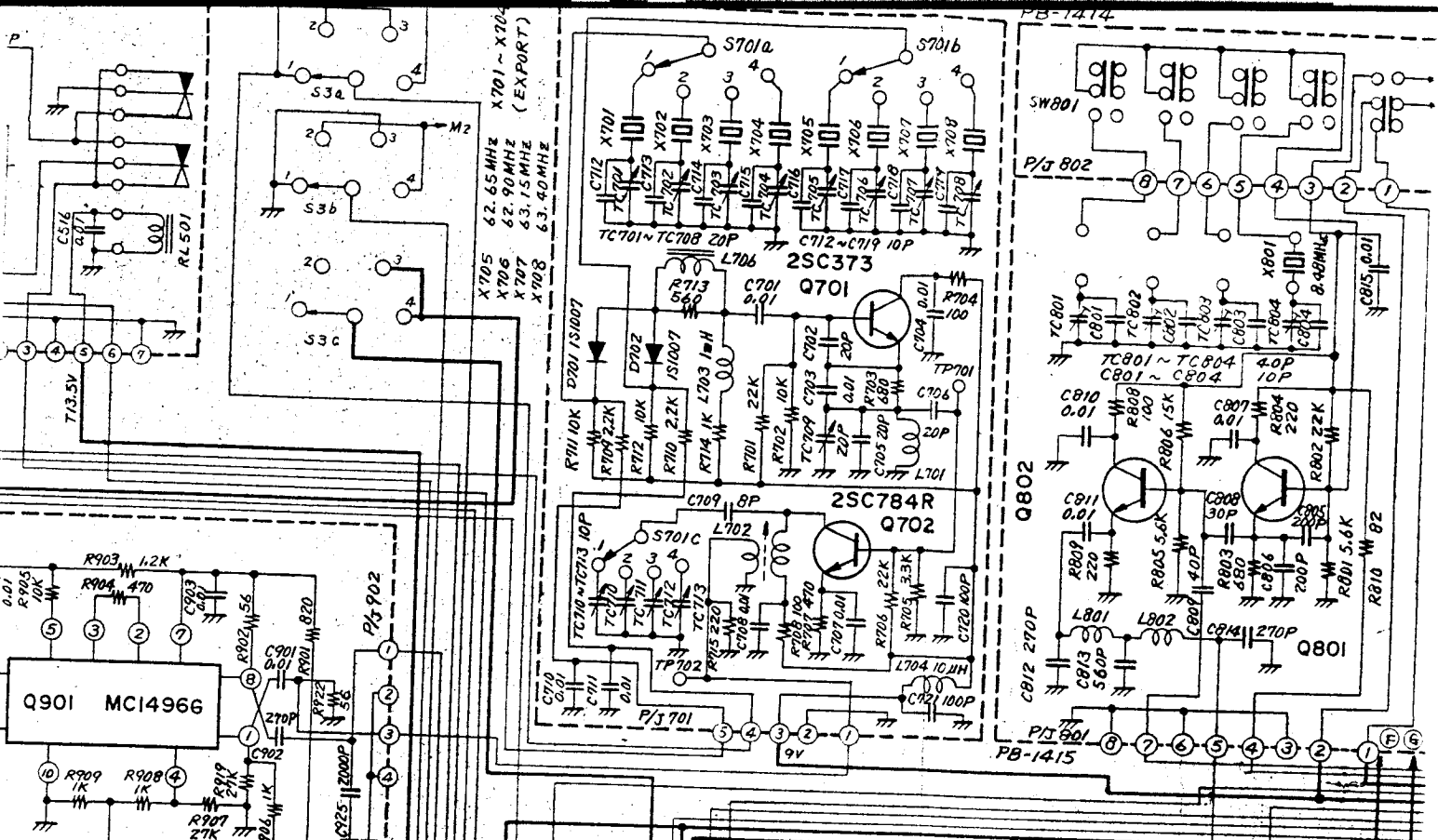

For Service Manuals Contact  
**MAURITON TECHNICAL SERVICES**  
8 Cherry Tree Rd, Chinner  
Oxon OX9 4QY  
Tel: 01844 351094 Fax: 01844 352654  
Email: enquiries@mauriton.co.uk

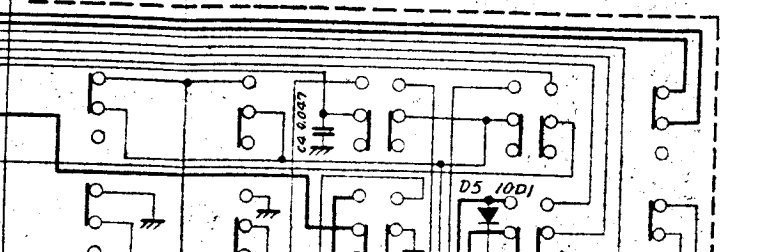
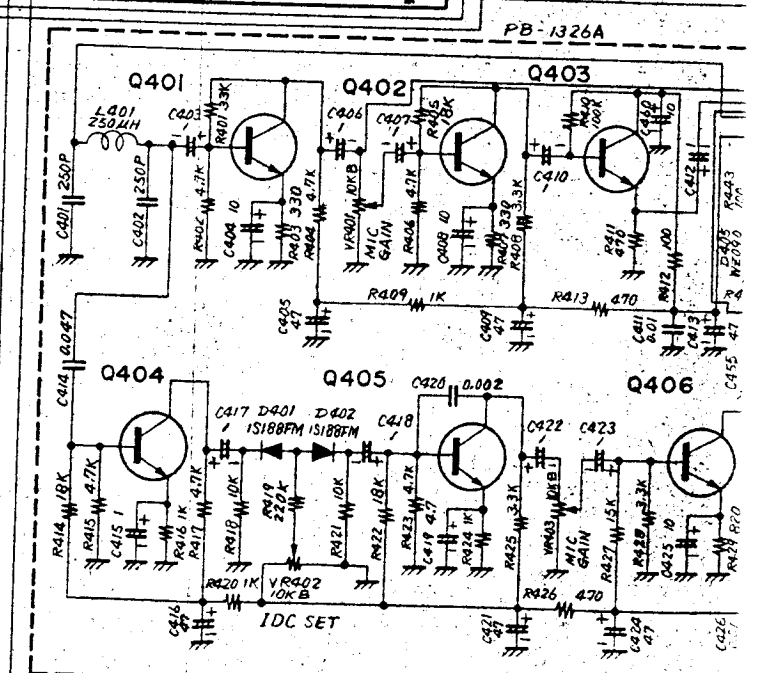

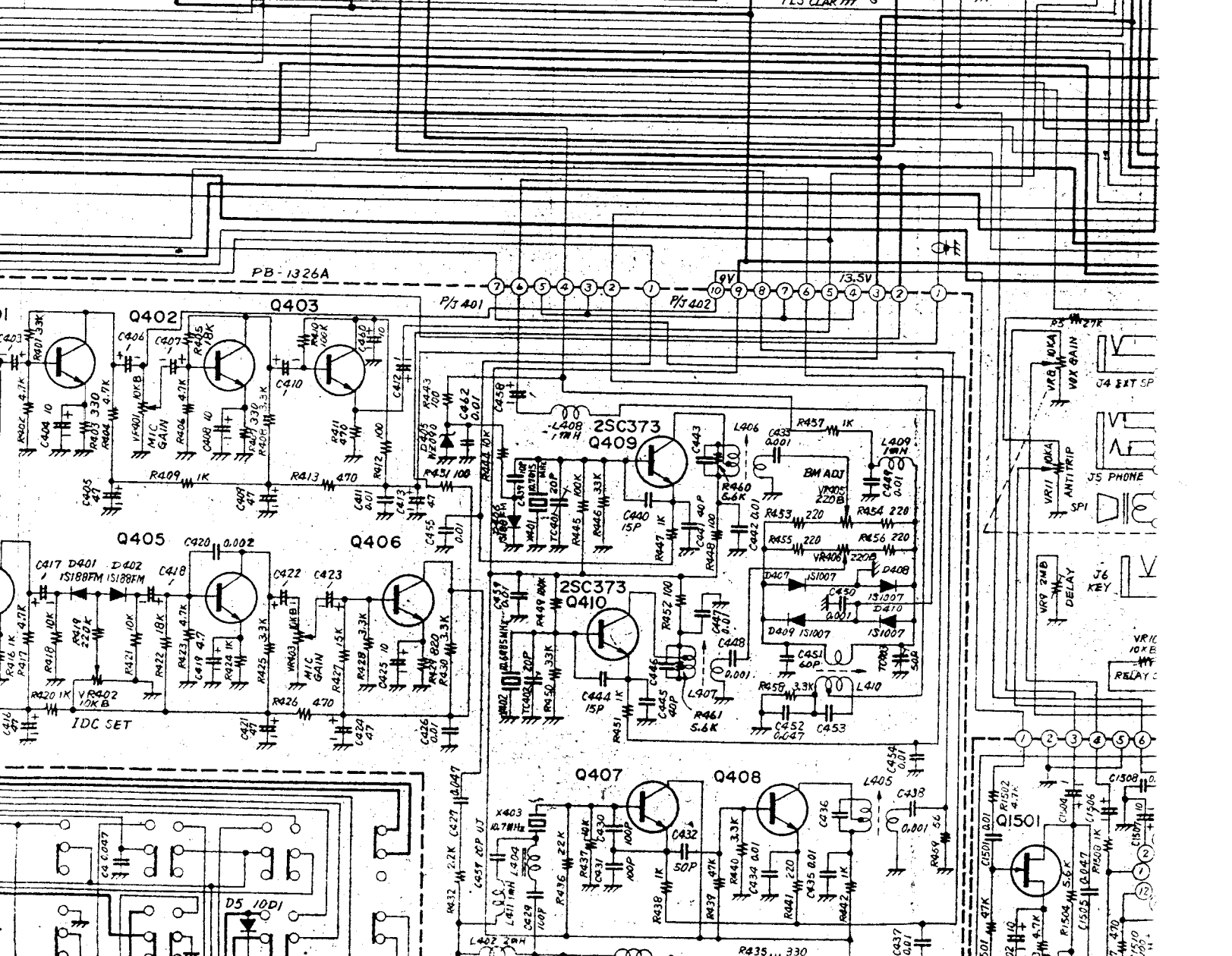
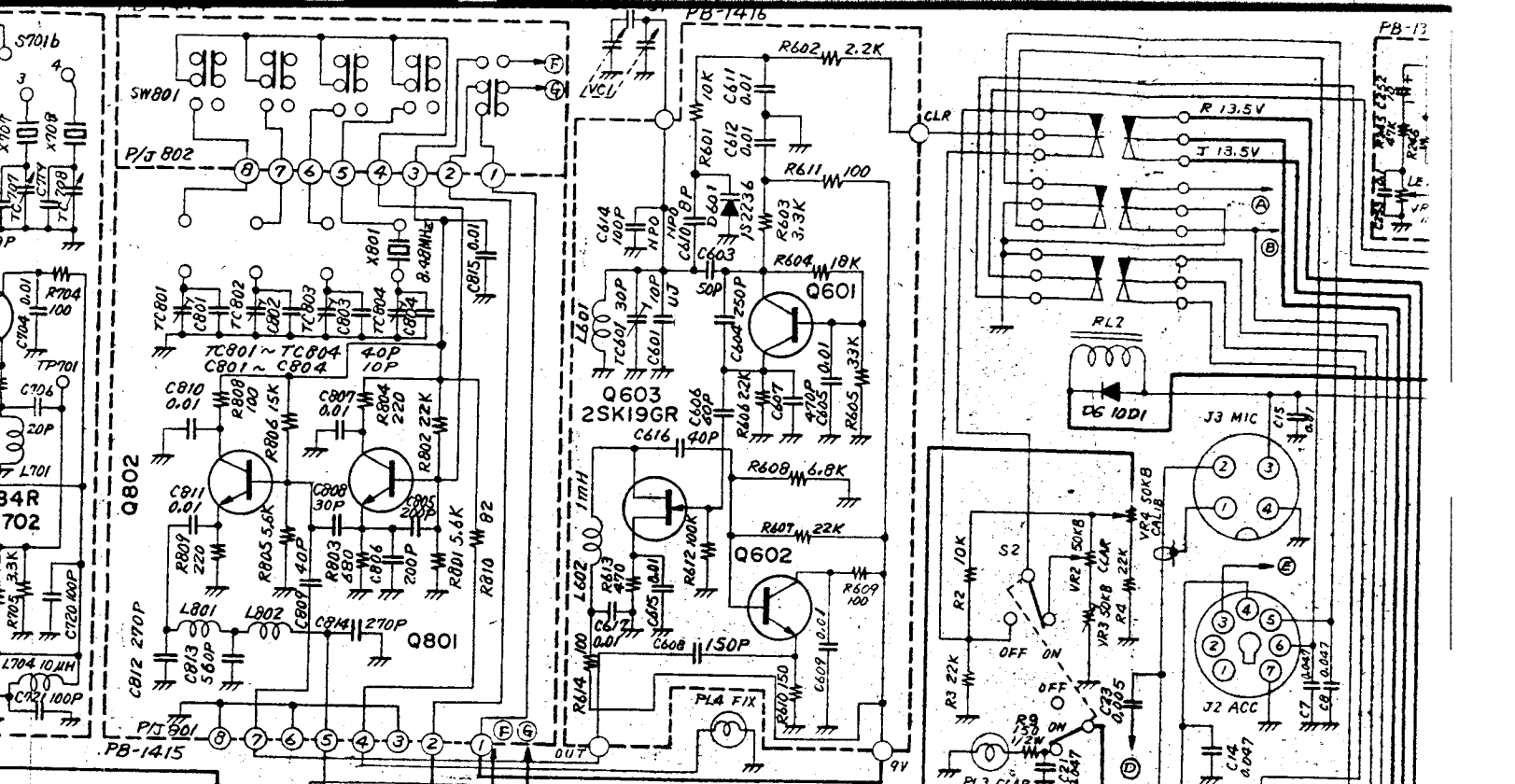



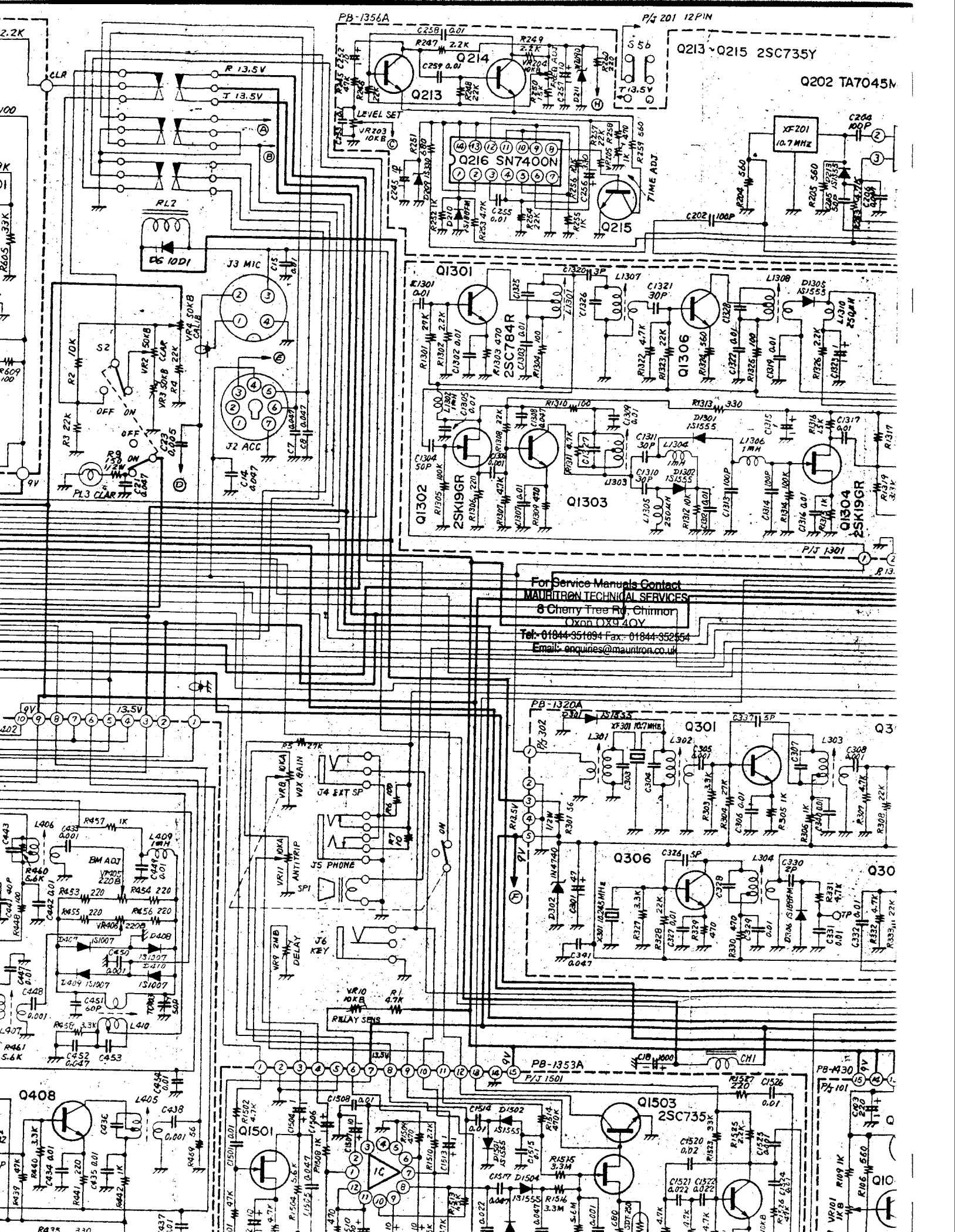

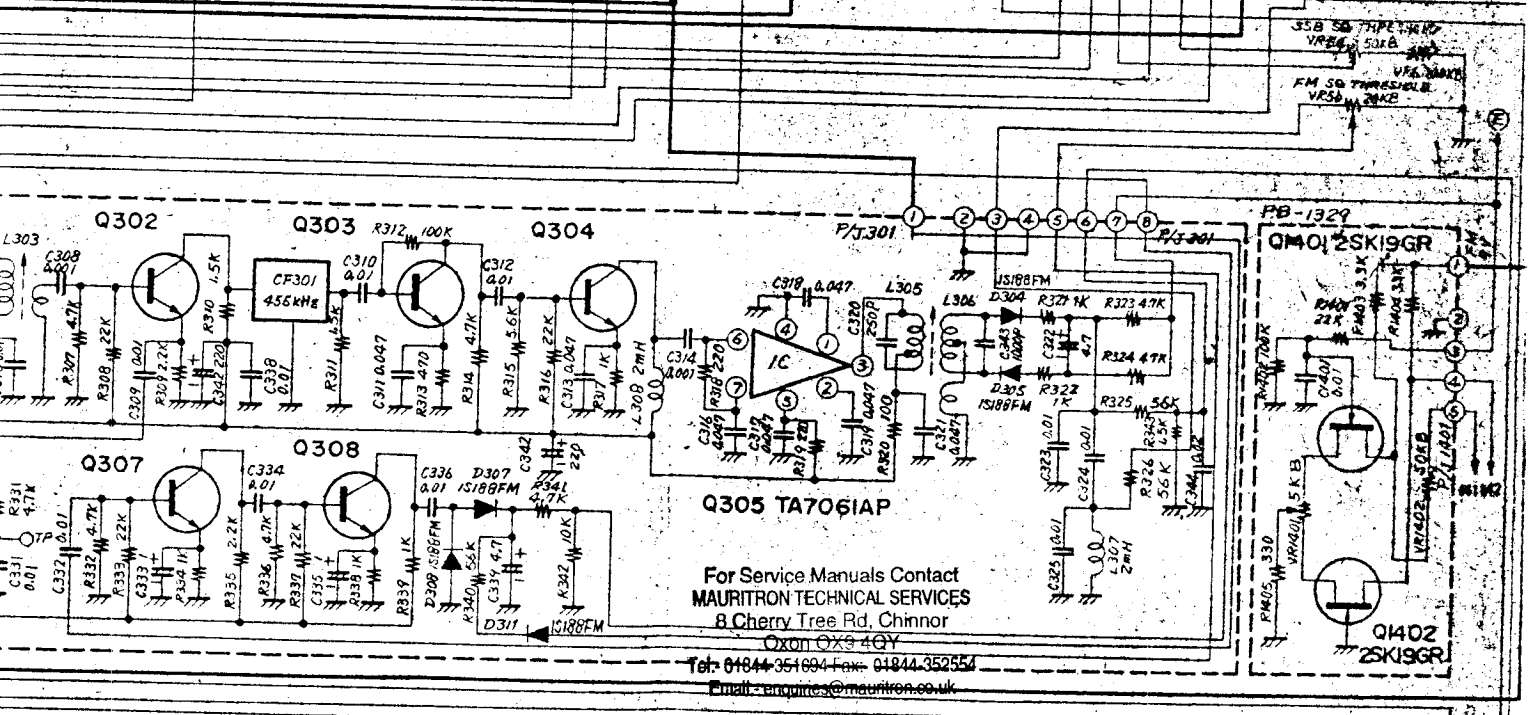
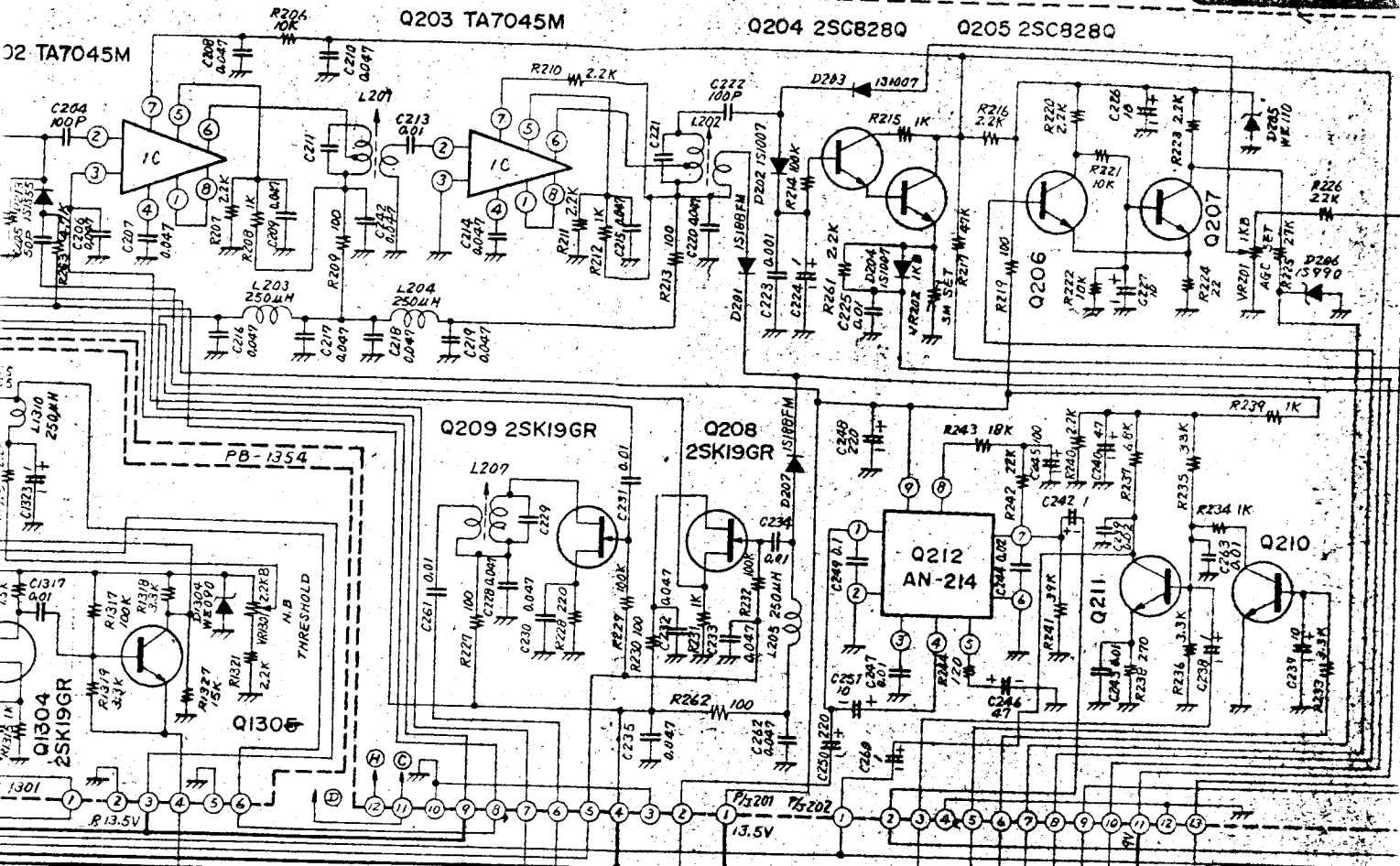

For Service Manuals Contact  
**MAURITRON TECHNICAL SERVICES**  
 8 Cherry Tree Rd, Chinnor  
 Oxon OX9 4QY  
 Tel: 01844 351894 Fax: 01844 352554  
 Email: enquiries@mauritron.co.uk

