

FT-2400H

TECHNICAL SUPPLEMENT



*2-m, 50-Watt Mobile
Paging Transceiver*

YAESU MUSEN CO., LTD.

C.P.O. BOX 1500, TOKYO, JAPAN

YAESU U.S.A.

17210 Edwards Rd., Cerritos, California 90701, U.S.A.

YAESU EUROPE B.V.

Snipweg 3, 1118AA Schiphol, The Netherlands

CONTENTS

GENERAL INFORMATION	1-1
SPECIFICATIONS	1-2
CIRCUIT DESCRIPTION	2-1
PACKING	3-1
MAIN-ASSY PARTS LIST	3-2
EXPLODED VIEW	3-4
ALIGNMENT	4-1
BLOCK DIAGRAM	4-5
VCO UNIT	4-6
PARTS LIST	4-6
PARTS LAYOUT & CIRCUIT DIAGRAM	4-8
MAIN UNIT	4-9
PARTS LIST	4-9
PARTS LAYOUT	4-17
CIRCUIT DIAGRAM	4-19
MIC UNIT	4-20
PARTS LIST	4-20
PARTS LAYOUT & CIRCUIT DIAGRAM	4-22
CONTROL UNIT	4-23
PARTS LIST	4-23
PARTS LAYOUT	4-27
CIRCUIT DIAGRAM	4-29
INTERFACE UNIT	4-30
PARTS LIST	4-30
PARTS LAYOUT	4-34
CIRCUIT DIAGRAM	4-35
INSTALLATION OF OPTIONS (FRC-6)	5-1
PARTS LIST	5-3
PARTS LAYOUT & CIRCUIT DIAGRAM	5-5
INSTALLATION OF OPTIONS (FTS-17A)	5-6
PARTS LIST	5-8
PARTS LAYOUT & CIRCUIT DIAGRAM	5-10

Cut out the label at the right and place it behind the clear plastic window in the spine of the manual binder.



FT-2400H
Technical Supplement

GENERAL INFORMATION



The FT-2400H is a special version of Yaesu's top-of-the-line professional grade commercial land mobile transceivers, intended for 2-meter FM operation in the amateur radio service.

With its compartmentalized one-piece die-cast chassis, the FT-2400H provides 3-step user-selectable power output up to 50 watts easily without forced cooling. Backlighting for the large LCD (display), knobs and major buttons is automatically controlled by a photosensor, and the less-used buttons have a flip-down protective cover.

The thirty-one freely tunable memories can each be programmed with a 4-character channel name, which can then be displayed in place of frequency, as desired. Each memory offers complete programmability and scanning functions, such as independent tx/rx frequencies, independent repeater offset and CTCSS tone, programmable scan limits, selectable scan resume modes and memory skip, priority monitoring and a 1-touch instant-recall CALL channel. Channel steps are user-selectable from 5 to 50 kHz, and Automatic Repeater Shift can set standard repeater shifts when you tune

to a repeater subband. A 1750-Hz tone generator is included in European versions.

A 38-tone programmable CTCSS encoder is built-in as standard, and the FTS-17A CTCSS decoder unit can be installed to provide tone squelched private channels and a CTCSS paging bell feature to sound a paging alert tone when the tone squelch opens.

Revolutionary DTMF (Dual-Tone, Multi-Frequency) -based selective calling and private paging capabilities can be easily added with the optional FRC-6, controlled entirely from the front panel. You can select any of 999 3-digit ID codes for your transceiver, and then have your receiver stay quiet until your code is received (from any standard DTMF-equipped transceiver). When a call is received, the FT-2400H displays the caller's code, and a paging beeper can be set to sound and even to respond to the call automatically. Seven DTMF code memories store your ID plus those of six other frequently-called stations or groups you wish to monitor.

SPECIFICATIONS

General

Frequency Range: 144 ~ 146 or 148 MHz, or
140 ~ 150 MHz Tx, 140 ~ 174 MHz Rx
Channel Steps: 5, 10, 12.5, 15, 20, 25 & 50 kHz
Frequency Stability: < 10 ppm (-20 to +60 °C)
Mode of Emission: F3
Antenna Impedance: 50 ohms, unbalanced
Supply voltage: 13.8V DC \pm 10%, negative
ground
Current Consumption (typical):
Rx: 400 mA, Tx hi/med/low: 12/9/5A
Operating Temperature Range: -20 to +60 °C
Case Size (WHD):
160 \times 50 \times 180 mm (w/o knobs)
Weight: 1.5 kg (3.3 lb)

Transmitter

Output Power (high/med/low): 50/25/5W
Modulation Type: Variable Reactance
Maximum Deviation: \pm 5 kHz
Spurious Radiation: less than -60 dB
Microphone Impedance: 2k Ω

Receiver

Circuit Type:
Double Conversion Superheterodyne
IFs: 21.4 MHz & 455 kHz
Sensitivity (for 12dB SINAD):
better than 0.2 μ V
Selectivity (-6/-60 dB): 12/30 kHz
IF Rejection: better than 70 dB
Image Rejection: better than 70 dB
Maximum AF Output:
2W into 8 ohms @10% THD

Specifications subject to change without notice or obligation.

CIRCUIT DESCRIPTION

Receive Signal Path

Incoming RF from the antenna jack is delivered to the Main Unit and passed through a lowpass filter and a $\frac{1}{4}$ -wave antenna switching network consisting of coils L1003 & L1004, capacitors C1003 & C1004, and diodes D1001 & D1002. Signals within the frequency range of the transceiver are then passed through a varactor-tuned bandpass filter consisting of T1001/T1002 before RF amplification by Q1001 (3SK131). The amplified RF is then bandpass filtered again by varactor-tuned resonators T1003/T1004, to ensure pure in-band input to 1st mixer Q1002/Q1003 (2SK302 x 2).

Buffered output from the VCO Unit is amplified by Q1005 (2SC2759) and lowpass filtered by L1009 and C1042/C1043, to provide a pure 1st local signal between 118.6 and 152.6 MHz to the 1st mixer. The 21.4-MHz 1st mixer product is passed through dual monolithic crystal filter XF1001 (± 7.5 kHz BW) to strip away all but the desired signal, which is then amplified by Q1004 (2SC2714).

The amplified 1st IF signal is applied to FM IF subsystem IC Q1008 (MC3372M), which contains the 2nd mixer, 2nd local oscillator, limiter amplifier, noise amplifier, S-meter amplifier and squelch gates. A 2nd local signal is generated from 21.855 MHz crystal X1001, which produces the 455 kHz 2nd IF when mixed with the 1st IF signal within Q1008. The 2nd IF is passed through ceramic filter CF1001 to strip away unwanted mixer products, and then applied to the limiter amp in Q1008, which removes amplitude variations in the 455 kHz IF before detection of the speech by ceramic discriminator CD1001.

Detected audio is delivered from Q1008 to the Interface Unit, where it passes through audio muting analog switch Q3005 (TC4S66F) before de-emphasis, high-pass and low-pass filtering by Q3006 (NJM2902M- $\frac{1}{4}$, - $\frac{2}{4}$ & - $\frac{1}{4}$). Another audio muting gate, Q3012 (DTC114TK), passes the signal, which is then combined with beeper audio originating from the microprocessor through Beeper volume trimmer VR3002 and lowpass filter Q3006 (NJM2902M- $\frac{3}{4}$). The level of the combined receiver and beeper audio on the Interface Unit is set by VOL potentiometer VR2002 on the Control Unit (via J3003 pin 3) and is then returned the Main Unit for amplification by Q1023 (TDA2003) up to 2 watts for the optional headphone jack or 8-ohm loudspeaker.

Squelch Control

The squelch circuit consists of noise amplifier Q1007 (2SC2712GR) and a high-pass filter and squelch trigger within Q1008 on the Main Unit, and control circuitry within microprocessor Q2001 (HD404719-A11H) on the Control Unit.

When no carrier is received, noise at the output of the detector stage in Q1008 is amplified by Q1007 and highpass filtered by the noise amp section of Q1008, and then rectified by D1012 to provide a DC control voltage for the squelch switching section within Q1008. With no carrier, pin 14 of Q1008 is high. This signal is inverted by Q1006 (1MH5) and delivered to BUSY pin 16 of main microprocessor Q2001 on the Control Unit as the Scan Stop signal, which causes the **BUSY** indication on the display when the squelch is open. This signal also causes the microprocessor to cut receiver audio in two places on the Interface Unit mentioned already: opening audio mute gate Q3005 (via switch Q3004, DTC114EK), and pulling the audio line to ground just before the audio amplifier at Q3012, thus silencing the receiver while no signal is being received, and during transmission.

When a carrier appears at the discriminator, noise is removed from the output, causing pin 14 of Q1008 to go low. This signals the microprocessor to activate the **BUSY** indicator through LCD driver Q2002 (LC7582). The microprocessor then checks for CTCSS tone detection from the F1S-1/A Tone Squelch Unit (if installed), and for Digital Code Squelch information (if the FRC-6 DCS Unit is installed). If not transmitting and tone squelch is not activated, or if the received tone matches that programmed, the microprocessor switches Q3004/-Q3005 and Q3012 to allow audio to pass to the amplifier and loudspeaker.

Center-Stop Scanning

To ensure that scanning stops at the center of a detected signal, discriminator output from pin 9 of Q1008 is also delivered to comparator circuit Q3008 (LA6324M- $\frac{2}{4}$ & - $\frac{3}{4}$) on the Interface Unit, which compares the discriminator output to a preset DC level. The output of the comparator connects to the Scan Stop line, preventing the received signal from signalling the microprocessor to stop scanning until the signal has been tuned to its peak level, preset by Center-Stop trimmer VR3004.

CIRCUIT DESCRIPTION

Transmit Signal Path

Speech input from the microphone is delivered via the Mic (Jack) Unit and the Control Unit to the Interface Unit, where it passed through Mic Mute analog switch Q3009 (TC4S66F) for amplification and pre-emphasis by Q3007 (LA6324M- $\frac{1}{4}$). To prevent over-deviation, the audio is processed by IDC (instantaneous deviation control) stage Q3007- $\frac{1}{4}$, and then lowpass filtered by Q3008 (LA6324M- $\frac{1}{4}$ & - $\frac{1}{4}$) before delivery to the modulator on the VCO Unit. Q3007- $\frac{3}{4}$ provides a low impedance reference for the lowpass filter input and some of the other opamps.

If a CTCSS tone is enabled for transmission, the subaudible tone from microprocessor Q2001 on the Control Unit is lowpass filtered by Q3007- $\frac{3}{4}$ and mixed with the IDC-processed speech audio. Also, DTMF tones generated by the FRC-6 option (connected to the PRG Unit jack), or directly from the microprocessor, are applied to the transmit audio chain at the input of the IDC stage. The microprocessor also disables microphone at Mic Mute switch Q3009 via Q3010 (DTC114EK) when necessary.

The modulating audio is delivered to diode D305 (HVU202) on the VCO Unit, frequency modulating the PLL carrier up to ± 5 kHz from the unmodulated carrier at the transmitting frequency. The modulated signal from transmitter VCO Q303 (MMBR951L) is buffered by Q305 (2SC2759) and delivered to the Main Unit for amplification by Q1C12 (2SC2759), Q1011 (MMBR951L) and Q1010 (2SC2538). The low level transmit signal is then finally amplified by PA module Q1009 (S-AV24) up to 50 watts. Harmonic spurious radiation in the final output is suppressed by a 3-pole lowpass filter on the Main Unit, and the transmit signal then passes through $\frac{1}{4}$ -wave antenna switch D1016 before delivery to the antenna.

Automatic Transmit Power Control

RF power output from the final amplifier is sampled by C1064 and rectified by D1017 (1SS108). The resulting DC is passed by high/medium/low power controller Q1017 (FMS1) and transmit inhibit gate Q1018 (IMX1) to Automatic Power Controller Q1019 (2SB986S) which regulates supply voltage to transmitter RF amplifiers Q1C10 and Q1011, so as to maintain stable high, medium or low output power under varying antenna loading conditions.

Spurious Suppression

Generation of spurious products by the transmitter is minimized by the fundamental carrier frequency being equal to the final transmitting frequency, modulated directly in the transmit VCO. Additional harmonic suppression is provided by a 3-pole lowpass filter consisting of L1002, L1013, L1014 and C1002, C1062, C1063, C1065-C1067, C1152 and C1153, resulting in more than 60 dB harmonic suppression (for transmitting frequencies in the amateur band) prior to delivery to the antenna.

PLL Frequency Synthesizer

PLL circuitry on the Main Unit consists of swallow counter Q1025 (MC12022SLAD) and PLL subsystem IC Q1024 (MC145158F2), which contains a reference oscillator/divider, serial-to-parallel data latch, programmable divider and a phase comparator. Stability is obtained by a regulated 5-V supply via Q1014 (2SC2712GR) to Q1024 and temperature compensating capacitors associated with 12.8-MHz frequency reference crystal X1002.

Receiver VCO Q301 (MMBR951L) on the VCO Unit oscillates between 118.6 and 152.6 according to the programmed receiving frequency. The VCO output is buffered by Q305 (2SC2759) on the VCO Unit, and then returned to the Main Unit where a sample of the output is buffered by Q1028 (2SC2714) for application to prescaler/swallow counter Q1025. There the VCO signal is divided by 64 or 65, according to a control signal from the data latch section of Q1024, before being applied to the programmable divider section of the PLL chip.

The data latch section of Q1024 also receives serial dividing data from microprocessor Q2001 on the Control Unit, which causes the predivided VCO signal to be further divided by 23,720 — 30,520 in the programmable divider section, depending upon the desired receive frequency, so as to produce a 5-kHz or 6.25-kHz derivative of the current VCO frequency. Meanwhile, the reference divider section of Q1024 divides the 12.8-MHz crystal reference by 2560 (or 2048) to produce the 5-kHz (or 6.25-kHz) loop reference (respectively).

The 5-kHz (or 6.25-kHz) signal from the programmable divider (derived from the VCO) and that derived from the crystal are applied to the phase detector section of Q1024, which produces a dual 5-V pulsed output with pulse duration depending on the phase difference between the input

CIRCUIT DESCRIPTION

signals. This pulse train is converted to DC by charge pump Q1026/Q1027 (MX3/IMZ2), low-pass filtered, and then fed back to varactors D301 and D302 (1T363 × 2) on the VCO Unit.

Changes in the level of the DC voltage applied to D301/D302 affect the reactance in the tank circuit of VCO Q301, changing the oscillating frequency according to the phase difference between the signals derived from the VCO and the crystal reference oscillator. The VCO is thus phase-locked to the crystal reference oscillator.

The output of receiver VCO Q301, after buffering by Q305, is delivered to the Main Unit for amplification by Q1005 before application to the 1st mixer, as described previously.

Transmitter VCO Q303 (MMBF951L) oscillates between 140 and 174 MHz according to the programmed transmit frequency. The remainder of the PLL circuitry is shared with the receiver. However, the dividing data from the microprocessor is such that the VCO frequency is at the actual transmit frequency (rather than offset for IFs, as in the receiving case). Also, the transmitter VCO is modulated by the filtered speech audio applied to modulating varactor D305, as described previously. If the FRC-6 Digital Coded Squelch option is installed, DCS modulation is applied both to the VCO and to the PLL frequency reference, via varactor D1021 (HVU202).

Transmit Inhibit

When the transmit PLL is unlocked pin 7 of PLL chip Q1024 goes to a logic low, turning on Q1020 (DTA143EK) and turning off half of Q1018. This unlock signal produces a low impedance at the base of the other half of Q1018, which then turns off Automatic Power Controller Q1019 to disable the supply voltage to transmitter RF amplifiers Q1010 and Q1011, disabling the transmitter.

Miscellaneous Circuits

Power-On Sequencing & Panel Lamps

Pressing the **POWER** switch on the front panel turns on Q2007 (2SA1162GR) on the Control Unit, applying 5 volts from regulator Q2004 (RH5VA-45AA) via Q2003 (NJU7201U50) and the 13.8-V supply line to the base of Q2012 (DTC114EK). This pulls PO KEY pin 38 of microprocessor Q2001 low, causing PO ON pin 19 to go high. The PO ON line then pulls the base of Q2018 (2SB1301-ZQ) low via Q2015 (FMG8), lighting the pilot lamps via Q2014 (2SD1033K) and Q2010 (2SB1301-ZQ). Lamp brightness is controlled by CdS photosensor CS2001, opamp Q2009 (NJM2904M-1/2), and transistor Q2011 (2SC2712GR), powered by regulator Q2013 (NJU7201U50).

When Q2015 is turned on by the PO ON line, it turns on Q3001 (DTA114EK) on the Interface Unit, which in turn allows Q3002 (2SB1140S) to pass 13.8 volts to regulator Q3003 (HA17808P), and to 9-volt regulator Q1013, audio amplifier Q1023 and APC switch Q1019 on the Main Unit.

Push-To-Talk Transmit Activation

The PTT switch on the microphone is connected to pin 17 of microprocessor Q2001, so that when the switch is closed pin 12 (tx/rx) goes low. This signal is delivered to power bus controller Q1021 (IMH5) on the Main Unit, which then disables the receiver by disabling the 9-V supply bus at Q1022 (DTA143EK) to the front end, IF discriminator and receiver VCO circuitry. At the same time, Q1015 (2SB986S) activates the transmit 9-V supply line to enable the transmitter.

PACKAGING

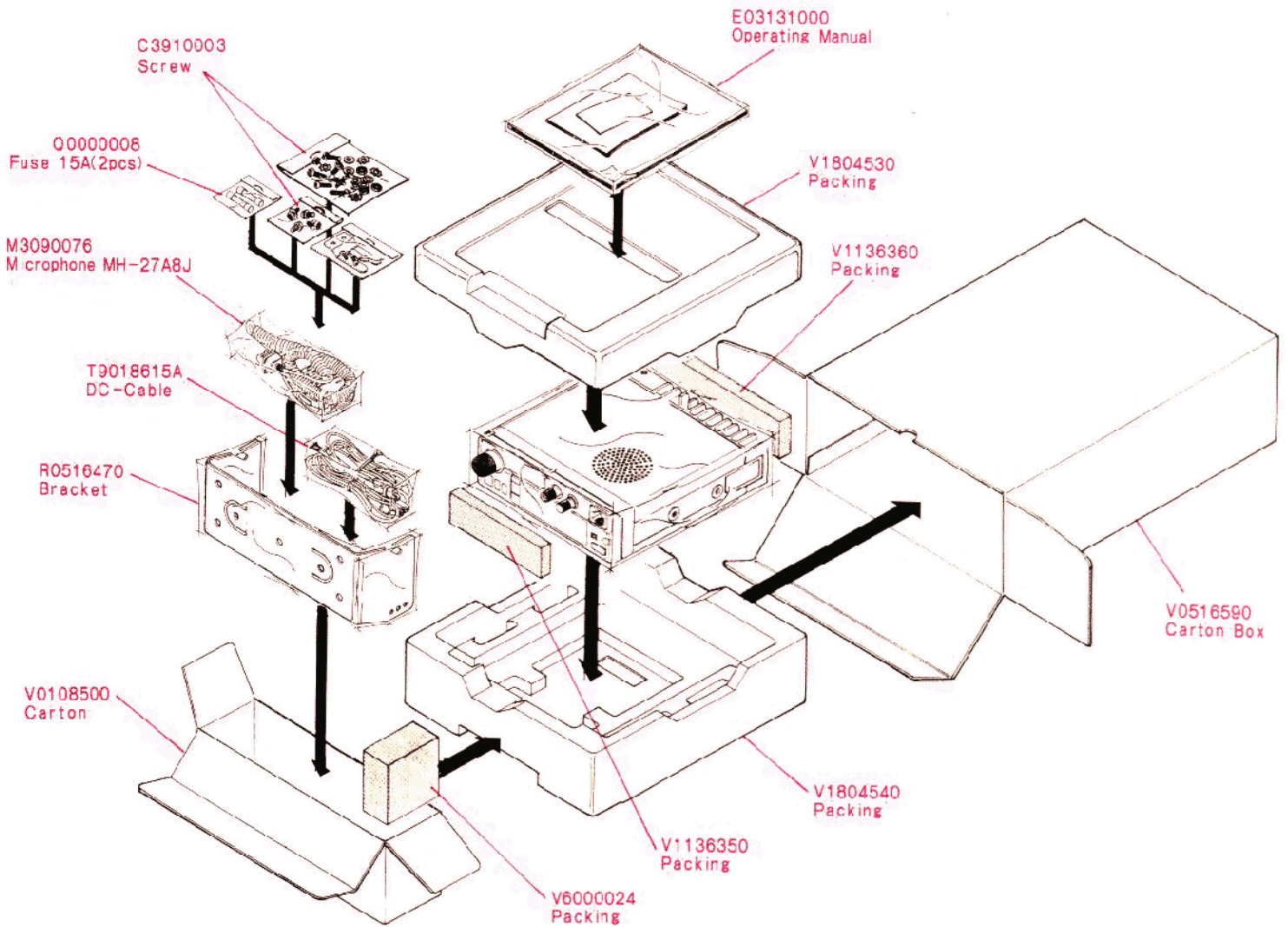

MAIN-ASSY PARTS LIST

REF	YABSU P/N	DESCRIPTION	MFGR'S DESIG.	VALUE	WV	TOL.	VERS.
*** MAIN ASSY ***							
Z 0001	Q0000008	FUSE (2 PCS)			15A		
J 0001	P1090654	CONNECTOR	HSJ0780-01-010				
J 0002	P1090352	CONNECTOR	FM-NDR-MI				
P 0001	T9206000A	WIRE-ASSY					
P 0002	T9206082	WIRE-ASSY					
P 0003	T9206087	WIRE-ASSY					
P 0004	T9206088	WIRE-ASSY					
P 0005	T9206089	WIRE ASSY					
P 0006	T9206091	WIRE-ASSY					
SP0001	M4090067	SPEAKER	TL-57A	8ohm	1.5W		

EXPLODED VIEW

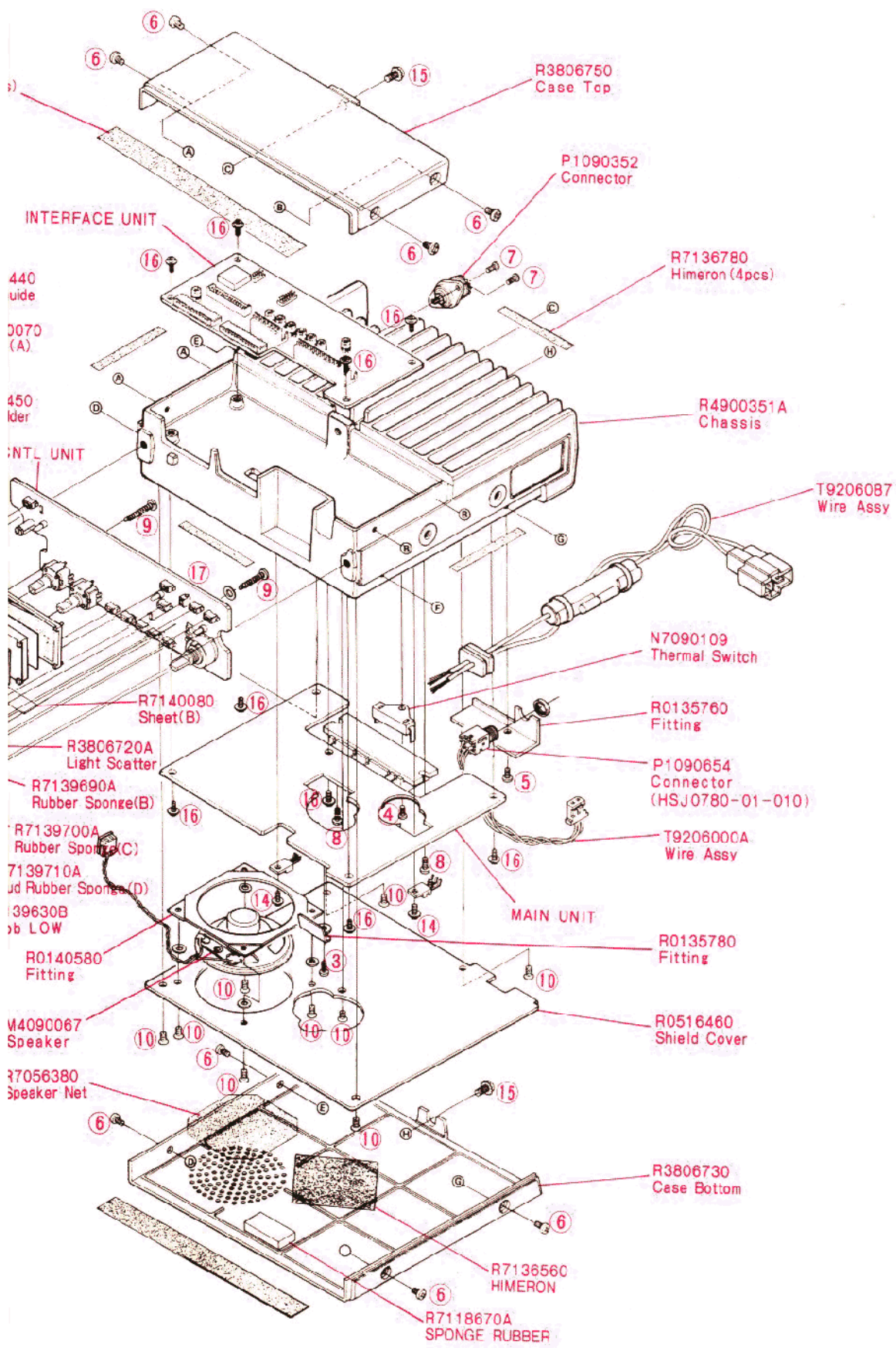

EXPLODED VIEW

SCREW LIST			
Part No.	YAESU P/N	Description	qty
①	L43104001	TAPTITE SCREW M2X4	1
②	L43206001	TAPTITE SCREW M2.6x6	2
③	L00306001	PAN HEAD SCREW M3X6	1
④	L03308002	PAN HEAD SCREW ASM3X8N1	1
⑤	L20306001	BINDING HEAD SCREW M3X6	1
⑥	L20306007	BINDING HEAD SCREW M3X6B	8
⑦	L20306002	BINDING HEAD SCREW M3X6N1	2
⑧	L20308001	BINDING HEAD SCREW M3X8	2
⑨	L23214001	TAPTITE SCREW M2.6X6	2
⑩	U30206001	FLAT HEAD SCREW M2.6X6	9
⑪	U30306007	FLAT HEAD SCREW M3X6B	1
⑫	U51425007	HEX SOCKET HEAD BOLT M4X25D	2
⑬	U9900020	HEX HEAD BOLT HSM4X8B	4
⑭	U04208001	SEMS SCREW HSN2.6X8	2
⑮	U06408007	SCREW DM4X8B	2
⑯	U05308002	CAP SCREW TM3X8N1	8
⑰	U753U3650	PLAIN WASHER ¥3X6X0.5	1

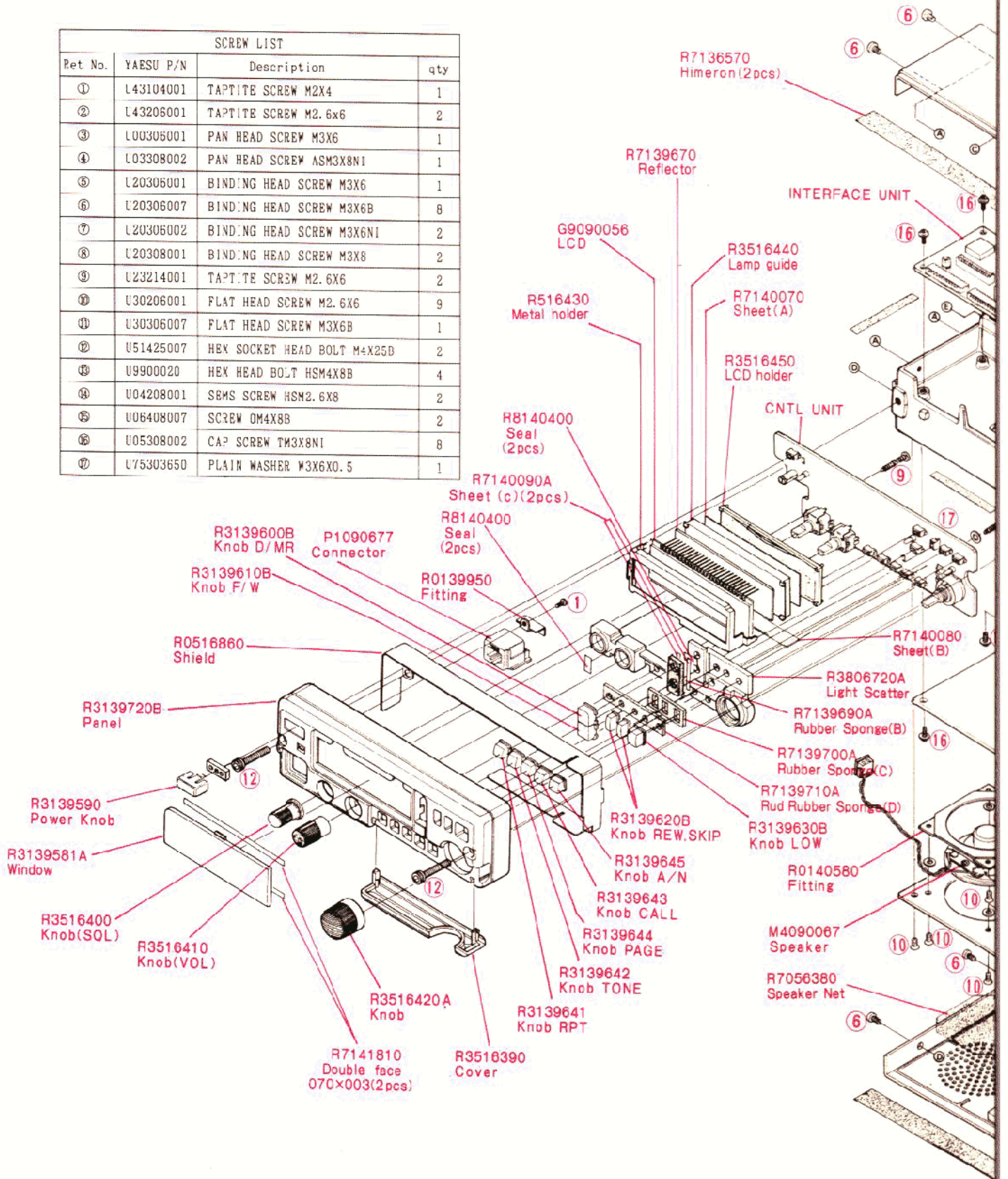

ALIGNMENT

The FT-2400H has been carefully aligned at the factory for the specified performance across the amateur band. Realignment should therefore not be necessary except in the event of a component failure. All component replacement and service should be performed only by an authorized Yaesu representative, or the warranty policy may be voided.

The following procedures cover the sometimes critical and tedious adjustments that are not normally required once the transceiver has left the factory. However, if damage occurs and some parts subsequently be replaced, realignment may be required. If a sudden problem occurs during normal operation, it is likely due to component failure; realignment should not be done until after the faulty component has been replaced.

We recommend that servicing be performed only by authorized Yaesu service technicians who are experienced with the circuitry and fully

equipped for repair and alignment. Therefore, if a fault is suspected, contact the dealer from whom the transceiver was purchased for instructions regarding repair. Authorized Yaesu service technicians realign all circuits and make complete performance checks to ensure compliance with factory specifications after replacing any faulty components.

Those who do undertake any of the following alignments are cautioned to proceed at their own risk. Problems caused by unauthorized attempts at realignment are not covered by the warranty policy. Also, Yaesu must reserve the right to change circuits and alignment procedures in the interest of improved performance, without notifying owners.

Under no circumstances should any alignment be attempted unless the normal function and operation of the transceiver are clearly understood, the cause of the malfunction has been clearly pinpointed and any faulty components replaced, and

Case Disassembly

- ❑ Make sure the transceiver is off. Loosen the screws on the heatsink and remove the top and bottom covers. The Control Unit is now accessible on the top of the chassis.
- ❑ In the bottom of the set, remove the 5 screws from the shield cover, and remove the shield to gain access to the Main Unit.

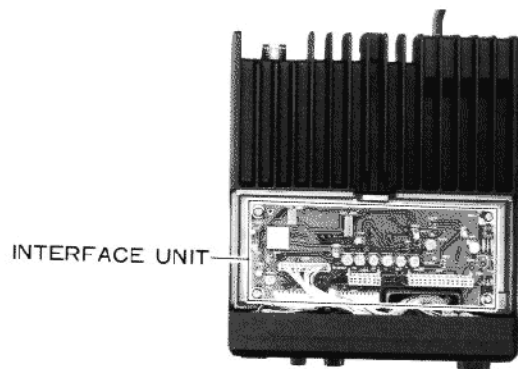
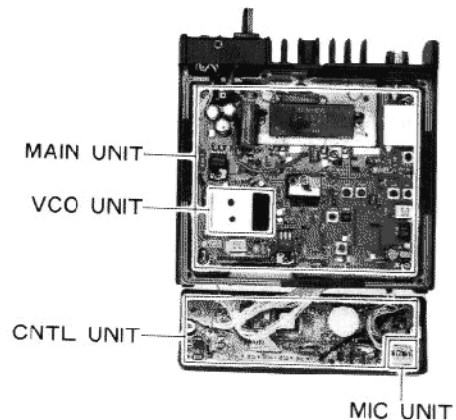
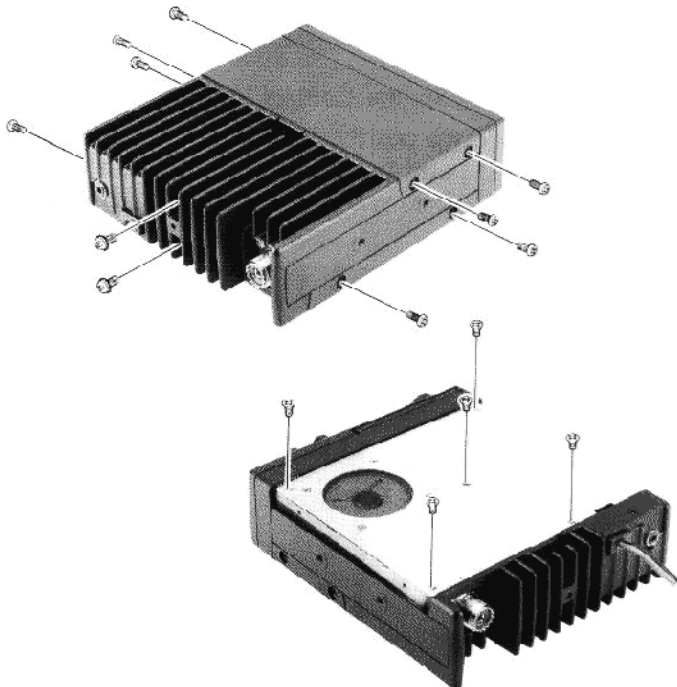

ALIGNMENT

the need for realignment determined to be absolutely necessary.

The following test equipment (and thorough familiarity with its correct use) is necessary for complete realignment. Correction of problems caused by misalignment resulting from use of improper test equipment is not covered under the warranty policy. While most steps do not require all of the equipment listed, the interactions of some adjustments may require that more complex adjustments be performed afterwards. Do not attempt to perform only a single step unless it is clearly isolated electrically from all other steps. Rather, have all test equipment ready before beginning, and follow all of the steps in a section in the order presented.

Required Test Equipment

- RF Signal Generator with calibrated output level at 200 MHz
- Deviation Meter (linear detector)
- Oscilloscope
- AF Millivoltmeter
- SINAD Meter
- Inline Wattmeter with 5% accuracy at 200 MHz
- Regulated DC Power Supply adjustable from 10 to 17V, 15A
- 50-Ω Dummy Load: 100W at 200 MHz
- Frequency Counter: ± 0.2 ppm accuracy at 200 MHz
- AF Signal Generator
- DC Voltmeter: high impedance
- Spectrum Analyzer
- VHF Sampling Coupler

Alignment Preparation & Precautions

A 50-Ω dummy load and inline wattmeter must be connected to the main antenna jack in all procedures that call for transmission, except where specified otherwise. Correct alignment is not possible with an antenna.

After completing one step, read the following step to determine whether the same test equipment will be required. If not, remove the test equipment (except dummy load and wattmeter, if connected) before proceeding.

Correct alignment requires that the ambient temperature be the same as that of the transceiver and test equipment, and that this temperature be held constant between 20 and 30 °C (68 ~ 86 °F). When the transceiver is brought into the shop from hot or cold air it should be allowed some time for thermal equalization with the environment before alignment.

Alignments must only be made with oscillator shields and circuit boards firmly affixed in place. Also, the test equipment must be thoroughly warmed up before beginning.

Note: Signal levels in dB referred to in the alignment procedure are based on $0 \text{ dB}\mu = 0.5 \text{ dB}\mu\text{V}$.

PLL & Transmitter

Set up the test equipment as shown here for transmitter alignment. Maintain the supply voltage at 13.6V for all steps.

PLL & Transmitter Alignment Setup

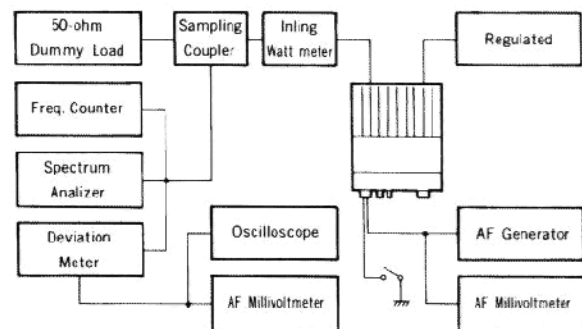

PLL VCV (Varactor Control Voltage)

- Connect the positive lead of the DC voltmeter to the test point near C1141 on the Main Unit, as indicated below, and the negative lead to chassis ground.

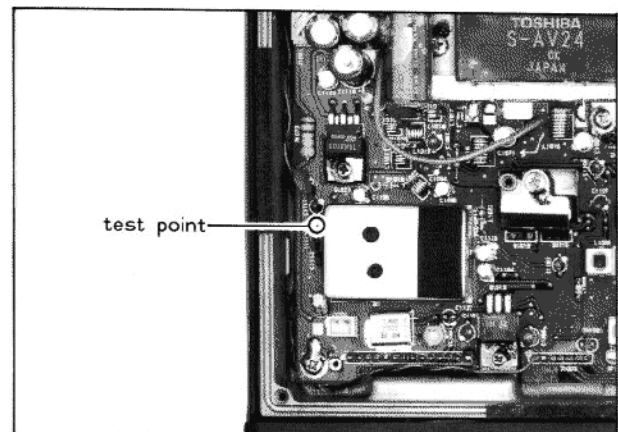

ALIGNMENT

PLL & Transmitter Alignment Points

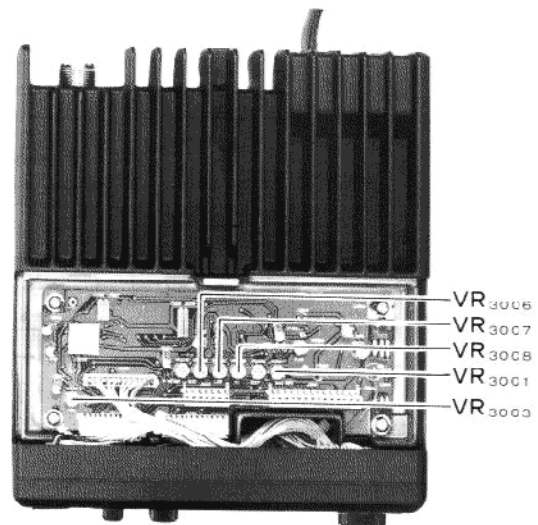
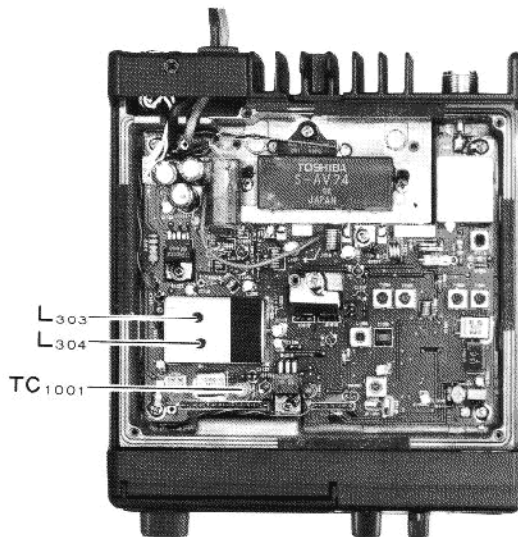

- ❑ Set the transceiver to 174.000 MHz, and adjust coil L303 on the VCO Unit for 6.8 V on the voltmeter.
- ❑ Retune to 140.000 MHz, and confirm at least 0.8V on the meter.
- ❑ Tune to 174.000 MHz again, and this time key the transmitter while adjusting coil L304 on the VCO Unit for 6.5V on the voltmeter.
- ❑ Again retune to 140.000 MHz, key the transmitter, and confirm at least 1V on the meter.
- ❑ Tune to 146.000 MHz and confirm the VCV is between 1.3 and 2.0V.

PLL Reference Frequency

- ❑ With the wattmeter, dummy load and frequency counter connected to the antenna jack, and while tuned to 146.000 MHz, key the transmitter and adjust TC1001 on the Main Unit, if necessary, so the counter frequency is within 100 Hz of 146.000 MHz.

Transmitter Output Power & APC

- ❑ Preset trimmer potentiometers VR3006, VR3007 and VR3008 fully clockwise.
- ❑ While tuned to 146.000 MHz, press the **LOW** button on the panel to select high, medium and

then low power while adjusting these potentiometers for the corresponding transmitter power output levels listed below:

Panel Power Selection	Adjustment	Power Output
High	VR3008	50 ± 5W
Medium	VR3006	25 ± 1W
Low	VR3007	5 ± 1W

Transmitter Deviation

- ❑ While tuned to 146.000 MHz, adjust the AF generator attenuator for 50 mV output at 1 kHz to the **MIC** jack.
- ❑ Key the transmitter and adjust VR3001 on the Interface Unit for ±4.8 kHz deviation on the deviation meter (within 100 Hz).
- ❑ Press **F/W** → **TONE** and select the 88.5-Hz CTCSS tone. Then press **TONE** again once or twice (so that "**ENC**" is displayed) to enable 88.5-Hz CTCSS tone generation.
- ❑ Reduce the AF generator injection to zero. Key the transmitter, and adjust VR3003 on the Interface Unit for ±0.7 kHz deviation (within 100 Hz).

ALIGNMENT

Receiver

Set up the test equipment as shown below for receiver alignment.

Receiver Alignment Setup

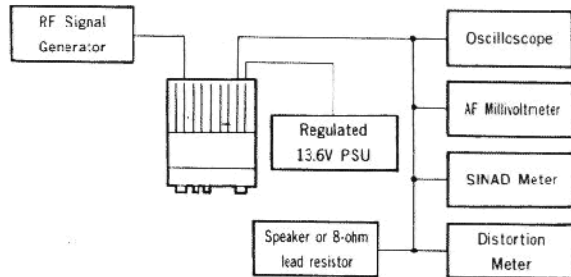

Receiver Alignment Points

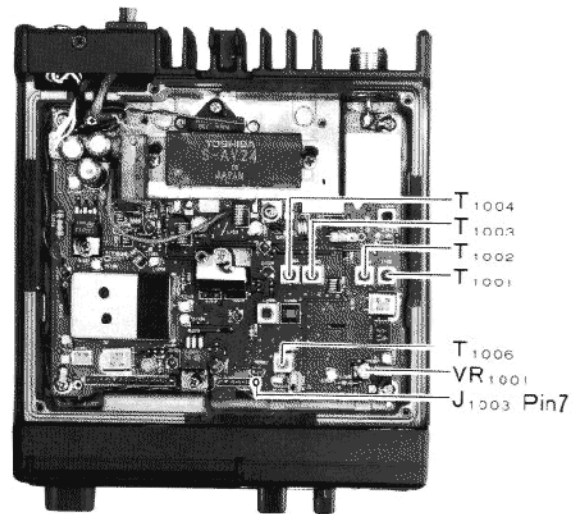

Interstage Transformers

- Connect the DC voltmeter between J1003 pin 7 and chassis ground.
- Modulate the RF signal generator with ± 3.5 kHz deviation of a 1-kHz tone.
- Adjust T1001 through T1004 on the Main Unit for maximum voltage on the meter, then adjust T1006 for optimum SINAD (at least -7 dB μ for 12 dB SINAD).

S-Meter Calibration

- While tuned to 146.000 MHz, inject 25 dB μ RF modulated with ± 3.5 kHz deviation of a 1-kHz tone, and adjust VR3005 on the Interface Unit so that all S-meter segments are just on.

Scanner Center-Stop

- Connect the DC voltmeter (3-V range) between TP3001 (+) and TP3002 (-) on the Interface Unit.
- With both the transceiver and signal generator tuned to 146.000 MHz, set the SQL fully counterclockwise (the BUSY indicator should be on). Inject 20 dB μ RF modulated with ± 3.5 kHz deviation of a 1-kHz tone, and adjust VR3004 on the Interface Unit for zero volts on the voltmeter.

Squelch

- At the center of the band, tune the RF signal generator to the same frequency, and set the generator level to -12 dB μ .
- Turn VR1001 clockwise until the squelch just closes, and then counterclockwise very slightly so that it just opens.

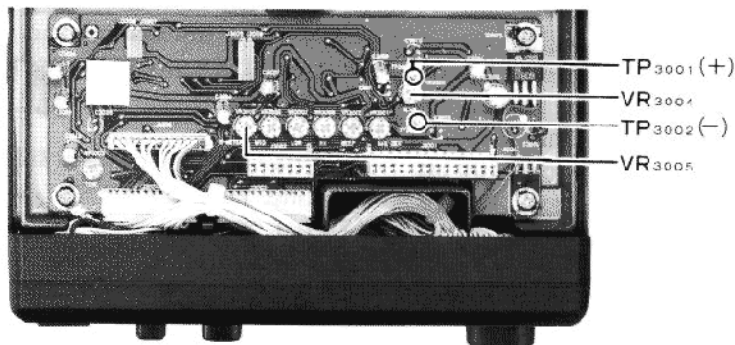

K DIAGRAM

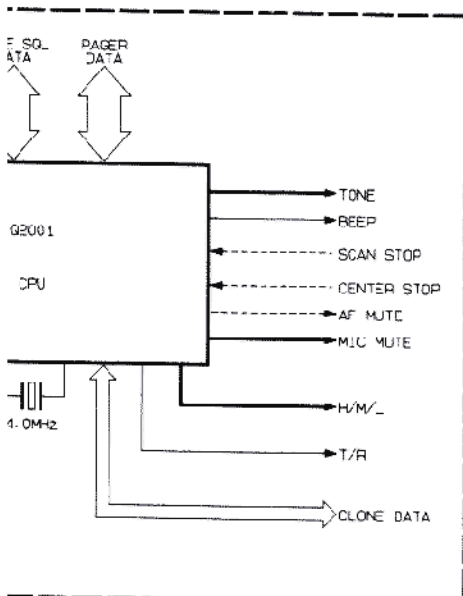
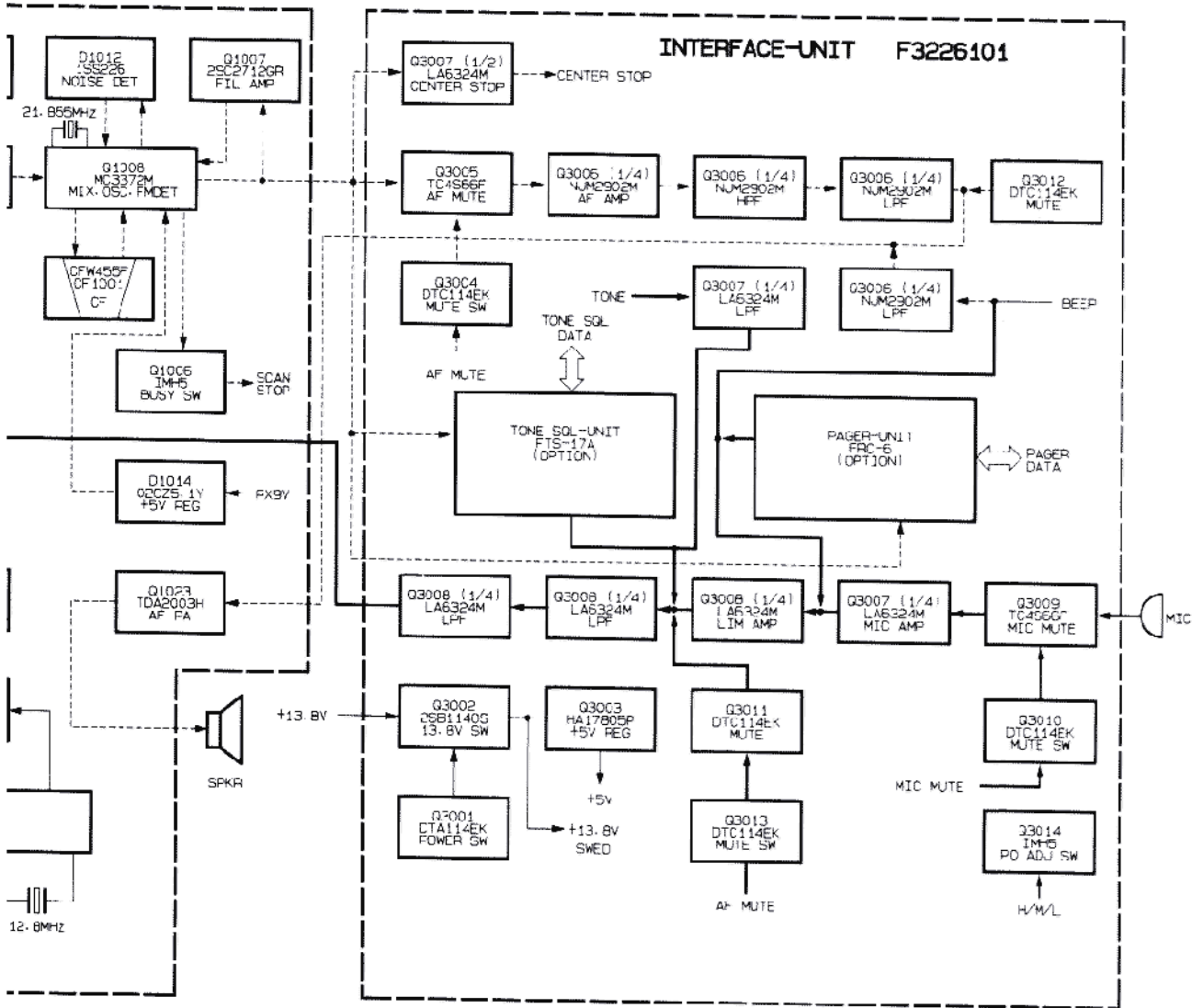

BLOCK DIAGRAM

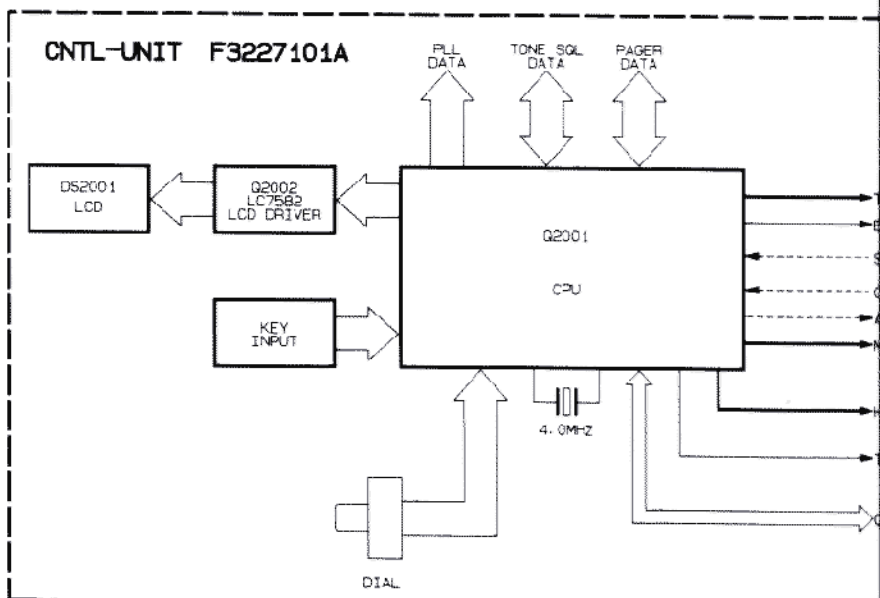
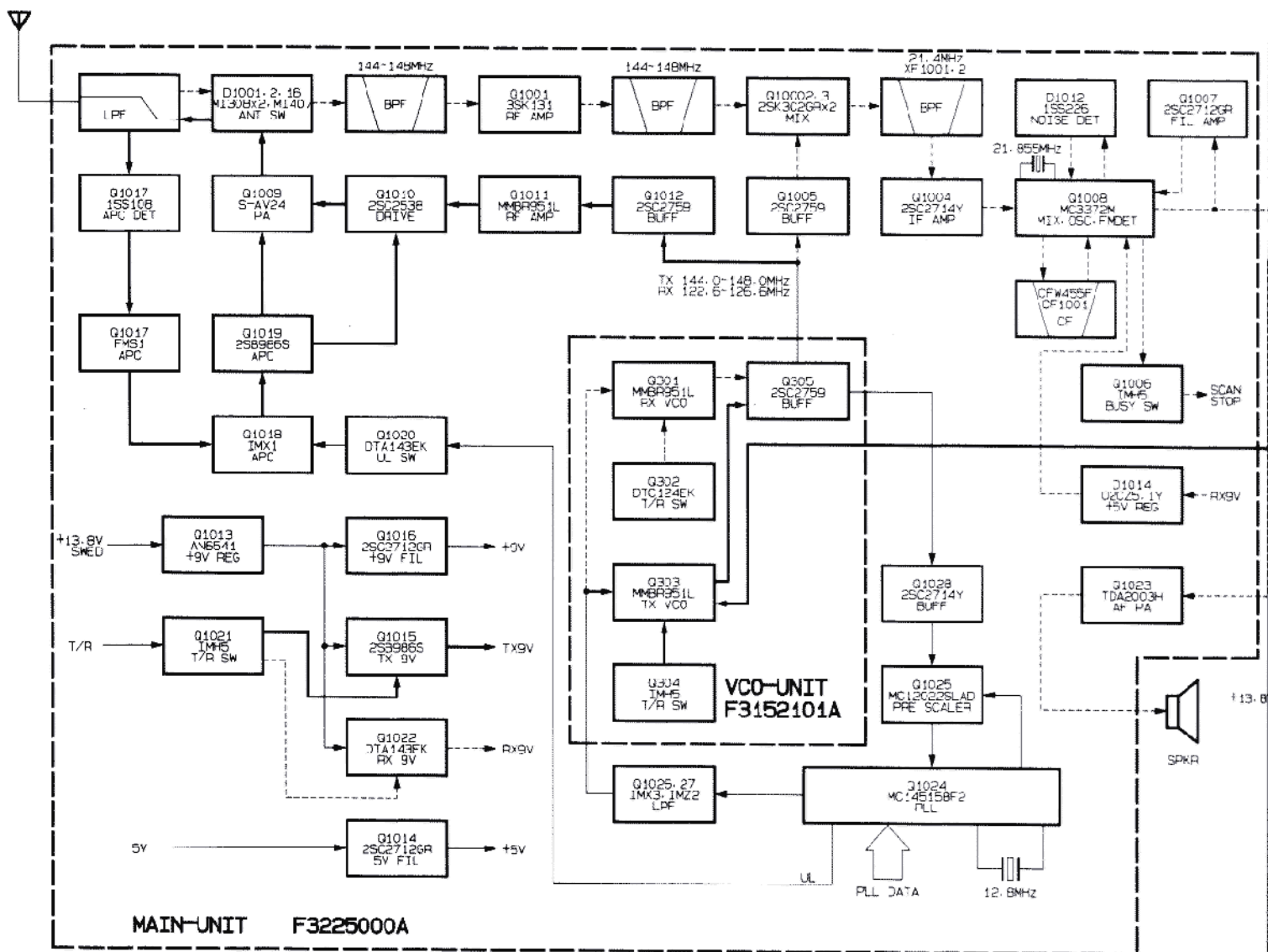

VCO UNIT PARTS LIST

REF	YAESU P/N	DESCRIPTION	MFR'S DESIG.	VALUE	WV	TOL.	VERS.
*** VCO-UNIT ***							
	CA0513001	P.C.B. W COMP.					
	F3152101A	P.C.B. W/O COMP.					
C 0301	K22170206	CHIP CAP.	GRM40CH050C50PT	5pF	50V	CH	
C 0302	K22170211	CHIP CAP.	GRM40CH100D50PT	10pF	50V	CH	
C 0303	K22170217	CHIP CAP.	GRM40CH180J50PT	18pF	50V	CH	
C 0304	K22170215	CHIP CAP.	GRM40CH150J50PT	15pF	50V	CH	
C 0305	K22170202	CHIP CAP.	GRM40CK010C50PT	1pF	50V	CK	
C 0306	K46120007	AL. ELECTRO. CAP.	16V101M6X7TR2	100uF	16V		
C 0307	K22170805	CHIP CAP.	GRM40B102M50PT	0.001uF	50V	D	
C 0308	K22170202	CHIP CAP.	GRM40CK010C50PT	1pF	50V	CK	
C 0309	K22170207	CHIP CAP.	GRM40CH060D50PT	6pF	50V	CH	
C 0310	K22170215	CHIP CAP.	GRM40CH150J50PT	15pF	50V	CH	
C 0311	K22170217	CHIP CAP.	GRM40CH180J50PT	18pF	50V	CH	
C 0312	K22170219	CHIP CAP.	GRM40CH220J50PT	22pF	50V	CH	
C 0313	K22170805	CHIP CAP.	GRM40E102M50PT	0.001uF	50V	B	
C 0314	K22170805	CHIP CAP.	GRM40E102M50PT	0.001uF	50V	B	
C 0315	K22170203	CHIP CAP.	GRM40CK020C50PT	2pF	50V	CK	
C 0316	K22170805	CHIP CAP.	GRM40E102M50PT	0.001uF	50V	B	
C 0317	K22170211	CHIP CAP.	GRM40CH100D50PT	10pF	50V	CH	
C 0318	K22170805	CHIP CAP.	GRM40E102M50PT	0.001uF	50V	B	
C 0319	K22170205	CHIP CAP.	GRM40CH040C50PT	4pF	50V	CH	
C 0320	K22170805	CHIP CAP.	GRM40E102M50PT	0.001uF	50V	B	
C 0321	K22170805	CHIP CAP.	GRM40E102M50PT	0.001uF	50V	B	
C 0322	K22170805	CHIP CAP.	GRM40E102M50PT	0.001uF	50V	B	
D 0301	G2070114	DIODE	1T363-01-T08A				
D 0302	G2070114	DIODE	1T363-01-T08A				
D 0303	G2070114	DIODE	1T363-01-T08A				
D 0304	G2070114	DIODE	1T363-01-T08A				
D 0305	G2070092	DIODE	HYU202-10TRP				
L 0301	L1190203	M. RFC	LAL03NA4R7K	4.7uH			
L 0302	L1190203	M. RFC	LAL03NA4R7K	4.7uH			
L 0303	L0190168	CJIL	S7-T2 R12-K868C				
L 0304	L0190169	CJIL	S7-T2 R12-K868B				
L 0305	L1630017	CJIL	32CS 380LB-2R2M=F	2.2uH			
L 0306	L1630017	CJIL	32CS 380LB-2R2M=F	2.2uH			
Q 0301	G3070056	TRANSISTOR	MMBR951LT1				
Q 0302	G3070034	TRANSISTOR	DTC124EK T97				
Q 0303	G3070056	TRANSISTOR	MMBR951LT1				
Q 0304	G3070027	TRANSISTOR	1MH5 T108				
Q 0305	G3327597B	TRANSISTOR	2SC27E9-T2B U22				
R 0301	J24205273	CHIP RES.	RMC1/10T 273J	27K	1/10W		
R 0302	J24205273	CHIP RES.	RMC1/10T 273J	27K	1/10W		
R 0303	J24205222	CHIP RES.	RMC1/10T 222J	2.2K	1/10W		
R 0304	J24205470	CHIP RES.	RMC1/10T 470J	47	1/10W		
R 0305	J24205273	CHIP RES.	RMC1/10T 273J	27K	1/10W		
R 0306	J24205273	CHIP RES.	RMC1/10T 273J	27K	1/10W		
R 0307	J24205102	CHIP RES.	RMC1/10T 102J	1K	1/10W		
R 0308	J24205332	CHIP RES.	RMC1/10T 332J	3.3K	1/10W		
R 0309	J24205103	CHIP RES.	RMC1/10T 103J	10K	1/10W		

VCO UNIT PARTS LIST

REF	YAESU P/N	DESCRIPTION	MFR'S DESIG.	VALUE	WV	TOL.	VERS.
R 0310	J24205221	CHIP RES.	RMC1/10T 221J	220		1/10W	
R 0311	J24205152	CHIP RES.	RMC1/10T 152J	1.5K		1/10W	
R 0312	J24205223	CHIP RES.	RMC1/10T 223J	22K		1/10W	
TP0301	Q5000037	TP-H MK-10160	TP-H MK-10160				
TP0302	Q5000037	TP-H MK-10160	TP-H MK-10160				
TP0303	Q5000037	TP-H MK-10160	TP-H MK-10160				
TP0304	Q5000037	TP-H MK-10160	TP-H MK-10160				
TP0305	Q5000037	TP-H MK-10160	TP-H MK-10160				
	R013G240A	SHIELD CASE					

T/CIRCUIT DIAGRAM

F3152101A

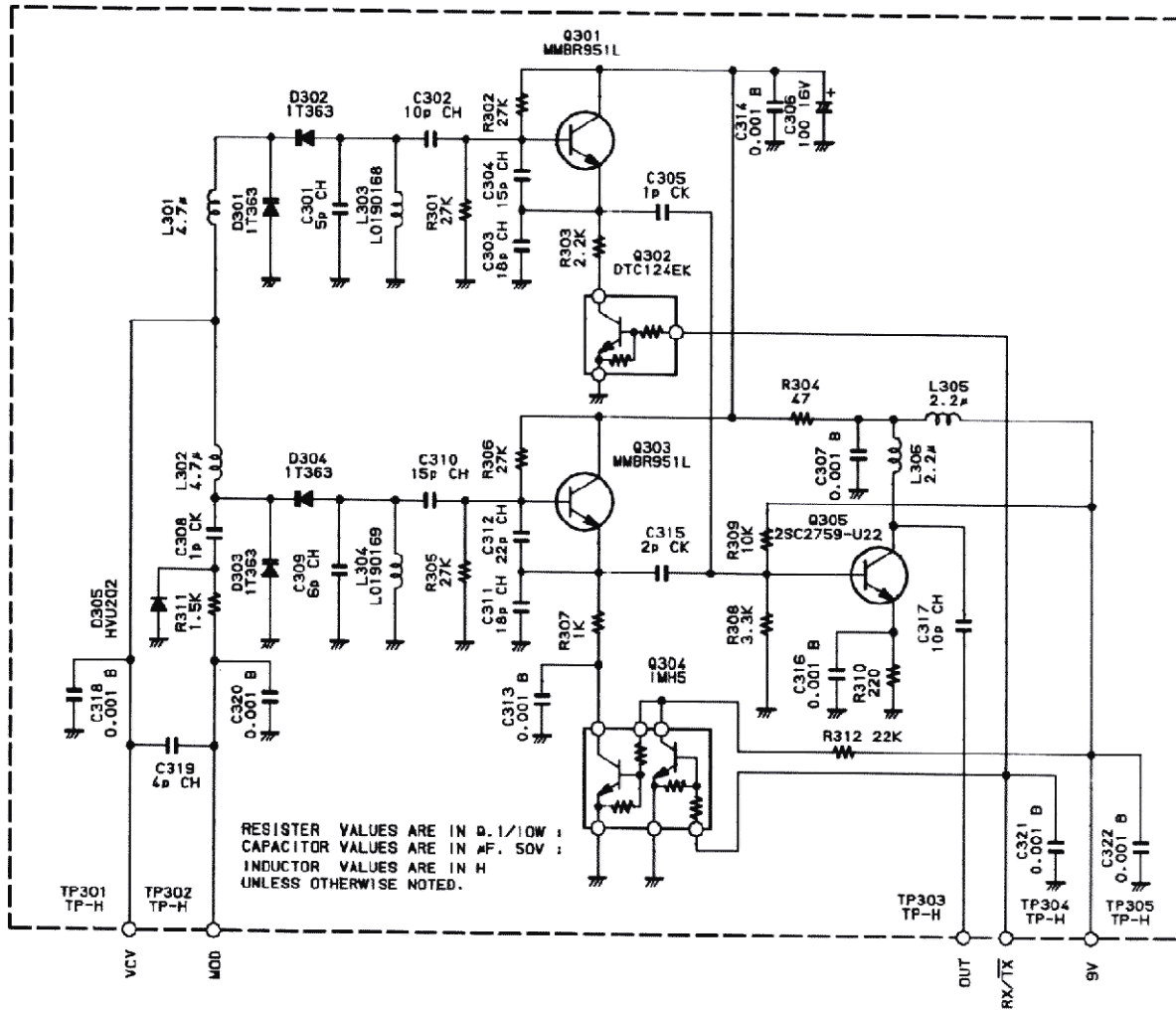

VCO UNIT PARTS LAYOUT

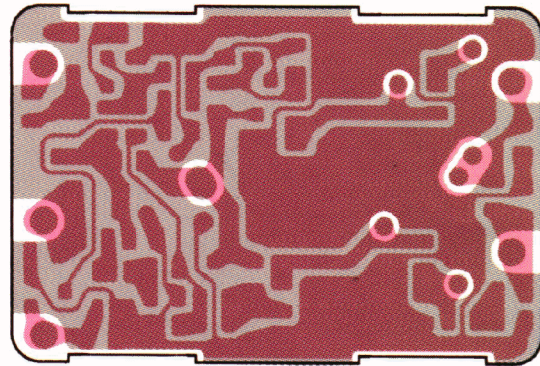
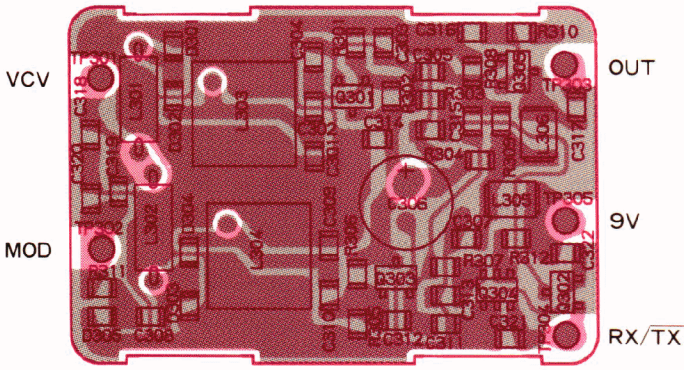

Obverse View of "Mixed Component" Side

Obverse View of Solder Side

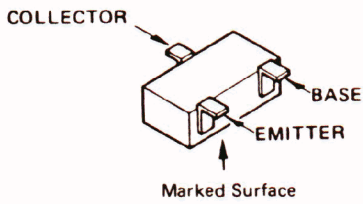

MMBR951(7Z) (Q301, 303)
 DTC124EK(25) (Q302)
 2SC2759(U22) (Q305)

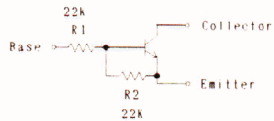

DTC124EK CIRCUIT DIAGRAM

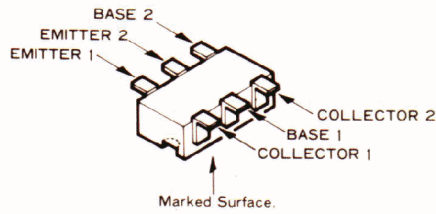

IMH5(H5) (Q304)

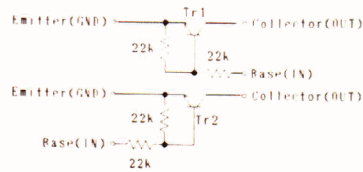

IMH5 CIRCUIT DIAGRAM

MAIN UNIT PARTS LIST

REF	YAESU P/N	DESCRIPTION	MFR'S DESIG.	VALUE	WV	TOL.	VERS.
*** MAIN-UNIT ***							
	CA0511001	P. C. B. W COMP.					
	F3225000A	P. C. B. W/C COMP.					
C 1001	K22275809	CHIP CAP.	GRM42-2W5R102K500PT	C. 001uF	500V	W5P	
C 1002	K22275219	CHIP CAP.	GRM42-2CH180J500PT	18pF	500V	CH	
C 1003	K22170223	CHIP CAP.	GRM40CH330J50PT	33pF	50V	CH	
C 1004	K22170204	CHIP CAP.	GRM40CJ030C50PT	3pF	50V	CJ	
C 1005	K22170805	CHIP CAP.	GRM403102M50PT	C. 001uF	50V	B	
C 1006	K22170203	CHIP CAP.	GRM40CK020C50PT	2pF	50V	CK	
C 1007	K22170805	CHIP CAP.	GRM403102M50PT	C. 001uF	50V	B	
C 1008	K22170207	CHIP CAP.	GRM40CH060D50PT	6pF	50V	CH	
C 1010	K22170219	CHIP CAP.	GRM40CH220J50PT	22pF	50V	CH	
C 1011	K22170805	CHIP CAP.	GRM403102M50PT	C. 001uF	50V	B	
C 1012	K22170805	CHIP CAP.	GRM403102M50PT	C. 001uF	50V	B	
C 1013	K22170805	CHIP CAP.	GRM403102M50PT	C. 001uF	50V	B	
C 1014	K22170805	CHIP CAP.	GRM403102M50PT	C. 001uF	50V	B	
C 1015	K22170805	CHIP CAP.	GRM403102M50PT	C. 001uF	50V	B	
C 1016	K22170805	CHIP CAP.	GRM403102M50PT	C. 001uF	50V	B	
C 1017	K22170805	CHIP CAP.	GRM403102M50PT	C. 001uF	50V	B	
C 1018	K22170232	CHIP CAP.	GRM40CK010C50PT	1pF	50V	CK	
C 1019	K22170805	CHIP CAP.	GRM403102M50PT	C. 001uF	50V	B	
C 1020	K22170233	CHIP CAP.	GRM40CK020C50PT	2pF	50V	CK	
C 1021	K22170233	CHIP CAP.	GRM40CK020C50PT	2pF	50V	CK	
C 1023	K22170805	CHIP CAP.	GRM403102M50PT	C. 001uF	50V	B	
C 1025	K22170805	CHIP CAP.	GRM403102M50PT	C. 001uF	50V	B	
C 1027	K46120004	AL. ELECTRO. CAP.	16V100M4X7T2	10uF	16V		
C 1028	K22170817	CHIP CAP.	GRM40B103M50PT	0.01uF	50V	B	
C 1029	K22170817	CHIP CAP.	GRM40B103M50PT	0.01uF	50V	B	
C 1030	K22170805	CHIP CAP.	GRM403102M50PT	C. 001uF	50V	B	
C 1031	K22170211	CHIP CAP.	GRM40CH100D50PT	10pF	50V	CH	
C 1032	K22170211	CHIP CAP.	GRM40CH100D50PT	10pF	50V	CH	
C 1033	K22170209	CHIP CAP.	GRM40CH080D50PT	8pF	50V	CH	
C 1034	K22170817	CHIP CAP.	GRM40B103M50PT	0.01uF	50V	B	
C 1035	K22170817	CHIP CAP.	GRM40B103M50PT	0.01uF	50V	B	
C 1036	K22170817	CHIP CAP.	GRM40B103M50PT	0.01uF	50V	B	
C 1037	K22170805	CHIP CAP.	GRM403102M50PT	C. 001uF	50V	B	
C 1038	K22170805	CHIP CAP.	GRM403102M50PT	C. 001uF	50V	B	
C 1039	K22170805	CHIP CAP.	GRM403102M50PT	C. 001uF	50V	B	
C 1040	K22170227	CHIP CAP.	GRM40CH470J50PT	47pF	50V	CH	
C 1041	K22170805	CHIP CAP.	GRM403102M50PT	C. 001uF	50V	B	
C 1042	K22170221	CHIP CAP.	GRM40CH270J50PT	27pF	50V	CH	
C 1043	K22170211	CHIP CAP.	GRM40CH100D50PT	10pF	50V	CH	
C 1045	K78140009	TANTALUM CHIP CAP.	TESVA1E174M1-8R	0.47uF	25V		
C 1046	K46120004	AL. ELECTRO. CAP.	16V100M4X7T2	10uF	16V		
C 1047	K22140811	CHIP CAP.	GRM40B104M25PT	0.1uF	25V	B	
C 1048	K22170817	CHIP CAP.	GRM40B103M50PT	0.01uF	50V	B	
C 1049	K22170817	CHIP CAP.	GRM40B103M50PT	0.01uF	50V	B	
C 1050	K22170809	CHIP CAP.	GRM40B222M50PT	0.0022uF	50V	B	
C 1051	K22170805	CHIP CAP.	GRM403102M50PT	C. 001uF	50V	B	
C 1052	K22170231	CHIP CAP.	GRM40CH680J50PT	68pF	50V	CH	
C 1053	K22170225	CHIP CAP.	GRM40CH390J50PT	39pF	50V	CH	
C 1054	K46120004	AL. ELECTRO. CAP.	16V100M4X7T2	10uF	16V		
C 1055	K22170231	CHIP CAP.	GRM40CH680J50PT	68pF	50V	CH	
C 1056	K22140811	CHIP CAP.	GRM40B104M25PT	0.1uF	25V	B	

MAIN UNIT PARTS LIST

REF	YAESU P/N	DESCRIPTION	MFR'S DESIG.	VALUE	NV	TOL.	VERS.
C 1057	K22140811	CHIP CAP.	GRM40E104M25PT	0.1uF	25V	E	
C 1058	K22170233	CHIP CAP.	GRM40CH820J50PT	82pF	50V	CH	
C 1059	K22170817	CHIP CAP.	GRM40E103M50PT	0.01uF	50V	E	
C 1060	K22170805	CHIP CAP.	GRM40E102M50PT	0.001uF	50V	E	
C 1061	K22275221	CHIP CAP.	GRM42-2CH220J50OPT	22pF	500V	CH	
C 1063	K22275219	CHIP CAP.	GRM42-2CH130J50OPT	13pF	500V	CH	
C 1064	K22170202	CHIP CAP.	GRM40CK010C50PT	1pF	50V	CK	
C 1065	K22275221	CHIP CAP.	GRM42-2CH220J50OPT	22pF	500V	CH	
C 1066	K22170208	CHIP CAP.	GRM40CH070J50PT	7pF	50V	CH	
C 1067	K22275217	CHIP CAP.	GRM42-2CH150J50OPT	15pF	500V	CH	
C 1068	K22170805	CHIP CAP.	GRM40E102M50PT	0.001uF	50V	E	
C 1069	K46160005	AL. ELECTRO. CAP.	35V.0CM5X7TR2	10uF	35V		
C 1070	K22170805	CHIP CAP.	GRM40E102M50PT	0.001uF	50V	E	
C 1071	K46160005	AL. ELECTRO. CAP.	35V.0CM5X7TR2	10uF	35V		
C 1072	K22170805	CHIP CAP.	GRM40E102M50PT	0.001uF	50V	E	
C 1074	K22170219	CHIP CAP.	GRM40CH220J50PT	22pF	50V	CH	
C 1075	K22170805	CHIP CAP.	GRM40E102M50PT	0.001uF	50V	E	
C 1076	K22170223	CHIP CAP.	GRM40CH330J50PT	33pF	50V	CH	
C 1077	K22170221	CHIP CAP.	GRM40CH270J50PT	27pF	50V	CH	
C 1078	K22170805	CHIP CAP.	GRM40E102M50PT	0.001uF	50V	E	
C 1080	K22170221	CHIP CAP.	GRM40CH270J50PT	27pF	50V	CH	
C 1081	K22170805	CHIP CAP.	GRM40E102M50PT	0.001uF	50V	E	
C 1082	K22170219	CHIP CAP.	GRM40CH220J50PT	22pF	50V	CH	
C 1083	K22170805	CHIP CAP.	GRM40E102M50PT	0.001uF	50V	E	
C 1084	K40149037	AL. ELECTRO. CAP.	RE2-25V471M	470uF	25V		
C 1085	K22170817	CHIP CAP.	GRM40E103M50PT	0.01uF	50V	E	
C 1086	K22170805	CHIP CAP.	GRM40E102M50PT	0.001uF	50V	E	
C 1087	K22170805	CHIP CAP.	GRM40E102M50PT	0.001uF	50V	E	
C 1089	K22170805	CHIP CAP.	GRM40E102M50PT	0.001uF	50V	E	
C 1090	K22170805	CHIP CAP.	GRM40E102M50PT	0.001uF	50V	E	
C 1091	K76120019	TANTALUM CAP.	TPDN1C100M8S(MXO)	10uF	16V		
C 1092	K22170805	CHIP CAP.	GRM40E102M50PT	0.001uF	50V	E	
C 1093	K22170805	CHIP CAP.	GRM40E102M50PT	0.001uF	50V	E	
C 1094	K76120019	TANTALUM CAP.	TPDN1C100M8S(MXO)	10uF	16V		
C 1095	K22170805	CHIP CAP.	GRM40E102M50PT	0.001uF	50V	E	
C 1096	K46120004	AL. ELECTRO. CAP.	16V.0CM4X7TR2	10uF	16V		
C 1097	K22170805	CHIP CAP.	GRM40E102M50PT	0.001uF	50V	E	
C 1098	K76160027	TANTALUM CAP.	TPDN1V100M8S(MXO)	10uF	35V		
C 1099	K22170817	CHIP CAP.	GRM40E103M50PT	0.01uF	50V	E	
C 1100	K22170817	CHIP CAP.	GRM40B103M50PT	0.01uF	50V	E	
C 1101	K76120019	TANTALUM CAP.	TPDN1C100M8S(MXO)	10uF	16V		
C 1102	K46120004	AL. ELECTRO. CAP.	16V100M4X7TR2	10uF	16V		
C 1104	K46120004	AL. ELECTRO. CAP.	16V100M4X7TR2	10uF	16V		
C 1105	K22170817	CHIP CAP.	GRM40B103M50PT	0.01uF	50V	E	
C 1106	K22170817	CHIP CAP.	GRM40B103M50PT	0.01uF	50V	E	
C 1107	K76120015	TANTALUM CAP.	TPDN1C2R2M8S(MXO)	2.2uF	16V		
C 1108	K76140013	TANTALUM CAP.	TPDN1R010M8S(MXO)	1uF	25V		
C 1109	K22170805	CHIP CAP.	GRM40B102M50PT	0.001uF	50V	E	
C 1110	K22170235	CHIP CAP.	GRM40CH101J50PT	100pF	50V	CH	
C 1111	K22140811	CHIP CAP.	GRM40B104M25PT	0.1uF	25V	E	
C 1112	K22170805	CHIP CAP.	GRM40B102M50PT	0.001uF	50V	E	
C 1113	K46120010	AL. ELECTRO. CAP.	RC2-16V470M-C34(5X7)	47uF	16V		
C 1114	K22170805	CHIP CAP.	GRM40E102M50PT	0.001uF	50V	E	
C 1115	K22170805	CHIP CAP.	GRM40E102M50PT	0.001uF	50V	E	
C 1116	K22140811	CHIP CAP.	GRM40E104M25PT	0.1uF	25V	E	
C 1117	K40149037	AL. ELECTRO. CAP.	RE2-25V471M	470uF	25V		
C 1118	K40129067	AL. ELECTRO. CAP.	RE3-16V102MS	1000uF	16V		

MAIN UNIT PARTS LIST

REF	YA3SU P/N	DESCRIPTION	MFR'S DESIG.	VALUE	WV	TOL.	VERS.
C 1119	K22170817	CHIP CAP.	GRM4CB103M50PT	0.01uF	50V	B	
C 1120	K22140811	CHIP CAP.	GRM4CB104M25PT	0.1uF	25V	B	
C 1121	K22170817	CHIP CAP.	GRM4CB103M50PT	0.01uF	50V	B	
C 1122	K22170821	CHIP CAP.	GRM4CB223M50PT	0.022uF	50V	B	
C 1123	K46120C10	AL. ELECTRO. CAP.	3C2-16V470M-T34 (5X7)	47uF	16V		
C 1125	K22170223	CHIP CAP.	GRM4CCH330J50PT	33pF	50V	CH	
C 1126	K22170225	CHIP CAP.	GRM4CCH390J50PT	39pF	50V	CH	
C 1128	K22170817	CHIP CAP.	GRM4CB103M50PT	0.01uF	50V	B	
C 1129	K22170805	CHIP CAP.	GRM4CB102M50PT	0.001uF	50V	B	
C 1130	K22170805	CHIP CAP.	GRM4CB102M50PT	0.001uF	50V	B	
C 1131	K22140811	CHIP CAP.	GRM4CB104M25PT	0.1uF	25V	B	
C 1132	K22170211	CHIP CAP.	GRM4CCH100D50PT	10pF	50V	CH	
C 1133	K22170805	CHIP CAP.	GRM4CB102M50PT	0.001uF	50V	B	
C 1134	K22170805	CHIP CAP.	GRM4CB102M50PT	0.001uF	50V	B	
C 1135	K22170817	CHIP CAP.	GRM4CB103M50PT	0.01uF	50V	B	
C 1136	K46120C04	AL. ELECTRO. CAP.	16V10COM4X7TR2	10uF	16V		
C 1137	K22140811	CHIP CAP.	GRM4CB104M25PT	0.1uF	25V	B	
C 1138	K22140811	CHIP CAP.	GRM4CB104M25PT	0.1uF	25V	B	
C 1139	K19149C21	CERAMIC CAP.	JAT08X473K-L45AE	0.047uF	25V	X	
C 1140	K22170805	CHIP CAP.	GRM4CB102M50PT	0.001uF	50V	B	
C 1141	K76120C15	TANTALUM CAP.	TPDN1C2R2M8S(MXC)	2.2uF	16V		
C 1142	K19149C29	CERAMIC CAP.	JAT0EV103K-L45AC	0.01uF	25V	V	
C 1143	K19149C09	CERAMIC CAP.	JAT0EX472K-L05AE	0.0047uF	25V	X	
C 1144	K22170805	CHIP CAP.	GRM4CB102M50PT	0.001uF	50V	B	
C 1145	K22170805	CHIP CAP.	GRM4CB102M50PT	0.001uF	50V	B	
C 1146	K22170219	CHIP CAP.	GRM4CCH220J50PT	22pF	50V	CH	
C 1150	K22170223	CHIP CAP.	GRM4CCH330J50PT	33pF	50V	CH	
C 1151	K22170211	CHIP CAP.	GRM4CCH100D50PT	10pF	50V	CH	
C 1152	K22275212	CHIP CAP.	GRM42-2CH090J50CPT	9pF	500V	CH	
C 1153	K22275213	CHIP CAP.	GRM42-2CH100D50CPT	10pF	500V	CH	
C 1155	K22170805	CHIP CAP.	GRM4CB102M50PT	0.001uF	50V	B	
C 1157	K22170217	CHIP CAP.	GRM4CCH180J50PT	18pF	50V	CH	
C 1158	K22170813	CHIP CAP.	GRM4CB472M50PT	0.0047uF	50V	B	
C 1159	K22140811	CHIP CAP.	GRM4CB104M25PT	0.1uF	25V	B	
C 1160	K22140811	CHIP CAP.	GRM4CB104M25PT	0.1uF	25V	B	
C 1161	K73160C17	TANTALUM CAP.	TPDN1VR22M8S(MXC)	0.22uF	35V		
C 1162	K73120C10	TANTALUM CHIP CAP.	TESV621C335M8R	3.3uF	16V		
CD1001	H7300180	CERAMIC DISC	CDB455C7				
CF1001	H39002C2	CERAMIC FILTER	CFW455F				
D 1001	G2090337	DIODE	M1308				
D 1002	G2090337	DIODE	M1308				
D 1003	G2070092	DIODE	HVU2C2-10TRP				
D 1004	G2070092	DIODE	HVU2C2-10TRP				
D 1005	G2070092	DIODE	HVU2C2-10TRP				
D 1006	G2070092	DIODE	HVU2C2-10TRP				
D 1007	G2070092	DIODE	HVU2C2-10TRP				
D 1008	G2070092	DIODE	HVU2C2-10TRP				
D 1009	G2070092	DIODE	HVU2C2-10TRP				
D 1010	G2070092	DIODE	HVU2C2-10TRP				
D 1012	G2070003	DIODE	ISS226 TE85R				
D 1014	G2070062	DIODE	J2C25.1Y TE85R				
D 1015	Q9000534	SURGE ABSORBER	P6KE18				
D 1016	G2090335	DIODE	M1407				
D 1017	G2090337	DIODE	ISS108				

MAIN UNIT PARTS LIST

REF	YAESU P/N	DESCRIPTION	MFR'S DESIG.	VALUE	WV	TOL.	VERS.
D 1018	G2060004	DIODE	1SS270TJ				
D 1019	G2060004	DIODE	1SS270TJ				
D 1020	G2070C09	DIODE	1SS184 TE85R				
D 1022	G2070C48	DIODE	1SS272 TE85R				
J 10C1	P3090667	CONNECTOR	B3B-EH				
J 10C2	P3090787	CONNECTOR	IMSA-1068-142040				
J 10C3	P3090833	CONNECTOR	IMSA-1068-072040				
J 10C4	P3090821	CONNECTOR	SC25-02WS				
L 1002	L0022052	COIL	1.578.0D1.2UEW R				
L 1003	L0021835A	COIL	2.576.0D0.8UEW R				
L 1004	L0190166	COIL	S7-T2 R12-K869C				
L 1005	L1190342	M. RFC	LAL02KRR22M	0.22uH			
L 1006							
L 1008	L1190352	M. RFC	LAL02KRR47M	0.47uH			
L 1009	L0190167	COIL	S7-T2 R12-K869E				
L 1010	L1190390	M. RFC	LAL03KH102K	1nH			
L 1012	L1190095	M. RFC	LAL04NA4R7K	4.7uH			
L 1013	L0022052	COIL	1.578.0D1.2UEW R				
L 1014	L0022051	COIL	2.576.0D1.2UEW R				
L 1015	L0020751	COIL	8.574.0D0.3UEW R				
L 1016	L0020751	COIL	8.574.0D0.3UEW R				
L 1017	L0021359	COIL	1.573.5D0.3UEW R				
L 1018	L0021811A	COIL	2.573.0D0.3UEW R				
L 1019	L0020679	COIL	4.573.5D0.3UEW R				
L 1020	L0021811A	COIL	2.573.0D0.3UEW R				
L 1021	L0020679	COIL	4.573.5D0.3UEW R				
L 1022	L0020679	COIL	4.573.5D0.3UEW R				
L 1023	L1190188	M. RFC	LAL03NAR22M	0.22uF			
Q 1001	G4801317B	FET	3SK131-T2B V12				
Q 1002	G3803027G	FET	2SK302GR TE85R				
Q 1003	G3803027G	FET	2SK302GR TE85R				
Q 1004	G3327147Y	TRANSISTOR	2SC2714YTE85R				
Q 1005	G3327597B	TRANSISTOR	2SC2759-T2B J22				
Q 1006	G3070027	TRANSISTOR	1MH5 T108				
Q 1007	G3327127G	TRANSISTOR	2SC2712GR TE85R				
Q 1008	G1091108	IC	MC3372ML				
Q 1009	G1091018	IC	S-AV24				
Q 1010	G3325380	TRANSISTOR	2SC2538				
Q 1011	G3070056	TRANSISTOR	MMB3951LT1				
Q 1012	G3327597B	TRANSISTOR	2SC2759-T2B U22				
Q 1013	G1091146	IC	AN6541				
Q 1014	G3327127G	TRANSISTOR	2SC2712GR TE85R				
Q 1015	G3209360S	TRANSISTOR	2SB986S				
Q 1016	G3327127G	TRANSISTOR	2SC2712GR TE85R				
Q 1017	G3070008	TRANSISTOR	FMS1 T96				
Q 1018	G3070024	TRANSISTOR	IMX1 T110				
Q 1019	G3209860S	TRANSISTOR	2SB986S				
Q 1020	G3070010	TRANSISTOR	DTA143EX T96				
Q 1021	G3070027	TRANSISTOR	1MH5 T108				
Q 1022	G3070010	TRANSISTOR	DTA143EX T96				
Q 1023	G1C90815	IC	TDA2003H				
Q 1024	G1C91105	IC	MC145158F2L				
Q 1025	G1C91103	IC	MC12022SLADR2				
Q 1026	G3070059	TRANSISTOR	IMX3 T108				

MAIN UNIT PARTS LIST

REF	YAESU P/N	DESCRIPTION	MFR'S DESIG.	VALUE	WV	TOL.	VERS.
Q 1027	G307006C	TRANSISTOR	1M22 T108				
Q 1028	G3327.47Y	TRANSISTOR	2SC2714YTE35R				
R 1001	J24205225	CHIP RES.	RMC1/10T 225J	2.2M	1/10W		
R 1002	J24205225	CHIP RES.	RMC1/10T 225J	2.2M	1/10W		
R 1003	J24205154	CHIP RES.	RMC1/10T 154J	150K	1/10W		
R 1004	J24205223	CHIP RES.	RMC1/10T 223J	22K	1/10W		
R 1005	J24205183	CHIP RES.	RMC1/10T 183J	18K	1/10W		
R 1006	J24205223	CHIP RES.	RMC1/10T 223J	22K	1/10W		
R 1007	J24205470	CHIP RES.	RMC1/10T 470J	47	1/10W		
R 1008	J24205102	CHIP RES.	RMC1/10T 102J	1K	1/10W		
R 1009	J24205101	CHIP RES.	RMC1/10T 101J	100	1/10W		
R 1010	J24205225	CHIP RES.	RMC1/10T 225J	2.2M	1/10W		
R 1011	J24205225	CHIP RES.	RMC1/10T 225J	2.2M	1/10W		
R 1012	J24205470	CHIP RES.	RMC1/10T 470J	47	1/10W		
R 1014	J24205221	CHIP RES.	RMC1/10T 221J	220	1/10W		
R 1015	J24205100	CHIP RES.	RMC1/10T 100J	10	1/10W		
R 1016	J24205000	CHIP RES.	RMC1/10T 000J	0	1/10W		
R 1017	J24205821	CHIP RES.	RMC1/10T 821J	820	1/10W		
R 1018	J24205104	CHIP RES.	RMC1/10T 104J	100K	1/10W		
R 1019	J24205221	CHIP RES.	RMC1/10T 221J	220	1/10W		
R 1020	J24205221	CHIP RES.	RMC1/10T 221J	220	1/10W		
R 1021	J24205102	CHIP RES.	RMC1/10T 102J	1K	1/10W		
R 1022	J24205101	CHIP RES.	RMC1/10T 101J	100	1/10W		
R 1023	J24205150	CHIP RES.	RMC1/10T 150J	15	1/10W		
R 1024	J24205102	CHIP RES.	RMC1/10T 102J	1K	1/10W		
R 1025	J24205472	CHIP RES.	RMC1/10T 472J	4.7K	1/10W		
R 1026	J24205270	CHIP RES.	RMC1/10T 270J	27	1/10W		
R 1027	J24205471	CHIP RES.	RMC1/10T 471J	470	1/10W		
R 1028	J24205563	CHIP RES.	RMC1/10T 563J	56K	1/10W		
R 1030	J24205223	CHIP RES.	RMC1/10T 223J	22K	1/10W		
R 1031	J24205474	CHIP RES.	RMC1/10T 474J	470K	1/10W		
R 1032	J24205824	CHIP RES.	RMC1/10T 824J	820K	1/10W		
R 1033	J24205474	CHIP RES.	RMC1/10T 474J	470K	1/10W		
R 1034	J24205472	CHIP RES.	RMC1/10T 472J	4.7K	1/10W		
R 1035	J24205394	CHIP RES.	RMC1/10T 394J	390K	1/10W		
R 1036	J24205472	CHIP RES.	RMC1/10T 472J	4.7K	1/10W		
R 1037	J24205103	CHIP RES.	RMC1/10T 103J	10K	1/10W		
R 1038	J24205103	CHIP RES.	RMC1/10T 103J	10K	1/10W		
R 1039	J24205822	CHIP RES.	RMC1/10T 822J	8.2K	1/10W		
R 1040	J24205182	CHIP RES.	RMC1/10T 182J	1.8K	1/10W		
R 1041	J24205221	CHIP RES.	RMC1/10T 221J	220	1/10W		
R 1042	J22335101	METAL FILM RES.	E3G-2S3101	100	2W		
R 1043	J24205102	CHIP RES.	RMC1/10T 102J	1K	1/10W		
R 1044	J24205103	CHIP RES.	RMC1/10T 103J	10K	1/10W		
R 1045	J24205102	CHIP RES.	RMC1/10T 102J	1K	1/10W		
R 1046	J24205472	CHIP RES.	RMC1/10T 472J	4.7K	1/10W		
R 1047	J07245100	CARBON FILM RES.	RJ14TPJ100	10	1/4W		
R 1048	J24205101	CHIP RES.	RMC1/10T 101J	100	1/10W		
R 1049	J24205122	CHIP RES.	RMC1/10T 122J	1.2K	1/10W		
R 1050	J24205390	CHIP RES.	RMC1/10T 390J	39	1/10W		
R 1051	J24205221	CHIP RES.	RMC1/10T 221J	220	1/10W		
R 1052	J24205472	CHIP RES.	RMC1/10T 472J	4.7K	1/10W		
R 1053	J24205470	CHIP RES.	RMC1/10T 470J	47	1/10W		
R 1054	J24205560	CHIP RES.	RMC1/10T 560J	56	1/10W		
R 1055	J24205472	CHIP RES.	RMC1/10T 472J	4.7K	1/10W		
R 1056	J24205102	CHIP RES.	RMC1/10T 102J	1K	1/10W		

MAIN UNIT PARTS LIST

REF	YAESU P/N	DESCRIPTION	MFR'S DESIG.	VALUE	NV	TOL.	VERS.
R 1057	J24205101	CHIP RES.	RMC:/10T 101J	100	1/10W		
R 1058	J24205151	CHIP RES.	RMC:/10T 151J	150	1/10W		
R 1059	J24205221	CHIP RES.	RMC:/10T 221J	220	1/10W		
R 1060	J24205471	CHIP RES.	RMC:/10T 471J	470	1/10W		
R 1061	J24205223	CHIP RES.	RMC:/10T 223J	22K	1/10W		
R 1062	J24205222	CHIP RES.	RMC:/10T 222J	2.2K	1/10W		
R 1063	J24205471	CHIP RES.	RMC:/10T 471J	470	1/10W		
R 1064	J24205104	CHIP RES.	RMC:/10T 104J	100K	1/10W		
R 1067	J24245470	CHIP RES.	RMC:/4 470JACP	47	1/4W		
R 1068	J24245471	CHIP RES.	RMC:/4 471JACP	470	1/4W		
R 1069	J24205223	CHIP RES.	RMC:/10T 223J	22K	1/10W		
R 1070	J24205182	CHIP RES.	RMC:/10T 182J	1.8K	1/10W		
R 1071	J24205152	CHIP RES.	RMC:/10T 152J	1.5K	1/10W		
R 1072	J20306229	METAL FILM RES.	RS1B 1W K	2.2	1W		
R 1073	J24205010	CHIP RES.	RMC:/10T 10J	1	1/10W		
R 1074	J24205221	CHIP RES.	RMC:/10T 221J	220	1/10W		
R 1075	J24205229	CHIP RES.	RMC:/10T 2R2J	2.2	1/10W		
R 1076	J20306010	METAL FILM RES.	RS1B 1W K	1	1W		
R 1077	J24205103	CHIP RES.	RMC:/10T 103J	10K	1/10W		
R 1082	J24205470	CHIP RES.	RMC:/10T 470J	47	1/10W		
R 1083	J24205470	CHIP RES.	RMC:/10T 470J	47	1/10W		
R 1084	J24205472	CHIP RES.	RMC:/10T 472J	4.7K	1/10W		
R 1085	J24205103	CHIP RES.	RMC:/10T 103J	10K	1/10W		
R 1086	J24205153	CHIP RES.	RMC:/10T 153J	15K	1/10W		
R 1087	J24205472	CHIP RES.	RMC:/10T 472J	4.7K	1/10W		
R 1088	J24205100	CHIP RES.	RMC:/10T 100J	10	1/10W		
R 1089	J24205471	CHIP RES.	RMC:/10T 471J	470	1/10W		
R 1090	J24205122	CHIP RES.	RMC:/10T 122J	1.2K	1/10W		
R 1091	J24205000	CHIP RES.	RMC:/10T 000J	0	1/10W		
R 1092	J24205471	CHIP RES.	RMC:/10T 471J	470	1/10W		
R 1093	J24205561	CHIP RES.	RMC:/10T 561J	560	1/10W		
R 1094	J24205472	CHIP RES.	RMC:/10T 472J	4.7K	1/10W		
R 1095	J24205561	CHIP RES.	RMC:/10T 561J	560	1/10W		
R 1096	J24205225	CHIP RES.	RMC:/10T 225J	2.2M	1/10W		
R 1097	J24205102	CHIP RES.	RMC:/10T 102J	1K	1/10W		
R 1098	J24205560	CHIP RES.	RMC:/10T 560J	56	1/10W		
R 1099	J24205822	CHIP RES.	RMC:/10T 822J	8.2K	1/10W		
R 1100	J24205822	CHIP RES.	RMC:/10T 822J	8.2K	1/10W		
R 1101	J24205471	CHIP RES.	RMC:/10T 471J	470	1/10W		
R 1102	J24205101	CHIP RES.	RMC:/10T 101J	100	1/10W		
R 1103	J24205103	CHIP RES.	RMC:/10T 103J	10K	1/10W		
R 1104	J24205222	CHIP RES.	RMC:/10T 222J	2.2K	1/10W		
R 1105	J24205101	CHIP RES.	RMC:/10T 101J	100	1/10W		
R 1106	J24205150	CHIP RES.	RMC:/10T 150J	15	1/10W		
R 1110	J24205470	CHIP RES.	RMC:/10T 470J	47	1/10W		
R 1111	J24205151	CHIP RES.	RMC:/10T 151J	150	1/10W		
R 1112	J24205102	CHIP RES.	RMC:/10T 102J	1K	1/10W		
R 1115	J24205223	CHIP RES.	RMC:/10T 223J	22K	1/10W		
R 1116	J24205181	CHIP RES.	RMC:/10T 181J	180	1/10W		
R 1117	J24205331	CHIP RES.	RMC:/10T 331J	330	1/10W		
R 1118	J24205471	CHIP RES.	RMC:/10T 471J	470	1/10W		
R 1120	J24205182	CHIP RES.	RMC:/10T 182J	1.8K	1/10W		
R 1121	J24205473	CHIP RES.	RMC:/10T 473J	47K	1/10W		
R 1122	J24205223	CHIP RES.	RMC:/10T 223J	22K	1/10W		
R 1123	J24245331	CHIP RES.	RMC:/4 331JACP	330	1/4W		
R 1124	J24205000	CHIP RES.	RMC:/10T 000J	0	1/10W		
R 1125	J24205000	CHIP RES.	RMC:/10T 000J	0	1/10W		

MAIN UNIT PARTS LIST

REF	YAESU P/N	DESCRIPTION	MFGR'S DESIG.	VALUE	WV	TOL.	VERS.
T 1001	L0022053	COIL	160M R12-K905X				
T 1002	L0022055	COIL	160M R12-K907X				
T 1003	L0022054	COIL	160M R12 K908X				
T 1004	L0022056	COIL	160M R12-K906X				
T 1005	L0190173	COIL	456DB-1007				
T 1006	L0022111	COIL	21.4M				
TC1001	K91000071	TRIMMER CAP.	TZ03R200ER	20PF	20p		
VR1001	J51745473	POT.	H0651A017-47KB	47KB			
X 1001	H0102816	XTAL	HC-49/T	20.945MHZ			
X 1002	H0102801	XTAL	EC-49/T	12.800MHZ			
XF1001	H1102095	XTAL	21M153U				
XF1002	H1102095	XTAL	21M153U				
	R013579J	SHIELD CASE					
	R013680J	LEAF SPRING					
	R312953J	XTAL HOLDER (2 pcs)					

UNIT PARTS LAYOUT

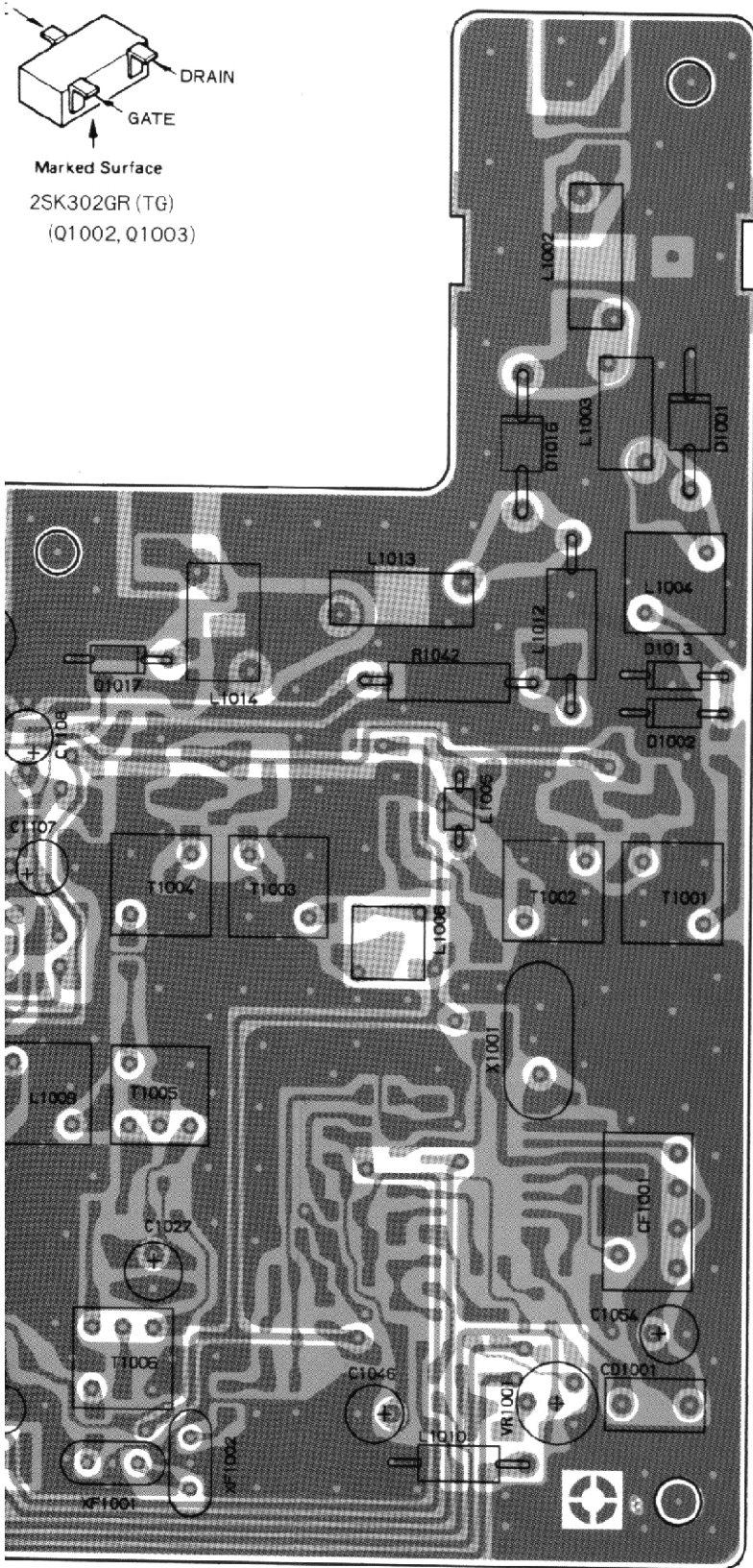

Obverse View of Leaded Component Side

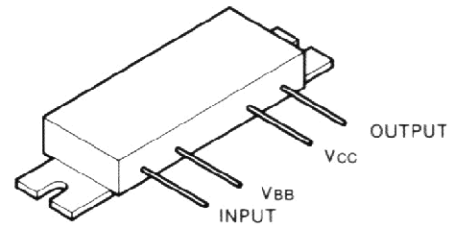

S-AV24
(Q1009)

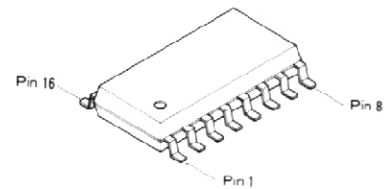

MC145158F2
(Q1024)
MC3372M
(Q1008)

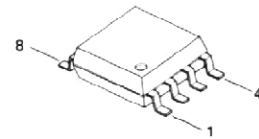

MC12022SLAD
(Q1025)

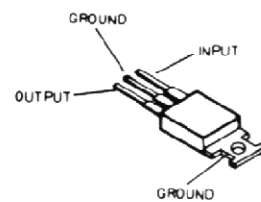

AN6541
(Q1013)

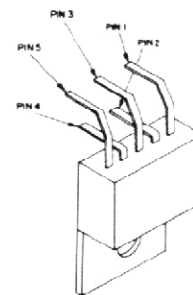

TDA2003H
(Q1023)

PARTS LAYOUT

LECTOR(Tr₂)
(Tr₁)
TOR(Tr₁)

lector (OUT)

e (IK)
lector (OUT)

AM

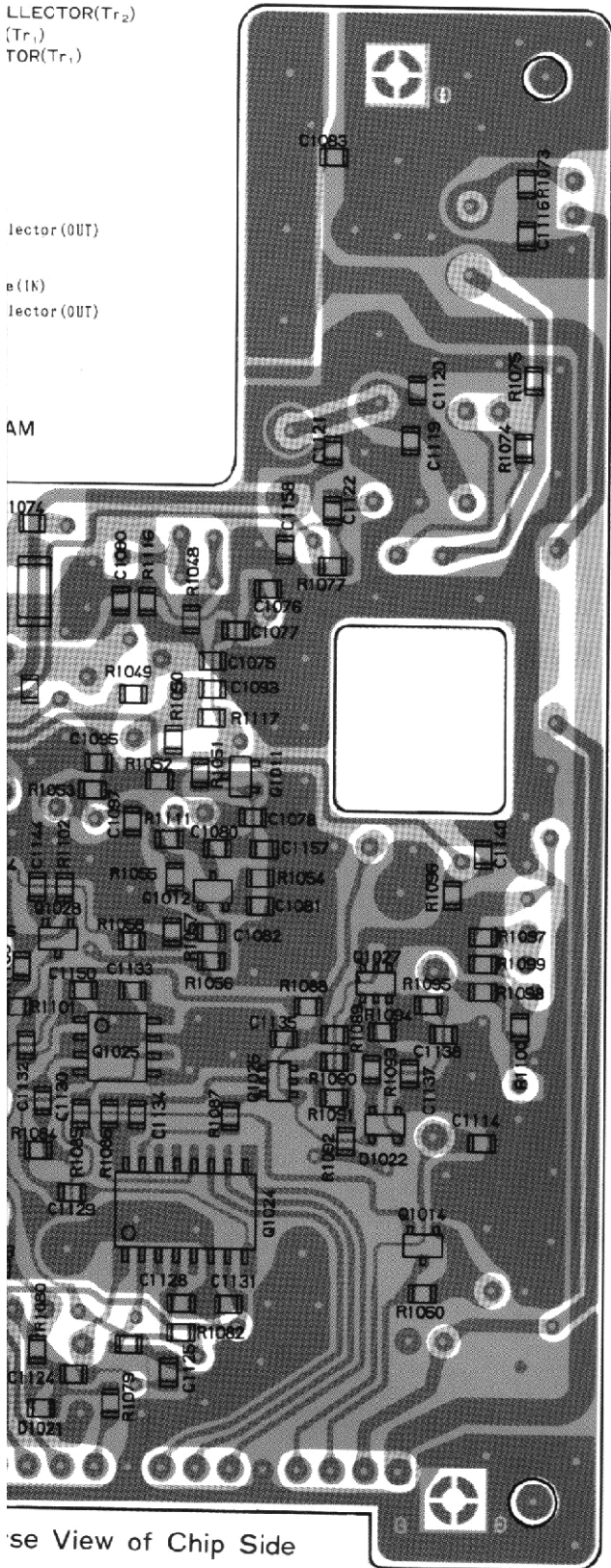

se View of Chip Side

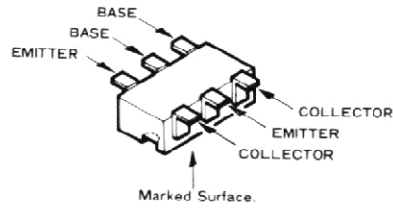

IMX3 (X3)
(Q1026)

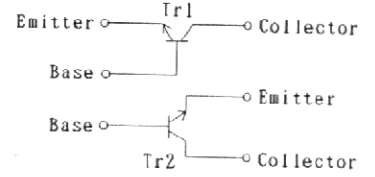

IMX3 CIRCUIT DIAGRAM

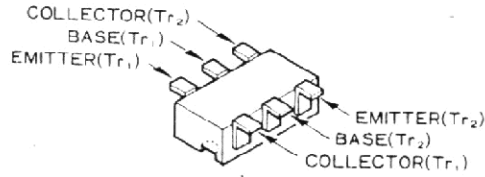

Marked Surface
IMZ2 (Z2)
(Q1027)

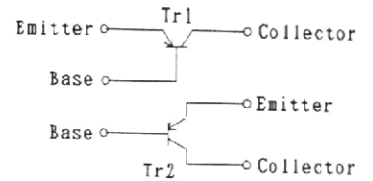

IMZ2 CIRCUIT DIAGRAM

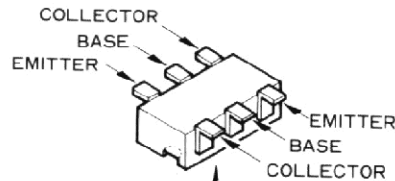

Marked Surface
IMX1 (X1)
(Q1018)

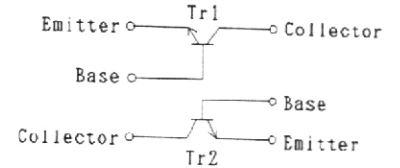

IMX1 CIRCUIT DIAGRAM

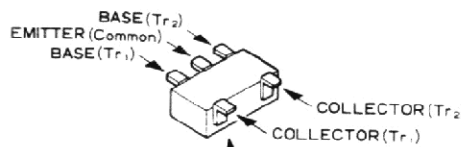

Marked Surface
FMS1 (S1)
(Q1017)

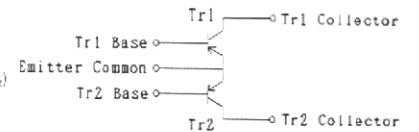

FMS1 CIRCUIT DIAGRAM

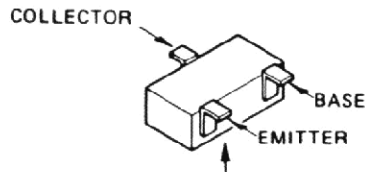

Marked Surface
DTA143EK (3C)
(Q1020, Q1022)

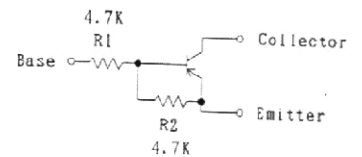

DTA143EK CIRCUIT DIAGRAM

MAIN UNIT PART



25C2538
(Q1010)

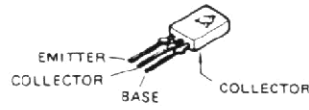

2SB986S
(Q1015, Q1019)

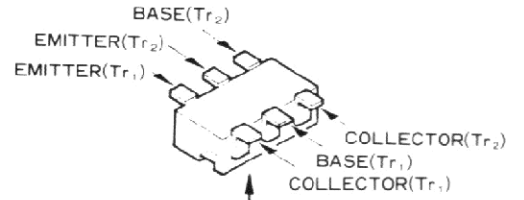

Marked Surface

IMH5 (H5)
(Q1006, Q1021)

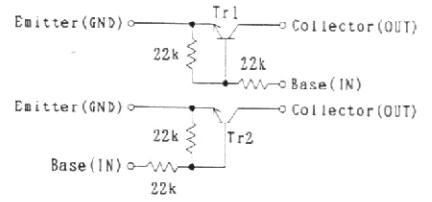

IMH5 CIRCUIT DIAGRAM

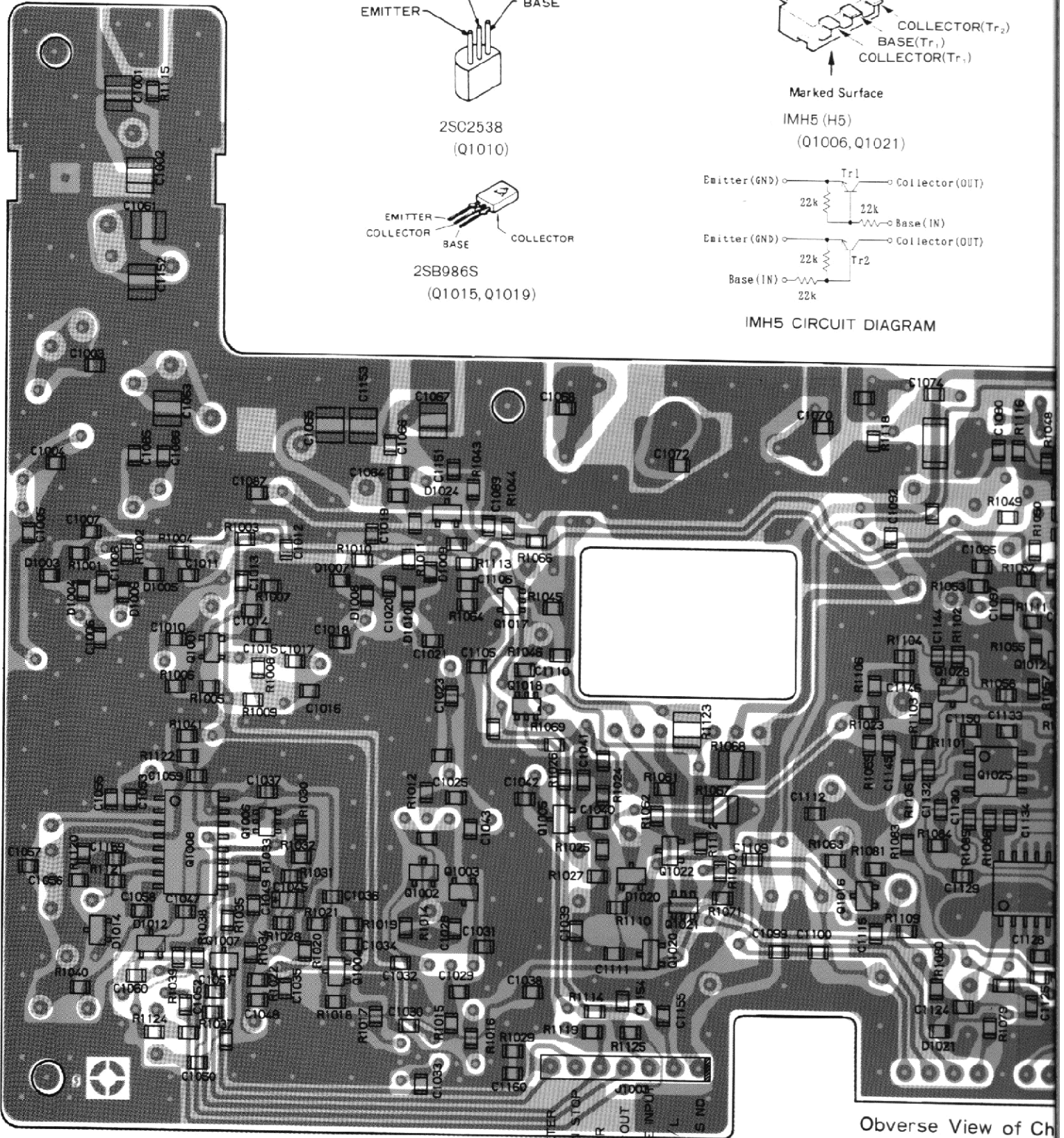

Obverse View of Ch

- 5-METER
- SCAN STOP
- SQ VR
- DISC OUT
- NOISE INPUT
- H/M/L
- 13.8V 5 ND

MIC UNIT PARTS LIST

REF	YAESU P/N	DESCRIPTION	MFGR'S DESIG.	VALUE	WV	TOL.	VERS.
*** MIC-UNIT ***							
	CA05100C1	P.C.B. W COMP.					
	F3227102R	P.C.B. W/O COMP.					
C 1501	K22174235	CHIP CAP.	G3M39CH101J50PT	100pF	50V	CH	
C 1502	K22174235	CHIP CAP.	G3M39CH101J50PT	100pF	50V	CH	
C 1503	K22174235	CHIP CAP.	G3M39CH101J50PT	100pF	50V	CH	
C 1504	K22174235	CHIP CAP.	G3M39CH101J50PT	100pF	50V	CH	
C 1505	K22174235	CHIP CAP.	G3M39CH101J50PT	100pF	50V	CH	
C 1506	K22174235	CHIP CAP.	G3M39CH101J50PT	100pF	50V	CH	
C 1507	K22174235	CHIP CAP.	G3M39CH101J50PT	100pF	50V	CH	
C 1508	K22174235	CHIP CAP.	G3M39CH101J50PT	100pF	50V	CH	
J 1501	P1030677	CONNECTOR	R41-2736H				

MIC UNIT PARTS LAYOUT/CIRCUIT DIAGRAM

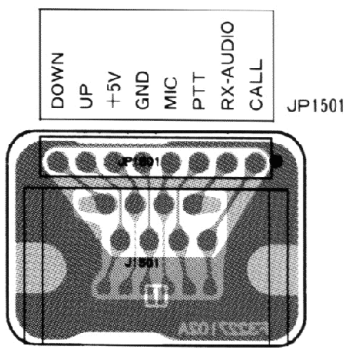

Obverse View of Connector Side

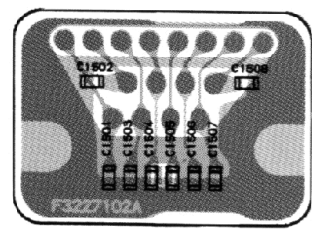

Obverse View of Chip Side

F3227102A

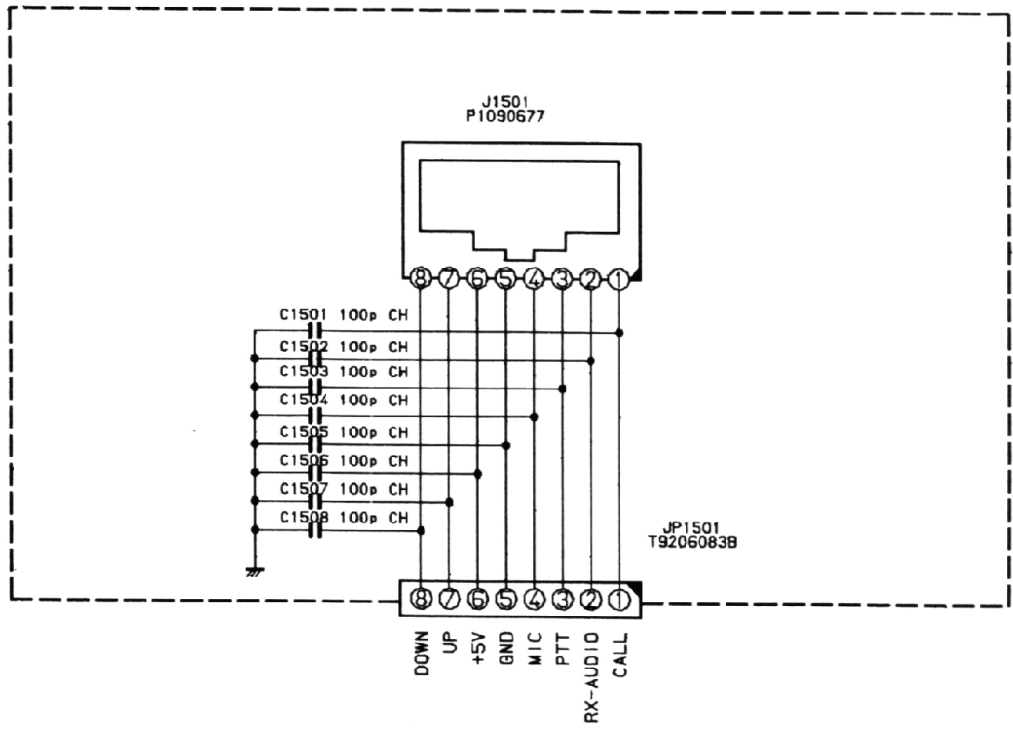

CNTL UNIT PARTS LIST

REF	YAESU P/N	DESCRIPTION	MFR'S DESIG.	VALUE	WV	TOL.	VERS.
*** CNTL-UNIT ***							
	CA0509001	P. C. B. W COMP.					TYP A2
	CA0509002	P. C. B. W COMP.					TYP A3
	CA0509003	P. C. B. W COMP.					TYP B3
	CA0509004	P. C. B. W COMP.					TYP B1
	F3227101B	P. C. B. W/O COMP.					
BT2001	Q9000552	LITHIUM BATTERY	CR2016-TS1				
C 2001	K22140811	CHIP CAP.	GRM40E104M25PT	0.1uF	25V	E	
C 2002	K221748C7	CHIP CAP.	GRM39E681M50PT	680pF	50V	E	
C 2003	K221448C2	CHIP CAP.	GRM39E103M25PT	0.01uF	25V	E	
C 2004	K22174235	CHIP CAP.	GRM39CH101J50PT	100pF	50V	CH	
C 2005	K22174235	CHIP CAP.	GRM39CH101J50PT	100pF	50V	CH	
C 2006	K22174235	CHIP CAP.	GRM39CH101J50PT	100pF	50V	CH	
C 2007	K22174235	CHIP CAP.	GRM39CH101J50PT	100pF	50V	CH	
C 2008	K221748C9	CHIP CAP.	GRM39E102M50PT	0.001uF	50V	B	
C 2009	K221748C9	CHIP CAP.	GRM39E102M50PT	0.001uF	50V	B	
C 2010	K221748C9	CHIP CAP.	GRM39E102M50PT	0.001uF	50V	B	
C 2011	K221748C9	CHIP CAP.	GRM39E102M50PT	0.001uF	50V	B	
C 2012	K221748C9	CHIP CAP.	GRM39E102M50PT	0.001uF	50V	B	
C 2013	K221748C9	CHIP CAP.	GRM39E102M50PT	0.001uF	50V	B	
C 2014	K22174219	CHIP CAP.	GRM39CH220J50PT	22pF	50V	CH	
C 2015	K22174219	CHIP CAP.	GRM39CH220J50PT	22pF	50V	CH	
C 2016	K781200C9	TANTALUM CHIP CAP.	TESVA1C105M1-8R	1uF	16V		
C 2017	K221748C9	CHIP CAP.	GRM39E102M50PT	0.001uF	50V	B	
C 2018	K78080019	TANTALUM CHIP CAP.	TEMSVB20J106M-8R	10uF	6.3V		
C 2019	K221748C9	CHIP CAP.	GRM39E102M50PT	0.001uF	50V	B	
C 2022	K221748C9	CHIP CAP.	GRM39E102M50PT	0.001uF	50V	B	
C 2023	K78080019	TANTALUM CHIP CAP.	TEMSVB20J106M-8R	10uF	6.3V		
C 2024	K78120011	TANTALUM CHIP CAP.	TESVC1C106M12R	10uF	16V		
C 2026	K78120011	TANTALUM CHIP CAP.	TESVC1C106M12R	10uF	16V		
C 2027	K221748C9	CHIP CAP.	GRM39E102M50PT	0.001uF	50V	B	
C 2028	K221748C9	CHIP CAP.	GRM39E102M50PT	0.001uF	50V	B	
C 2029	K78080019	TANTALUM CHIP CAP.	TEMSVB2CJ106M-8R	10uF	6.3V		
C 2030	K22174235	CHIP CAP.	GRM39CH101J50PT	100pF	50V	CH	
C 2031	K22174235	CHIP CAP.	GRM39CH101J50PT	100pF	50V	CH	
C 2032	K22174235	CHIP CAP.	GRM39CH101J50PT	100pF	50V	CH	
C 2033	K22174235	CHIP CAP.	GRM39CH101J50PT	100pF	50V	CH	
C 2034	K22174235	CHIP CAP.	GRM39CH101J50PT	100pF	50V	CH	
C 2035	K78100009	TANTALUM CHIP CAP.	TESVA1A155M1-8R	1.5	10V		
C 2037	K221748C9	CHIP CAP.	GRM39E102M50PT	0.001uF	50V	B	
C 2038	K78120011	TANTALUM CHIP CAP.	TESVC1C106M12R	10uF	16V		
C 2040	K22174235	CHIP CAP.	GRM39CH101J50PT	100pF	50V	CH	
C 2041	K78160027	TANTALUM CHIP CAP.	TESVA1V224M1-8R	0.22uF	35V		
C 2042	K40129063	AL. ELECTRO. CAP.	RE3-16V101M	100uF	16V		
C 2043	K40109028	AL. ELECTRO. CAP.	UVR1A101MCA6	100uF	10V		
CS2001	G9090056	CDS P2137-01	P2137-01				
D 2001	G2070158	DIODE	RB471E T148				
D 2002	G2070309	DIODE	ISS184 TE85R				
D 2010	G2090251	DIODE	HZ11C1				
D 2011	G2090306	DIODE	10E1				
D 2012	G2070026	DIODE	ISS196 TE85R				

CNTL UNIT PARTS LIST

REF	YAESU P/N	DESCRIPTION	MFR'S DESIG.	VALUE	WV	TOL.	VERS.
DS2001	G6090086	LCD	FTD-10262 (SP-2E)				
J 2001	P0090861	CONNECTOR	B13B-2R				
J 2003	P0090782	CONNECTOR	B12B-2R				
J 2004	P0090782	CONNECTOR	B12R-2R				
JP1501	T9206083	WIRE-ASSY					
PL2001	Q1000065	LAMP	9V		9V		
PL2002	Q1000065	LAMP	9V		9V		
PL2003	Q1000065	LAMP	9V		9V		
PL2004	Q1000065	LAMP	9V		9V		
Q 2001	G1091338	IC	HD4074719H HY-102				
Q 2002	G1090830	IC	LC7582				
Q 2003	G1091144	IC	NJU72C1U50 TE2				
Q 2004	G1090966	IC	RH5VA45AA-T1				
Q 2005	G3070033	TRANSISTOR	DTC144EK T97				
Q 2006	G3070026	TRANSISTOR	1MD2 T108				
Q 2007	G3111627G	TRANSISTOR	ZSA11E2GR TE85R				
Q 2009	G1090589	IC	NJM29C4M				
Q 2010	G3213017Q	TRANSISTOR	2SB13C1-T2 ZQ				
Q 2011	G3327127G	TRANSISTOR	2SC2712GR TE85R				
Q 2012	G3070033	TRANSISTOR	DTC144EK T97				
Q 2013	G1091144	IC	NJU72C1U50 TE2				
Q 2014	G341033CK	TRANSISTOR	2SD1033K				
Q 2015	G3070061	TRANSISTOR	FHG4 T148				
Q 2018	G3213017Q	TRANSISTOR	2SB13C1-T2 ZQ				
R 2001	J24185823	CHIP RES.	RMC1/16 823JATP	82K		1/16W	
R 2002	J24185393	CHIP RES.	RMC1/16 393JATP	39K		1/16W	
R 2003	J24185223	CHIP RES.	RMC1/16 223JATP	22K		1/16W	
R 2004	J241851C3	CHIP RES.	RMC1/16 103JATP	10K		1/16W	
R 2005	J241851C3	CHIP RES.	RMC1/16 103JATP	10K		1/16W	
R 2006	J24185472	CHIP RES.	RMC1/16 472JATP	4.7K		1/16W	
R 2007	J24185473	CHIP RES.	RMC1/16 473JATP	47K		1/16W	
R 2008	J24185472	CHIP RES.	RMC1/16 472JATP	4.7K		1/16W	
R 2009	J24185473	CHIP RES.	RMC1/16 473JATP	47K		1/16W	
R 2010	J241851C2	CHIP RES.	RMC1/16 102JATP	1K		1/16W	
R 2011	J241851C2	CHIP RES.	RMC1/16 102JATP	1K		1/16W	
R 2012	J241851C2	CHIP RES.	RMC1/16 102JATP	1K		1/16W	
R 2013	J241851C2	CHIP RES.	RMC1/16 102JATP	1K		1/16W	
R 2014	J241851C2	CHIP RES.	RMC1/16 102JATP	1K		1/16W	
R 2015	J241851C2	CHIP RES.	RMC1/16 102JATP	1K		1/16W	
R 2016	J241851C2	CHIP RES.	RMC1/16 102JATP	1K		1/16W	
R 2017	J241851C2	CHIP RES.	RMC1/16 102JATP	1K		1/16W	
R 2018	J241851C2	CHIP RES.	RMC1/16 102JATP	1K		1/16W	
R 2019	J241851C2	CHIP RES.	RMC1/16 102JATP	1K		1/16W	
R 2020	J241851C2	CHIP RES.	RMC1/16 102JATP	1K		1/16W	
R 2021	J241851C3	CHIP RES.	RMC1/16 103JATP	10K		1/16W	
R 2022	J241851C4	CHIP RES.	RMC1/16 104JATP	100K		1/16W	
R 2023	J241851C3	CHIP RES.	RMC1/16 103JATP	10K		1/16W	
R 2024	J241851C4	CHIP RES.	RMC1/16 104JATP	100K		1/16W	
R 2025	J24185221	CHIP RES.	RMC1/16 221JATP	220		1/16W	
R 2026	J24185225	CHIP RES.	RMC1/16 225JATP	2.2M		1/16W	
R 2027	J241851C2	CHIP RES.	RMC1/16 102JATP	1K		1/16W	

CNTL UNIT PARTS LIST

REF	YAESU P/N	DESCRIPTION	MFGR'S DESIG.	VALUE	WV	TOL.	VERS.
R 20E9	J2418E103	CHIP RES.	RMC1/16 103JATP	10K	1/16W		
R 21C0	J2418E472	CHIP RES.	RMC1/16 472JATP	4.7K	1/16W		
R 21C3	J2418E224	CHIP RES.	RMC1/16 224JATP	220K	1/16W		
R 21C4	J2418E224	CHIP RES.	RMC1/16 224JATP	220K	1/16W		
R 21C5	J2418E224	CHIP RES.	RMC1/16 224JATP	220K	1/16W		
R 21C6	J2418E224	CHIP RES.	RMC1/16 224JATP	220K	1/16W		
R 21C7	J2418E224	CHIP RES.	RMC1/16 224JATP	220K	1/16W		
R 21C8	J2418E224	CHIP RES.	RMC1/16 224JATP	220K	1/16W		
R 21C9	J2418E102	CHIP RES.	RMC1/16 102JATP	1K	1/16W		
R 2110	J2418E103	CHIP RES.	RMC1/16 103JATP	10K	1/16W		
S 2001	Q9000395	ROTARY ENCODER	EVQ-WWNF1524B				
S 2002	N5090024	TACT SWITCH	SKHLAA				
S 2003	N5090024	TACT SWITCH	SKHLAA				
S 2004	N5090024	TACT SWITCH	SKHLAA				
S 2005	N5090024	TACT SWITCH	SKHLAA				
S 2006	N5090024	TACT SWITCH	SKHLAA				
S 2007	N5090024	TACT SWITCH	SKHLAA				
S 2008	N5090024	TACT SWITCH	SKHLAA				
S 2009	N5090024	TACT SWITCH	SKHLAA				
S 2010	N5090024	TACT SWITCH	SKHLAA				
S 2011	N5090024	TACT SWITCH	SKHLAA				
S 2014	N5090024	TACT SWITCH	SKHLAA				
VR2001	J50800143	POT.	RK09K1130	20KA			
VR2002	J50800142	POT.	RK09K1130	20KA			
X 2001	H0102984	X'AL	HC-49U/S	4.000MHZ			
	R3139660	LAMP HOLDER (4 pcs)					
	R3516430	METAL HOLDER					
	R3516440	LAMP GUIDE					
	R3516450	LCD HOLDER					
	R7139670	REFLECTOR					
	R7140070	SHEET (A)					
	R7140080	SHEET (B)					
	R8118690	SEAL OZO					
	R7076390	X'AL SPACER					
	S6000242	LED SPACER	LH-5-9				

PARTS LAYOUT

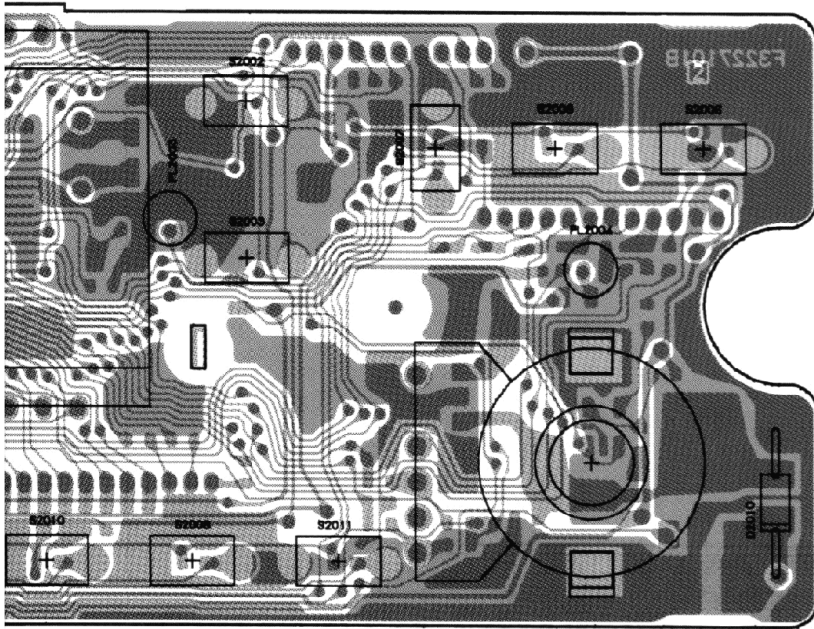

Reverse View of Leaded Component Side

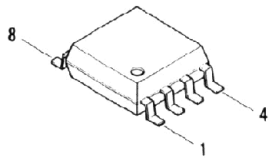

NJM2904
(Q2009)

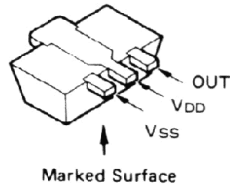

NJU7201 U50 (J1)
(Q2003, Q2013)
RH5VA45AA (D5)
(Q2004)

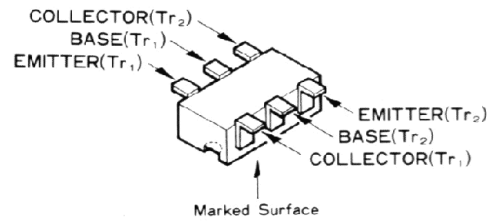

IMD2 (D2)
(Q2006)

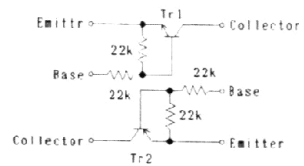

IMD2 CIRCUIT DIAGRAM

CNTL UNIT PARTS

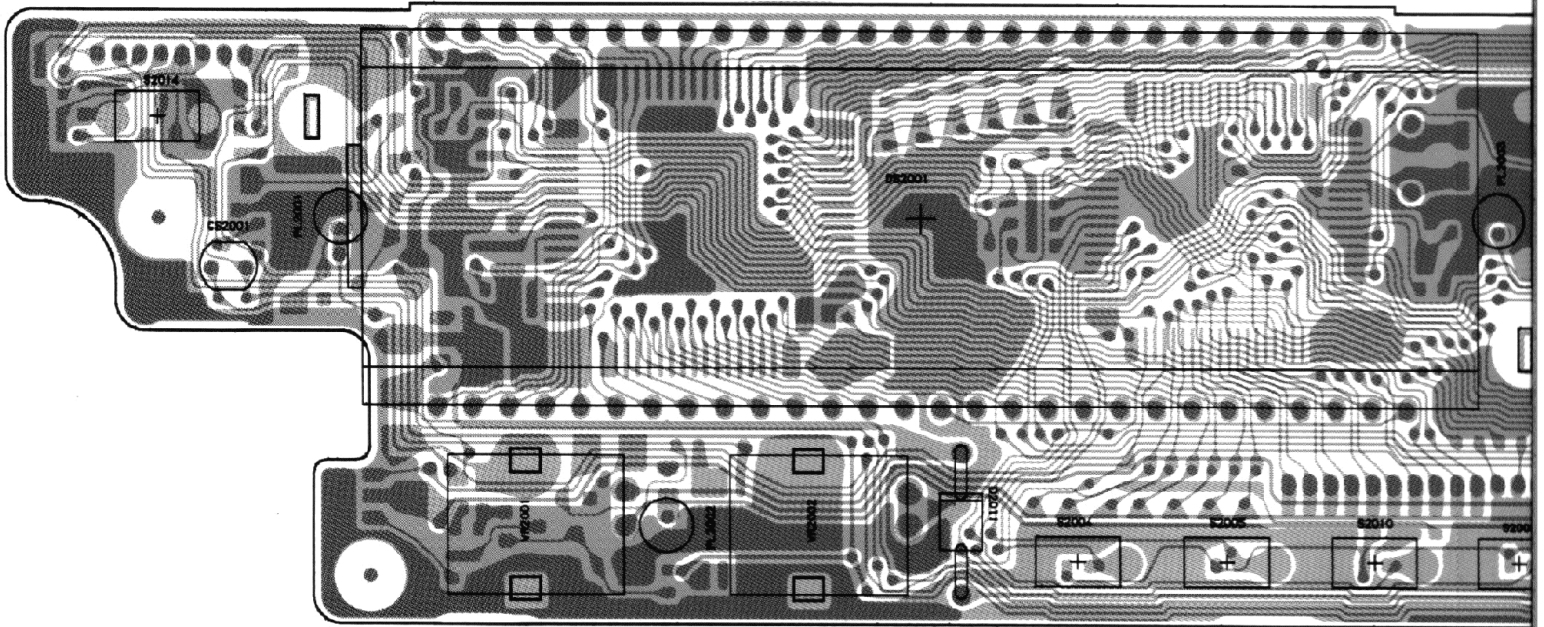

Obverse View of

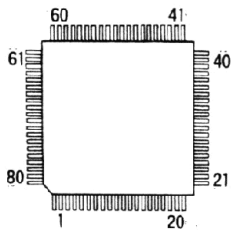

HD4074719H
(Q2001)

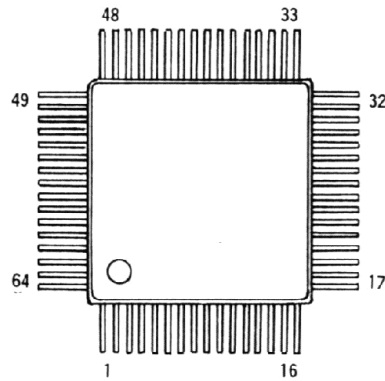

LC7582
(Q2002)

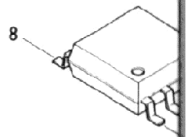

NJM2904
(Q2009)

PARTS LAYOUT

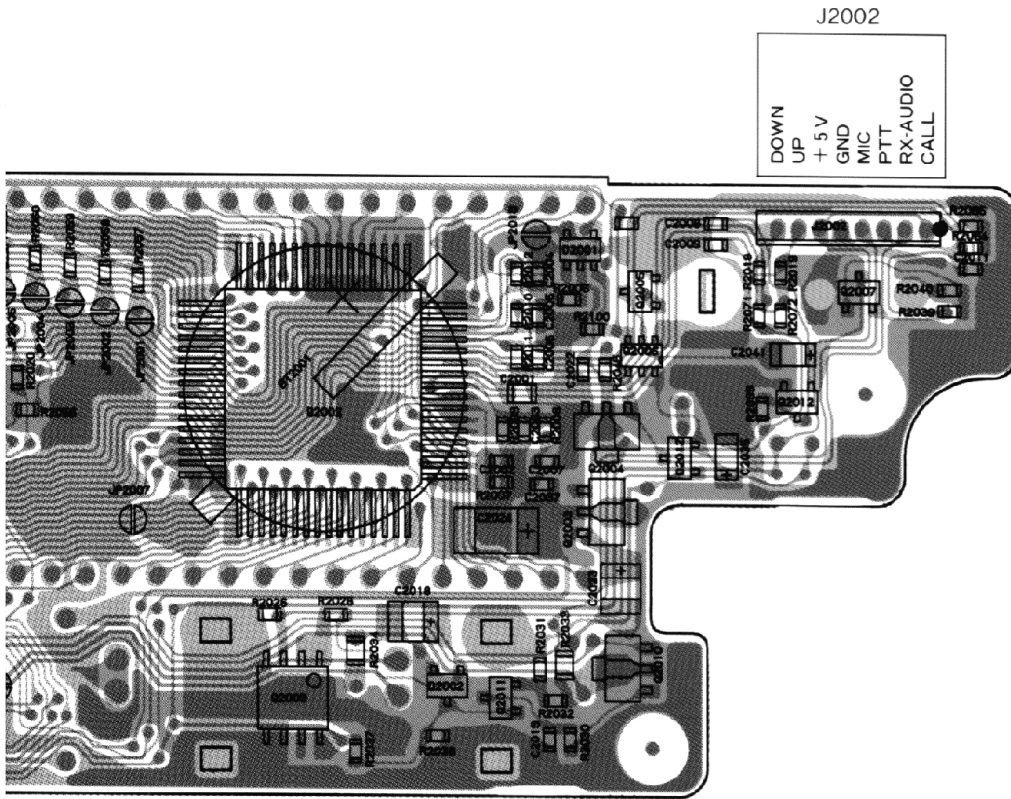

Obverse View of Chip Side

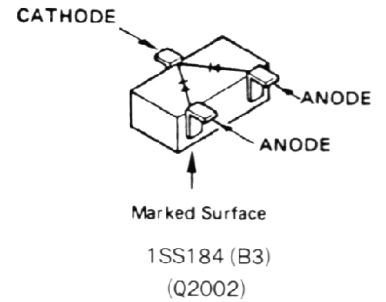

BASE
EMITTER

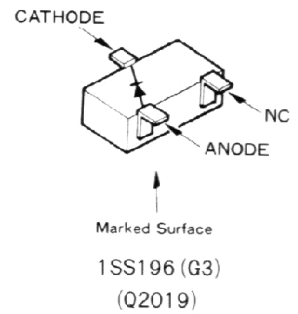
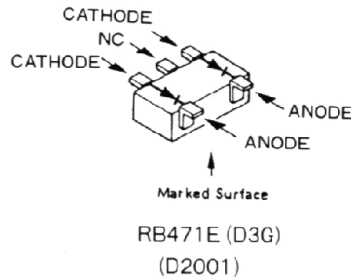
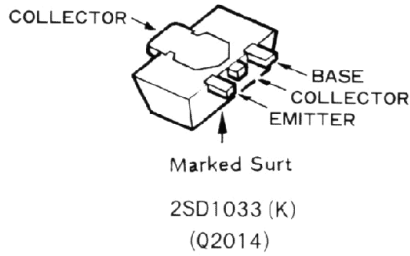

Collector

Emitter

DIAGRAM

J2004

13.8V
GND
H/L
H/M
PO
GND
SQL VR
SCAN STOP
S-METER
AF VR
T/R
NOISE INPUT

J2003

AF SP
GND
CLOCK
DATA
LE ENAB
GND
MIC
CENTER STOP
MIC MUTE
AF MUTE
BEEP
TONE

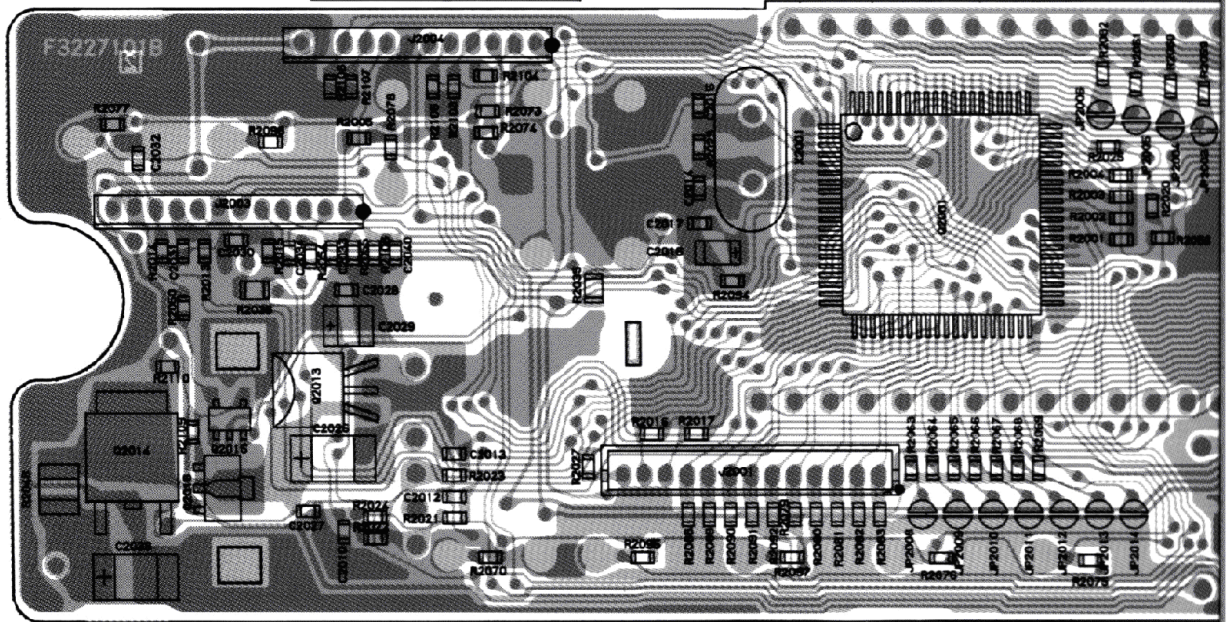

TSQ-STB
TSQ-DATA
TSQ-CLK
DET-OUT
R/W
CS
RRO
O2
TRQ/CP
D0
D1
D2
D3

J2001

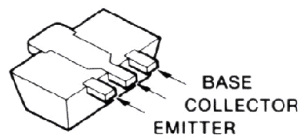

Marked Surface
2SB1301 (ZQ)
(Q2010, Q2018)

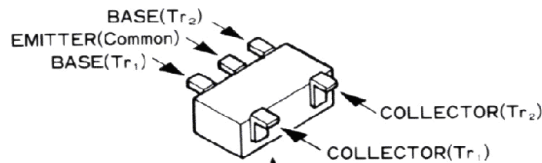

Marked Surface
FMG4 (G4)
(Q2015)

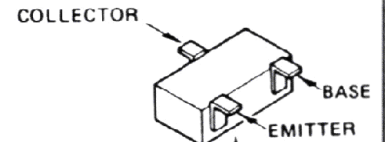

Marked Surface
2SA1162GR (SG)
(Q2007)
2SC2712GR (LG)
(Q2011)
DTC144EK (26)
(Q2005, Q2012)

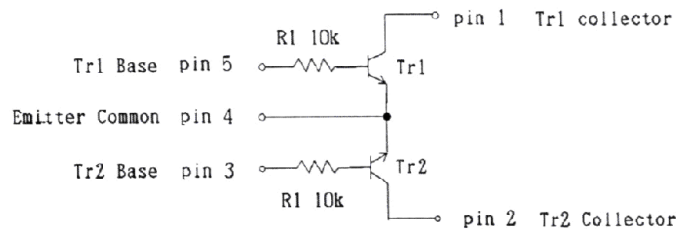

FMG4 CIRCUIT DIAGRAM

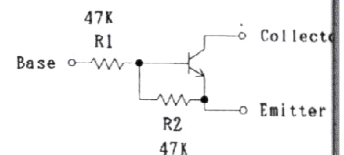

DTC144EK CIRCUIT DIAGRAM

INTERFACE UNIT PARTS LIST

REF	YAESU P/N	DESCRIPTION	MFR'S DESIG.	VALUE	NV	COL.	VERS.
*** INTERFACE-UNIT ***							
	CA0508001	P. C. B. W COMP.					
	F3226101	P. C. B. W/C COMP.					
C 3001	K22170805	CHIP CAP.	GRM40B102M50PT	0.001uF	50V	B	
C 3003	K22170817	CHIP CAP.	GRM40B103M50PT	0.01uF	50V	B	
C 3004	K76120024	TANTALUM CAP.	SS2-1C105-T2	1uF	16V		
C 3005	K22170805	CHIP CAP.	GRM40B102M50PT	0.001uF	50V	B	
C 3006	K46120007	AL. ELECTRC. CAP.	16V101M6X7TR2	100uF	16V		
C 3007	K22170805	CHIP CAP.	GRM40B102M50PT	0.001uF	50V	B	
C 3008	K46170030	AL. ELECTRC. CAP.	50V010M4X7TR2	1uF	50V		
C 3009	K22170821	CHIP CAP.	GRM40B223M50PT	0.022uF	50V	B	
C 3011	K22170805	CHIP CAP.	GRM40B102M50PT	0.001uF	50V	B	
C 3012	K22170805	CHIP CAP.	GRM40B102M50PT	0.001uF	50V	B	
C 3014	K22140813	CHIP CAP.	GRM40B473M25PT	0.047uF	25V		
C 3015	K22140813	CHIP CAP.	GRM40B473M25PT	0.047uF	25V		
C 3016	K22140813	CHIP CAP.	GRM40B473M25PT	0.047uF	25V		
C 3017	K22170251	CHIP CAP.	GRM40CH471J50PT	470pF	50V	CH	
C 3018	K22170809	CHIP CAP.	GRM40B222M50PT	0.0022uF	50V	B	
C 3019	K22140811	CHIP CAP.	GRM40B104M25PT	0.1uF	25V	B	
C 3020	K46170032	AL. ELECTRC. CAP.	50V3R3M4X7TR2	3.3uF	50V		
C 3021	K22170809	CHIP CAP.	GRM40B3222M50PT	0.0022uF	50V	B	
C 3022	K22170805	CHIP CAP.	GRM40B102M50PT	0.001uF	50V	B	
C 3024	K46120004	AL. ELECTRO. CAP.	16V100M4X7TR2	10uF	16V		
C 3025	K22140810	CHIP CAP.	GRM40B333M25PT	0.033uF	25V	B	
C 3027	K22170211	CHIP CAP.	GRM40CH100D50PT	10pF	50V	CH	
C 3028	K22170817	CHIP CAP.	GRM40B103M50PT	0.01uF	50V	3	
C 3029	K22170817	CHIP CAP.	GRM40B103M50PT	0.01uF	50V	3	
C 3031	K46120004	AL. ELECTRO. CAP.	16V100M4X7TR2	10uF	16V		
C 3032	K22140813	CHIP CAP.	GRM40B473M25PT	0.047uF	25V		
C 3033	K22170807	CHIP CAP.	GRM40B152M50PT	0.0015	50V	3	
C 3034	K22170809	CHIP CAP.	GRM40B222M50PT	0.0022uF	50V	3	
C 3035	K22170805	CHIP CAP.	GRM40B102M50PT	0.001uF	50V	3	
C 3036	K22170817	CHIP CAP.	GRM40B103M50PT	0.01uF	50V	3	
C 3037	K22140811	CHIP CAP.	GRM40B104M25PT	0.1uF	25V	3	
C 3039	K22170805	CHIP CAP.	GRM40B102M50PT	0.001uF	50V	3	
C 3040	K22170251	CHIP CAP.	GRM40CH471J50PT	470pF	50V	CH	
C 3041	K22140811	CHIP CAP.	GRM40B104M25PT	0.1uF	25V	3	
C 3042	K46120004	AL. ELECTRO. CAP.	16V100M4X7TR2	10uF	16V		
C 3043	K22140810	CHIP CAP.	GRM40B333M25PT	0.033uF	25V	3	
C 3044	K22120805	CHIP CAP.	GRM40B683M16PT	0.068uF	16V	R	
C 3045	K22170812	CHIP CAP.	GRM40B392M50PT	0.0039	50V	B	
C 3047	K22140813	CHIP CAP.	GRM40B473M25PT	0.047uF	25V		
C 3048	K22170805	CHIP CAP.	GRM40B102M50PT	0.001uF	50V	B	
C 3049	K22140811	CHIP CAP.	GRM40B104M25PT	0.1uF	25V	B	
C 3050	K46120004	AL. ELECTRO. CAP.	16V100M4X7TR2	10uF	16V		
C 3051	K22170235	CHIP CAP.	GRM40CH101J50PT	100pF	50V	CH	
C 3052	K22170235	CHIP CAP.	GRM40CH101J50PT	100pF	50V	CH	
C 3053	K22170235	CHIP CAP.	GRM40CH101J50PT	100pF	50V	CH	
C 3054	K22170235	CHIP CAP.	GRM40CH101J50PT	100pF	50V	CH	
C 3055	K22170235	CHIP CAP.	GRM40CH101J50PT	100pF	50V	CH	
C 3056	K22170235	CHIP CAP.	GRM40CH101J50PT	100pF	50V	CH	
C 3057	K22170235	CHIP CAP.	GRM40CH101J50PT	100pF	50V	CH	
C 3058	K22170235	CHIP CAP.	GRM40CH101J50PT	100pF	50V	CH	
C 3059	K22170235	CHIP CAP.	GRM40CH101J50PT	100pF	50V	CH	

INTERFACE UNIT PARTS LIST

REF	YAESU P/N	DESCRIPTION	MFR'S DESIG.	VALUE	WV	TOL.	VERS.
C 3060	K22170235	CHIP CAP.	GRM40CH101J50PT	100pF	5JV	CH	
C 3061	K22170235	CHIP CAP.	GRM40CH101J50PT	100pF	50V	CH	
C 3062	K22170235	CHIP CAP.	GRM40CH101J50PT	100pF	50V	CH	
C 3063	K22170235	CHIP CAP.	GRM40CH101J50PT	100pF	50V	CH	
C 3064	K461200C4	AL. ELECTRO. CAP.	16V10CM4X7TR2	10uF	16V		
C 3065	K22170805	CHIP CAP.	GRM40B102M50PT	0.001uF	50V	B	
C 3066	K22170235	CHIP CAP.	GRM40CH101J50PT	100pF	50V	CH	
C 3067	K22170235	CHIP CAP.	GRM40CH101J50PT	100pF	50V	CH	
C 3068	K22170235	CHIP CAP.	GRM40CH101J50PT	100pF	50V	CH	
C 3069	K22170235	CHIP CAP.	GRM40CH101J50PT	100pF	50V	CH	
C 3070	K22170235	CHIP CAP.	GRM40CH101J50PT	100pF	50V	CH	
C 3071	K22170235	CHIP CAP.	GRM40CH101J50PT	100pF	50V	CH	
C 3075	K22170235	CHIP CAP.	GRM40CH101J50PT	100pF	50V	CH	
C 3076	K22170805	CHIP CAP.	GRM40B102M50PT	0.001uF	50V	B	
C 3077	K22170235	CHIP CAP.	GRM40CH101J50PT	100pF	50V	CH	
C 3078	K22170235	CHIP CAP.	GRM40CH101J50PT	100pF	50V	CH	
C 3079	K22170235	CHIP CAP.	GRM40CH101J50PT	100pF	50V	CH	
C 3080	K22170235	CHIP CAP.	GRM40CH101J50PT	100pF	50V	CH	
C 3081	K22170235	CHIP CAP.	GRM40CH101J50PT	100pF	50V	CH	
C 3082	K22170235	CHIP CAP.	GRM40CH101J50PT	100pF	50V	CH	
C 3083	K22170235	CHIP CAP.	GRM40CH101J50PT	100pF	50V	CH	
C 3084	K22170235	CHIP CAP.	GRM40CH101J50PT	100pF	50V	CH	
C 3085	K22170235	CHIP CAP.	GRM40CH101J50PT	100pF	50V	CH	
C 3086	K22170235	CHIP CAP.	GRM40CH101J50PT	100pF	50V	CH	
C 3087	K22170235	CHIP CAP.	GRM40CH101J50PT	100pF	50V	CH	
C 3088	K22170805	CHIP CAP.	GRM40B102M50PT	0.001uF	50V	B	
C 3089	K22170805	CHIP CAP.	GRM40B102M50PT	0.001uF	50V	B	
C 3091	K22170805	CHIP CAP.	GRM40B102M50PT	0.001uF	50V	B	
C 3093	K22170809	CHIP CAP.	GRM40B222M50PT	0.0022uF	50V	B	
C 3094	K46120004	AL. ELECTRO. CAP.	16V100M4X7TR2	10uF	16V		
C 3095	K22170805	CHIP CAP.	GRM40B102M50PT	0.001uF	50V	B	
C 3096	K22140811	CHIP CAP.	GRM40B104M25PT	0.1uF	25V	B	
D 3001	G2070001	DIODE	1SS181 TE85R				
D 3002	G2070078	DIODE	1MN10 T108				
J 3001	P1090678	CONNECTOR	5124-14BHF8				
J 3002	P1090428	CONNECTOR	5124-07BHF8				
J 3003	P0090851	CONNECTOR	SB20-12WL				
J 3004	P0090851	CONNECTOR	SB20-12WL				
J 3005	P0090620	CONNECTOR	SB20-13WS				
J 3006	P0090856	CONNECTOR	9230B-1-05Z003-T				
J 3007	P0090856	CONNECTOR	9230B-1-05Z003-T				
J 3008	P0090857	CONNECTOR	9230B-1-07Z003-T				
J 3009	P0090857	CONNECTOR	9230B-1-07Z003-T				
Q 3001	G3070047	TRANSISTOR	DTA114EK T97				
Q 3002	G3211400S	TRANSISTOR	2SB1110S				
Q 3003	G1C90843	IC	UPC78L05J				
Q 3004	G3C70002	TRANSISTOR	DTC114EK T96				
Q 3005	G1090893	IC	TC4S66F TE85R				
Q 3006	G1090908	IC	NJM2902M				
Q 3007	G1090559	IC	LA6324NM				
Q 3008	G1090559	IC	LA6324NM				
Q 3009	G1090893	IC	TC4S66F TE85R				
Q 3010	G3070002	TRANSISTOR	DTC114EK T96				
Q 3011	G3070033	TRANSISTOR	DTC144EK T97				

INTERFACE UNIT PARTS LIST

REF	YABSU P/N	DESCRIPTION	MFGR'S DES.G.	VALUE	WV	TOL.	VERS.
Q 3012	G3070002	TRANSISTOR	D7C114EK T96				
Q 3013	G3070002	TRANSISTOR	D7C114EK T96				
Q 3014	G3070027	TRANSISTOR	1MH5 T108				
R 3001	J24275221	CHIP RES.	RMC1/2 221JCTP	220	1/2W		
R 3002	J24205472	CHIP RES.	RMC1/10T 472J	4.7K	1/10W		
R 3003	J24205103	CHIP RES.	RMC1/10T 103J	10K	1/10W		
R 3004	J24205470	CHIP RES.	RMC1/10T 470J	47	1/10W		
R 3005	J24205473	CHIP RES.	RMC1/10T 473J	47K	1/10W		
R 3006	J24205105	CHIP RES.	RMC1/10T 105J	1M	1/10W		
R 3007	J24205000	CHIP RES.	RMC1/10T 000J	0	1/10W		
R 3008	J24205334	CHIP RES.	RMC1/10T 334J	330K	1/10W		
R 3009	J24205472	CHIP RES.	RMC1/10T 472J	4.7K	1/10W		
R 3010	J24205822	CHIP RES.	RMC1/10T 822J	8.2K	1/10W		
R 3012	J24205563	CHIP RES.	RMC1/10T 533J	56K	1/10W		
R 3013	J24205332	CHIP RES.	RMC1/10T 332J	3.3K	1/10W		
R 3014	J24205473	CHIP RES.	RMC1/10T 473J	47K	1/10W		
R 3015	J24205473	CHIP RES.	RMC1/10T 473J	47K	1/10W		
R 3016	J24205472	CHIP RES.	RMC1/10T 472J	4.7K	1/10W		
R 3017	J24205472	CHIP RES.	RMC1/10T 472J	4.7K	1/10W		
R 3018	J24205103	CHIP RES.	RMC1/10T 103J	10K	1/10W		
R 3019	J24205682	CHIP RES.	RMC1/10T 682J	6.8K	1/10W		
R 3020	J24205103	CHIP RES.	RMC1/10T 103J	10K	1/10W		
R 3021	J24205103	CHIP RES.	RMC1/10T 103J	10K	1/10W		
R 3022	J24205470	CHIP RES.	RMC1/10T 470J	47	1/10W		
R 3023	J24205103	CHIP RES.	RMC1/10T 103J	10K	1/10W		
R 3024	J24205472	CHIP RES.	RMC1/10T 472J	4.7K	1/10W		
R 3025	J24205392	CHIP RES.	RMC1/10T 392J	3.9K	1/10W		
R 3026	J24205472	CHIP RES.	RMC1/10T 472J	4.7K	1/10W		
R 3027	J24205564	CHIP RES.	RMC1/10T 554J	550K	1/10W		
R 3028	J24205153	CHIP RES.	RMC1/10T 153J	15K	1/10W		
R 3029	J24205123	CHIP RES.	RMC1/10T 123J	12K	1/10W		
R 3030	J24205155	CHIP RES.	RMC1/10T 155J	1.5M	1/10W		
R 3031	J24205394	CHIP RES.	RMC1/10T 394J	390K	1/10W		
R 3032	J24205105	CHIP RES.	RMC1/10T 105J	1M	1/10W		
R 3033	J24205473	CHIP RES.	RMC1/10T 473J	47K	1/10W		
R 3034	J24205473	CHIP RES.	RMC1/10T 473J	47K	1/10W		
R 3035	J24205472	CHIP RES.	RMC1/10T 472J	4.7K	1/10W		
R 3039	J24205333	CHIP RES.	RMC1/10T 333J	33K	1/10W		
R 3040	J24205333	CHIP RES.	RMC1/10T 333J	33K	1/10W		
R 3041	J24205225	CHIP RES.	RMC1/10T 225J	2.2M	1/10W		
R 3042	J24205153	CHIP RES.	RMC1/10T 153J	15K	1/10W		
R 3043	J24205153	CHIP RES.	RMC1/10T 153J	15K	1/10W		
R 3044	J24205333	CHIP RES.	RMC1/10T 333J	33K	1/10W		
R 3046	J24205104	CHIP RES.	RMC1/10T 104J	100K	1/10W		
R 3047	J24205104	CHIP RES.	RMC1/10T 104J	100K	1/10W		
R 3048	J24205225	CHIP RES.	RMC1/10T 225J	2.2M	1/10W		
R 3049	J24205103	CHIP RES.	RMC1/10T 103J	10K	1/10W		
R 3050	J24205103	CHIP RES.	RMC1/10T 103J	10K	1/10W		
R 3051	J24205273	CHIP RES.	RMC1/10T 273J	27K	1/10W		
R 3052	J24205273	CHIP RES.	RMC1/10T 273J	27K	1/10W		
R 3053	J24205273	CHIP RES.	RMC1/10T 273J	27K	1/10W		
R 3054	J24205474	CHIP RES.	RMC1/10T 474J	470K	1/10W		
R 3055	J24205274	CHIP RES.	RMC1/10T 274J	270K	1/10W		
R 3056	J24205184	CHIP RES.	RMC1/10T 184J	180K	1/10W		
R 3057	J24205564	CHIP RES.	RMC1/10T 564J	560K	1/10W		
R 3058	J24205103	CHIP RES.	RMC1/10T 103J	10K	1/10W		

INTERFACE UNIT PARTS LIST

REF	YAESU P/N	DESCRIPTION	MFGR'S DESIG.	VALUE	NV	TOL.	VERS.
R 3059	J24205103	CHIP RES.	RMC1/10T 103J	10K	1/10W		
R 3060	J24205333	CHIP RES.	RMC1/10T 333J	33K	1/10W		
R 3061	J24205333	CHIP RES.	RMC1/10T 333J	33K	1/10W		
R 3062	J24205182	CHIP RES.	RMC1/10T 182J	1.8K	1/10W		
R 3063	J24205182	CHIP RES.	RMC1/10T 182J	1.8K	1/10W		
R 3064	J24205393	CHIP RES.	RMC1/10T 393J	39K	1/10W		
R 3066	J24205224	CHIP RES.	RMC1/10T 224J	220K	1/10W		
R 3067	J24205223	CHIP RES.	RMC1/10T 223J	22K	1/10W		
R 3069	J24205473	CHIP RES.	RMC1/10T 473J	47K	1/10W		
R 3071	J24205472	CHIP RES.	RMC1/10T 472J	4.7K	1/10W		
R 3073	J24205104	CHIP RES.	RMC1/10T 104J	100K	1/10W		
TP3001	Q5000016	TP-E	TP E/MS 60124				
TP3002	Q5000016	TP-E	TP-E/MS-60124				
VR3001	J51745103	POT.	H0651A013-10KB	10KB			
VR3002	J51745224	POT.	H0651A021-220KE	220KR			
VR3003	J51745223	POT.	H0651A015-22KB	22KB			
VR3004	J51745103	POT.	H0651A013-10KB	10KB			
VR3005	J51745473	POT.	H0651A017-47KB	47KB			
VR3006	J51745682	POT.	H0651A012-6.8KE	6.8KB			
VR3007	J51745222	POT.	H0651A009-2.2KE	2.2KB			
VR3008	J51745103	POT.	H0651A013-10KB	10KB			
	R7139760	RUBBER SPONGE					

UNIT PARTS LAYOUT

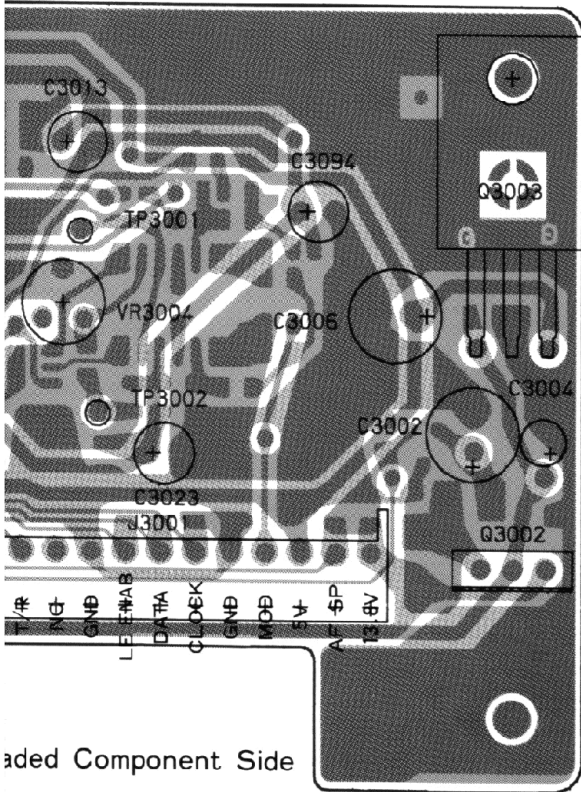

Unpopulated Component Side

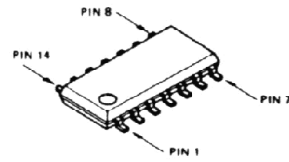
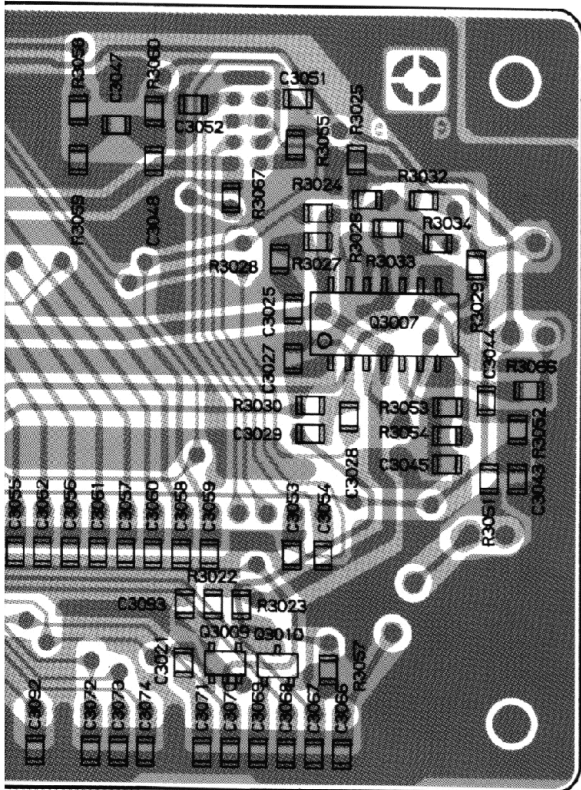

LA6324M
(Q3007, Q3008)
NJM2902M
(Q3006)

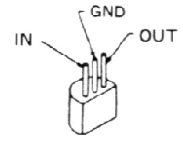

78L05
(Q3003)

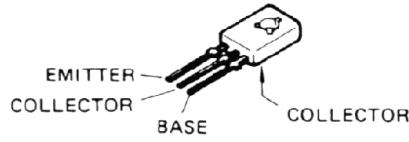

2SB1140S
(Q3002)

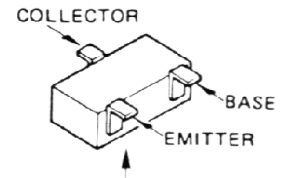

Marked Surface
DTC114EK (24)
(Q3004, Q3010)
(Q3012, Q3013)
DTA114EK (14)
(Q3001)

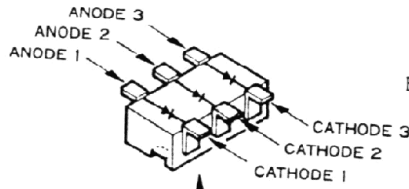

Marked Surface
IMN10 (N10)
(D3002)

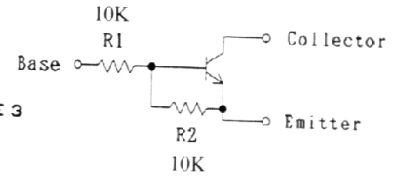

DTC114EK CIRCUIT DIAGRAM



Marked Surface
1SS181 (A3)
(D3001)

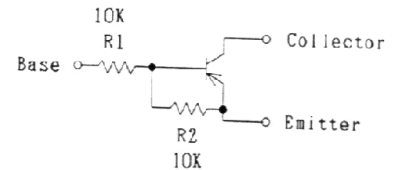

DTA114EK CIRCUIT DIAGRAM

INSTALLATION OF OPTIONS (FRC-6)

FRC-6 DTMF Pager Installation & Alignment

The FRC-6 provides DTMF paging/selcall features using 3-digit DTMF station ID codes. Seven code memories store your ID code plus those of six frequently-called stations or groups. Control is provided through the front panel of the transceiver. See the *FT-2400H Operating Manual* for operational details.

- Disconnect the DC power cable, and referring to Figure 1, remove the four screws affixing the top cover (two on either side), and loosen the one on top from the back by several turns. Lift the rear edge of the cover slightly, then remove it.
- Referring to Figure 2, note the accessory mounting location for the FRC-6 over the larger of the two empty white connectors.
- Carefully align the pins on the FRC-6 with the connector, and press it into place.
- The factory adjusts the output tone level (the small trimmer accessible through the FRC-6 board) for the proper deviation, so it should

require no further adjustment. The alignment procedure is listed below, however, if needed.

- Replace the top cover and four screws removed in the first step, and remember to tighten the screw at the back of the top panel from the rear.

Alignment

- Select 20-kHz tuning steps on the transceiver (press **F/W** → **A/N STEP**, turn the selector knob for 20-kHz displayed steps, and press **A/N STEP** again).
- Connect the test equipment as shown on the following page, and temporarily connect a 4.7-kilohm resistor between pins 7 and 12 on the installed FRC-6, as shown below (this causes a DTMF tone to be emitted continuously).
- Adjust VR101 on the FRC-6 for ± 3.5 to 4.7 kHz deviation during transmission, with no microphone input.
- Set the AF generator for 50 mV output at 1 kHz, and adjust trimmer potentiometer VR3001 for ± 4.8 kHz deviation during transmission.

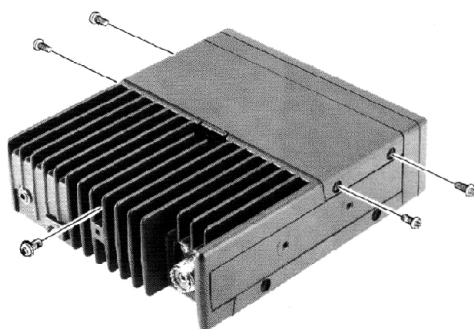

Figure 1

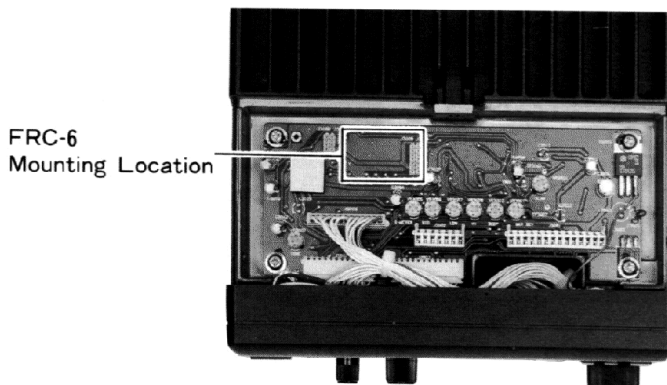

Figure 2

FRC-6 PARTS LIST

REF	YABSJ P/N	DESCRIPTION	MFR'S DESIG.	VALUE	WV	TOL.
*** PGR UNIT ***						
	F3223101A	P. C. B. W/O COMP.				
C 0101	K22170817	CHIP CAP.	GRM40B103M50PT	0.01uF	50V	B
C 0102	K22141005	CHIP CAP.	GRM40F104Z25PT	0.1uF	25V	F
C 0103	K22141005	CHIP CAP.	GRM40F104Z25PT	0.1uF	25V	F
C 0104	K22141005	CHIP CAP.	GRM40F104Z25PT	0.1uF	25V	F
C 0105	K22170223	CHIP CAP.	GRM40CH330J50PT	33pF	50V	CH
C 0106	K22170223	CHIP CAP.	GRM40CH330J50PT	33pF	50V	CH
C 0107	K78100015	TANTALUM CHIP CAP.	TEMSVA1A335M-8R	3.3uF	10V	
C 0108	K22170235	CHIP CAP.	GRM40CH101J50PT	100pF	50V	CH
C 0109	K22170235	CHIP CAP.	GRM40CH101J50PT	100pF	50V	CH
C 0110	K22170235	CHIP CAP.	GRM40CH101J50PT	100pF	50V	CH
C 0111	K22170235	CHIP CAP.	GRM40CH101J50PT	100pF	50V	CH
F 0101	P1090705	CONNECTOR	52022-1410			
G 0101	G1091344	IC	CM8880SIT-2			
R 0101	J24205104	CHIP RES.	RMC1/10T 104J	100K	1/10W	
R 0102	J24205104	CHIP RES.	RMC1/10T 104J	100K	1/10W	
R 0104	J24205104	CHIP RES.	RMC1/10T 104J	100K	1/10W	
R 0106	J24205332	CHIP RES.	RMC1/10T 332J	3.3K	1/10W	
R 0107	J24205103	CHIP RES.	RMC1/10T 103J	10K	1/10W	
VR0101	J51780473	POT.	RH043P4S4X	47K		
X 0101	H0102849	XTAL	3.573545MHZ			
	R7139730	RUBBER SPONGE				

OUT/CIRCUIT DIAGRAM

F3228101A

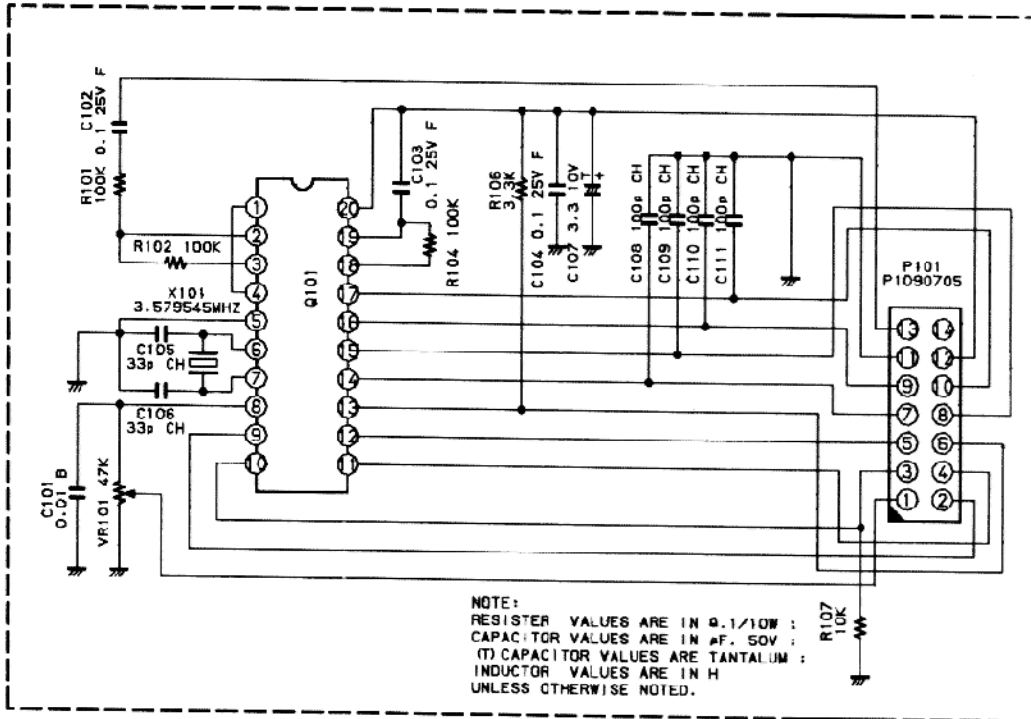

IN	N. C
GND	+5V
D2	D3
D0	D1
D2	TRQ/CP
CS	RSO
OUT	R/W

FRC-6 PARTS LAYOUT

- | | |
|---------|-----------|
| 1. OUT | 2. R/W |
| 3. CS | 4. RSO |
| 5. Q2 | 6. IRQ/CP |
| 7. D0 | 8. D1 |
| 9. D2 | 10. D3 |
| 11. GND | 12. +5V |
| 13. IN | 14. N.C. |

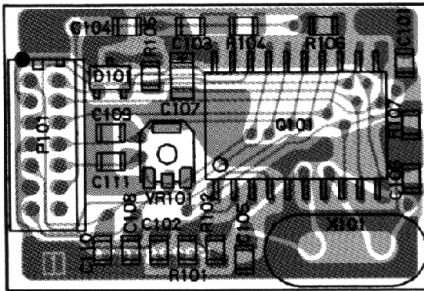

Obverse View of Chip Side

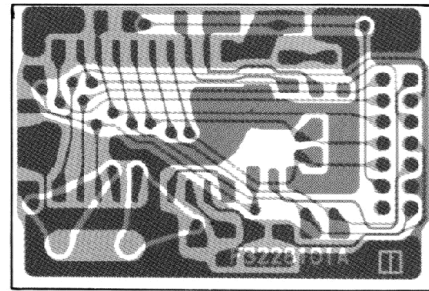

Obverse View of Solder Side

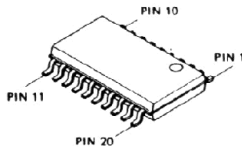

CM8880SIT-2
(Q0101)

INSTALLATION OF OPTIONS (FTS-17A)

FTS-17A CTCSS Encoder/Decoder Installation & Alignment

The FTS-17A includes a decoder for 38 EIA standard subaudible CTCSS tones, programmable from the front panel of the FT-2400H. It provides silent monitoring of busy channels when activated by the **ENC**ode/**DEC**ode Tone Squelch function.

- ❑ Disconnect the DC power cable, and referring to Figure 1 on the previous page, remove the four screws affixing the top cover (two on either side), and loosen the one on top from the back by several turns. Lift the rear edge of the cover slightly, then remove it.
- ❑ Referring to Figure 3 below, note the accessory mounting location for the FTS-17A over the smaller of the two empty white connectors. Remove the paper from the double-sided adhesive pad.
- ❑ Carefully align the pins on the FTS-17A with the connector, and press it into place.

- ❑ The factory adjusts the output tone level (the small trimmer accessible through the FTS-17A board) for the proper deviation, so it should require no further adjustment. The alignment procedure is listed below, however, if needed.
- ❑ Replace the top cover and four screws removed in the first step, and remember to tighten the screw at the back of the top panel from the rear.

Alignment

- ❑ Select 20-kHz tuning steps on the transceiver (press **F/W** → **A/N STEP**, turn the selector knob for 20-kHz displayed steps, and press **A/N STEP** again).
- ❑ Connect the test equipment as shown below, and adjust VR101 on the FTS-17A for ± 0.7 kHz deviation during transmission, with no microphone input.
- ❑ Set the AF generator for 50 mV output at 1 kHz, and adjust trimmer potentiometer VR3001 for ± 4.8 kHz deviation during transmission.

FTS-17A
Mounting Location

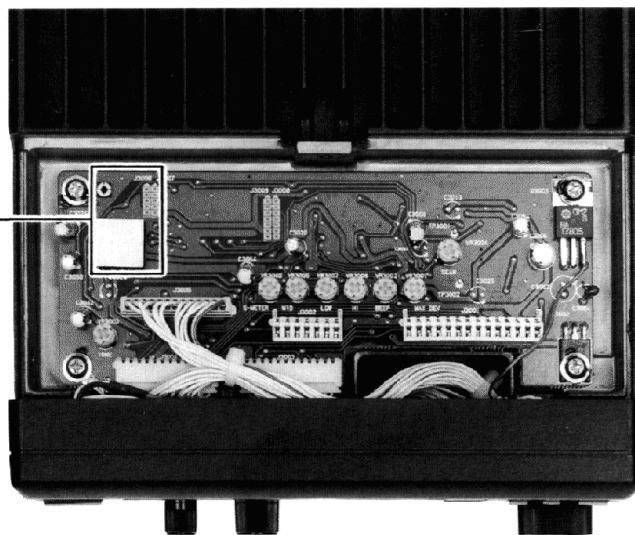

INSTALLATION OF OPTIONS (FTS-17A)

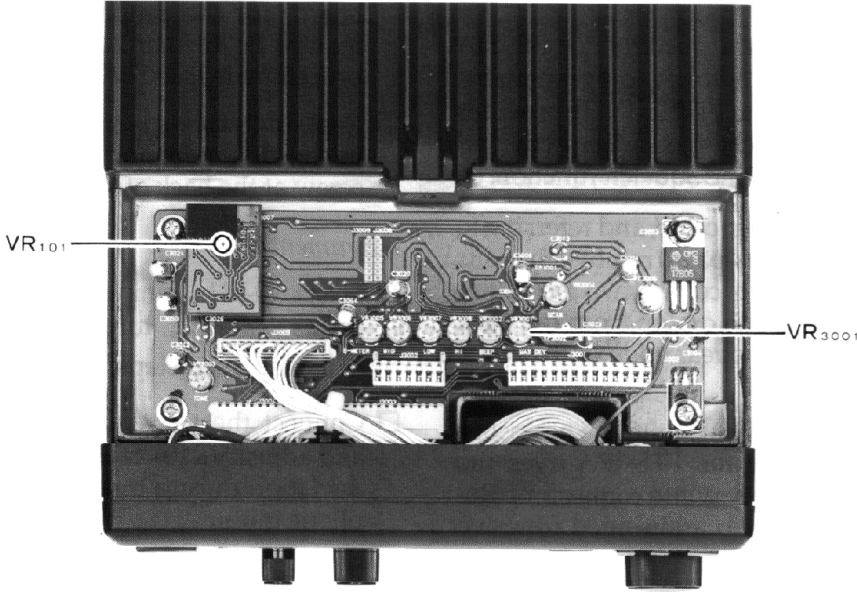

FTS-17A PARTS LIST

REF	YAESU P/N	DESCRIPTION	MFG'S DESIG.	VALUE	WV	TOL.	VERS.
*** T-SQL-UNIT ***							
	F3220101	P. C. B. W/O COMP.					
C 0101	K22174801	CHIP CAP.	GRM39B221M50PT	2205F	50V	B	
C 0102	K22174801	CHIP CAP.	GRM39B221M50PT	2205F	50V	B	
C 0103	K22140811	CHIP CAP.	GRM40B104M25PT	0.1uF	25V	B	
C 0104	K78120013	TANTALUM CHIP CAP.	F951C105MRAAF1Q2	1uF	16V		
C 0105	K78140012	TANTALUM CHIP CAP.	F951E474MRAAF1Q2	0.47uF	25V		
C 0106	K78080002	TANTALUM CHIP CAP.	F950J475MSAAF1Q2	4.7uF	6.3V		
C 0107	K22174809	CHIP CAP.	GRM39B102M50PT	0.001uF	50V	B	
C 0108	K22143811	CHIP CAP.	GRM40B104M25PT	0.1uF	25V	B	
C00101	F7900550	CERAMIC OSC	CSB1000J221T		1MHZ		
D 0101	G2070086	DIODE	1SS301 TE85R				
P 0101	P1090324	CONNECTOR	52022-1010				
Q 0101	G1090897	IC	MX355LH				
R 0101	J24185105	CHIP RES.	RMC1/16 105JATP	1M	1/16W		
R 0102	J24185225	CHIP RES.	RMC1/16 225JATP	2.2M	1/16W		
R 0103	J24185334	CHIP RES.	RMC1/16 334JATP	330K	1/16W		
R 0104	J24185822	CHIP RES.	RMC1/16 822JATP	8.2K	1/16W		
VR0101	J51780473	POT.	RH04BPAS4X 47K	47K			
	R7130200	SPONGE					

FTS-17A PARTS LAYOUT

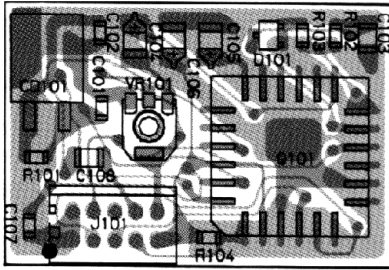

Obverse View
of Chip Side

- 1. GND
- 2. GND
- 3. CLOCK
- 4. T DET
- 5. DATA
- 6. T5
- 7. T STB
- 8. T SQL
- 9. CPUS
- 10. TONE

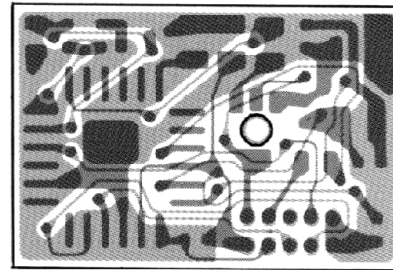

Obverse View of Solder Side

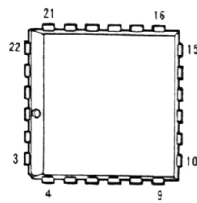

MX365LH
(Q0101)

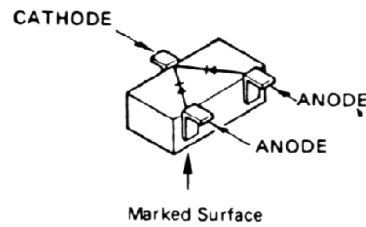

Marked Surface
1SS301 (B3)
(D0101)