

FT-48OR
MAIN, PWR AMP UNIT
BLOCK DIAGRAM

→ RX
→ TX

CIRCUIT DESCRIPTION

The block diagram and circuit description to follow will provide you with a better understanding of this transceiver. Please refer to the block and schematic diagram for specific circuit details.

RECEIVER

The RF signal from the antenna jack is applied to the MAIN UNIT through a low pass filter and the antenna relay, RL₂₀₀₁. The signal is amplified by Q₁₀₀₁ (3SK59Y), a dual gate MOS FET with excellent rejection of cross modulation and intermodulation. The amplified signal is fed to the 1st mixer, Q₁₀₀₂ (3SK51-03), where the RF signal is mixed with a local signal delivered from the PLL UNIT, resulting in a 10.81 MHz first IF signal.

The first IF signal is passed through a monolithic crystal filter, XF₁₀₀₁ (108M30B), which has ± 15 kHz bandwidth, and amplified by Q₁₀₀₃ (3SK73Y), which acts as a switch driven by the NB (noise blanker) circuit. The amplified signal from Q₁₀₀₃ is fed to IF amplifiers for each mode.

FM mode signal is fed to 2nd mixer Q₁₀₀₅ (2SC535B), where the signal is mixed with an 11.265 MHz local signal, resulting in a 455 kHz 2nd IF signal.

The 2nd IF signal is passed through a ceramic filter, CF₁₀₀₁, which has a ± 4.5 kHz bandwidth, and then fed to the FM mode IF amplifier.

The filtered signal is amplified by Q₁₀₀₆ and Q₁₀₀₇ (2SC945Q) and passed through CF₁₀₀₂, which has a ± 7.5 kHz bandwidth. The filtered FM signal is amplified by Q₁₀₀₈ (μ PC577H) and demodulated by CD₁₀₀₁ and D₁₀₁₀/D₁₀₁₁ (1S188FM). The demodulated FM signal is amplified by Q₁₀₁₂ (2SC1815GR) and then fed to the AF amplifier.

SSB and CW mode signals from the Q₁₀₀₃ are passed through a crystal filter, XF₁₀₀₂, which has a very high shape factor, to improve adjacent frequency selectivity. The filtered SSB signal is amplified by Q₁₀₁₄ and Q₁₀₁₅ (3SK73Y), and then fed to the balanced demodulator, Q₁₀₁₆ (μ PC1037H), where a carrier signal is applied from the carrier oscillator Q₁₀₄₁/Q₁₀₄₂ (2SC945Q); the detected audio output is then fed to the AF amplifier.

The audio signals from each demodulator are passed to the active lowpass filter, which consists of Q₁₀₂₇ and Q₁₀₂₈ (2SC945Q) to eliminate the unwanted noise portion of the signal. The audio signal is then fed, through the AF gain control, to the audio output amplifier, Q₁₀₂₉ (μ PC2002V), providing about 2 watts of audio output to the speaker.

S-METER CIRCUIT

A portion of the amplified IF signal is fed to Q₁₀₁₇ (2SC535B), a buffer amplifier, through C₁₀₈₀. The amplified signal is then applied to the AGC detector, D₁₀₂₅/D₁₀₂₆. The rectified signal is amplified by DC amplifier Q₁₀₁₈ (2SC1815Y) for AGC control. This AGC voltage is delivered to the front panel S.PO indicator to illuminate LEDs according to the input signal strength.

SQUELCH CIRCUIT

A portion of the demodulated FM signal from the ceramic discriminator (CD₁₀₀₁, D₁₀₁₀, D₁₀₁₁) is fed to noise amplifiers Q₁₀₀₉ and Q₁₀₁₀ (2SC945Q) through VR₁₀₀₂ and the SQ Control (VR_{1b}), and then rectified by D₁₀₁₂ and D₁₀₁₄, a voltage doubling circuit. The rectified signal is fed to the base of Q₁₀₁₁ (2SC1815Y), the squelch control circuit.

When no carrier is present, the rectified DC voltage is applied to the base of Q₁₀₁₁, to turn Q₁₀₁₂ (2SC1815GR) on. With conduction of Q₁₀₁₁, the base of Q₁₀₁₂ is grounded, squelching the audio amplifier.

When a carrier is present, the rectified DC voltage is reduced; and the audio amplifier Q₁₀₁₂ then recovers to normal operation. The BUSY lamp switch, Q₁₀₁₃ (2SC945Q), is also activated by the rectified voltage from the demodulator to illuminate the BUSY lamp when a carrier is present.

NB (Noise Blanker) CIRCUIT

A portion of the IF signal from monolithic filter XF_{1001} is amplified by Q_{1047} (2SC535B), Q_{1048} , Q_{1049} , and Q_{1050} (2SC1583). The output signal is rectified by D_{1059} and D_{1060} , producing a DC voltage. This DC voltage is amplified by Q_{1052} (MPSA13) and fed to gate 2 of Q_{1003} , the noise blanker gate. A portion of the DC voltage is amplified by Q_{1051} , and then fed to Q_{1048} , Q_{1049} (2SC1583) as a noise blanker AGC voltage. When impulse-type noise is received, the induced DC voltage reduces the gain of Q_{1003} , and blocks the signal path momentarily. The noise AGC control voltage is not, however, induced by such impulse-type noise, because the time constant of C_{1243}/R_{1273} is long. Normal signals, though, induce the noise blanker AGC voltage, reducing the gain of the noise amplifier, allowing normal signal flow at Q_{1003} .

TRANSMITTER

The discussion of the signal flow on transmit will be on a mode by mode basis.

SSB

The audio input signal from the microphone is amplified by Q_{1030} (2SC1815GR) and Q_{1039} (2SC1815Y). The audio level is adjusted to the proper level by VR_{1007} , and is applied through an active lowpass filter, Q_{1040} (2SC945Q), to the ring modulator, $D_{1053}-D_{1056}$. Here the audio signal modulates the 10.81 MHz carrier signal delivered from the carrier oscillator Q_{1041} (2SC945Q) and buffer Q_{1042} (2SC945Q), resulting in a 10.81 MHz double-sideband signal. The signal is amplified by Q_{1043} (2SK19TM-GR) and fed to XF_{1002} , a crystal filter, where the unwanted sideband is sliced out. The SSB signal is then fed to a mixer Q_{1036} (MC1496G) and mixed with a local signal from the PLL Unit, resulting in a 143.5–148.5 MHz SSB signal.

The SSB signal is passed through $T_{1010}-T_{1014}$, which are tuned exactly to the operating frequency by varactor diodes, thus minimizing spurious radiation. The signal is then amplified by Q_{1037} (3SK70), and Q_{1038} (2SC2053) to the proper level for driving the power amplifier circuit.

FM

The output audio signal at Q_{1030} is amplified by Q_{1031} (2SC1815GR) and Q_{1032} (2SC945Q) and fed to the IDC circuit, consisting of D_{1037} and D_{1038} , which clips both positive and negative peaks to control the maximum possible deviation; the clipped signal is then passed through an active lowpass filter to eliminate harmonics above the speech range caused by clipping. The output signal is amplified by Q_{1034} (2SC945Q) to a sufficient audio level and applied to the FM modulation module XM_{1001} for modulation, and the maximum deviation is adjusted by VR_{1006} prior to delivery to Q_{1014} . The signal path is then identical to that of the SSB signal.

CW

For CW, the 10.8107 MHz carrier signal is generated by Q_{1044} (2SC945Q), amplified by Q_{1035} (2SC945Q), and fed to IF amplifier Q_{1014} .

The key line is connected to switching transistor Q_{1062} (2SC945Q) through inverter Q_{1061} (MC14011B), which controls the gate voltages at Q_{1014} (3SK73) and Q_{1037} (3SK59Y), and thus turning the RF signal on and off.

The signal path is then identical to that of the CW signal.

An RC circuit connected to the base of Q_{1062} produces an ideal keying waveshape for click-free CW operation. The key line is also connected to side tone oscillator Q_{1061} (MC14011B) for monitoring of the code signal during CW operation. In order to operate on semi-break-in, the Schmitt trigger and delay circuit at Q_{1060} (MC14011B) activates the RX-TX changeover relay.

POWER AMPLIFIER CIRCUIT

The RF signal from the Main Unit is amplified by Q_{2001} (2SC2053) and Q_{2002} (M57713) in the Power Amplifier Unit, delivering approximately 10 watts of RF output to the antenna through a lowpass filter.

POWER CONTROL CIRCUIT

When the HI/LOW switch is set to the LOW position, the base of Q_{1046} is grounded through VR_{1012} , and the collector current of Q_{1046} is decreased. Because the output power of Q_{2001} is controlled by Q_{2003} , the drive level to Q_{2002} is decreased, thus reducing the RF output power to approximately 1 watt.

TONE BURST CIRCUIT

When the PTT switch is pressed, the one-shot multivibrator consisting of Q_{1060} (A2, 3) (MC-14011B) is activated to generate a pulse of 0.5–1 second duration. The pulse switches Q_{1058} (2SA-733P) to supply DC voltage to Q_{1057} (TC5082P), where a 1750 or 1800 Hz tone signal is generated. Pressing the T.CALL switch also switches Q_{1058} and generates a tone signal. The tone is fed to the FM MIC amplifier and superimposed on the transmit signal.

ALC (Automatic Level Control) CIRCUIT

A portion of the output power from Q_{2002} is applied through C_{2020} to rectifiers D_{2001} and D_{2002} producing a DC voltage. The DC voltage is ampli-

fied by DC amplifier Q_{1018} (2SC1815Y) and fed to gate 2 of Q_{1014} to control its gain, thus preventing overdrive. The ALC level is adjusted by VR_{1003} for proper drive to Q_{2002} .

AFP (Automatic Final Protection) CIRCUIT

If the transmitter is activated without an antenna being connected, or if a high VSWR is present at the antenna jack, the reflected power is detected through T_{2001} and D_{2003} . The detected AFP voltage is applied through VR_{2002} to Q_{1063} (2SC1815Y) in the Main Unit. As the reflected power increases, the AFP voltage also increases, and consequently Q_{1063} conducts. The voltage at gate 2 of Q_{1014} (3SK73Y) then decreases, resulting in lower output power. When the transceiver is correctly matched to an antenna, full power output will be obtained.

PLL CIRCUIT

The PLL circuit is comprised of three PLL oscillators each consisting of a reference crystal oscillator, a programmable divider, a prescaler, and a phase comparator. The PLL produces local signals for the receiver and transmitter stages, using a synthesis scheme which produces 10 Hz steps.

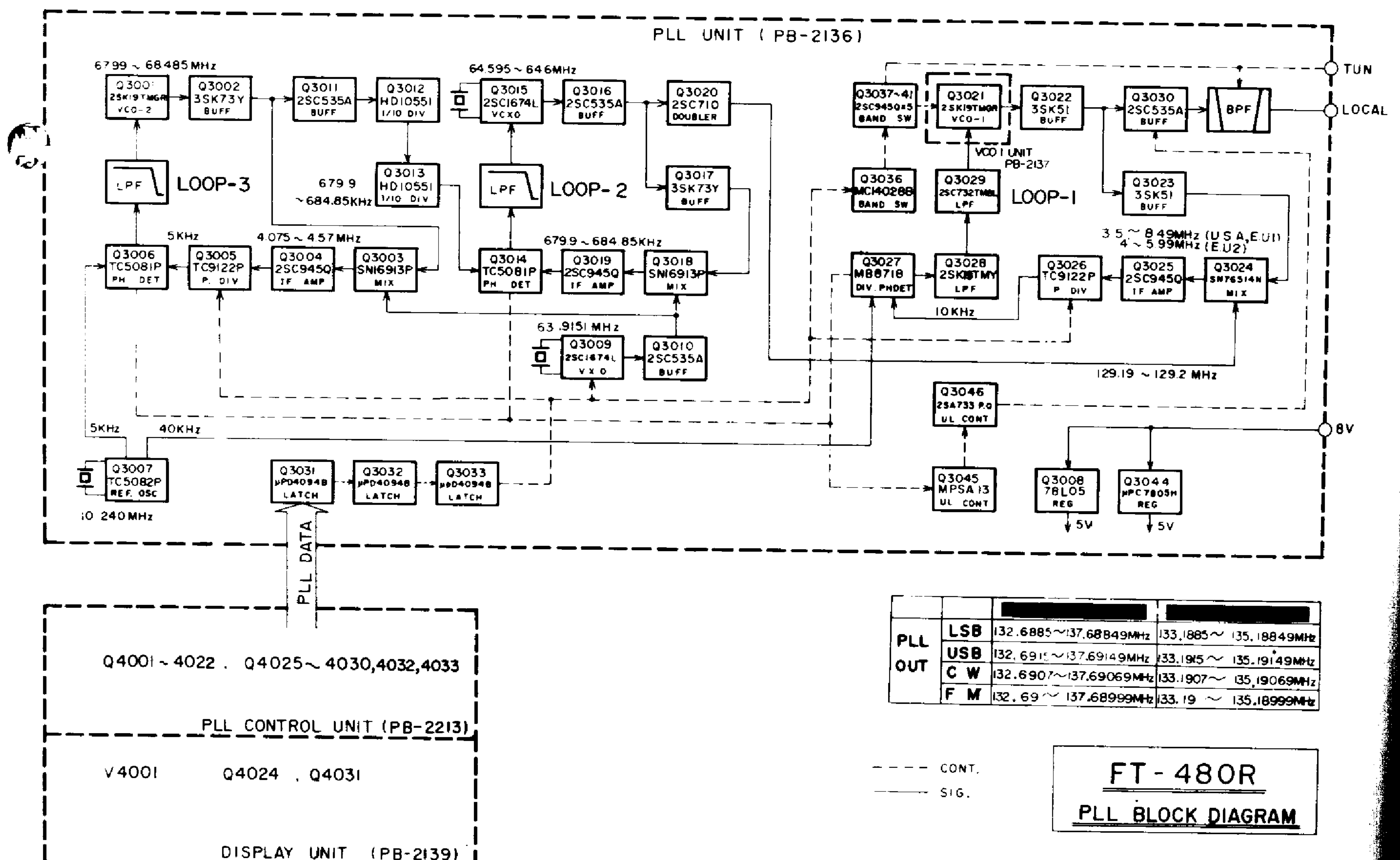

PERFORMANCE CHECKS

Make all performance checks at 13.8 VDC under load.

Check the transmitter power output as follows:

- (a) Connect a suitable dummy load/wattmeter to the antenna jack.
- (b) Set the MODE switch to the FM position, and key the transceiver while observing the power output, which should be approximately 10 watts. At full power output, 8–9 LED's will light up on the S.PO indicator.

- (c) Set the MODE switch to SSB, and key the transmitter. Speak in a normal voice into the microphone; 8–9 LED's should light up.

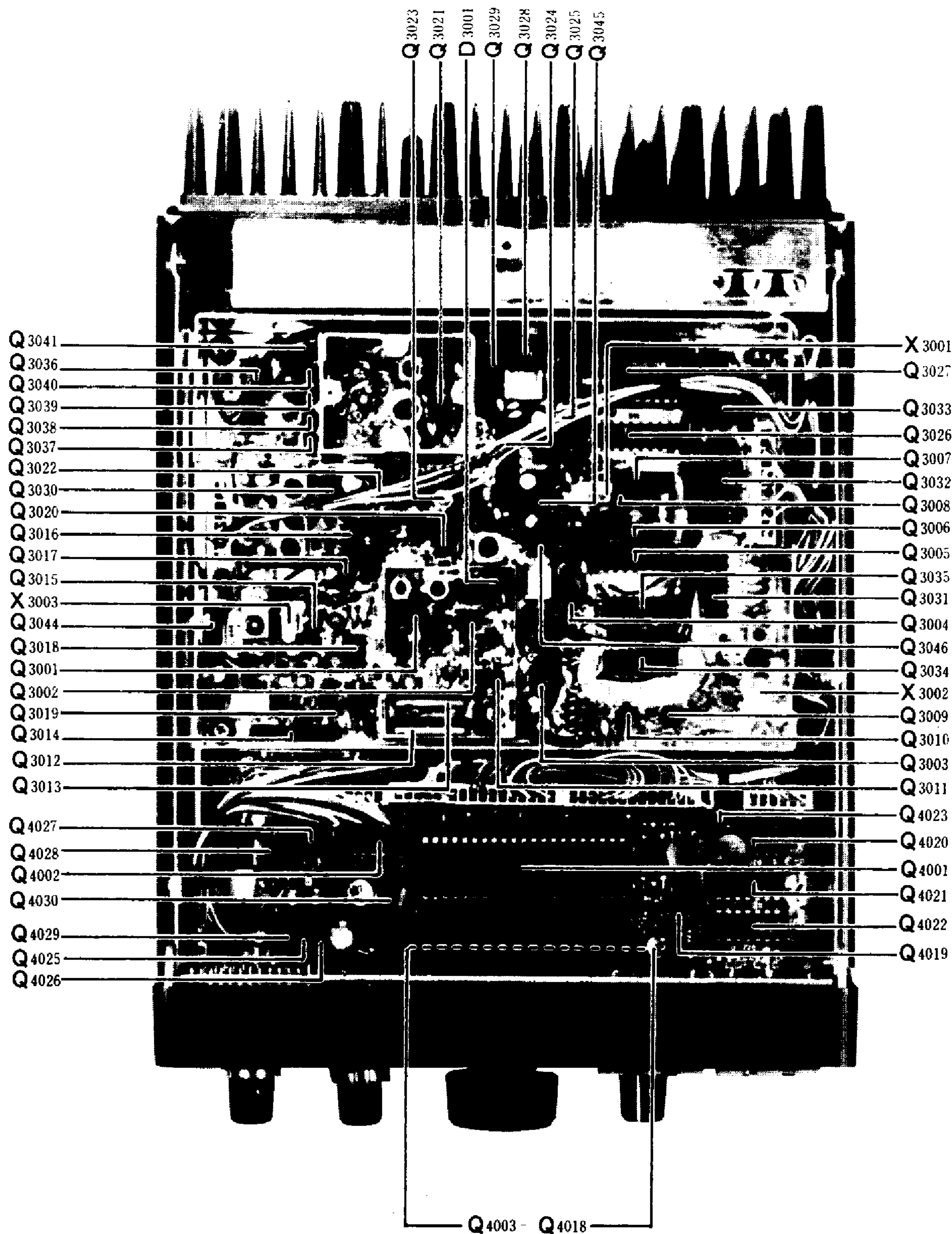
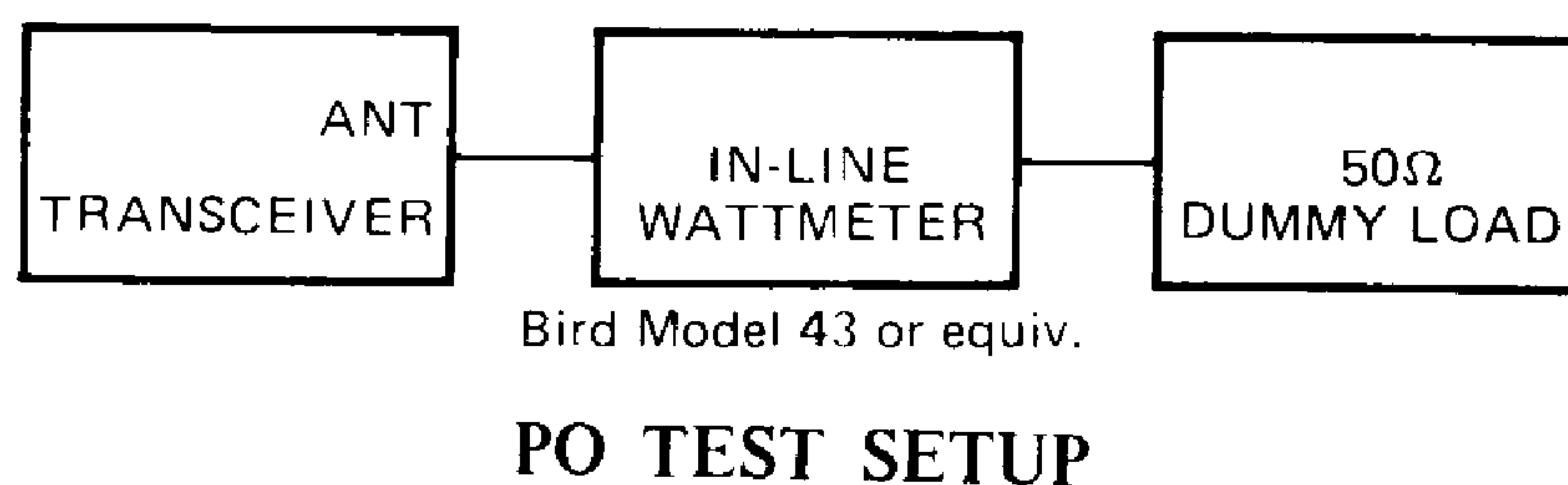

PART LOCATIONS (Top View)

Check the receiver sensitivity as follows:

- (a) Connect an AC VTVM to the SP jack. Set the MODE switch to the FM position and rotate the SQUELCH control fully counterclockwise.
- (b) Connect the RF output of a precision VHF signal generator to the antenna jack and note the VTVM reading with no signal input. Adjust the AF GAIN control and the VTVM range, as required, to obtain a full scale VTVM reading. DO NOT change the setting of the AF GAIN control after this calibration has been made.

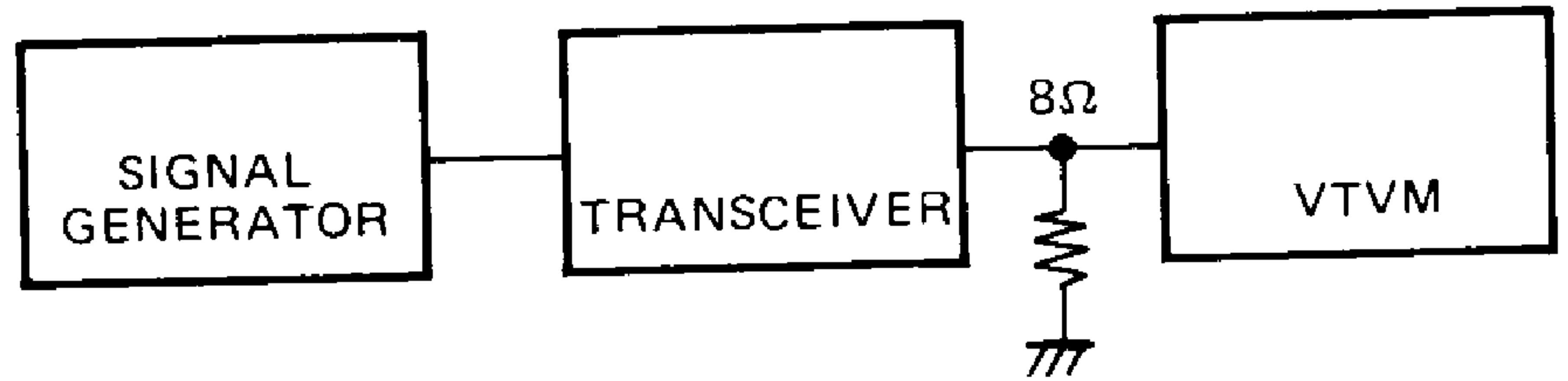

RX SENSITIVITY TEST SETUP

- (c) Set the signal generator to the receiver frequency of the transceiver, and adjust the output amplitude of the signal generator until the VTVM reads 20 dB (1/10 voltage) below the reading in step (b). The signal generator output voltage at this point is the 20 dB quieting sensitivity, and it should be approximately $0.35 \mu\text{V}$.

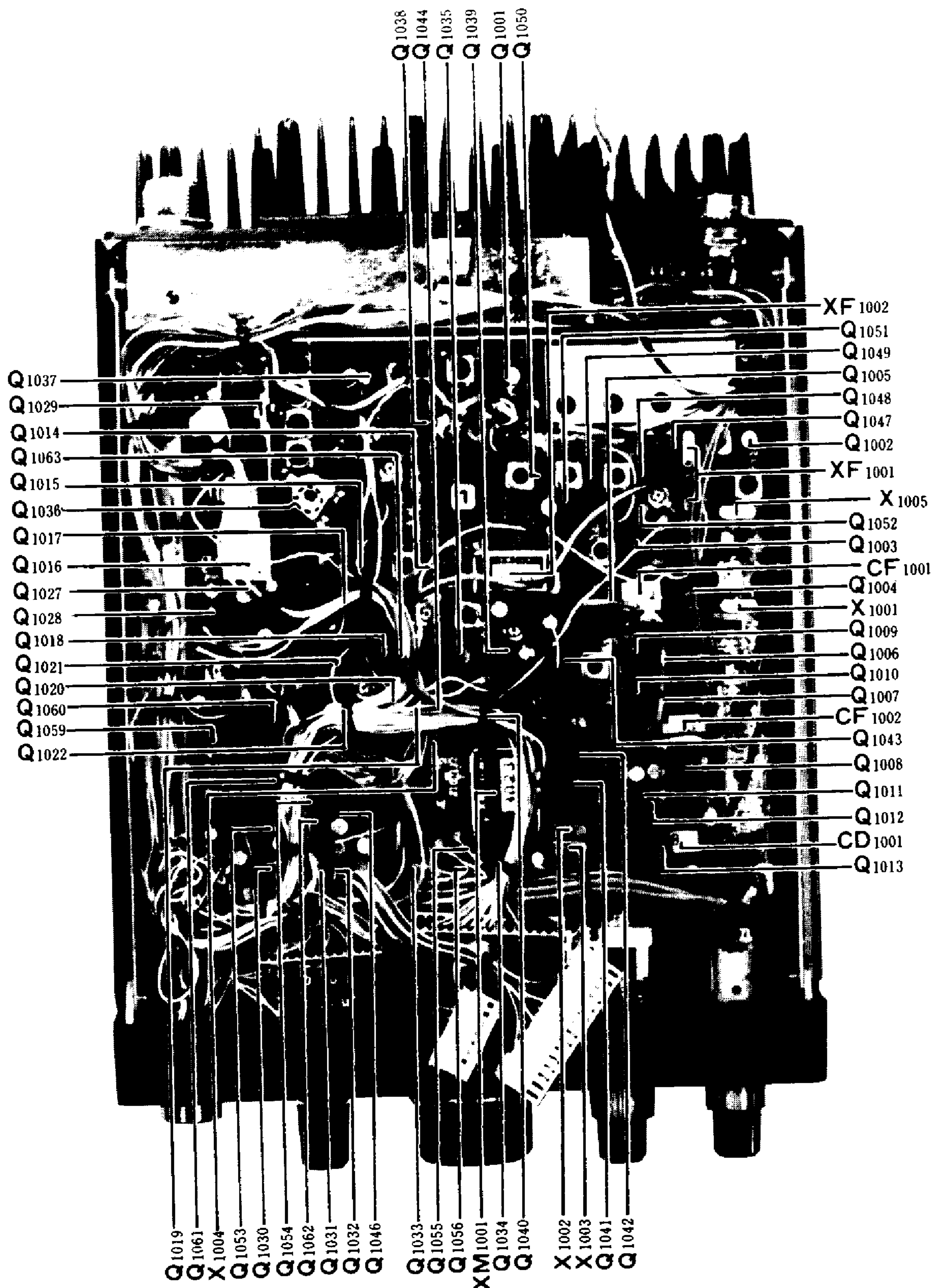

PART LOCATIONS (Bottom View)

- (d) Set the MODE switch to SSB and connect the AC VTVM to the speaker output. Apply an unmodulated $0.5 \mu\text{V}$ signal from the signal generator, and tune the transceiver main dial for a maximum VTVM reading.
- (e) Adjust the AF GAIN control for a reading of 450 mV on the VTVM.
- (f) Reduce the signal generator output and read the VTVM: the VTVM reading should be 45 mV for a 20 dB S/N ratio.

If the above check indicates a need for realignment, it is recommended that the unit be returned to the dealer for servicing. The sophisticated CPU and control circuitry, in particular, are so critical that they should not be touched by other than an experienced technician. Attempts to realign the transceiver tuned circuits without the proper equipment may result in degraded transceiver performance.

RECEIVER SECTION

(1) 2nd Local Oscillator

- a) Set the MODE switch to FM, and connect the RF probe of a VTVM to TP_{1002} .
- b) Measure the RF injection voltage. A nominal value is $0.5 \text{ V} - 0.7 \text{ VRMS}$.
- c) Connect a frequency counter to TP_{1002} and check to see that the oscillation frequency is correct: 11.265 MHz.

(2) 1st IF Amplifier

- a) Set the MODE switch to FM, and adjust VR_{1001} to the fully counterclockwise position.

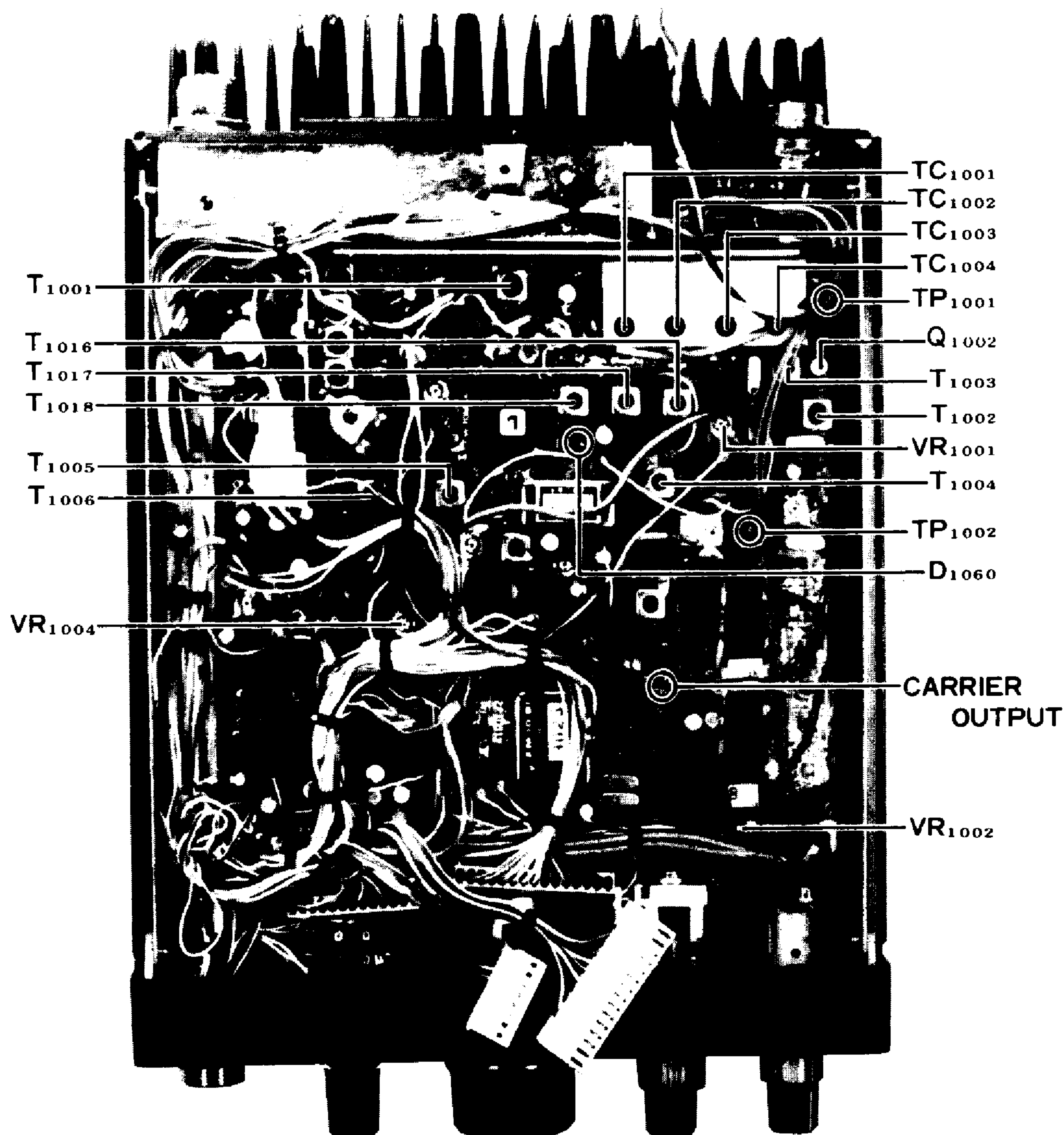

ALIGNMENT AND TEST POINTS FOR RECEIVER

- b) Connect a sweep generator to gate 1 of Q_{1002} (TP_{1001}). Connect an oscilloscope, through a detector, to the secondary winding of T_{1004} .
- c) Set the frequency of the sweep generator to 10.81 MHz, and apply output from the generator.
- d) Adjust T_{1003} and T_{1004} until the scope pattern illustrated in Fig. 2 is obtained.

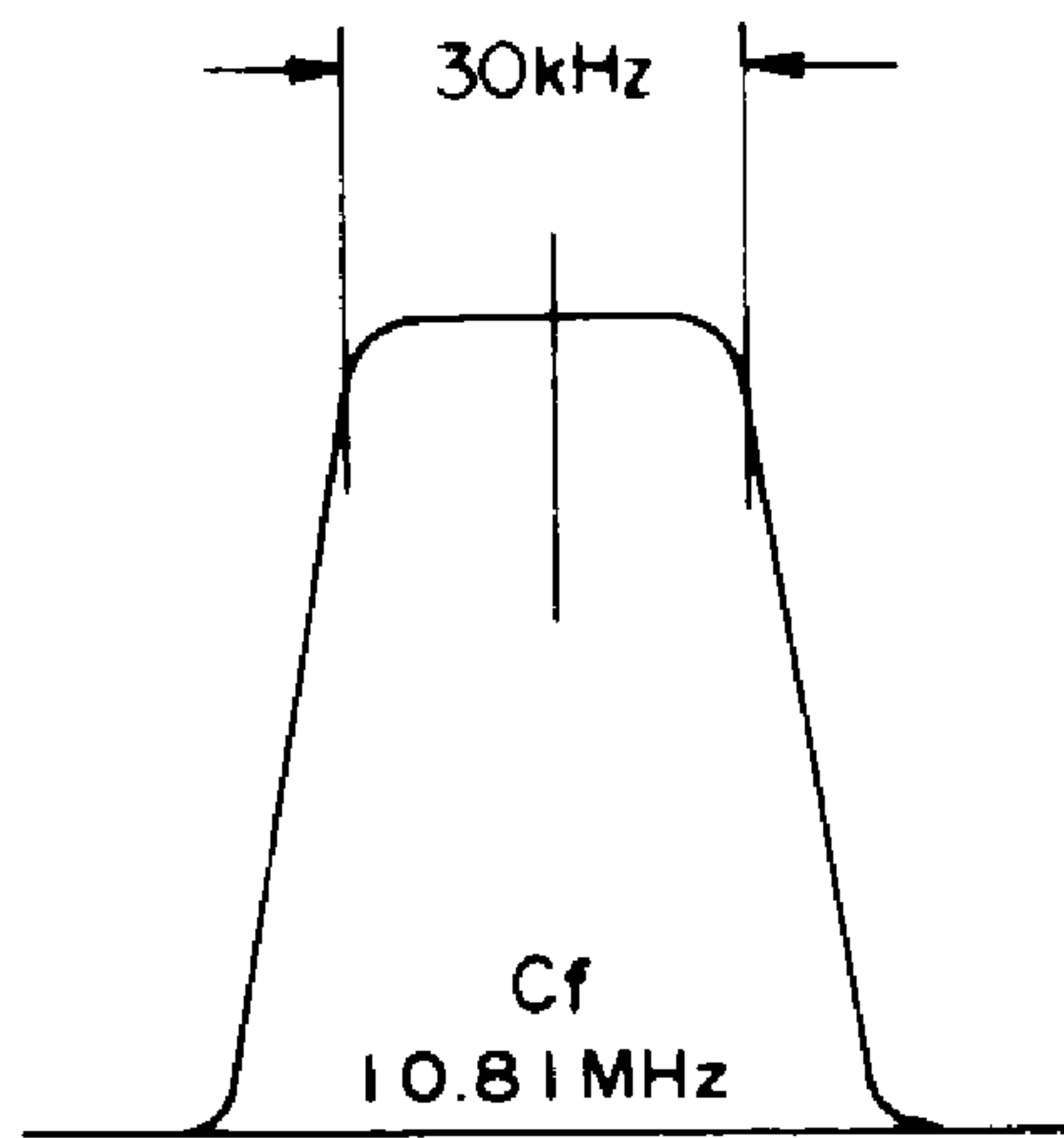

Figure 2

(3) SSB Carrier Oscillator

- a) Set the MODE switch to LSB.
- b) Connect the RF probe of the VTVM to the CARRIER OUTPUT terminal on the Main Unit (where C_{1212} and a shielded cable are connected), and measure the oscillation level. A nominal value is 170–230 mV RMS.
- c) Set the MODE switch to USB. Measure the oscillation level in the same way as in the step (b). A nominal value is 170–230 mV RMS.

(4) SSB IF Circuit

- a) Set the mode switch to USB or LSB.
- b) Connect a signal generator to TP_{1001} , and set its output level to 15 dB μ (5.62 μ V) at 10.81 MHz.
- c) Peak T_{1004} , T_{1005} , and T_{1006} for a maximum S.PO indication.

(5) RF Amplifier

- a) Set the output level and frequency of the generator to 10 dB μ (3.16 μ V) at 146 MHz.
- b) Set the receiver frequency to 146 MHz, and adjust T_{1001} , T_{1002} , TC_{1001} – TC_{1004} for a maximum S.PO indication.

(6) S-Meter Full Scale Setting

- a) Rotate VR_{1004} fully clockwise to make sure that all the LED's on the S-meter scale are illuminated.
- b) Set VR_{1004} to the point where all the LED's go off.
- c) Apply a 4 dB μ (1.584 μ V) signal from the signal generator and adjust VR_{1001} so that only one LED is illuminated.

(7) Noise-Blanker Adjustment

- a) Set the MODE switch to USB or LSB.
- b) Set the receiver frequency to 146 MHz.
- c) Adjust the output level and frequency of the signal generator to 5–10 dB μ (1.78 μ V–3.16 μ V) at 146 MHz. Temporarily connect TP_{1002} to ground with a clip lead, in order to disable the 2nd local oscillator.
- d) Connect a voltmeter (full scale: 2.5V) to the cathode of D_{1060} and ground. Adjust T_{1016} , T_{1017} , and T_{1018} for a maximum reading on the voltmeter scale.

(8) Squelch Adjustment

- a) Set the MODE switch to FM.
- b) Set the front panel SQL control to the 9 o'clock position.
- c) Adjust VR_{1002} so that the receiver is just muted. Now apply a signal from the signal generator. A signal of approximately –13 dB μ (0.224 μ V) with ± 3.5 kHz deviation at 1 kHz should be required to trip the squelch.

TRANSMITTER SECTION

Unless otherwise indicated, always perform transmitter alignment with a dummy load connected to the antenna jack. If the AFP circuits are being aligned, an improper load impedance at a critical time could result in the destruction of the final transistors.

* In order to adjust these trimmers, remove the two screws marked "A", and loosen the two screws marked "B" on the side panels. Then tilt the Final Unit as shown below.

** TC₂₀₀₁ - TC₂₀₀₄ require no realignment unless final transistors are replaced.

(1) TX Strip Trimmer Adjustment

- Set the MODE switch to FM, and the transmitter frequency to 146.00 MHz.
- With a dummy load/wattmeter connected to the antenna jack, advance VR₂₀₀₂ and VR₁₀₀₃ fully counterclockwise.
- Squeeze the microphone PTT switch, and adjust TC₂₀₀₁ - TC₂₀₀₄ * for maximum power output as indicated on the wattmeter.

(2) Mixer/Interstage Alignment

- Temporarily disconnect the RF OUT cable from the Main Unit.
- Terminate the RF OUT terminals with a 50 ohm resistor, and connect the RF probe of a VTVM to the RF OUT terminals.
- Set the transmitter frequency to 145.5 MHz, MODE to FM, and key the transceiver.
- Adjust T₁₀₁₀ - T₁₀₁₄, TC₁₀₀₅, and TC₁₀₀₆ for maximum reading on the VTVM.

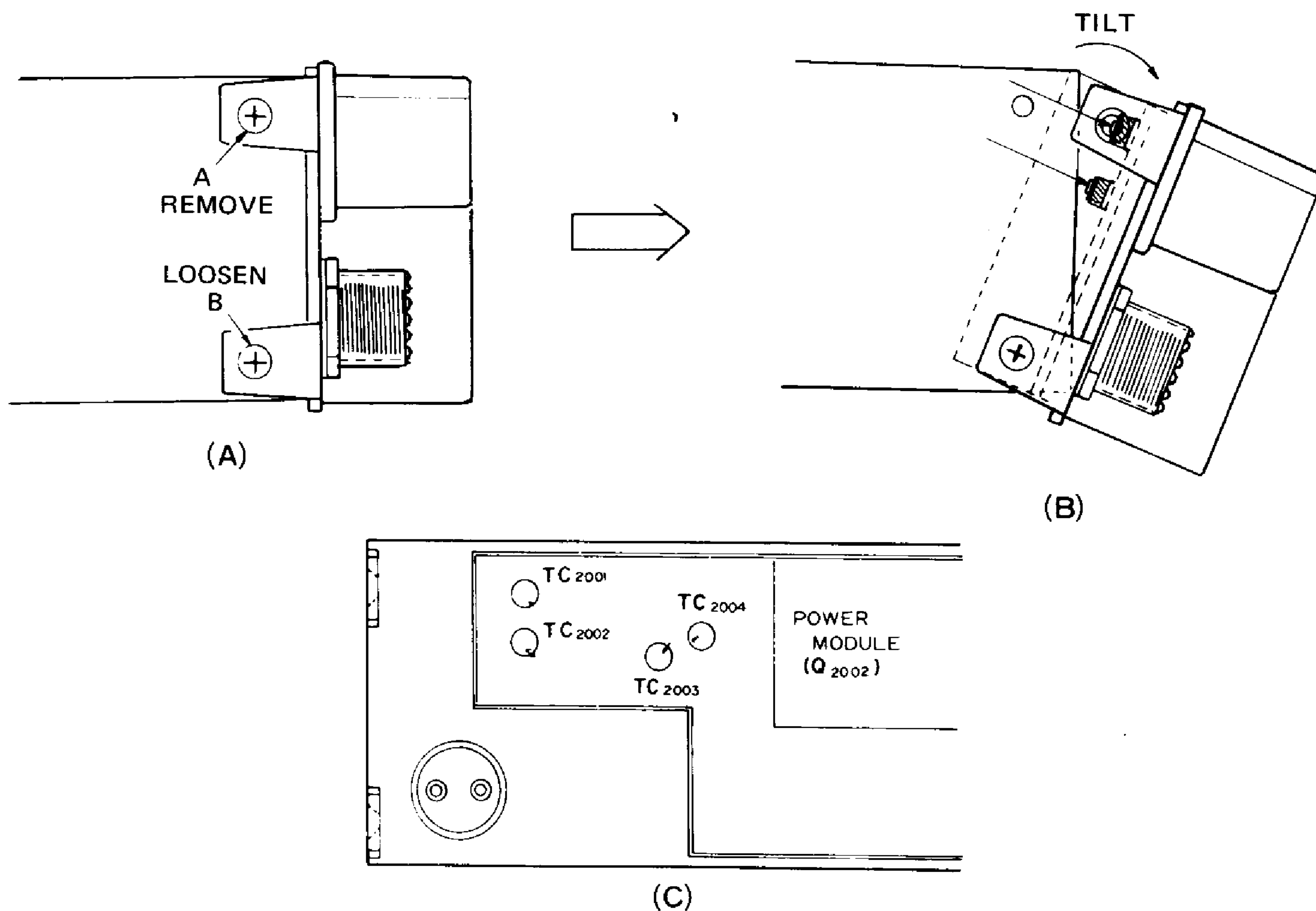

POWER AMPLIFIER UNIT

(3) CW Carrier Oscillator

- a) Set the MODE switch to CW.
- b) Connect the RF probe of a VTVM to TP₁₀₀₆ and key the transceiver.
- c) Adjust T₁₀₀₉ for a reading of 100 mV RMS on the VTVM.
- d) Connect a frequency counter to TP₁₀₀₆, and adjust TC₁₀₁₀ for a reading of exactly 10.8093 MHz on the counter.

(4) ALC/PO Adjustment

- a) Set the MODE switch to FM.
- b) With a dummy load/wattmeter connected to the antenna jack. Key the transceiver.
- c) Adjust VR₁₀₀₃ for an output of 10 watts on the wattmeter.

- d) Adjust VR₂₀₀₁ so as to illuminate 9 LED's on the S.PO indicator.

(5) AFP Adjustment

- a) Connect a DC voltmeter to the AFP terminal on the Main Unit and ground.
- b) Rotate VR₂₀₀₂ fully counterclockwise.
- c) Set the MODE switch to FM.
- d) Adjust VR₂₀₀₃ for minimum indication on the DC voltmeter.
- e) Disconnect the 50 ohm dummy load, and connect a 165 ohm, 10 watt dummy load to the antenna jack. Key the transceiver.
- f) Adjust VR₂₀₀₂ so as to illuminate 8 LED's on the S.PO indicators. Now return to RX.
- g) Remove the dummy load from the antenna jack, Close the PTT switch, and check to see that the current consumption is less than 2 amps.

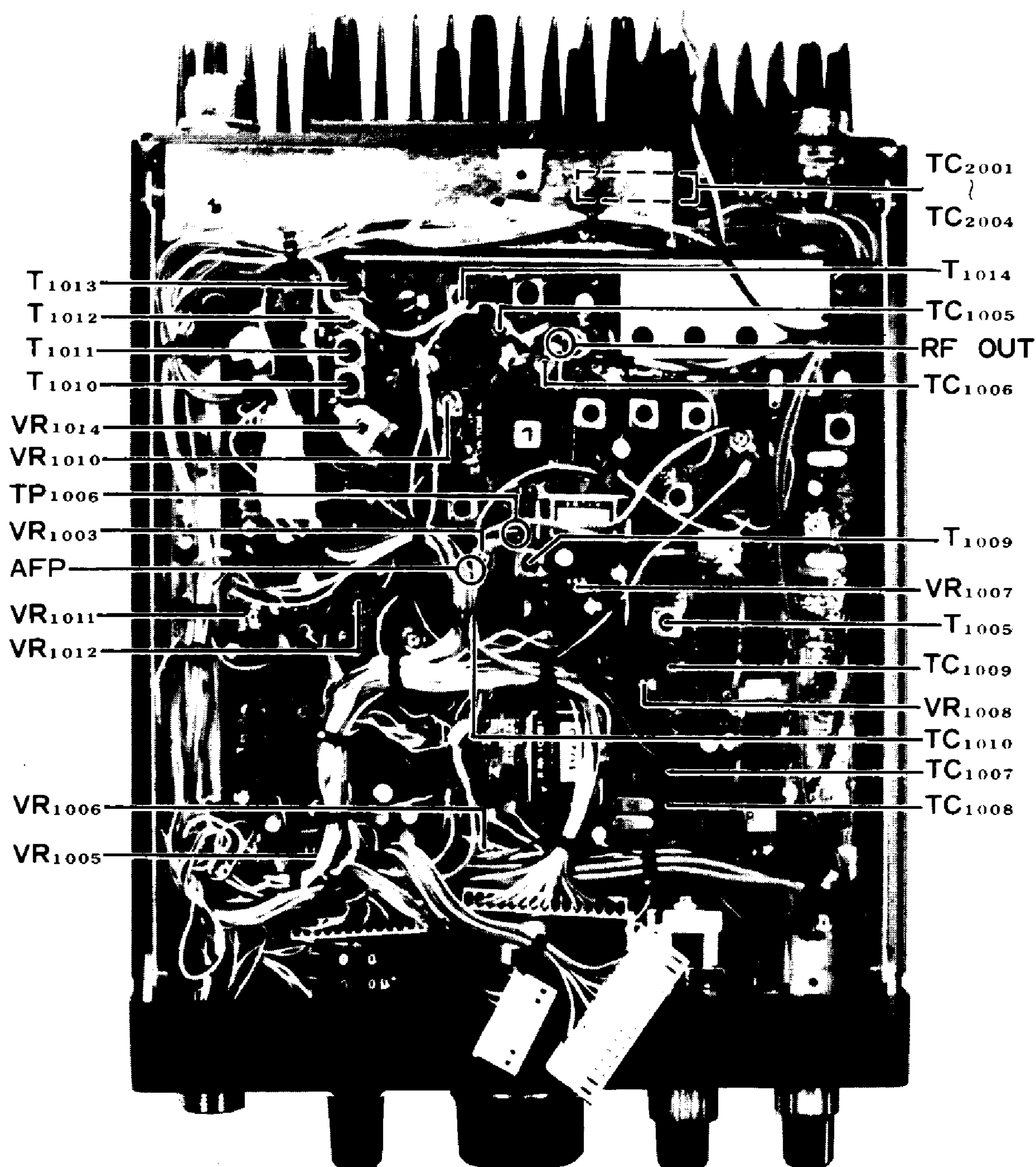

ALIGNMENT AND TEST POINTS FOR TRANSMITTER

(6) Low Power Output Setting

- a) Set the HI/LOW switch to the LOW position, and key the transmitter in the FM mode.
- b) Adjust VR₁₀₁₂ for an output of 1 watt on the wattmeter.

(7) FM Modulator Adjustment

- a) Refer to Fig. 3, and set up the transceiver and test equipment as shown.
- b) Set VR₁₀₀₅, located on the Main Unit, to the center of its range, and apply a 1 kHz, 15 mV signal from the audio generator to the mic jack.
- c) Adjust VR₁₀₀₆ for a deviation of ± 4.5 kHz while observing the signal waveform on the scope.
- d) Now reduce the audio generator output level to 1.5 mV, and adjust VR₁₀₀₅ for a deviation of ± 3.5 kHz. Check to see that the waveform on the scope is not distorted.
- e) Turning the audio generator on and off, make sure that the BUSY/MOD indicator illuminates along with the changing audio input.

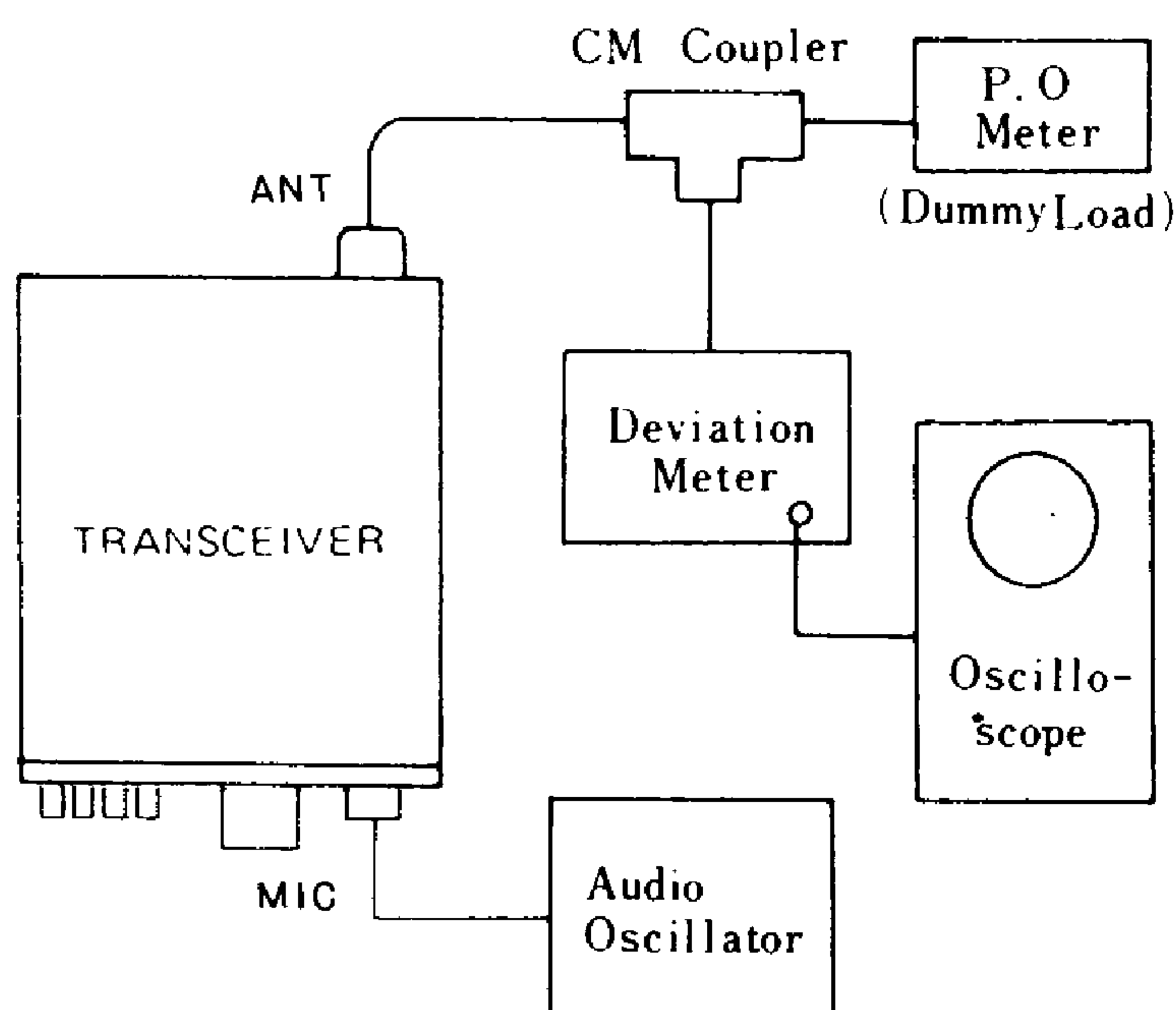

Figure 3

(8) SSB Modulator Adjustment

(A) Balanced Modulator Output Transformer Adjustment

- a) With a dummy load/wattmeter connected to the antenna jack, set the MODE switch to USB or LSB.
- b) Set VR₁₀₀₇ to the center of its range, and apply a 1 kHz, 1 mV signal from the audio generator to the mic jack.
- c) Adjust T₁₀₁₅ for maximum power output.

(B) SSB Carrier Point Adjustment

- a) Apply a 1 kHz, 1.2 mV signal from the audio generator to the mic jack, and adjust VR₁₀₀₇ for an output of 8 watts.
- b) Set the MODE switch to USB and the frequency of the audio generator to 300 Hz. Adjust TC₁₀₀₈ for an output of 2 watts.
- c) Set the MODE switch to LSB, and the frequency of the audio generator to 300 Hz. Adjust TC₁₀₀₇ for an output of 2 watts.

(C) Carrier Balance Adjustment

- a) Temporarily short the mic input terminal of the mic jack (pin 8) to ground with a clip lead. Set the MODE switch to USB.
- b) While monitoring the carrier on a monitor receiver, adjust VR₁₀₀₈ and TC₁₀₀₉ for a minimum S-Meter reading (or minimum signal level if no S-Meter reading occurs).
- c) Switch between USB and LSB, and compare the output levels with no modulation. Adjustment of VR₁₀₀₈, TC₁₀₀₉ may be necessary to achieve good carrier nulling on both modes.

(9) CW Side Tone Frequency/Semi-break-in Delay Adjustment

- a) Adjust VR₁₀₁₀ for the desired monitoring level on CW operation.
- b) Adjust VR₁₀₁₁ for the desired CW VOX relay hang time.

PLL SECTION

NOTE: The PLL circuit is very critical in its adjustment. Alignment must only be performed by an experienced technician. All alignment should be performed at a temperature within the range 15°–30°C, preferably near the center of this range.

(1) VCV Line Adjustment

(A) PLL 1 Adjustment

- a) Set the STEP switch to "M," the MODE switch to FM, and tune the transceiver to 145.9900 MHz.
- b) Connect the DC probe of the VTVM to TP₃₀₁₂, and adjust TC₃₀₀₄ for a reading of exactly 6.5 V.

(B) PLL 2 Adjustment

- a) Set the STEP switch to "M," the MODE switch to USB, and tune the transceiver to 145.0099 MHz.
- b) Connect the DC probe of the VTVM to TP₃₀₀₉, and adjust L₃₀₁₇ to secure a reading of 3.5 V.

(C) PLL 3 Adjustment

- a) Set the STEP switch to "M," MODE switch to USB, and tune the transceiver to 145.0099 MHz.
- b) Connect the DC probe of the VTVM to TP₃₀₀₁, and adjust TC₃₀₀₁ to secure a reading of 3.5 V.

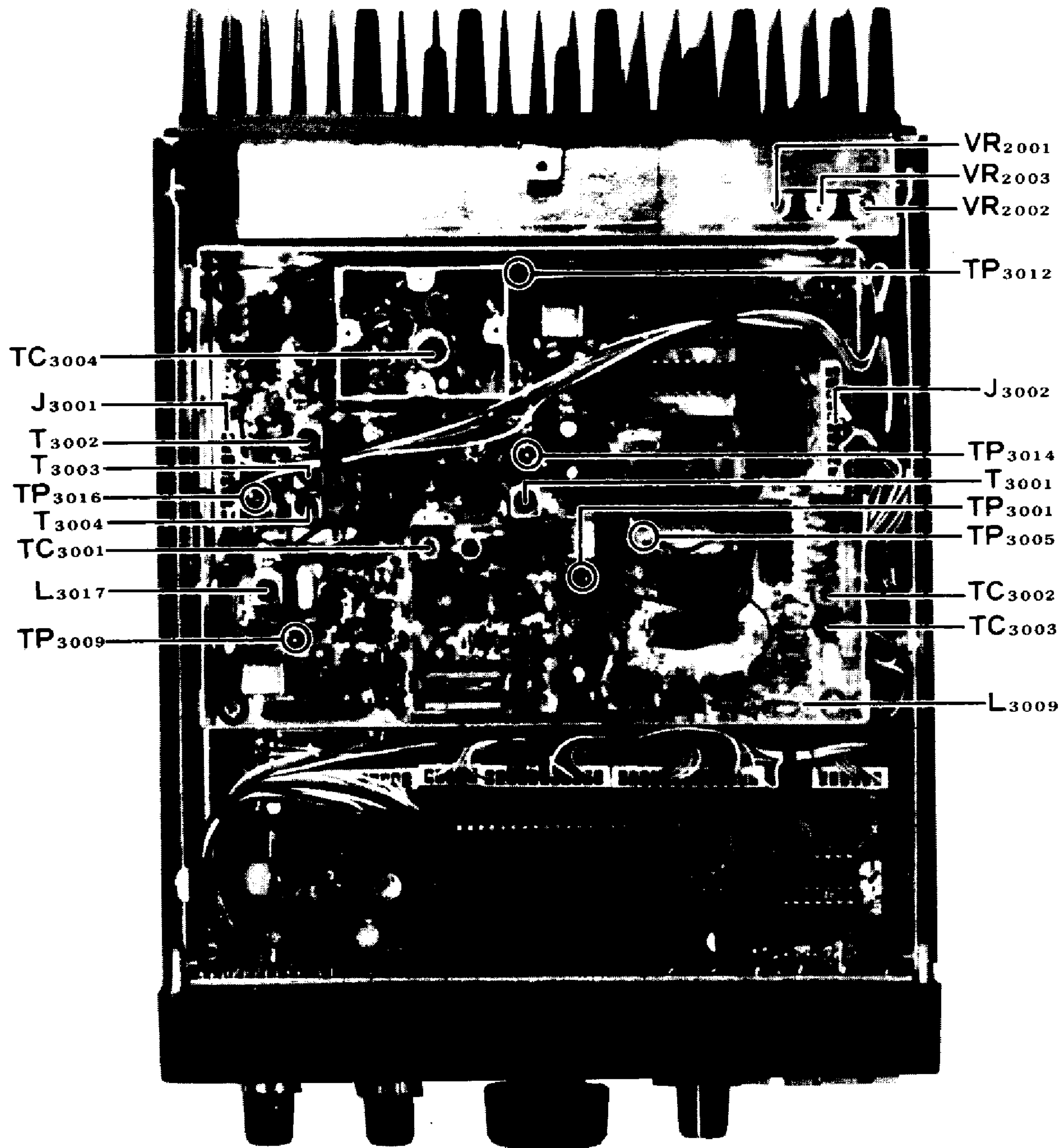

ALIGNMENT AND TEST POINTS FOR PLL

(2) Multiplier Stage Adjustment

- a) Set the STEP switch to "M," the MODE switch to USB, and tune the transceiver to 145.0099 MHz.
- b) Connect the RF probe of the VTVM to TP₃₀₁₄, and adjust T₃₀₀₁ for a maximum reading on the VTVM.

NOTE: In order to achieve the specified frequencies for the above alignment steps, some presetting of the display will be required (because the 10 Hz digit is not displayed). Push the F.SET button, switch to USB, then set the STEP switch to "S". The precise frequency may then be set using the main dial.

(3) PLL Output Bandpass Filter Adjustment

- a) Set the STEP switch to "F," the MODE switch to FM, and tune the transceiver to 145.4000 MHz.
- b) Connect the RF probe of the VTVM to TP₃₀₁₆, and peak T₃₀₀₂, T₃₀₀₃, and T₃₀₀₄ for a maximum meter reading.

(4) PLL Local Frequency

- a. Connect a frequency counter to TP₃₀₁₆.
- b) Set the STEP switch to "S," the MODE switch to USB, and tune the transceiver to 144.00000 MHz.
- c) Adjust TC₃₀₀₂ for a reading of exactly 133.19150 MHz on the frequency counter.
- d) Change the transceiver display frequency to 144.00009 MHz, using the Main Dial.
- e) Adjust TC₃₀₀₃ for a reading of exactly 133.19159 MHz on the frequency counter.
- f) Repeat steps (b), (c), (d) and (e) several times to ensure complete frequency adjustment.



MAIN UNIT
CIRCUIT DIAGRAM





PLL UNIT (NO. 30...) PB-2136

DISPLAY UNIT (NO. 40) PB-2139

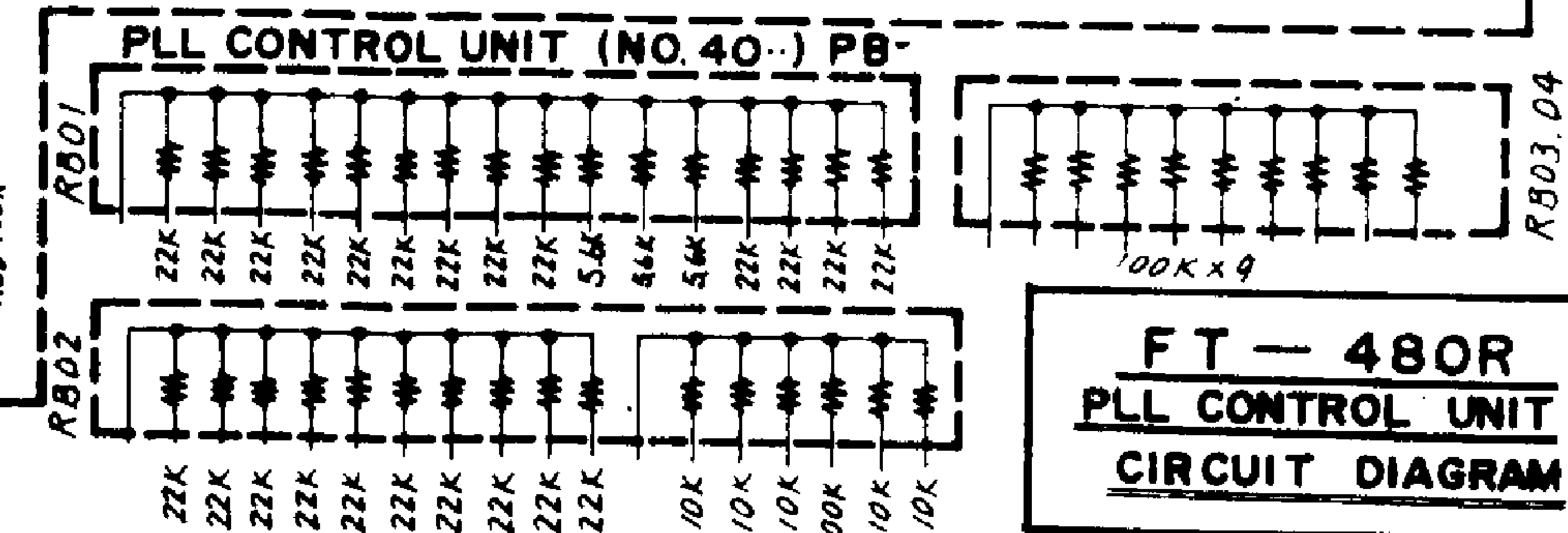


FT-48OR
PLL CONTROL UNIT
CIRCUIT DIAGRAM

ALL DIODES ARE 1SS53 UNLESS OTHERWISE NOTED.

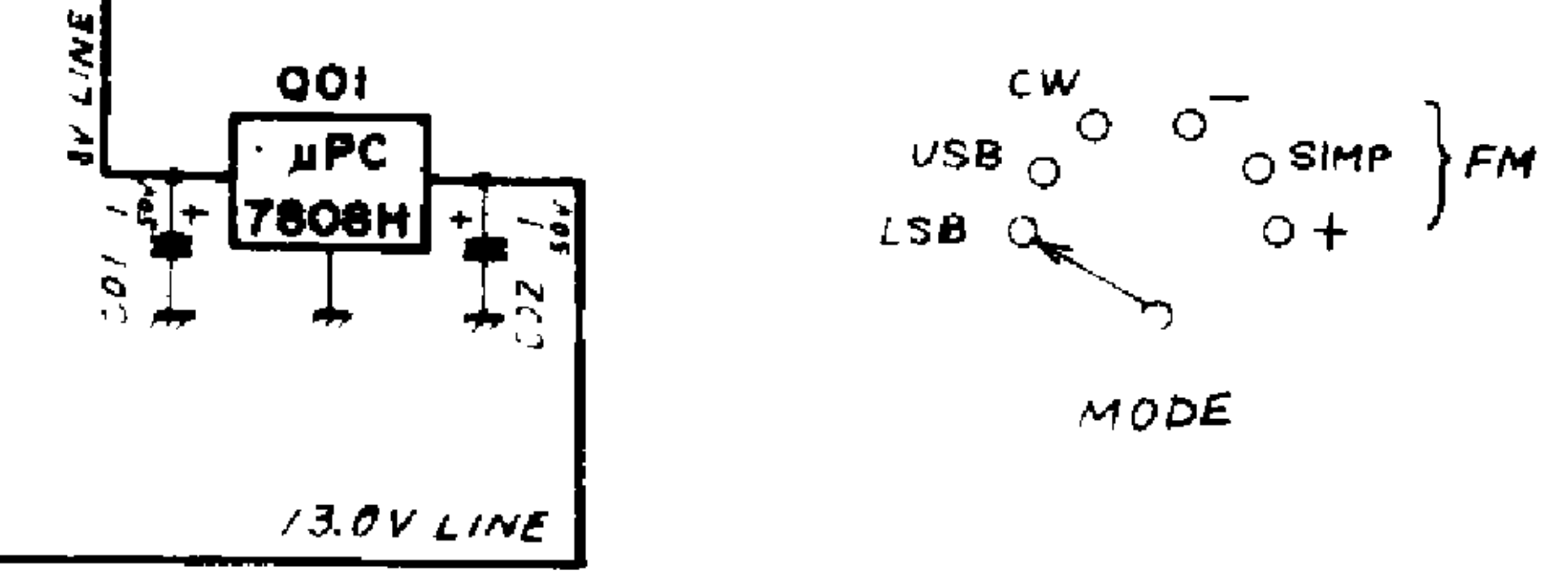
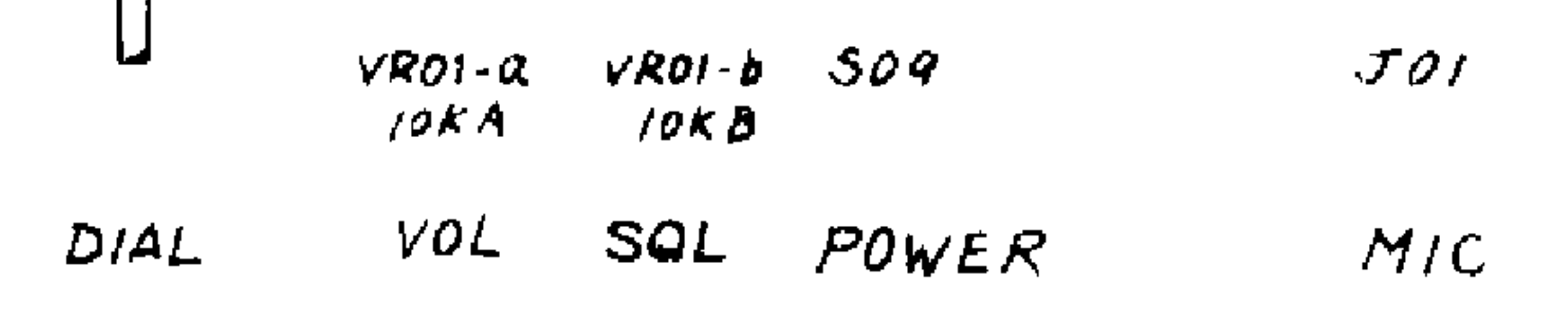
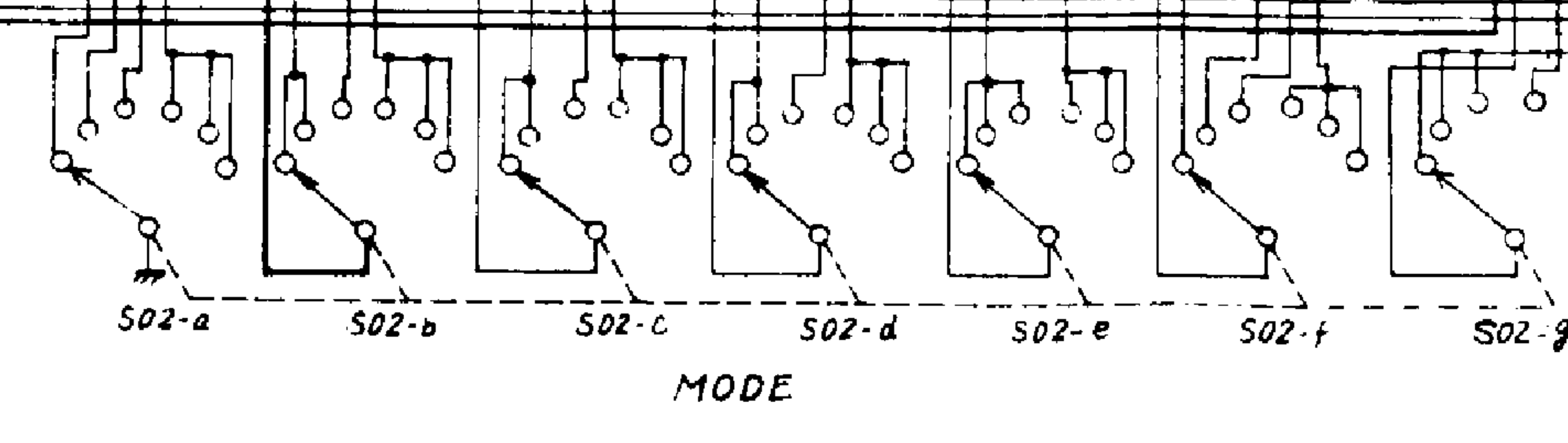
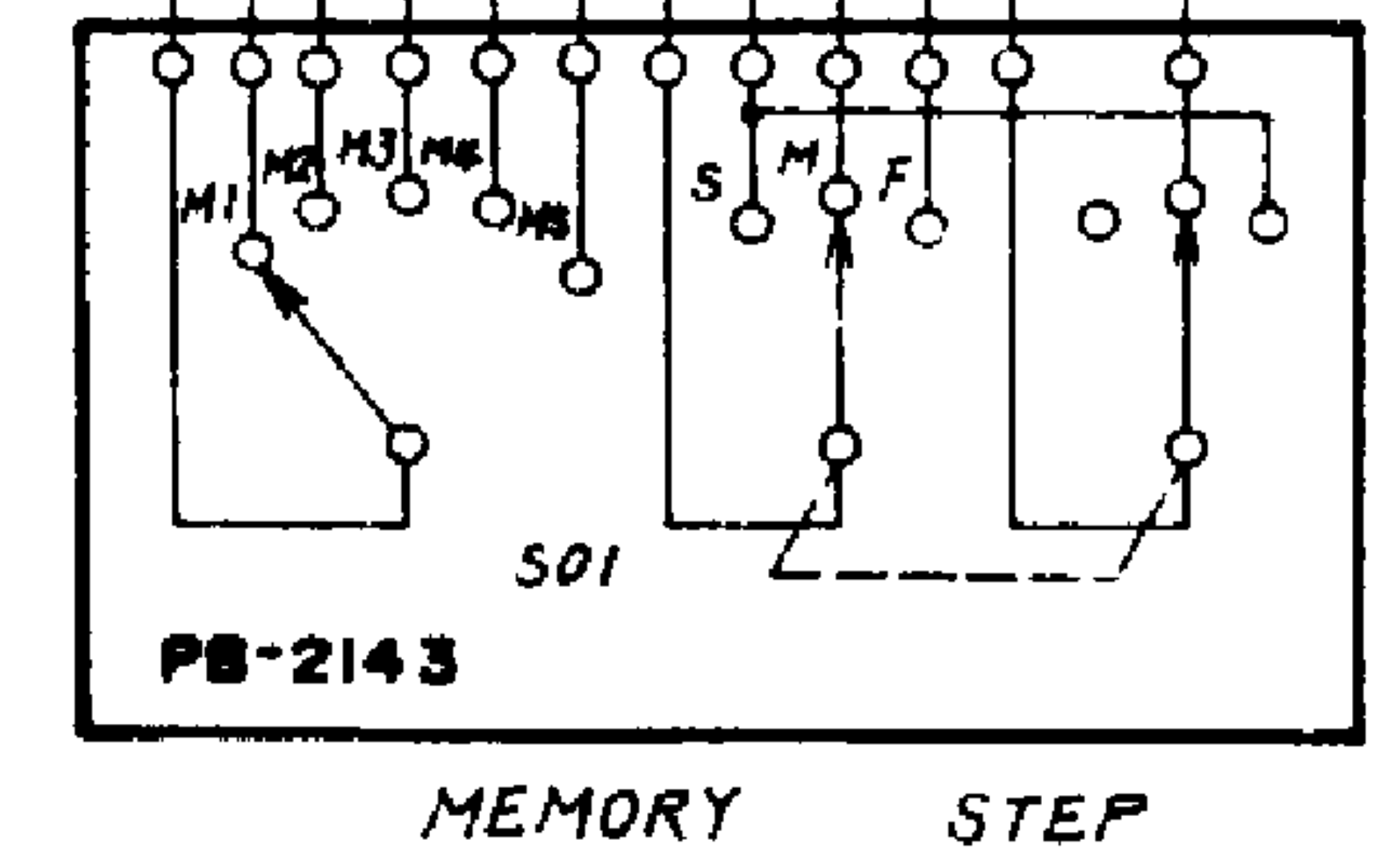
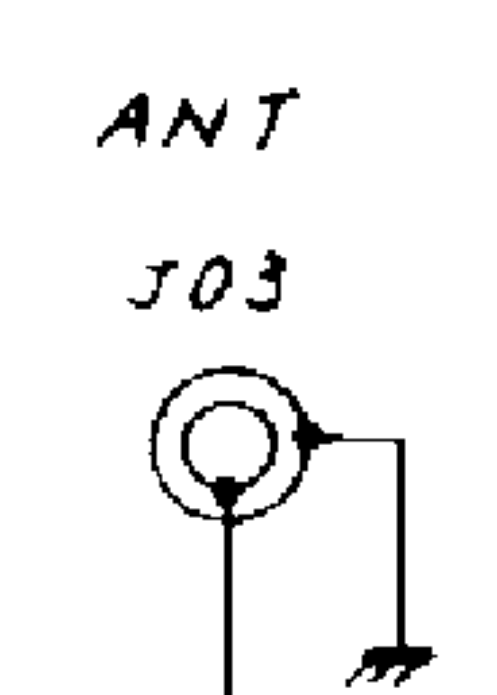
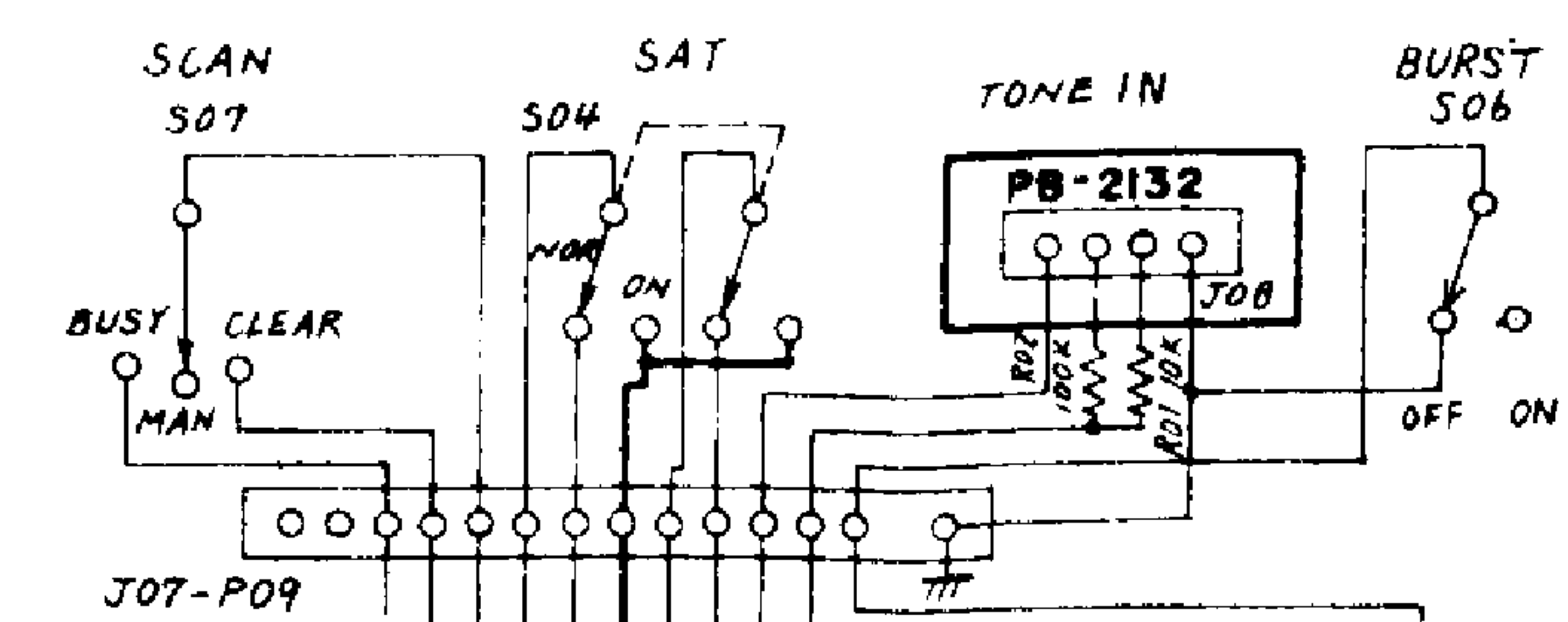
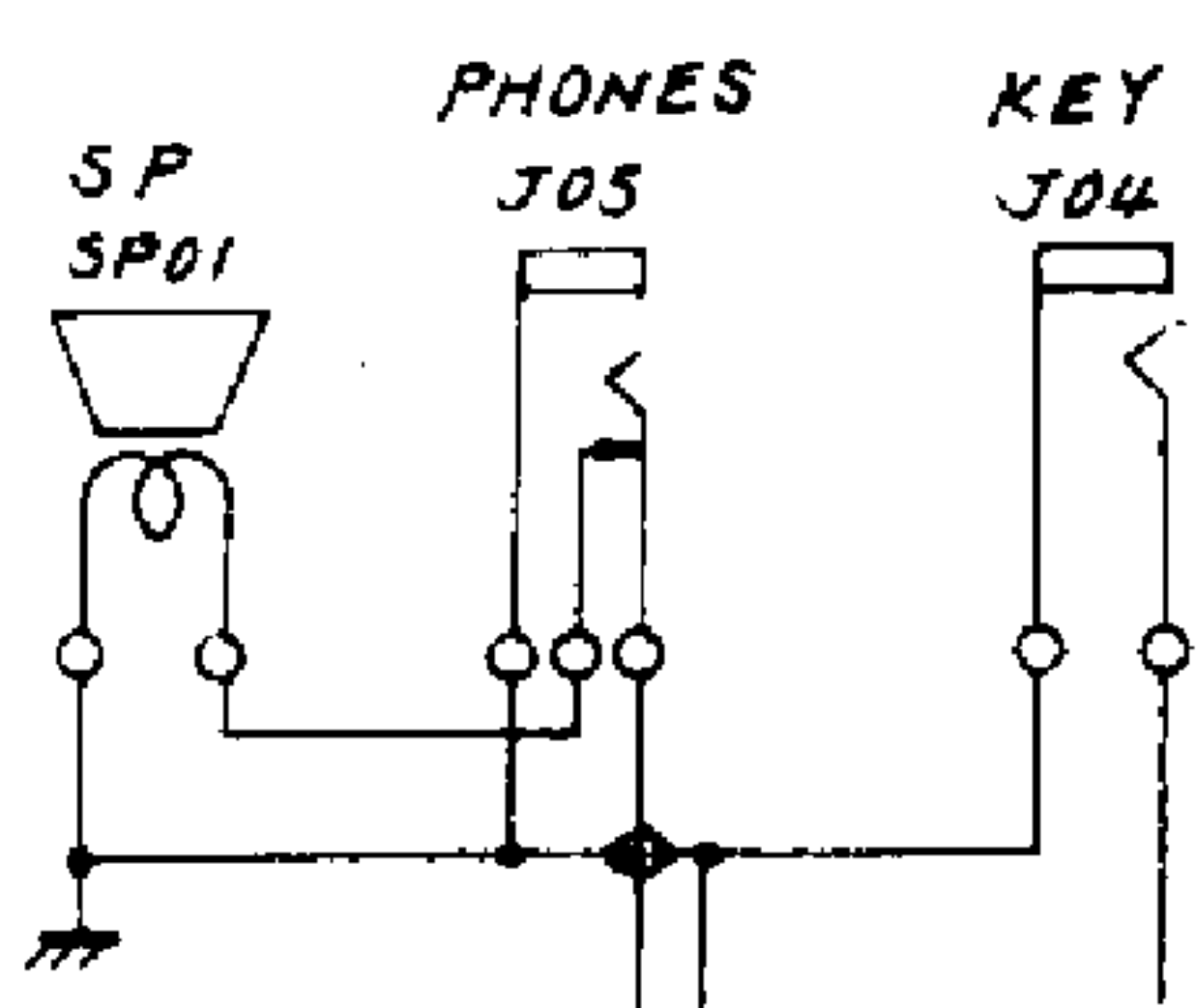


FT-48OR
CONNECTION DIAGRAM